

GROUP 90

CIRCUIT DIAGRAMS

CONTENTS

HOW TO READ CIRCUIT DIAGRAMS	90-4	MULTIPOINT FUEL INJECTION (MFI) SYSTEM <2.4L ENGINE-M/T>	90-42
JUNCTION BLOCK	90-10	MULTIPOINT FUEL INJECTION (MFI) SYSTEM <2.4L ENGINE-A/T>	90-52
JOINT CONNECTOR.....	90-12	MULTIPOINT FUEL INJECTION (MFI) SYSTEM <3.8L ENGINE-M/T>	90-62
CENTRALIZED JUNCTION.....	90-15	MULTIPOINT FUEL INJECTION (MFI) SYSTEM <3.8L ENGINE-A/T>	90-72
POWER DISTRIBUTION SYSTEM ..	90-22	COOLING SYSTEM <2.4L ENGINE>.	90-82
STARTING SYSTEM <M/T>	90-28	COOLING SYSTEM <3.8L ENGINE>.	90-84
STARTING SYSTEM <A/T>.....	90-29	INVECS-II 4A/T <2.4L ENGINE>	90-86
IGNITION SYSTEM <2.4L ENGINE-M/T>	90-30	INVECS-II 5A/T <3.8L ENGINE>	90-96
IGNITION SYSTEM <2.4L ENGINE-A/T>.....	90-32	HEADLIGHT	90-106
IGNITION SYSTEM <3.8L ENGINE-M/T>	90-34	TAILLIGHT, POSITION LIGHT AND LICENSE PLATE LIGHT	90-112
IGNITION SYSTEM <3.8L ENGINE-A/T>.....	90-36	FOG LIGHT.....	90-118
CHARGING SYSTEM <2.4L ENGINE>	90-38	FRONT DOME LIGHT, REAR DOME LIGHT, LUGGAGE COMPARTMENT LIGHT AND IGNITION KEY HOLE ILLUMINATION LIGHT.....	90-124
CHARGING SYSTEM <3.8L ENGINE>	90-40		

Continued on next page

GLOVE BOX LIGHT	90-132	WINDSHIELD WIPER AND WASHER <A/T>	90-226
VANITY MIRROR LIGHT	90-133	REAR WIPER AND WASHER <M/T>	90-232
TURN-SIGNAL LIGHT AND HAZARD WARNING LIGHT	90-134	REAR WIPER AND WASHER <A/T>	90-240
BACKUP LIGHT <M/T>	90-142	REAR WINDOW DEFOGGER AND DOOR MIRROR HEATER	90-248
BACKUP LIGHT <A/T>	90-144	REMOTE CONTROLLED MIRROR	90-250
STOPLIGHT	90-146	AUTOMATIC ANTI-DAZZLING MIRROR	90-252
HORN	90-147	AUDIO SYSTEM <VEHICLES WITHOUT AUDIO AMPLIFIER>	90-254
METER AND GAUGE <M/T>	90-148	AUDIO SYSTEM <VEHICLES WITH AUDIO AMPLIFIER>	90-258
METER AND GAUGE <A/T>	90-154	ACCESSORY SOCKET	90-264
BRAKE WARNING LIGHT, OIL PRESSURE WARNING LIGHT, FUEL WARNING LIGHT <M/T>	90-160	MULTI -CENTER DISPLAY	90-266
BRAKE WARNING LIGHT, OIL PRESSURE WARNING LIGHT, FUEL WARNING LIGHT <A/T>	90-164	SUNROOF	90-270
POWER WINDOWS	90-168	AUTO-CRUISE CONTROL SYSTEM <2.4L ENGINE-M/T>	90-274
CENTRAL DOOR LOCKING SYSTEM	90-176	AUTO-CRUISE CONTROL SYSTEM <2.4L ENGINE-A/T>	90-282
MANUAL AIR CONDITIONING SYSTEM <2.4L ENGINE>	90-190	AUTO-CRUISE CONTROL SYSTEM <3.8L ENGINE-M/T>	90-290
MANUAL AIR CONDITIONING SYSTEM <3.8L ENGINE>	90-200	AUTO-CRUISE CONTROL SYSTEM <3.8L ENGINE-A/T>	90-298
AUTOMATIC AIR CONDITIONING SYSTEM <3.8L ENGINE>	90-210	ELECTRONIC BRAKE-FORCE DISTRIBUTION (EBD) AND ANTI-LOCK BRAKING SYSTEM (ABS) <VEHICLES WITHOUT TRACTION CONTROL SYSTEM (TCL)>	90-306
WINDSHIELD WIPER AND WASHER <M/T>	90-220		

Continued on next page

ELECTRONIC BRAKE-FORCE DISTRIBUTION (EBD) AND ANTI-LOCK BRAKING SYSTEM (ABS) <VEHICLES WITH TRACTION CONTROL SYSTEM (TCL)>	90-312	LIGHTING MONITOR TONE ALARM	90-362
ENGINE IMMOBILIZER SYSTEM <2.4L ENGINE-M/T>	90-318	IGNITION KEY REMINDER TONE ALARM	90-364
ENGINE IMMOBILIZER SYSTEM <2.4L ENGINE-A/T>.	90-324	SEAT BELT WARNING TONE ALARM	90-366
ENGINE IMMOBILIZER SYSTEM <3.8L ENGINE-M/T>	90-330	DOOR AJAR WARNING TONE ALARM <M/T>	90-370
ENGINE IMMOBILIZER SYSTEM <3.8L ENGINE-A/T>.	90-336	DOOR AJAR WARNING TONE ALARM <A/T>.	90-376
SUPPLEMENTAL RESTRAINT SYSTEM (SRS)	90-342	CONTROLLER AREA NETWORK (CAN) <2.4L ENGINE-M/T>	90-382
POWER SEAT	90-352	CONTROLLER AREA NETWORK (CAN) <2.4L ENGINE-A/T>	90-390
HEATED SEAT	90-354	CONTROLLER AREA NETWORK (CAN) <3.8L ENGINE-M/T>	90-400
FORGOTTEN KEY PREVENTION FUNCTION	90-358	CONTROLLER AREA NETWORK (CAN) <3.8L ENGINE-A/T>	90-408

HOW TO READ CIRCUIT DIAGRAMS

M1901000100793

The circuit of each system from the fuse (or fusible link) to ground is shown. The power supply is shown at the top and the ground at the bottom to facilitate understanding of how the current flows. Some variations are included in one circuit diagram. Accordingly, some diagrams may not be applicable for individual vehicles.

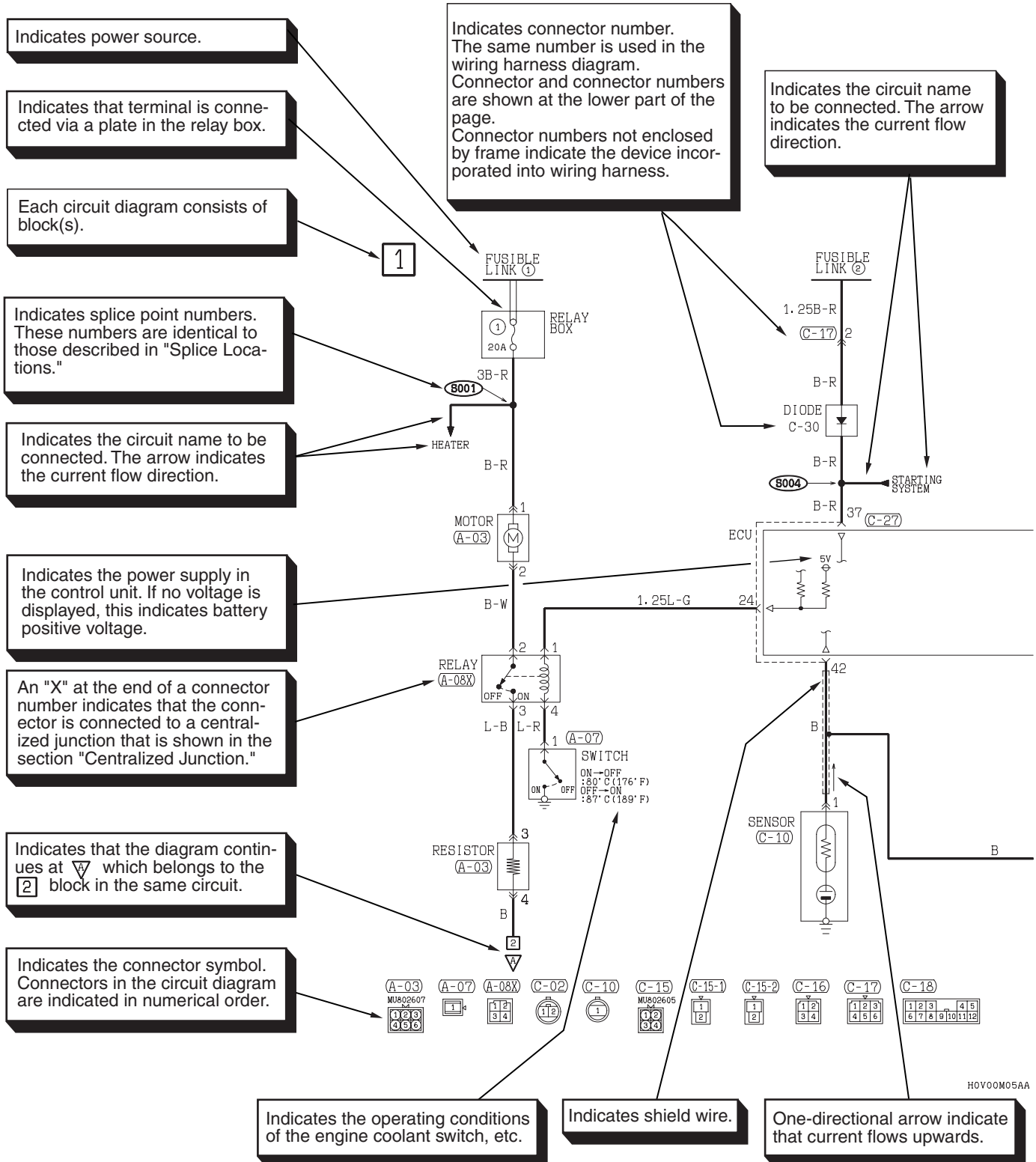

HOV00M05AA

AC106603AG

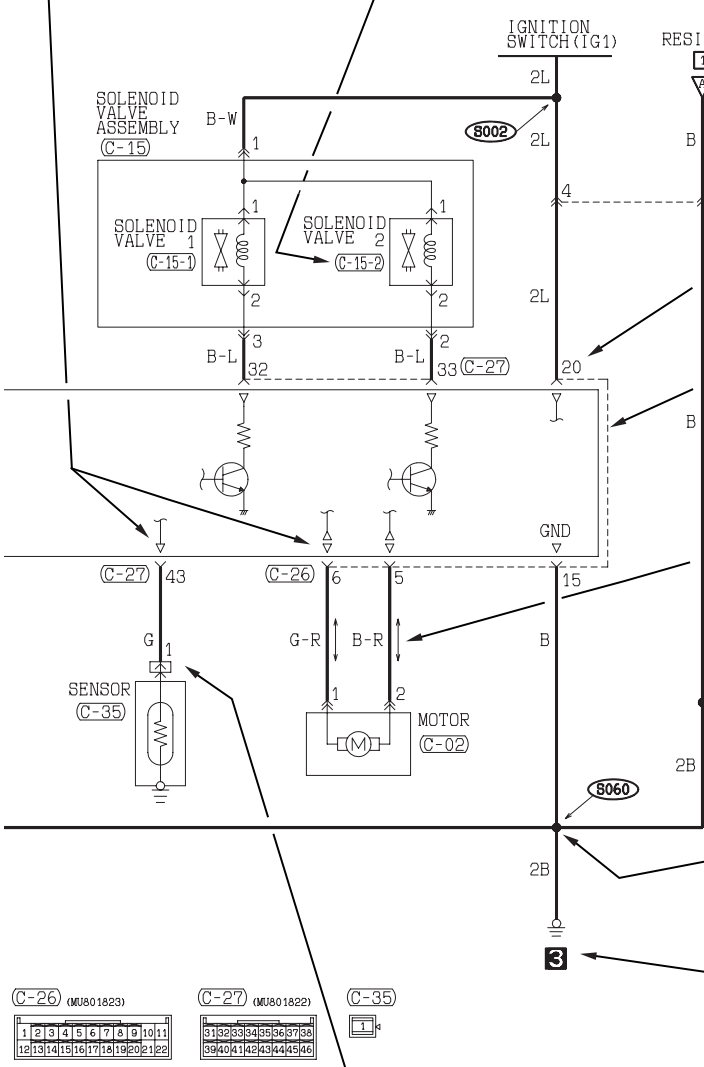
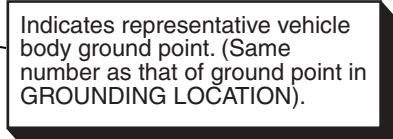
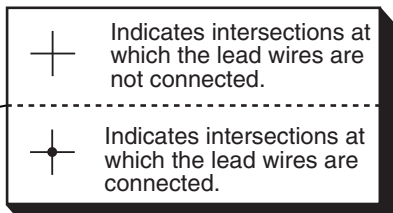
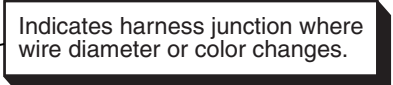
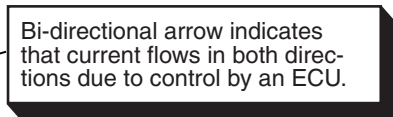
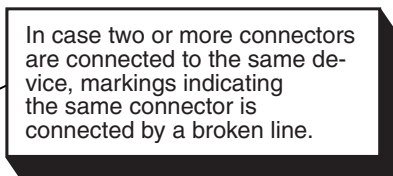
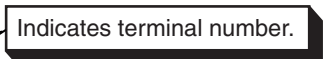
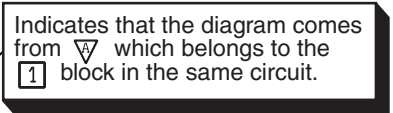
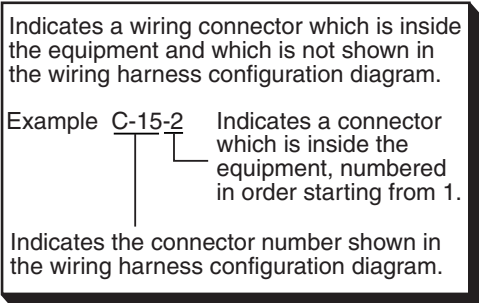
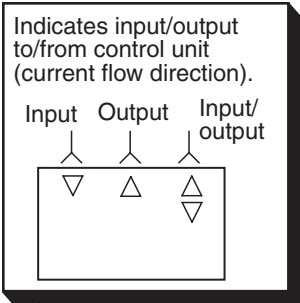

(C-26) (M/J801823)	(C-27) (M/J801822)	(C-35)
1 2 3 4 5 6 7 8 9 10 11 12 13 14 15 16 17 18 19 20 21 22	31 32 33 34 35 36 37 38 39 40 41 42 43 44 45 46	1*

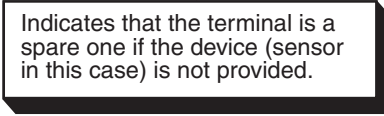





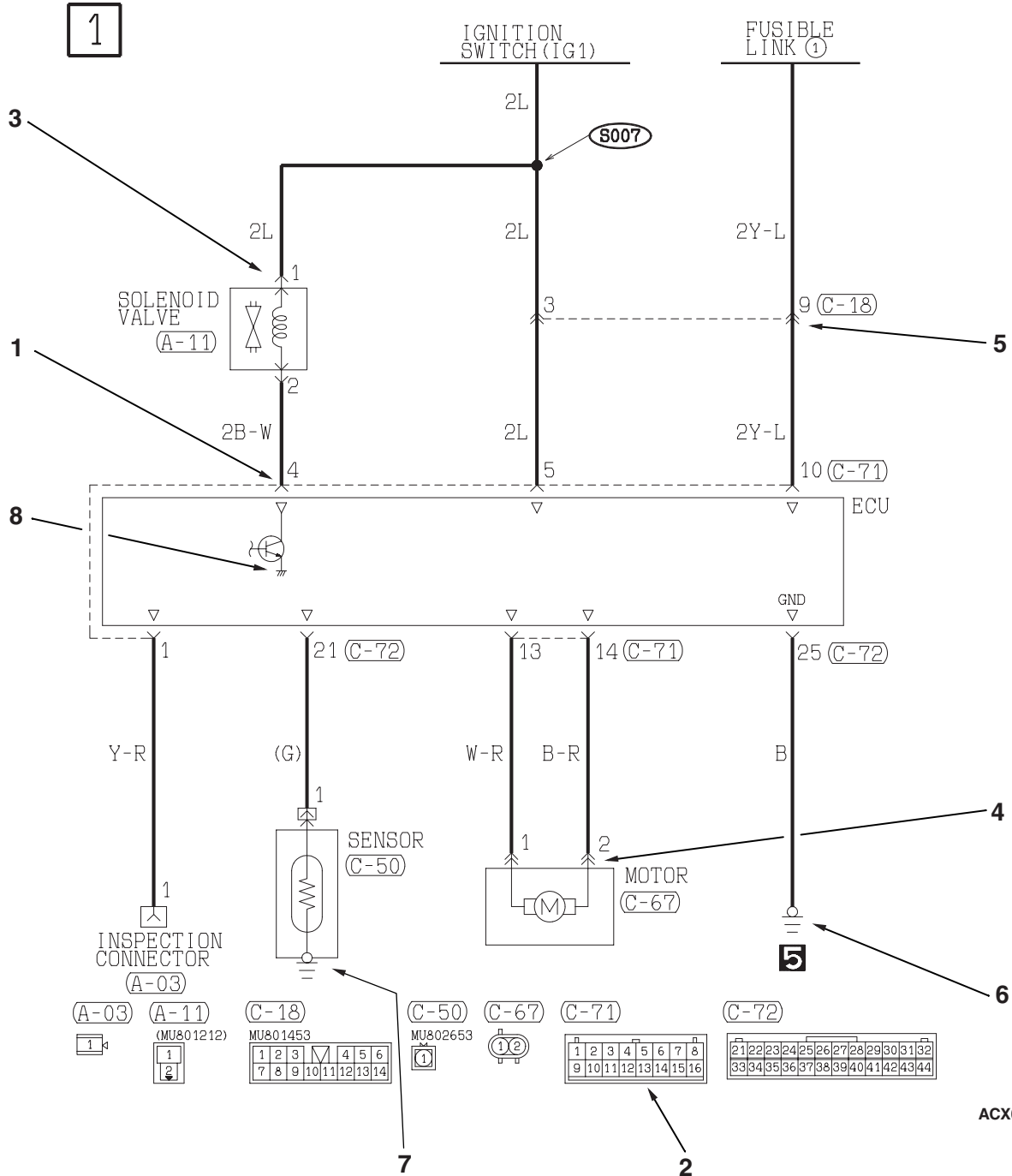



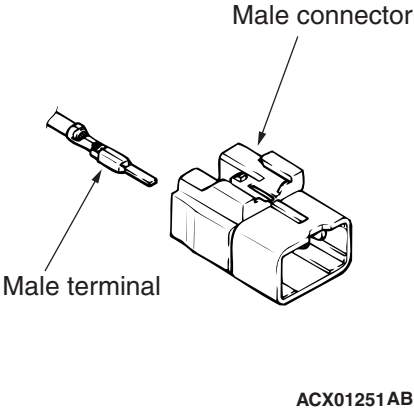

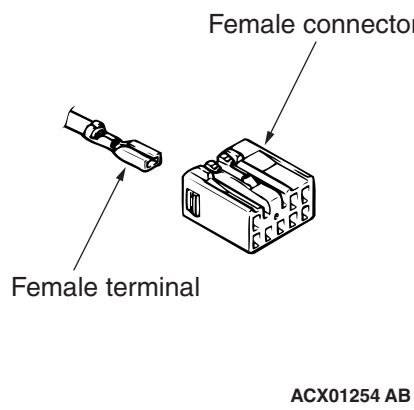
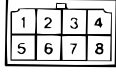
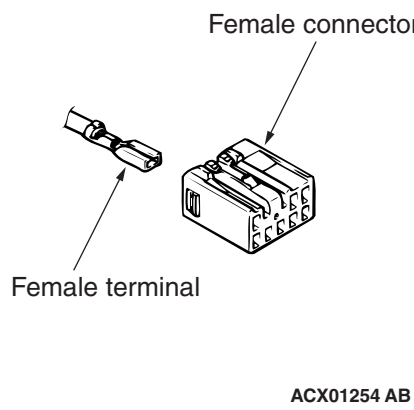

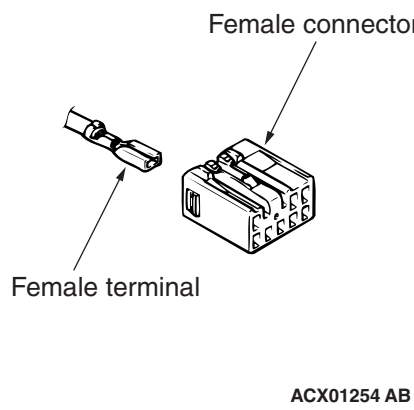
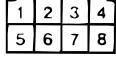
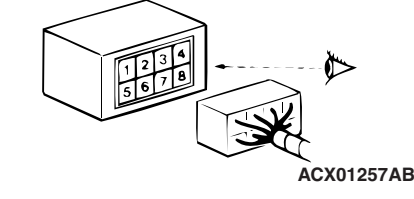
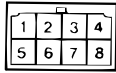
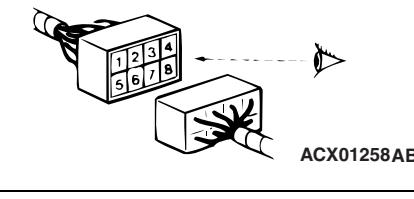

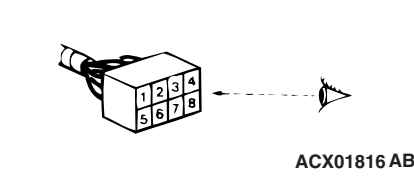
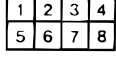

H0V00M05AB

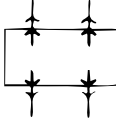
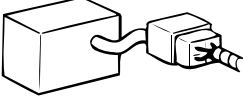
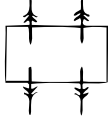
CONNECTOR/GROUNDING INDICATIONS

























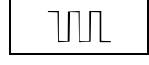

ACX02364 AC

ITEM	NO.	CONNECTOR/ GROUNDING	SYMBOL	CONTENTS
Connector and terminal marking	1		Male terminal  ACX01252 AB	The male and female terminals are indicated as shown. The connector with male terminal(s) is called as male connector and indicated by two connector contour lines, while the connector with female terminal(s) is called as female connector and indicated by single connector contour line.
			Male connector  ACX01253 AB	
			Female terminal  ACX01255 AB	
			Female connector  ACX01256 AB	
Connector symbol marking	2	Device 	 ACX01253	The symbol indicates the connector is viewed as shown. At a device connection, the connector symbol on the device side is shown. For an intermediate connector, the male connector symbol is shown. For spare connectors and check connectors, no device is connected, and so the harness-side connector symbol is shown for these connectors.
		Intermediate connector 	 ACX01256	
		Spare connector, check connector 	 ACX01256	

ITEM	NO.	CONNECTOR/ GROUNDING	SYMBOL	CONTENTS
Connector connection marking	3	Direct connection type  ACX01260 AB	 ACX01261	Connection between a device and the harness is either by direct insertion in the device (direct connection type) or by connection with a harness connector furnished on the device side (harness connection type). The two types are indicated as illustrated. However, a data link connector is exceptional.
	4	Harness connection type  ACX01262 AB	 ACX01263	
	5	Intermediate connector  ACX01264 AB	 ACX01265	
Ground marking	6	Body ground  ACX01273 AB	 ACX01274	Grounding is either by body ground, device ground or control unit interior ground. These are indicated as illustrated.
	7	Device ground  ACX01275 AB	 ACX01276	
	8	Ground in control unit  ACX01277 AB	 ACX01278	

SYMBOLS (EXCEPT CONNECTOR AND GROUNDING)

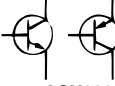
Devices appearing in circuit diagrams are indicated by the following symbols.

<p align="center">Battery</p>  <p align="center">ACX02377 AB</p>	<p align="center">Buzzer</p>  <p align="center">ACX02378 AB</p>	<p align="center">Capacitor</p>  <p align="center">ACX02379 AB</p>	<p align="center">Electrolytic capacitor</p>  <p align="center">ACX02380 AB</p>	<p align="center">Variable capacitor</p>  <p align="center">ACX02381 AB</p>	<p align="center">Coil</p>  <p align="center">ACX02382 AB</p>
<p align="center">Diode</p>  <p align="center">ACX02383 AB</p>	<p align="center">Light emitting diode</p>  <p align="center">ACX02384 AB</p>	<p align="center">Photo diode</p>  <p align="center">ACX02385 AB</p>	<p align="center">Zener diode</p>  <p align="center">ACX02386 AB</p>	<p align="center">Dual filament bulb</p>  <p align="center">ACX02387 AC</p>	<p align="center">Single filament bulb</p>  <p align="center">ACX02388 AC</p>
<p align="center">Fuse</p>  <p align="center">ACX02389 AB</p>	<p align="center">Fusible link</p>  <p align="center">ACX02390 AB</p>	<p align="center">Horn</p>  <p align="center">ACX02391 AB</p>	<p align="center">Motor</p>  <p align="center">ACX02392 AB</p>	<p align="center">Pulse generator</p>  <p align="center">ACX02393 AB</p>	<p align="center">Piezoelectric device</p>  <p align="center">ACX02394 AB</p>
<p align="center">Resistor</p>  <p align="center">ACX02395 AB</p>	<p align="center">Variable resistor</p>  <p align="center">ACX02396 AB</p>	<p align="center">Speaker</p>  <p align="center">ACX02397 AB</p>	<p align="center">Thermistor</p>  <p align="center">ACX02398 AB</p>	<p align="center">Transistor</p>  <p align="center">ACX02399 AB</p>	<p align="center">Photo transistor</p>  <p align="center">ACX02400 AB</p>

WIRE COLOR CODES

Wire colors are identified by the following color codes.

CODE	WIRE COLOR	CODE	WIRE COLOR	CODE	WIRE COLOR	CODE	WIRE COLOR
B	Black	L	Blue	R	Red	Y	Yellow
BR	Brown	LG	Light green	SB	Sky blue	-	-
G	Green	O	Orange	V	Violet	-	-
GR	Gray	P	Pink	W	White	-	-

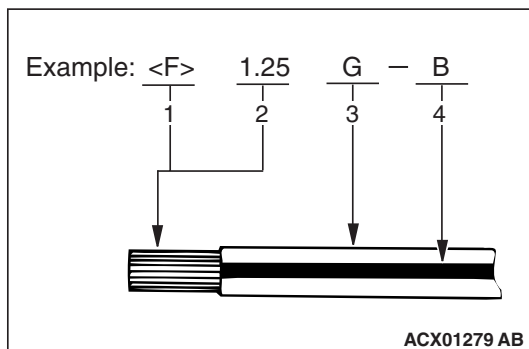

If a cable has two colors, the first of the two color code characters indicates the basic color (color of the cable coating) and the second indicates the marking (tracer) color.

NO.	MEANING
1	<F>: Flexible wire
	<T>: Twisted wire
2	Wire size (mm ²)*
3	Basic color (color of the cable coating)
4	Marking color

NOTE:

*: No code indicates 0.5 mm² (0.0008 in²). Cable color code in parentheses indicates 0.3 mm² (0.0005 in²).

JUNCTION BLOCK

M1901000201425

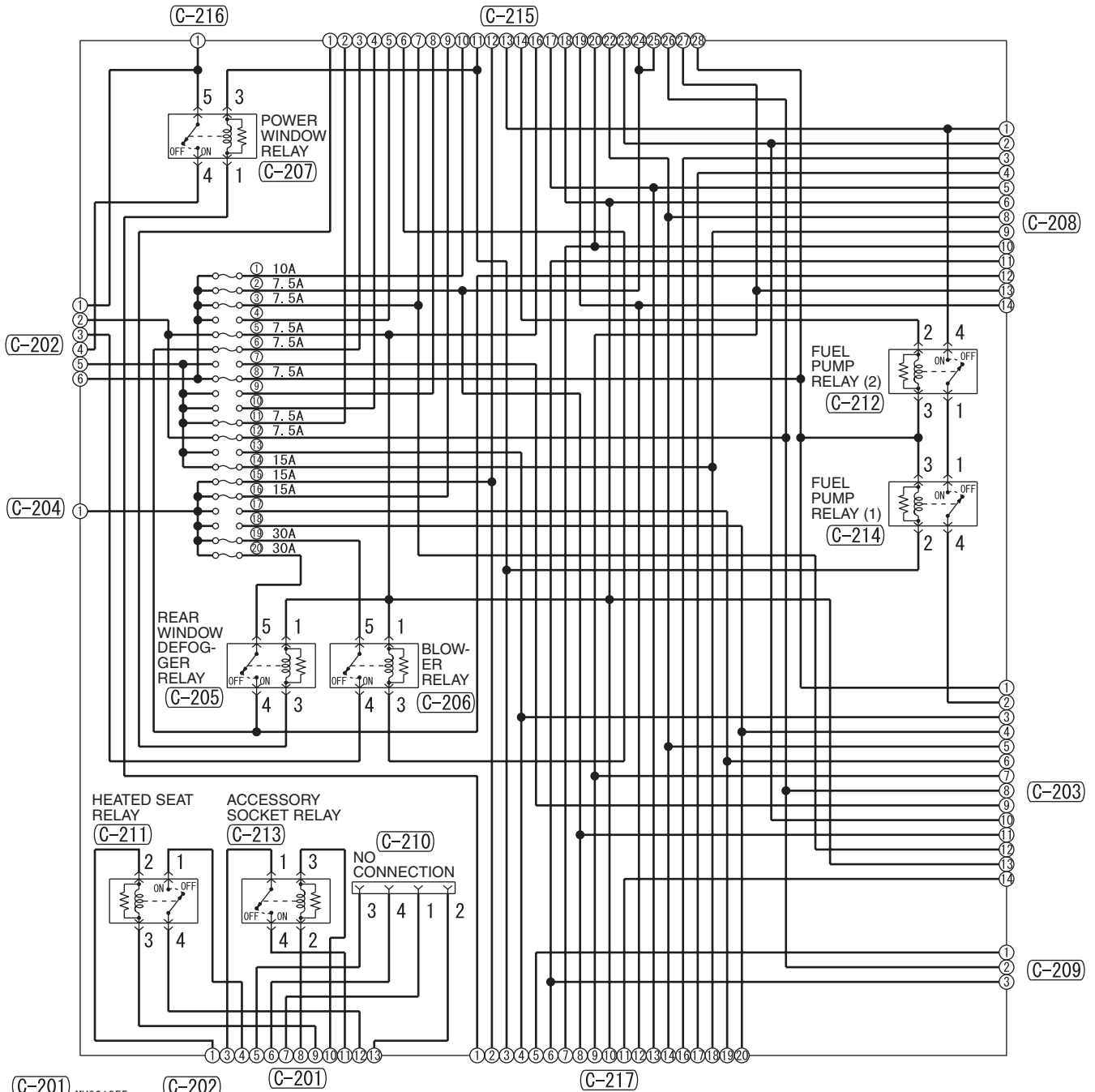

NOTE
CONNECTOR NUMBERS ARE KEYED TO THE CONFIGURATION
DIAGRAM (DASH PANEL) AND EACH CIRCUIT DIAGRAM.

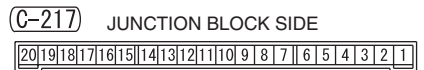
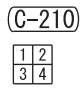
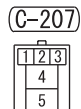
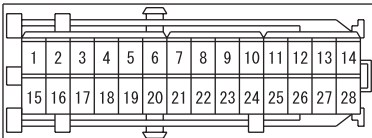
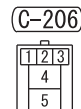
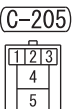
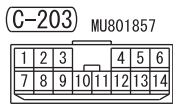
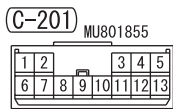

H6P00M00AA

FRONT VIEW

REAR VIEW

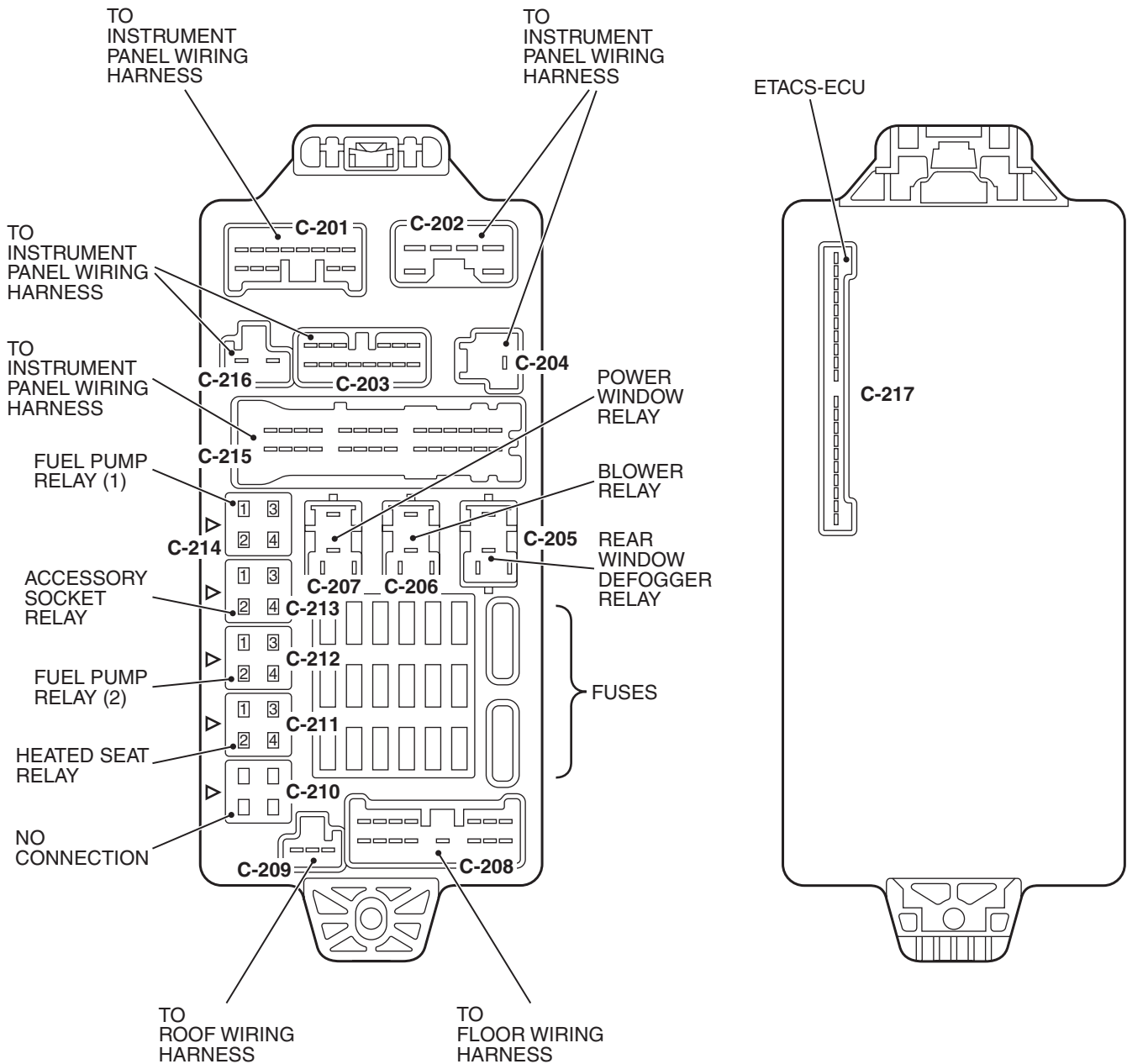

AC407157AB

JOINT CONNECTOR

M1901014201688

NOTE: IN THE ACTUAL VEHICLES, SOME OF THE JOINT CONNECTOR TERMINALS IN THE SAME BUS ARE USED, SO IN SOME CASES, THE TERMINAL ARRANGEMENT INDICATED ON THE CIRCUIT DIAGRAMS DOSE NOT COINSIDE WITH THE ONES IN THE ACTUAL VEHICLES.
HOWEVER, ON JOINT CONNECTOR (3), THE ACTUAL TERMINAL AGREEMENT SHOULD ALWAYS AGREE WITH THE CIRCUIT DIAGRAMS.

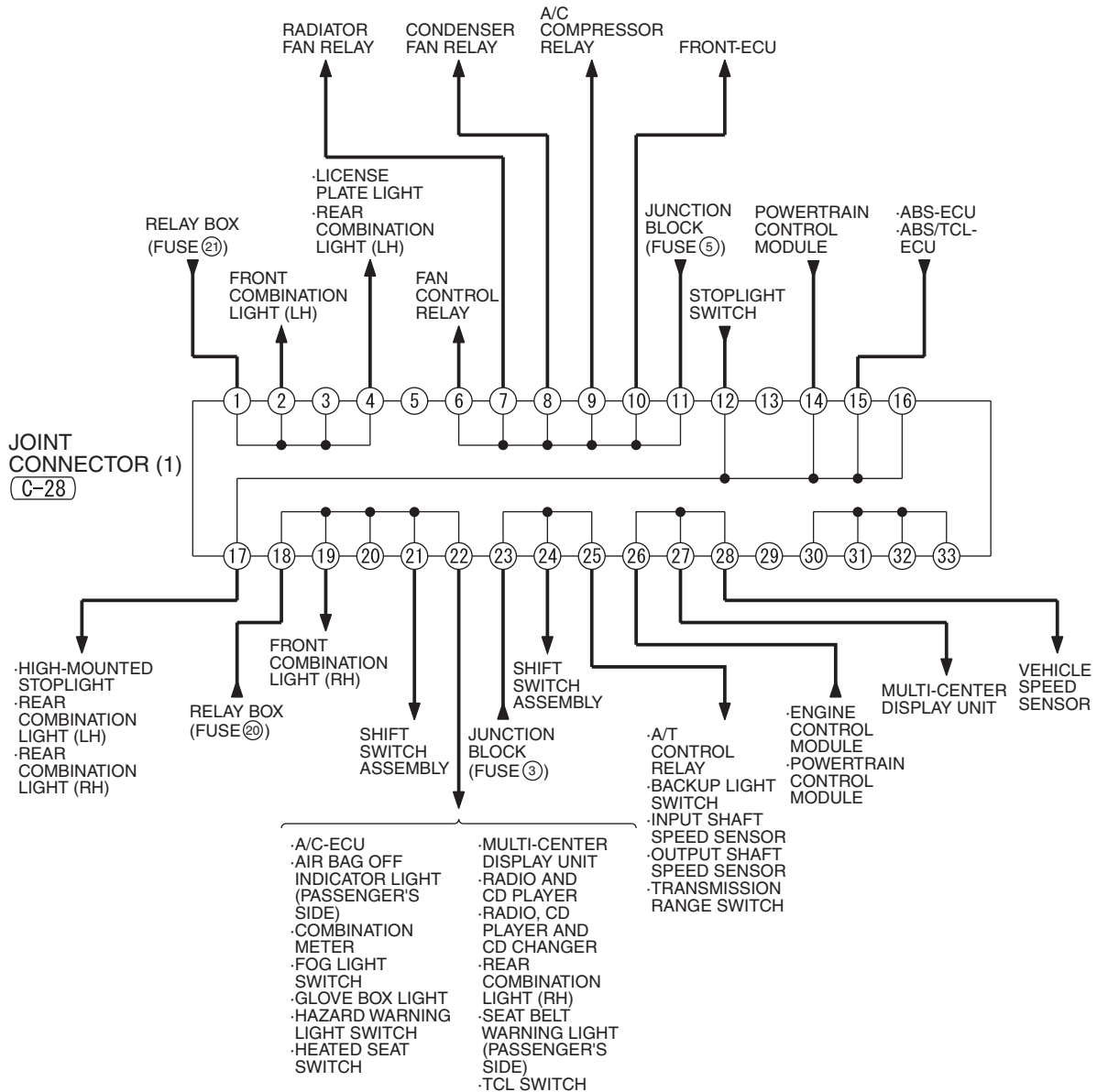

(C-01)

1	2	3	4	5	6	7	8	9	10	11
12	13	14	15	16	17	18	19	20	21	22
23	24	25	26	27	28	29	30	31	32	33

(C-28)

1	2	3	4	5	6	7	8	9	10	11
12	13	14	15	16	17	18	19	20	21	22
23	24	25	26	27	28	29	30	31	32	33

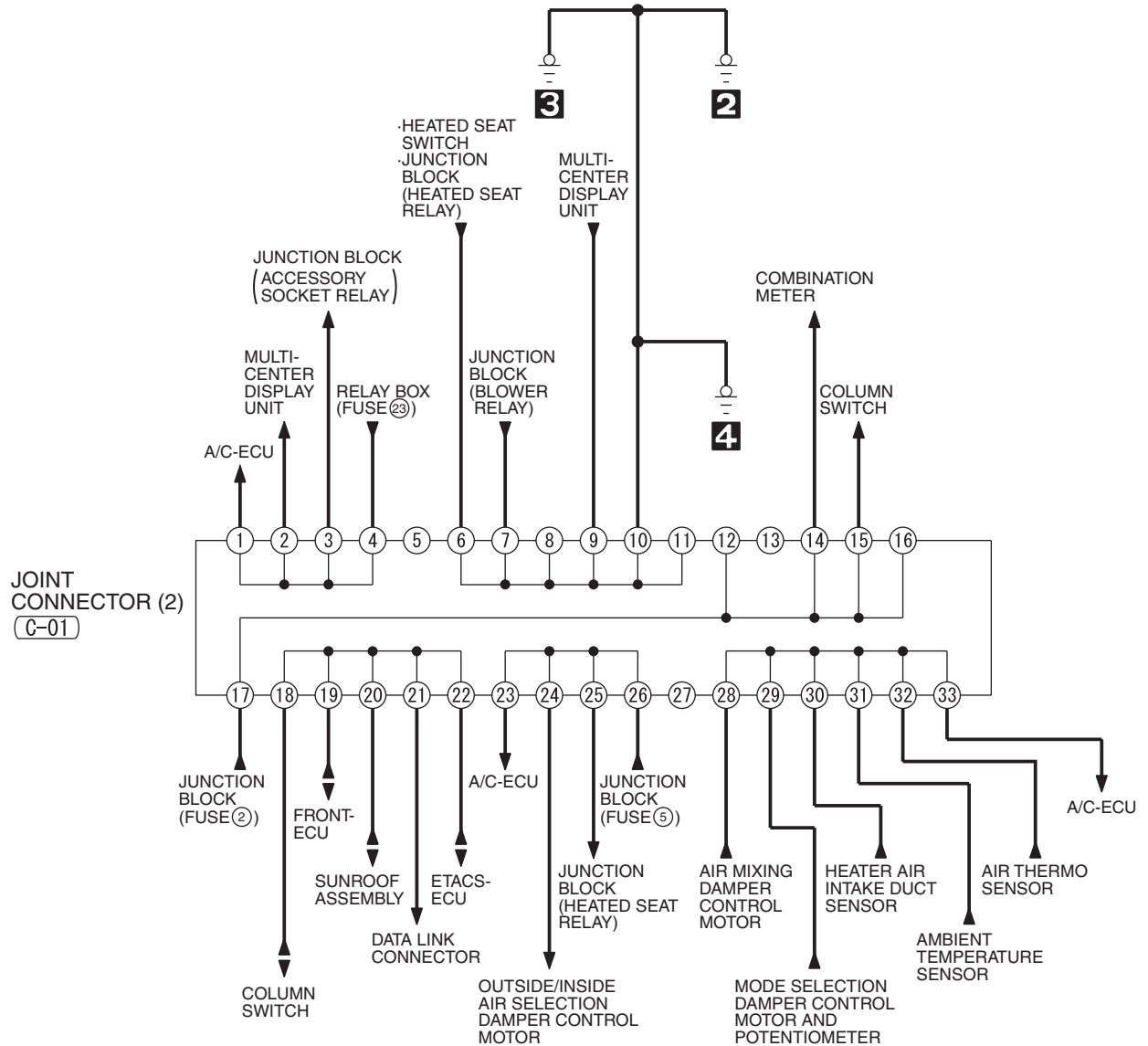

JOINT CONNECTOR (CONTINUED)

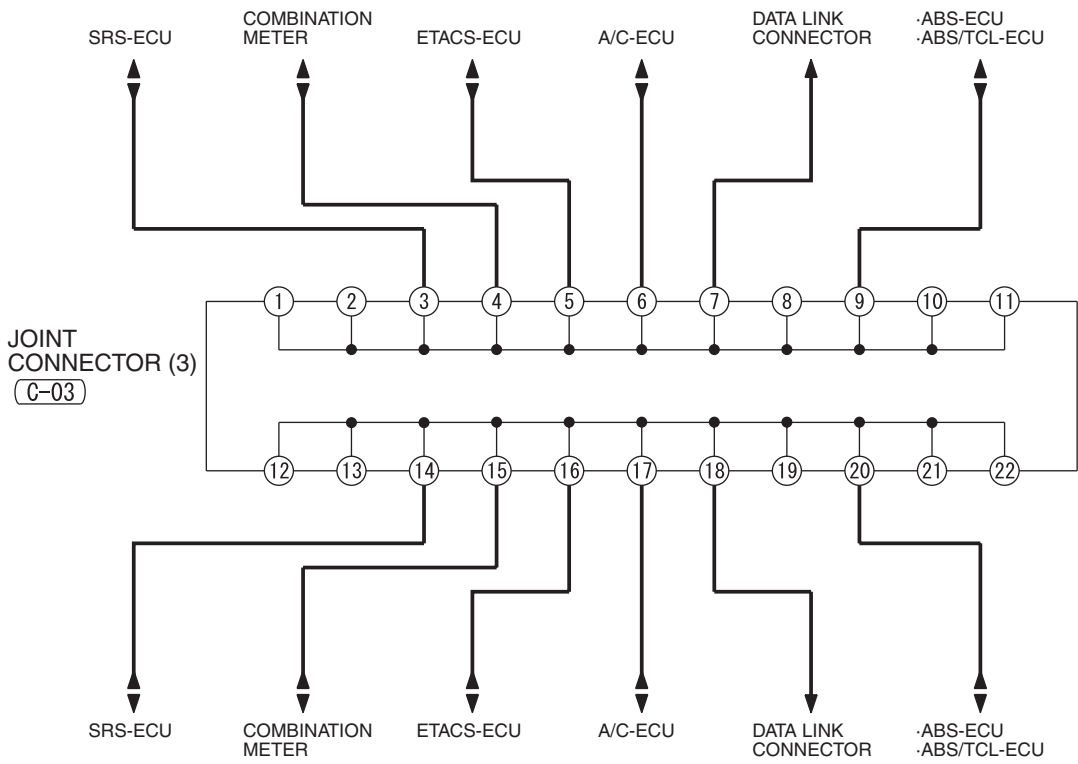

C-03

MJ801515

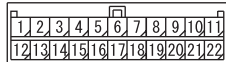

CENTRALIZED JUNCTION

M1901000301370

FUSIBLE LINK AND FUSE ENGINE COMPARTMENT

NO.	POWER SUPPLY CIRCUIT	NAME	RATED CAPACITY (A)	HOUSING COLOR	LOAD CIRCUIT
1	Battery/Generator (Fusible link No.27)	Fusible link	80	Black	Fuse Nos.15, 16, 19 and 20 (in junction block) circuit
2			30 *1 50 *2	Pink *1 Red *2	Fan control module and radiator fan motor
3			60	Yellow	ABS-ECU and ABS/TCL-ECU
4			40	Green	Ignition switch circuit
5			30	Pink	Fuse No.21 (in junction block circuit), power window motor and power seat assembly
6		Fuse	15	Blue	Front fog light and front fog light relay
7			20	Yellow	Heated seat assembly and heated seat switch
8			15	Red	Horn (High), horn (Low) and horn relay
9			20	Yellow	Camshaft position sensor, crankshaft position sensor, engine control module, engine oil control valve, evaporative emission purge solenoid, evaporative emission ventilation solenoid, exhaust gas recirculation valve, fan control relay, fuel injector, heated oxygen sensor, mass airflow sensor, MFI relay, powertrain control module, throttle actuator control motor relay, variable intake air control solenoid valve and vehicle speed sensor
10			10	Red	A/C compressor assembly and A/C-ECU
11			7.5	Brown	ABS-ECU, ABS/TCL-ECU, high-mounted stoplight, powertrain control module and rear combination light
12			30	Green	Audio amplifier
13			7.5	Brown	Generator
14			10	Red	ETACS-ECU
15			20	Yellow	A/T control solenoid valve assembly and powertrain control module
16	Front-ECU (Headlight relay: High)	10	Red	Headlight (RH)	
17		10	Red	Headlight (LH)	

NO.	POWER SUPPLY CIRCUIT	NAME	RATED CAPACITY (A)	HOUSING COLOR	LOAD CIRCUIT
18	Front-ECU (Field effect transistor for headlight: Low)	Fuse	10	Red	Headlight (RH)
19			10	Red	Headlight (LH)
20	Front-ECU (Taillight relay)		7.5	Brown	A/C-ECU, air bag off indicator light (passenger's side), combination meter, front fog light switch, front combination light (RH), glove box light, hazard warning light switch, heated seat switch, multi-center display unit, radio, CD player, CD changer, rear combination light (RH), seat belt warning light (passenger's side), shift switch assembly and TCL switch
21			7.5	Brown	Front combination light (LH), license plate light and rear combination light (LH)
22	Battery/Generator (Fusible link No.27)		10	Red	A/C-ECU, column switch, combination meter, ETACS-ECU, front-ECU, key reminder switch, multi-center display unit, radio, CD player, CD changer and vanity mirror light
23	Ignition switch (ACC)		15	Blue	A/C-ECU, accessory socket relay, ETACS-ECU, multi-center display unit, radio, CD player and CD changer
24	Battery/Generator (Fusible link No.27)		15	Blue	Fuel pump module
25	Ignition switch (ACC)		30	Green	Front-ECU and windshield wiper motor
26	Battery/Generator (Fusible link No.27)	Fusible link	20	Light blue	Condenser fan motor
27	Generator		120	–	Battery, front-ECU, fusible link Nos.1, 2, 3, 4, 5 and 26 and fuse Nos.6, 7, 8, 9, 10, 11, 12, 13, 14, 15, 22 and 24 (in relay box)

NOTE:

1. *1: 2.4L Engine
2. *2: 3.8L Engine

(RELAY BOX IN ENGINE COMPARTMENT)

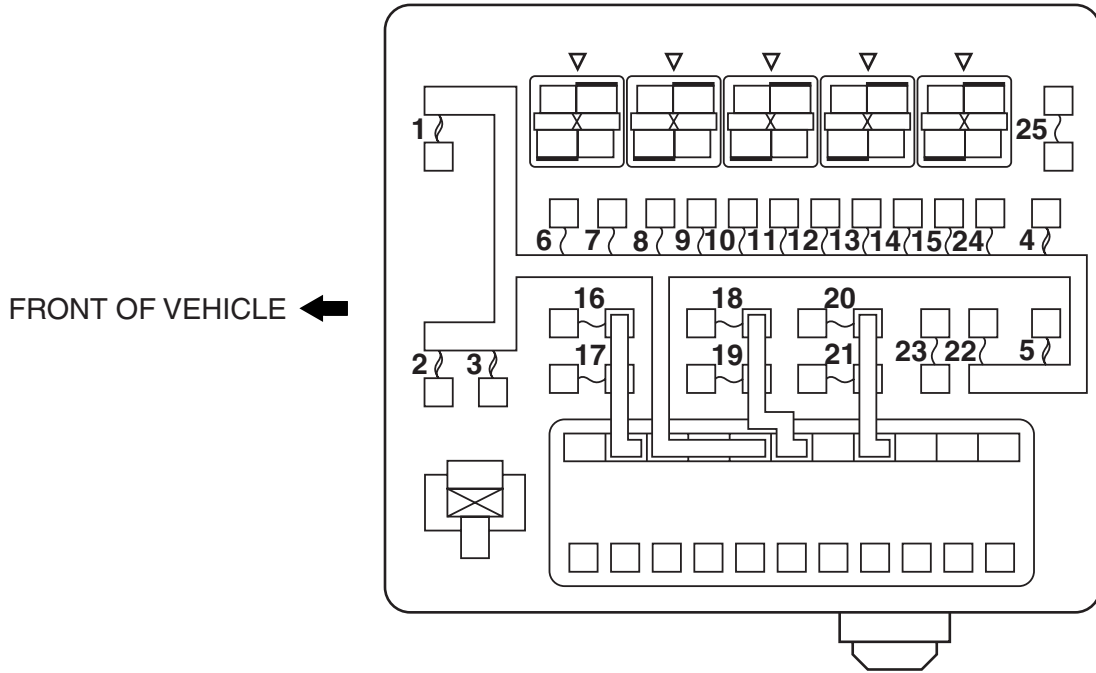

AC208462AB

(RELAY BOX IN ENGINE COMPARTMENT)

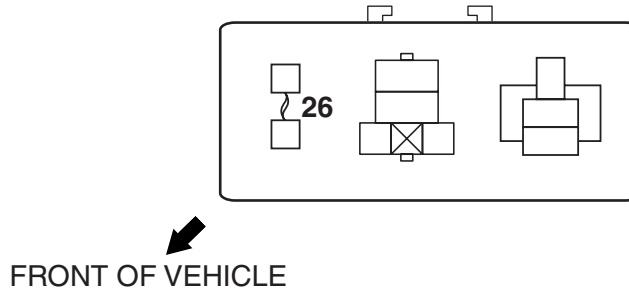

AC303418AB

(CONNECTED DIRECTLY TO BATTERY POSITIVE TERMINAL)

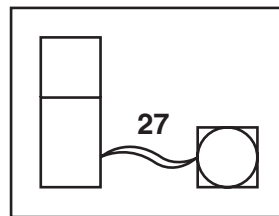

AC207745AG

PASSENGER COMPARTMENT

NO.	POWER SUPPLY CIRCUIT	NAME	RATED CAPACITY (A)	HOUSING COLOR	LOAD CIRCUIT
1	Ignition switch (IG1)	Fuse	10	Red	Capacitor and ignition coil
2			7.5	Brown	ABS-ECU, ABS/TCL-ECU, column switch, combination meter, ETACS-ECU, multi-center display unit and SRS-ECU
3			7.5	Brown	A/T control relay, air bag off indicator light (passenger's side), input shaft speed sensor, occupant classification-ECU, output shaft speed sensor, powertrain control module, rear combination light, seat belt warning light (passenger's side) and SRS-ECU
4			–	–	–
5	Ignition switch (IG2)		7.5	Brown	A/C compressor clutch relay, A/C-ECU, blower relay, condenser fan relay, fan control relay, front-ECU, heated seat relay, outside/inside air selection damper control motor, power window motor (LH), radiator fan relay and rear window defogger relay
6	Fusible link No.1 (Fuse No.20 in junction block)		7.5	Brown	Remote controlled mirror (mirror heater)
7	Ignition switch (ACC)		–	–	–
8	Ignition switch (IG1)		7.5	Brown	Engine control module, fuel pump relay and powertrain control module
9	Ignition switch (ACC)		–	–	–
10		–	–	–	
11		7.5	Brown	Remote controlled mirror	
12	Ignition switch (IG2)		7.5	Brown	Inside rear view mirror assembly and sunroof motor assembly
13	Ignition switch (ACC)		–	–	–
14		15	Blue	ETACS-ECU and rear wiper motor	
15	Fusible link No.1		15	Blue	Data link connector and ETACS-ECU
16		15	Blue	Accessory socket	
17		–	–	–	
18		–	–	–	
19		30	Green	Blower motor and resistor	
20		30	Green	Capacitor and rear window defogger	
21	Fusible link No.5		20	Yellow	Sunroof motor assembly

NO.	POWER SUPPLY CIRCUIT	NAME	RATED CAPACITY (A)	HOUSING COLOR	LOAD CIRCUIT
22	–	Fuse	–	–	–
23	Power window relay (Fusible link No.5)		7.5	Brown	Power window main switch, power window motor and power window sub switch
24	–		–	–	–

(IN JUNCTION BLOCK)

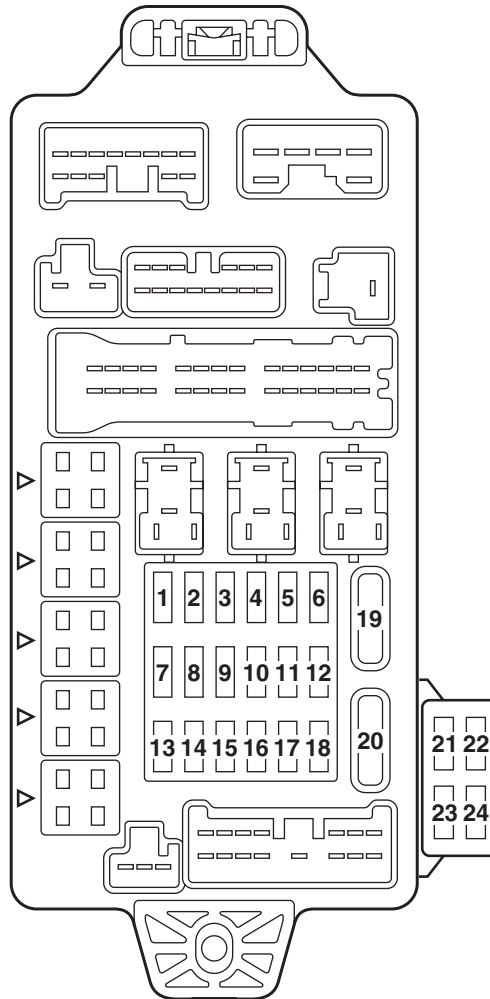

AC407158AB

CENTRALIZED RELAY

CONNECTOR NO.	NAME	CONNECTOR NO.	NAME
A-07X	Front fog light relay	A-20X	Radiator fan relay <2.4L Engine>
A-08X	Horn relay	B-10X	-
A-09X	-	B-11X	Starter relay <M/T>
A-10X	-	B-12X	-
A-11X	-	B-13X	Throttle actuator control motor relay
A-12X	Fan control relay	B-14X	-
A-13X	Front-ECU	B-15X	A/T control relay
A-14X	Front-ECU	B-16X	MFI relay
A-19X	Condenser fan relay <2.4L Engine>	B-17X	A/C compressor clutch relay

(RELAY BOX IN ENGINE COMPARTMENT)

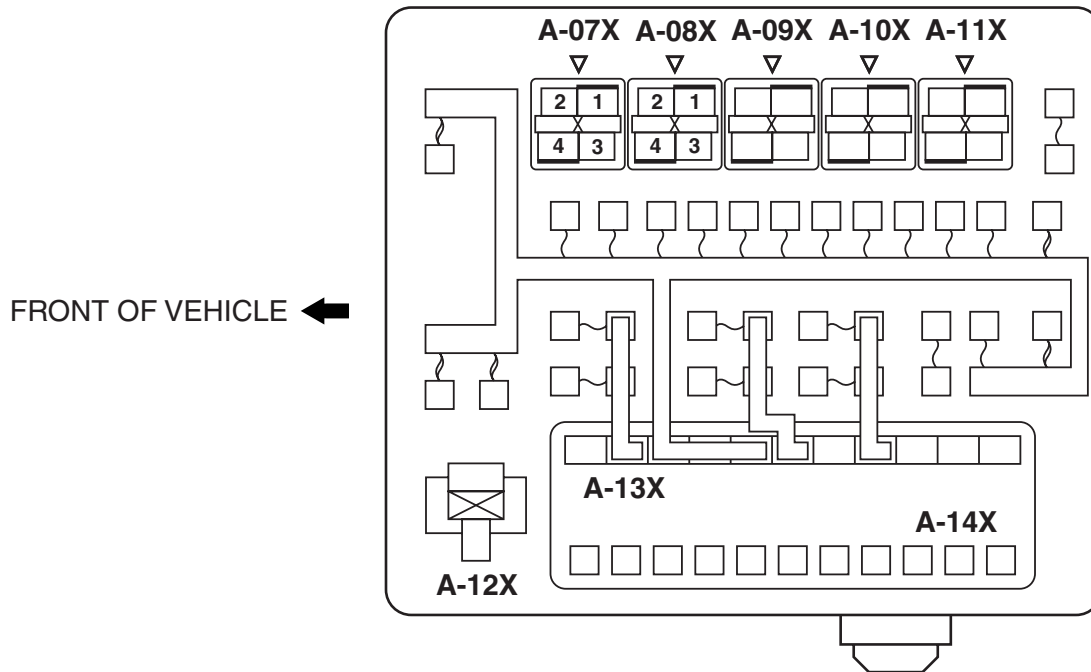

AC208462BA

(RELAY BOX IN ENGINE COMPARTMENT)

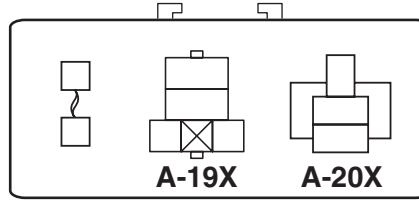

FRONT OF VEHICLE

AC303418AD

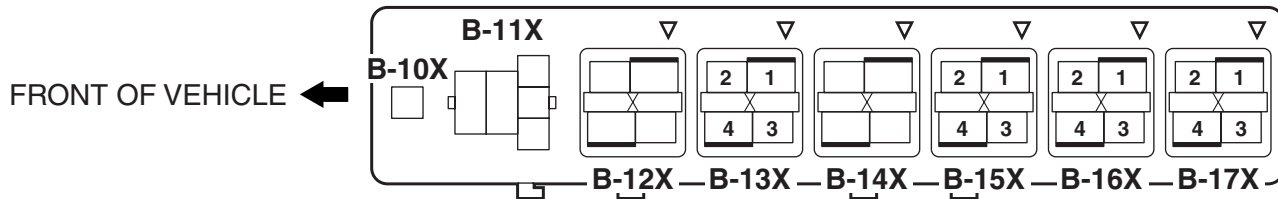

AC208464AR

NOTE: The triangle mark on the relay housing should face that on the relay box.

POWER DISTRIBUTION SYSTEM

M1901000401720

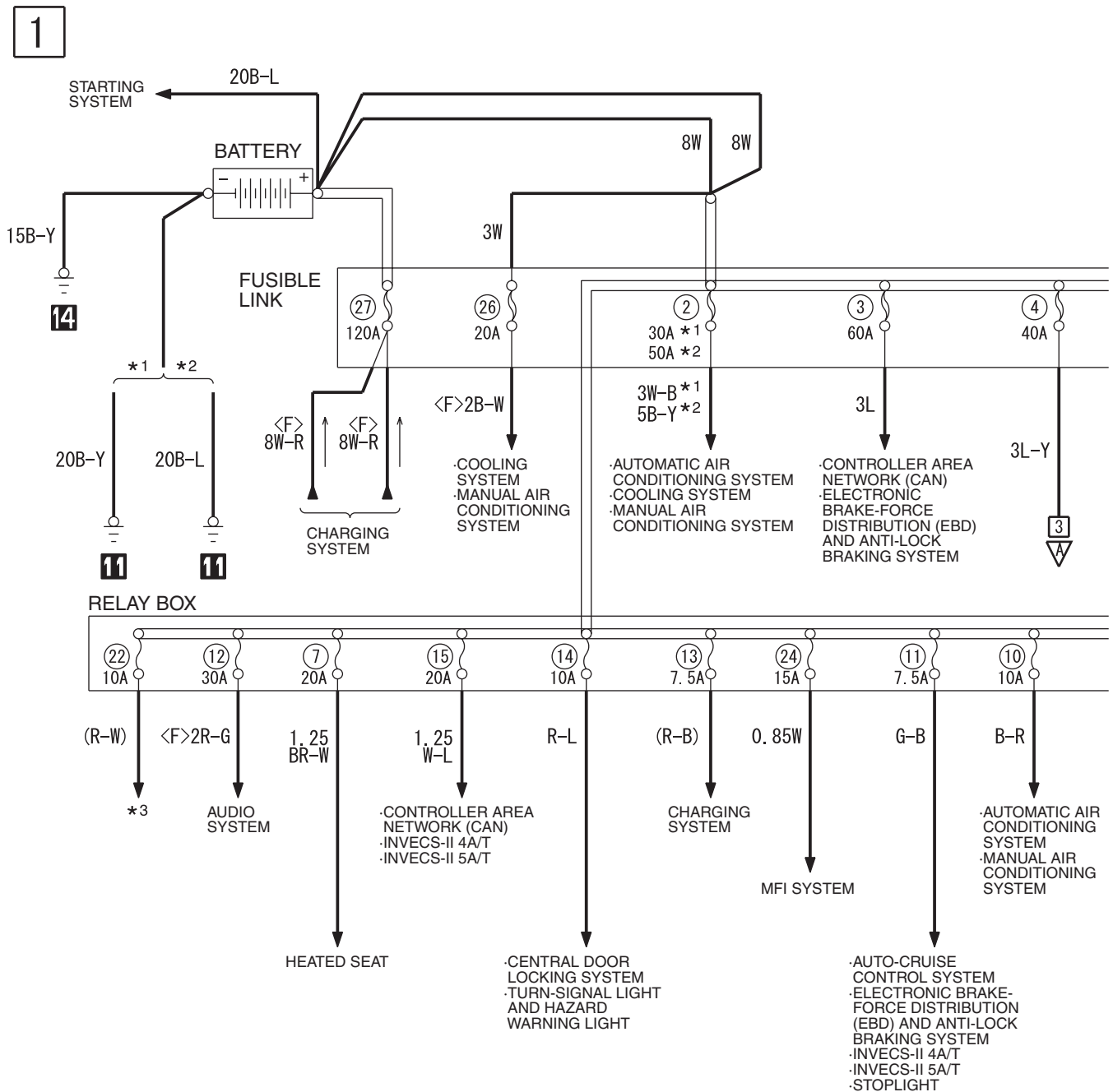

(A-13X)

1 2 3 4 5 6 7 8 9 10 11

H6P01M00AA

TSB Revision

NOTE

- *1: 2.4L ENGINE
- *2: 3.8L ENGINE

- *3: -AUDIO SYSTEM
- AUTO-CRUISE CONTROL SYSTEM
- AUTOMATIC AIR CONDITIONING SYSTEM
- BRAKE WARNING LIGHT, OIL PRESSURE WARNING LIGHT, FUEL WARNING LIGHT
- CENTRAL DOOR LOCKING SYSTEM
- CHARGING SYSTEM
- CONTROLLER AREA NETWORK (CAN)

- DOOR AJAR WARNING TONE ALARM
- ELECTRONIC BRAKE-FORCE DISTRIBUTION (EBD) AND ANTI-LOCK BRAKING SYSTEM (ABS)
- ENGINE IMMOBILIZER SYSTEM
- FOG LIGHT
- FRONT DOME LIGHT, REAR DOME LIGHT, LUGGAGE COMPARTMENT LIGHT AND IGNITION KEY HOLE ILLUMINATION LIGHT
- HEADLIGHT

- IGNITION KEY REMINDER TONE ALARM
- INVECS-II 4A/T
- INVECS-II 5A/T
- LIGHTING MONITOR TONE ALARM
- MANUAL AIR CONDITIONING SYSTEM
- METER AND GAUGE
- MFI SYSTEM
- MULTI-CENTER DISPLAY
- POWER WINDOWS
- REAR WIPER AND WASHER
- SEAT BELT WARNING TONE ALARM
- SUNROOF

- SUPPLEMENTAL RESTRAINT SYSTEM (SRS)
- TAILLIGHT, POSITION LIGHT AND LICENSE PLATE LIGHT
- TURN-SIGNAL LIGHT AND HAZARD WARNING LIGHT
- VANITY MIRROR LIGHT
- WINDSHIELD WIPER AND WASHER

2

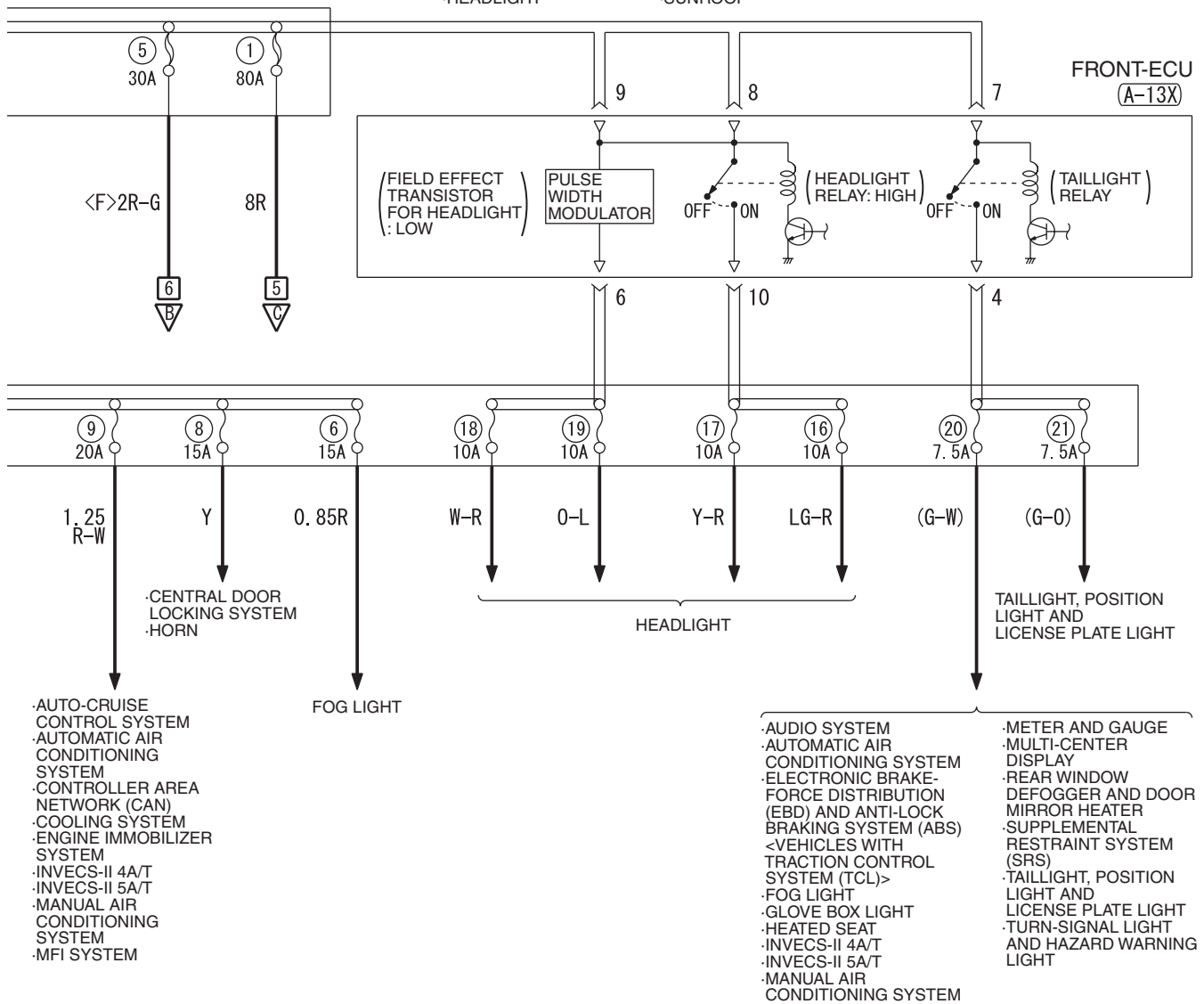

WIRE COLOR CODE

B: BLACK LG: LIGHT GREEN G: GREEN L: BLUE W: WHITE Y: YELLOW SB: SKY BLUE
 BR: BROWN O: ORANGE GR: GRAY R: RED P: PINK V: VIOLET PU: PURPLE

POWER DISTRIBUTION SYSTEM (CONTINUED)

3

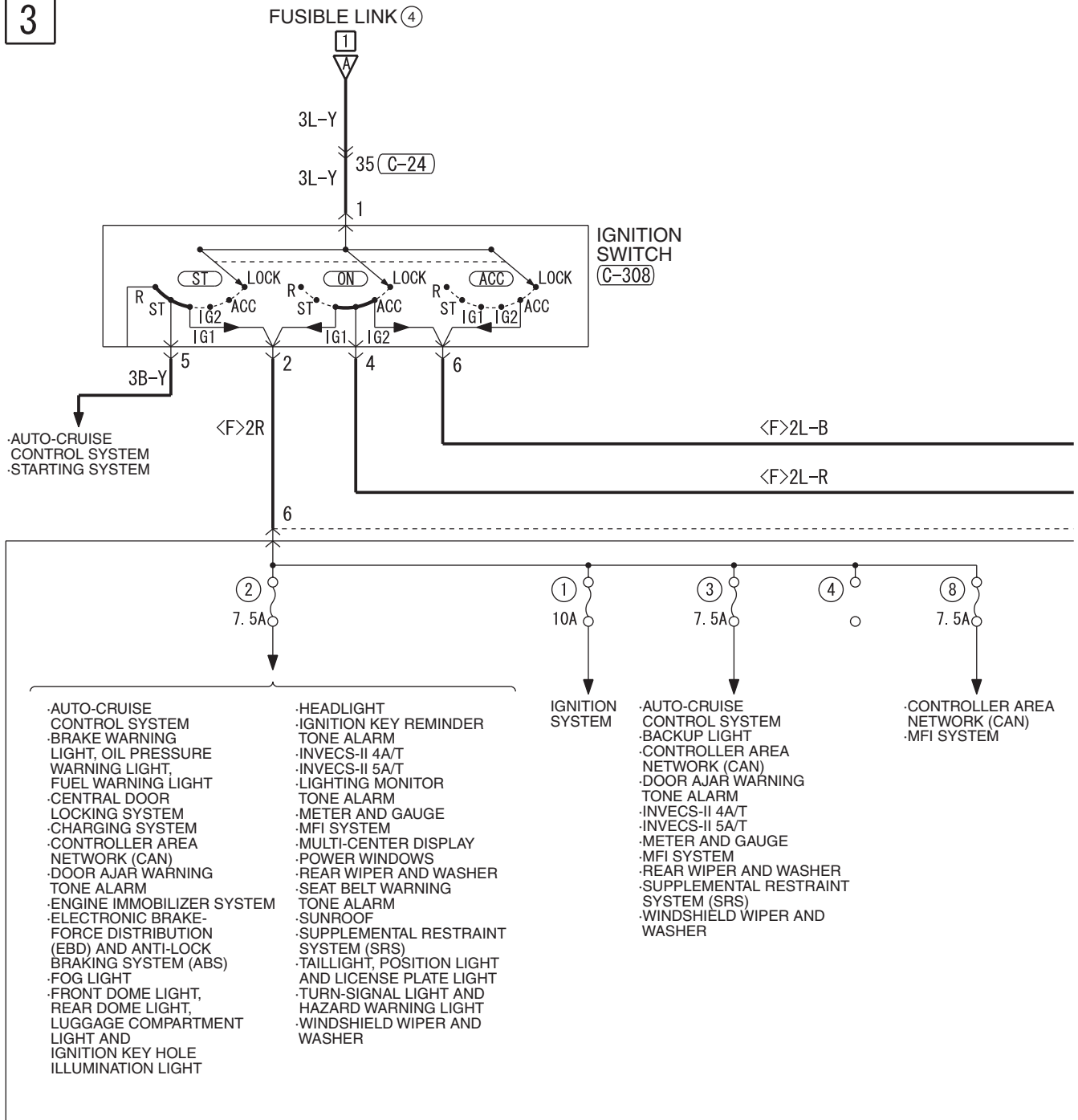

(C-24)

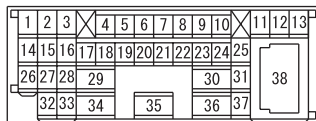

(C-202)



(C-308)



4

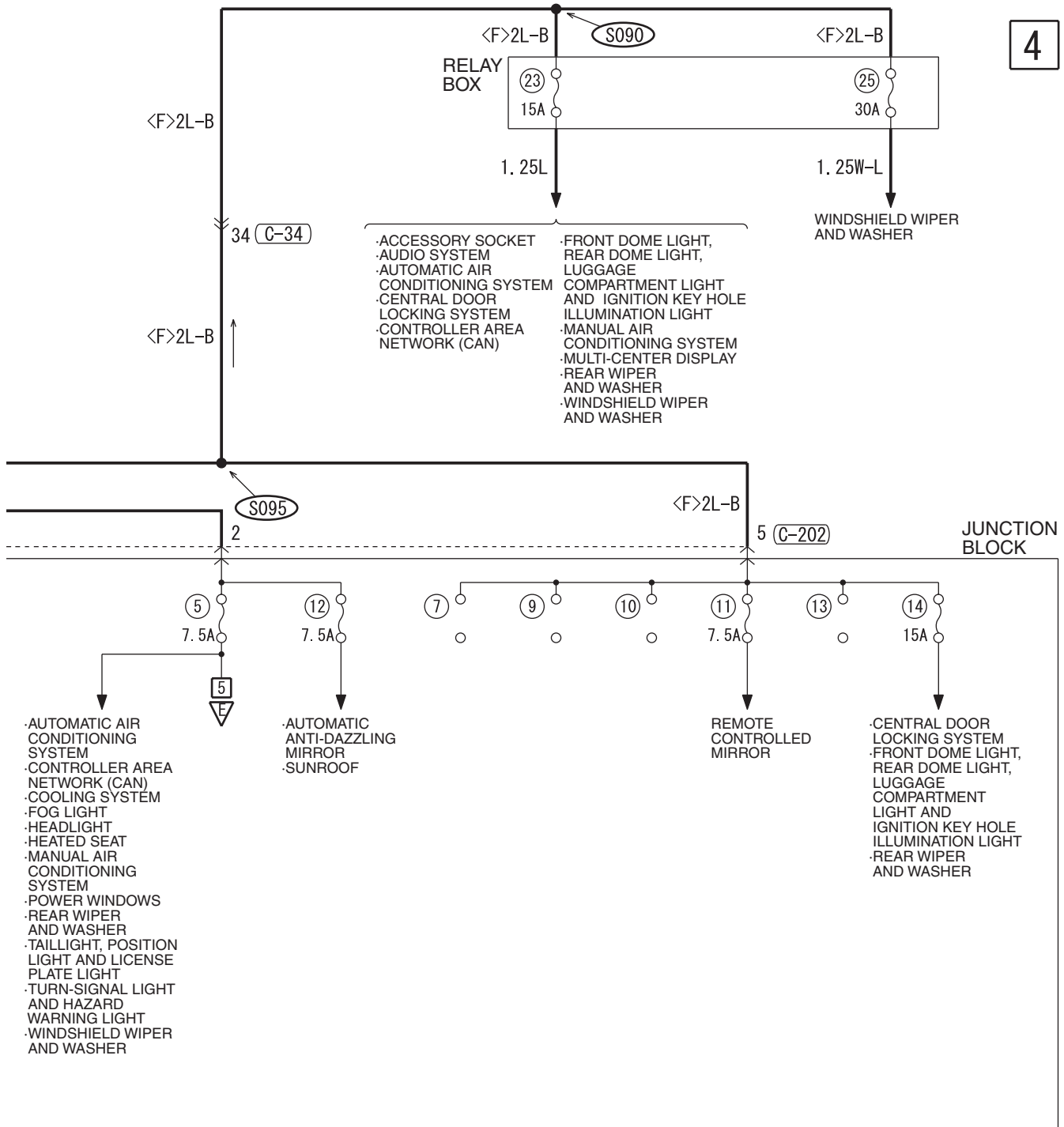

WIRE COLOR CODE

B: BLACK LG: LIGHT GREEN G: GREEN L: BLUE W: WHITE Y: YELLOW SB: SKY BLUE
BR: BROWN O: ORANGE GR: GRAY R: RED P: PINK V: VIOLET PU: PURPLE

H6P01M00BB

TSB Revision

POWER DISTRIBUTION SYSTEM (CONTINUED)

5

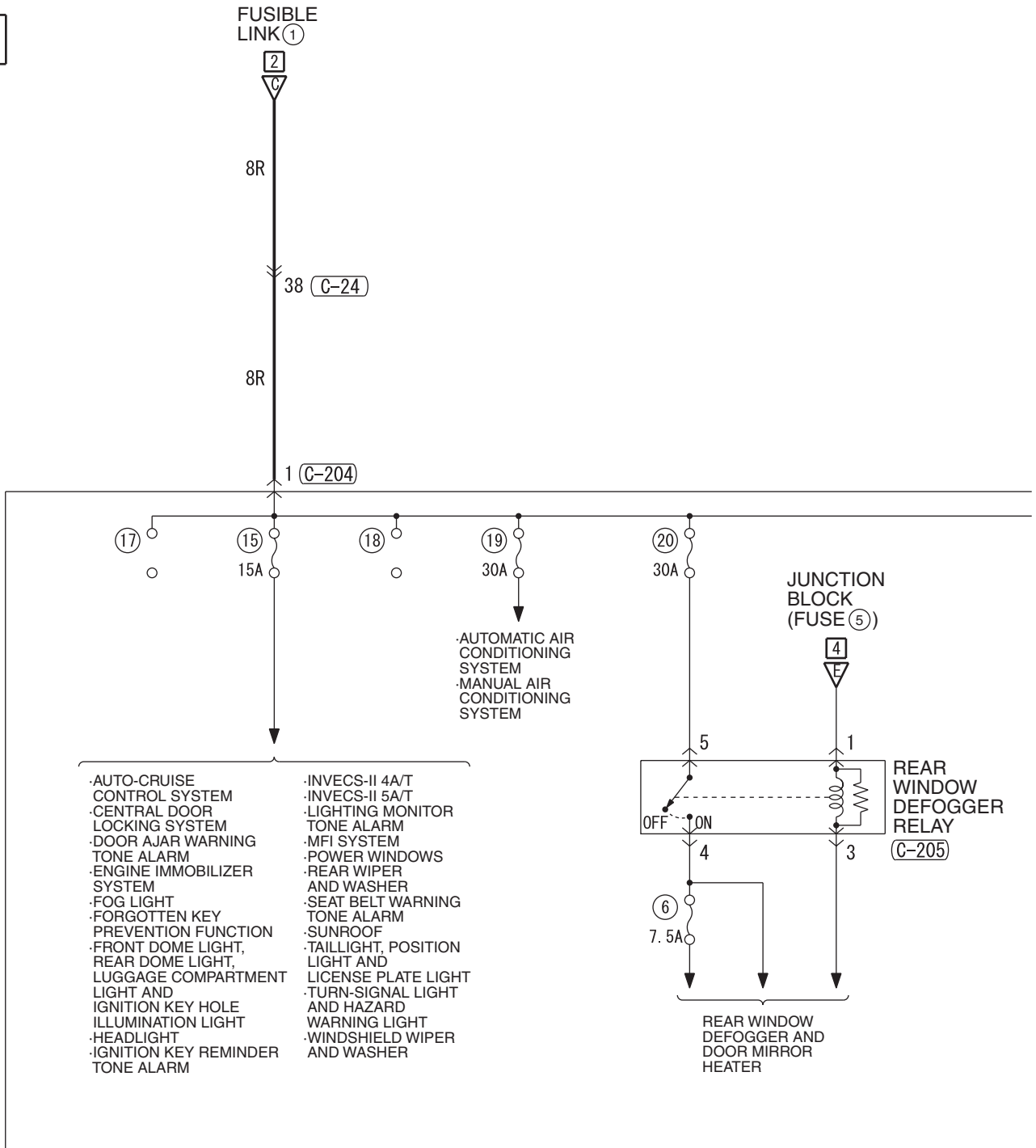

(C-24)

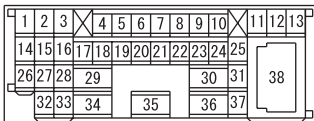

(C-201) MU801855

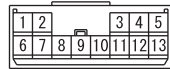

(C-202) MU801331



(C-204) MU801403



(C-205)



(C-207)



(C-213)



6

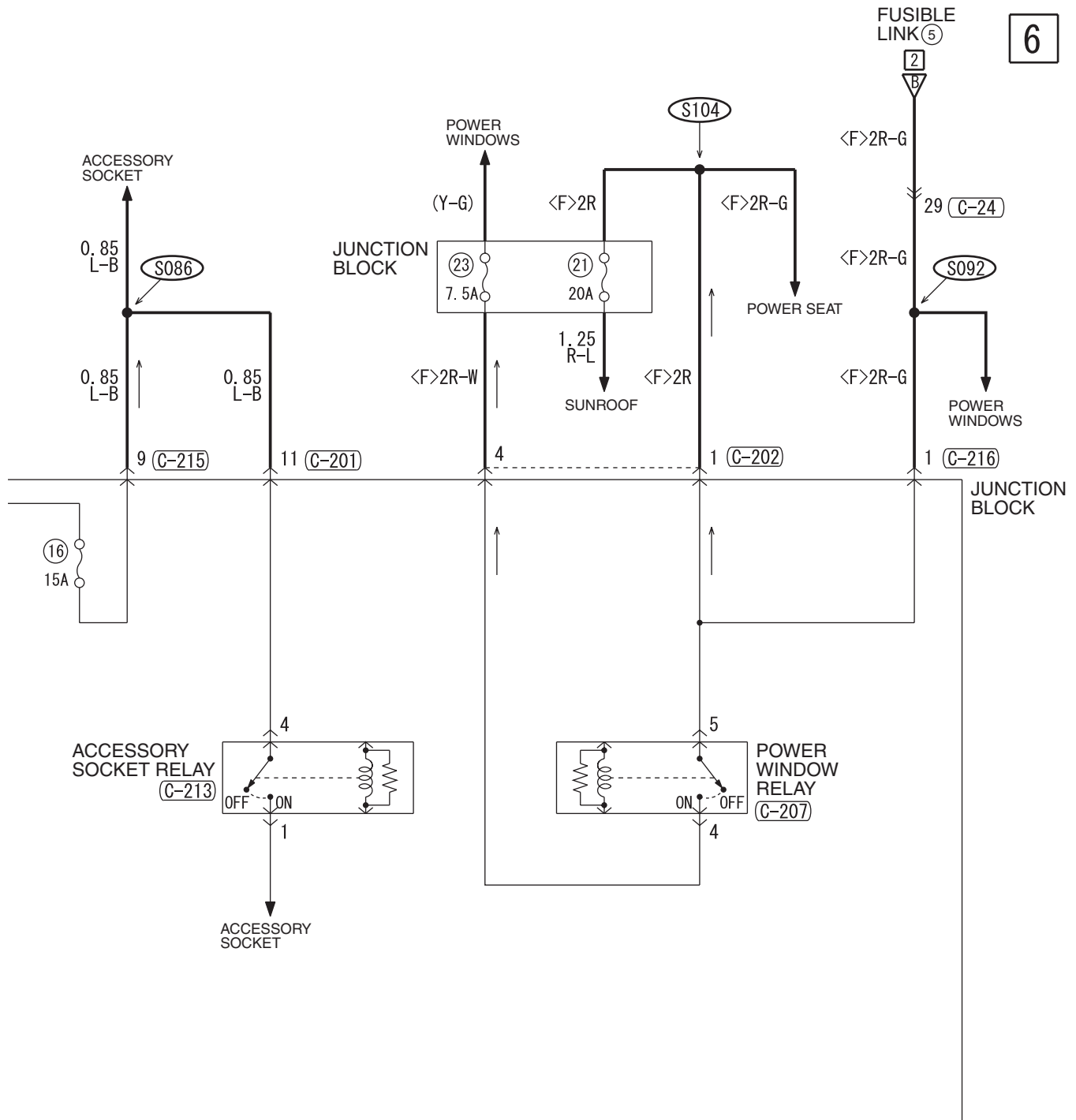

(C-215)

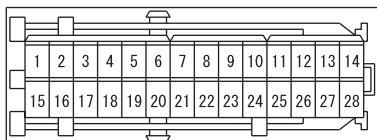

(C-216)



WIRE COLOR CODE
 B : BLACK LG : LIGHT GREEN G : GREEN L : BLUE
 BR : BROWN O : ORANGE GR : GRAY R : RED W : WHITE
 SB : SKY BLUE P : PINK Y : YELLOW V : VIOLET PU : PURPLE

H6P01M00CB

STARTING SYSTEM <M/T>

M1901000501943

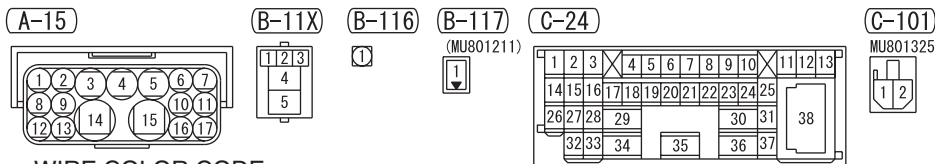
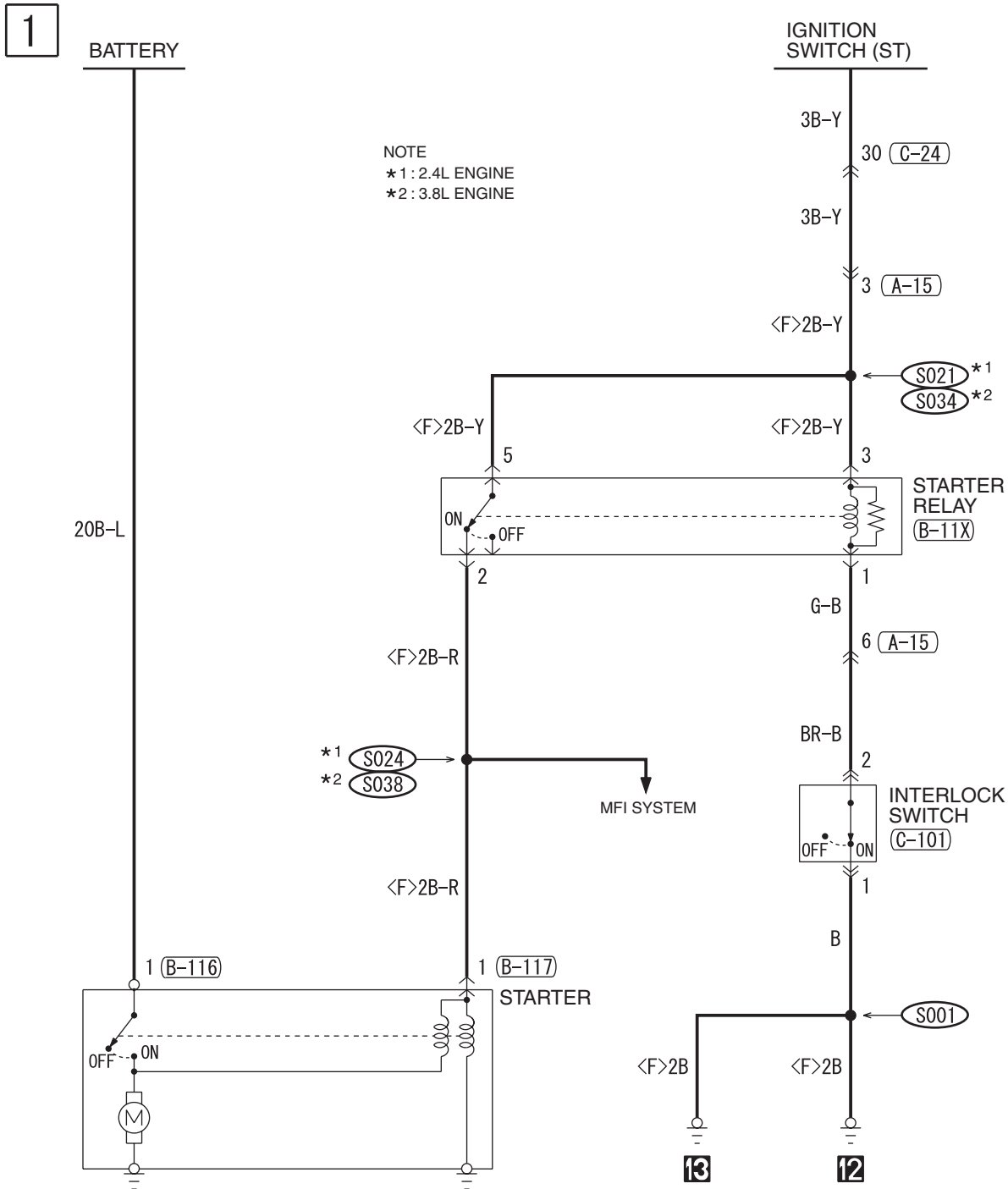

WIRE COLOR CODE

B: BLACK LG: LIGHT GREEN G: GREEN L: BLUE W: WHITE Y: YELLOW SB: SKY BLUE
BR: BROWN O: ORANGE GR: GRAY R: RED P: PINK V: VIOLET PU: PURPLE

H6P02M00AA

STARTING SYSTEM <A/T>

M1901000501954

1

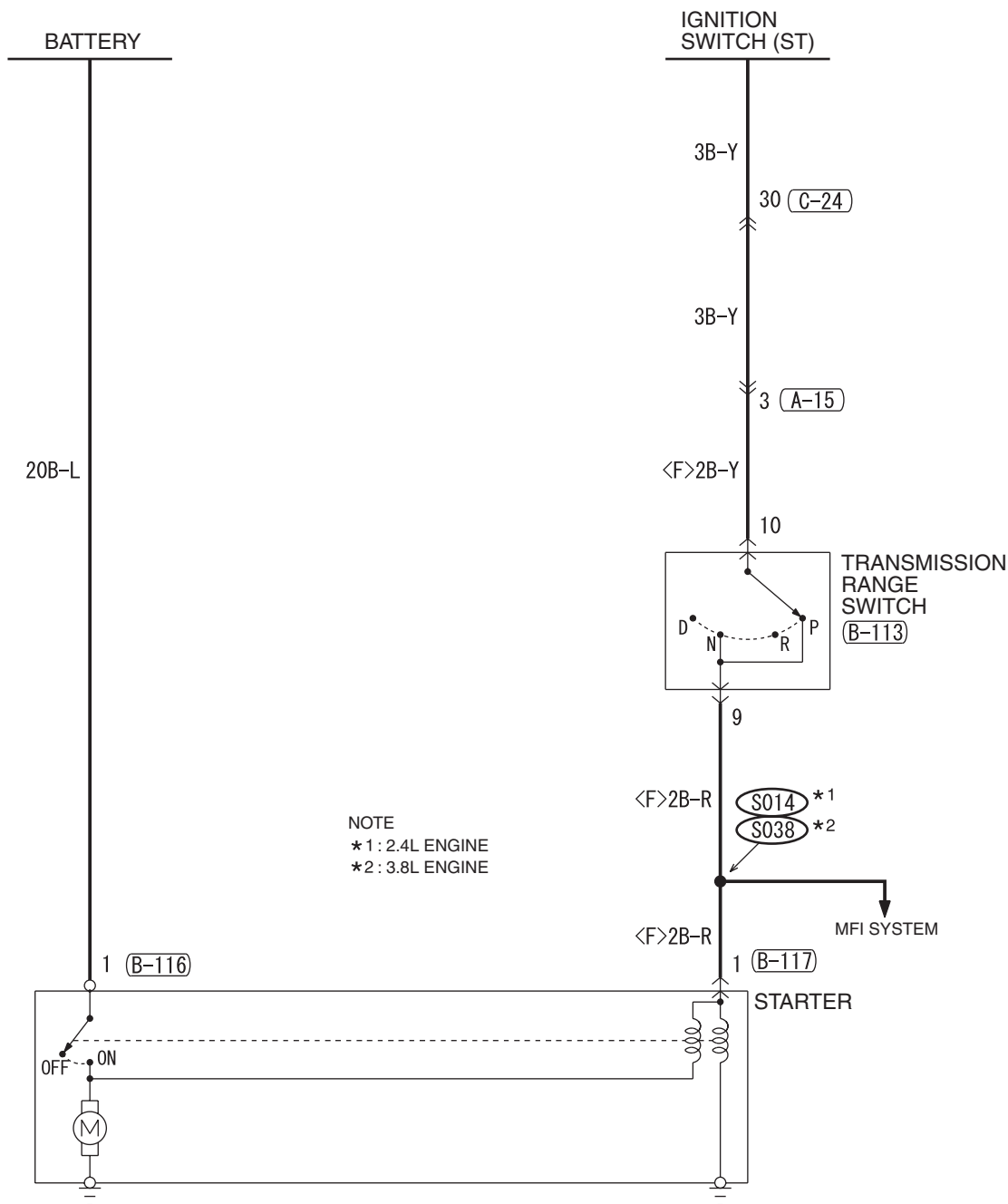

(A-15)

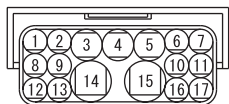

(B-113)

MU802355

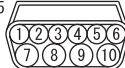

(B-116)



(B-117)

(MU801211)



(C-24)

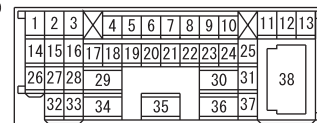

WIRE COLOR CODE

B: BLACK LG: LIGHT GREEN G: GREEN L: BLUE W: WHITE Y: YELLOW SB: SKY BLUE
BR: BROWN O: ORANGE GR: GRAY R: RED P: PINK V: VIOLET PU: PURPLE

H6P02M01AA

TSB Revision

IGNITION SYSTEM <2.4L ENGINE-M/T>

M1901000602653

1

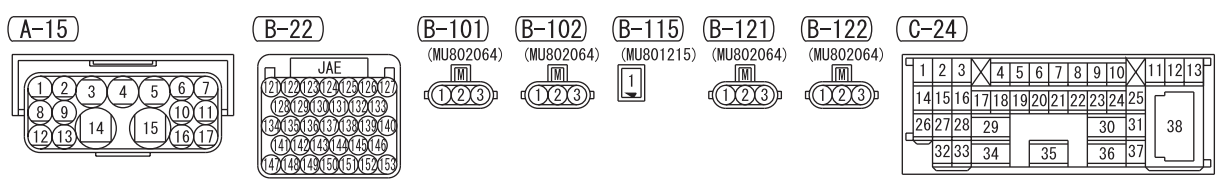
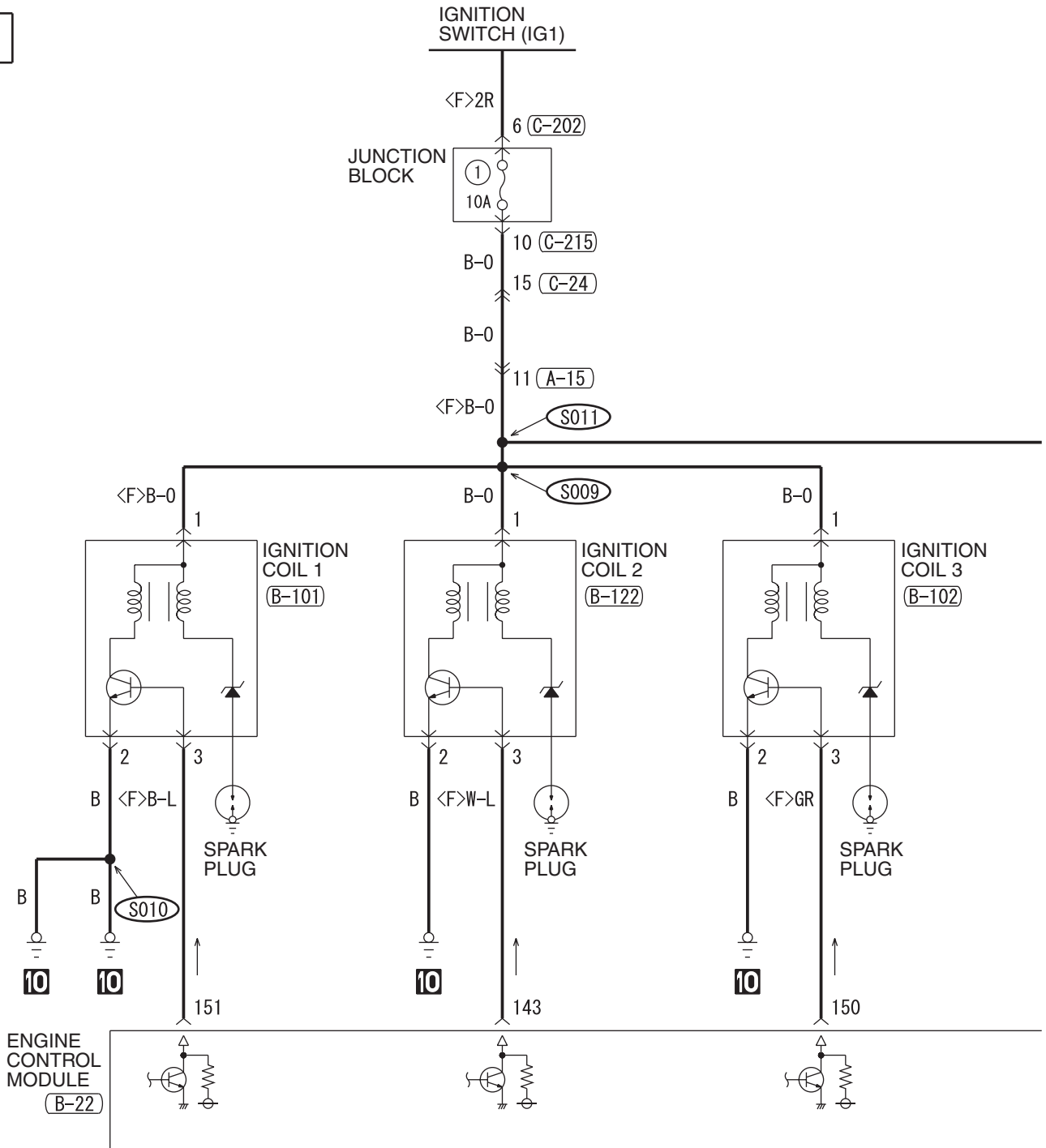

H6P03M00AA

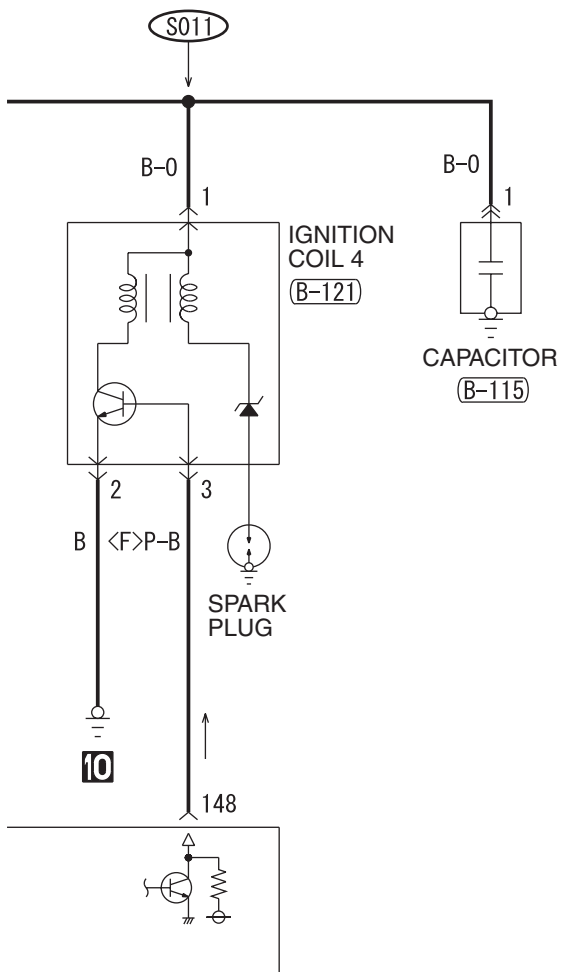

POWERTRAIN CONTROL MODULE INPUT SIGNAL	
·ACCELERATOR PEDAL POSITION SENSOR	·IGNITION SWITCH (ST)
·CAMSHAFT POSITION SENSOR	·INTAKE AIR TEMPERATURE SENSOR
·CRANKSHAFT POSITION SENSOR	·KNOCK SENSOR
·ENGINE COOLANT TEMPERATURE SENSOR	·MANIFOLD ABSOLUTE PRESSURE SENSOR
·FUEL TANK DIFFERENTIAL PRESSURE SENSOR	·MASS AIRFLOW SENSOR
·HEATED OXYGEN SENSOR	·THROTTLE POSITION SENSOR
	·VEHICLE SPEED SENSOR

(C-202)

(C-215)

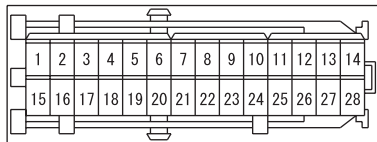

WIRE COLOR CODE
 B : BLACK LG : LIGHT GREEN G : GREEN L : BLUE
 BR : BROWN O : ORANGE GR : GRAY R : RED W : WHITE
 SB : SKY BLUE P : PINK Y : YELLOW V : VIOLET PU : PURPLE

IGNITION SYSTEM <2.4L ENGINE-A/T>

M1901000602664

1

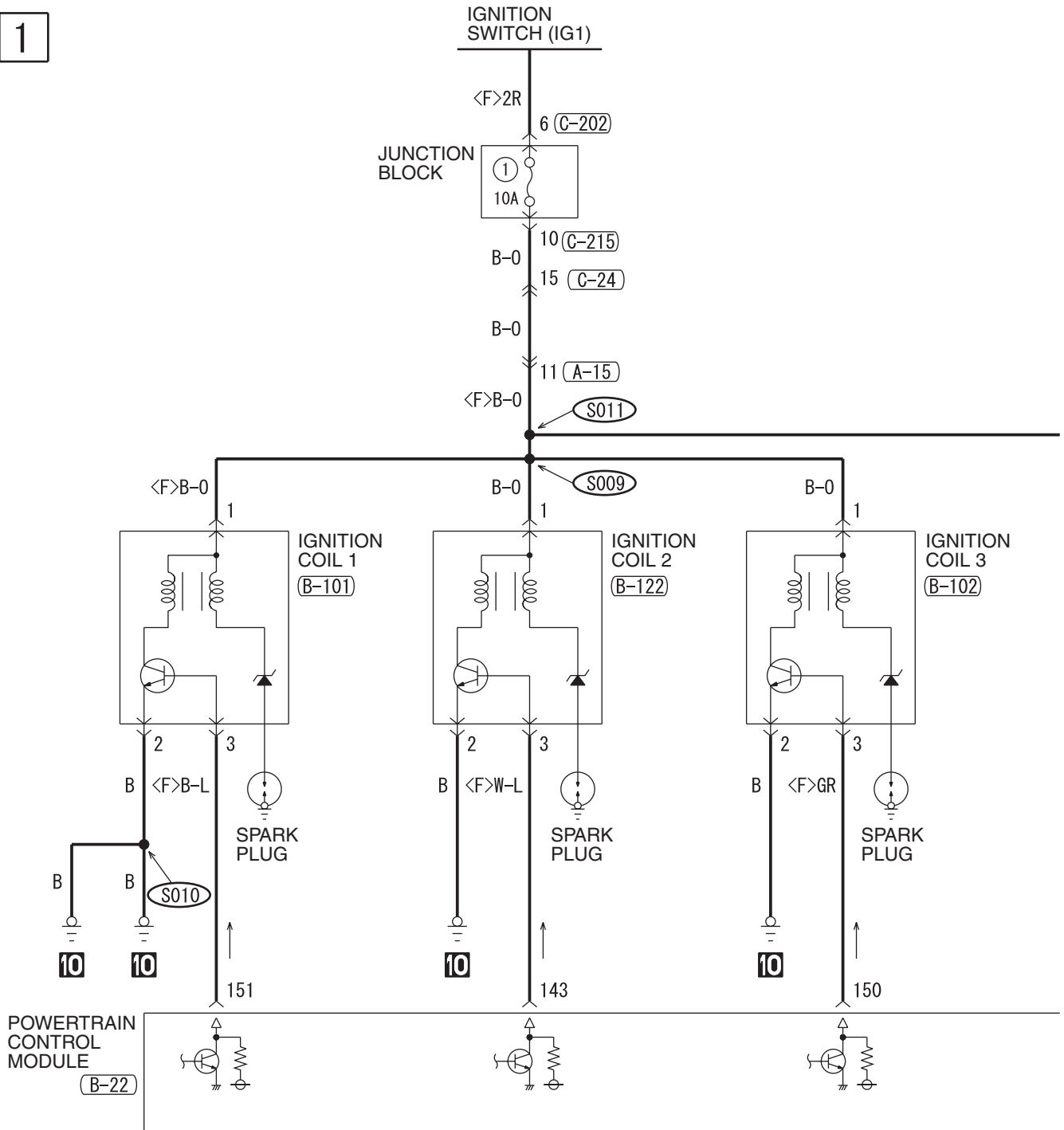

(A-15)

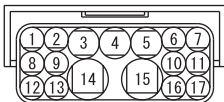

(B-22)



(B-101)



(B-102)



(B-115)



(B-121)



(B-122)



(C-24)

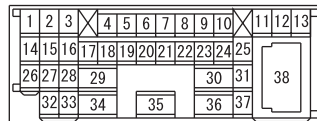

H6P03M01AA

2

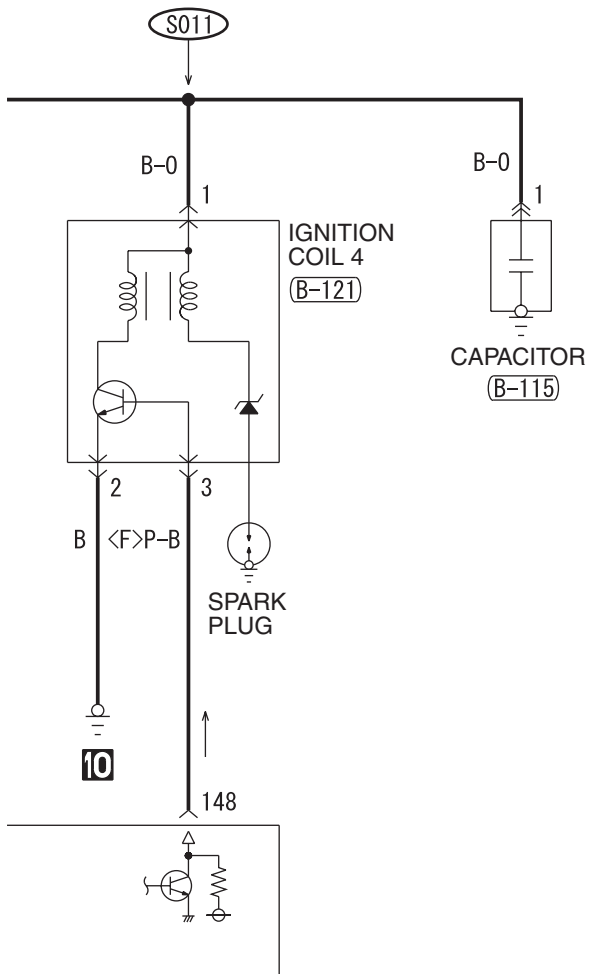

POWERTRAIN CONTROL MODULE INPUT SIGNAL	
·ACCELERATOR PEDAL POSITION SENSOR	·IGNITION SWITCH (ST)
·CAMSHAFT POSITION SENSOR	·INTAKE AIR TEMPERATURE SENSOR
·CRANKSHAFT POSITION SENSOR	·KNOCK SENSOR
·ENGINE COOLANT TEMPERATURE SENSOR	·MANIFOLD ABSOLUTE PRESSURE SENSOR
·FUEL TANK DIFFERENTIAL PRESSURE SENSOR	·MASS AIRFLOW SENSOR
·HEATED OXYGEN SENSOR	·OUTPUT SHAFT SPEED SENSOR
	·THROTTLE POSITION SENSOR
	·TRANSMISSION RANGE SWITCH

(C-202)

(C-215)

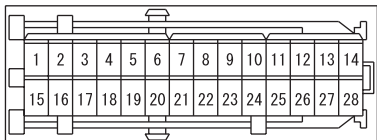

WIRE COLOR CODE
 B : BLACK LG : LIGHT GREEN G : GREEN L : BLUE
 BR : BROWN O : ORANGE GR : GRAY R : RED W : WHITE
 SB : SKY BLUE P : PINK Y : YELLOW V : VIOLET PU : PURPLE

H6P03M01AB

IGNITION SYSTEM <3.8L ENGINE-M/T>

M1901000602675

1

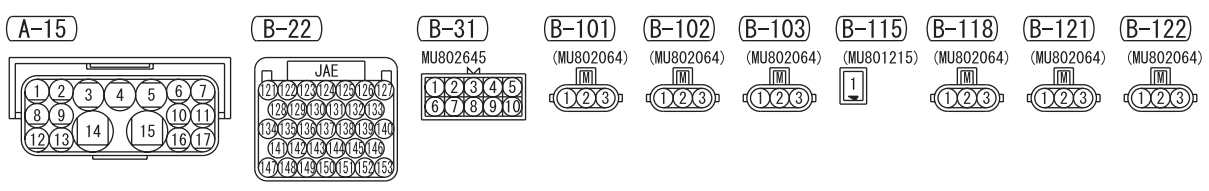
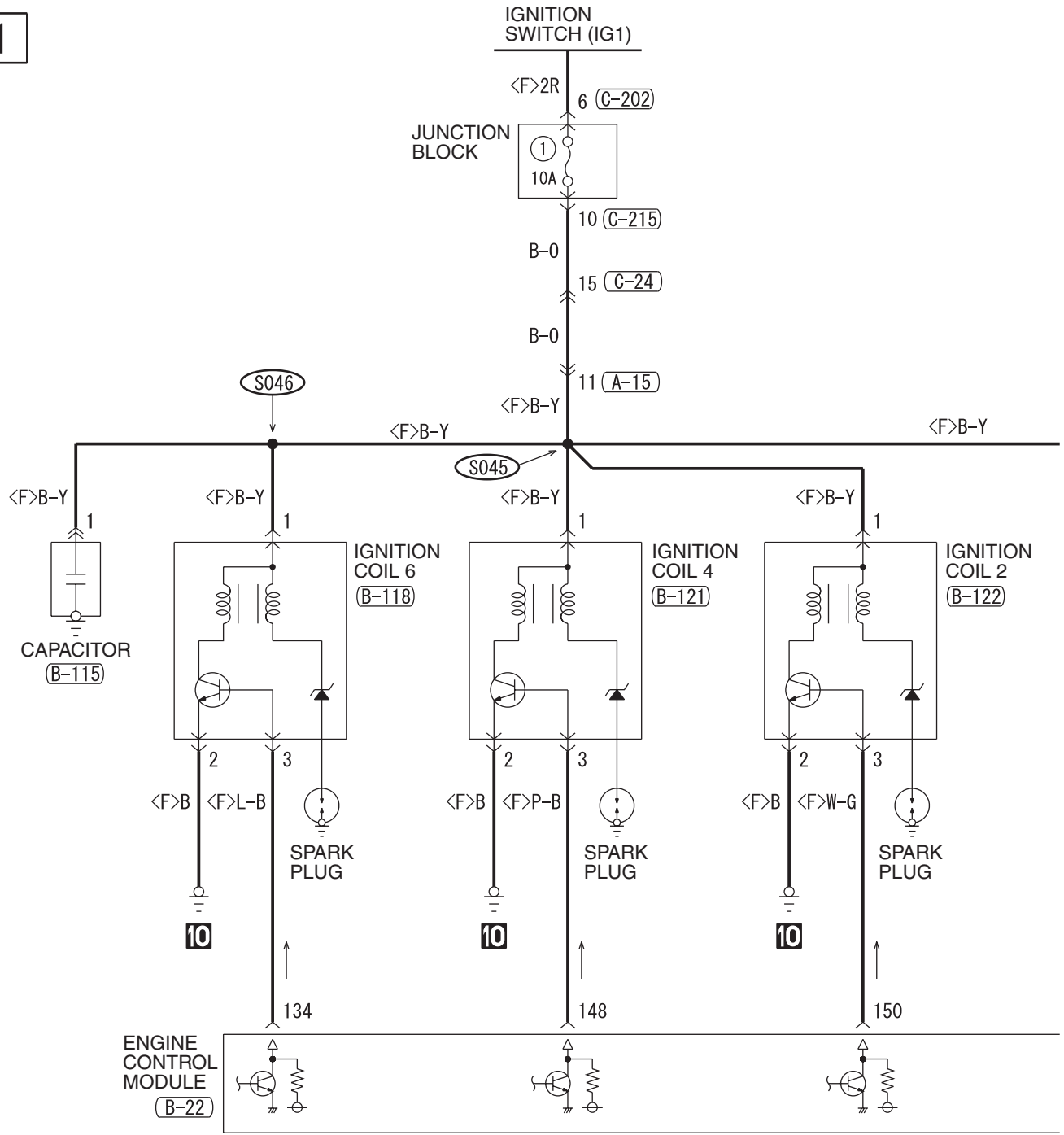

H6P03M02AA

TSB Revision

2

POWERTRAIN CONTROL MODULE INPUT SIGNAL	
·ACCELERATOR PEDAL POSITION SENSOR	·HEATED OXYGEN SENSOR
·CAMSHAFT POSITION SENSOR	·IGNITION SWITCH (ST)
·CRANKSHAFT POSITION SENSOR	·INTAKE AIR TEMPERATURE SENSOR
·ENGINE COOLANT TEMPERATURE SENSOR	·KNOCK SENSOR
·FUEL TANK DIFFERENTIAL PRESSURE SENSOR	·MANIFOLD ABSOLUTE PRESSURE SENSOR
	·MASS AIRFLOW SENSOR
	·THROTTLE POSITION SENSOR
	·VEHICLE SPEED SENSOR

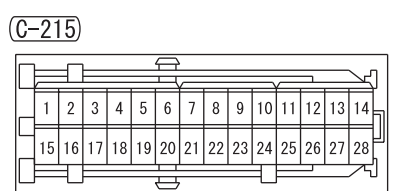
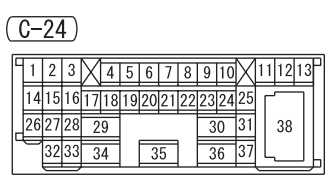
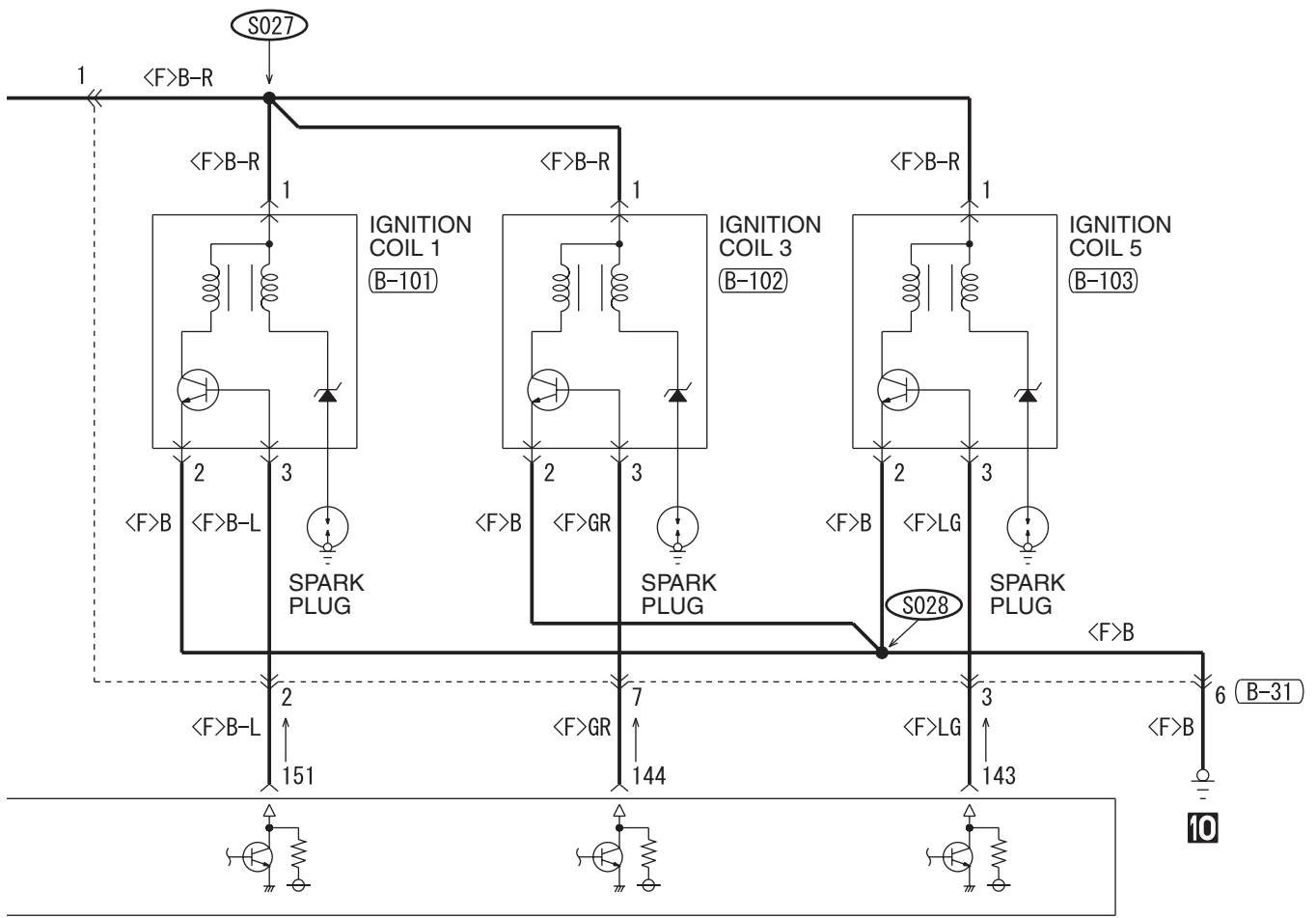

WIRE COLOR CODE
 B : BLACK SB : SKY BLUE
 BR : BROWN LG : LIGHT GREEN
 G : GREEN P : PINK GR : GRAY
 R : RED L : BLUE Y : YELLOW
 V : VIOLET W : WHITE O : ORANGE
 PU : PURPLE

H6P03M02AB

IGNITION SYSTEM <3.8L ENGINE-A/T>

M1901000602686

1

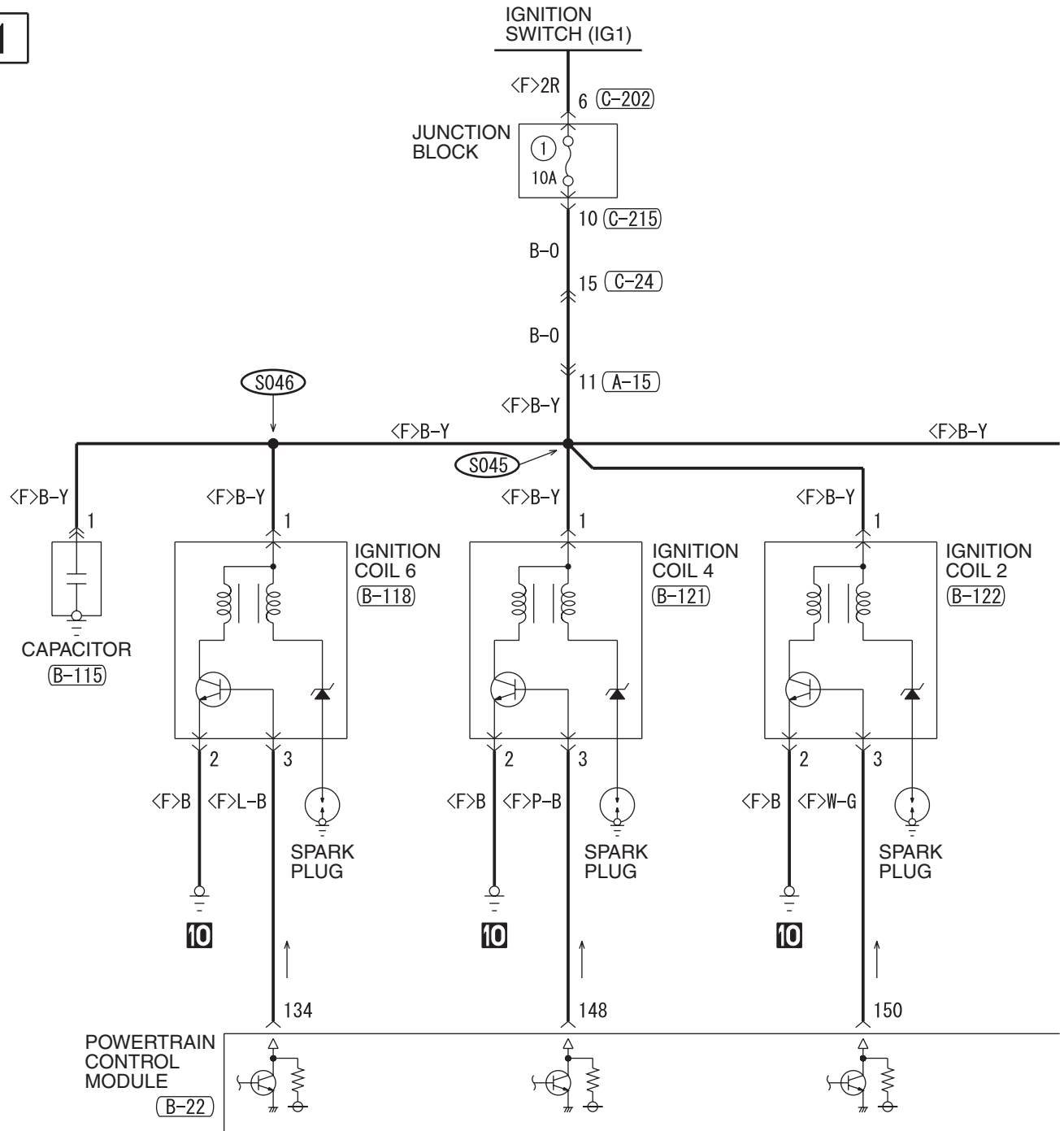

(A-15)

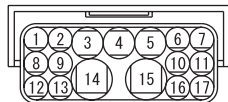

(B-22)



(B-31)



(B-101)



(B-102)



(B-103)



(B-115)



(B-118)



(B-121)



(B-122)



2

POWERTRAIN CONTROL MODULE INPUT SIGNAL	
·ACCELERATOR PEDAL POSITION SENSOR	·IGNITION SWITCH (ST)
·CAMSHAFT POSITION SENSOR	·INTAKE AIR TEMPERATURE SENSOR
·CRANKSHAFT POSITION SENSOR	·KNOCK SENSOR
·ENGINE COOLANT TEMPERATURE SENSOR	·MANIFOLD ABSOLUTE PRESSURE SENSOR
·FUEL TANK DIFFERENTIAL PRESSURE SENSOR	·MASS AIRFLOW SENSOR
·HEATED OXYGEN SENSOR	·OUTPUT SHAFT SPEED SENSOR
	·THROTTLE POSITION SENSOR
	·TRANSMISSION RANGE SWITCH

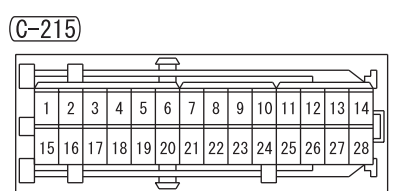
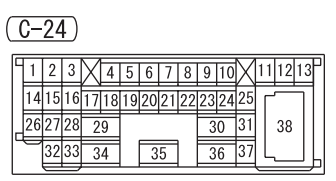
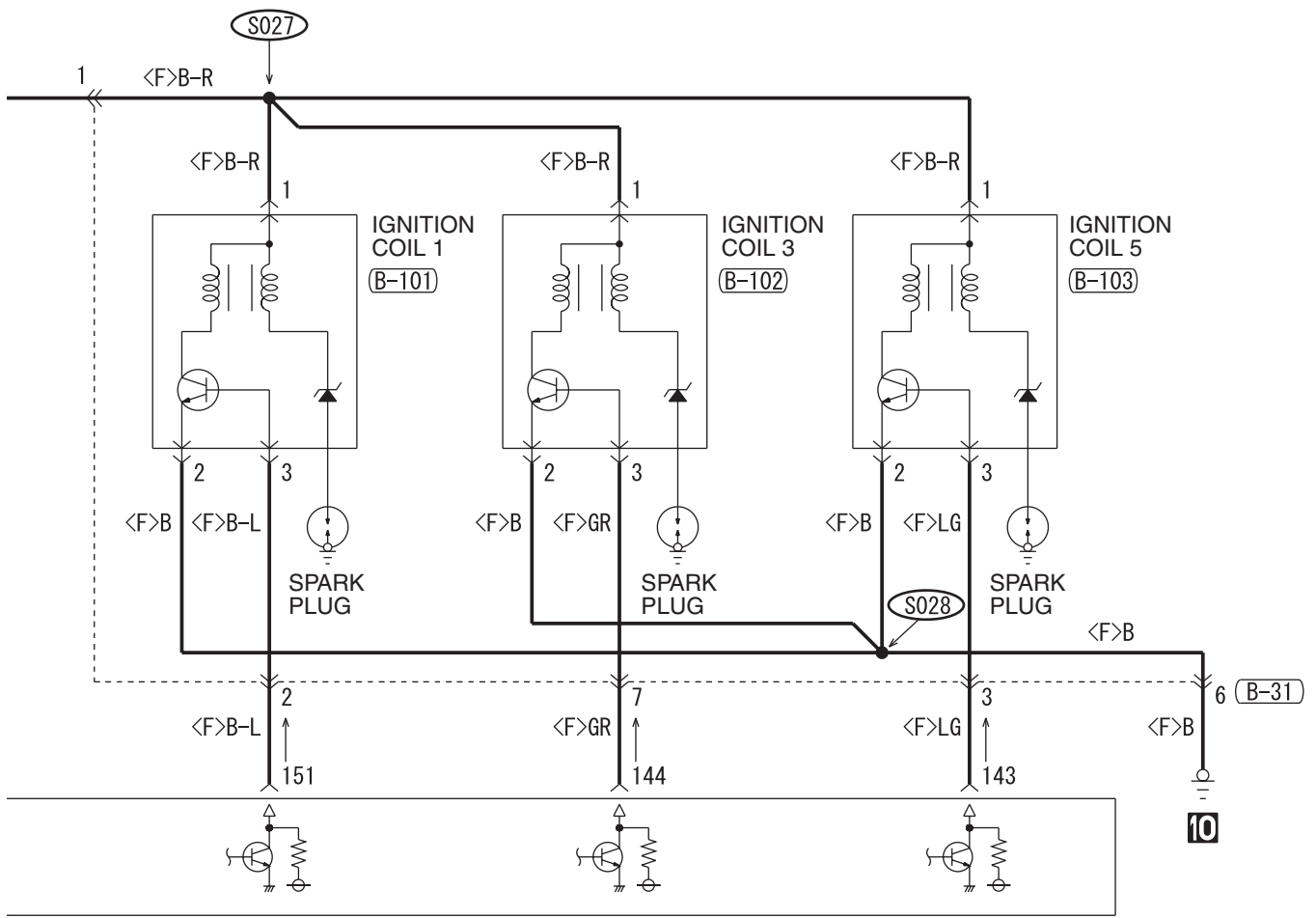

WIRE COLOR CODE
 B : BLACK SB : SKY BLUE
 BR : BROWN LG : LIGHT GREEN
 G : GREEN P : PINK GR : GRAY
 R : RED L : BLUE Y : YELLOW
 V : VIOLET W : WHITE O : ORANGE
 PU : PURPLE

H6P03M03AB

CHARGING SYSTEM <2.4L ENGINE>

M1901000701873

1

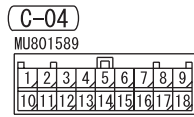
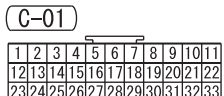
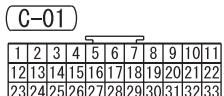
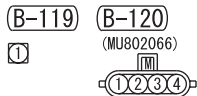
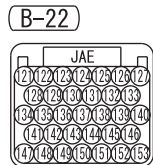
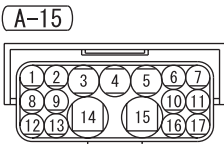
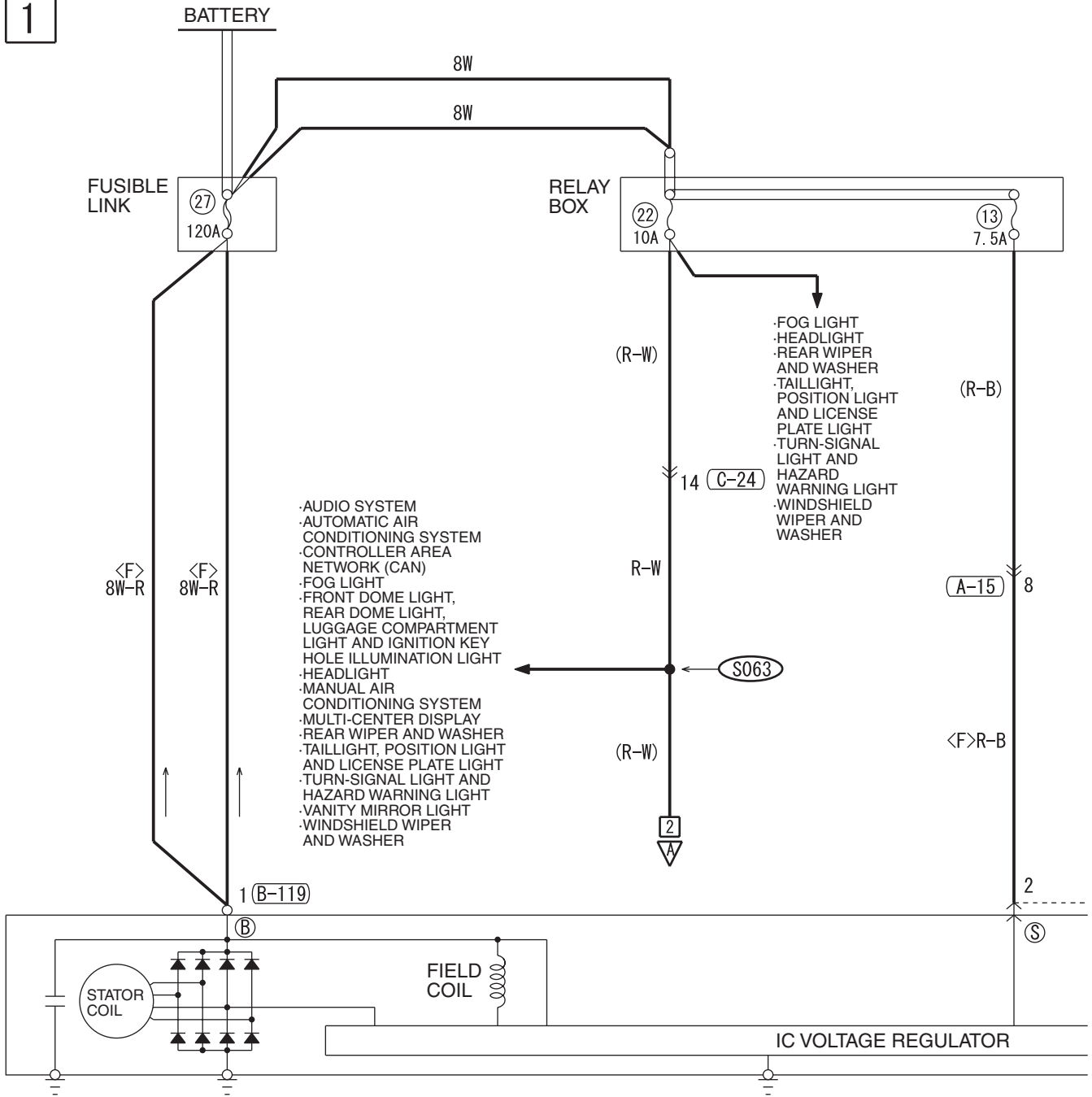

2

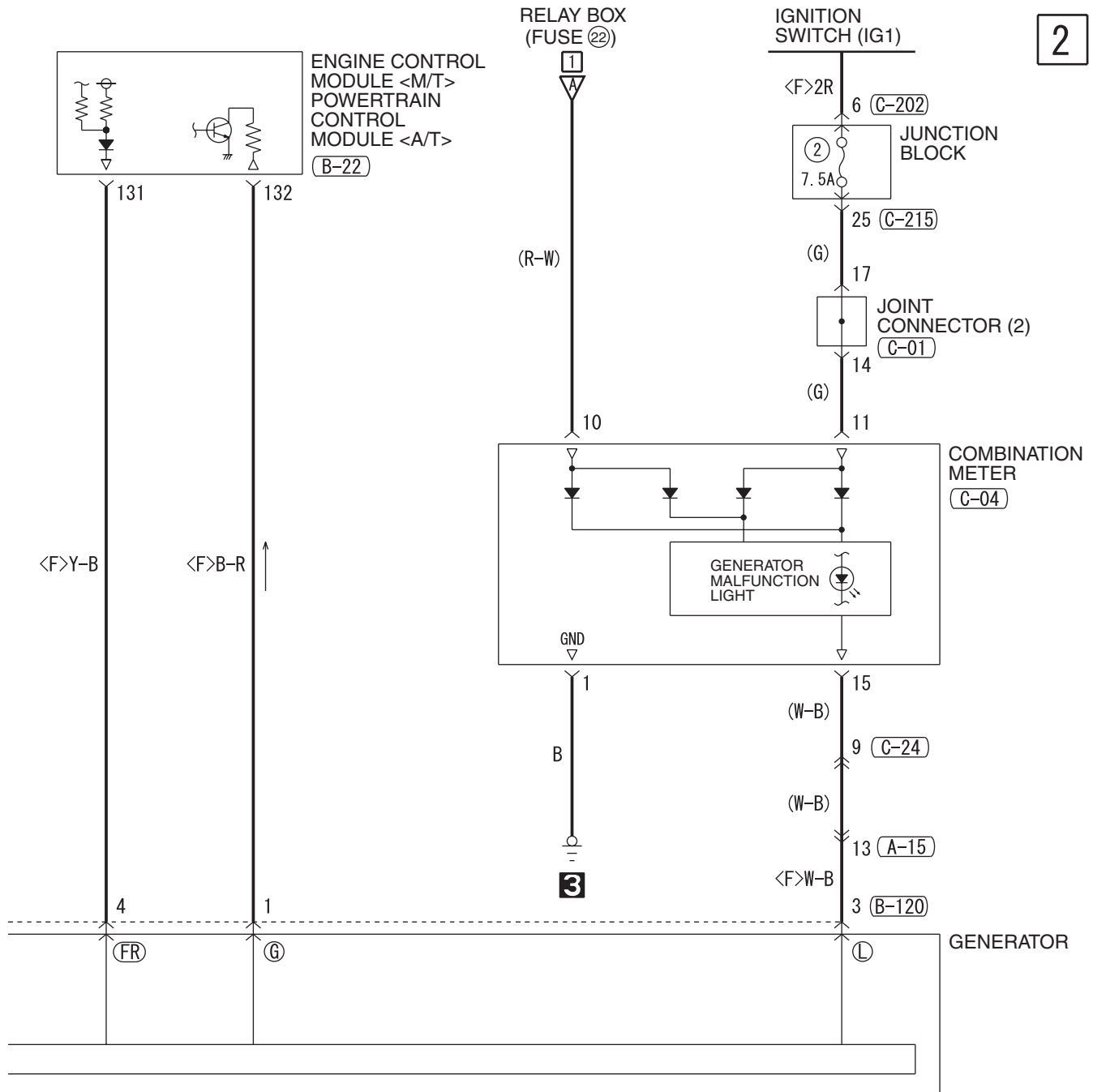

(C-24)

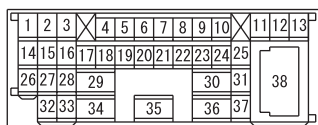

(C-202)



(C-215)

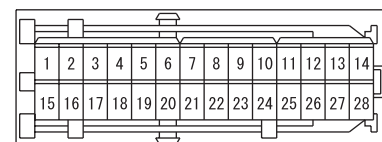

WIRE COLOR CODE

- B : BLACK SB : SKY BLUE
- BR : BROWN LG : LIGHT GREEN
- G : GREEN P : PINK GR : GRAY
- R : RED L : BLUE Y : YELLOW
- V : VIOLET W : WHITE O : ORANGE
- PU : PURPLE

H6P04M00AB

CHARGING SYSTEM <3.8L ENGINE>

M1901000701884

1

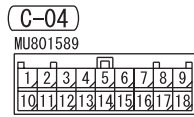
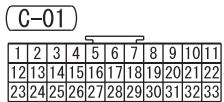
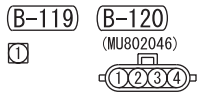
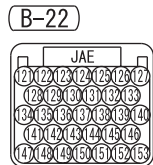
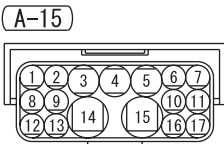
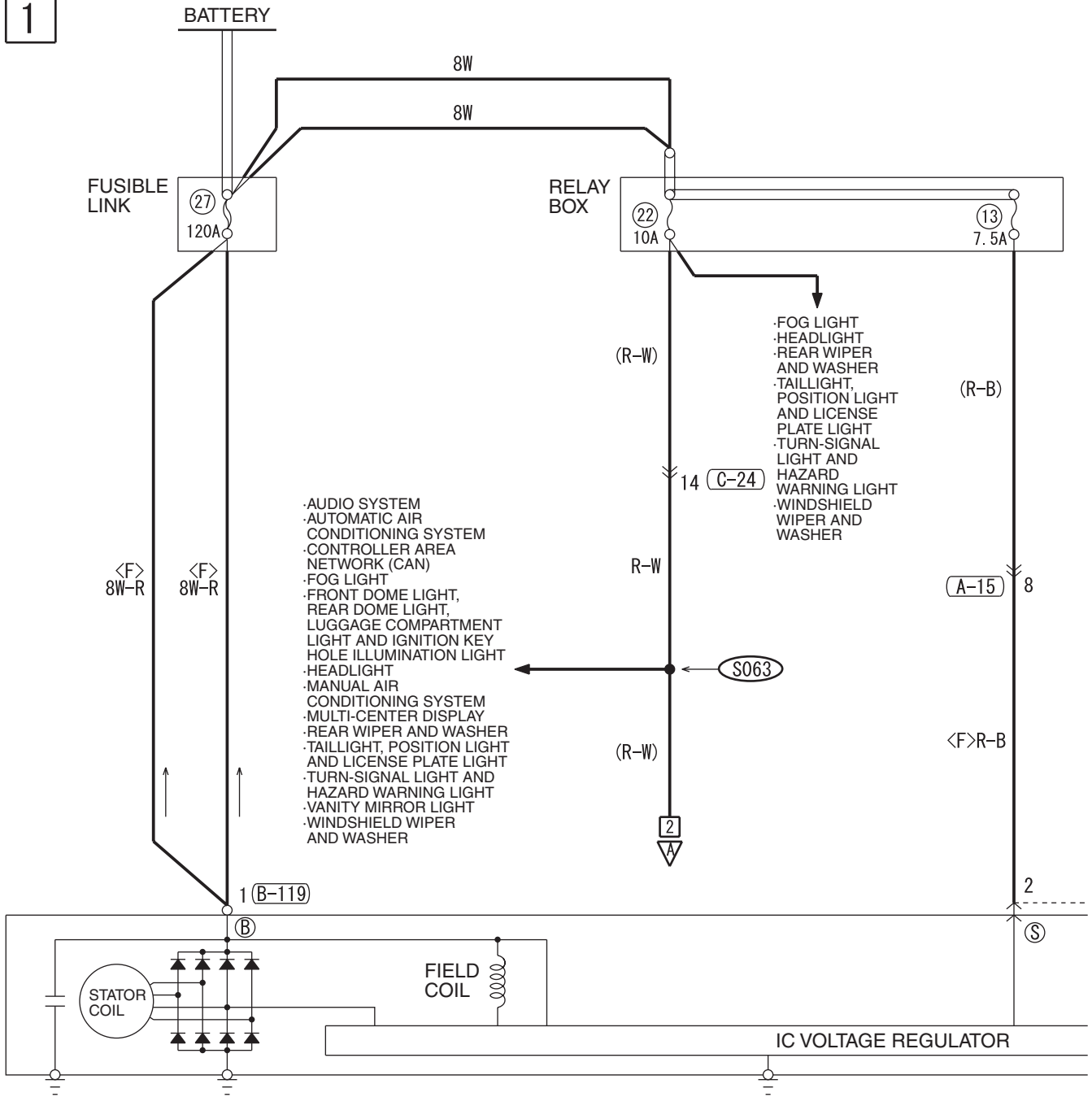

H6P04M01AA

2

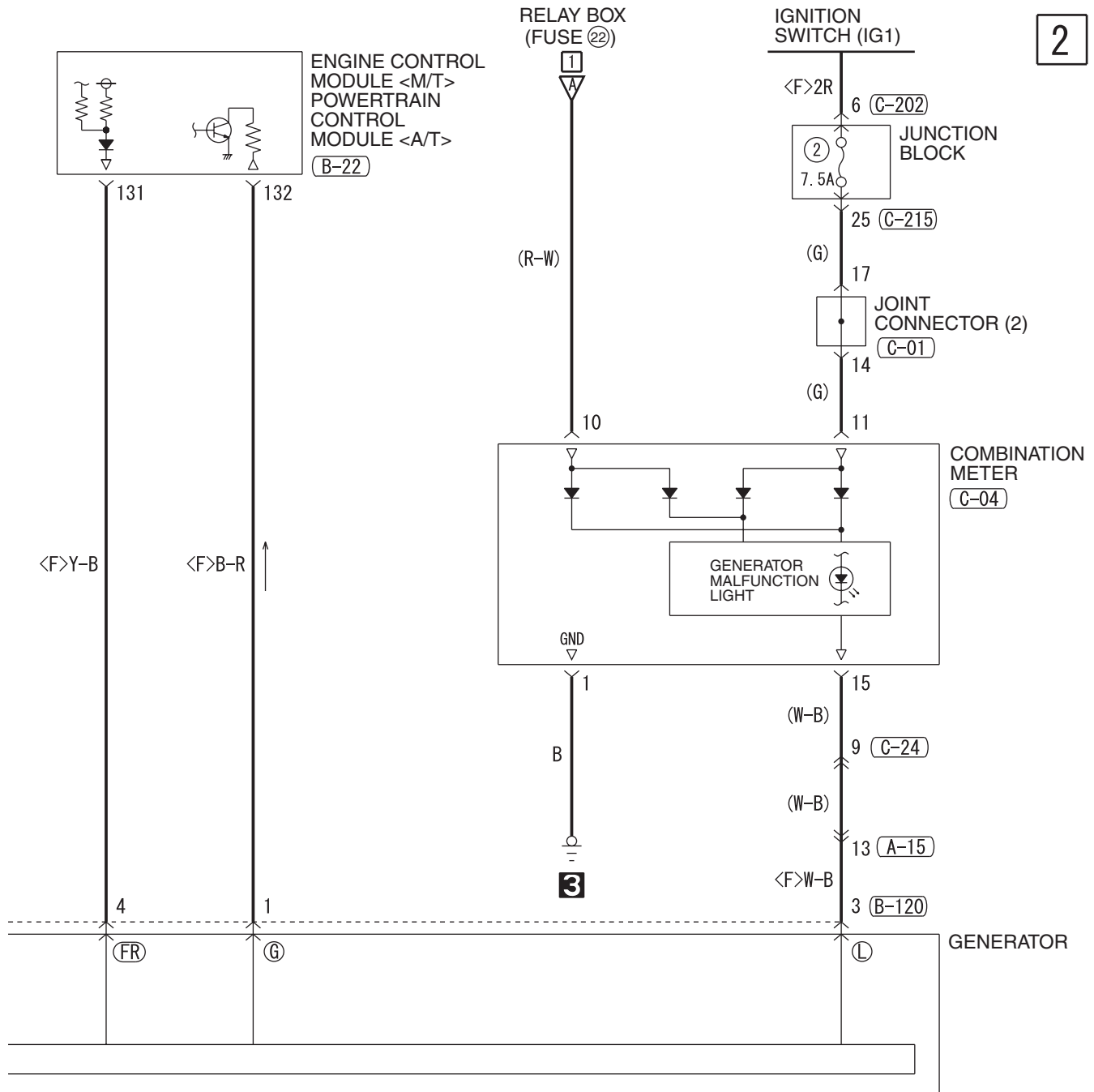

(C-24)

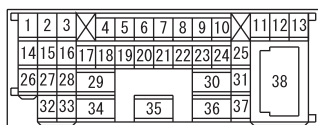

(C-202)



(C-215)

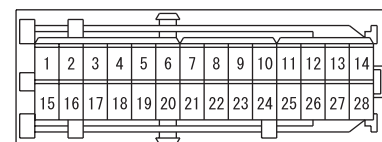

WIRE COLOR CODE
 B : BLACK SB : SKY BLUE
 BR : BROWN LG : LIGHT GREEN
 G : GREEN P : PINK GR : GRAY
 R : RED L : BLUE Y : YELLOW
 V : VIOLET W : WHITE O : ORANGE
 PU : PURPLE

H6P04M01AB

MULTIPOINT FUEL INJECTION (MFI) SYSTEM <2.4L ENGINE-M/T>

M1901000803586

1

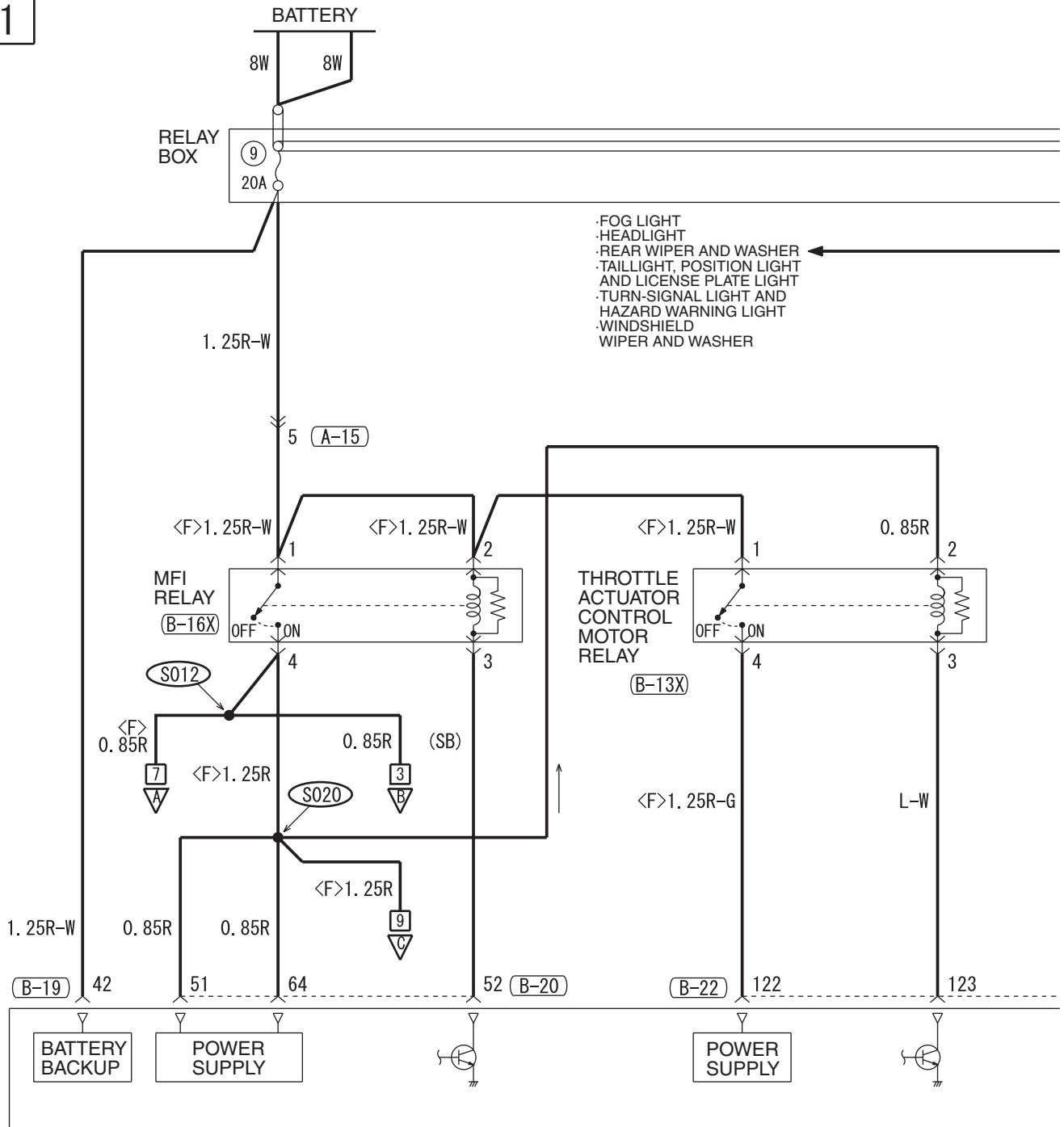

- FOG LIGHT
- HEADLIGHT
- REAR WIPER AND WASHER
- TAILLIGHT, POSITION LIGHT AND LICENSE PLATE LIGHT
- TURN-SIGNAL LIGHT AND HAZARD WARNING LIGHT
- WINDSHIELD WIPER AND WASHER

(A-15)

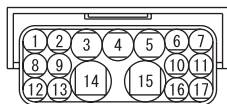

(C-215)

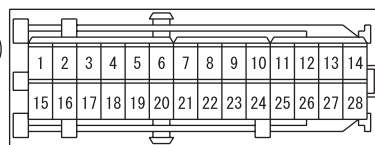

(B-13X)



(D-19)
(MU802058)



(B-16X)



(B-18)



(B-19)



(B-20)

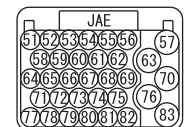

H6P05M00AA

2

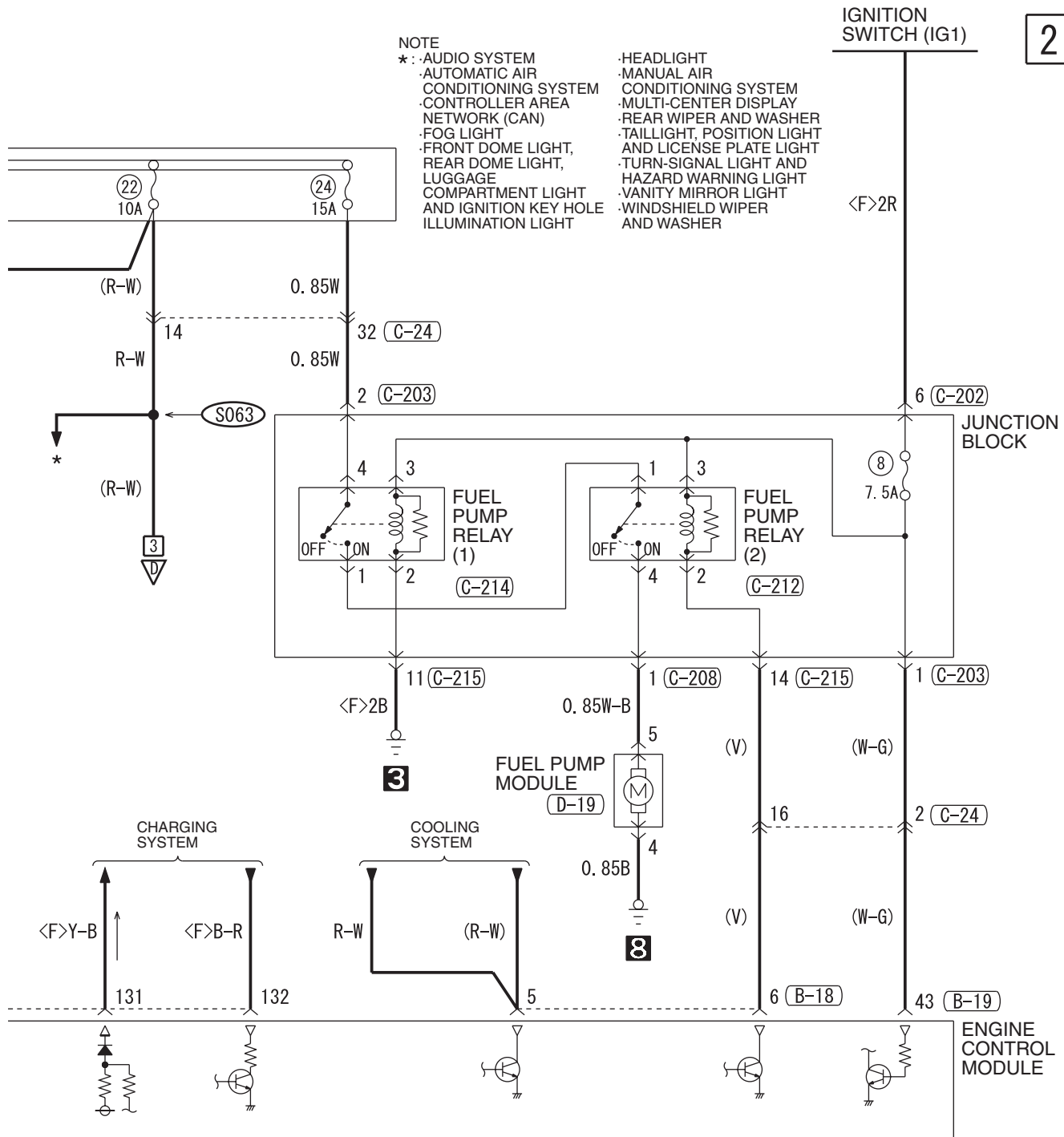

(B-22)



(C-24)

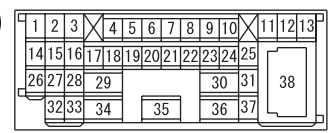

(C-202)

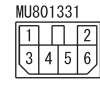

(C-203)

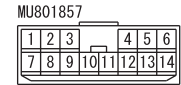

(C-208)

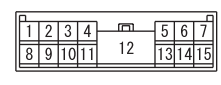

(C-212)



(C-214)



WIRE COLOR CODE
 B : BLACK LG : LIGHT GREEN G : GREEN L : BLUE
 BR : BROWN O : ORANGE GR : GRAY R : RED W : WHITE
 SB : SKY BLUE P : PINK Y : YELLOW V : VIOLET PU : PURPLE

H6P05M00AB

TSB Revision

MULTIPOINT FUEL INJECTION (MFI) SYSTEM <2.4L ENGINE-M/T> (CONTINUED)

3

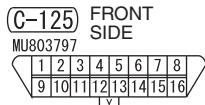
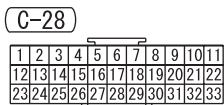
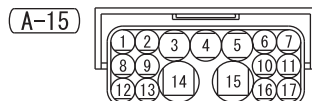
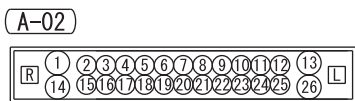
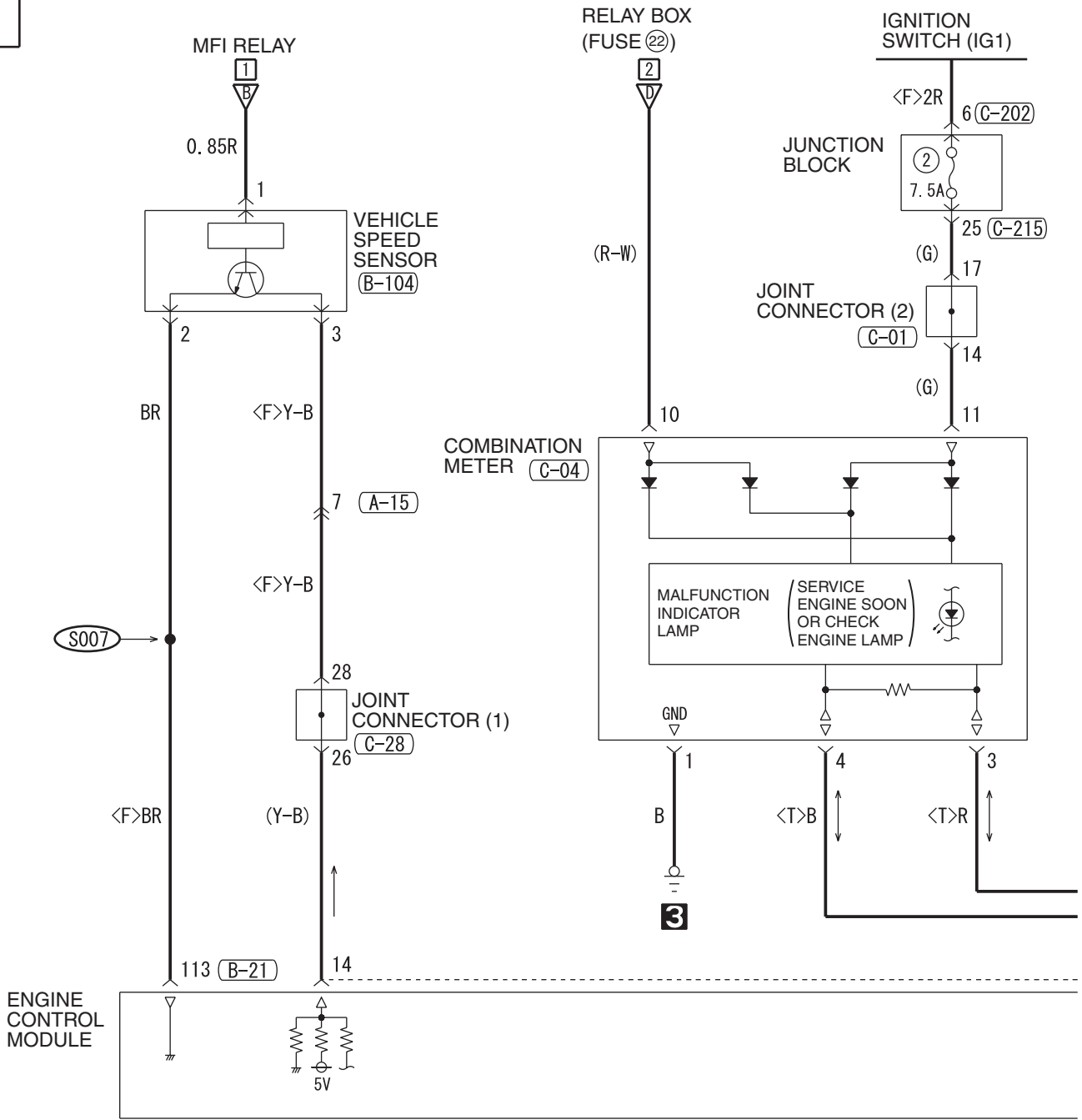

(C-215)

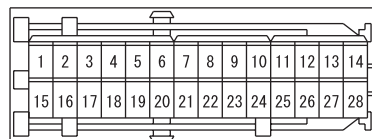

H6P05M00BA

4

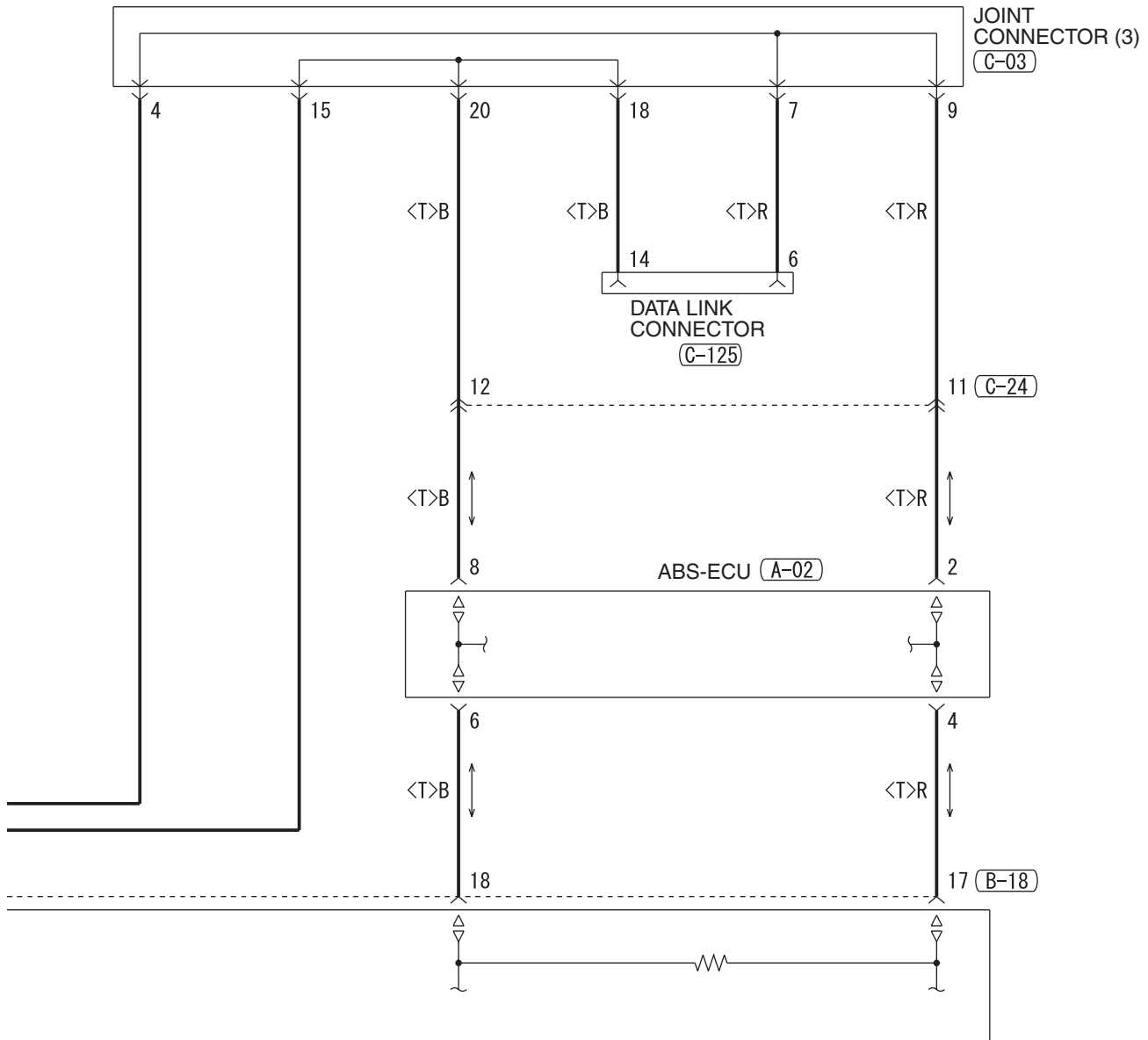

(B-104)

(C-01)

(C-03)

(C-04)

(C-24)

(MU802723)

1	2	3	4	5	6	7	8	9	10	11
12	13	14	15	16	17	18	19	20	21	22
23	24	25	26	27	28	29	30	31	32	33

1	2	3	4	5	6	7	8	9	10	11
12	13	14	15	16	17	18	19	20	21	22
23	24	25	26	27	28	29	30	31	32	33

MU801515

1	2	3	4	5	6	7	8	9	10	11
12	13	14	15	16	17	18	19	20	21	22

MU801589

1	2	3	4	5	6	7	8	9
10	11	12	13	14	15	16	17	18

1	2	3	4	5	6	7	8	9	10	11	12	13
14	15	16	17	18	19	20	21	22	23	24	25	
26	27	28	29					30	31		38	
32	33	34	35					36	37			

WIRE COLOR CODE

B : BLACK LG : LIGHT GREEN G : GREEN L : BLUE W : WHITE Y : YELLOW SB : SKY BLUE
 BR : BROWN O : ORANGE GR : GRAY R : RED P : PINK V : VIOLET PU : PURPLE

H6P05M00BB

MULTIPOINT FUEL INJECTION (MFI) SYSTEM <2.4L ENGINE-M/T> (CONTINUED)

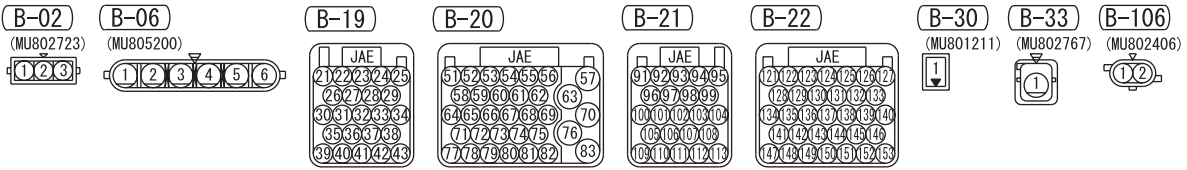
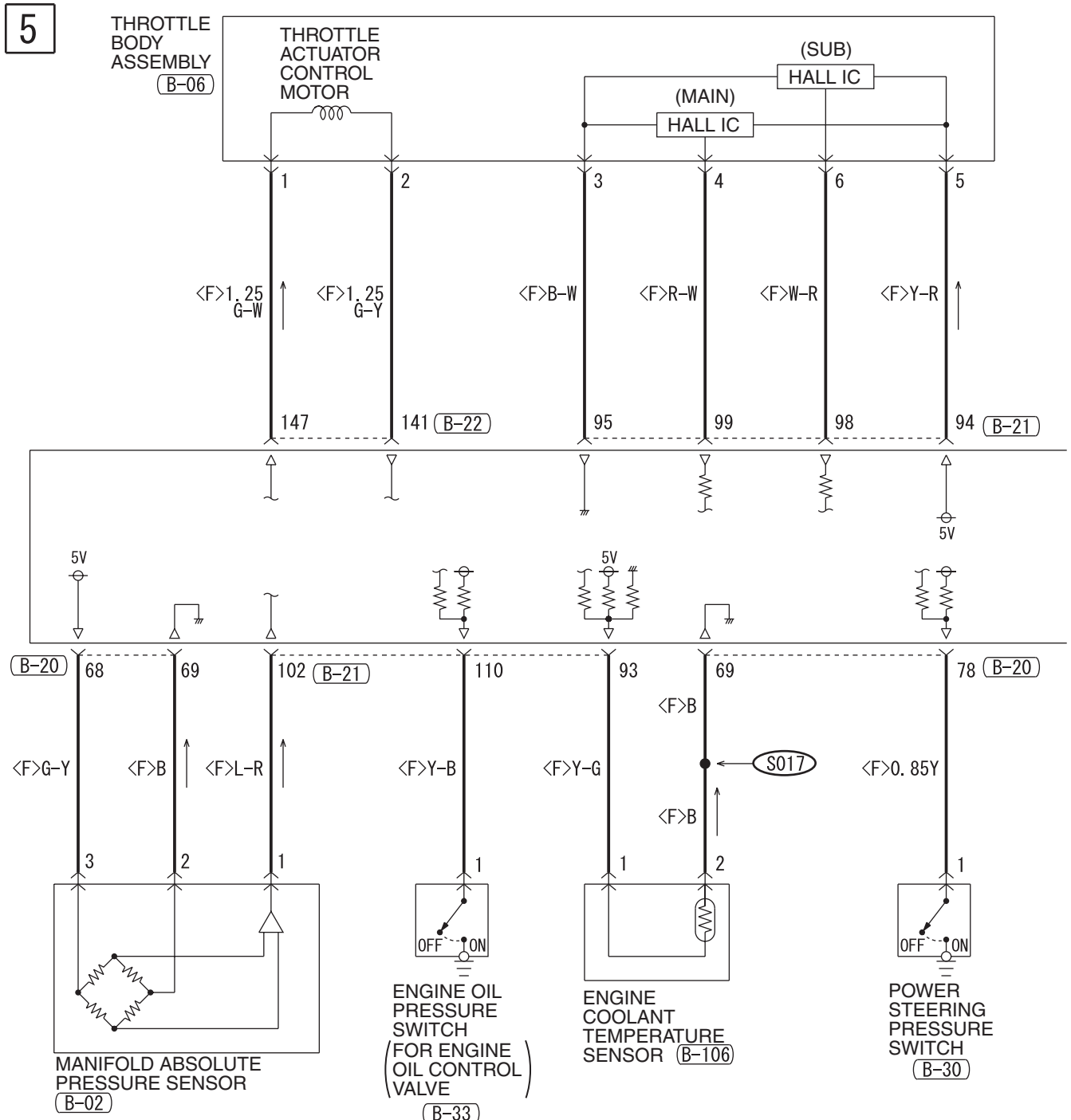

6

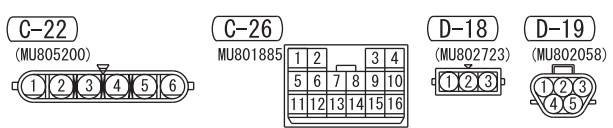
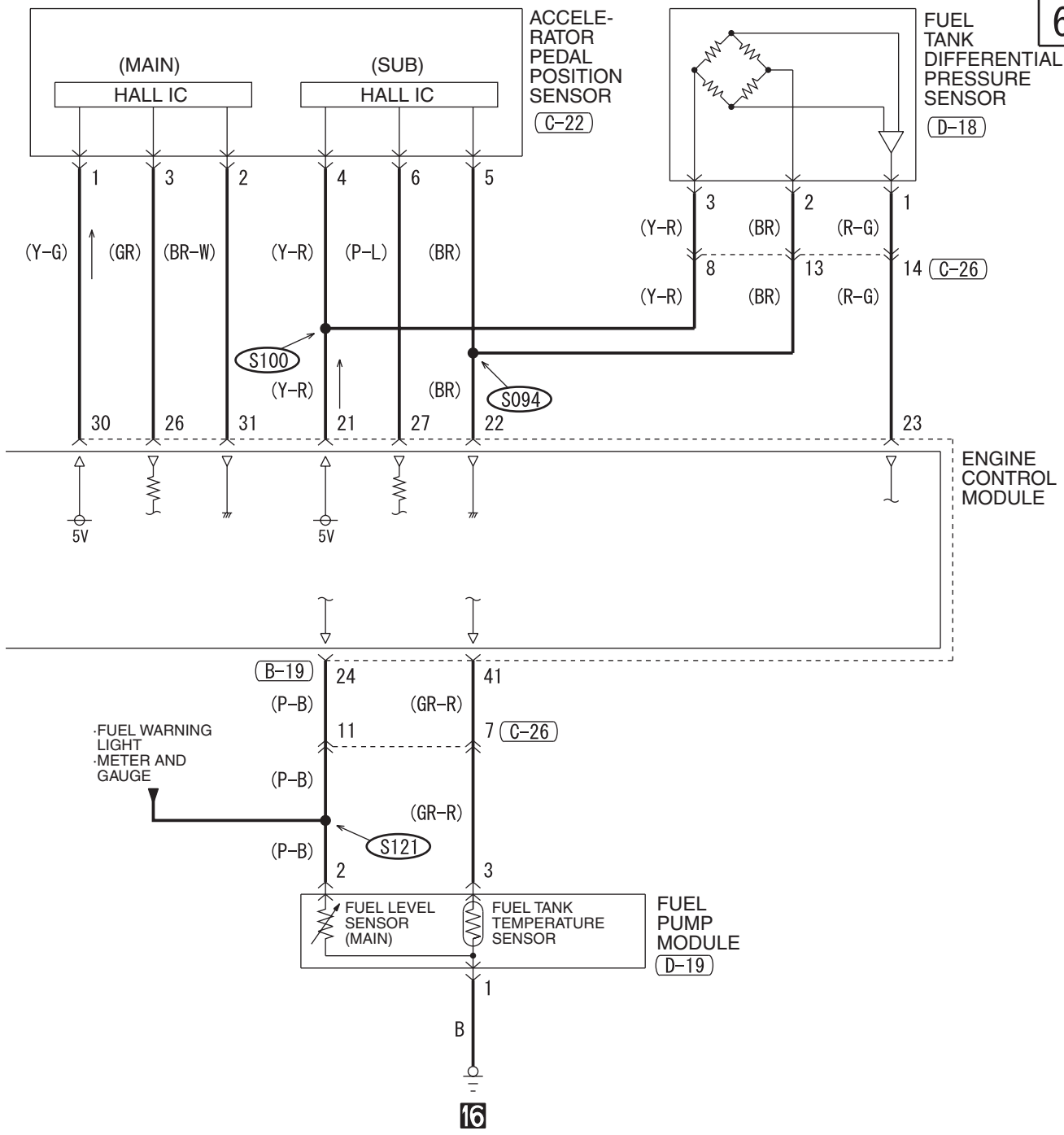

WIRE COLOR CODE
 B : BLACK LG : LIGHT GREEN G : GREEN L : BLUE W : WHITE Y : YELLOW SB : SKY BLUE
 BR : BROWN O : ORANGE GR : GRAY R : RED P : PINK V : VIOLET PU : PURPLE

H6P05M00CB

TSB Revision

MULTIPOINT FUEL INJECTION (MFI) SYSTEM <2.4L ENGINE-M/T> (CONTINUED)

7

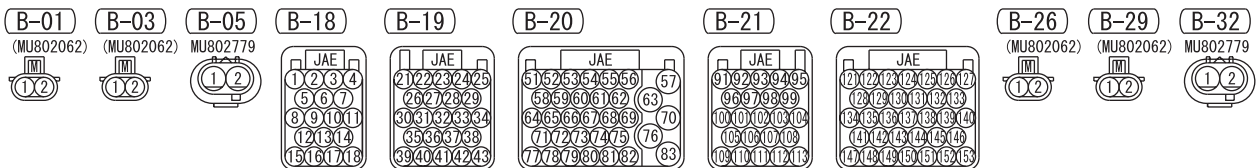
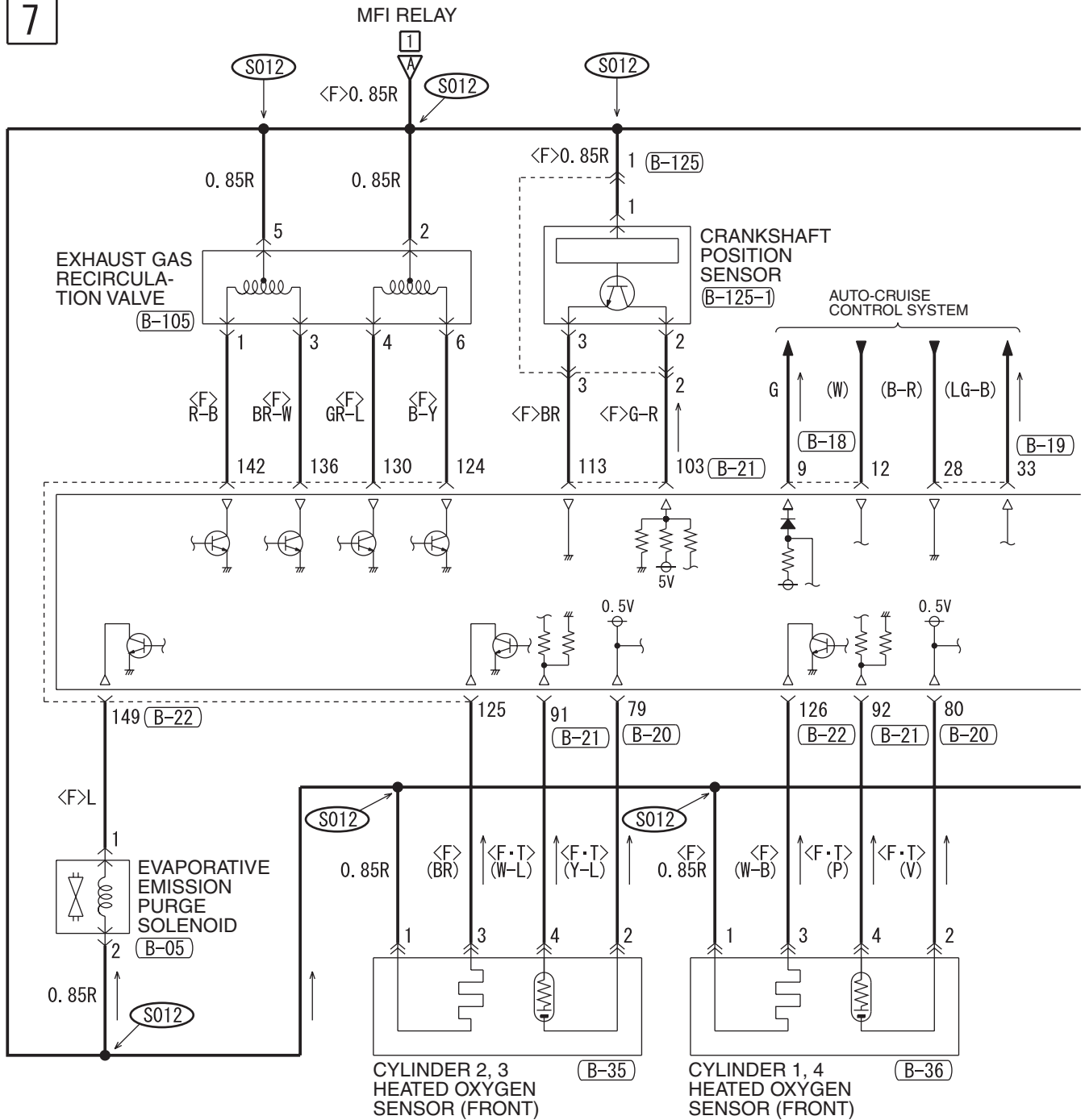

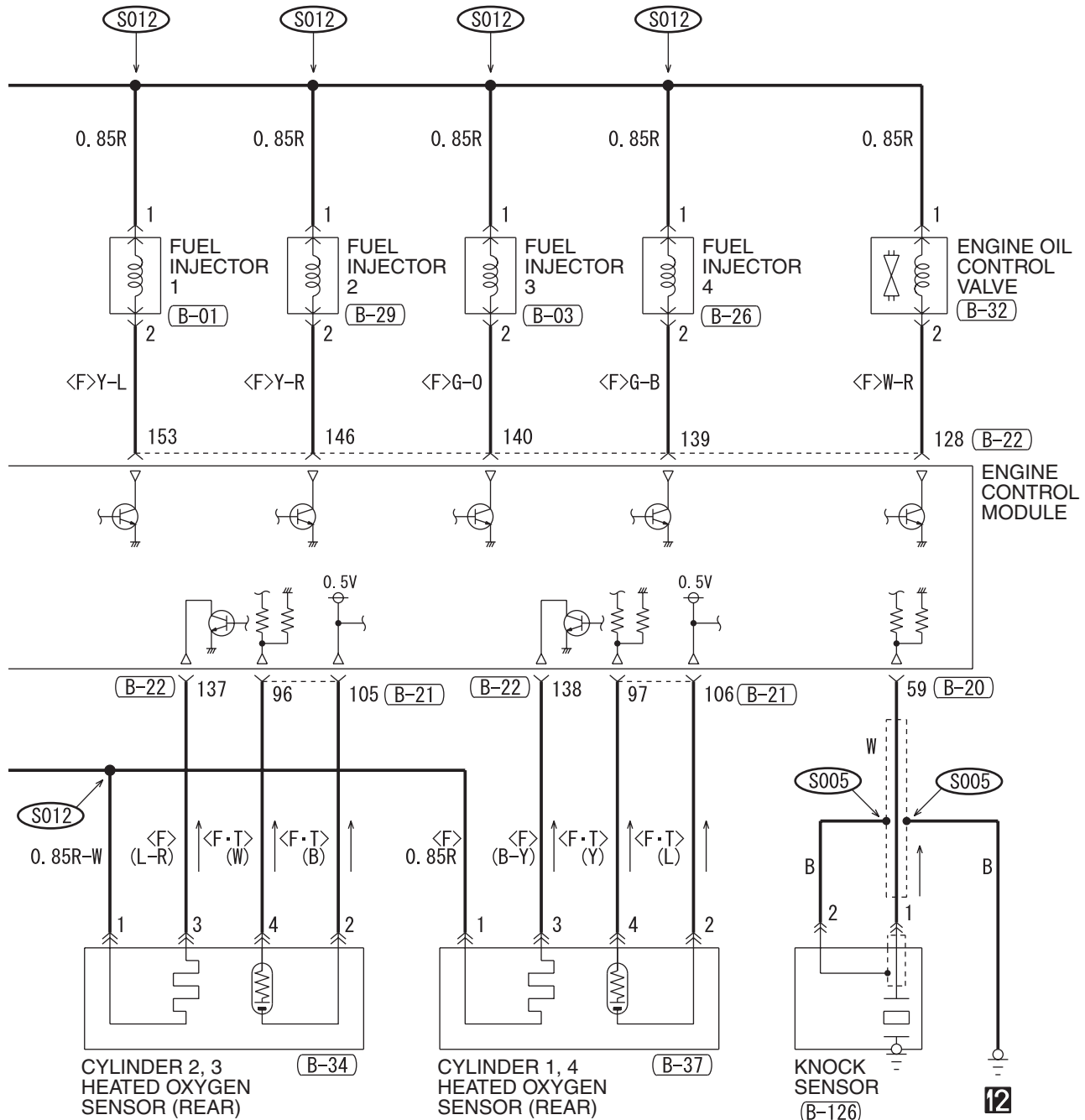

- | | | | | | | | |
|---------------------------|---------------------------|---------------------------|---------------------------|------------------------------|------------------------------|-----------------------------|----------------------------|
| (B-34)
MU802605 | (B-35)
MU802665 | (B-36)
MU802665 | (B-37)
MU802605 | (B-105)
(MU802056) | (B-125)
(MU802064) | (B-125-1)
(1X2X3) | (B-126)
MU802661 |
| | | | | | | | |

WIRE COLOR CODE
 B: BLACK LG: LIGHT GREEN G: GREEN L: BLUE W: WHITE Y: YELLOW SB: SKY BLUE
 BR: BROWN O: ORANGE GR: GRAY R: RED P: PINK V: VIOLET PU: PURPLE

MULTIPOINT FUEL INJECTION (MFI) SYSTEM <2.4L ENGINE-M/T> (CONTINUED)

9

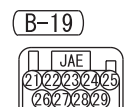
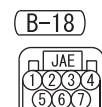
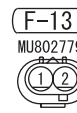
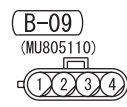
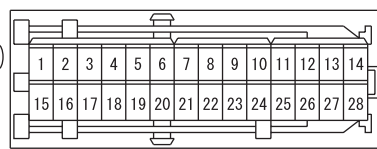
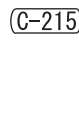
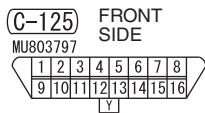
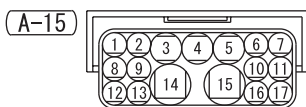
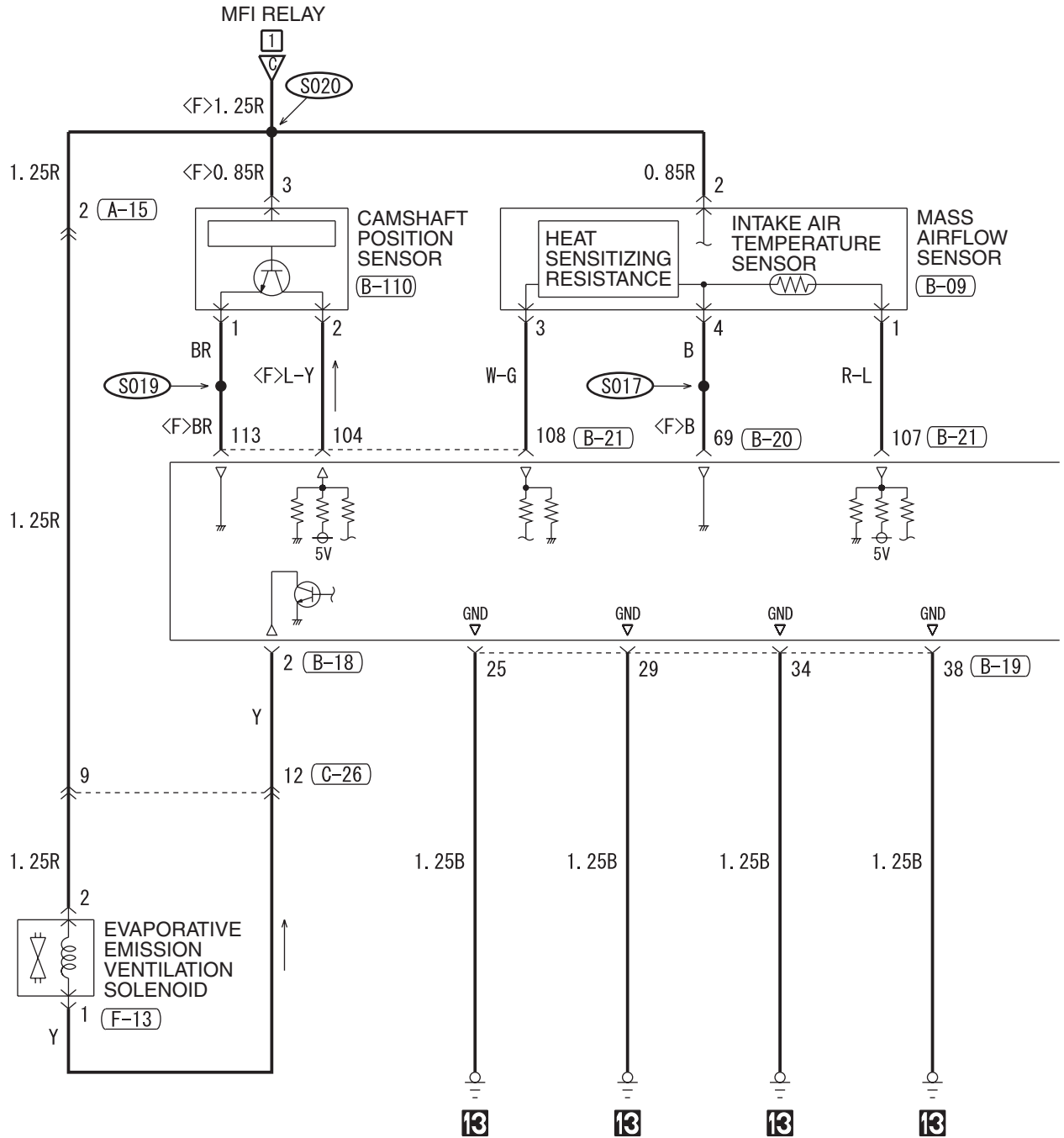

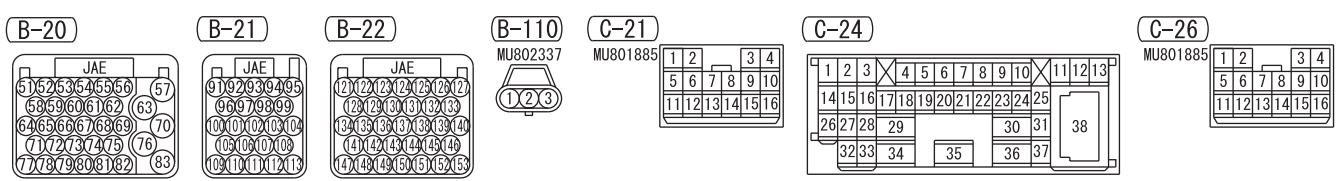
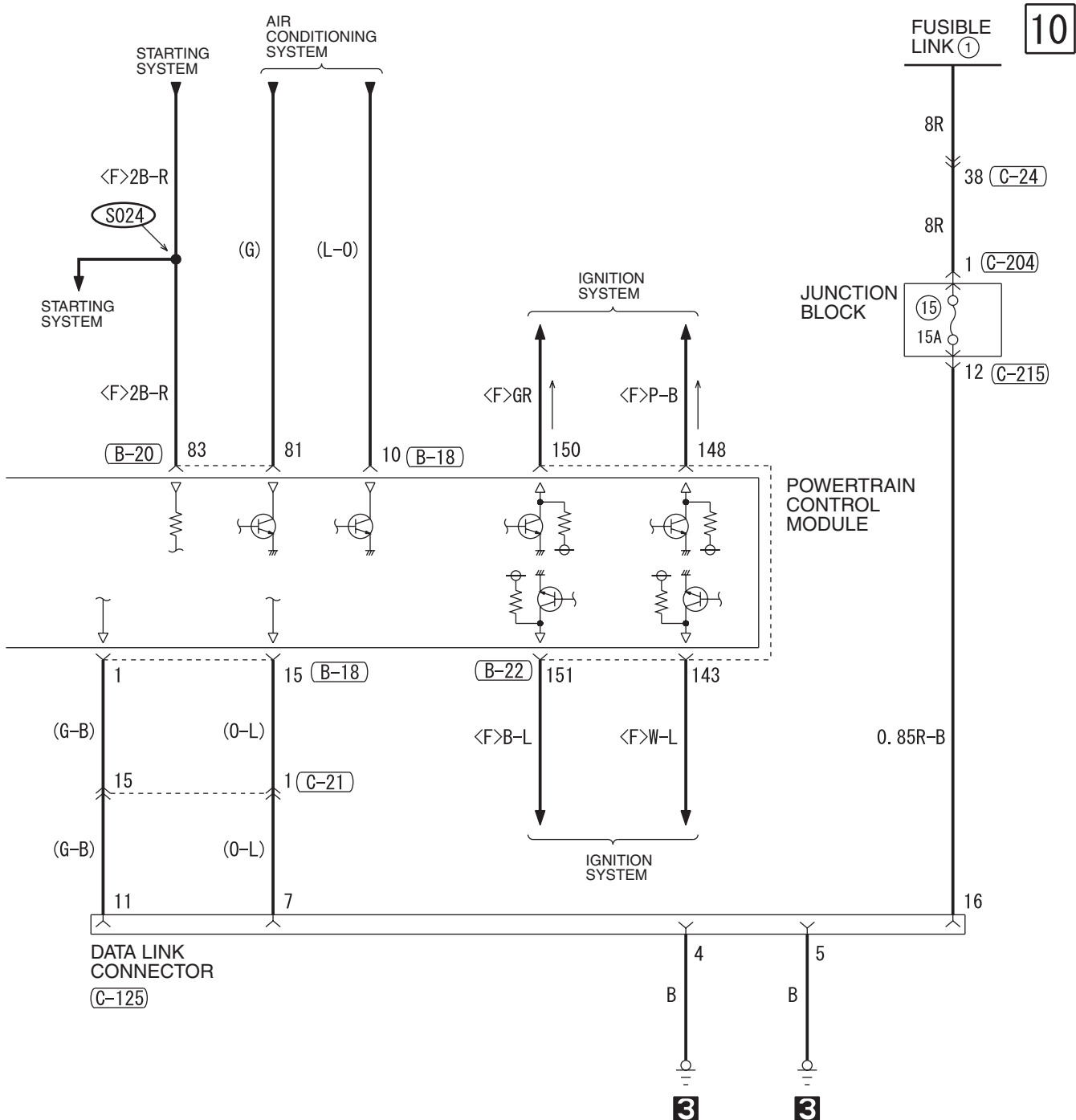

MULTIPOINT FUEL INJECTION (MFI) SYSTEM <2.4L ENGINE-A/T>

M1901000803597

1

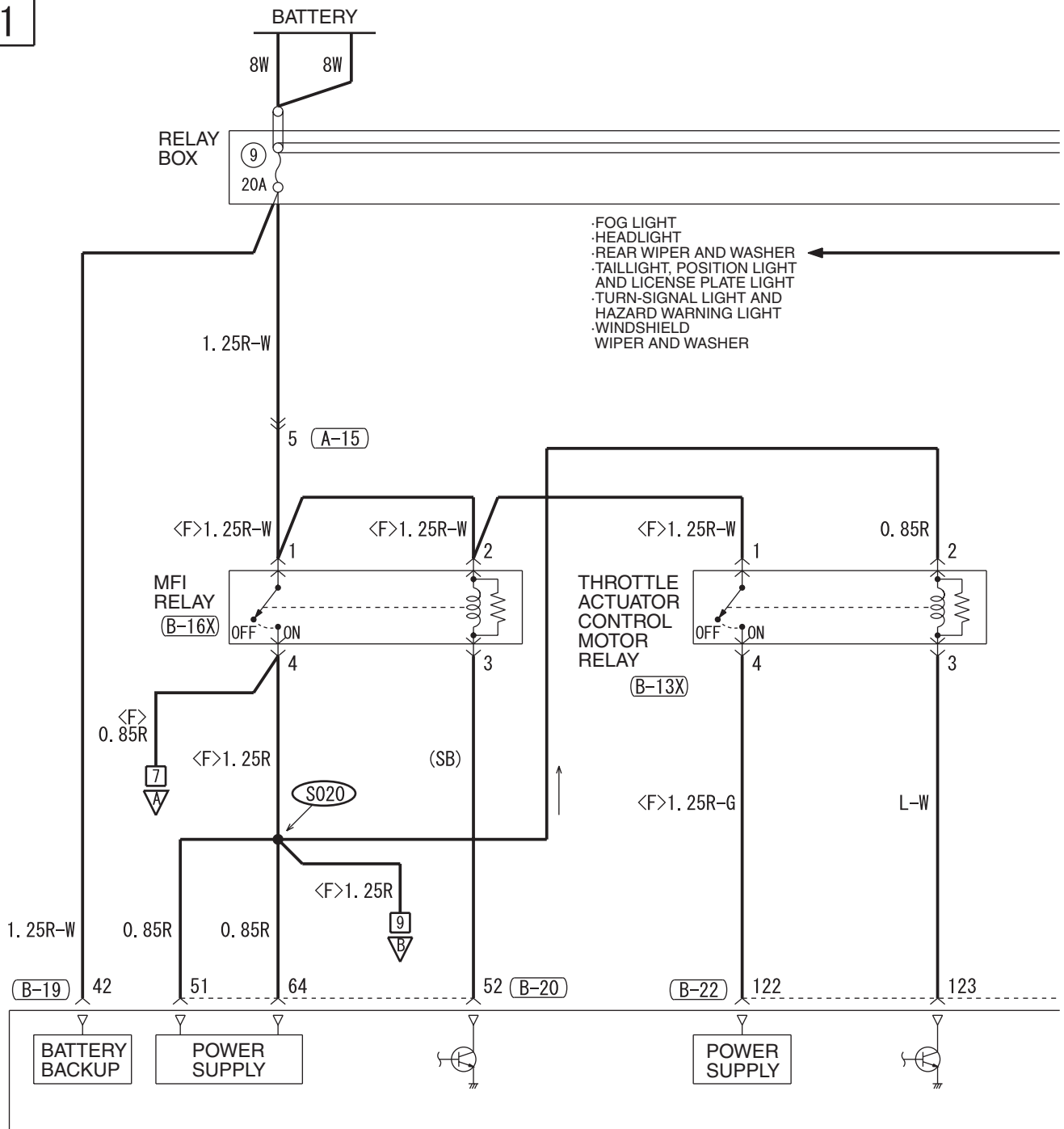

- FOG LIGHT
- HEADLIGHT
- REAR WIPER AND WASHER
- TAILLIGHT, POSITION LIGHT AND LICENSE PLATE LIGHT
- TURN-SIGNAL LIGHT AND HAZARD WARNING LIGHT
- WINDSHIELD WIPER AND WASHER

(A-15)

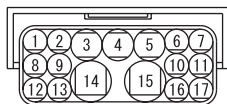

(C-215)

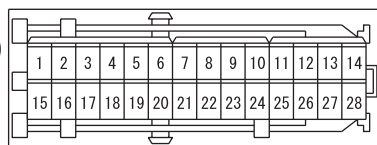

(B-13X)



(D-19)
(MU802058)



(B-16X)



(B-18)



(B-19)



(B-20)



H6P05M01AA

TSB Revision

2

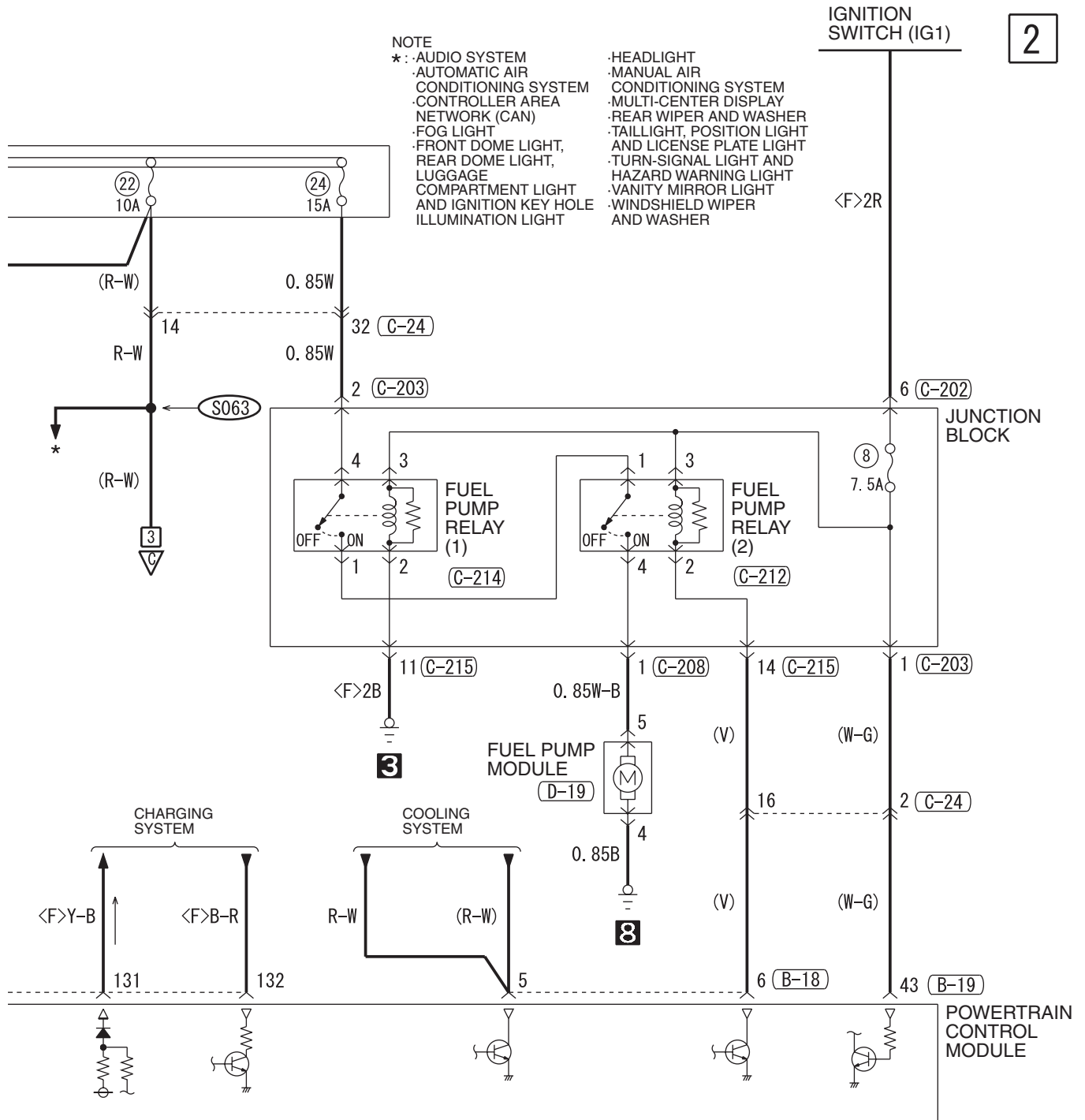

(B-22)

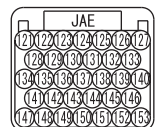

(C-24)

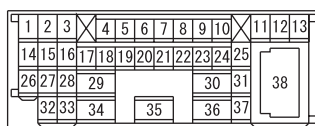

(C-202)



(C-203)

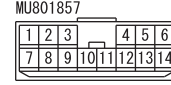

(C-208)

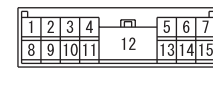

(C-212)



(C-214)



WIRE COLOR CODE
 B : BLACK LG : LIGHT GREEN G : GREEN L : BLUE
 BR : BROWN O : ORANGE GR : GRAY R : RED W : WHITE
 SB : SKY BLUE P : PINK Y : YELLOW V : VIOLET PU : PURPLE

H6P05M01AB

TSB Revision

MULTIPOINT FUEL INJECTION (MFI) SYSTEM <2.4L ENGINE-A/T> (CONTINUED)

3

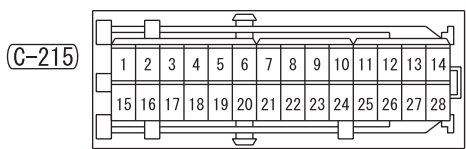
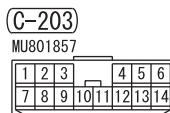
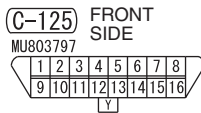
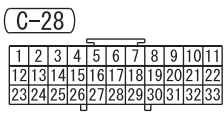
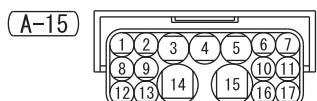
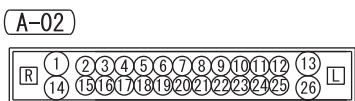
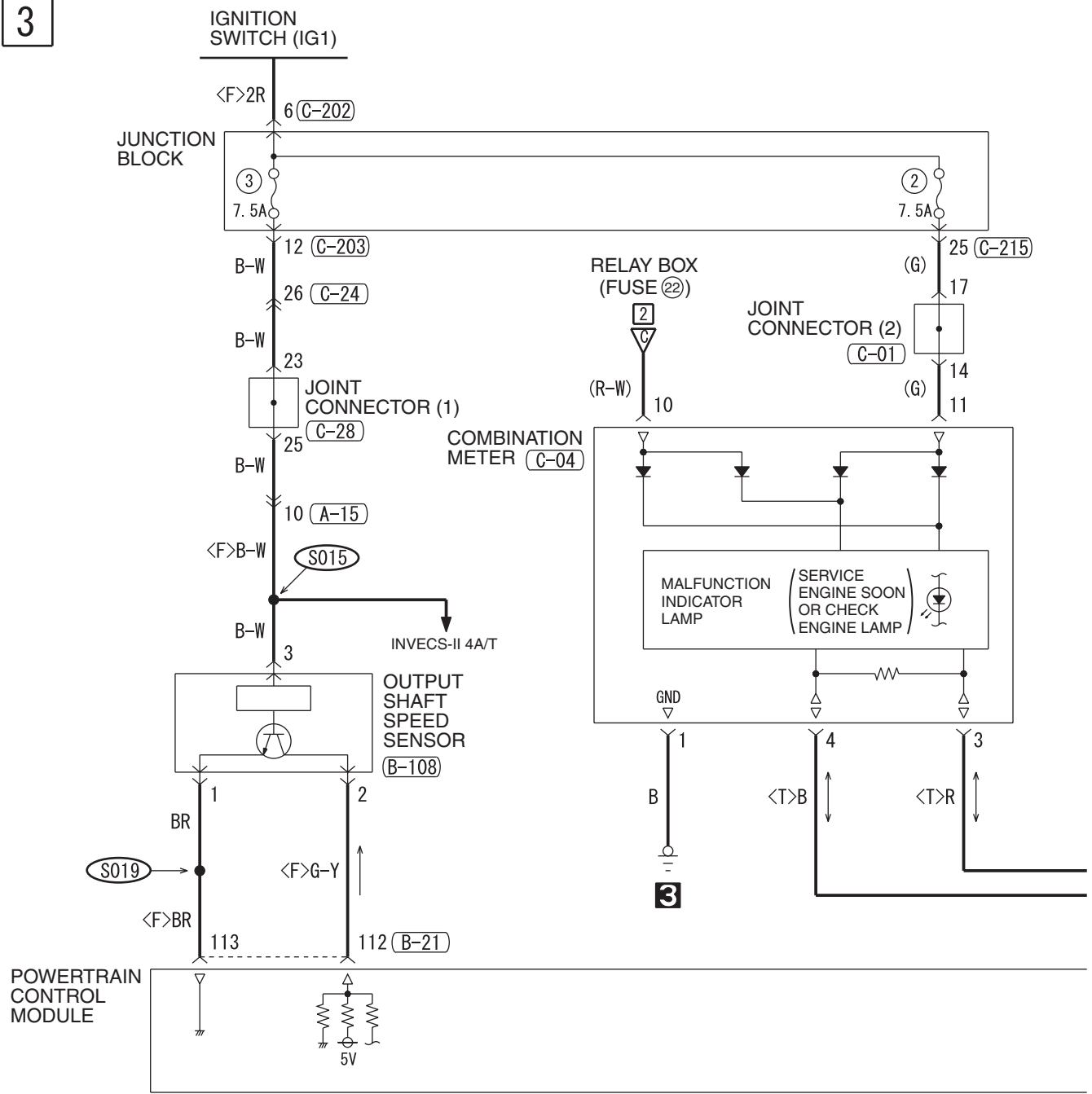

H6P05M01BA

4

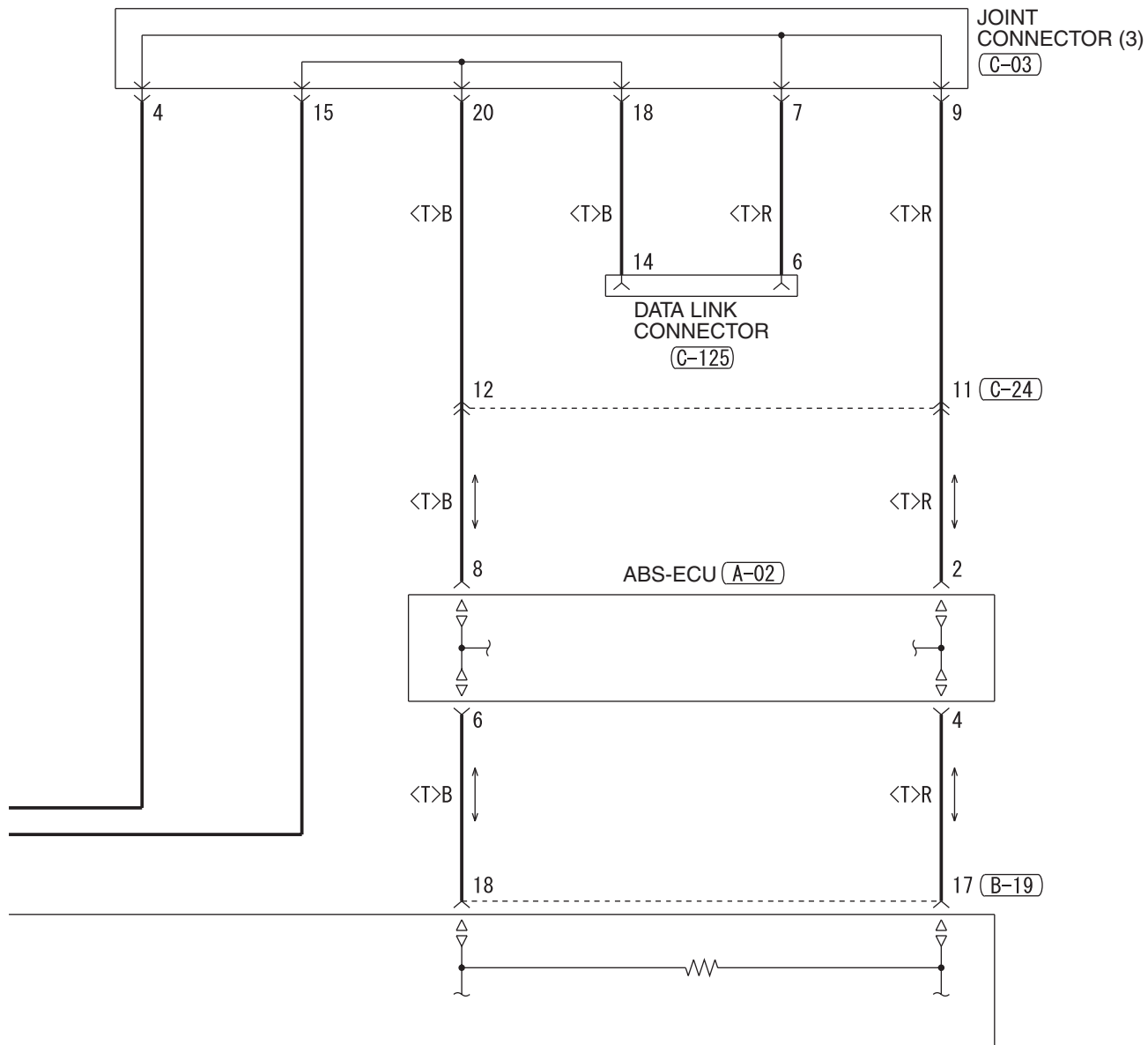

(B-21)



(B-108)



(C-01)



(C-03)

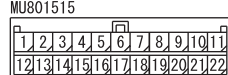

(C-04)



(C-24)

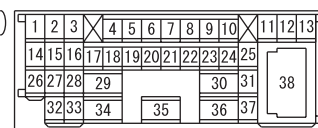

WIRE COLOR CODE

B: BLACK LG: LIGHT GREEN G: GREEN L: BLUE W: WHITE Y: YELLOW SB: SKY BLUE
 BR: BROWN O: ORANGE GR: GRAY R: RED P: PINK V: VIOLET PU: PURPLE

H6P05M01BB

TSB Revision

MULTIPOINT FUEL INJECTION (MFI) SYSTEM <2.4L ENGINE-A/T> (CONTINUED)

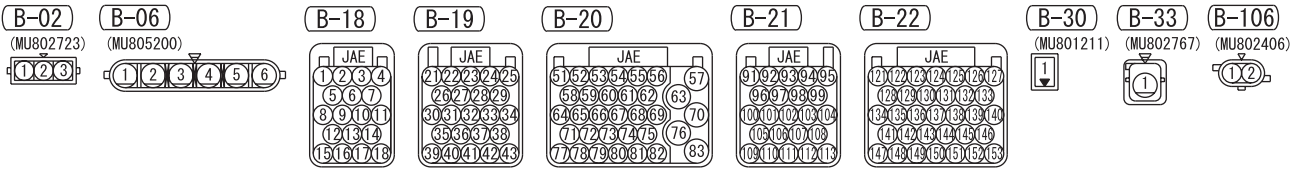
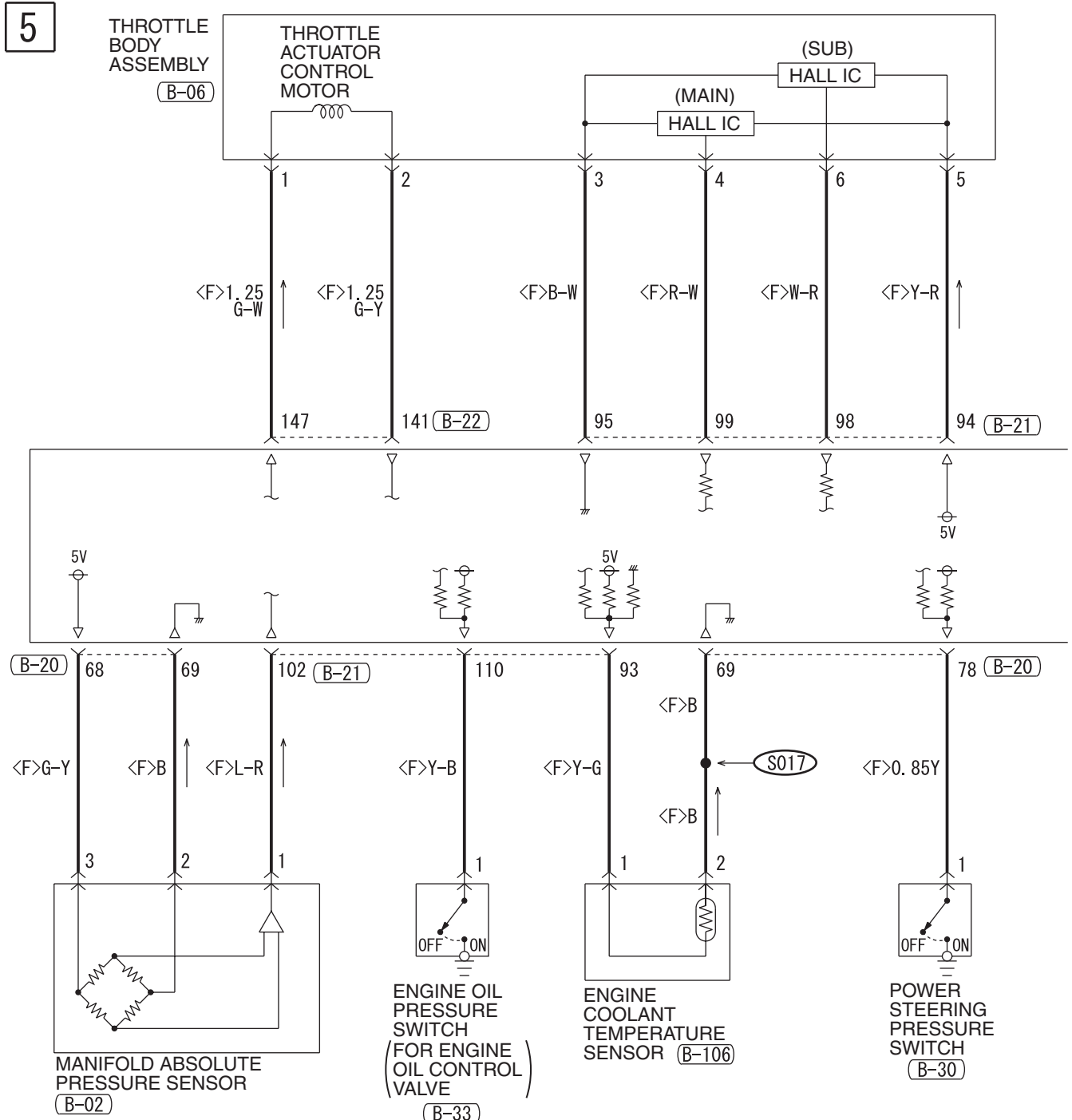

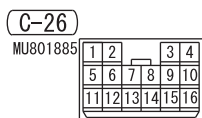
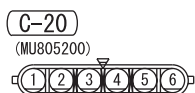
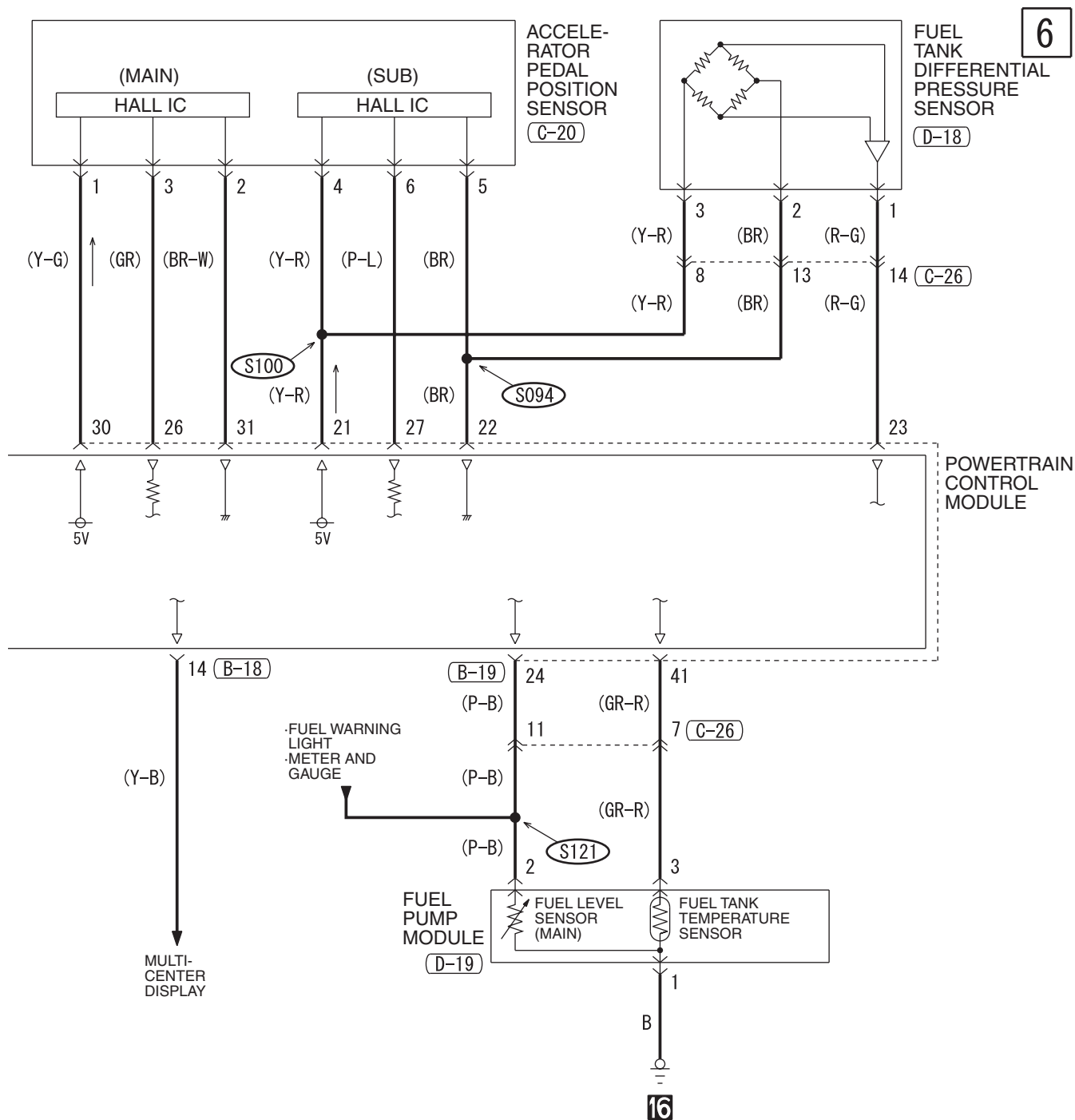

WIRE COLOR CODE

B: BLACK LG: LIGHT GREEN G: GREEN L: BLUE W: WHITE Y: YELLOW SB: SKY BLUE
 BR: BROWN O: ORANGE GR: GRAY R: RED P: PINK V: VIOLET PU: PURPLE

H6P05M01CB

MULTIPOINT FUEL INJECTION (MFI) SYSTEM <2.4L ENGINE-A/T> (CONTINUED)

7

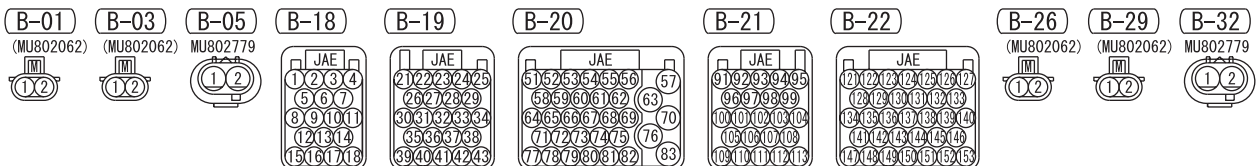
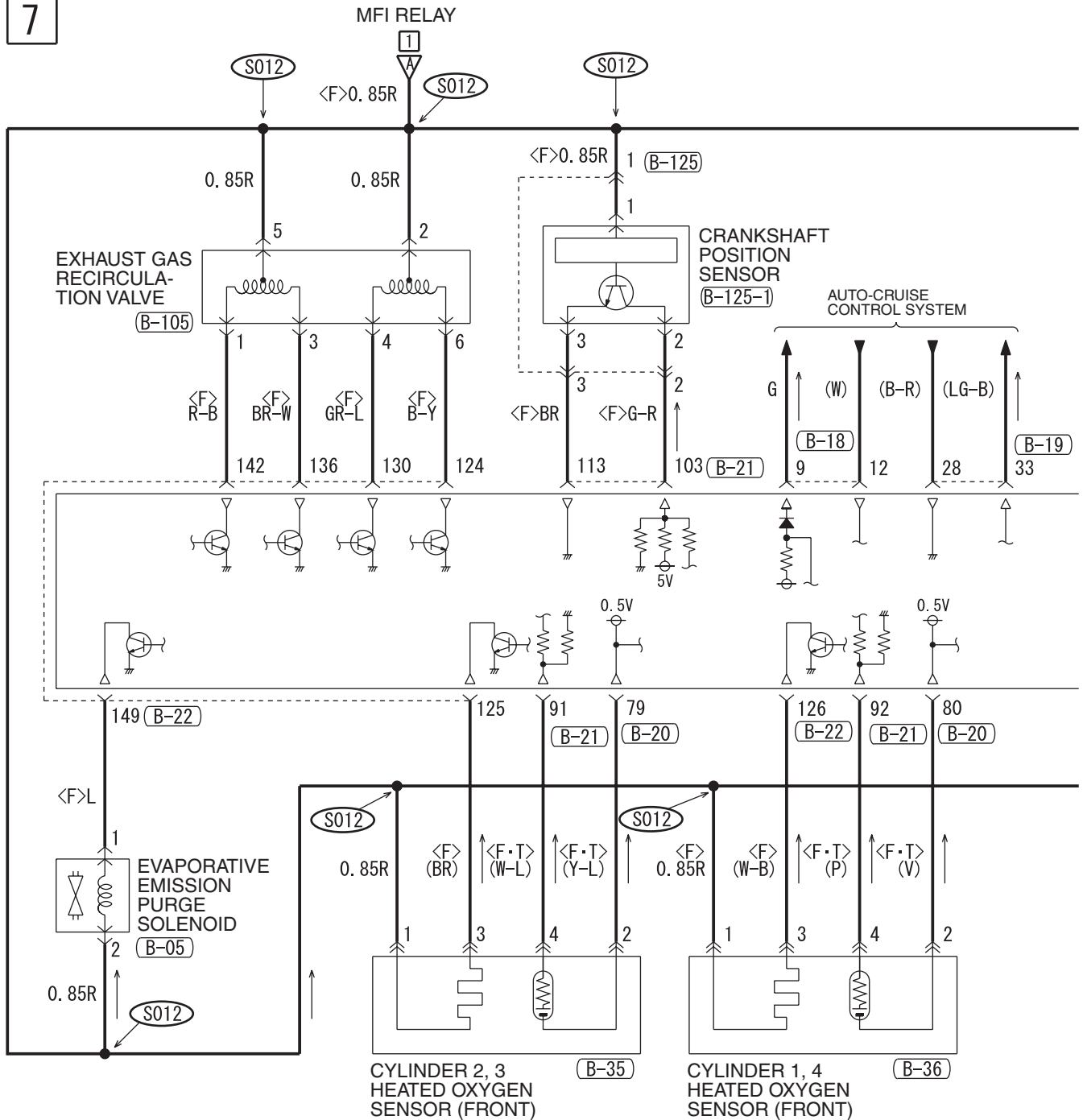

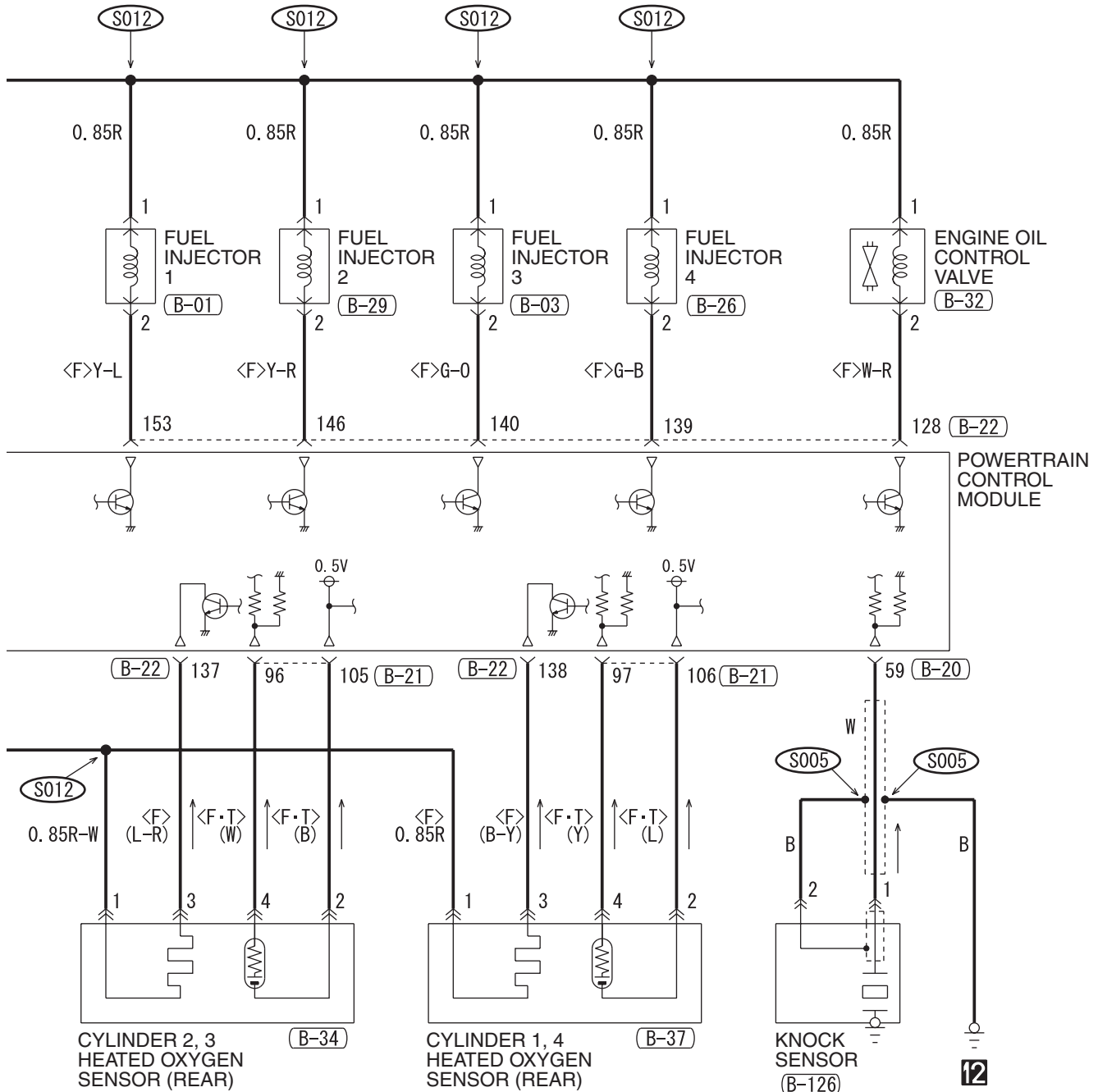

- | | | | | | | | |
|-----------------|-----------------|-----------------|-----------------|--------------------|--------------------|-------------------|------------------|
| (B-34) MU802605 | (B-35) MU802665 | (B-36) MU802665 | (B-37) MU802605 | (B-105) (MU802056) | (B-125) (MU802064) | (B-125-1) (1X2X3) | (B-126) MU802661 |
| | | | | | | | |

WIRE COLOR CODE
 B: BLACK LG: LIGHT GREEN G: GREEN L: BLUE W: WHITE Y: YELLOW SB: SKY BLUE
 BR: BROWN O: ORANGE GR: GRAY R: RED P: PINK V: VIOLET PU: PURPLE

MULTIPOINT FUEL INJECTION (MFI) SYSTEM <2.4L ENGINE-A/T> (CONTINUED)

9

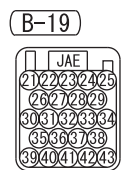
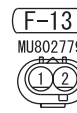
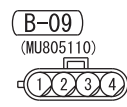
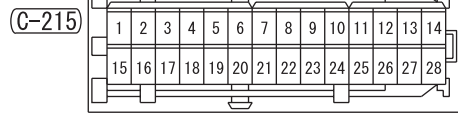
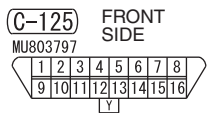
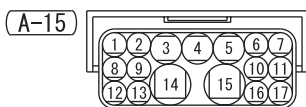
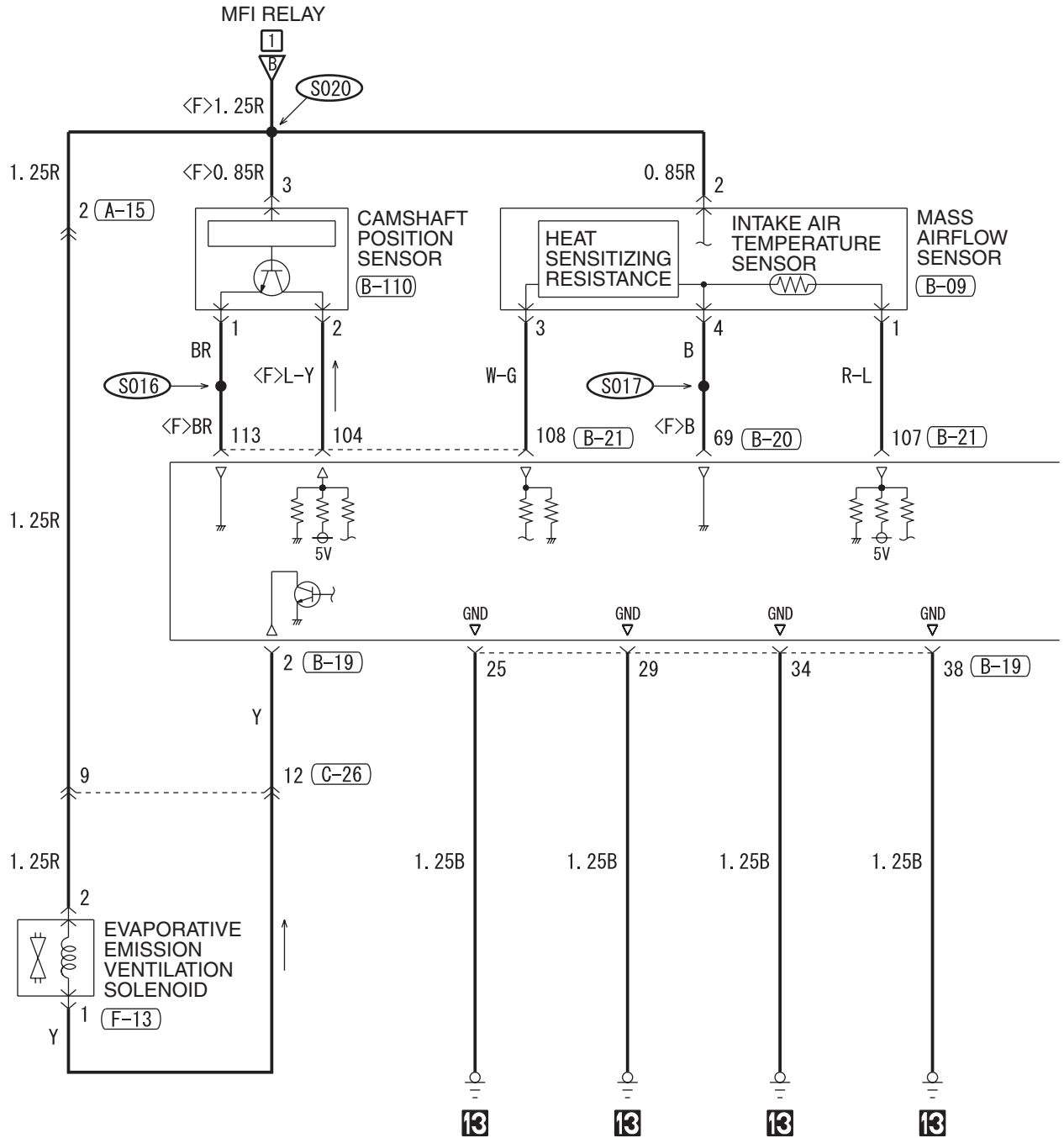

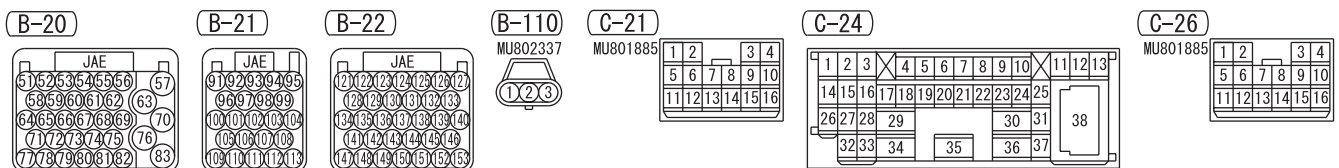
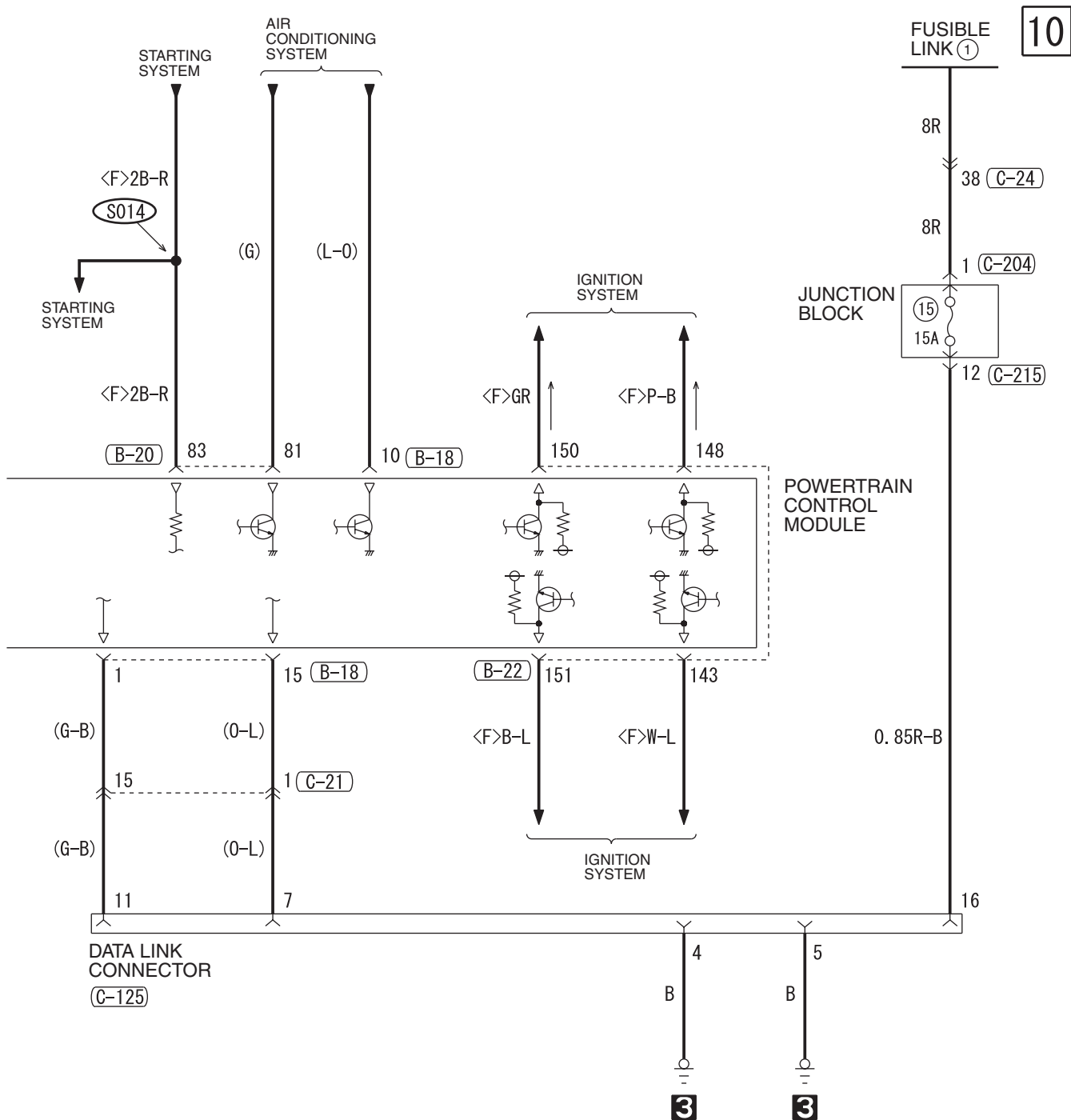

MULTIPOINT FUEL INJECTION (MFI) SYSTEM <3.8L ENGINE-M/T>

M1901000803605

1

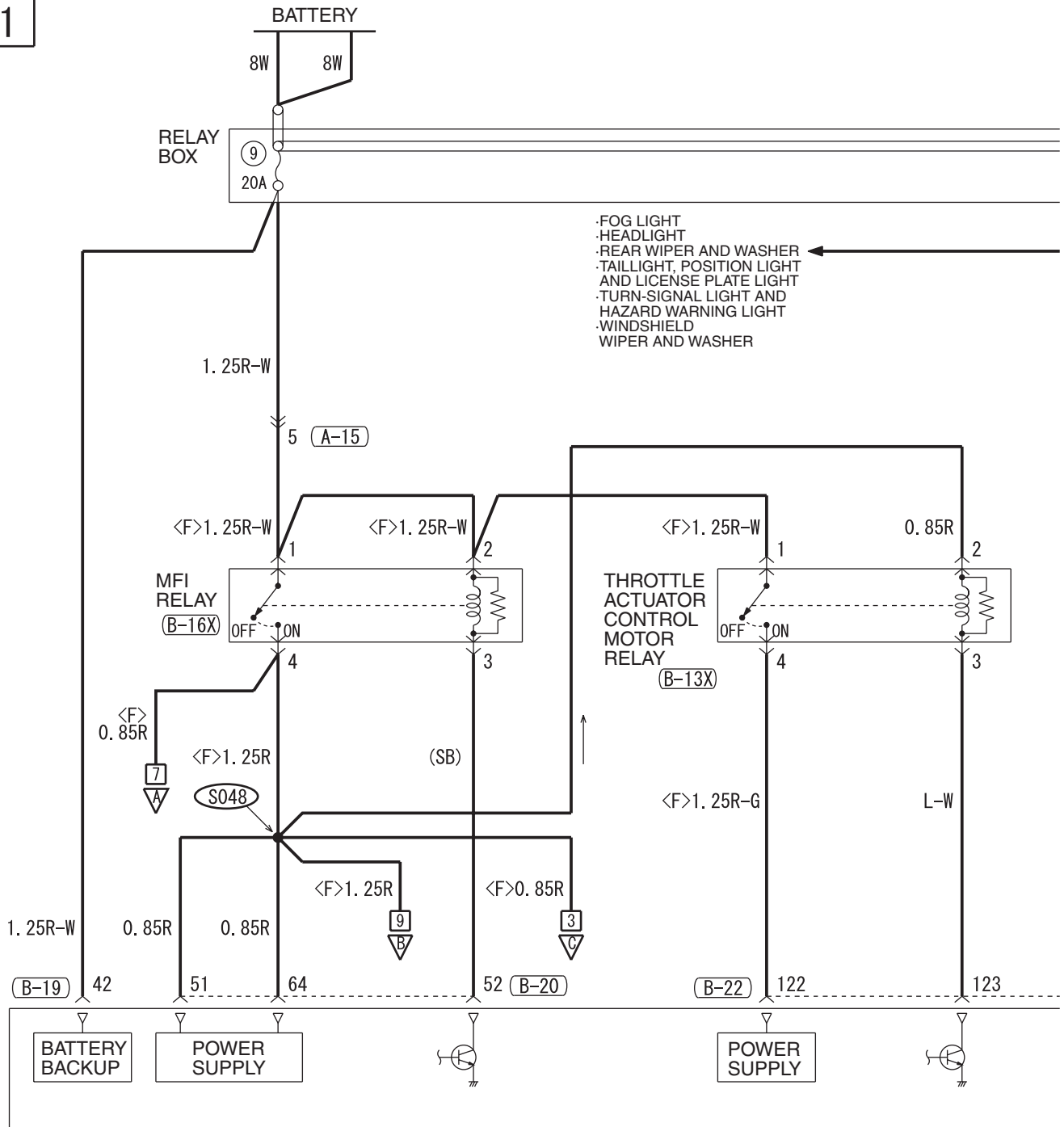

(A-15)

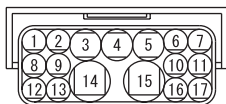

(C-215)

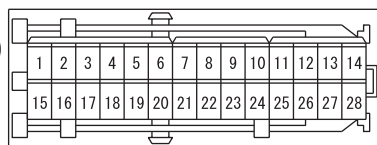

(B-13X)



(D-19)
 (MU802058)



(B-16X)



(B-18)



(B-19)

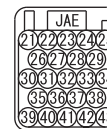

(B-20)

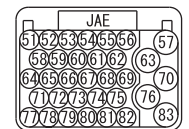

H6P05M02AA

2

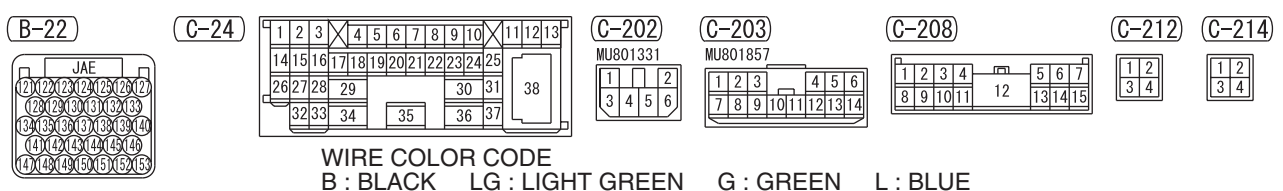
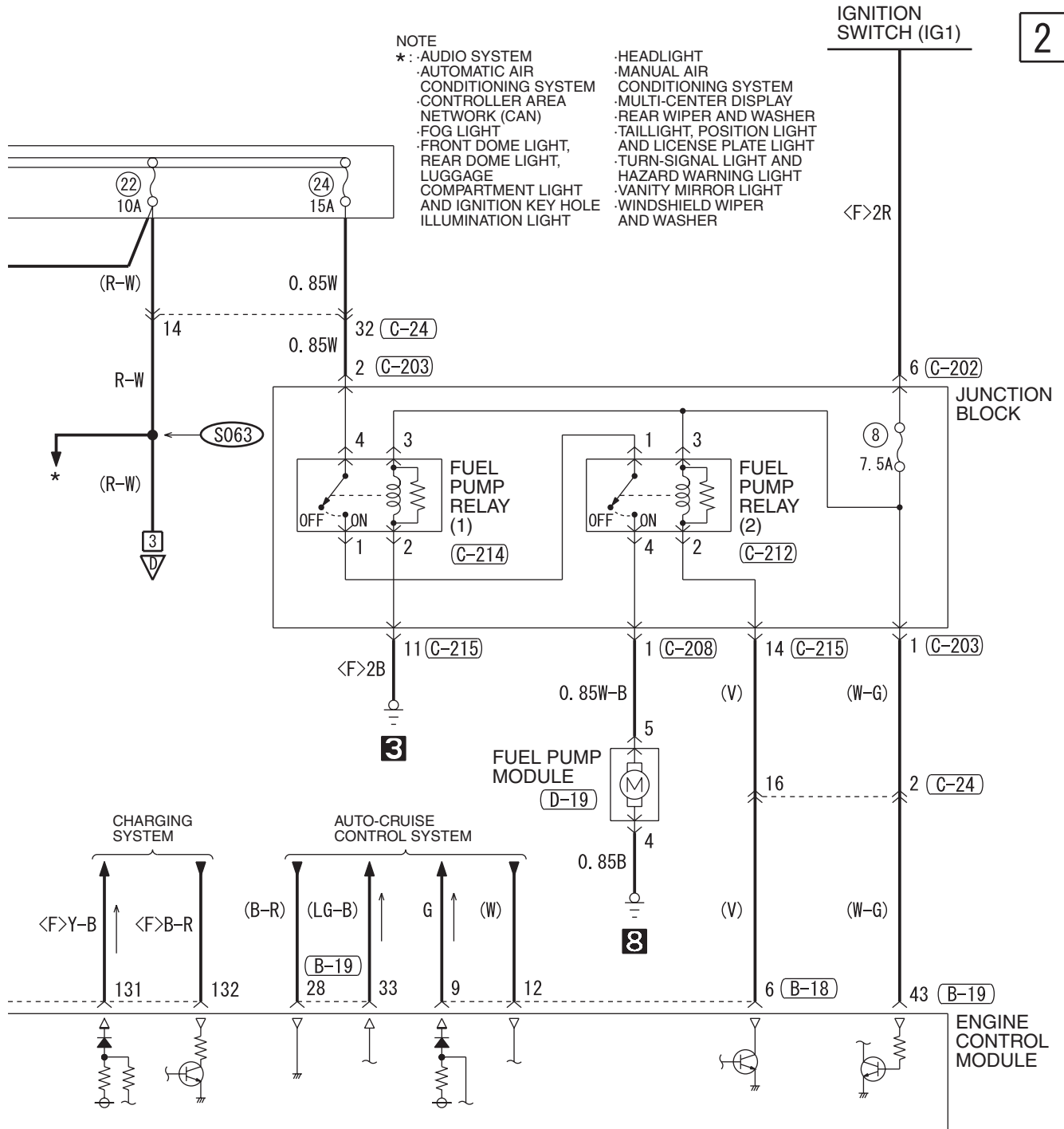

MULTIPOINT FUEL INJECTION (MFI) SYSTEM <3.8L ENGINE-M/T> (CONTINUED)

3

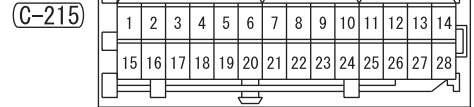
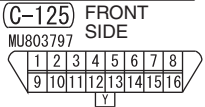
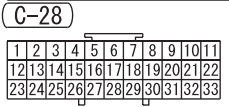
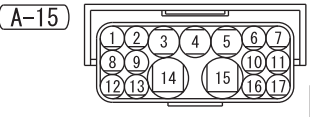
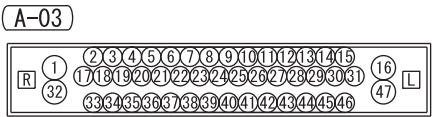
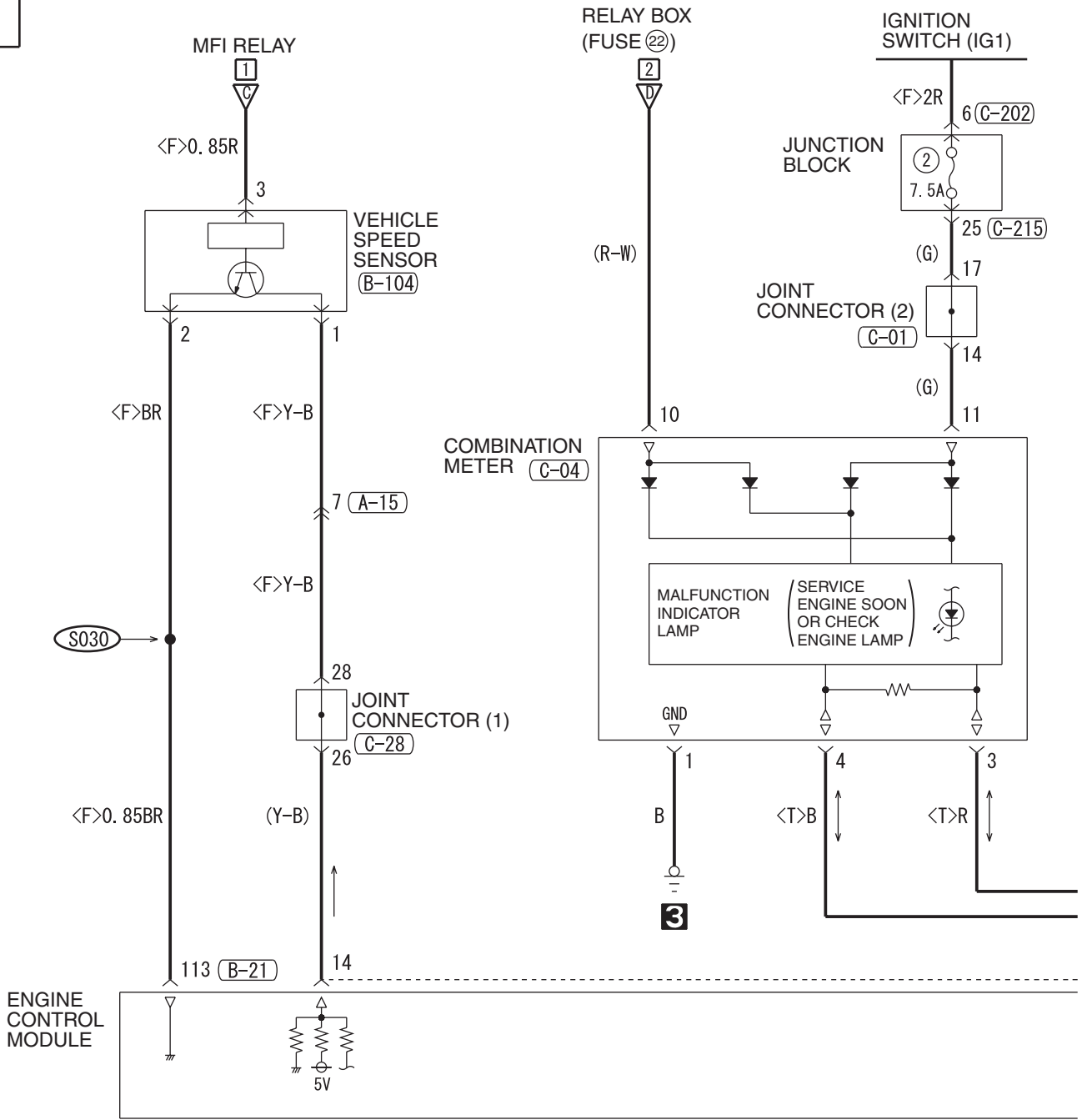

H6P05M02BA

4

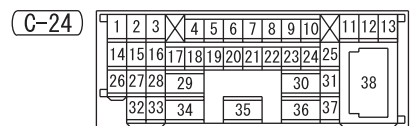
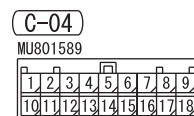
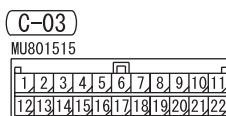
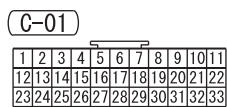
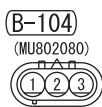
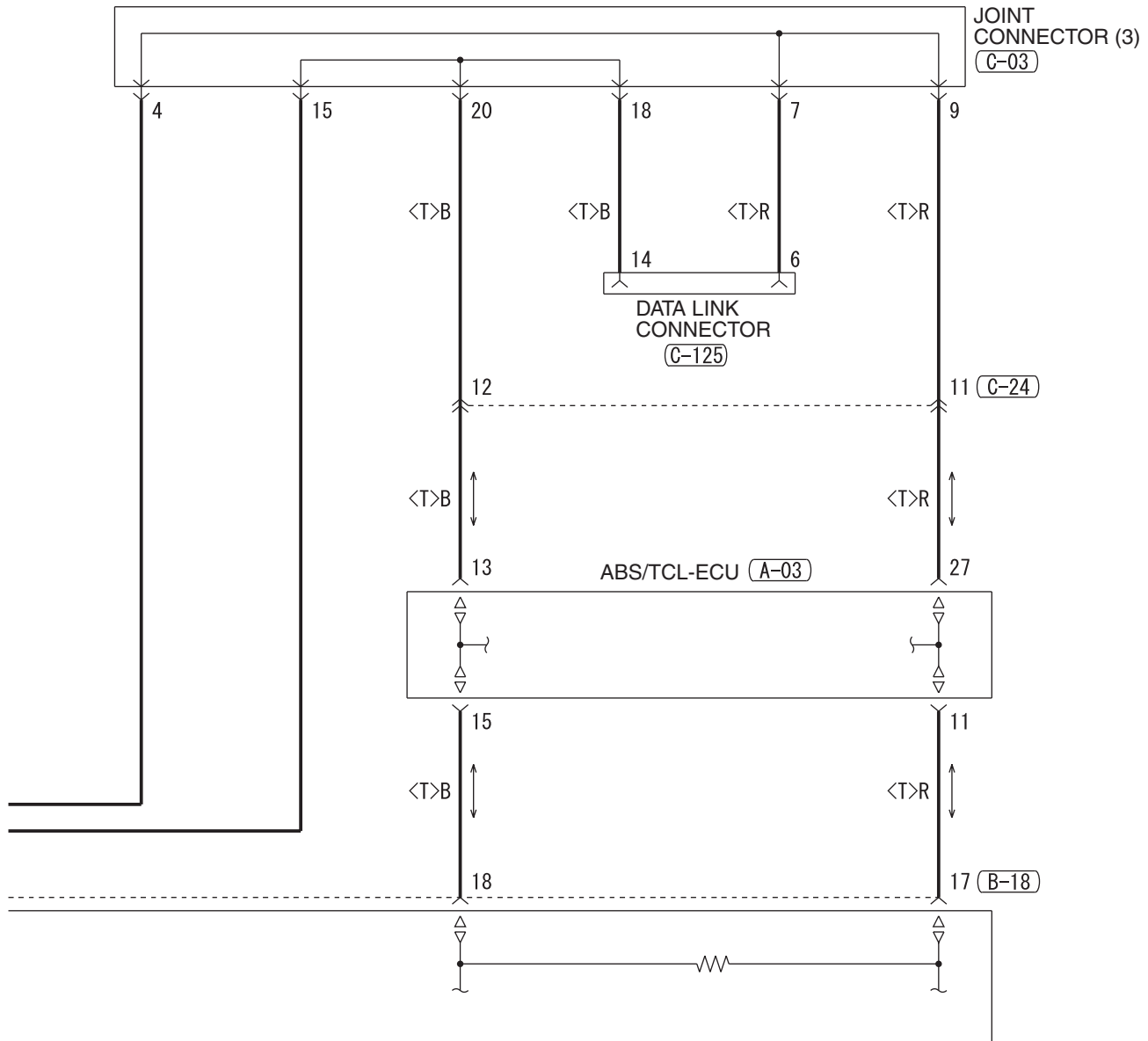

WIRE COLOR CODE
 B : BLACK LG : LIGHT GREEN G : GREEN L : BLUE
 BR : BROWN O : ORANGE GR : GRAY R : RED W : WHITE
 SB : SKY BLUE P : PINK Y : YELLOW V : VIOLET PU : PURPLE

H6P05M02BB

TSB Revision

MULTIPOINT FUEL INJECTION (MFI) SYSTEM <3.8L ENGINE-M/T> (CONTINUED)

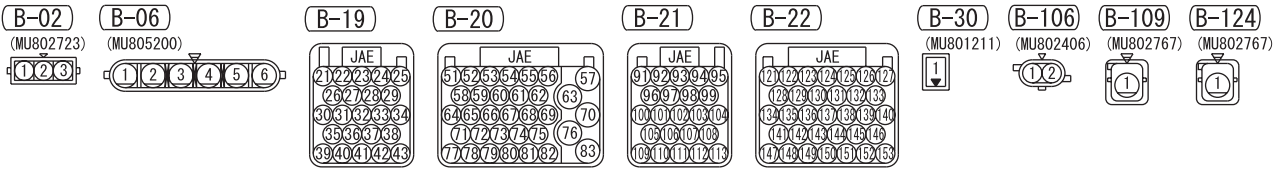
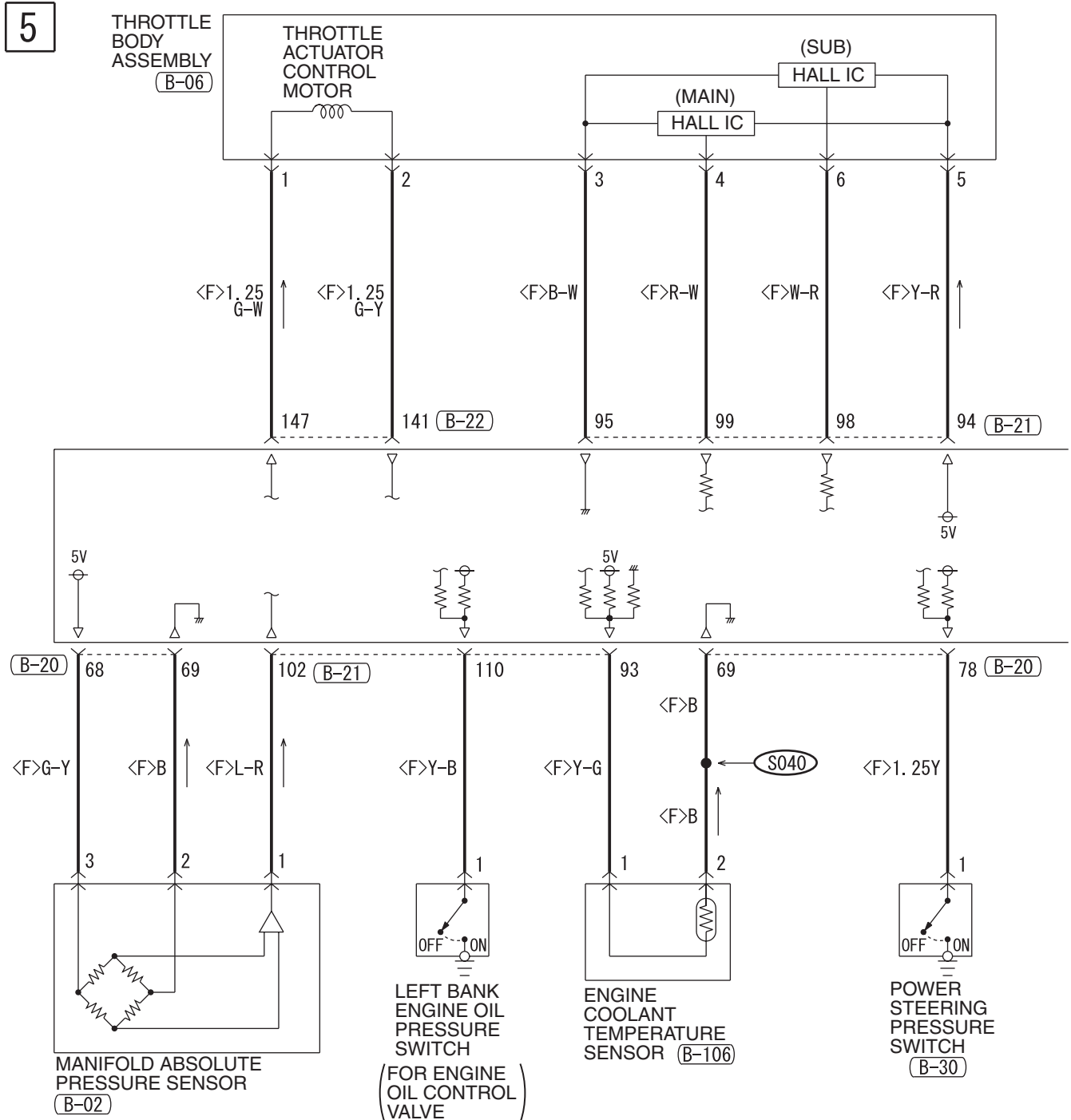

6

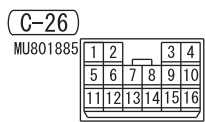
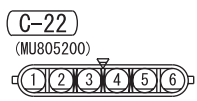
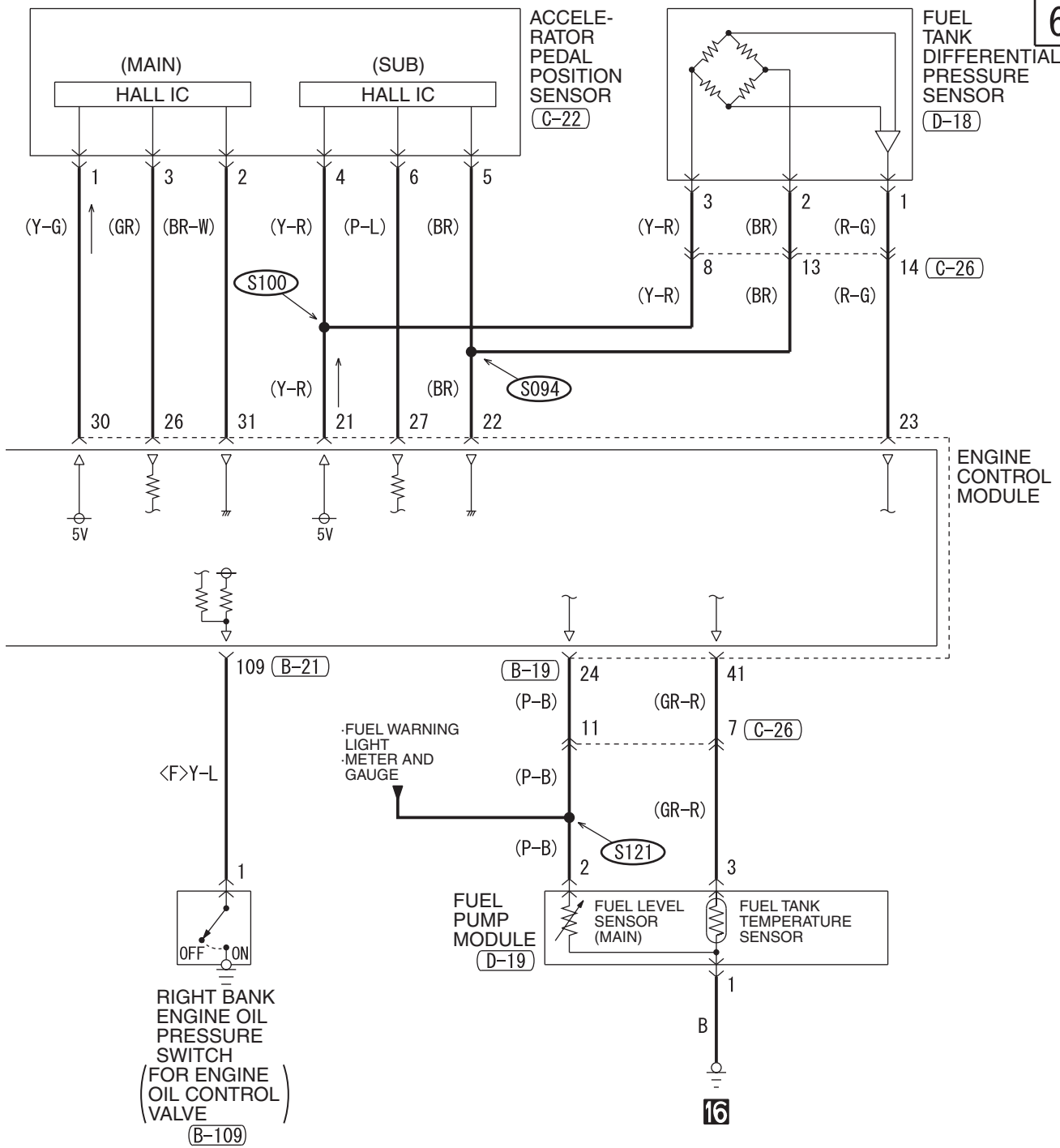

WIRE COLOR CODE
 B : BLACK LG : LIGHT GREEN G : GREEN L : BLUE W : WHITE Y : YELLOW SB : SKY BLUE
 BR : BROWN O : ORANGE GR : GRAY R : RED P : PINK V : VIOLET PU : PURPLE

H6P05M02CB

MULTIPOINT FUEL INJECTION (MFI) SYSTEM <3.8L ENGINE-M/T> (CONTINUED)

7

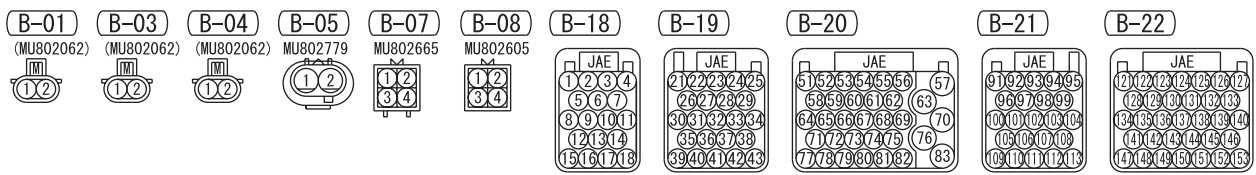
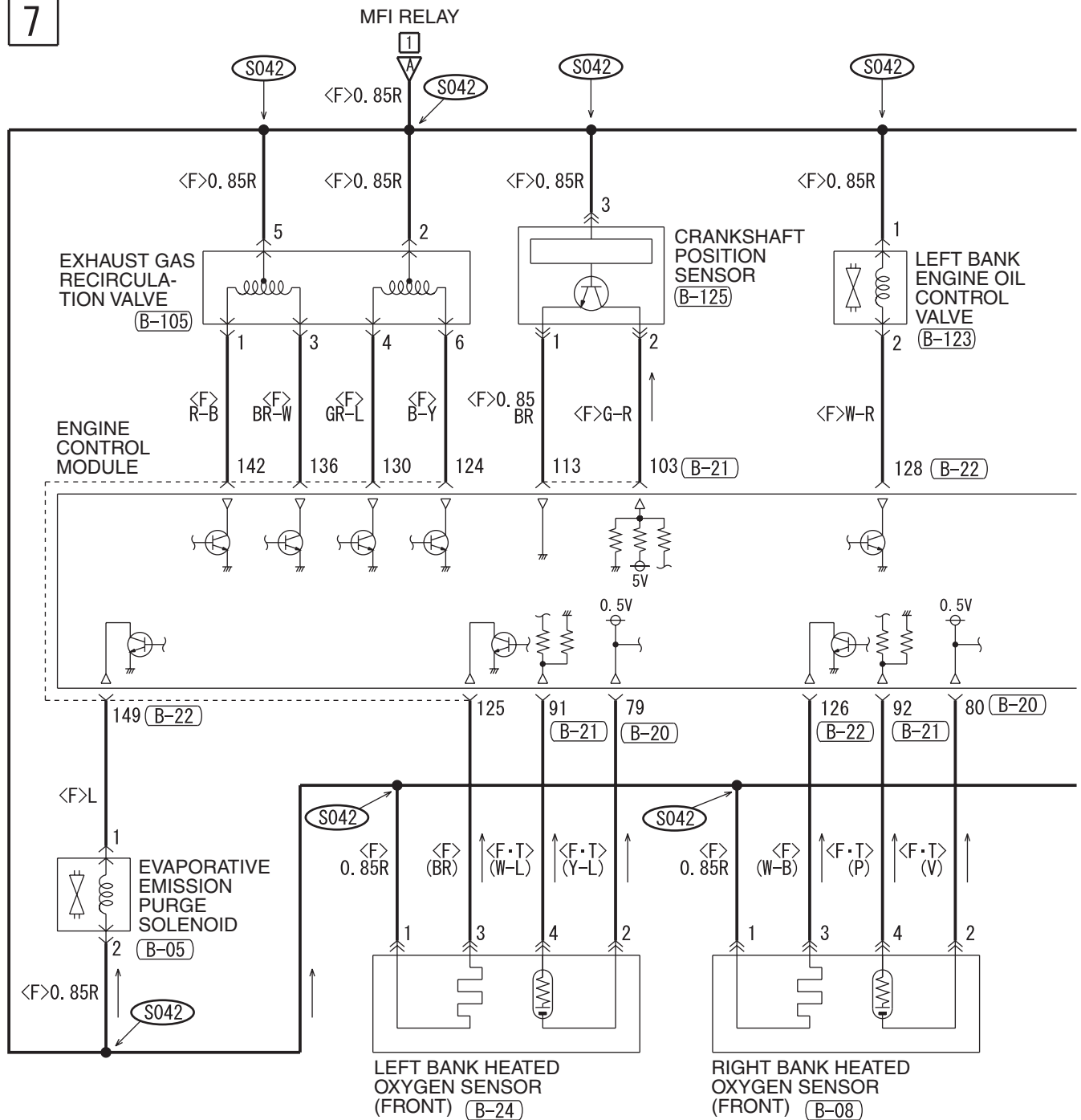

8

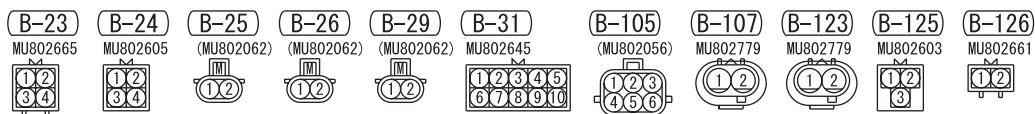
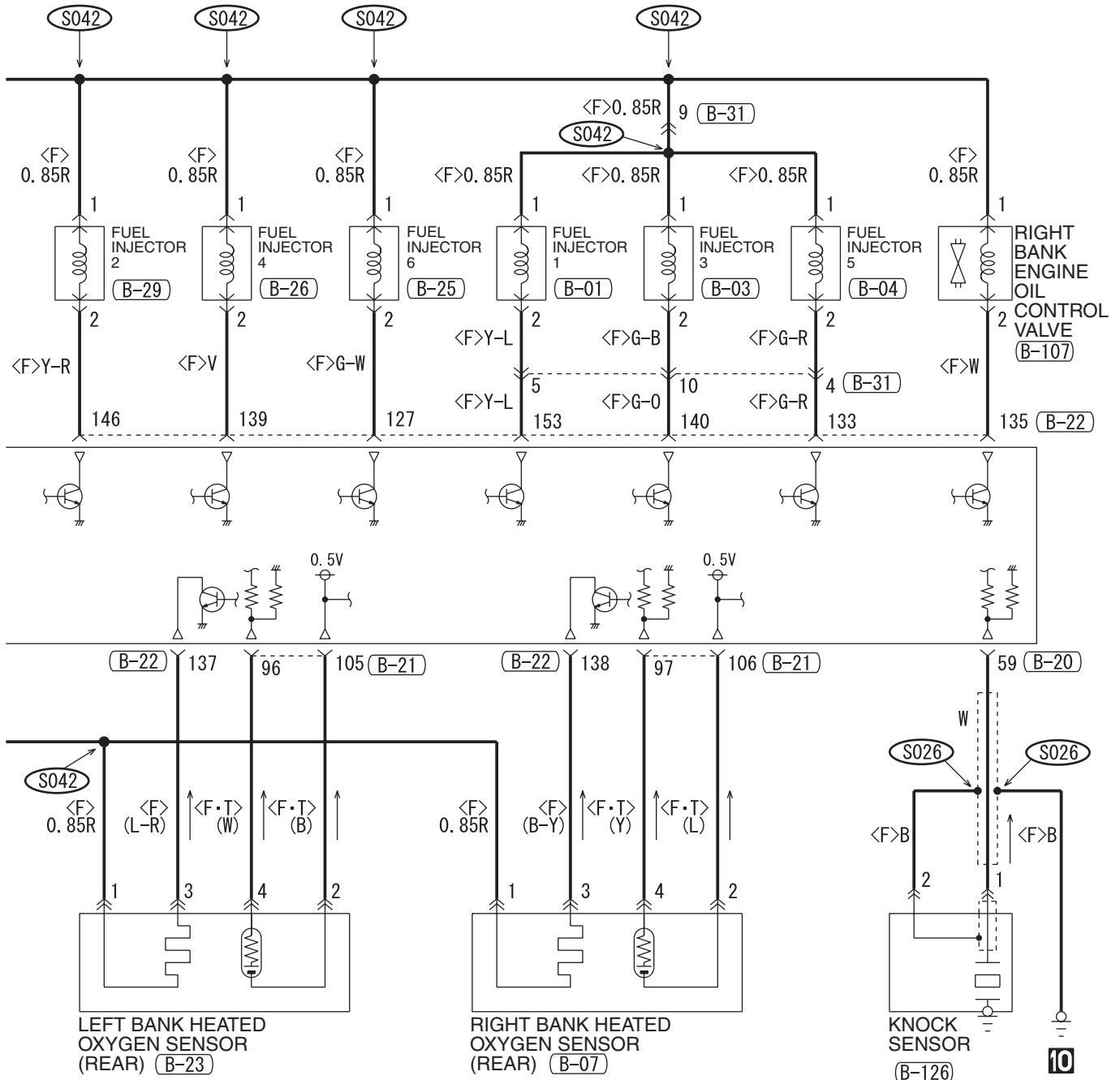

WIRE COLOR CODE
 B : BLACK LG : LIGHT GREEN G : GREEN L : BLUE W : WHITE Y : YELLOW SB : SKY BLUE
 BR : BROWN O : ORANGE GR : GRAY R : RED P : PINK V : VIOLET PU : PURPLE

H6P05M02DB

TSB Revision

MULTI-PORT FUEL INJECTION (MFI) SYSTEM <3.8L ENGINE-M/T> (CONTINUED)

9

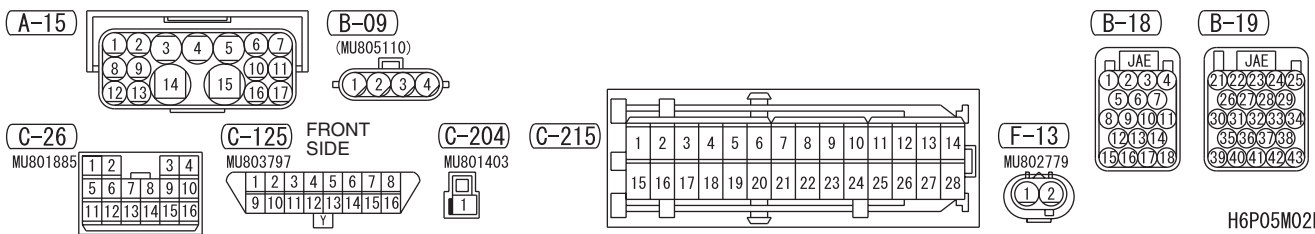
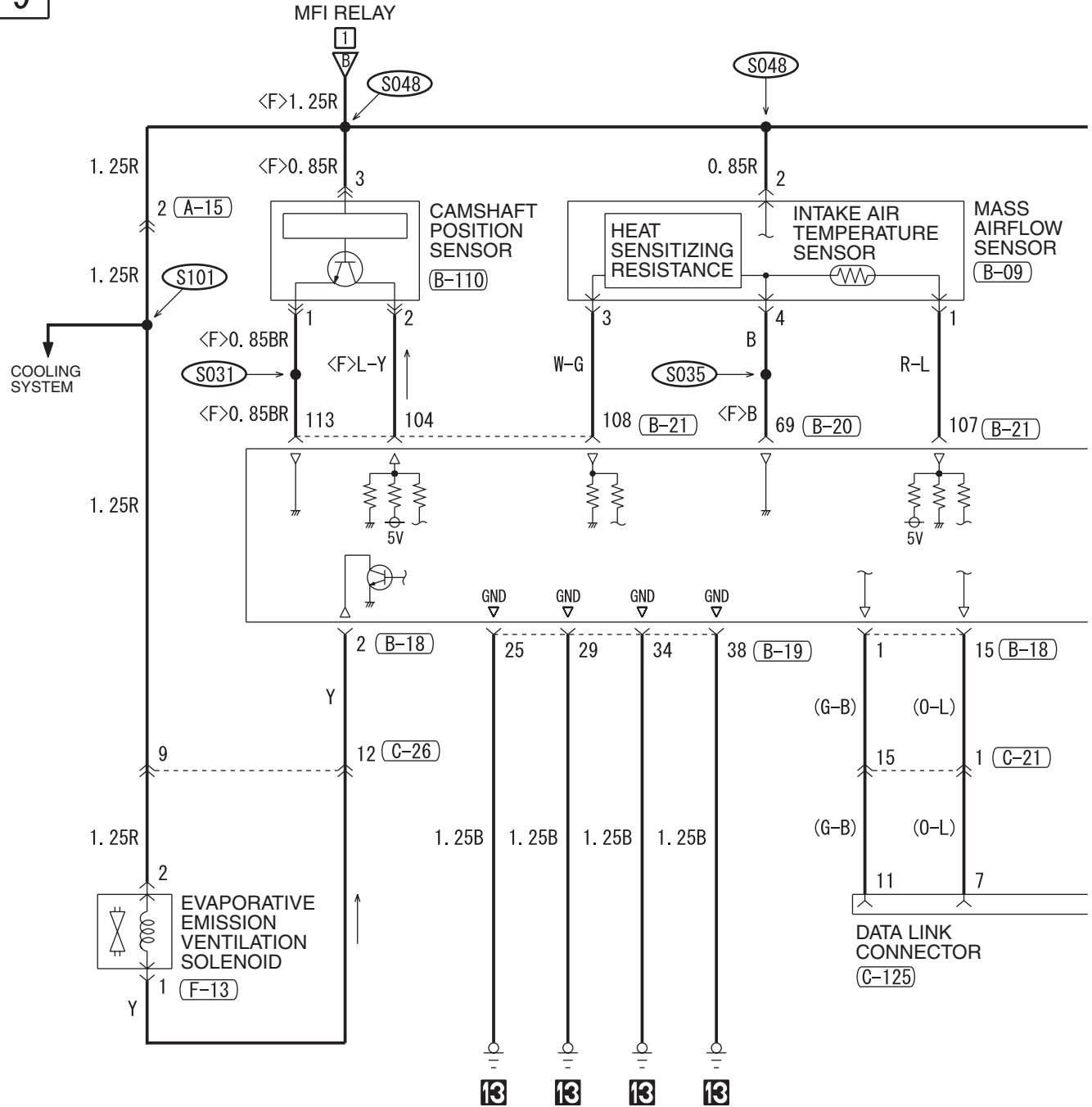

H6P05M02EA

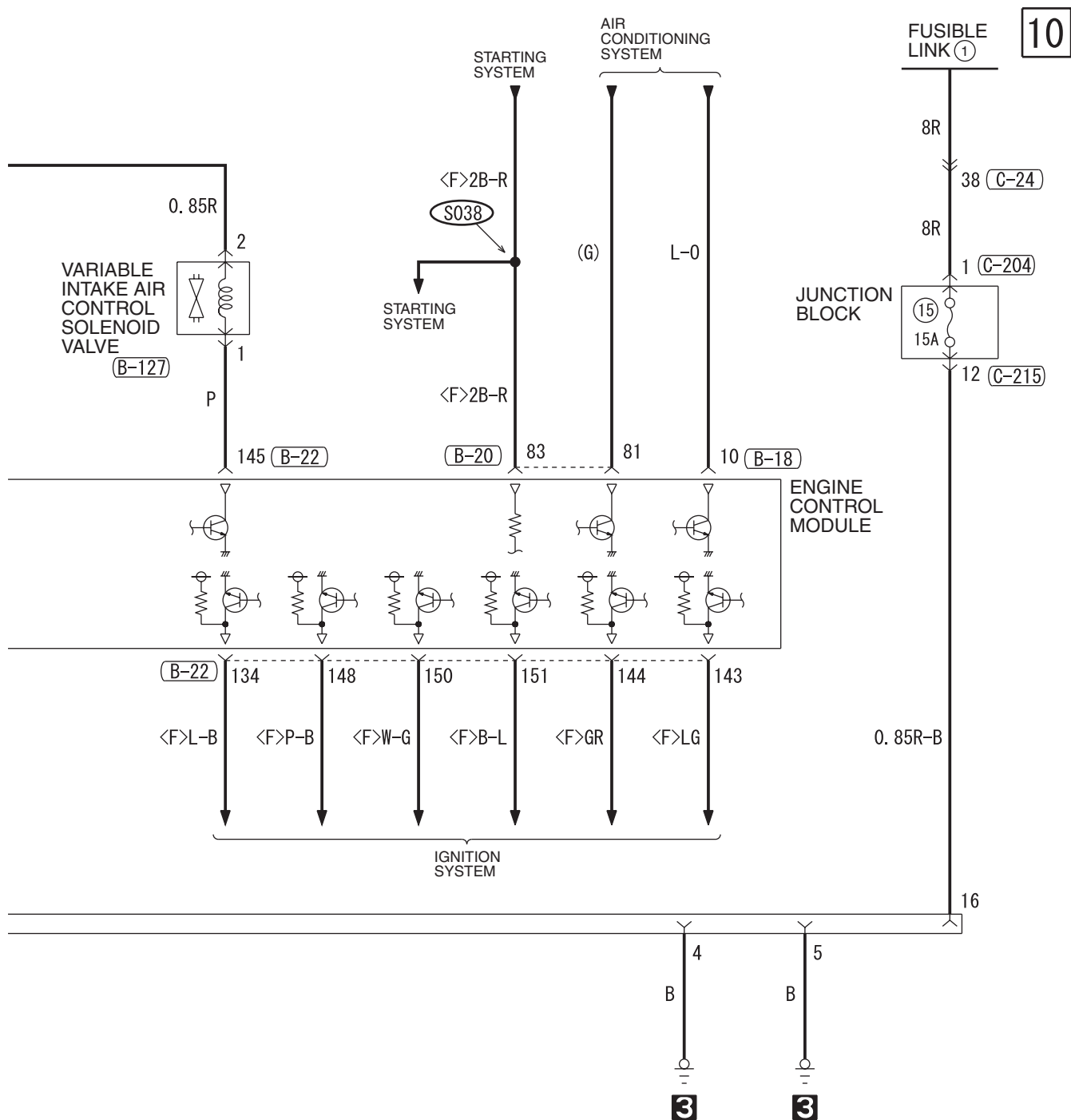

(B-20)

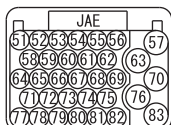

(B-21)



(B-22)

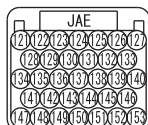

(B-110)



(B-127)



(C-21)



(C-24)

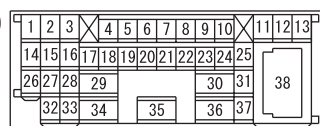

WIRE COLOR CODE

B : BLACK LG : LIGHT GREEN G : GREEN L : BLUE
 BR : BROWN O : ORANGE GR : GRAY R : RED W : WHITE
 SB : SKY BLUE P : PINK Y : YELLOW V : VIOLET P : PURPLE

H6P05M02EB

MULTIPOINT FUEL INJECTION (MFI) SYSTEM <3.8L ENGINE-A/T>

M1901000803616

1

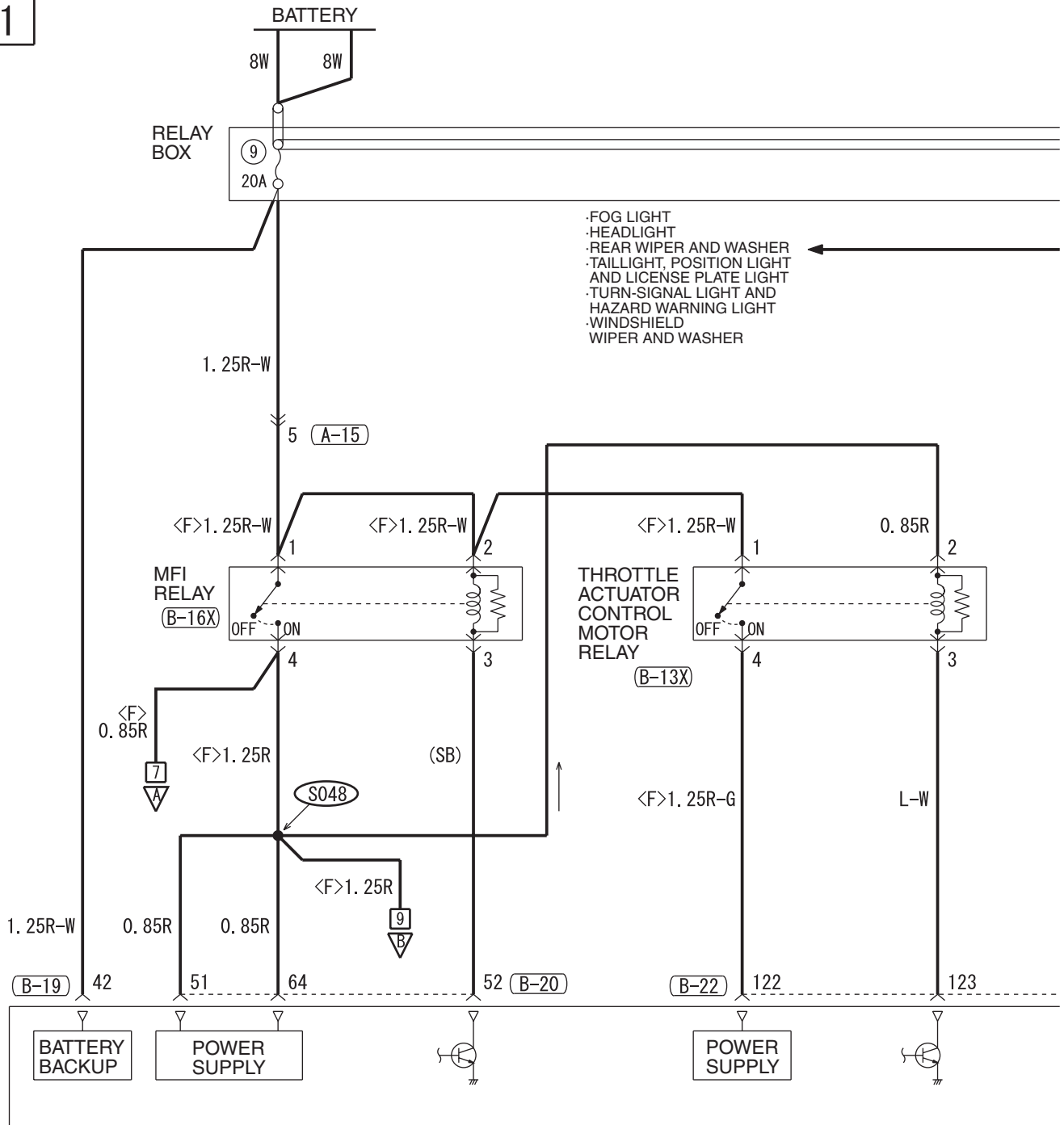

- FOG LIGHT
- HEADLIGHT
- REAR WIPER AND WASHER
- TAILLIGHT, POSITION LIGHT AND LICENSE PLATE LIGHT
- TURN-SIGNAL LIGHT AND HAZARD WARNING LIGHT
- WINDSHIELD WIPER AND WASHER

(A-15)

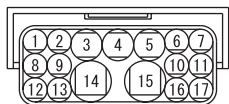

(C-215)

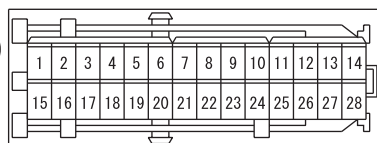

(B-13X)



(D-19)
(MU802058)



(B-16X)



(B-18)



(B-19)



(B-20)



H6P05M03AA

TSB Revision

2

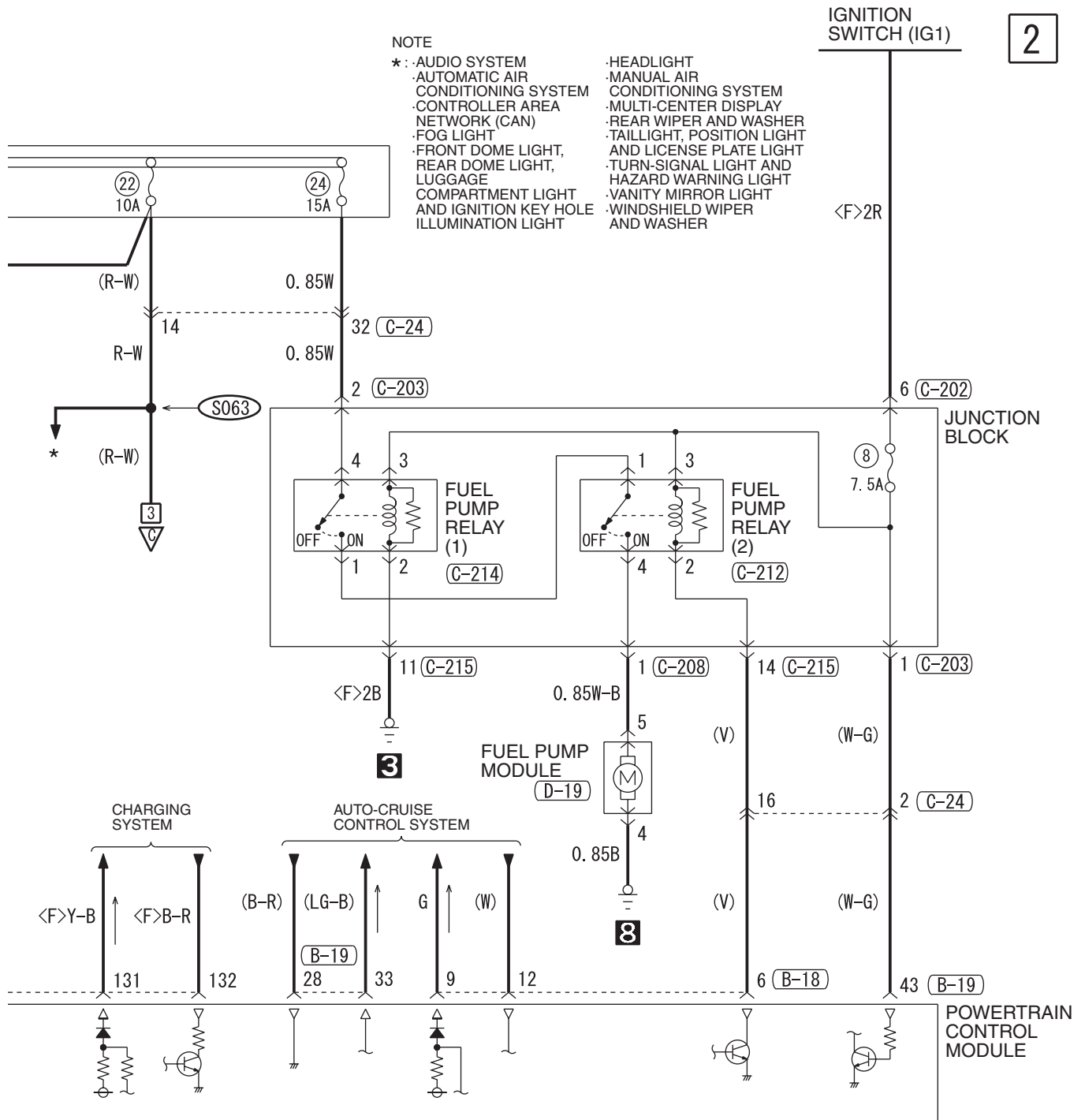

(B-22)

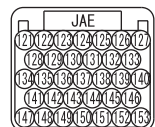

(C-24)

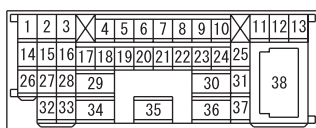

(C-202)



(C-203)

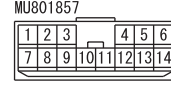

(C-208)

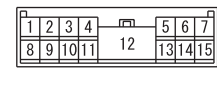

(C-212)



(C-214)



WIRE COLOR CODE

B : BLACK LG : LIGHT GREEN G : GREEN L : BLUE
 BR : BROWN O : ORANGE GR : GRAY R : RED W : WHITE
 SB : SKY BLUE P : PINK Y : YELLOW V : VIOLET PU : PURPLE

H6P05M03AB

TSB Revision

MULTIPOINT FUEL INJECTION (MFI) SYSTEM <3.8L ENGINE-A/T> (CONTINUED)

3

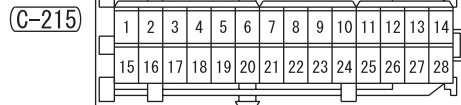
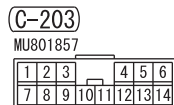
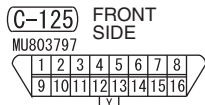
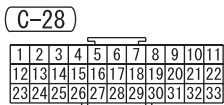
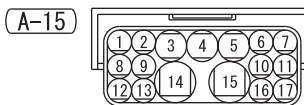
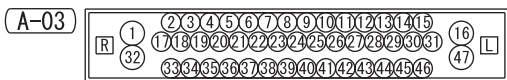
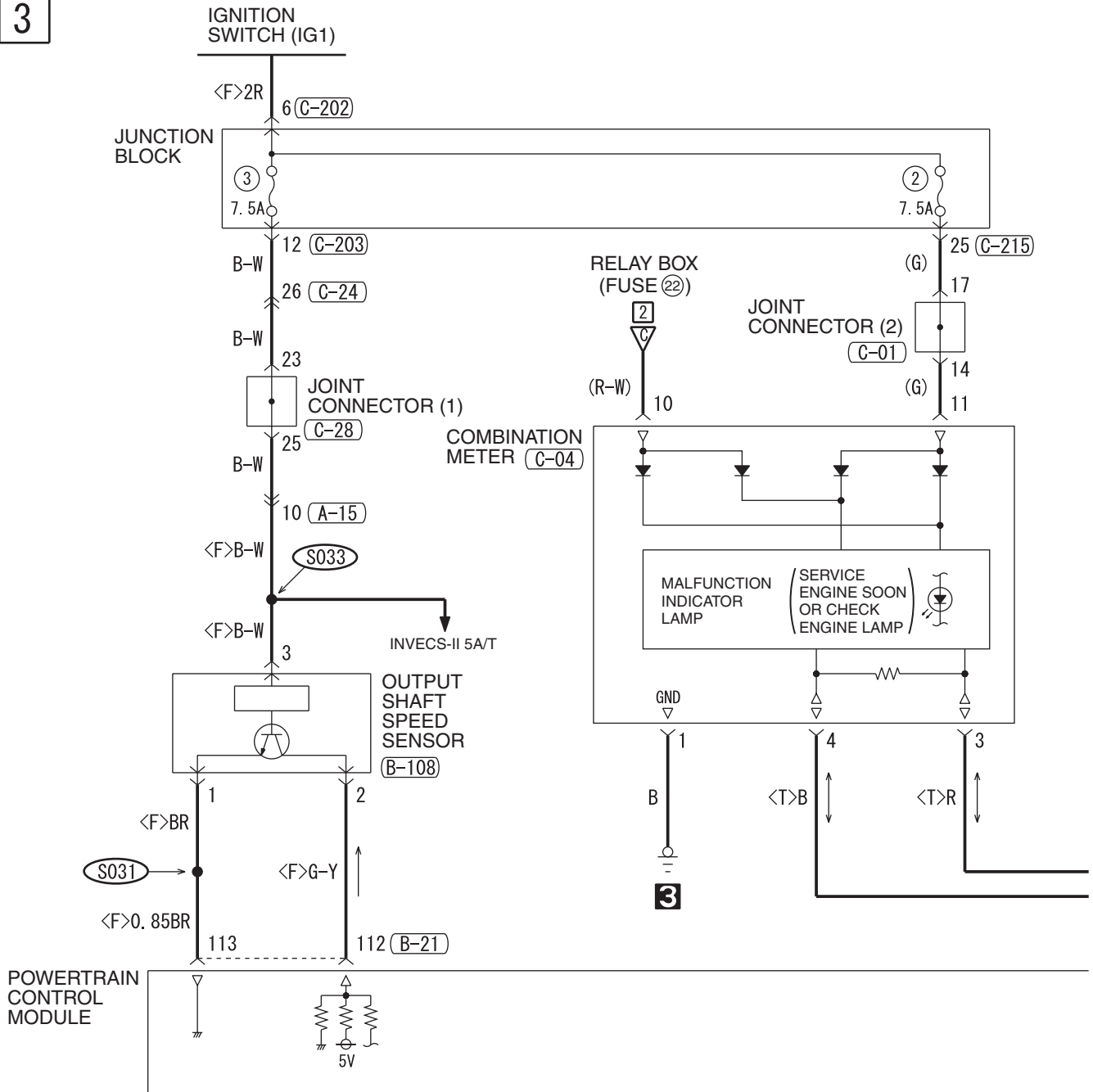

H6P05M03BA

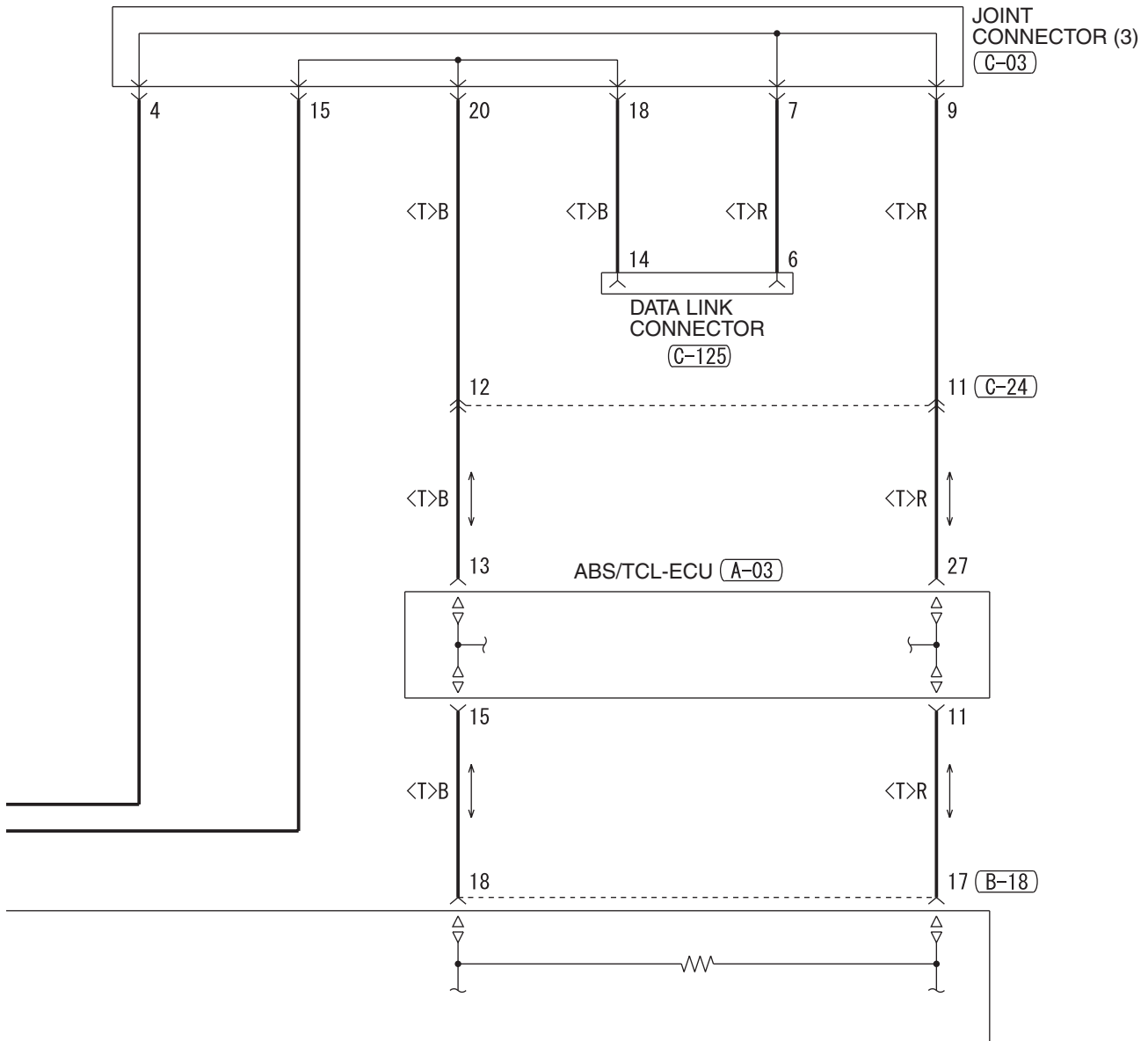

(B-21)



(B-108)



(C-01)

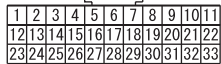

(C-03)

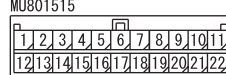

(C-04)

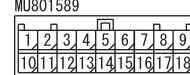

(C-24)

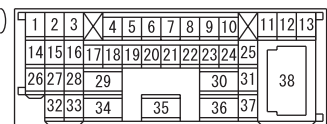

WIRE COLOR CODE

B: BLACK LG: LIGHT GREEN G: GREEN L: BLUE W: WHITE Y: YELLOW SB: SKY BLUE
 BR: BROWN O: ORANGE GR: GRAY R: RED P: PINK V: VIOLET PU: PURPLE

H6P05M03BB

MULTIPOINT FUEL INJECTION (MFI) SYSTEM <3.8L ENGINE-A/T> (CONTINUED)

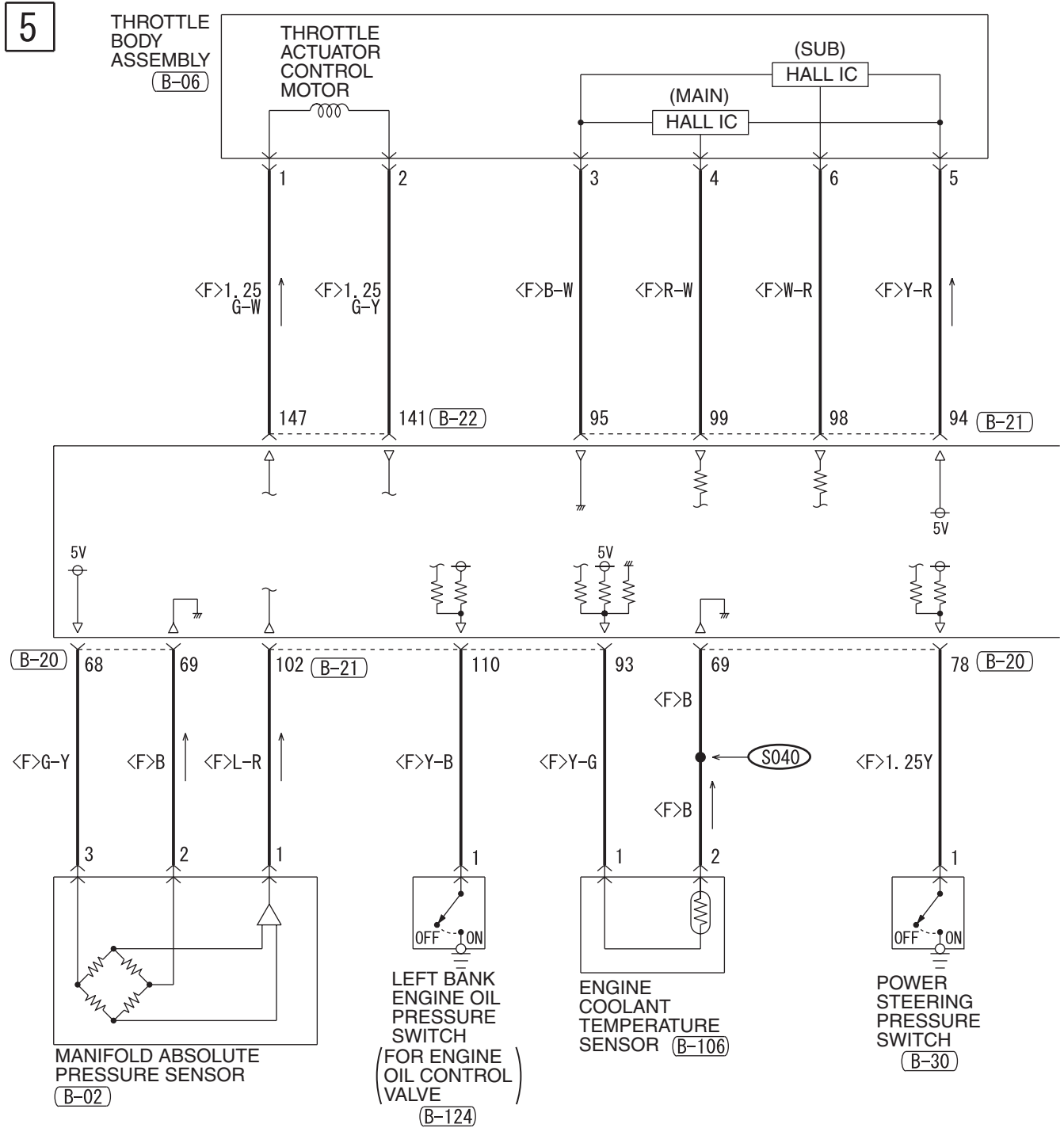

- (B-02) (MU802723)
- (B-06) (MU805200)
- (B-18) JAE
- (B-19) JAE
- (B-20) JAE
- (B-21) JAE
- (B-22) JAE
- (B-30) (MU801211)
- (B-106) (MU802406)
- (B-109) (MU802767)

6

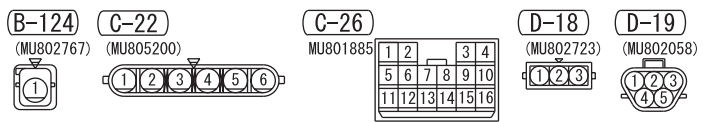
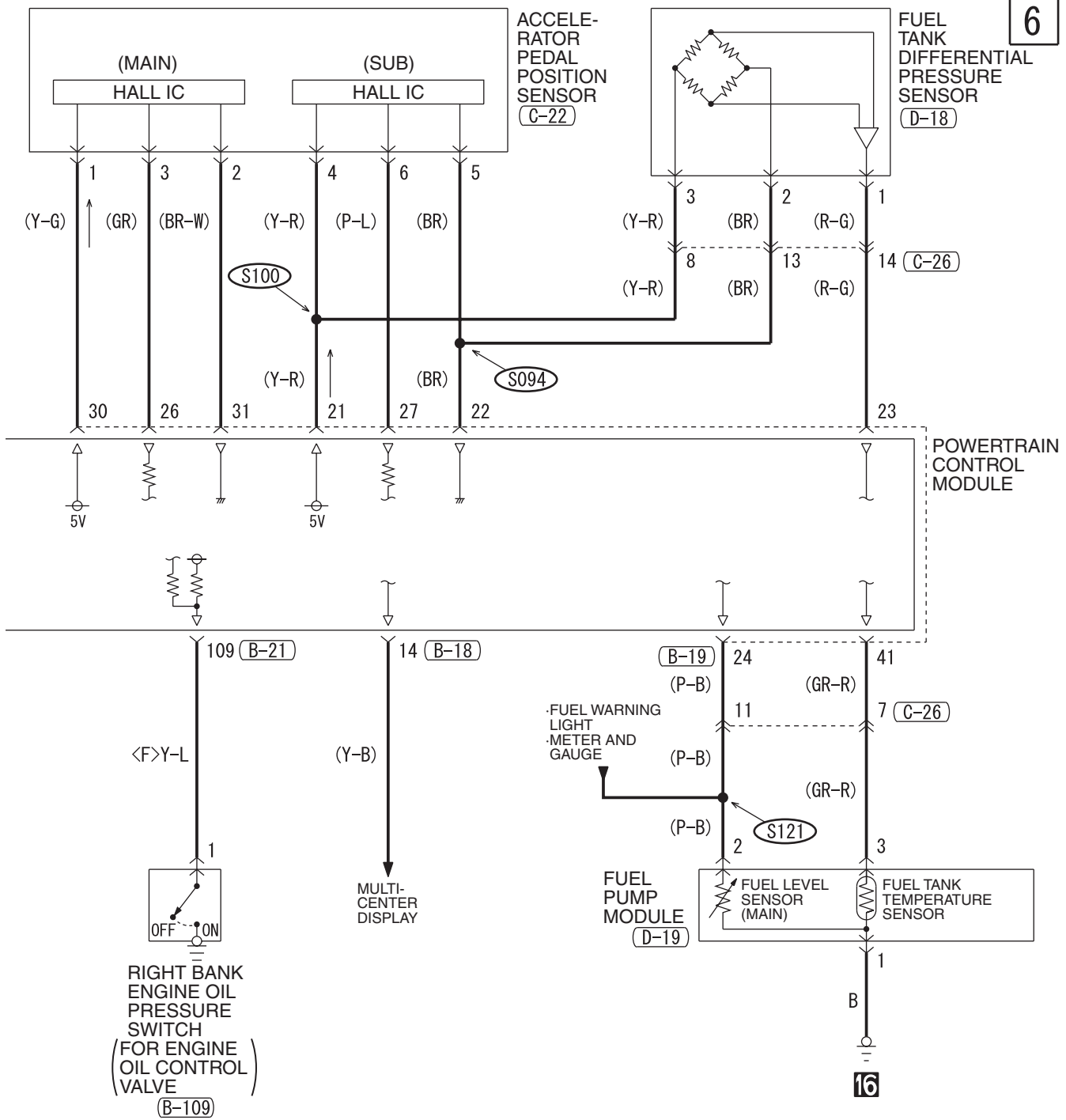

WIRE COLOR CODE
 B : BLACK LG : LIGHT GREEN G : GREEN L : BLUE W : WHITE Y : YELLOW SB : SKY BLUE
 BR : BROWN O : ORANGE GR : GRAY R : RED P : PINK V : VIOLET PU : PURPLE

H6P05M03CB

TSB Revision

MULTIPOINT FUEL INJECTION (MFI) SYSTEM <3.8L ENGINE-A/T> (CONTINUED)

7

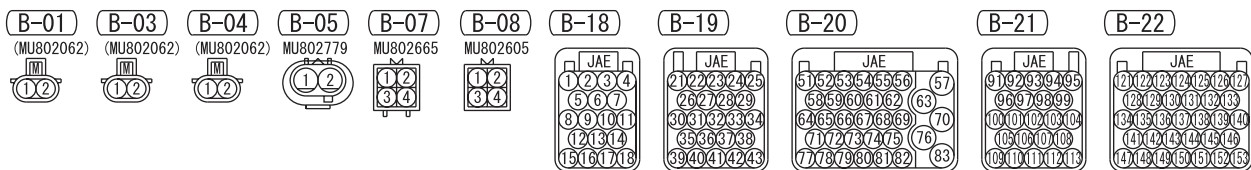
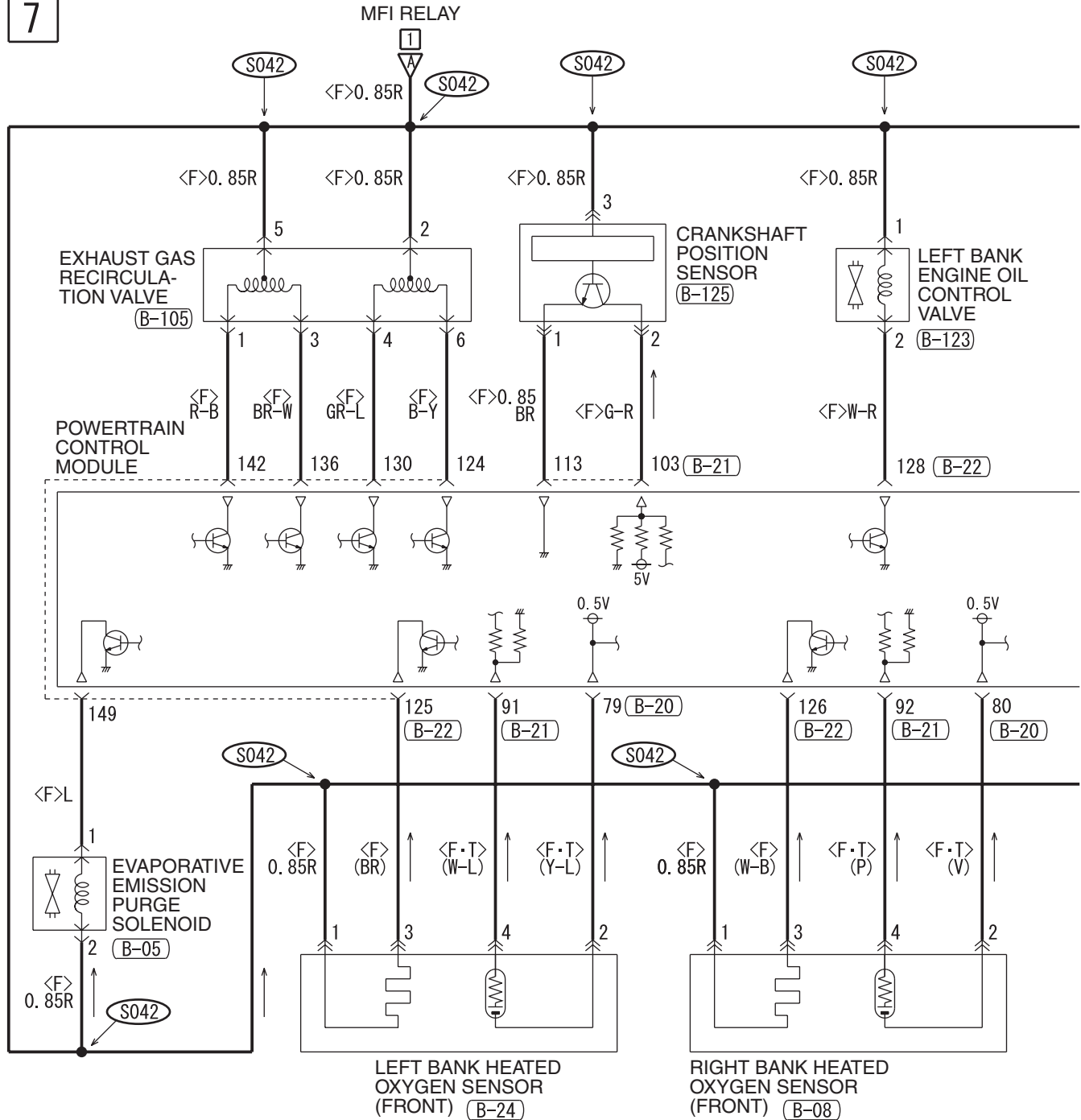

8

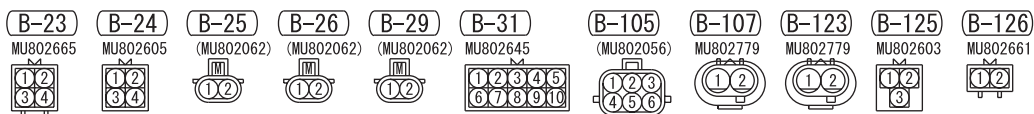
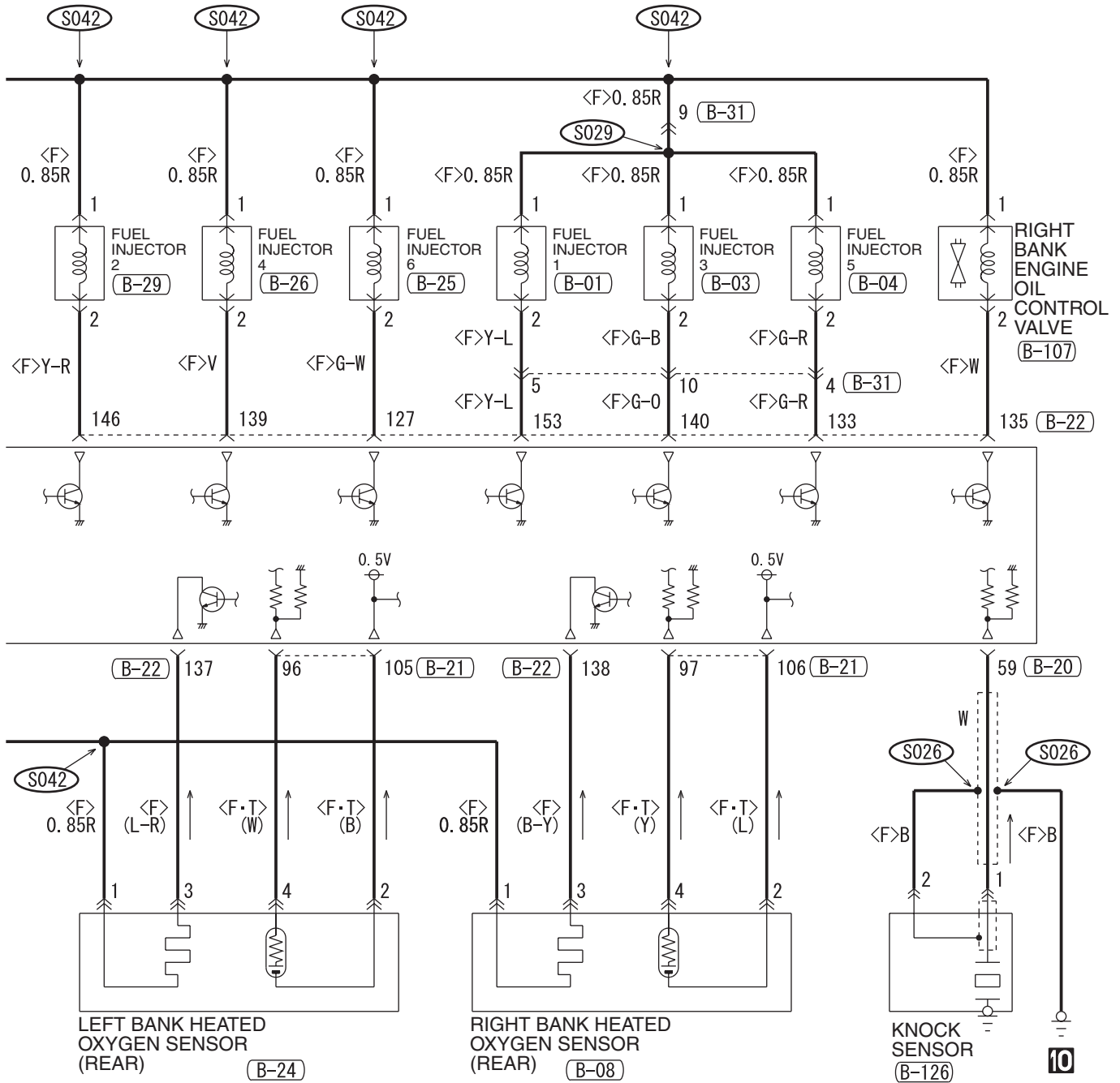

WIRE COLOR CODE
 B : BLACK LG : LIGHT GREEN G : GREEN L : BLUE W : WHITE Y : YELLOW SB : SKY BLUE
 BR : BROWN O : ORANGE GR : GRAY R : RED P : PINK V : VIOLET PU : PURPLE

MULTIPOINT FUEL INJECTION (MFI) SYSTEM <3.8L ENGINE-A/T> (CONTINUED)

9

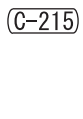
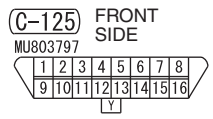
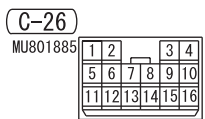
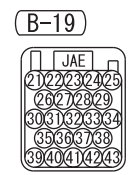
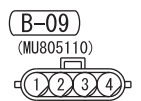
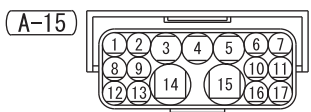
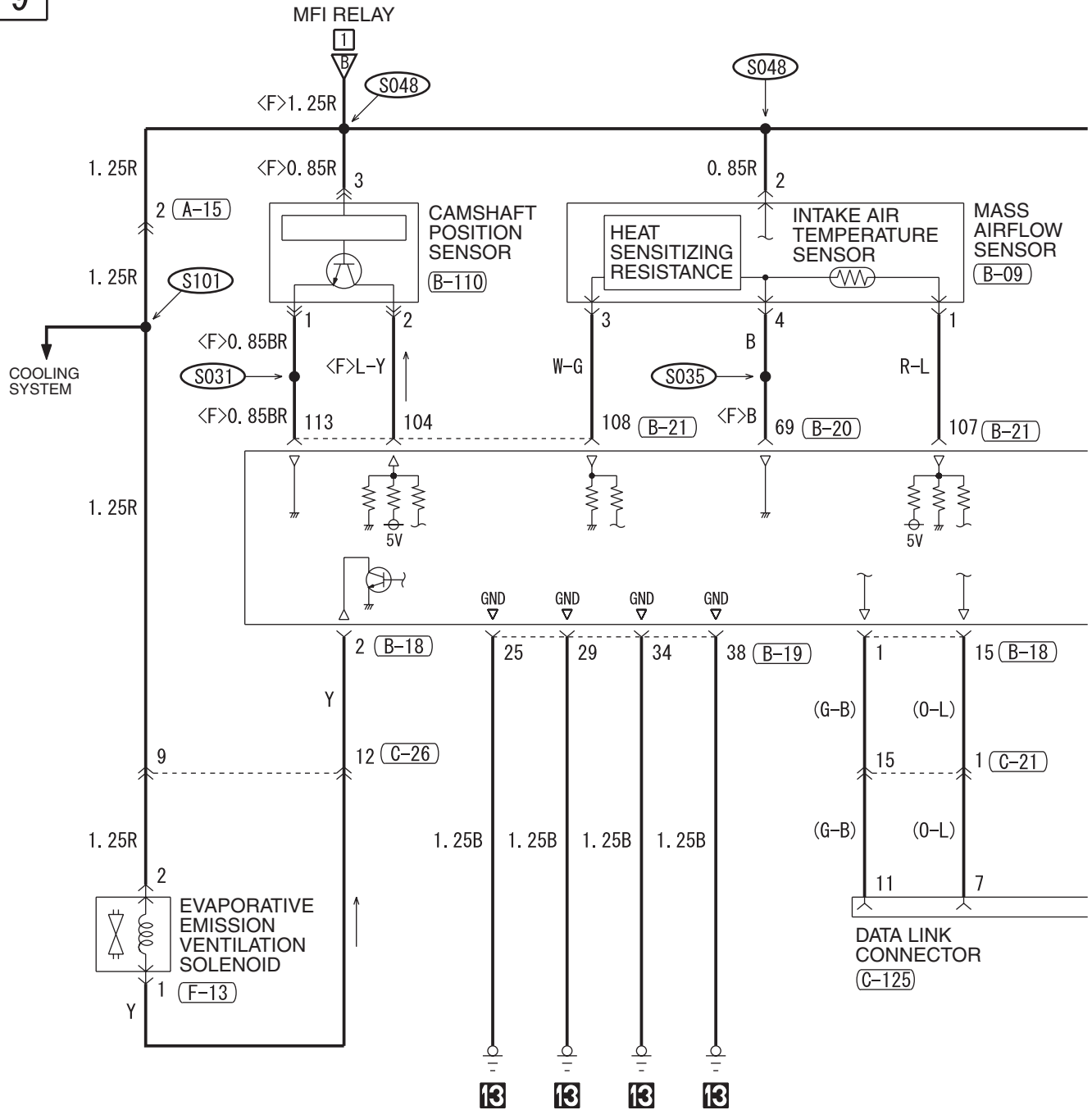

H6P05M03EA

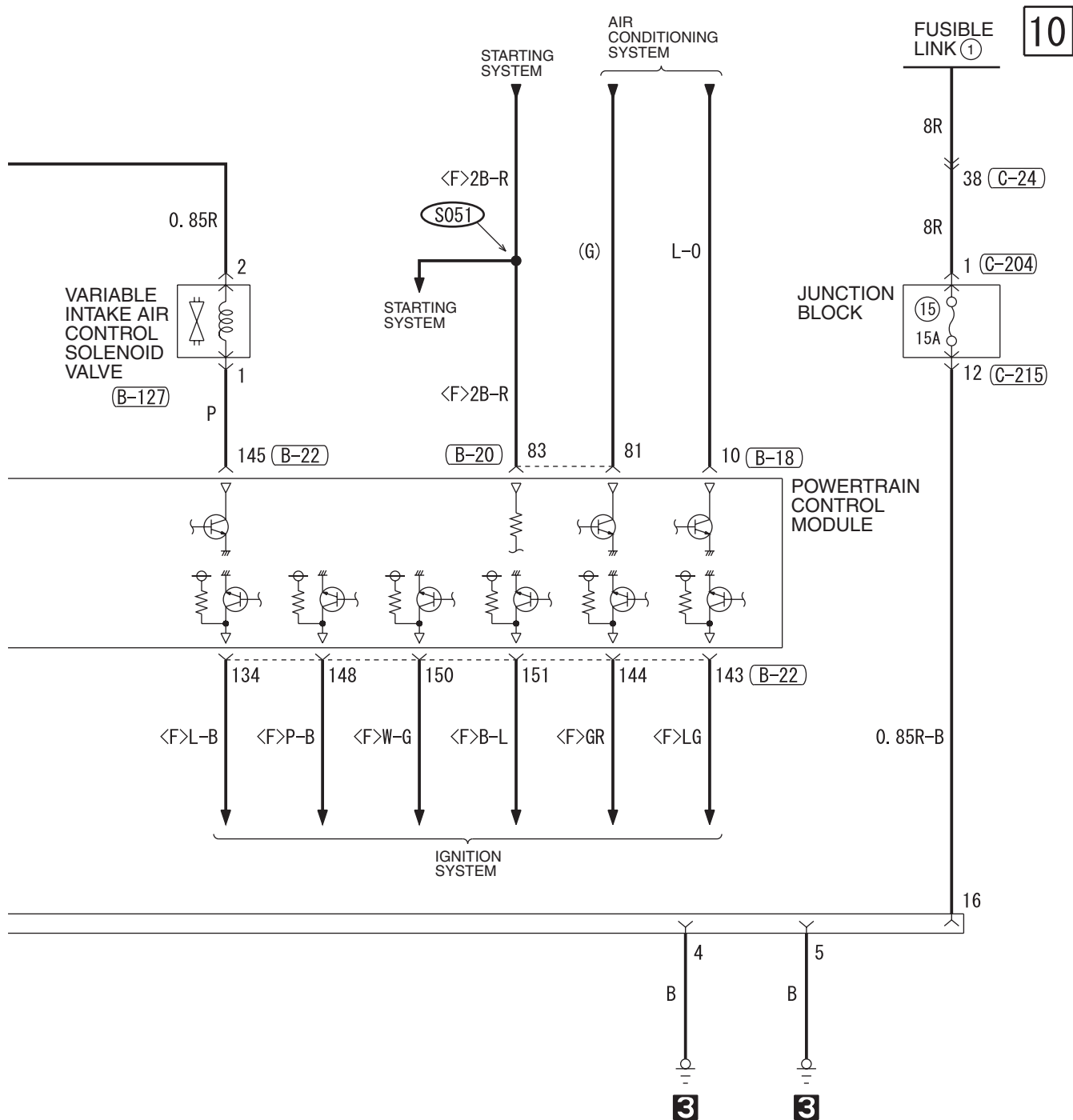

(B-20)

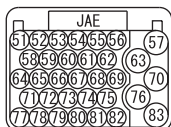

(B-21)



(B-22)

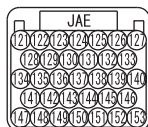

(B-110)



(B-127)



(C-21)

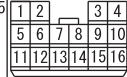

(C-24)

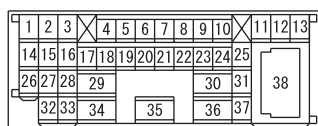

WIRE COLOR CODE

B : BLACK LG : LIGHT GREEN G : GREEN L : BLUE
 BR : BROWN O : ORANGE GR : GRAY R : RED W : WHITE
 SB : SKY BLUE P : PINK Y : YELLOW V : VIOLET PU : PURPLE

H6P05M03EB

COOLING SYSTEM <2.4L ENGINE>

M1901001001468

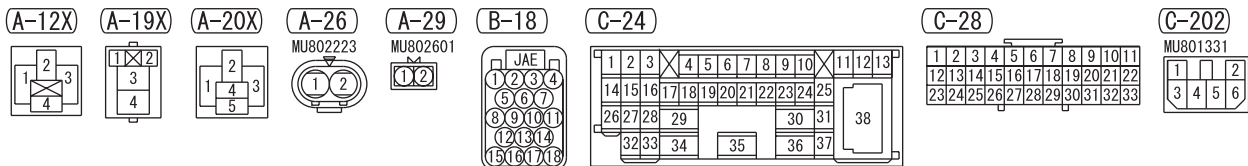
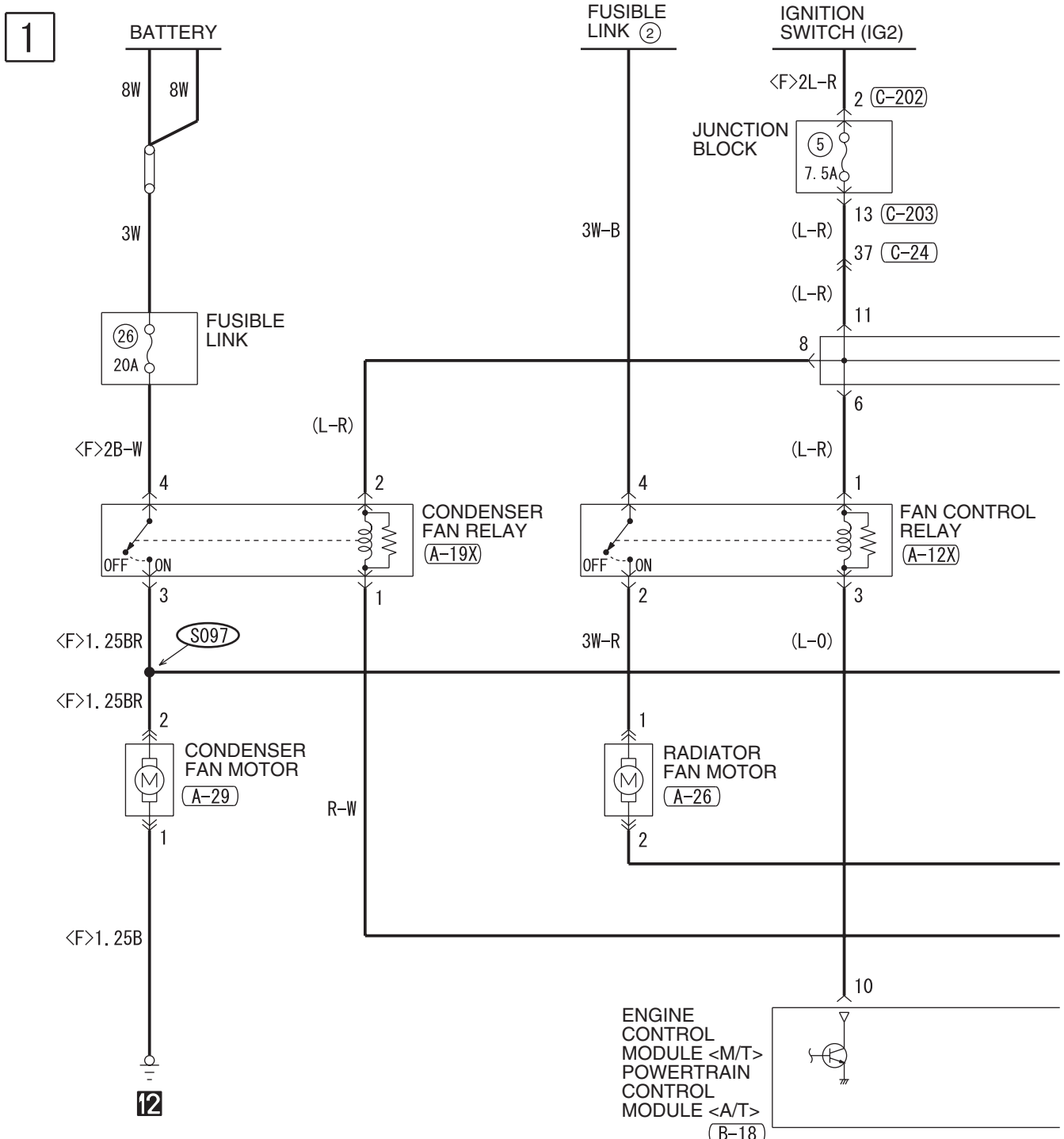

H6P06M00AA

NOTE
*1: M/T
*2: A/T

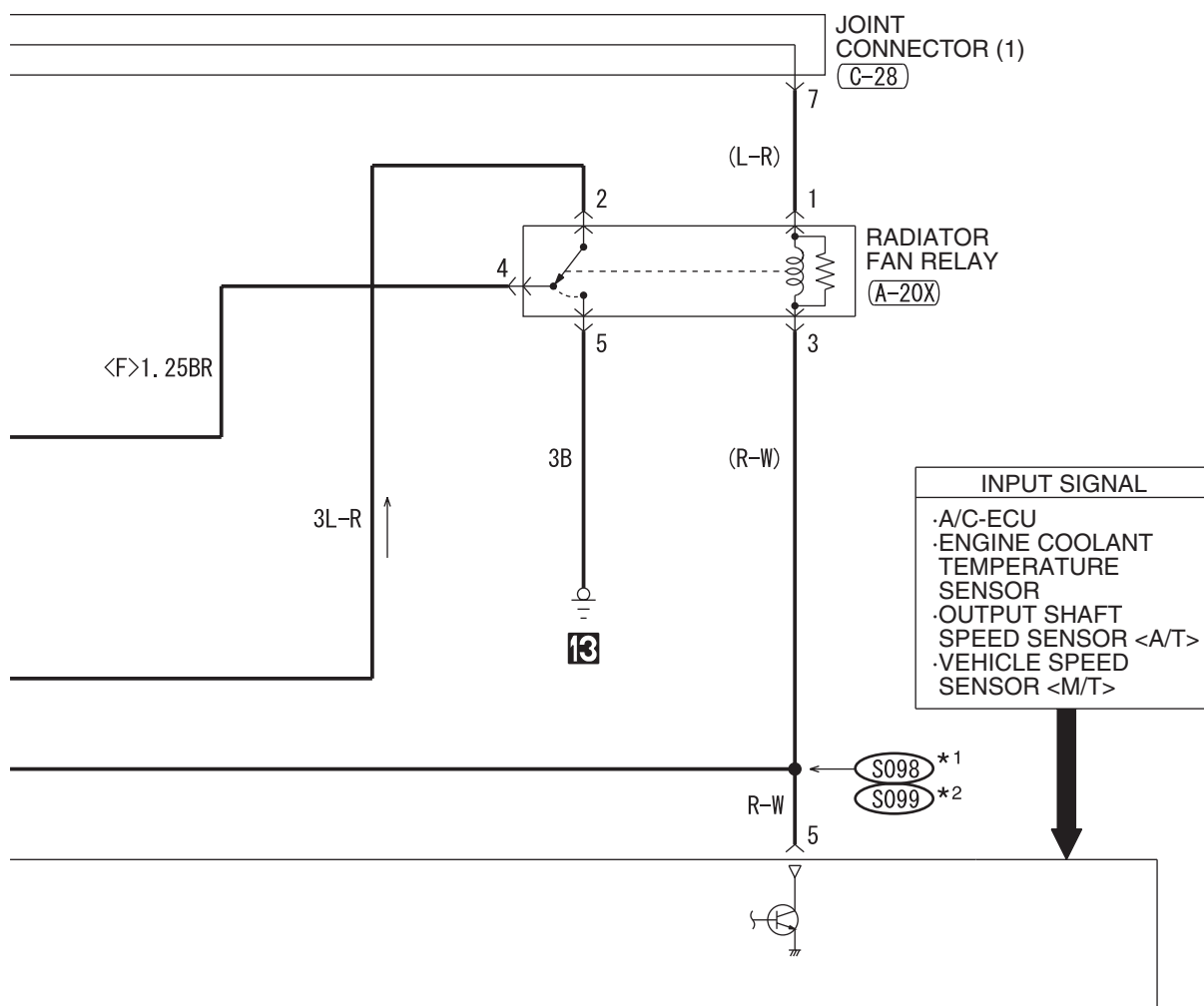

(C-203)

MU801857

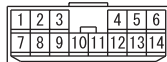

WIRE COLOR CODE

B: BLACK LG: LIGHT GREEN G: GREEN L: BLUE W: WHITE Y: YELLOW SB: SKY BLUE
BR: BROWN O: ORANGE GR: GRAY R: RED P: PINK V: VIOLET PU: PURPLE

H6P06M00AB

COOLING SYSTEM <3.8L ENGINE>

M1901001001479

1

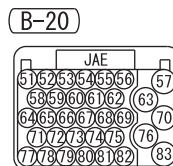
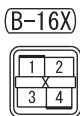
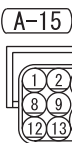
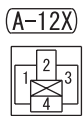
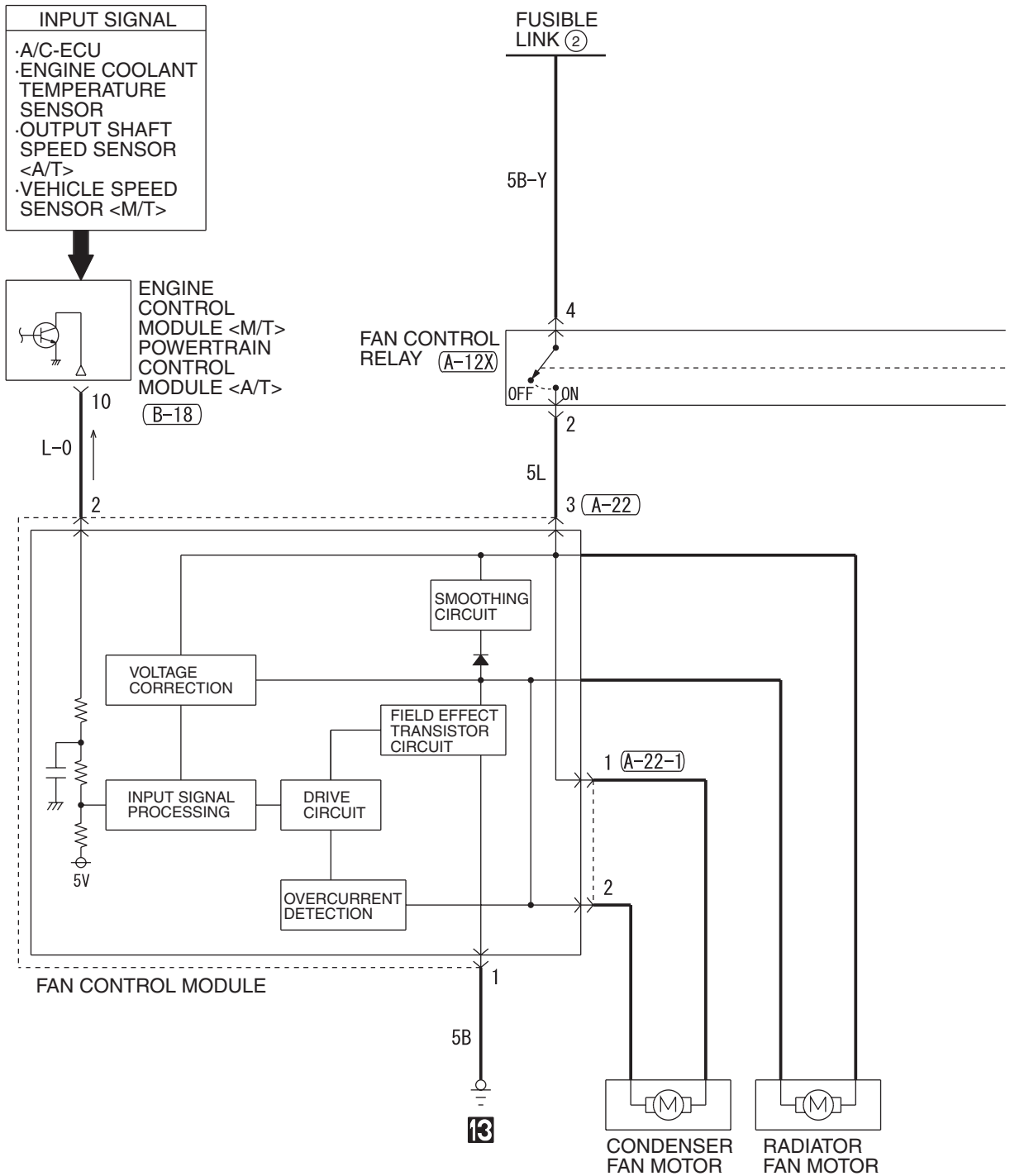

2

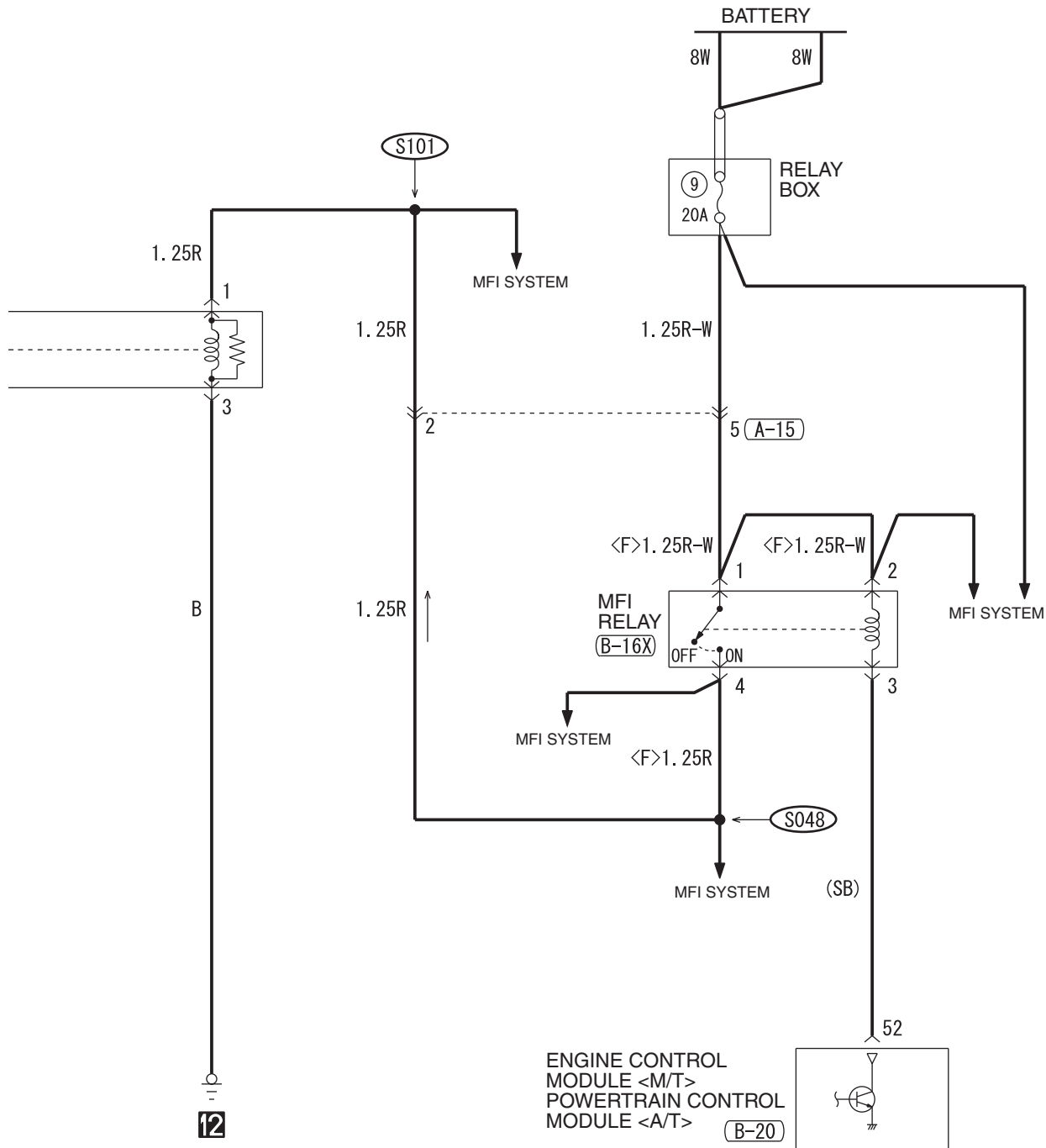

WIRE COLOR CODE
 B : BLACK LG : LIGHT GREEN G : GREEN L : BLUE W : WHITE Y : YELLOW SB : SKY BLUE
 BR : BROWN O : ORANGE GR : GRAY R : RED P : PINK V : VIOLET PU : PURPLE

H6P06M01AB

TSB Revision

INVECS-II 4A/T <2.4L ENGINE>

M1901016201770

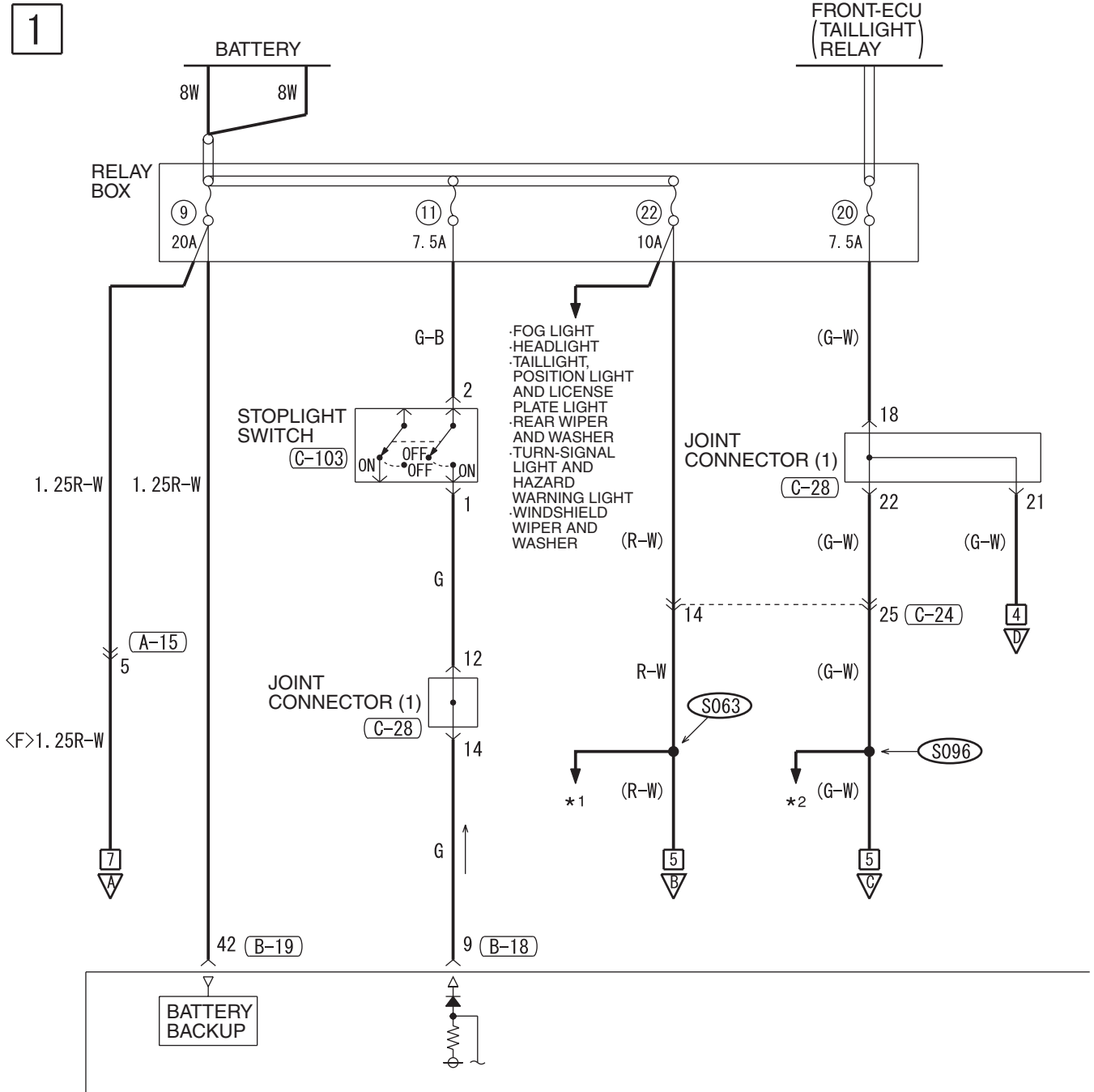

(A-15)

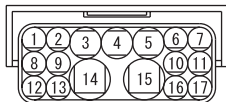

(B-18)

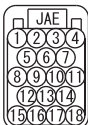

(B-19)

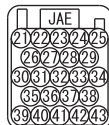

(B-21)

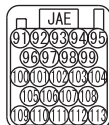

(B-108)



(B-112)



(C-01)

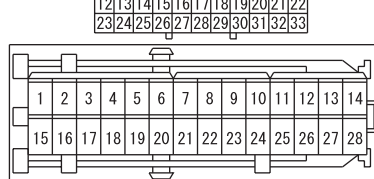

H6P07M00AA

2

NOTE

- *1: -AUDIO SYSTEM
 - CONTROLLER AREA NETWORK (CAN)
 - FOG LIGHT
 - FRONT DOME LIGHT, REAR DOME LIGHT, LUGGAGE COMPARTMENT LIGHT AND IGNITION KEY HOLE ILLUMINATION LIGHT
 - HEADLIGHT
 - MANUAL AIR CONDITIONING SYSTEM
 - MULTI-CENTER DISPLAY
 - REAR WIPER AND WASHER
 - TAILLIGHT, POSITION LIGHT AND LICENSE PLATE LIGHT
 - TURN-SIGNAL LIGHT AND HAZARD WARNING LIGHT
 - VANITY MIRROR LIGHT
 - WINDSHIELD WIPER AND WASHER
- *2: -AUDIO SYSTEM
 - FOG LIGHT
 - GLOVE BOX LIGHT
 - HEATED SEAT
 - MANUAL AIR CONDITIONING SYSTEM
 - MULTI-CENTER DISPLAY
 - REAR WINDOW DEFOGGER AND DOOR MIRROR HEATER
 - SUPPLEMENTAL RESISTANT SYSTEM (SRS)
 - TURN-SIGNAL LIGHT AND HAZARD WARNING LIGHT

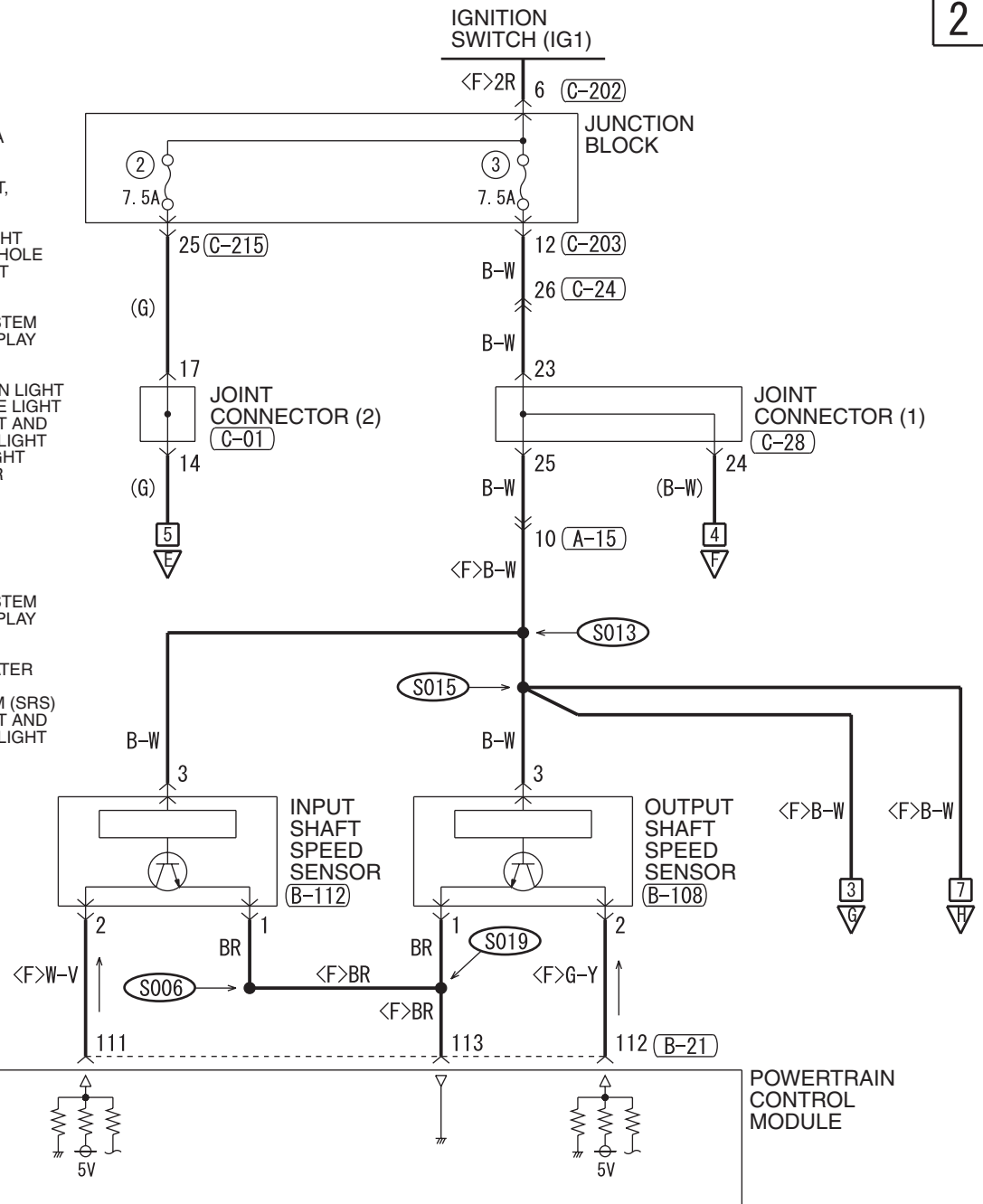

(C-24)

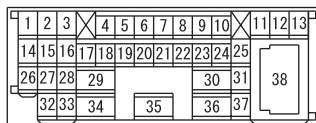

(C-28)



(C-103)



(C-202)



(C-203)



WIRE COLOR CODE

B: BLACK LG: LIGHT GREEN G: GREEN L: BLUE
BR: BROWN O: ORANGE GR: GRAY R: RED W: WHITE
SB: SKY BLUE P: PINK Y: YELLOW V: VIOLET PU: PURPLE H6P07M00AB

INVECS-II 4A/T <2.4L ENGINE> (CONTINUED)

3

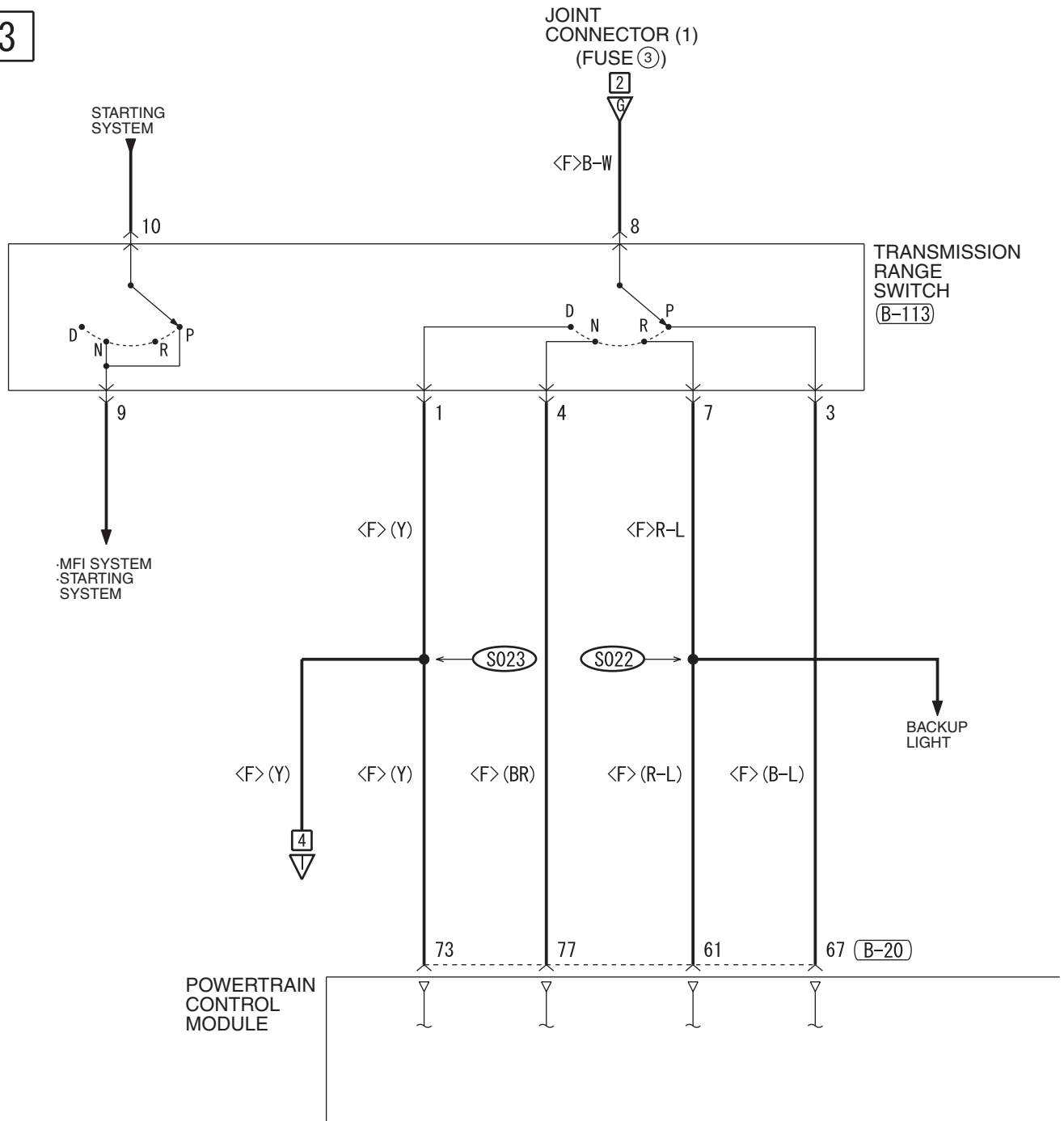

(A-15)

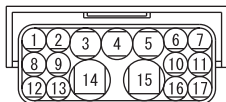

(B-19)

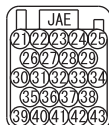

(B-20)

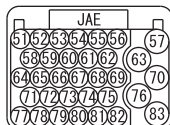

(B-113)

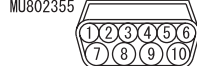

(C-17)



(C-21)

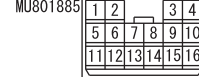

4

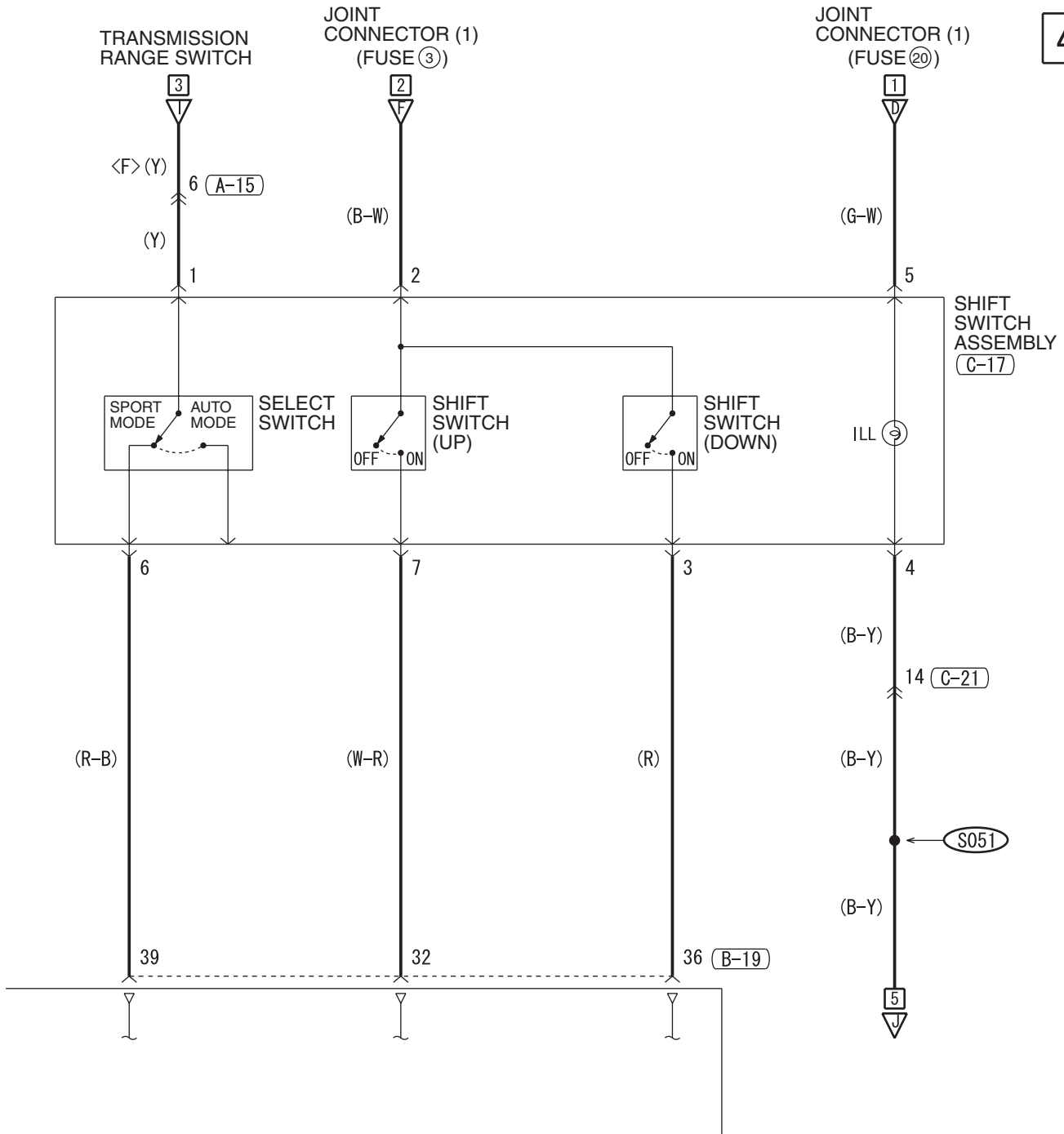

WIRE COLOR CODE
 B : BLACK LG : LIGHT GREEN G : GREEN L : BLUE W : WHITE Y : YELLOW SB : SKY BLUE
 BR : BROWN O : ORANGE GR : GRAY R : RED P : PINK V : VIOLET PU : PURPLE

H6P07M00BB

TSB Revision

INVECS-II 4A/T <2.4L ENGINE> (CONTINUED)

5

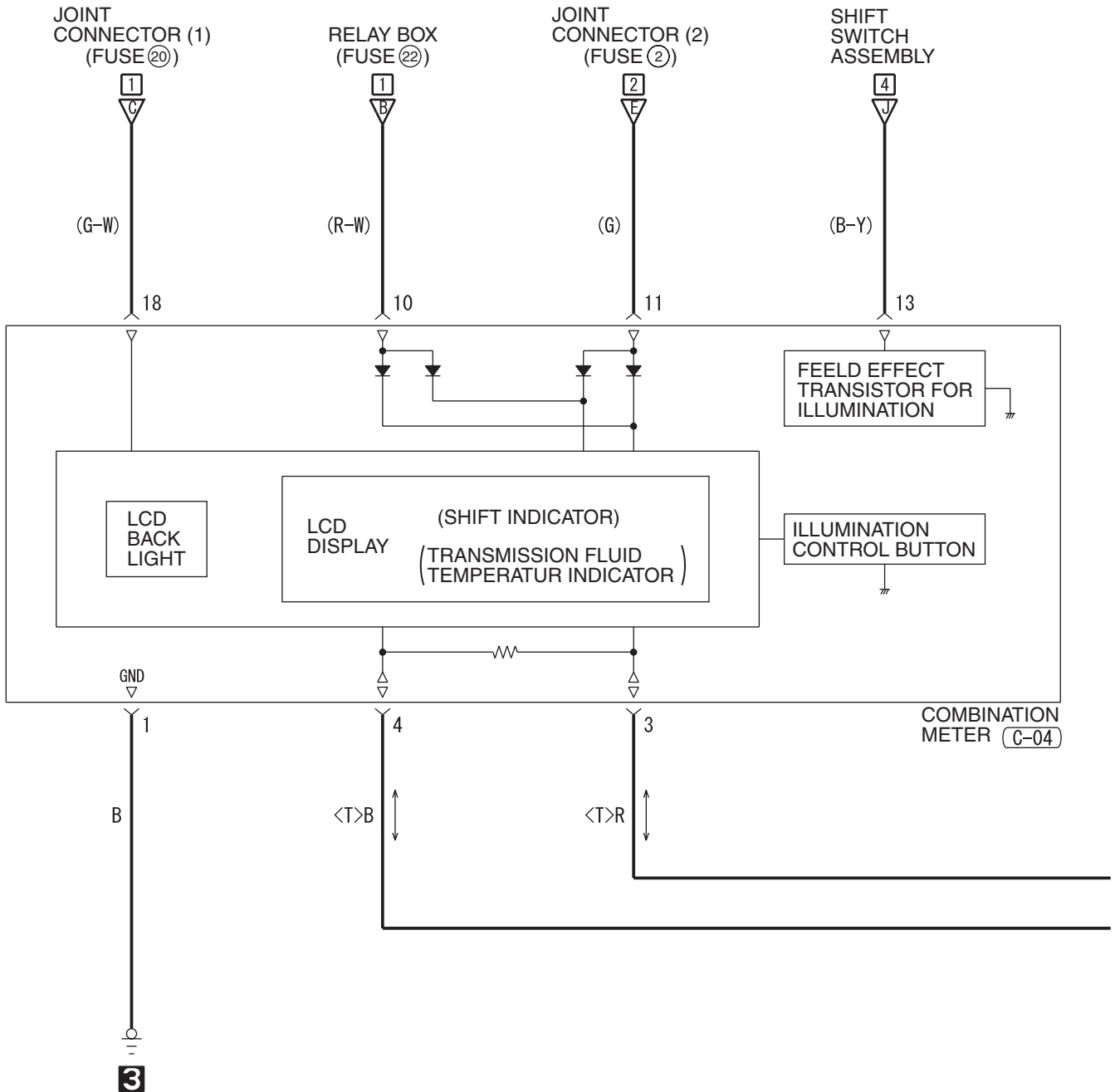

(A-02)



(B-18)

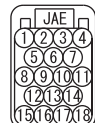

(C-03)

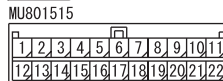

(C-04)

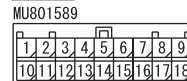

(C-24)

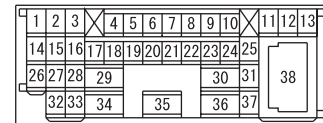

6

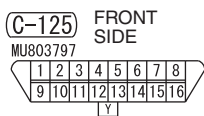
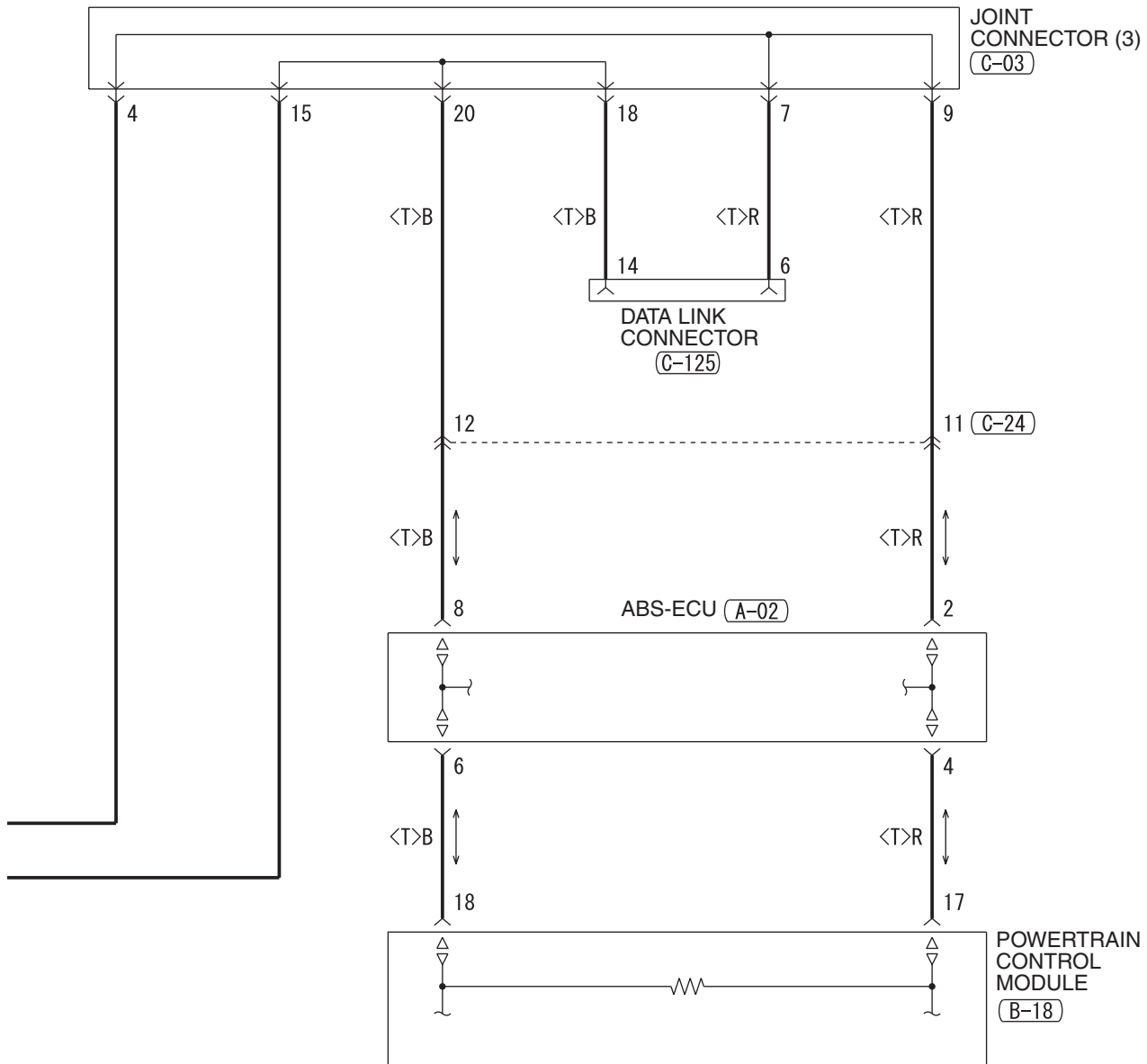

WIRE COLOR CODE
 B : BLACK LG : LIGHT GREEN G : GREEN L : BLUE W : WHITE Y : YELLOW SB : SKY BLUE
 BR : BROWN O : ORANGE GR : GRAY R : RED P : PINK V : VIOLET PU : PURPLE

H6P07M00CB

TSB Revision

INVECS-II 4A/T <2.4L ENGINE> (CONTINUED)

7

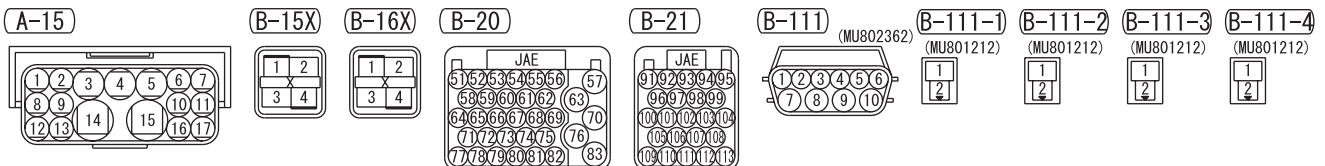
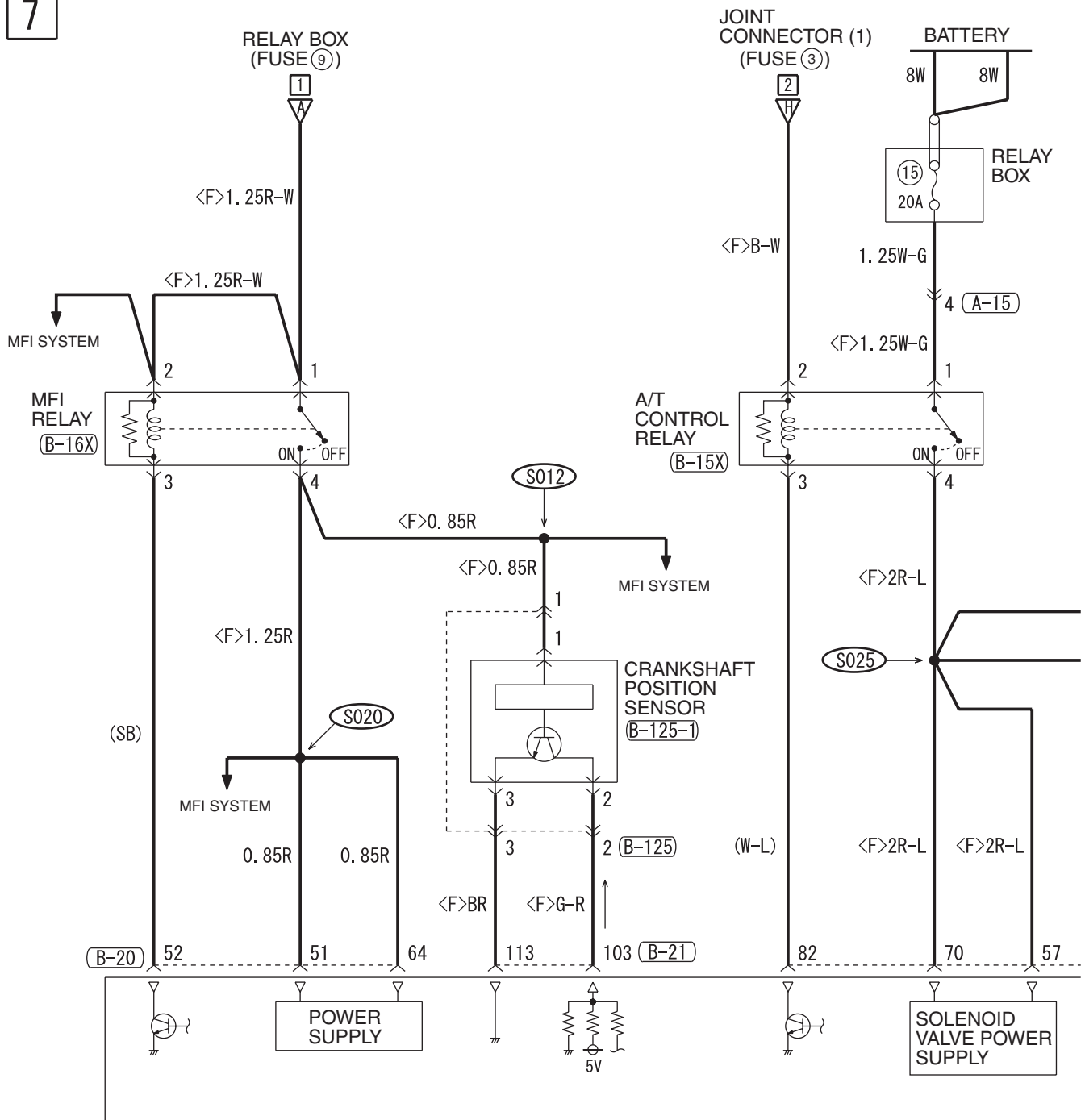

8

- NOTE
- *1: UNDERDRIVE SOLENOID VALVE
 - *2: SECOND SOLENOID VALVE
 - *3: OVERDRIVE SOLENOID VALVE
 - *4: TORQUE CONVERTER CLUTCH CONTROL SOLENOID VALVE
 - *5: LOW AND REVERSE SOLENOID VALVE

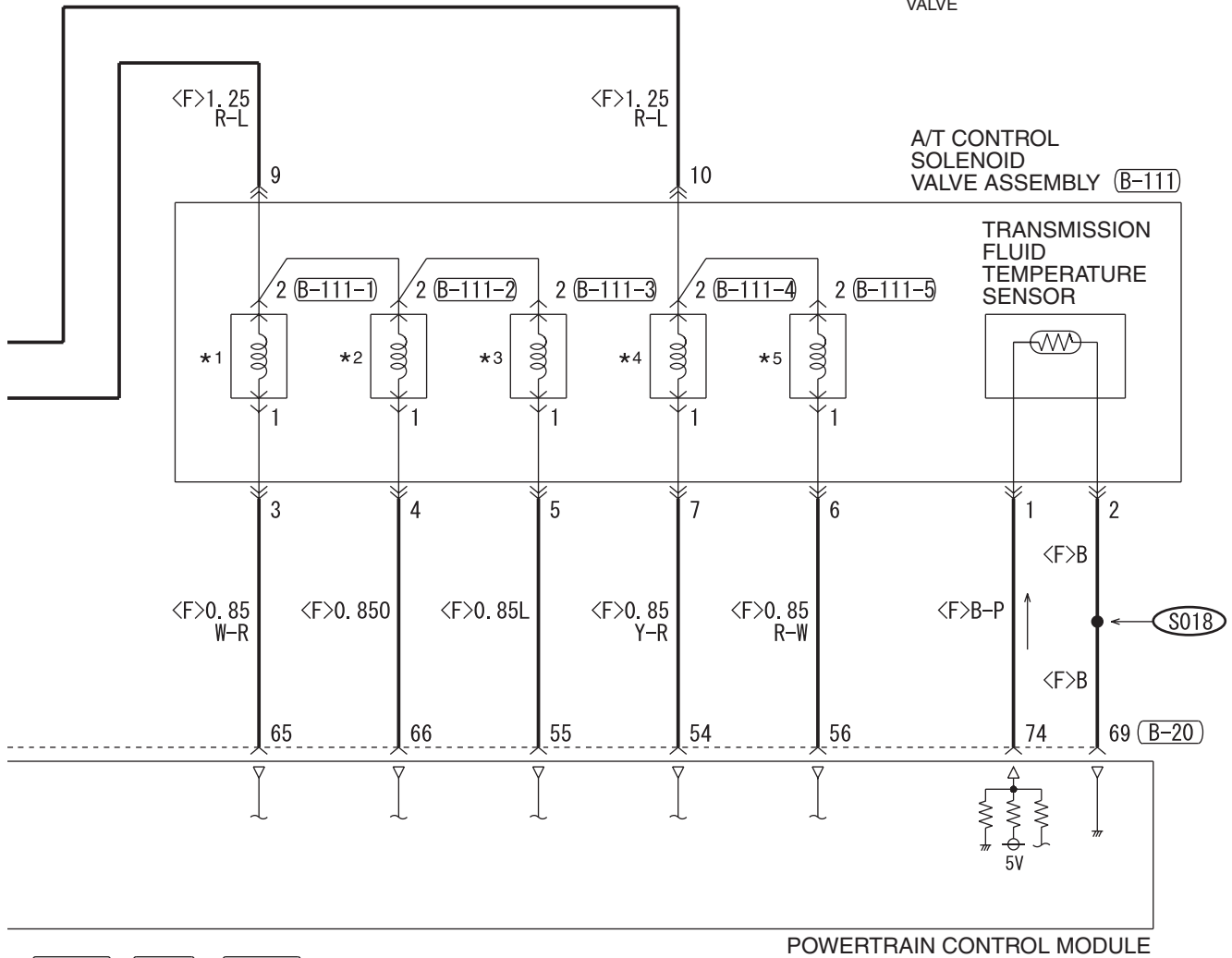

WIRE COLOR CODE

B: BLACK LG: LIGHT GREEN G: GREEN L: BLUE W: WHITE Y: YELLOW SB: SKY BLUE
 BR: BROWN O: ORANGE GR: GRAY R: RED P: PINK V: VIOLET PU: PURPLE

H6P07M00DB

TSB Revision

INVECS-II 4A/T <2.4L ENGINE> (CONTINUED)

9

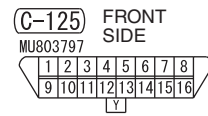
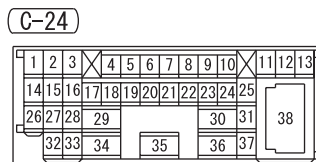
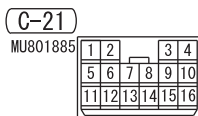
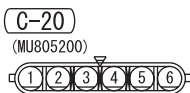
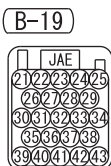
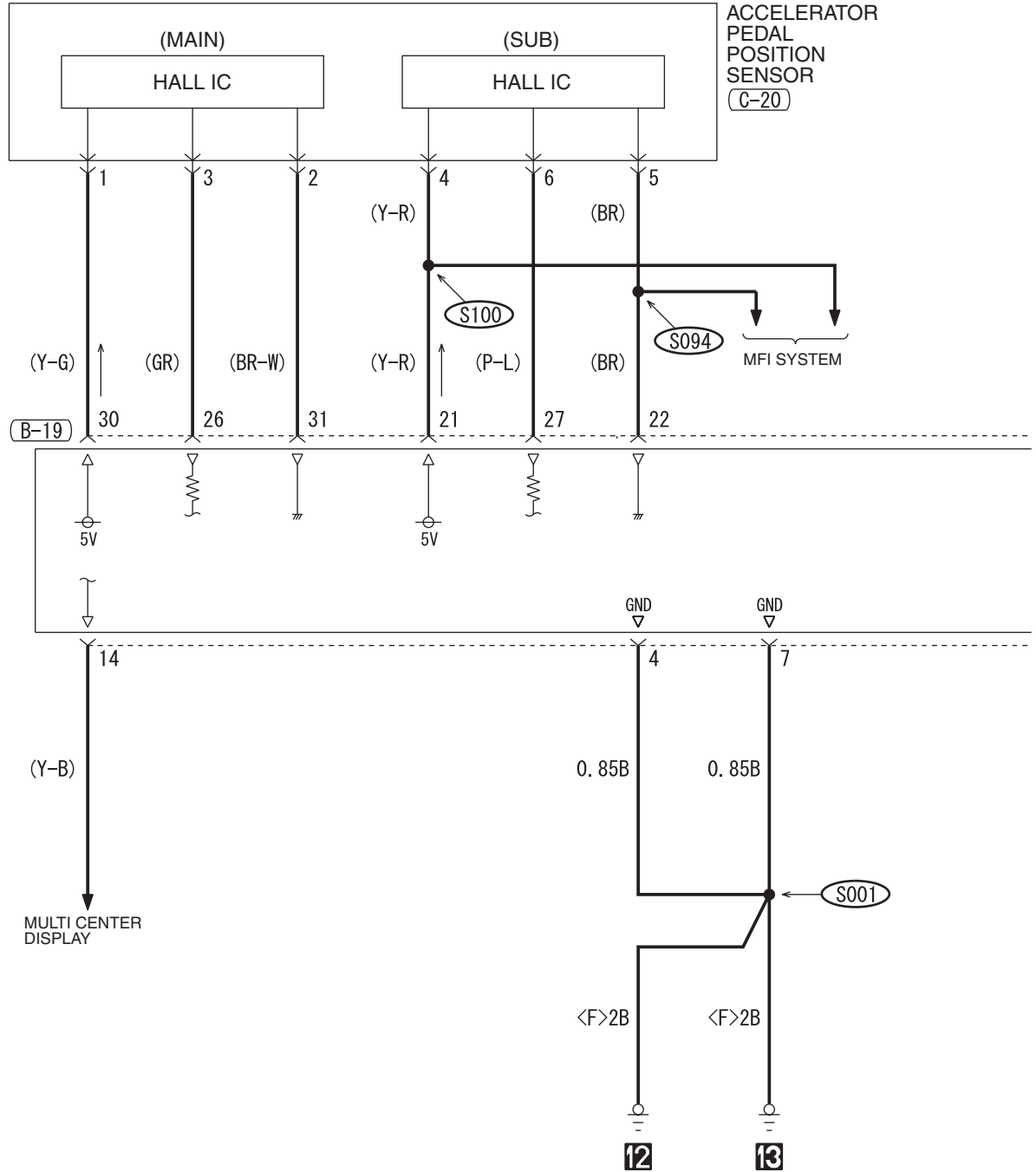

10

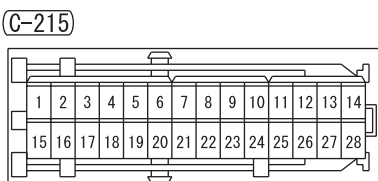
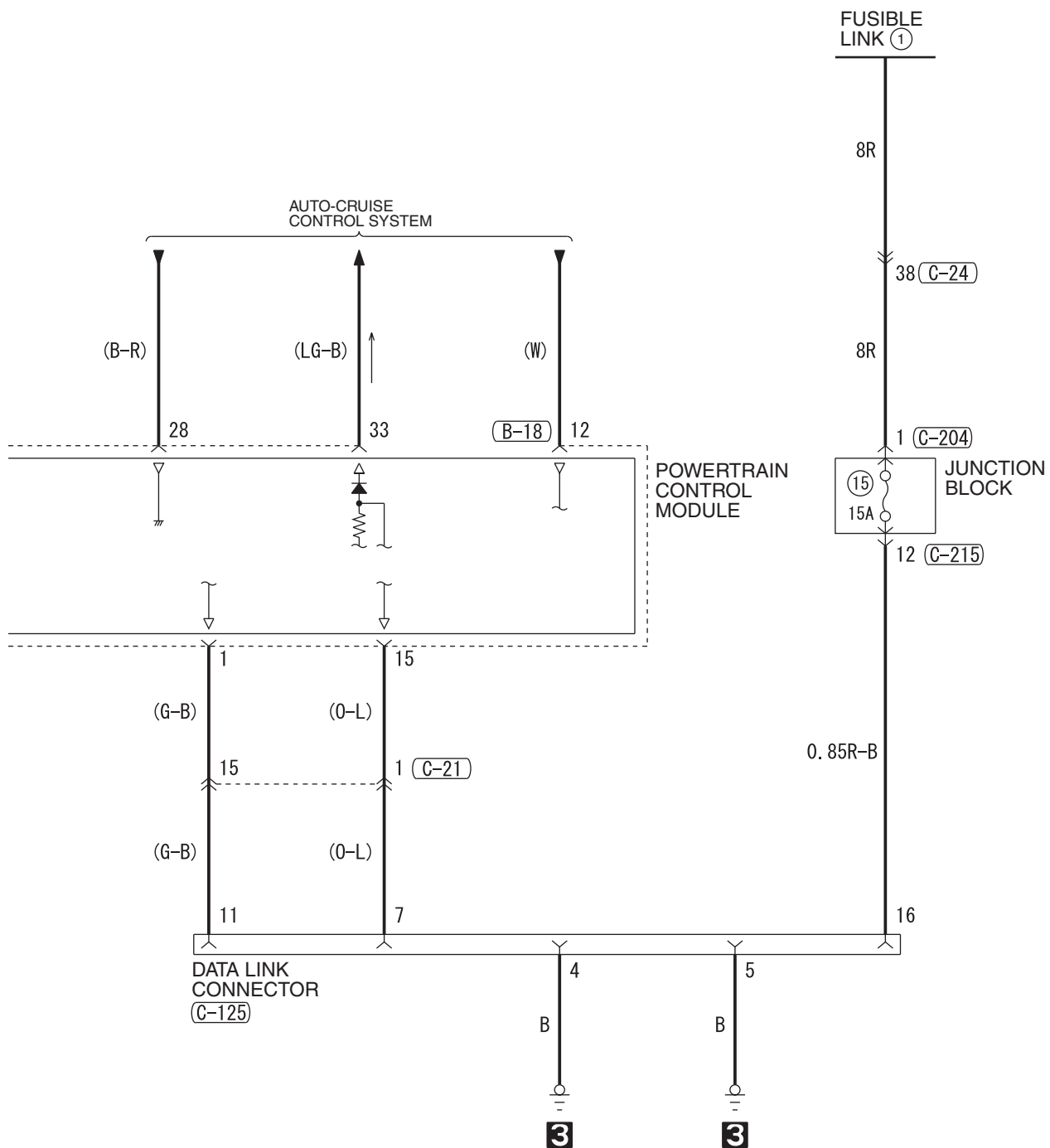

WIRE COLOR CODE
 B : BLACK LG : LIGHT GREEN G : GREEN L : BLUE
 BR : BROWN O : ORANGE GR : GRAY R : RED W : WHITE
 SB : SKY BLUE P : PINK Y : YELLOW V : VIOLET PU : PURPLE

H6P07M00EB

INVECS-II 5A/T <3.8L ENGINE>

M1901016300183

1

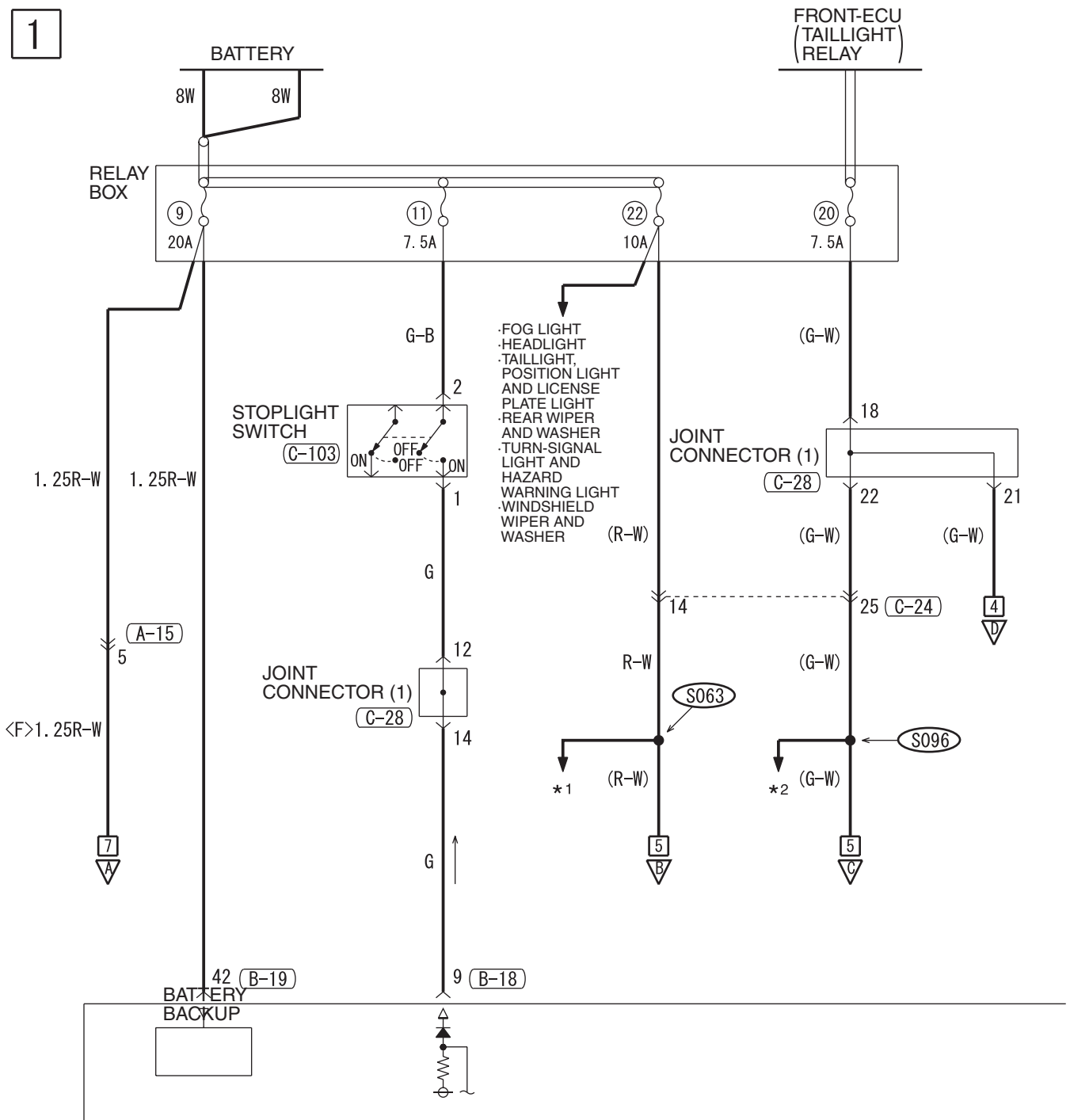

(A-15)

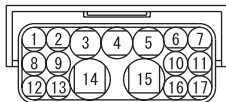

(B-18)

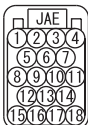

(B-19)

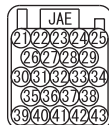

(B-21)



(B-108)



(B-112)



(C-01)

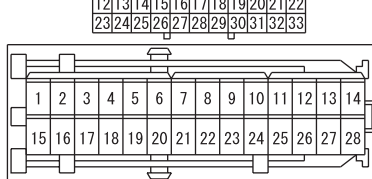

H6P07M01AA

NOTE

- *1: .AUDIO SYSTEM
.AUTOMATIC AIR
CONDITIONING SYSTEM
.CONTROLLER AREA
NETWORK (CAN)
.FOG LIGHT
.FRONT DOME LIGHT,
REAR DOME LIGHT,
LUGGAGE
COMPARTMENT LIGHT
AND IGNITION KEY HOLE
ILLUMINATION LIGHT
.HEADLIGHT
.MANUAL AIR
CONDITIONING SYSTEM
.MULTI-CENTER DISPLAY
.REAR WIPER
AND WASHER
.TAILLIGHT, POSITION LIGHT
AND LICENSE PLATE LIGHT
.TURN-SIGNAL LIGHT AND
HAZARD WARNING LIGHT
.VANITY MIRROR LIGHT
.WINDSHIELD WIPER
AND WASHER

- *2: .AUDIO SYSTEM
.AUTOMATIC AIR
CONDITIONING SYSTEM
.ELECTRONIC BRAKE-
FORCE DISTRIBUTION
(EBD) AND ANTI-LOCK
BRAKING SYSTEM (ABS)
<VEHICLES WITH
TRACTION CONTROL
SYSTEM (TCL)>
.FOG LIGHT
.GLOVE BOX LIGHT
.HEATED SEAT
.MANUAL AIR
CONDITIONING SYSTEM
.MULTI-CENTER DISPLAY
.REAR WINDOW DEFOGGER
AND DOOR MIRROR HEATER
.SUPPLEMENTAL
RESISTANT SYSTEM (SRS)
.TURN-SIGNAL LIGHT AND
HAZARD WARNING LIGHT

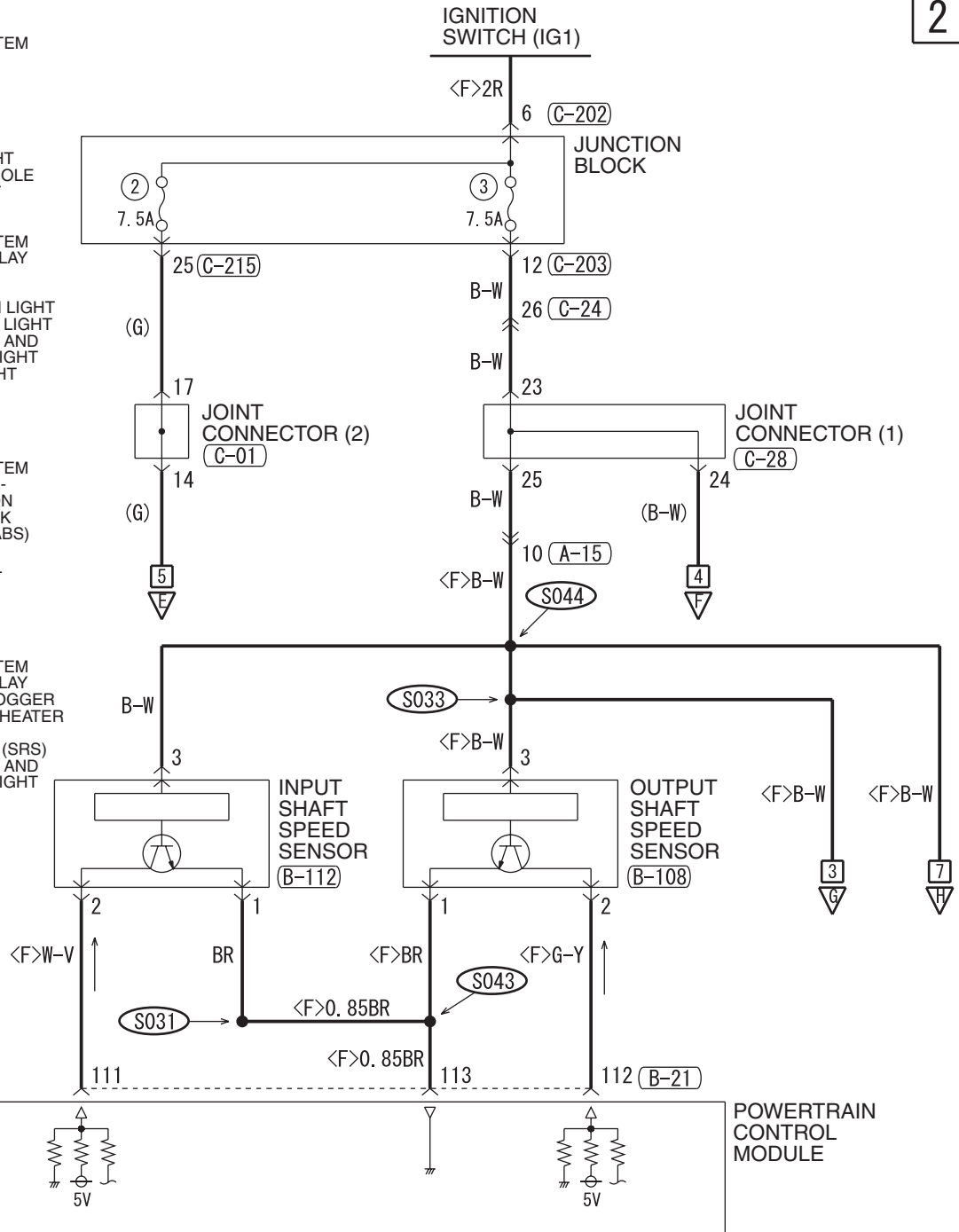

(C-24)

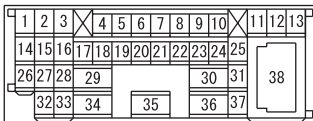

(C-28)



(C-103)



(C-202)



(C-203)



WIRE COLOR CODE

B: BLACK LG: LIGHT GREEN G: GREEN L: BLUE
BR: BROWN O: ORANGE GR: GRAY R: RED W: WHITE
SB: SKY BLUE P: PINK Y: YELLOW V: VIOLET PU: PURPLE

H6P07M01AB

INVECS-II 5A/T <3.8L ENGINE> (CONTINUED)

3

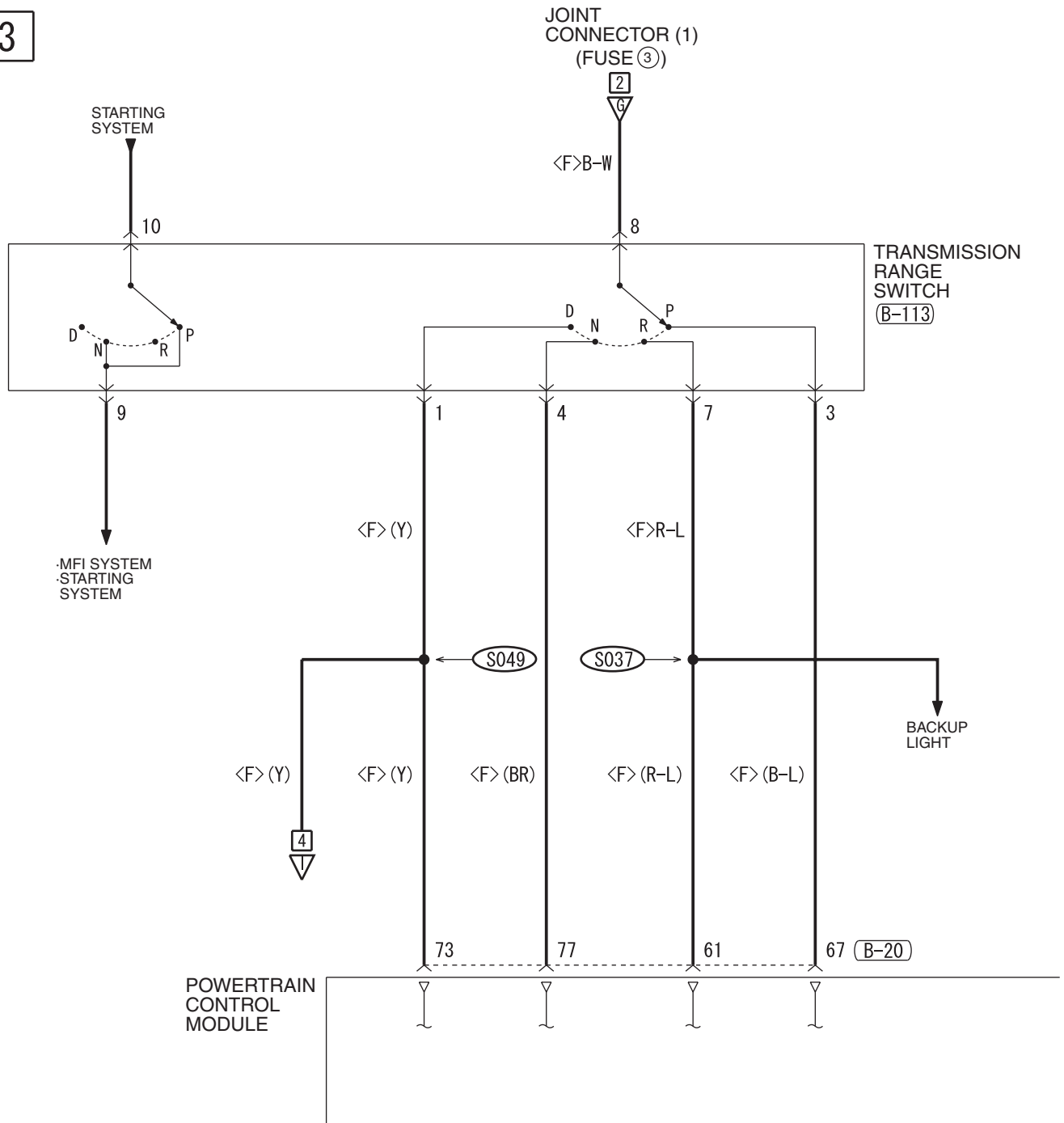

(A-15)

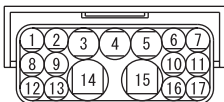

(B-19)

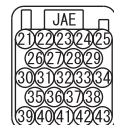

(B-20)

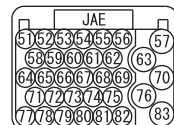

(B-113)

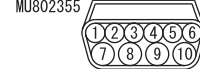

(C-17)

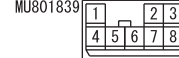

(C-21)



4

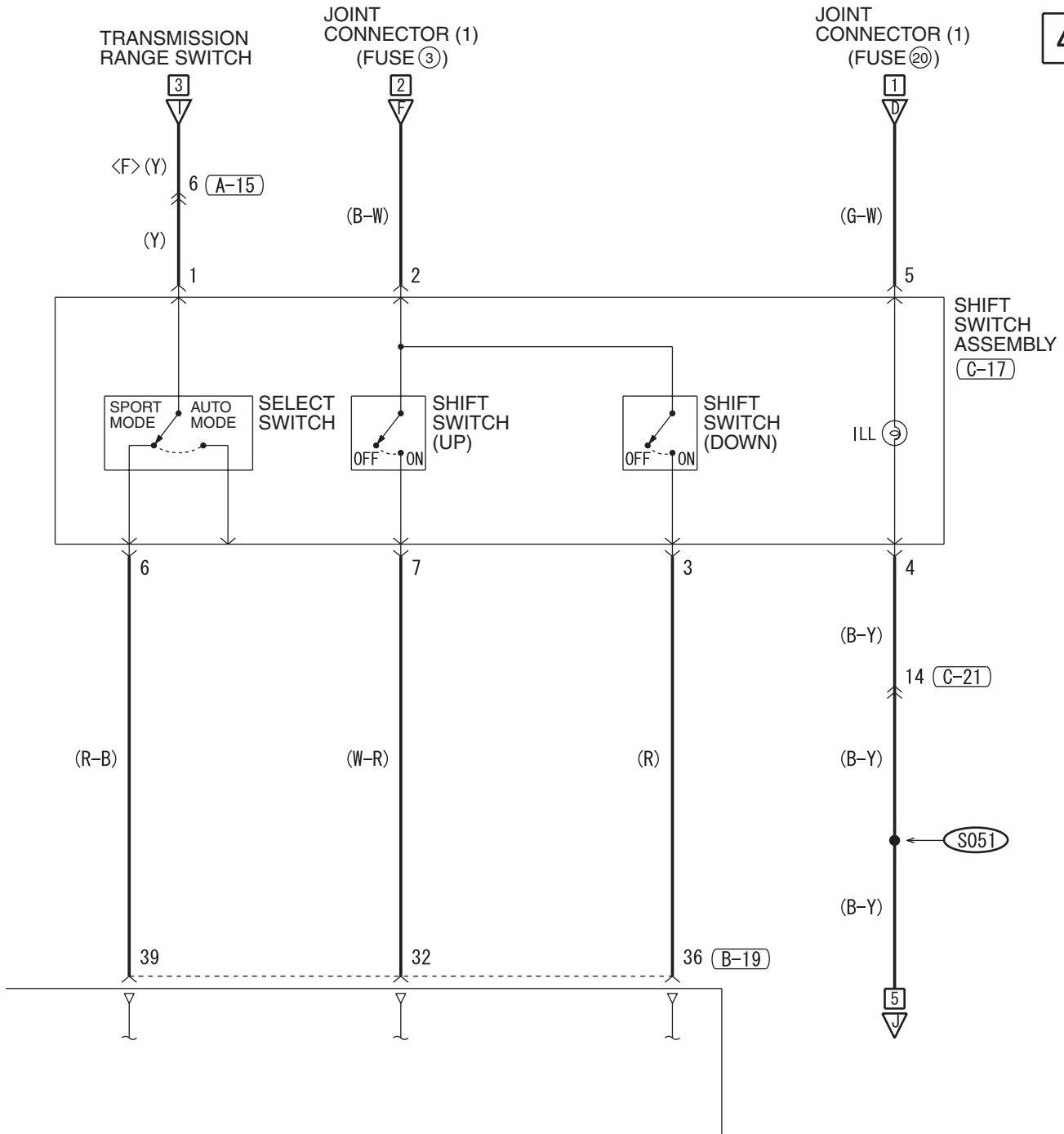

WIRE COLOR CODE
 B : BLACK LG : LIGHT GREEN G : GREEN L : BLUE W : WHITE Y : YELLOW SB : SKY BLUE
 BR : BROWN O : ORANGE GR : GRAY R : RED P : PINK V : VIOLET PU : PURPLE

H6P07M01BB

TSB Revision

INVECS-II 5A/T <3.8L ENGINE> (CONTINUED)

5

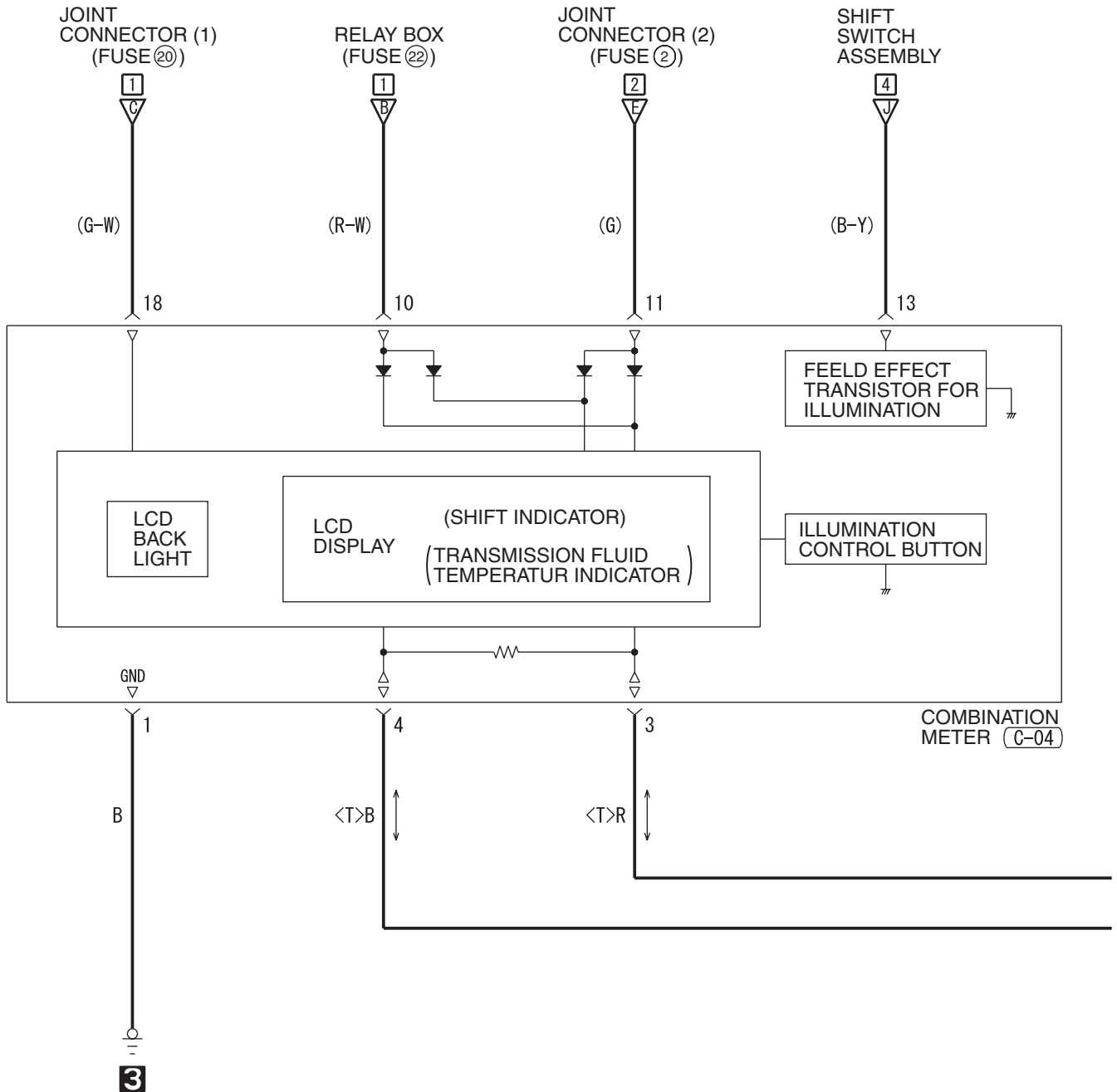

A-03

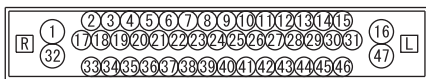

B-18

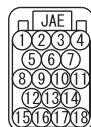

C-03

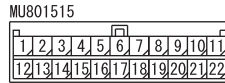

C-04

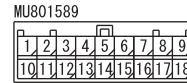

C-24

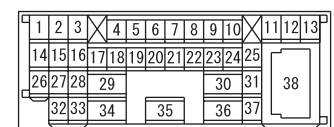

6

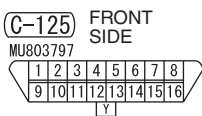
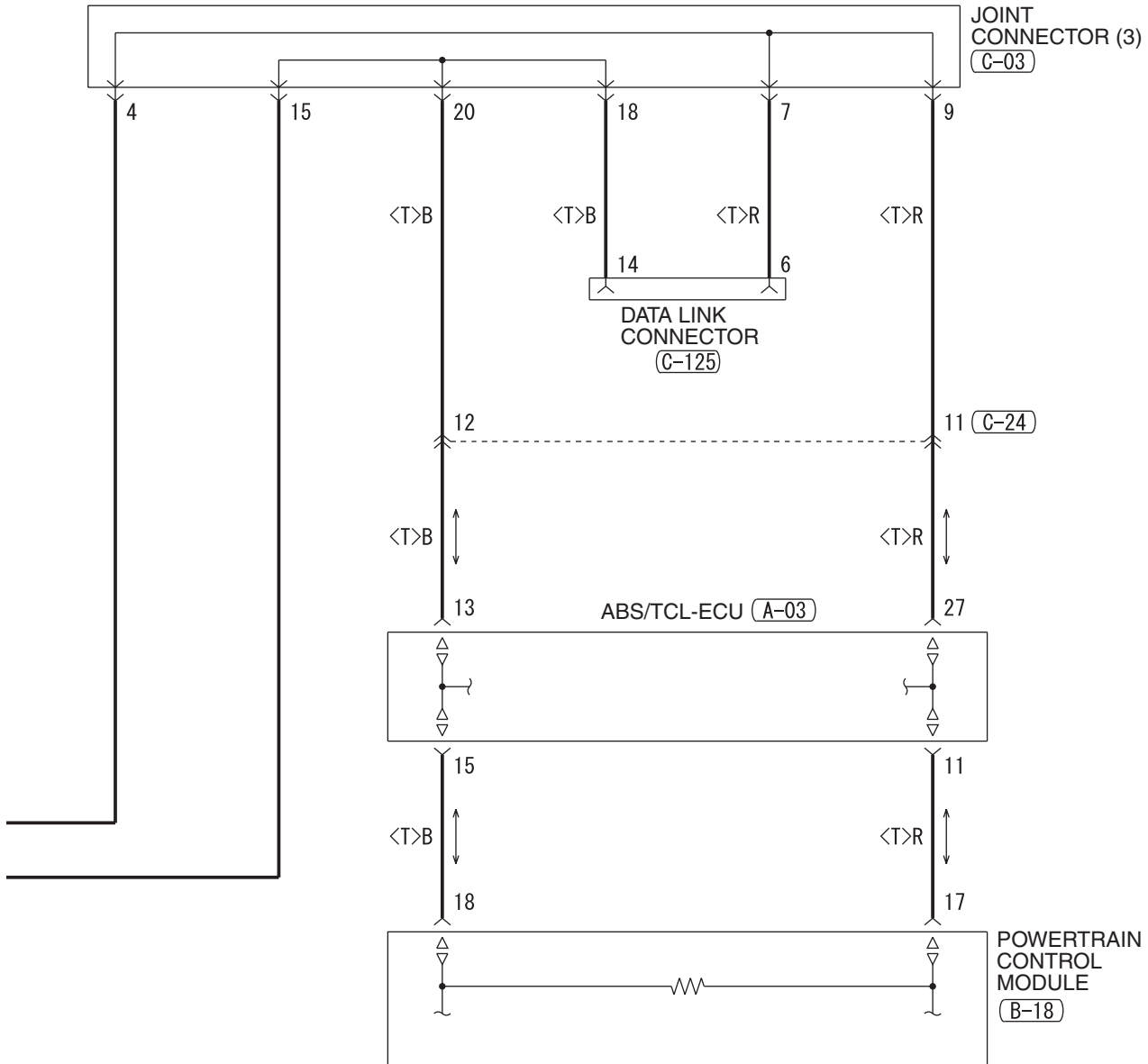

WIRE COLOR CODE
 B : BLACK LG : LIGHT GREEN G : GREEN L : BLUE W : WHITE Y : YELLOW SB : SKY BLUE
 BR : BROWN O : ORANGE GR : GRAY R : RED P : PINK V : VIOLET PU : PURPLE

H6P07M01CB

TSB Revision

INVECS-II 5A/T <3.8L ENGINE> (CONTINUED)

7

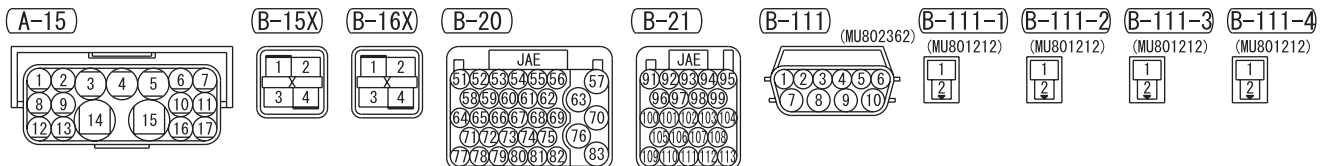
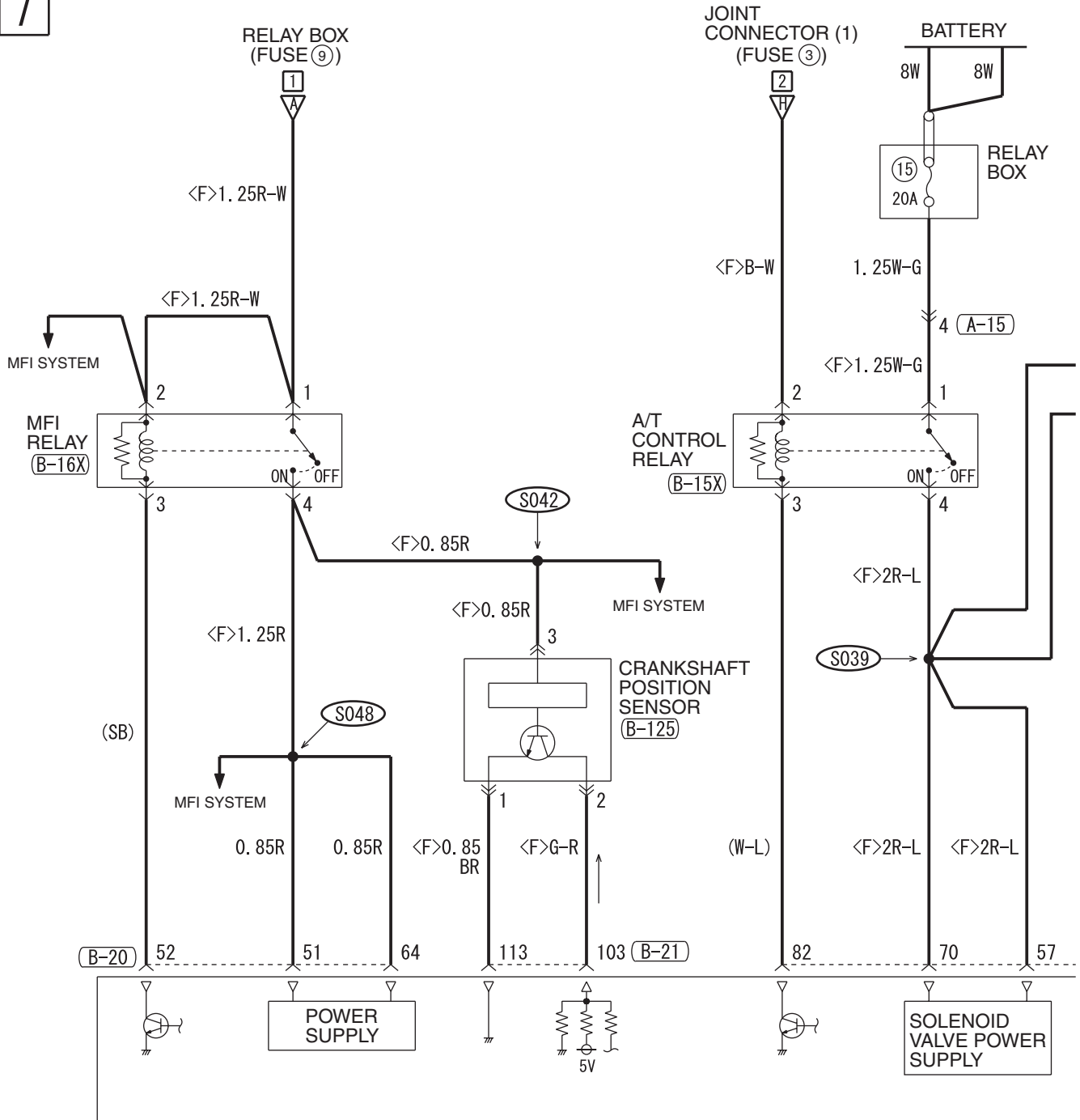

8

- NOTE
- *1: UNDERDRIVE SOLENOID VALVE
 - *2: SECOND SOLENOID VALVE
 - *3: OVERDRIVE SOLENOID VALVE
 - *4: TORQUE CONVERTER CLUTCH CONTROL SOLENOID VALVE
 - *5: LOW AND REVERSE SOLENOID VALVE
 - *6: REDUCTION SOLENOID VALVE

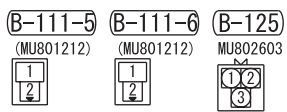
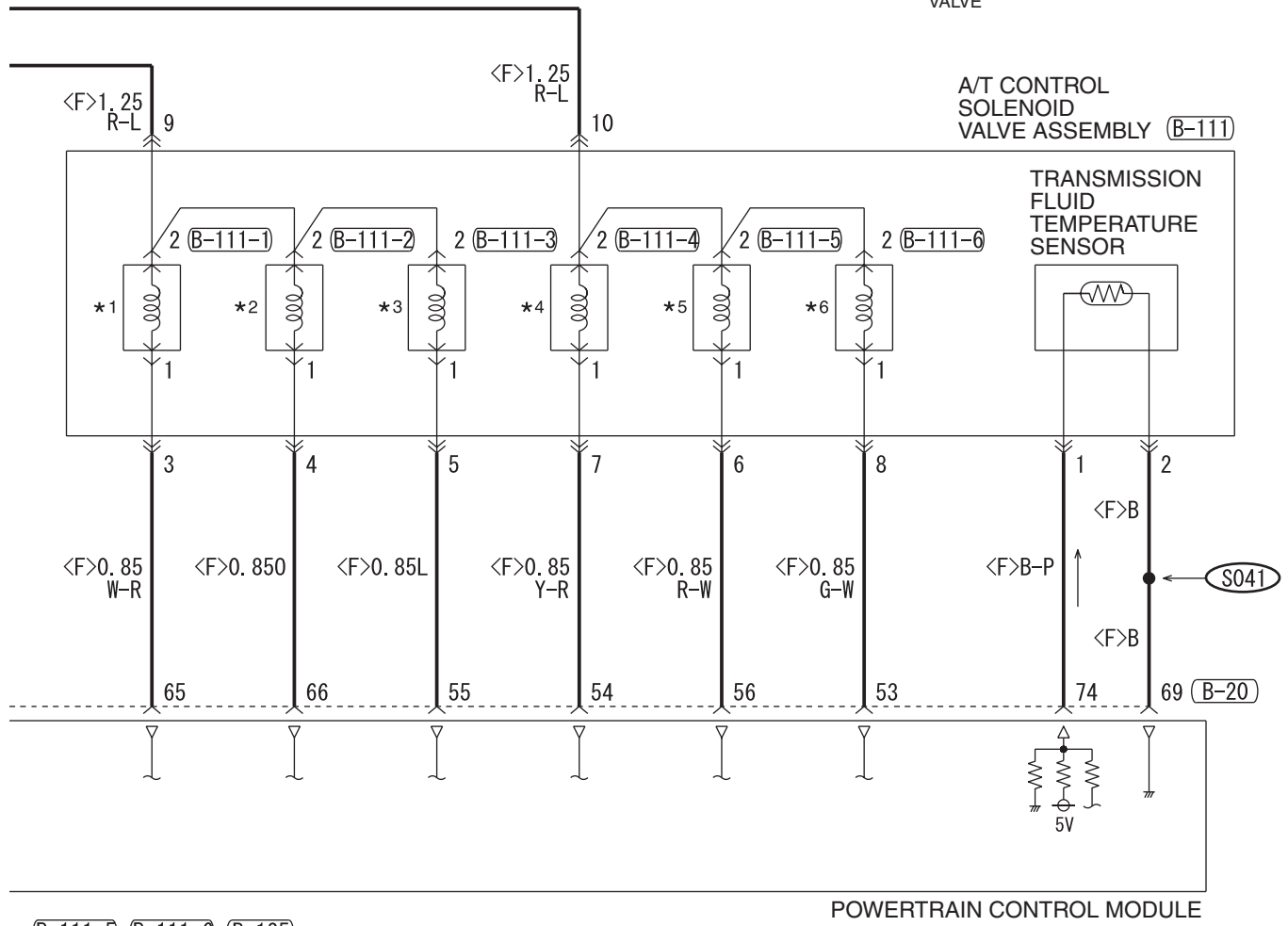

WIRE COLOR CODE
 B: BLACK LG: LIGHT GREEN G: GREEN L: BLUE W: WHITE Y: YELLOW SB: SKY BLUE
 BR: BROWN O: ORANGE GR: GRAY R: RED P: PINK V: VIOLET PU: PURPLE

H6P07M01DB

INVECS-II 5A/T <3.8L ENGINE> (CONTINUED)

9

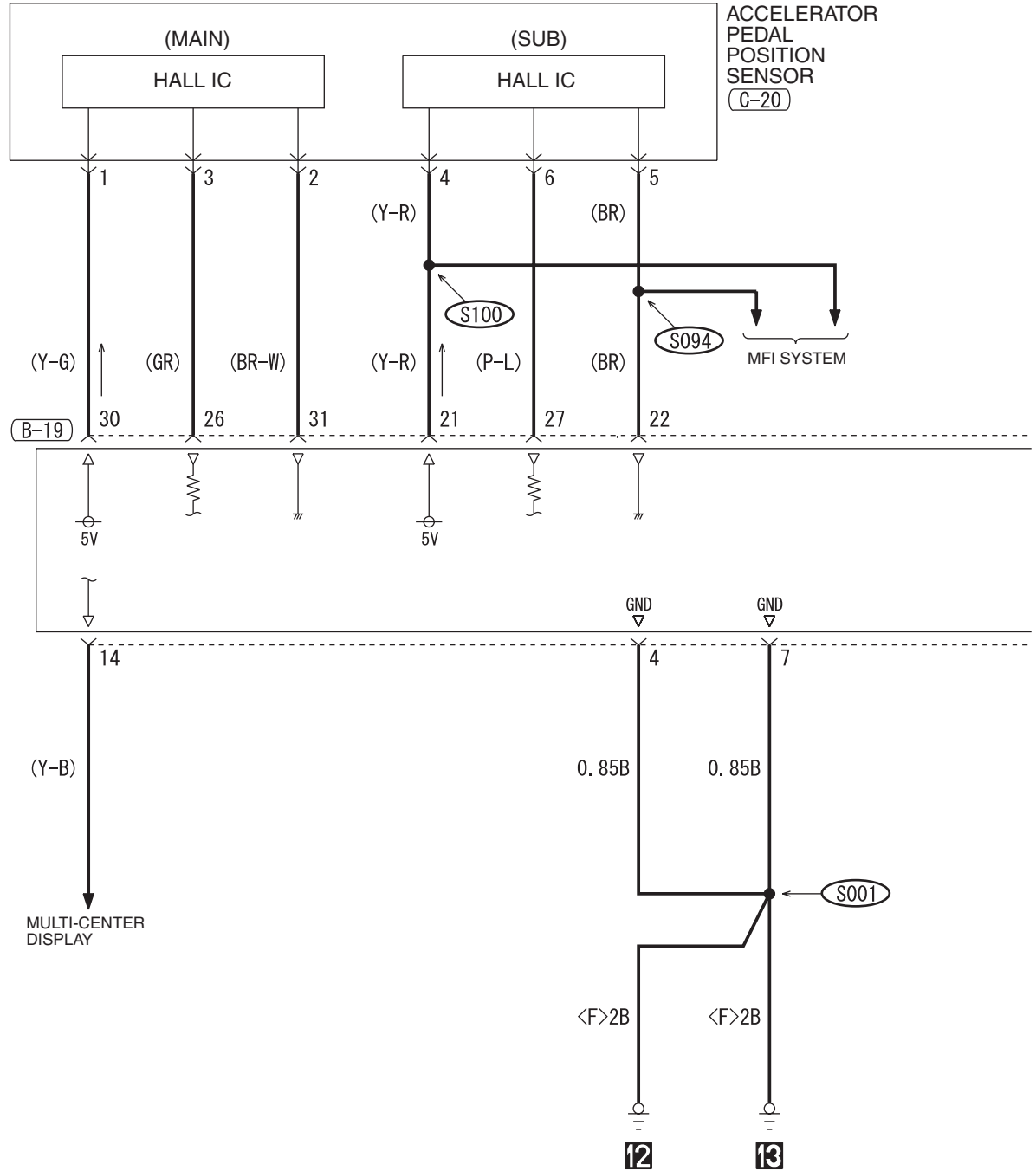

B-18

B-19

C-20

C-21

C-24

C-125

FRONT SIDE

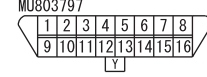
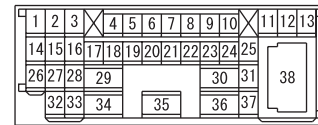
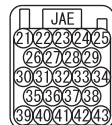
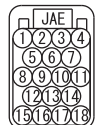

10

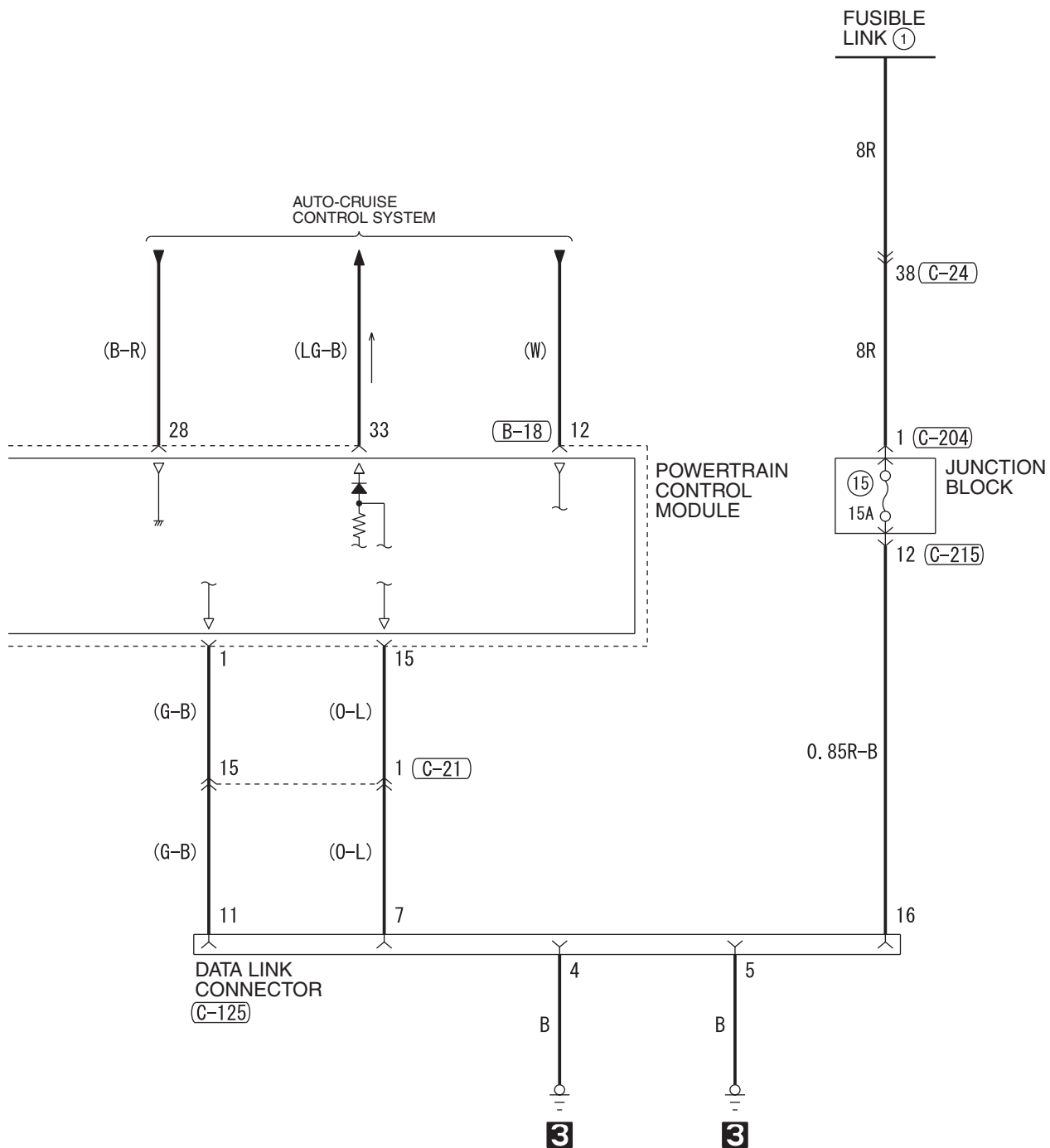

(C-215)

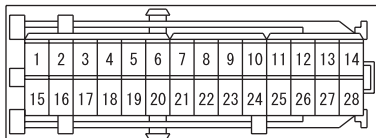

WIRE COLOR CODE
 B : BLACK LG : LIGHT GREEN G : GREEN L : BLUE
 BR : BROWN O : ORANGE GR : GRAY R : RED W : WHITE
 SB : SKY BLUE P : PINK Y : YELLOW V : VIOLET PU : PURPLE

H6P07M01EB

HEADLIGHT

1

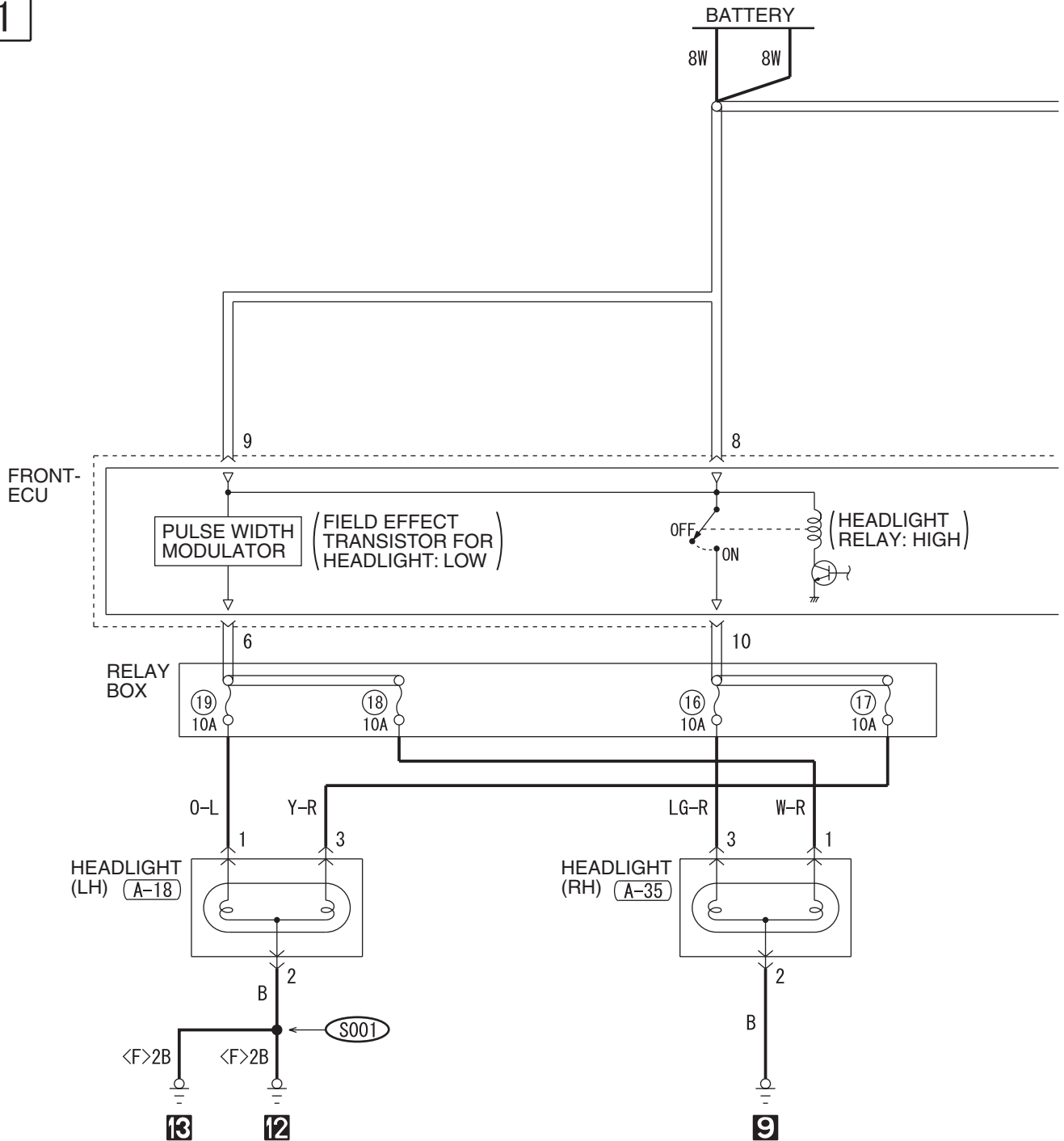

(A-13X)

1	2	3	4	5	6	7	8	9	10	11
---	---	---	---	---	---	---	---	---	----	----

(A-14X)

21	22	23	24	25	26	27	28	29	30	31
----	----	----	----	----	----	----	----	----	----	----

(A-18)



(A-35)



(C-24)

1	2	3	X	4	5	6	7	8	9	10	X	11	12	13
14	15	16	17	18	19	20	21	22	23	24	25			
26	27	28		29				30	31			38		
32	33	34		35				36	37					

(C-28)

1	2	3	4	5	6	7	8	9	10	11
12	13	14	15	16	17	18	19	20	21	22
23	24	25	26	27	28	29	30	31	32	33

2

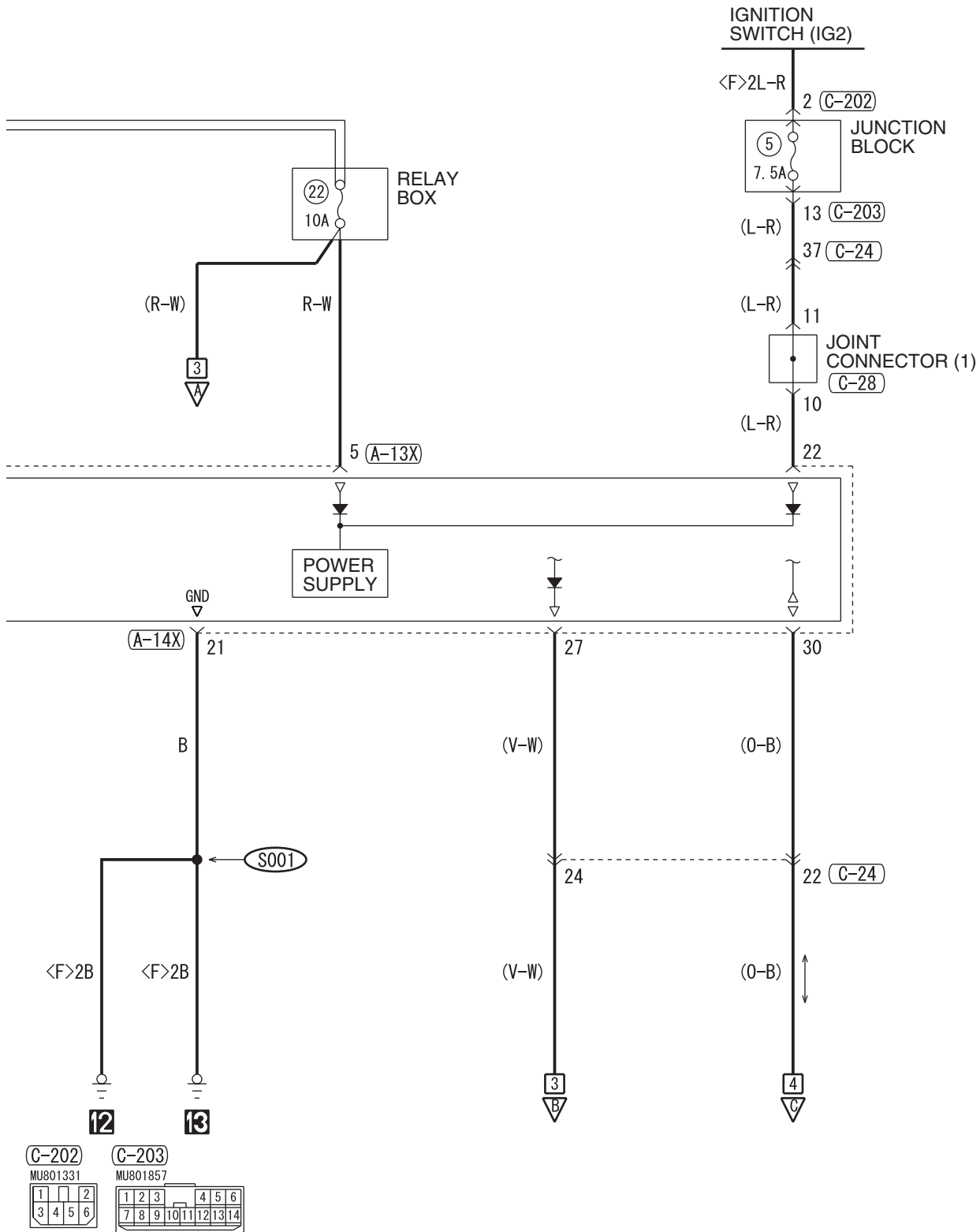

WIRE COLOR CODE
 B: BLACK LG: LIGHT GREEN G: GREEN L: BLUE W: WHITE Y: YELLOW SB: SKY BLUE
 BR: BROWN O: ORANGE GR: GRAY R: RED P: PINK V: VIOLET PU: PURPLE

H6P08M00AB

TSB Revision

HEADLIGHT (CONTINUED)

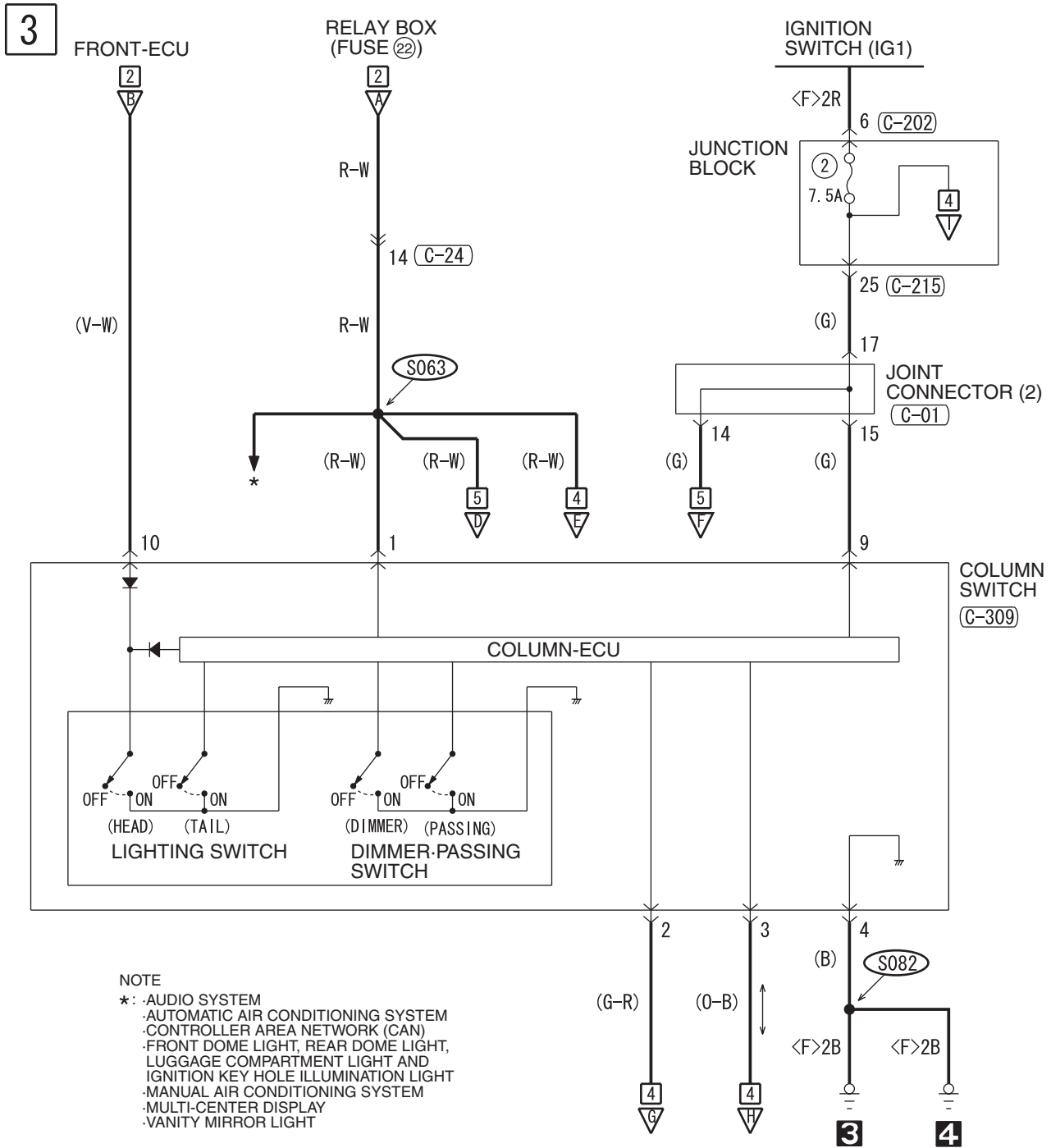

NOTE
 *: -AUDIO SYSTEM
 -AUTOMATIC AIR CONDITIONING SYSTEM
 -CONTROLLER AREA NETWORK (CAN)
 -FRONT DOME LIGHT, REAR DOME LIGHT,
 LUGGAGE COMPARTMENT LIGHT AND
 IGNITION KEY HOLE ILLUMINATION LIGHT
 -MANUAL AIR CONDITIONING SYSTEM
 -MULTI-CENTER DISPLAY
 -VANITY MIRROR LIGHT

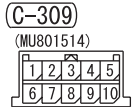
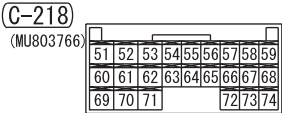
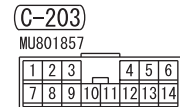
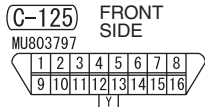
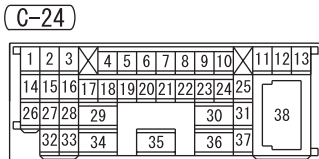
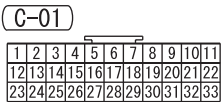

4

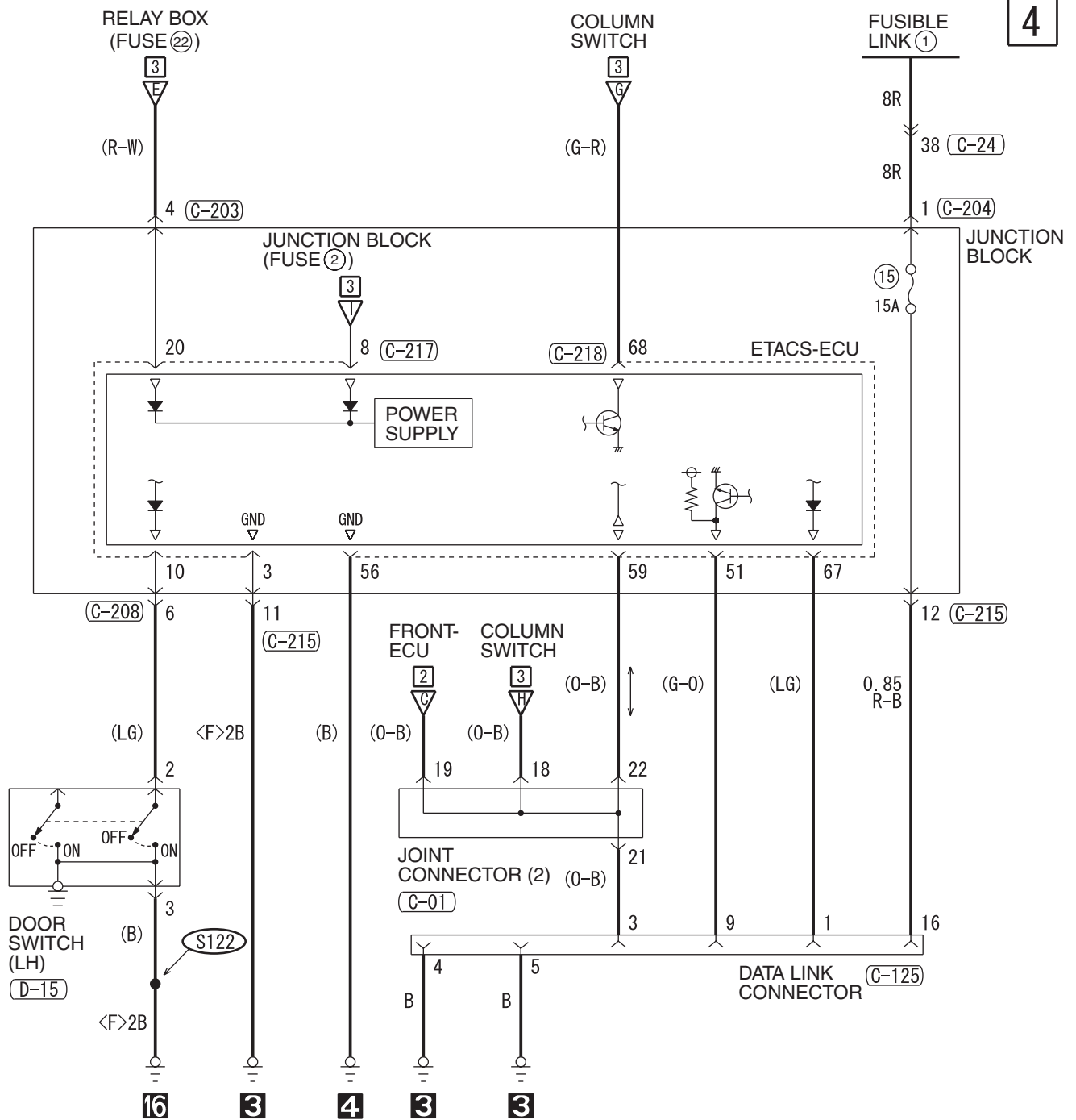

(C-208)



(C-215)

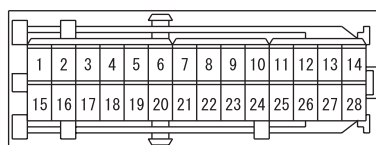

(C-217) JUNCTION BLOCK SIDE

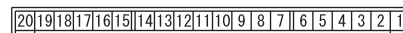

WIRE COLOR CODE

B : BLACK LG : LIGHT GREEN G : GREEN L : BLUE W : WHITE Y : YELLOW SB : SKY BLUE
BR : BROWN O : ORANGE GR : GRAY R : RED P : PINK V : VIOLET PU : PURPLE

H6P08M00BB

HEADLIGHT (CONTINUED)

5

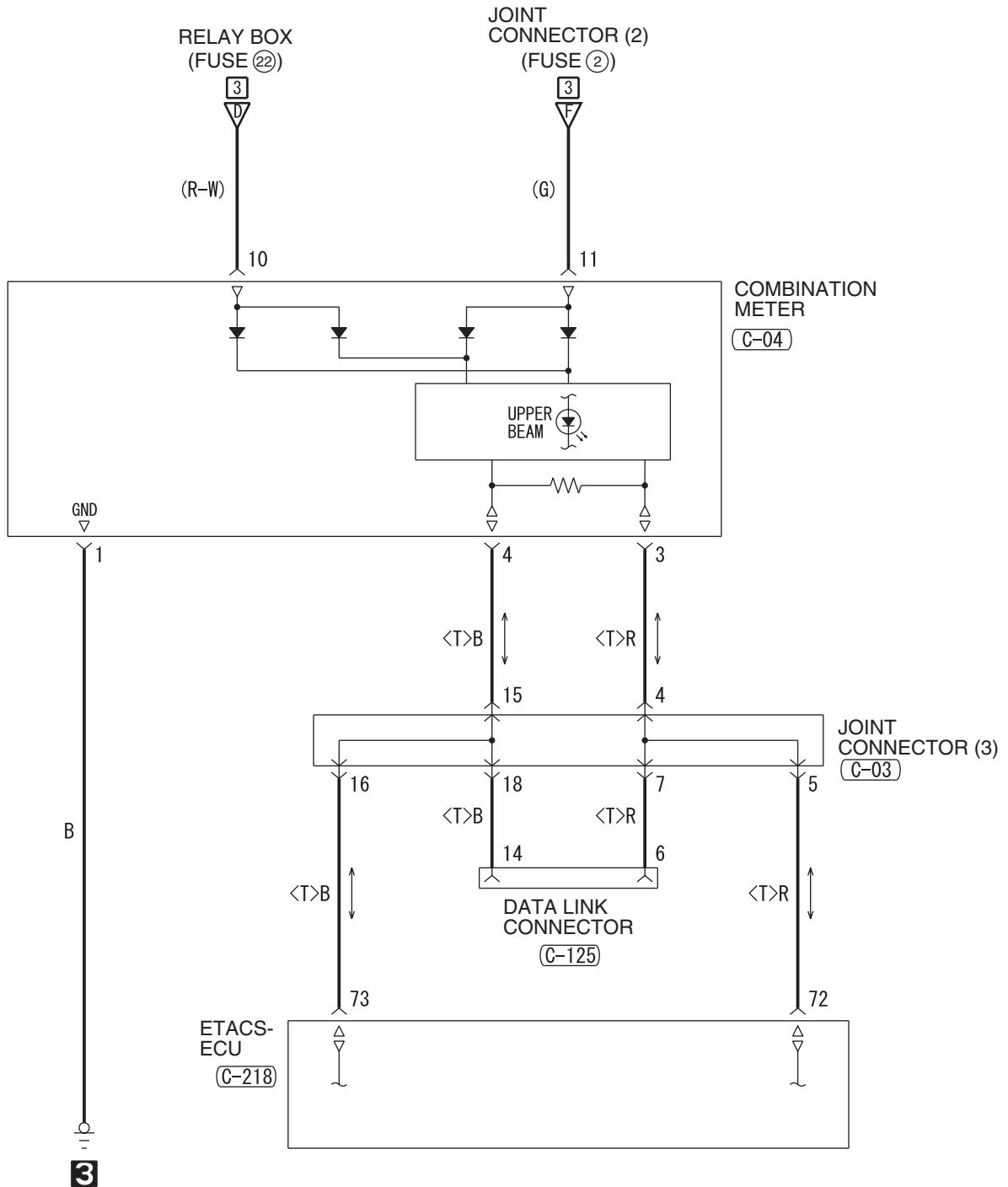

(C-03)

MU801515
1 2 3 4 5 6 7 8 9 10 11
12 13 14 15 16 17 18 19 20 21 22

(C-04)

MU801589
1 2 3 4 5 6 7 8 9
10 11 12 13 14 15 16 17 18

(C-125) FRONT SIDE

MU803797
1 2 3 4 5 6 7 8
9 10 11 12 13 14 15 16

(C-218)

MU803766
51 52 53 54 55 56 57 58 59
60 61 62 63 64 65 66 67 68
69 70 71 72 73 74

WIRE COLOR CODE

B: BLACK LG: LIGHT GREEN G: GREEN L: BLUE W: WHITE Y: YELLOW SB: SKY BLUE
BR: BROWN O: ORANGE GR: GRAY R: RED P: PINK V: VIOLET PU: PURPLE

H6P08M00CA

NOTES

TAILLIGHT, POSITION LIGHT AND LICENSE PLATE LIGHT

M1901012600319

1

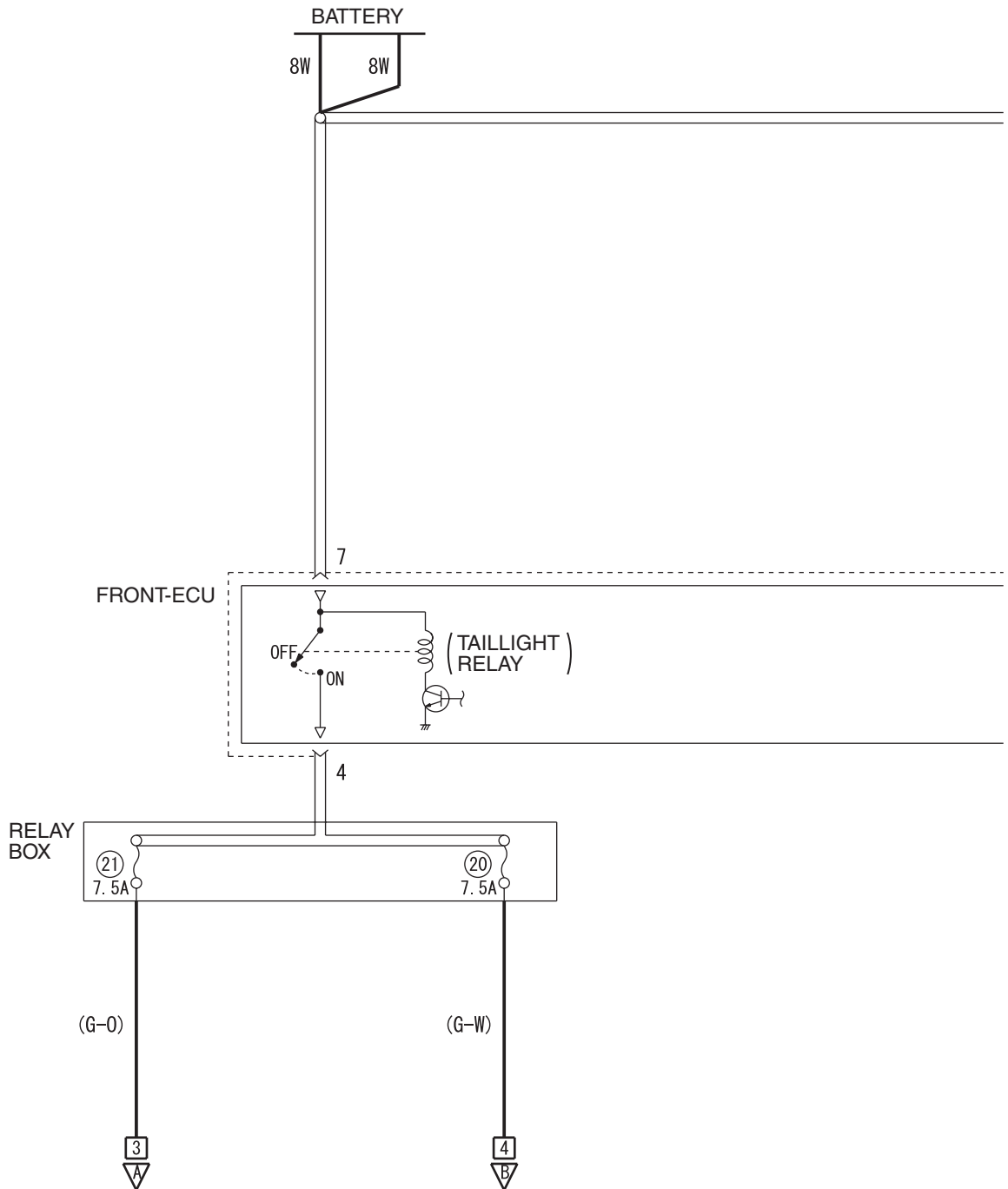

(A-13X)

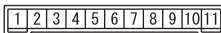

(A-14X)

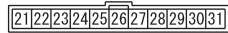

(C-24)

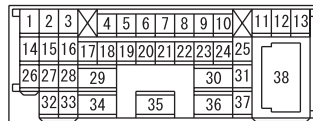

(C-28)



(C-202)



2

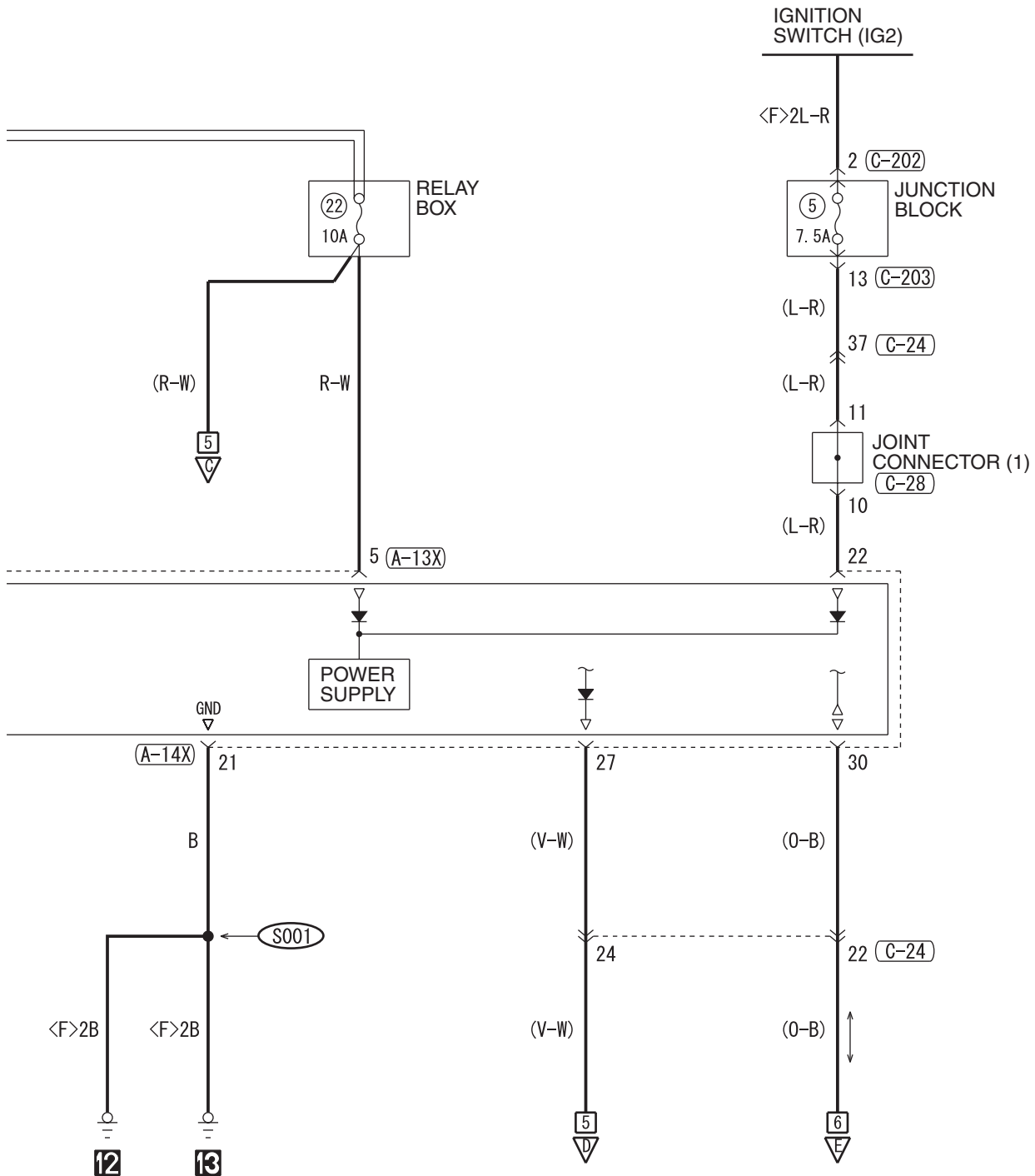

(C-203)

MU801857

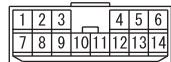

WIRE COLOR CODE

B : BLACK LG : LIGHT GREEN G : GREEN L : BLUE W : WHITE Y : YELLOW SB : SKY BLUE
 BR : BROWN O : ORANGE GR : GRAY R : RED P : PINK V : VIOLET PU : PURPLE

H6P08M01AB

TSB Revision

TAILLIGHT, POSITION LIGHT AND LICENSE PLATE LIGHT (CONTINUED)

3

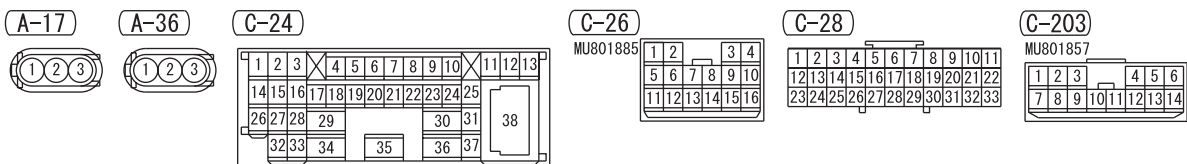
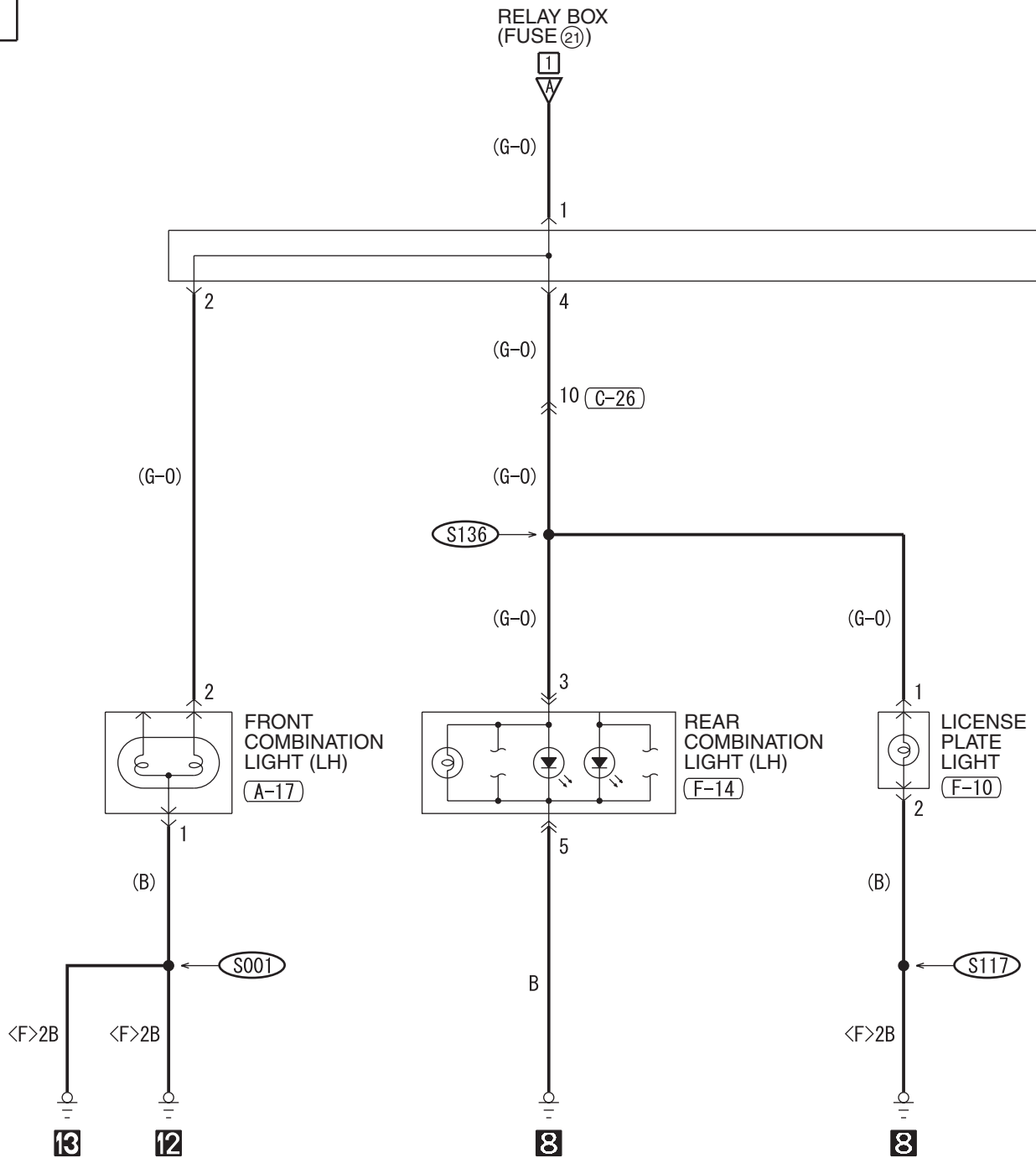

4

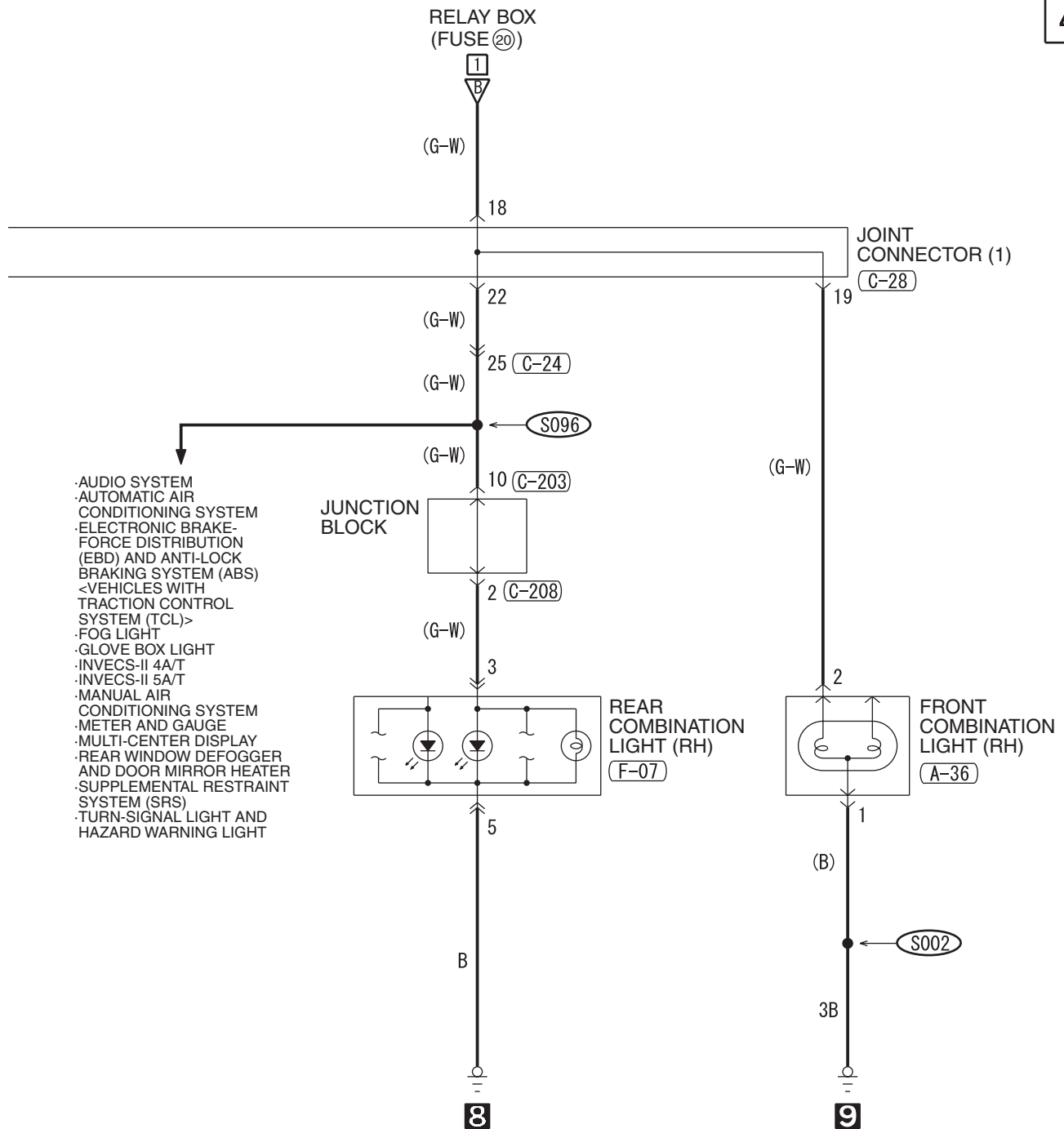

- AUDIO SYSTEM
- AUTOMATIC AIR CONDITIONING SYSTEM
- ELECTRONIC BRAKE-FORCE DISTRIBUTION (EBD) AND ANTI-LOCK BRAKING SYSTEM (ABS) <VEHICLES WITH TRACTION CONTROL SYSTEM (TCL)>
- FOG LIGHT
- GLOVE BOX LIGHT
- INVECS-II 4A/T
- INVECS-II 5A/T
- MANUAL AIR CONDITIONING SYSTEM
- METER AND GAUGE
- MULTI-CENTER DISPLAY
- REAR WINDOW DEFOGGER AND DOOR MIRROR HEATER
- SUPPLEMENTAL RESTRAINT SYSTEM (SRS)
- TURN-SIGNAL LIGHT AND HAZARD WARNING LIGHT

(C-208)

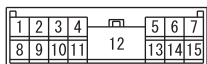

(F-07)



(F-10)



(F-14)



WIRE COLOR CODE

B: BLACK LG: LIGHT GREEN G: GREEN L: BLUE W: WHITE Y: YELLOW SB: SKY BLUE
 BR: BROWN O: ORANGE GR: GRAY R: RED P: PINK V: VIOLET PU: PURPLE

TAILLIGHT, POSITION LIGHT AND LICENSE PLATE LIGHT (CONTINUED)

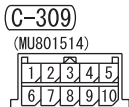
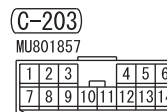
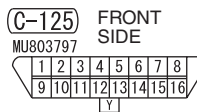
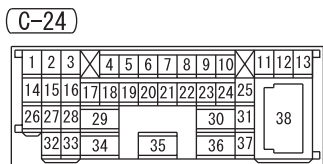
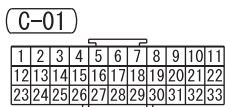
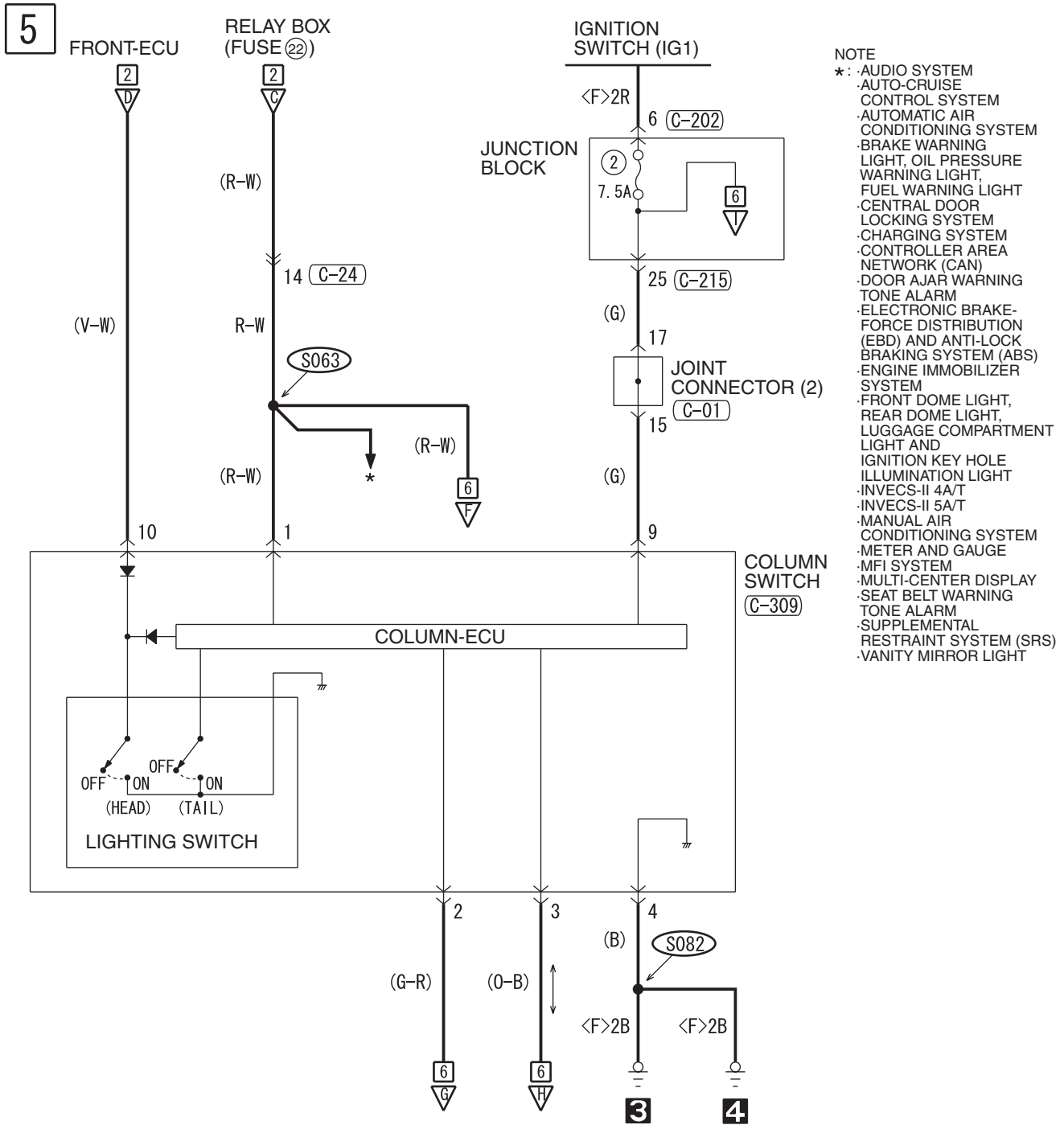

6

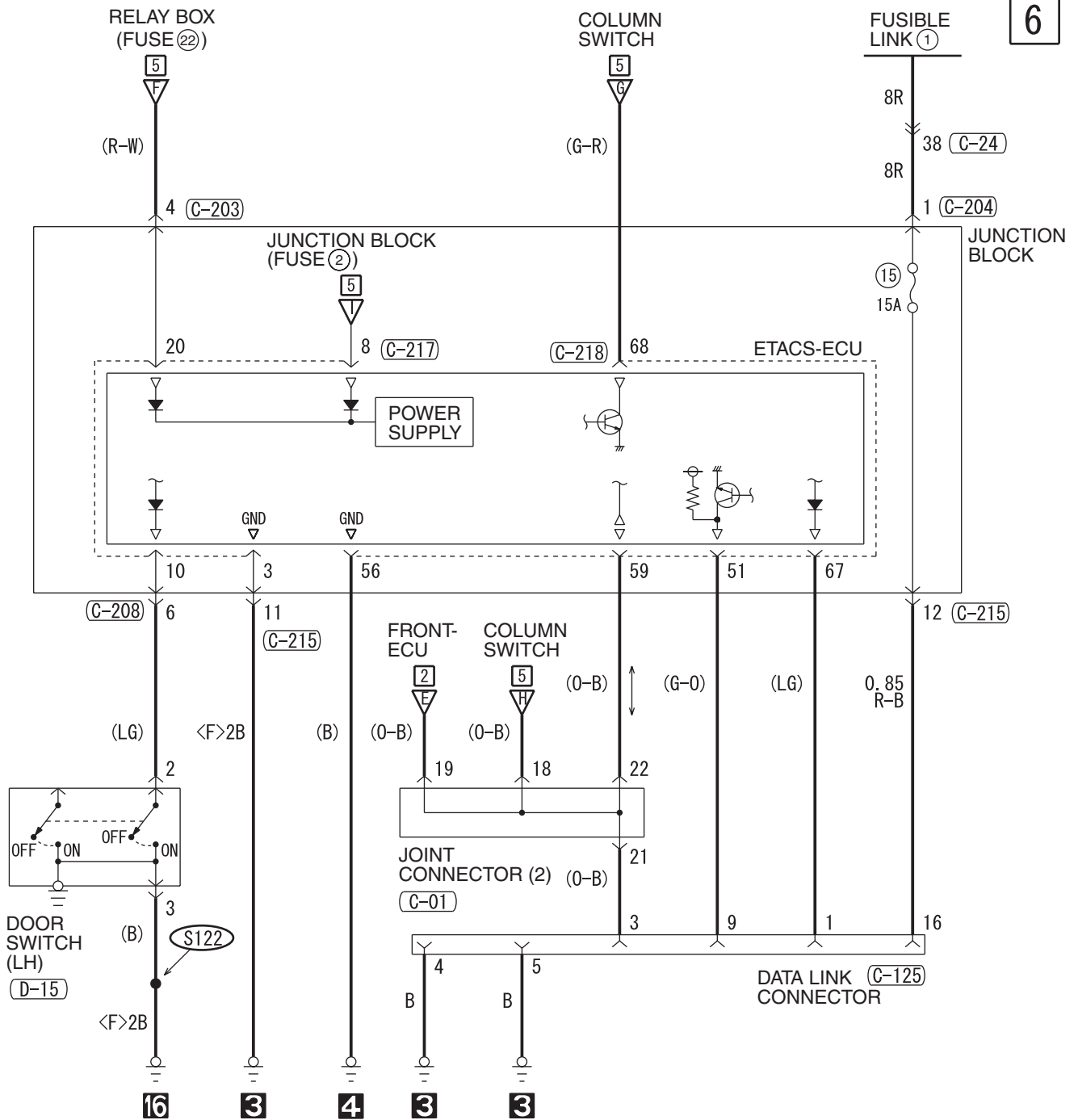

(C-208)



(C-215)

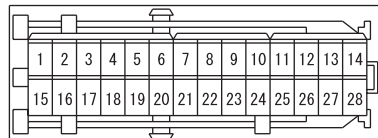

(C-217) JUNCTION BLOCK SIDE

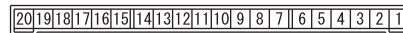

(C-218)



WIRE COLOR CODE

B: BLACK LG: LIGHT GREEN G: GREEN L: BLUE W: WHITE Y: YELLOW SB: SKY BLUE
 BR: BROWN O: ORANGE GR: GRAY R: RED P: PINK V: VIOLET PU: PURPLE

H6P08M01CB

FOG LIGHT

M1901001800825

1

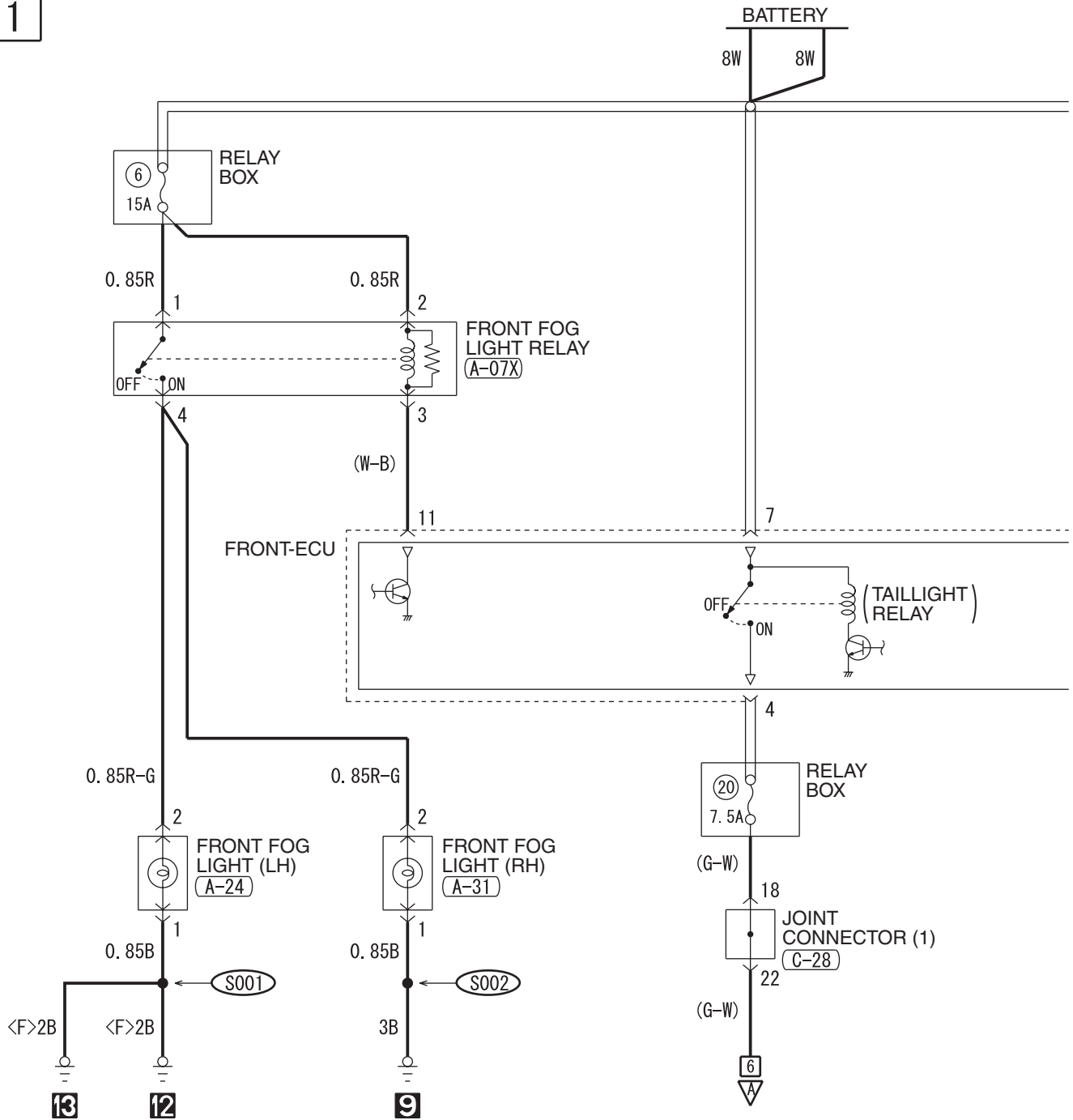

(A-07X)

(A-13X)

(A-14X)

(A-24)

(A-31)

(C-24)

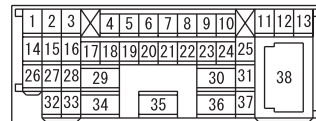
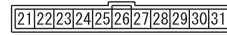
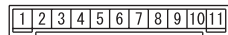

H6P08M02AA

TSB Revision

2

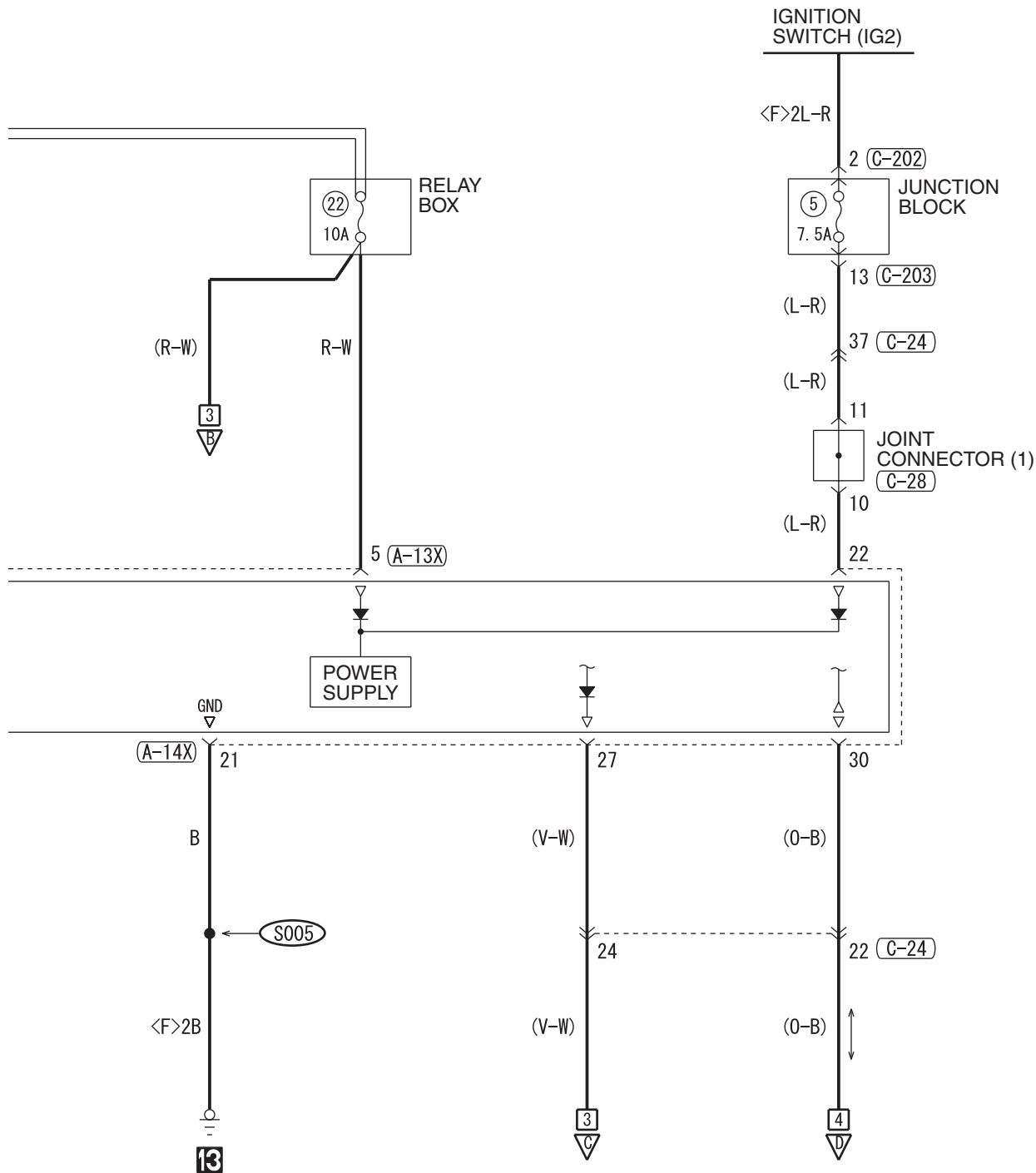

(C-28)

1	2	3	4	5	6	7	8	9	10	11
12	13	14	15	16	17	18	19	20	21	22
23	24	25	26	27	28	29	30	31	32	33

(C-202)

MU801331

1	2
3	4
5	6

(C-203)

MU801857

1	2	3	4	5	6
7	8	9	10	11	12
13	14				

WIRE COLOR CODE

B: BLACK LG: LIGHT GREEN G: GREEN L: BLUE W: WHITE Y: YELLOW SB: SKY BLUE
BR: BROWN O: ORANGE GR: GRAY R: RED P: PINK V: VIOLET PU: PURPLE

H6P08M02AB

TSB Revision

FOG LIGHT (CONTINUED)

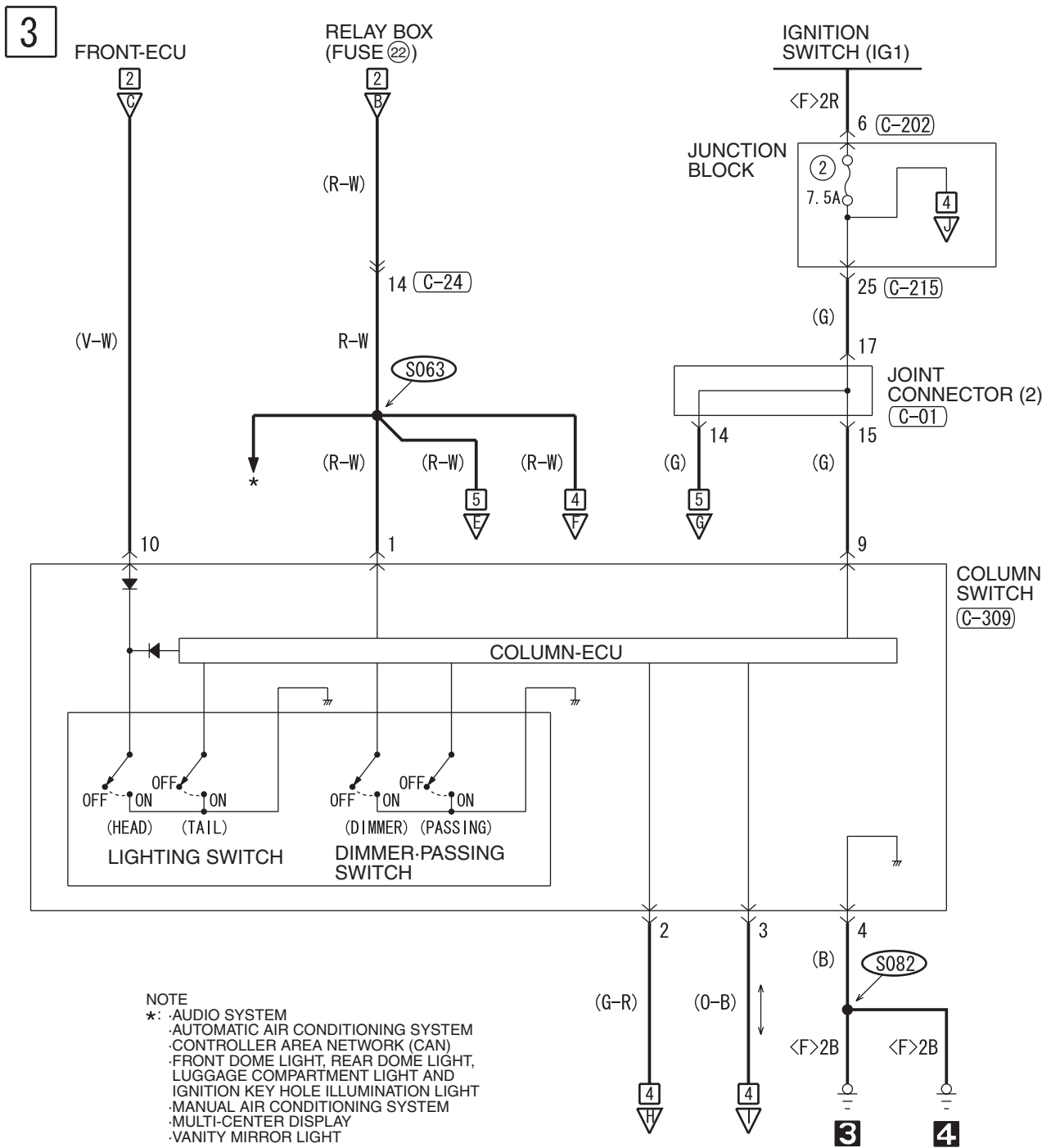

(C-01)

1	2	3	4	5	6	7	8	9	10	11
12	13	14	15	16	17	18	19	20	21	22
23	24	25	26	27	28	29	30	31	32	33

(C-24)

1	2	3	4	5	6	7	8	9	10	11	12	13
14	15	16	17	18	19	20	21	22	23	24	25	
26	27	28	29			30	31			38		
32	33	34			35		36	37				

(C-125) FRONT SIDE

MU803797

1	2	3	4	5	6	7	8
9	10	11	12	13	14	15	16

(C-202)

MU801331

1	2	3	4	5	6
---	---	---	---	---	---

(C-203)

MU801857

1	2	3	4	5	6		
7	8	9	10	11	12	13	14

(C-204)

MU801403

1

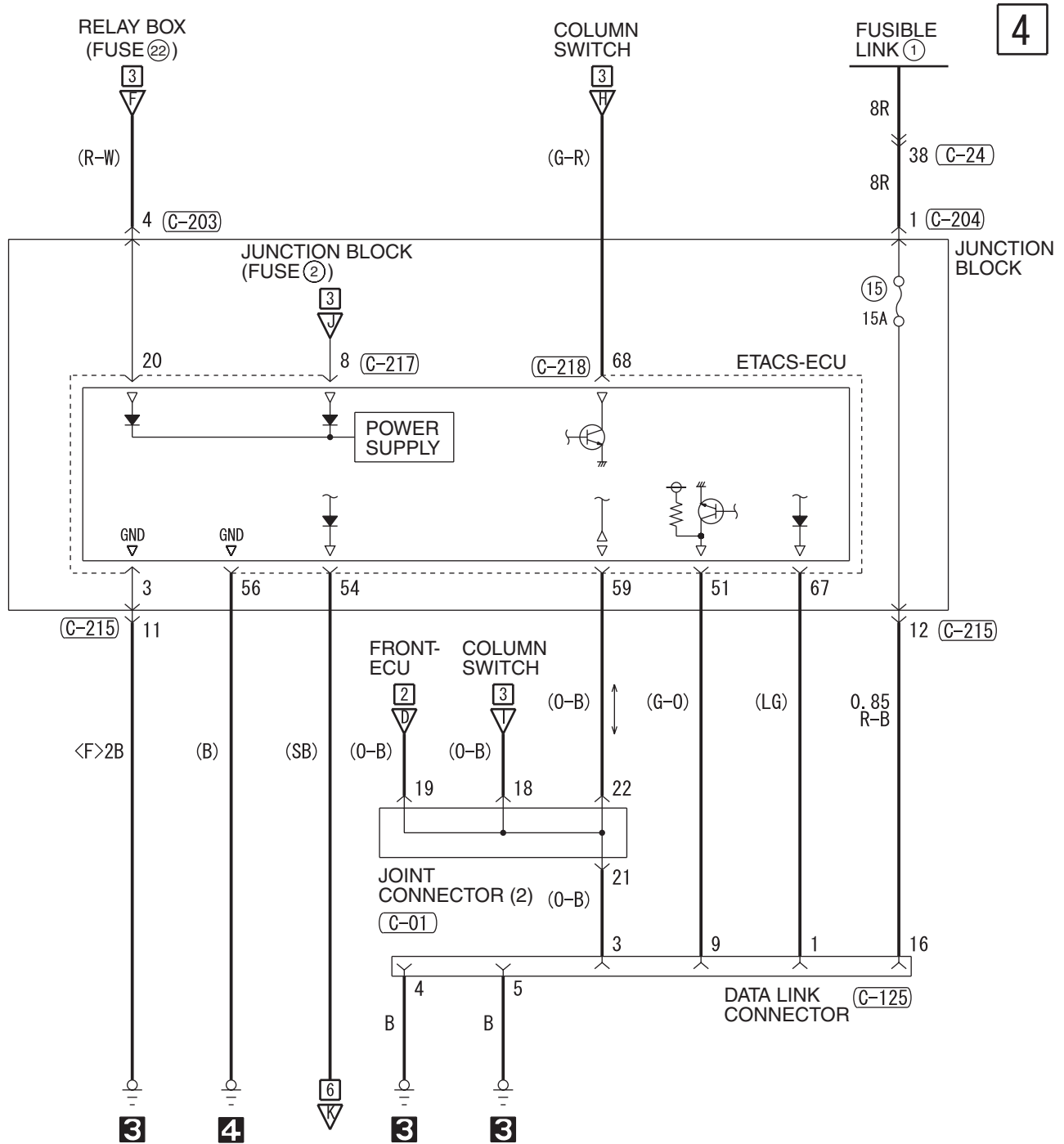

4

(C-215)

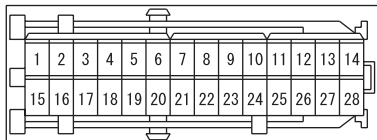

(C-217) JUNCTION BLOCK SIDE

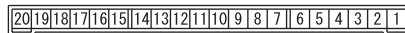

(C-218)

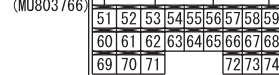

(C-309)

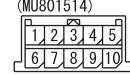

WIRE COLOR CODE

B: BLACK LG: LIGHT GREEN G: GREEN L: BLUE
 BR: BROWN O: ORANGE GR: GRAY R: RED W: WHITE
 SB: SKY BLUE P: PINK Y: YELLOW V: VIOLET PU: PURPLE H6P08M02BB

FOG LIGHT (CONTINUED)

5

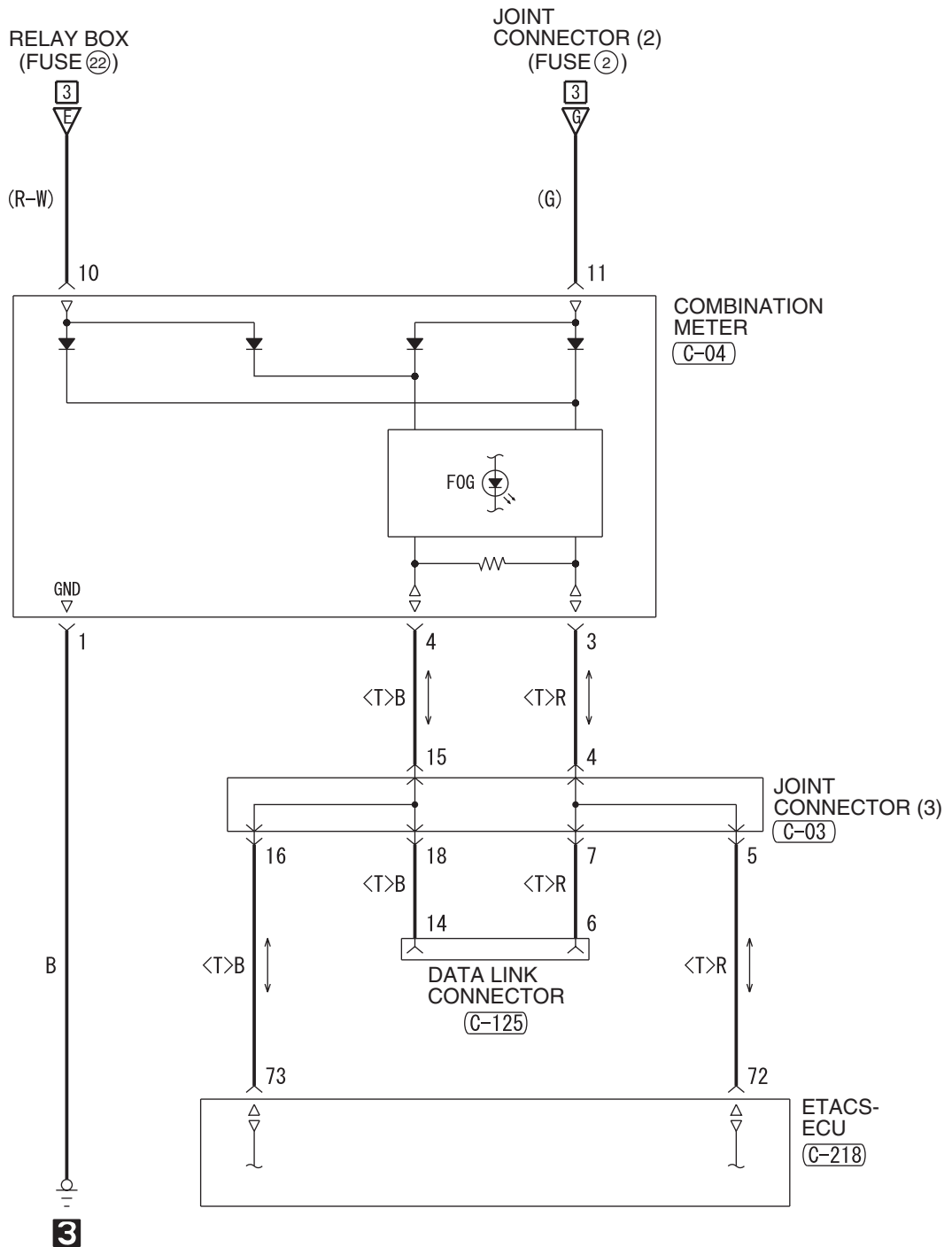

(C-03)

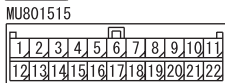

(C-04)

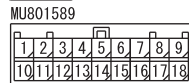

(C-24)

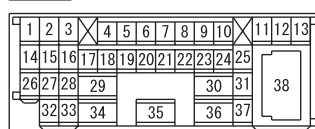

(C-125) FRONT SIDE

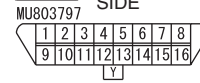

(C-127)

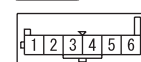

6

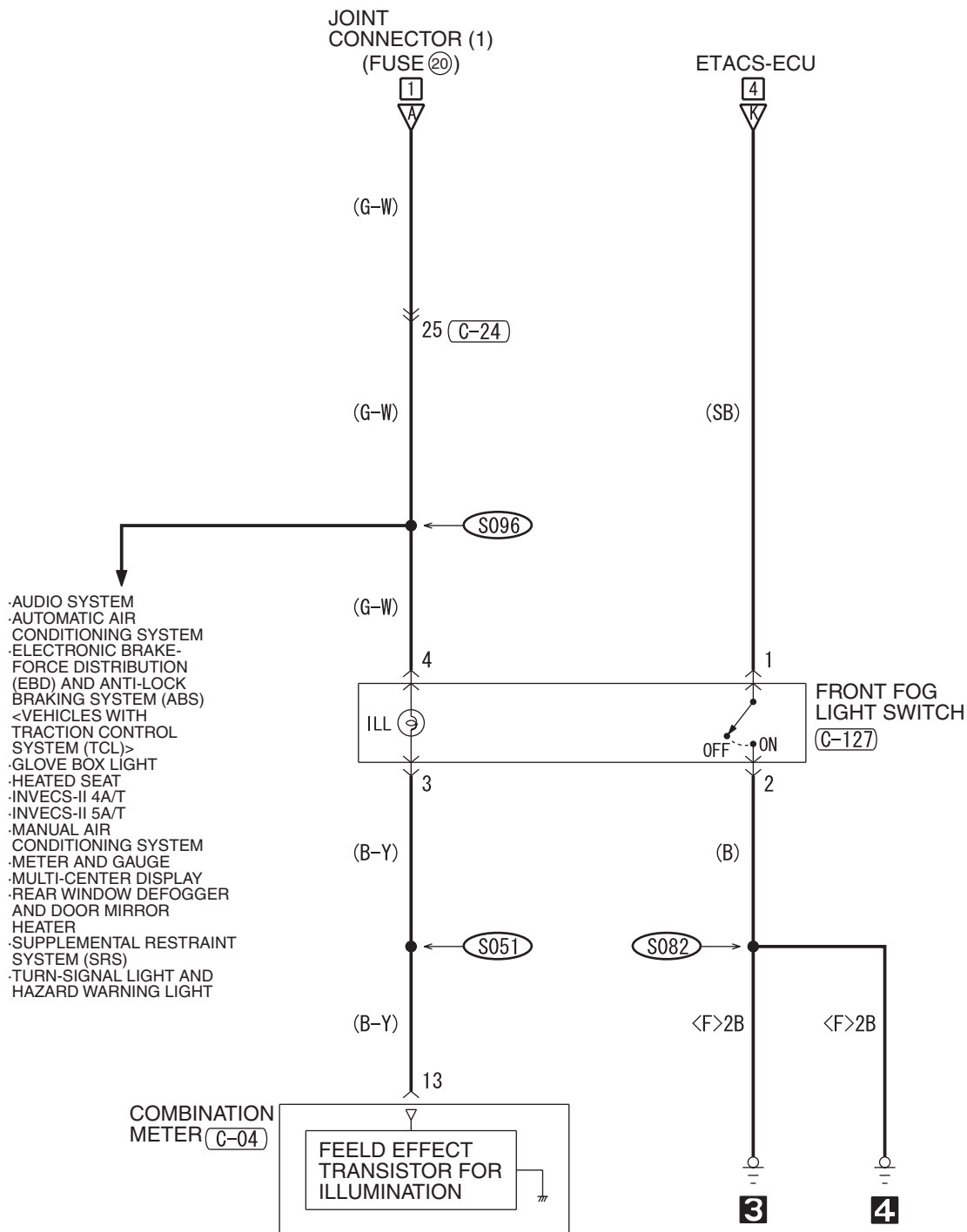

- AUDIO SYSTEM
- AUTOMATIC AIR CONDITIONING SYSTEM
- ELECTRONIC BRAKE-FORCE DISTRIBUTION (EBD) AND ANTI-LOCK BRAKING SYSTEM (ABS) <VEHICLES WITH TRACTION CONTROL SYSTEM (TCL)>
- GLOVE BOX LIGHT
- HEATED SEAT
- INVECS-II 4A/T
- INVECS-II 5A/T
- MANUAL AIR CONDITIONING SYSTEM
- METER AND GAUGE
- MULTI-CENTER DISPLAY
- REAR WINDOW DEFOGGER AND DOOR MIRROR HEATER
- SUPPLEMENTAL RESTRAINT SYSTEM (SRS)
- TURN-SIGNAL LIGHT AND HAZARD WARNING LIGHT

(C-218)

(MU803766)

51	52	53	54	55	56	57	58	59
60	61	62	63	64	65	66	67	68
69	70	71		72	73	74		

WIRE COLOR CODE

B: BLACK LG: LIGHT GREEN G: GREEN L: BLUE W: WHITE Y: YELLOW SB: SKY BLUE
BR: BROWN O: ORANGE GR: GRAY R: RED P: PINK V: VIOLET PU: PURPLE

H6P08M02CB

TSB Revision

FRONT DOME LIGHT, REAR DOME LIGHT, LUGGAGE COMPARTMENT LIGHT AND IGNITION KEY HOLE ILLUMINATION LIGHT

M1901018200171

1

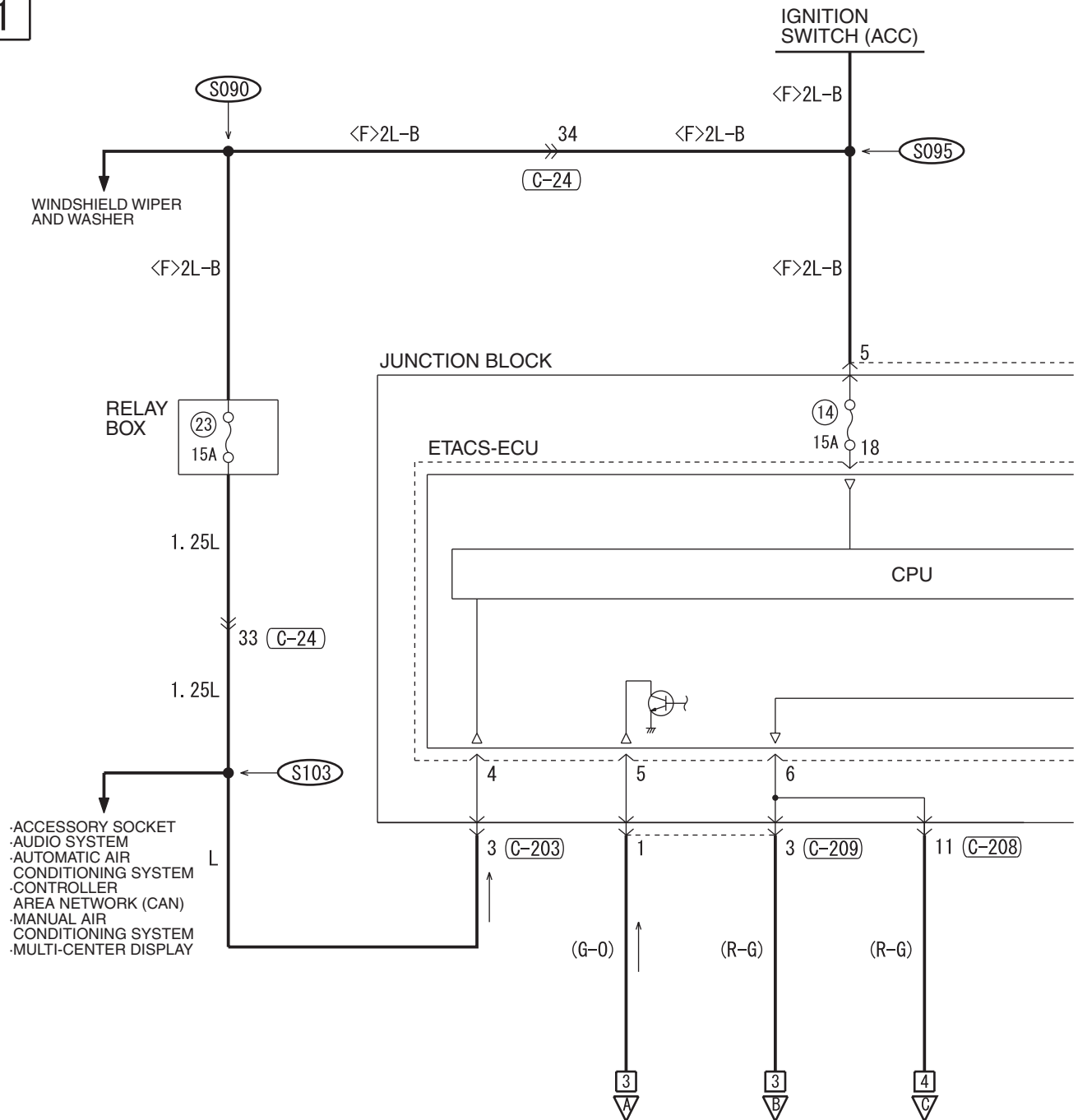

(C-24)

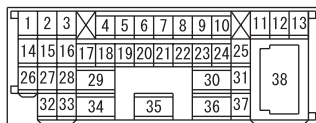

(C-125) FRONT SIDE

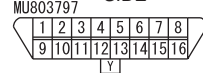

(C-202)



(C-203)

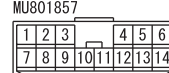

(C-204)



(C-208)

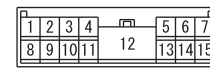

(C-209)



2

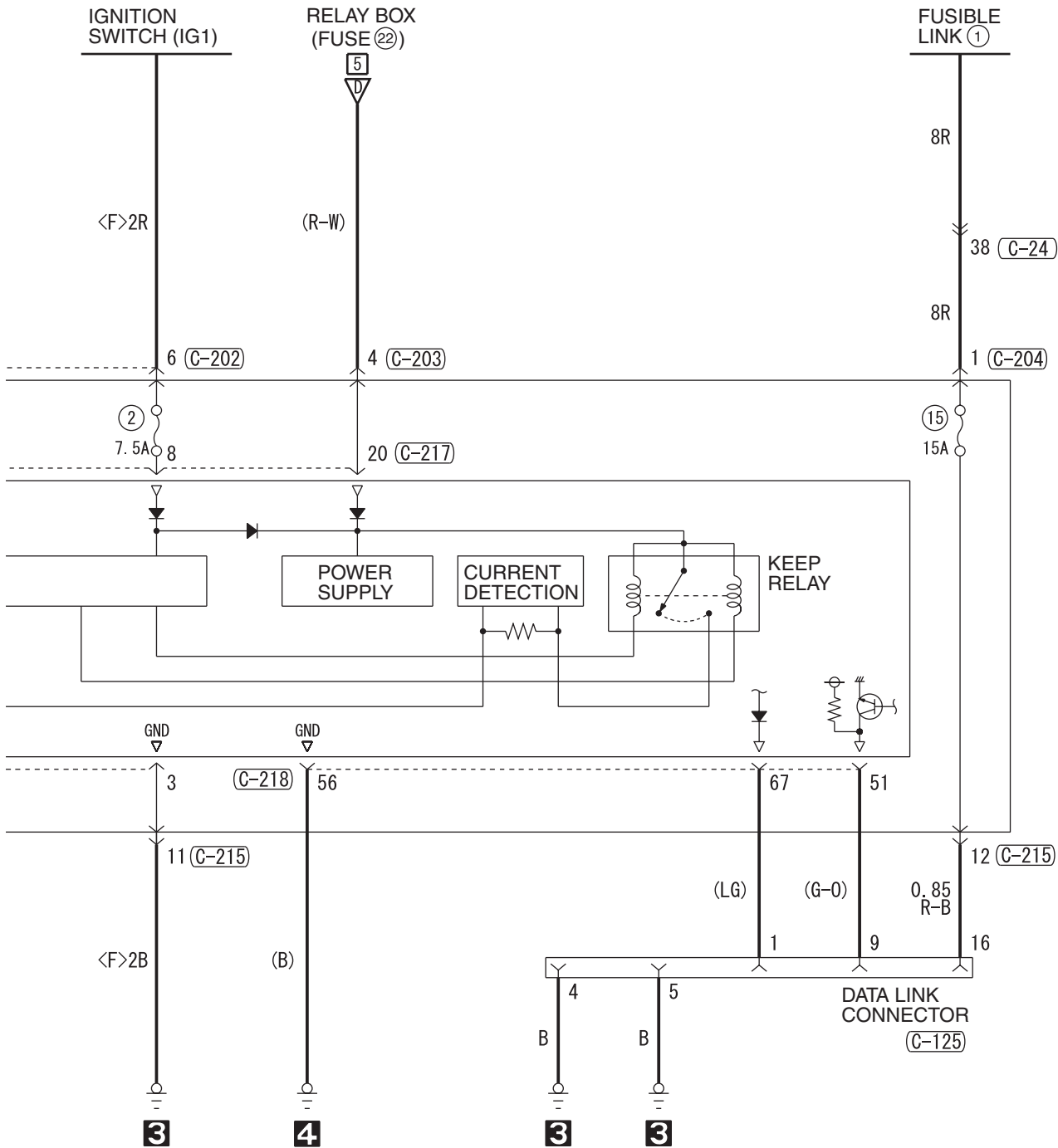

(C-215)

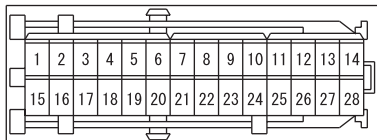

(C-217) JUNCTION BLOCK SIDE

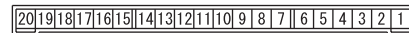

(C-218)

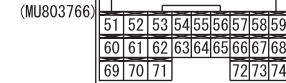

WIRE COLOR CODE

B : BLACK LG : LIGHT GREEN G : GREEN L : BLUE
 BR : BROWN O : ORANGE GR : GRAY R : RED W : WHITE
 SB : SKY BLUE P : PINK Y : YELLOW V : VIOLET PU : PURPLE

FRONT DOME LIGHT, REAR DOME LIGHT, LUGGAGE COMPARTMENT LIGHT AND IGNITION KEY HOLE ILLUMINATION LIGHT (CONTINUED)

3

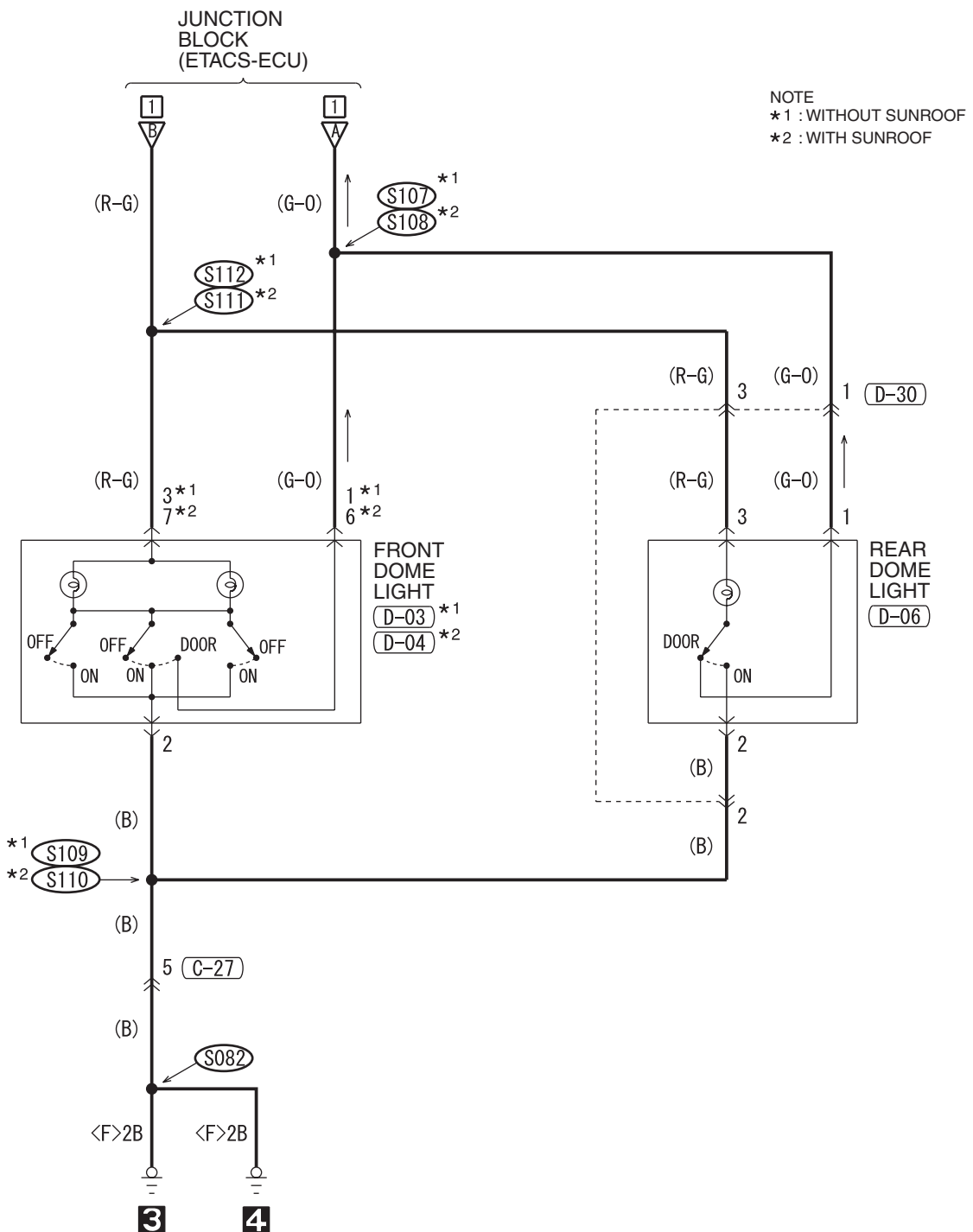

NOTE
 *1 : WITHOUT SUNROOF
 *2 : WITH SUNROOF

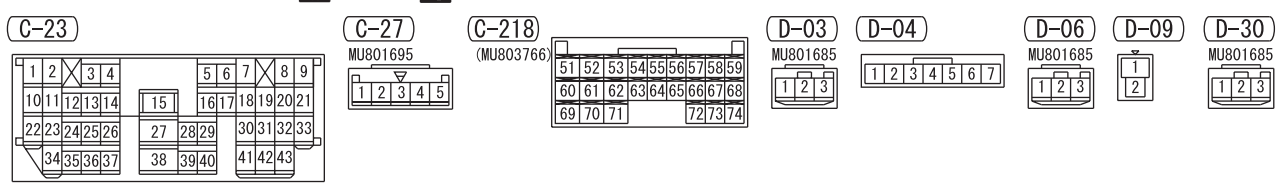

4

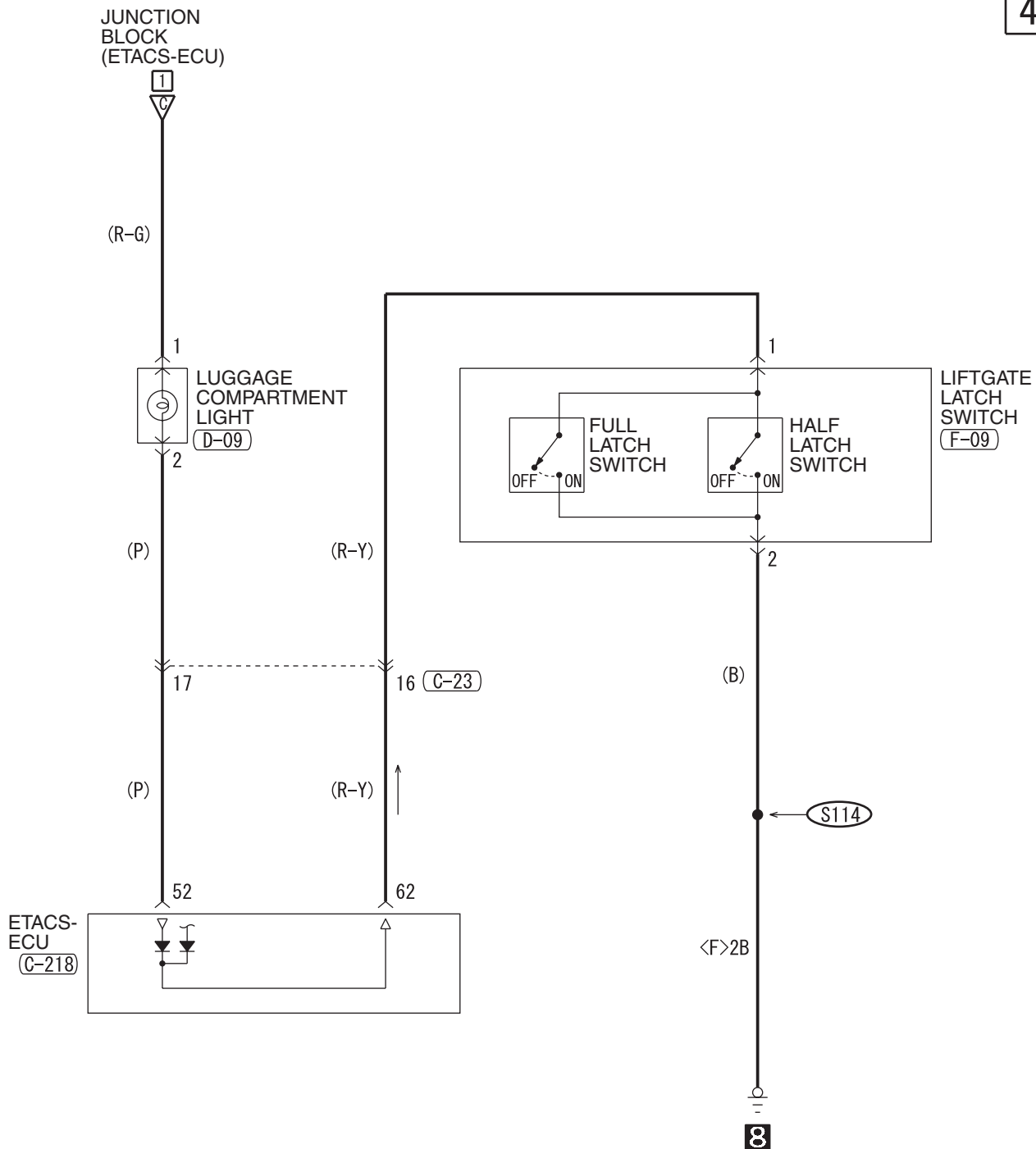

WIRE COLOR CODE
 B: BLACK LG: LIGHT GREEN G: GREEN L: BLUE W: WHITE Y: YELLOW SB: SKY BLUE
 BR: BROWN O: ORANGE GR: GRAY R: RED P: PINK V: VIOLET PU: PURPLE

H6P08M03BB

FRONT DOME LIGHT, REAR DOME LIGHT, LUGGAGE COMPARTMENT LIGHT AND IGNITION KEY HOLE ILLUMINATION LIGHT (CONTINUED)

5

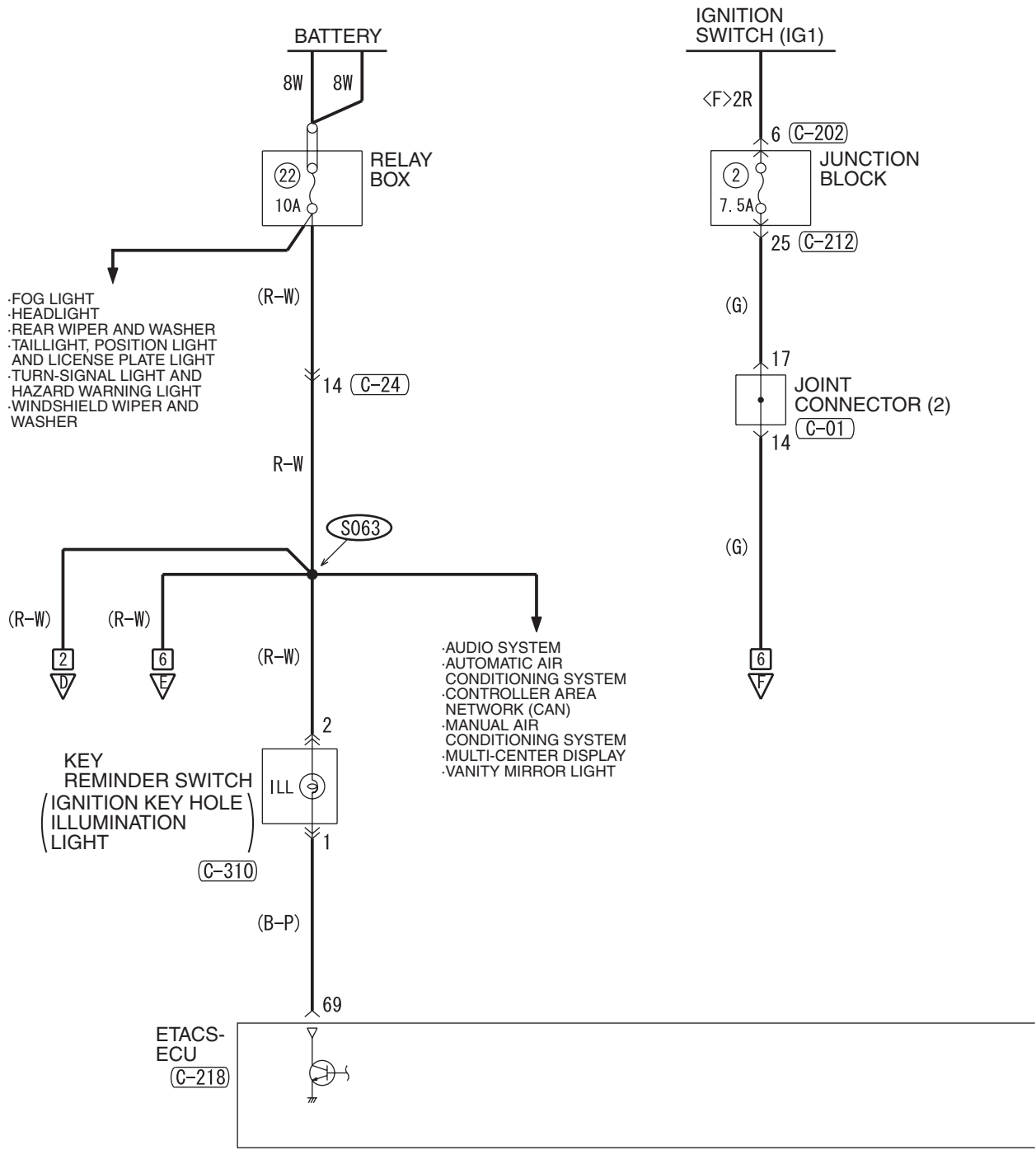

(C-01)



(C-03)

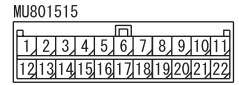

(C-04)

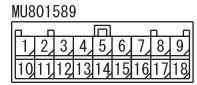

(C-24)

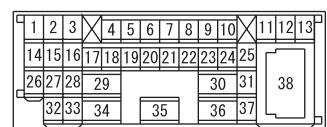

(C-125) FRONT SIDE

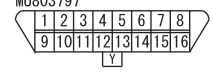

6

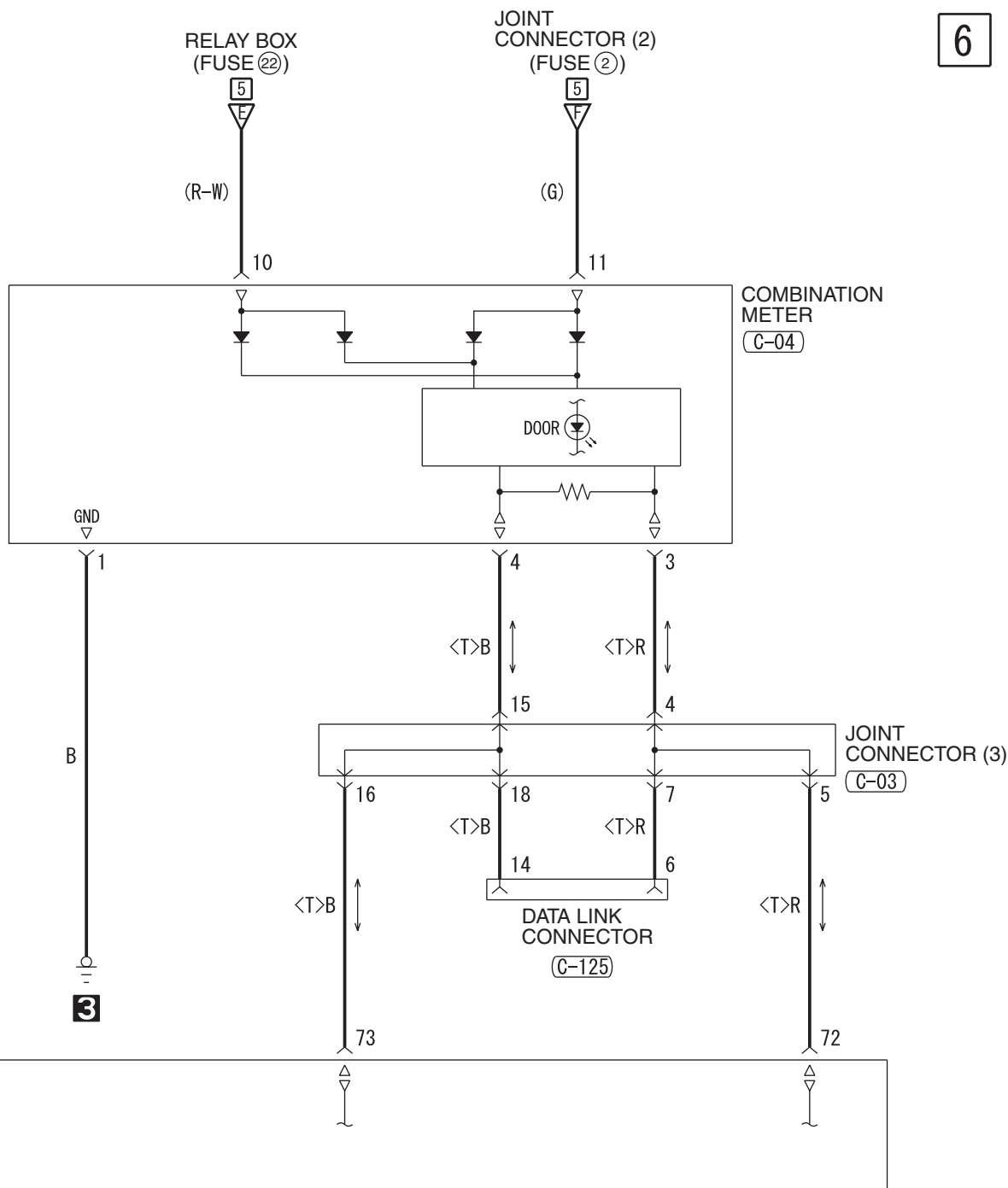

(C-215)

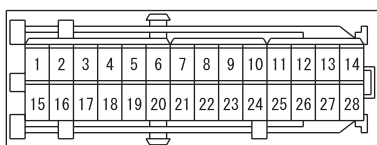

(C-218)

(MU803766)

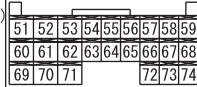

(C-310)

MU801547



WIRE COLOR CODE

B: BLACK LG: LIGHT GREEN G: GREEN L: BLUE W: WHITE Y: YELLOW SB: SKY BLUE
BR: BROWN O: ORANGE GR: GRAY R: RED P: PINK V: VIOLET PU: PURPLE

H6P08M03CB

FRONT DOME LIGHT, REAR DOME LIGHT, LUGGAGE COMPARTMENT LIGHT AND IGNITION KEY HOLE ILLUMINATION LIGHT (CONTINUED)

7

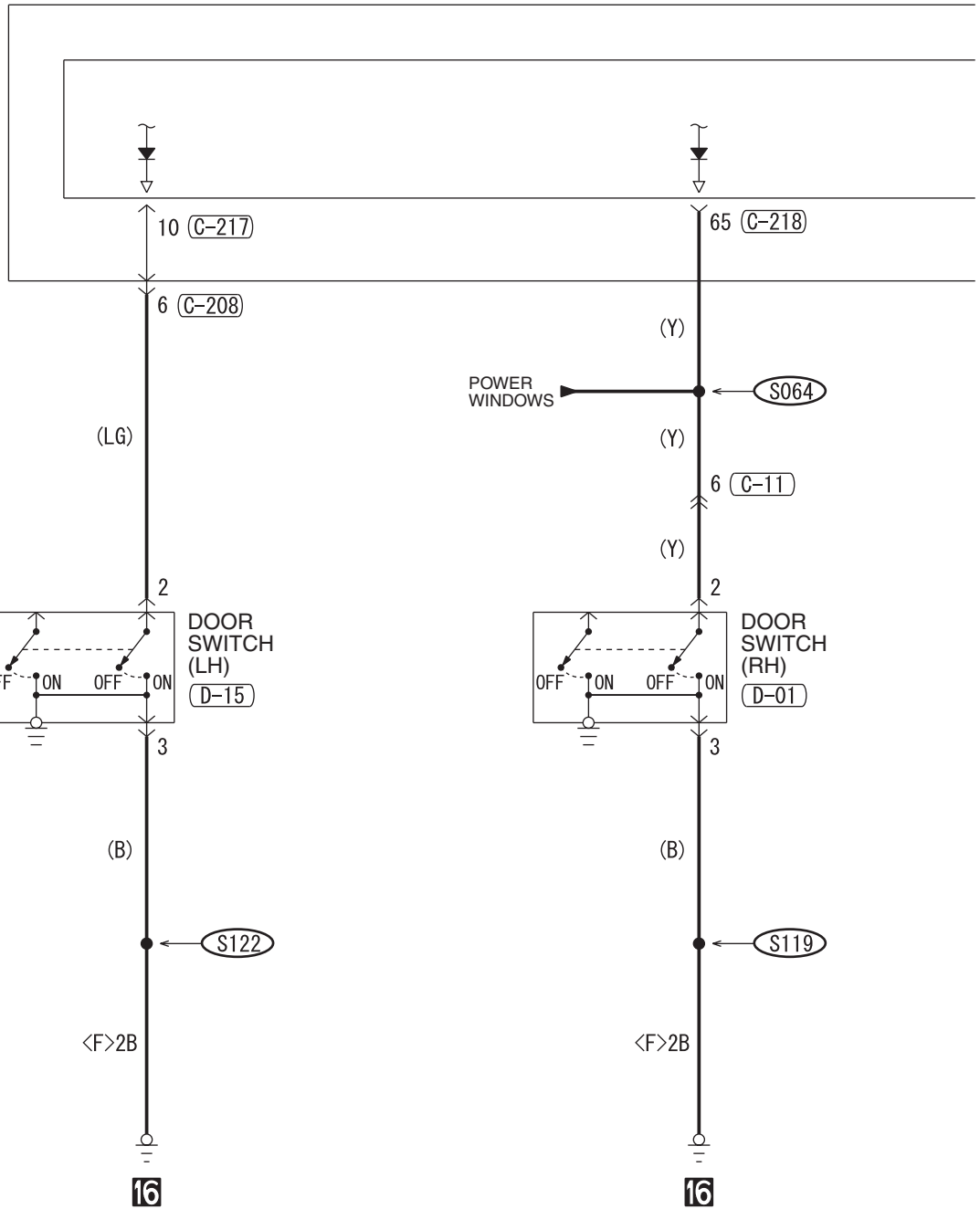

(C-11)

(C-25)

(C-208)

(C-217) JUNCTION BLOCK SIDE

1	2	3	4
5	6	7	8
9	10		

1	2	3	4	5	6	7	8	9
10	11	12	13	14	15	16	17	18
19	20	21	22	23	24	25	26	27
28	29	30	31	32				

1	2	3	4	5	6	7
8	9	10	11	12	13	14
15						

20	19	18	17	16	15	14	13	12	11	10	9	8	7	6	5	4	3	2	1
----	----	----	----	----	----	----	----	----	----	----	---	---	---	---	---	---	---	---	---

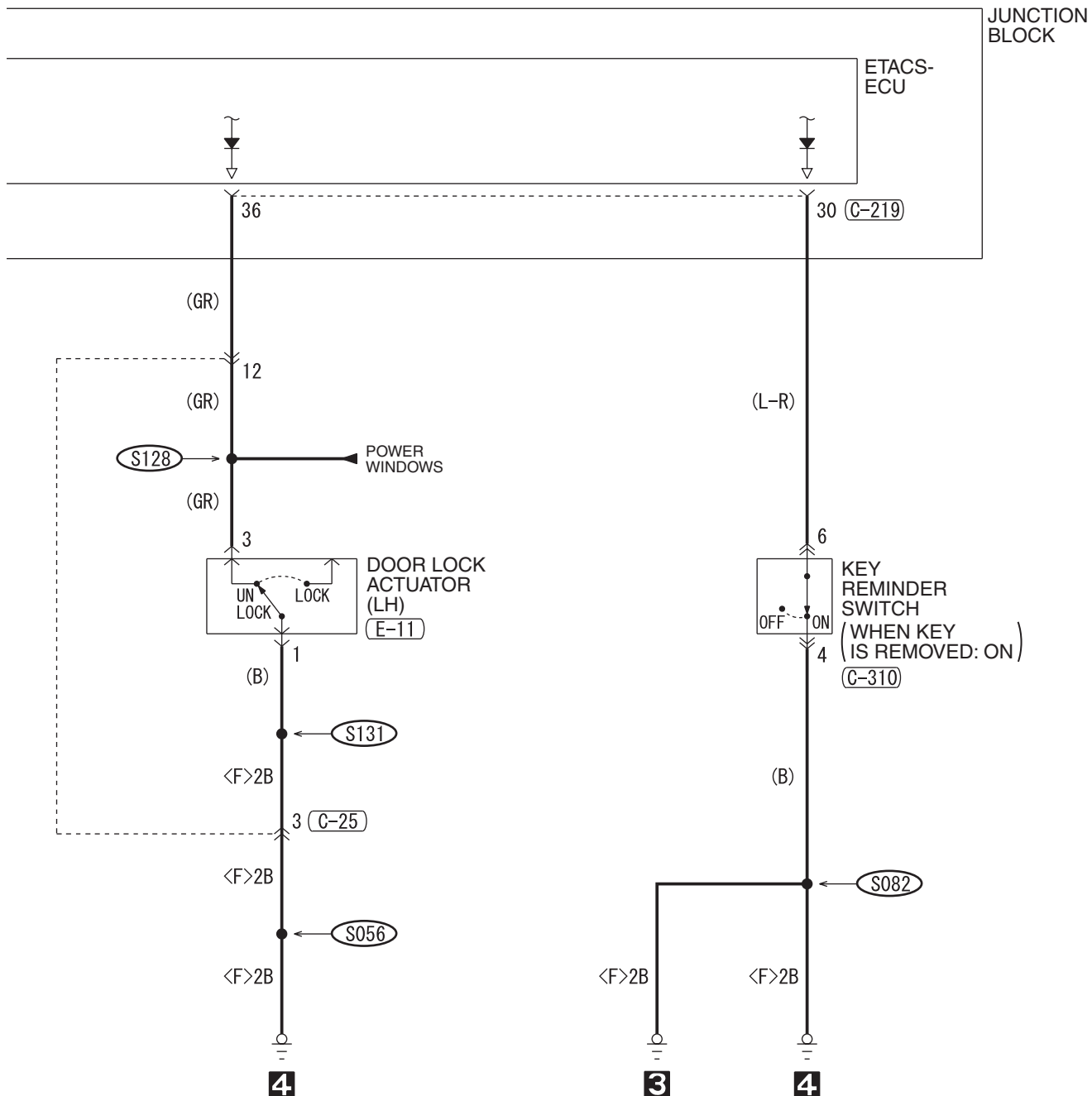

(C-218)
(MU803766)

51	52	53	54	55	56	57	58	59
60	61	62	63	64	65	66	67	68
69	70	71	72	73	74			

(C-219)
(MU803765)

21	22	23	24	25	26	27	28	29
30	31	32	33	34	35	36	37	38
39	40	41	42	43	44			

(C-310)
MU801547

1	2			
3	4	5	6	7

(D-01)
(MU801536)

1	2	3
---	---	---

(D-15)
(MU801536)

1	2	3
---	---	---

(E-11)
MU802341

1	2	3
4	5	6

WIRE COLOR CODE

B : BLACK LG : LIGHT GREEN G : GREEN L : BLUE W : WHITE Y : YELLOW SB : SKY BLUE
BR : BROWN O : ORANGE GR : GRAY R : RED P : PINK V : VIOLET PU : PURPLE

GLOVE BOX LIGHT

1

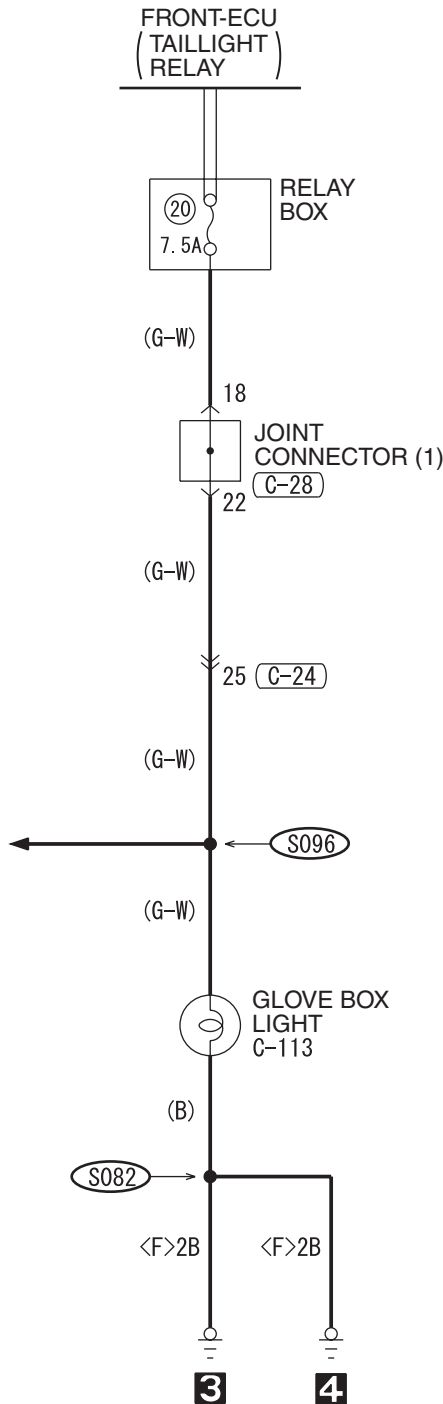

- AUDIO SYSTEM
- AUTOMATIC AIR CONDITIONING SYSTEM
- ELECTRONIC BRAKE-FORCE DISTRIBUTION (EBD) AND ANTI-LOCK BRAKING SYSTEM (ABS)
- <VEHICLES WITH TRACTION CONTROL SYSTEM (TCL)>
- FOG LIGHT
- HEATED SEAT
- INVECS-II 4A/T
- INVECS-II 5A/T
- MANUAL AIR CONDITIONING SYSTEM
- METER AND GAUGE
- MULTI-CENTER DISPLAY
- REAR WINDOW DEFOGGER AND DOOR MIRROR HEATER
- SUPPLEMENTAL RESTRAINT SYSTEM (SRS)
- TURN-SIGNAL LIGHT AND HAZARD WARNING LIGHT

C-24

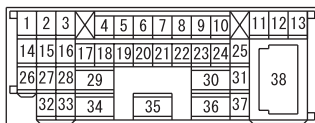

C-28



WIRE COLOR CODE

B : BLACK LG : LIGHT GREEN G : GREEN L : BLUE
 BR : BROWN O : ORANGE GR : GRAY R : RED W : WHITE
 SB : SKY BLUE P : PINK Y : YELLOW V : VIOLET PU : PURPLE

H6P08M04AA

M1901002400552

VANITY MIRROR LIGHT

1

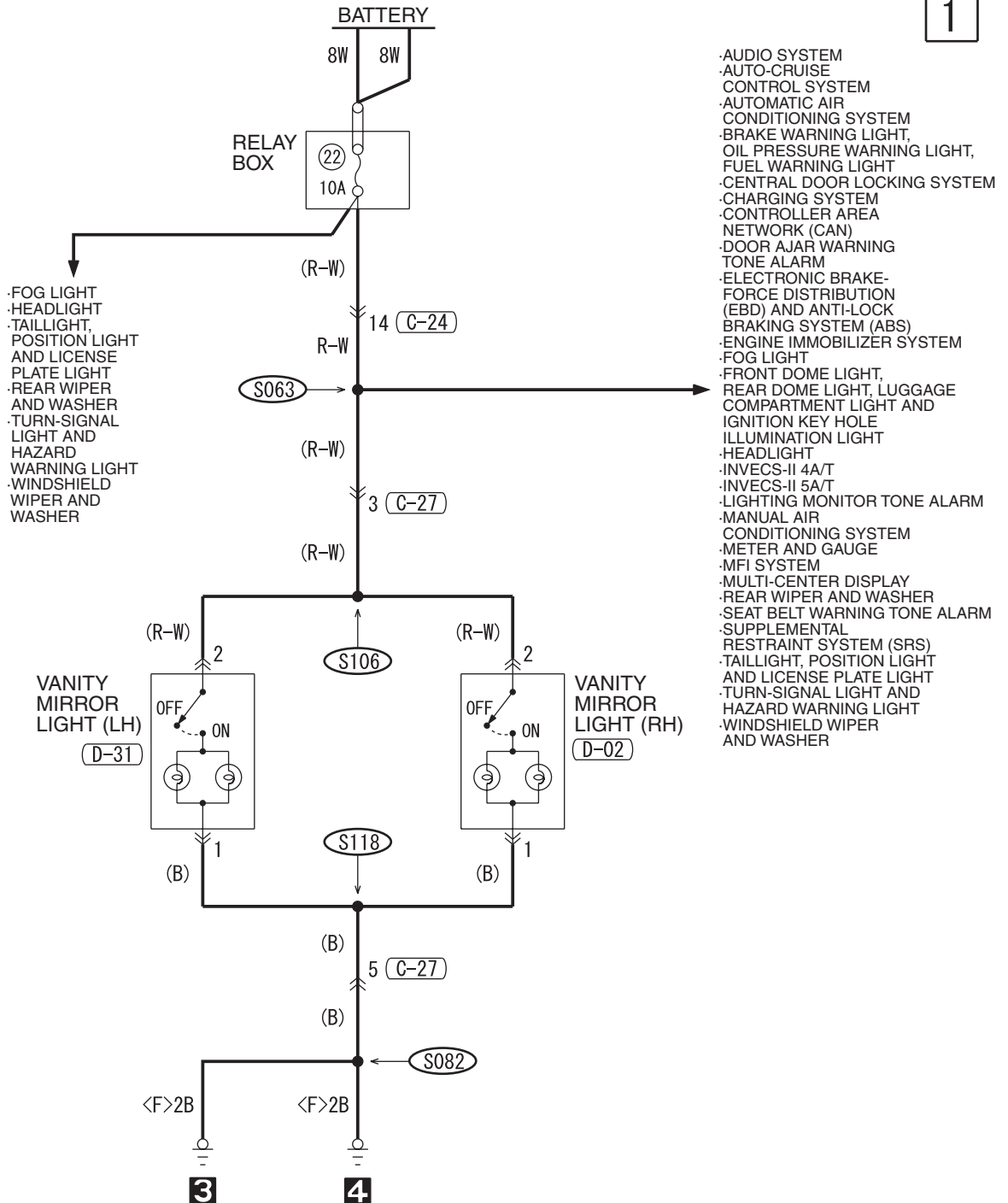

- AUDIO SYSTEM
- AUTO-CRUISE CONTROL SYSTEM
- AUTOMATIC AIR CONDITIONING SYSTEM
- BRAKE WARNING LIGHT, OIL PRESSURE WARNING LIGHT, FUEL WARNING LIGHT
- CENTRAL DOOR LOCKING SYSTEM
- CHARGING SYSTEM
- CONTROLLER AREA NETWORK (CAN)
- DOOR AJAR WARNING TONE ALARM
- ELECTRONIC BRAKE-FORCE DISTRIBUTION (EBD) AND ANTI-LOCK BRAKING SYSTEM (ABS)
- ENGINE IMMOBILIZER SYSTEM
- FOG LIGHT
- FRONT DOME LIGHT, REAR DOME LIGHT, LUGGAGE COMPARTMENT LIGHT AND IGNITION KEY HOLE ILLUMINATION LIGHT
- HEADLIGHT
- INVECS-II 4A/T
- INVECS-II 5A/T
- LIGHTING MONITOR TONE ALARM
- MANUAL AIR CONDITIONING SYSTEM
- METER AND GAUGE
- MFI SYSTEM
- MULTI-CENTER DISPLAY
- REAR WIPER AND WASHER
- SEAT BELT WARNING TONE ALARM
- SUPPLEMENTAL RESTRAINT SYSTEM (SRS)
- TAILLIGHT, POSITION LIGHT AND LICENSE PLATE LIGHT
- TURN-SIGNAL LIGHT AND HAZARD WARNING LIGHT
- WINDSHIELD WIPER AND WASHER

C-24

1	2	3	4	5	6	7	8	9	10	11	12	13
14	15	16	17	18	19	20	21	22	23	24	25	38
26	27	28	29	30	31							
32	33	34	35	36	37							

C-27 MU801695	D-02 MU801565	D-31 MU801565
------------------	------------------	------------------

WIRE COLOR CODE
 B : BLACK LG : LIGHT GREEN G : GREEN L : BLUE
 BR : BROWN O : ORANGE GR : GRAY R : RED W : WHITE
 SB : SKY BLUE P : PINK Y : YELLOW V : VIOLET PU : PURPLE

H6P08M05AA

TSB Revision

TURN-SIGNAL LIGHT AND HAZARD WARNING LIGHT

M1901002901613

1

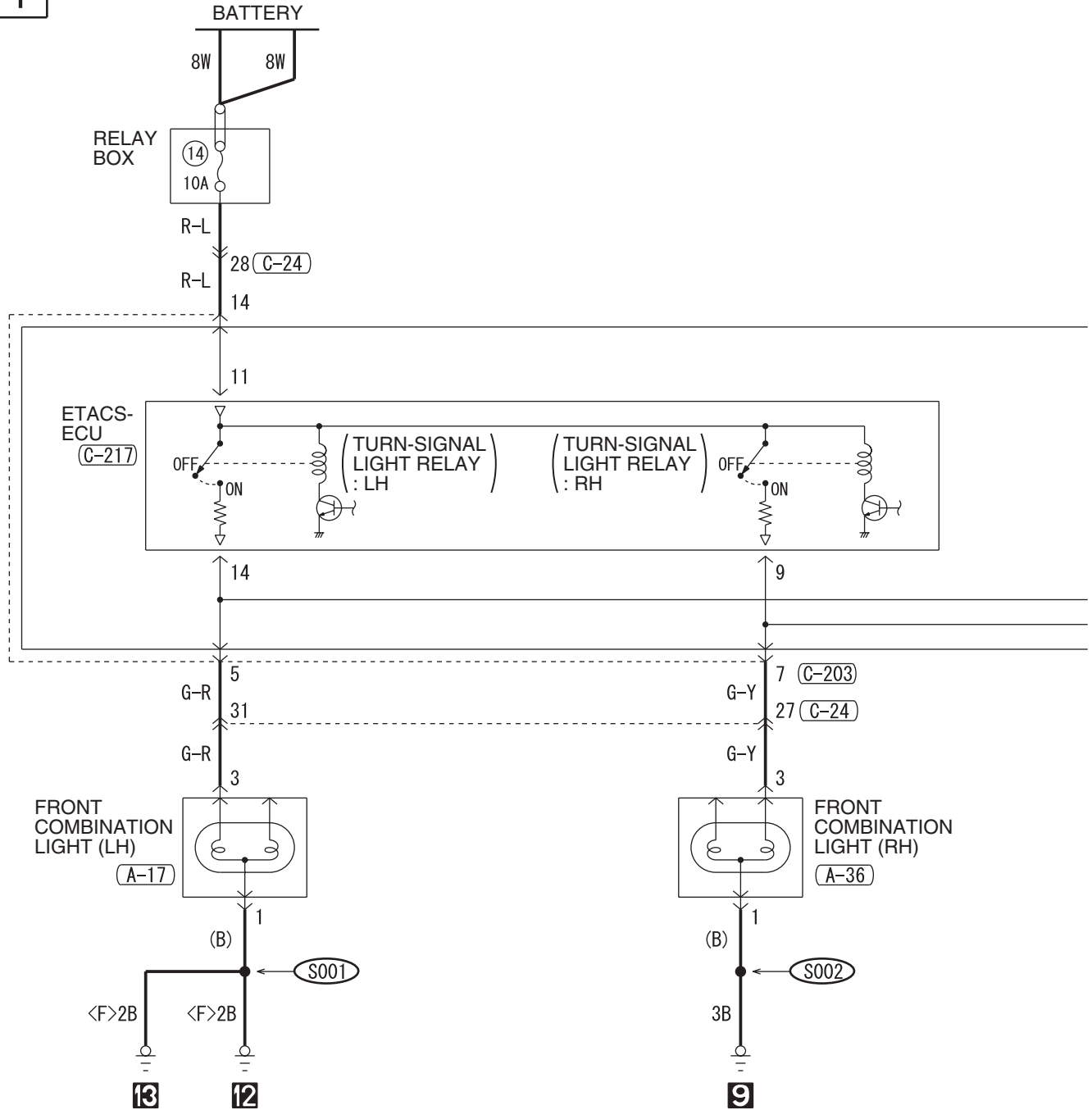

(A-17)

(A-36)

(C-24)

(C-203)

(C-208)

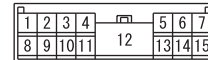
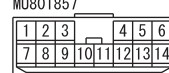
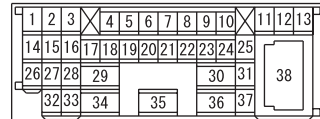
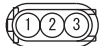

2

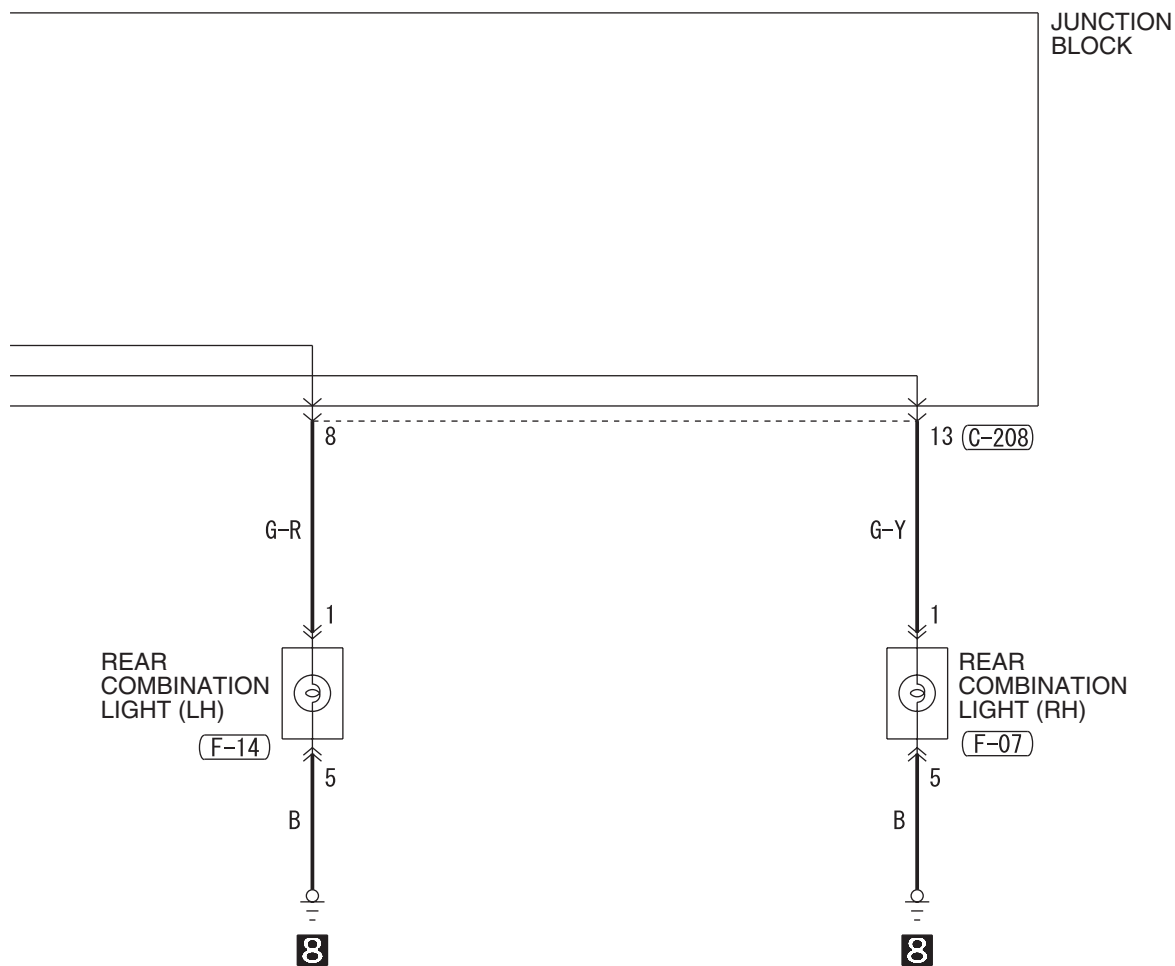

(C-217) JUNCTION BLOCK SIDE

20	19	18	17	16	15	14	13	12	11	10	9	8	7	6	5	4	3	2	1
----	----	----	----	----	----	----	----	----	----	----	---	---	---	---	---	---	---	---	---

(F-07)

MU801698					
1		2			
3	4	5	6		

(F-14)

MU801698					
1		2			
3	4	5	6		

WIRE COLOR CODE

B : BLACK LG : LIGHT GREEN G : GREEN L : BLUE W : WHITE Y : YELLOW SB : SKY BLUE
BR : BROWN O : ORANGE GR : GRAY R : RED P : PINK V : VIOLET PU : PURPLE

H6P09M00AB

TURN-SIGNAL LIGHT AND HAZARD WARNING LIGHT (CONTINUED)

3

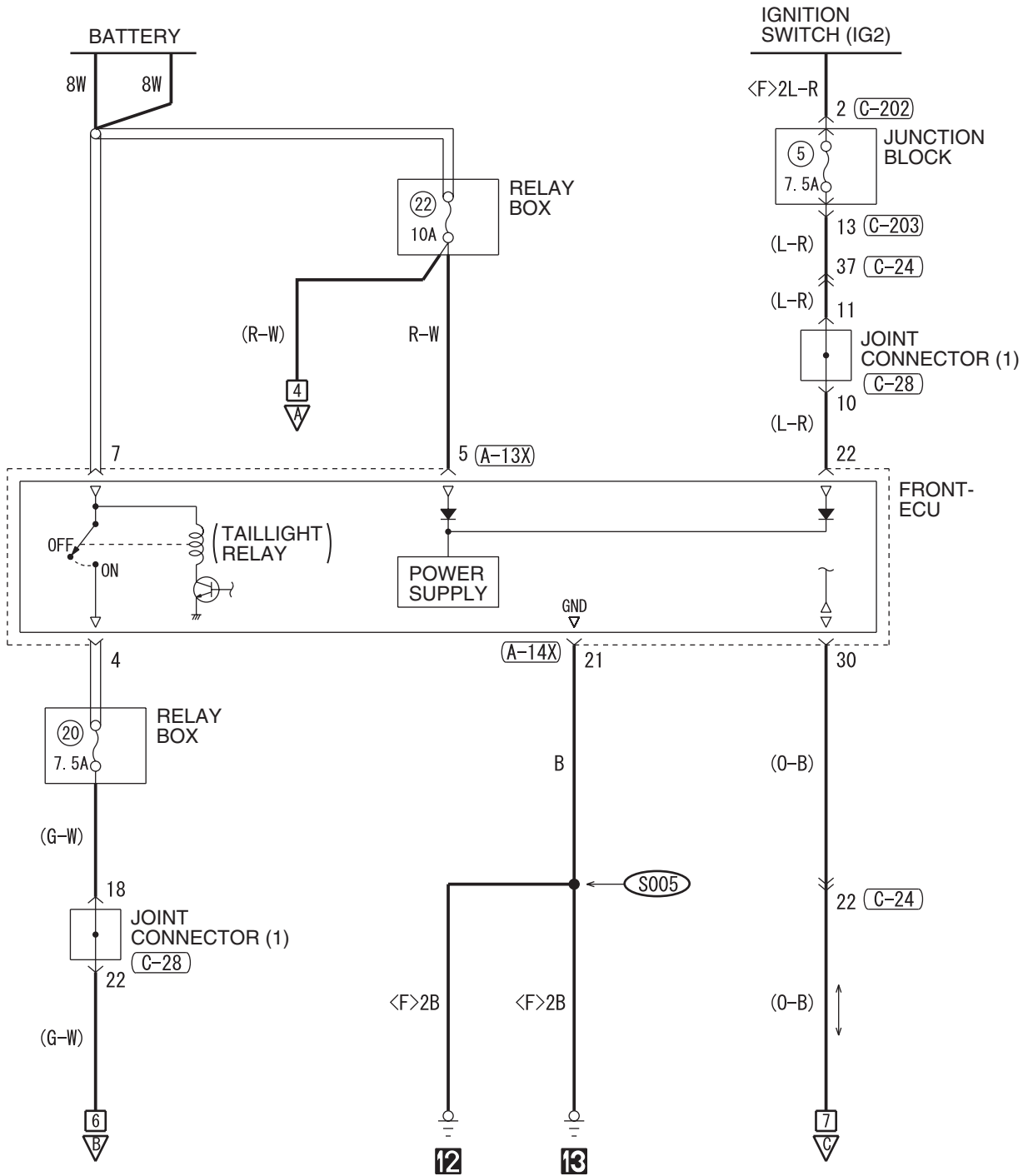

(A-13X)

1	2	3	4	5	6	7	8	9	10	11
---	---	---	---	---	---	---	---	---	----	----

(A-14X)

21	22	23	24	25	26	27	28	29	30	31
----	----	----	----	----	----	----	----	----	----	----

(C-01)

1	2	3	4	5	6	7	8	9	10	11
12	13	14	15	16	17	18	19	20	21	22
23	24	25	26	27	28	29	30	31	32	33

(C-24)

1	2	3	4	5	6	7	8	9	10	11	12	13
14	15	16	17	18	19	20	21	22	23	24	25	
26	27	28	29			30	31					
32	33	34		35		36	37			38		

(C-28)

1	2	3	4	5	6	7	8	9	10	11
12	13	14	15	16	17	18	19	20	21	22
23	24	25	26	27	28	29	30	31	32	33

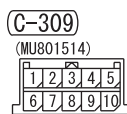
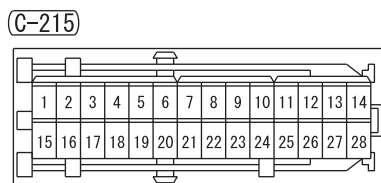
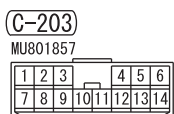
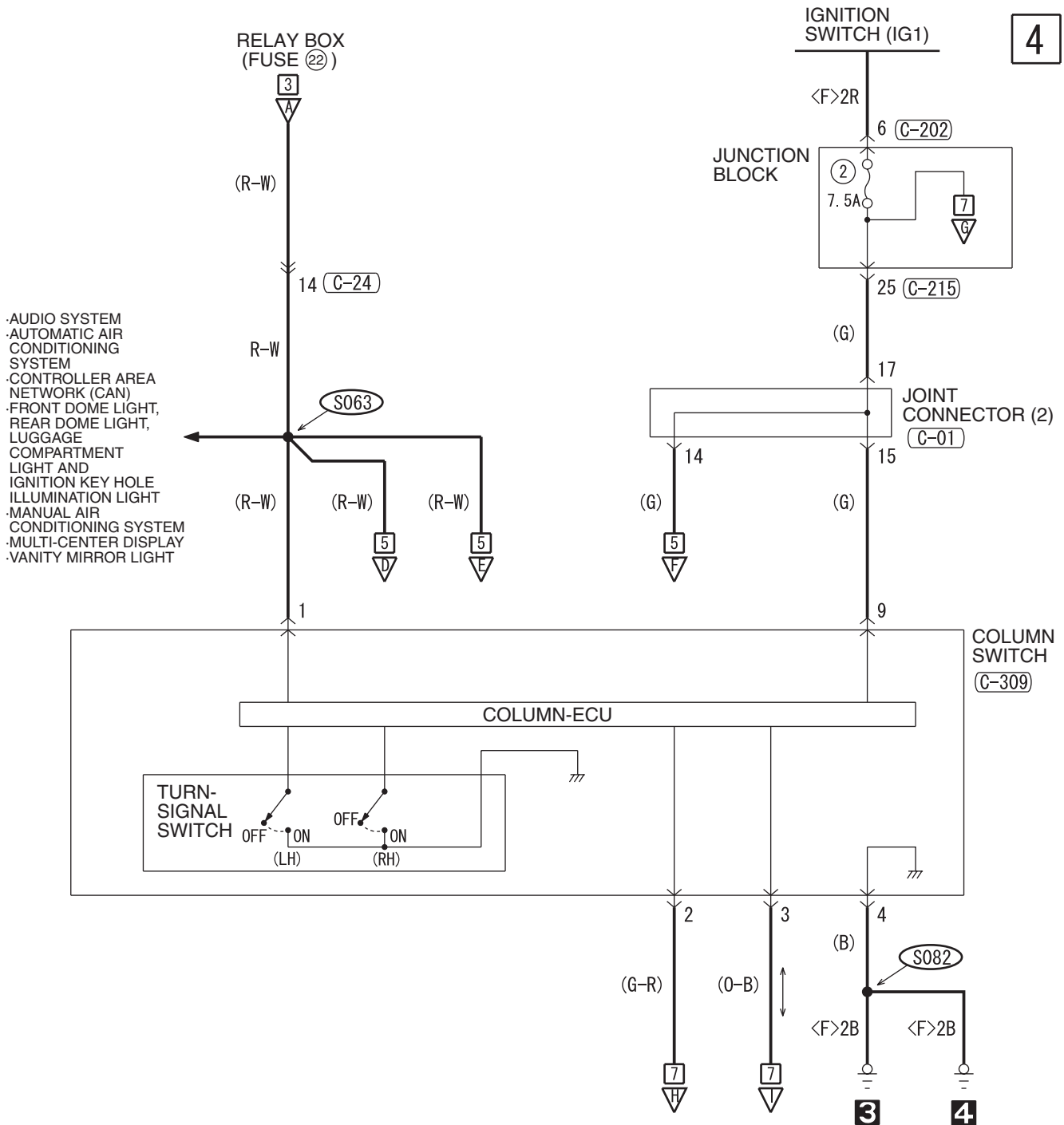

WIRE COLOR CODE
 B: BLACK LG: LIGHT GREEN G: GREEN L: BLUE W: WHITE Y: YELLOW SB: SKY BLUE
 BR: BROWN O: ORANGE GR: GRAY R: RED P: PINK V: VIOLET PU: PURPLE

H6P09M00BB

TURN-SIGNAL LIGHT AND HAZARD WARNING LIGHT (CONTINUED)

5

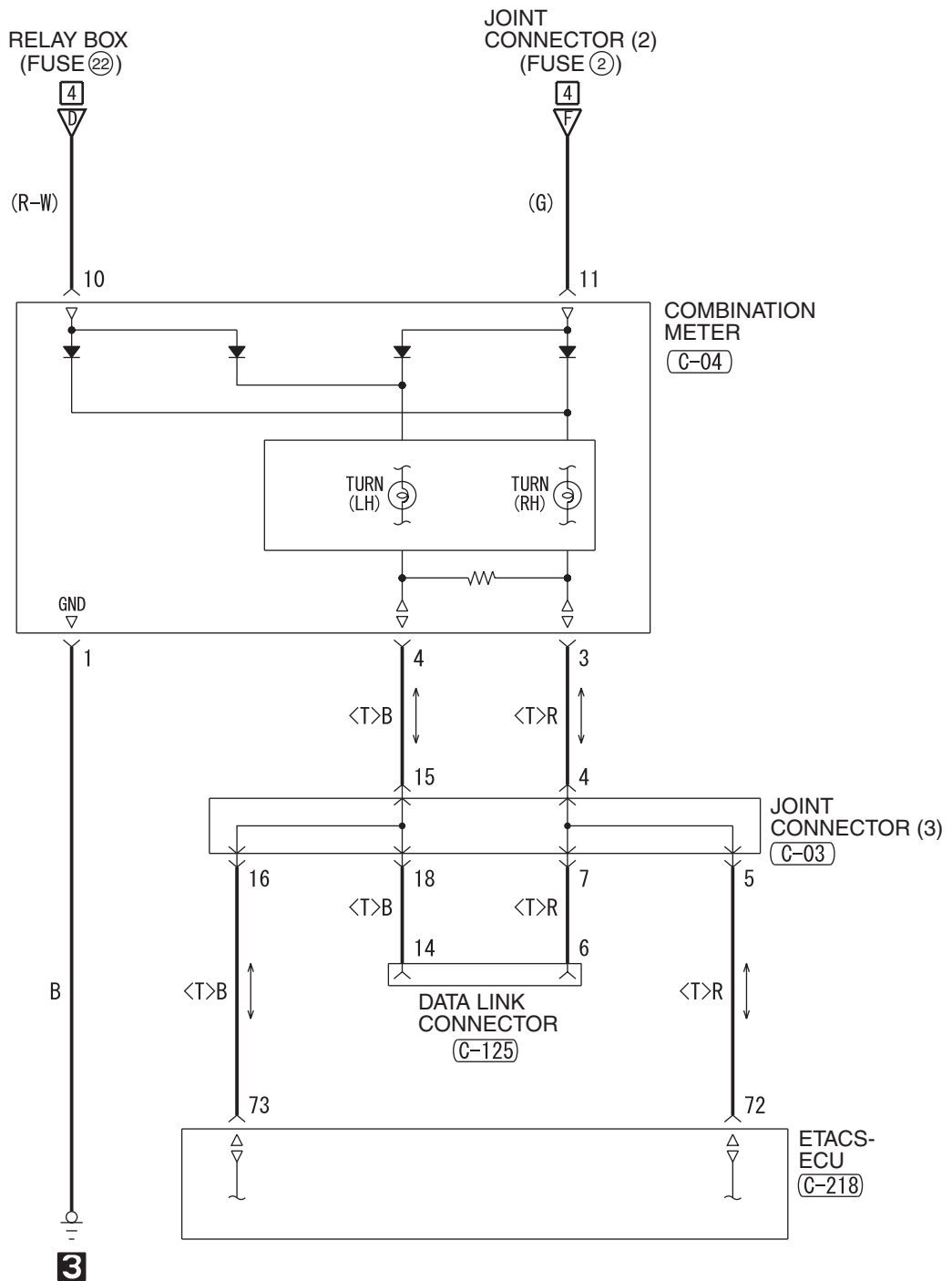

(C-03)

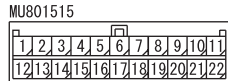

(C-04)

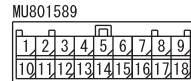

(C-08)

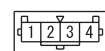

(C-24)

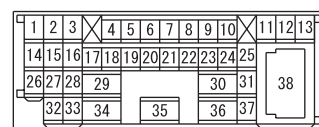

(C-125) FRONT SIDE



6

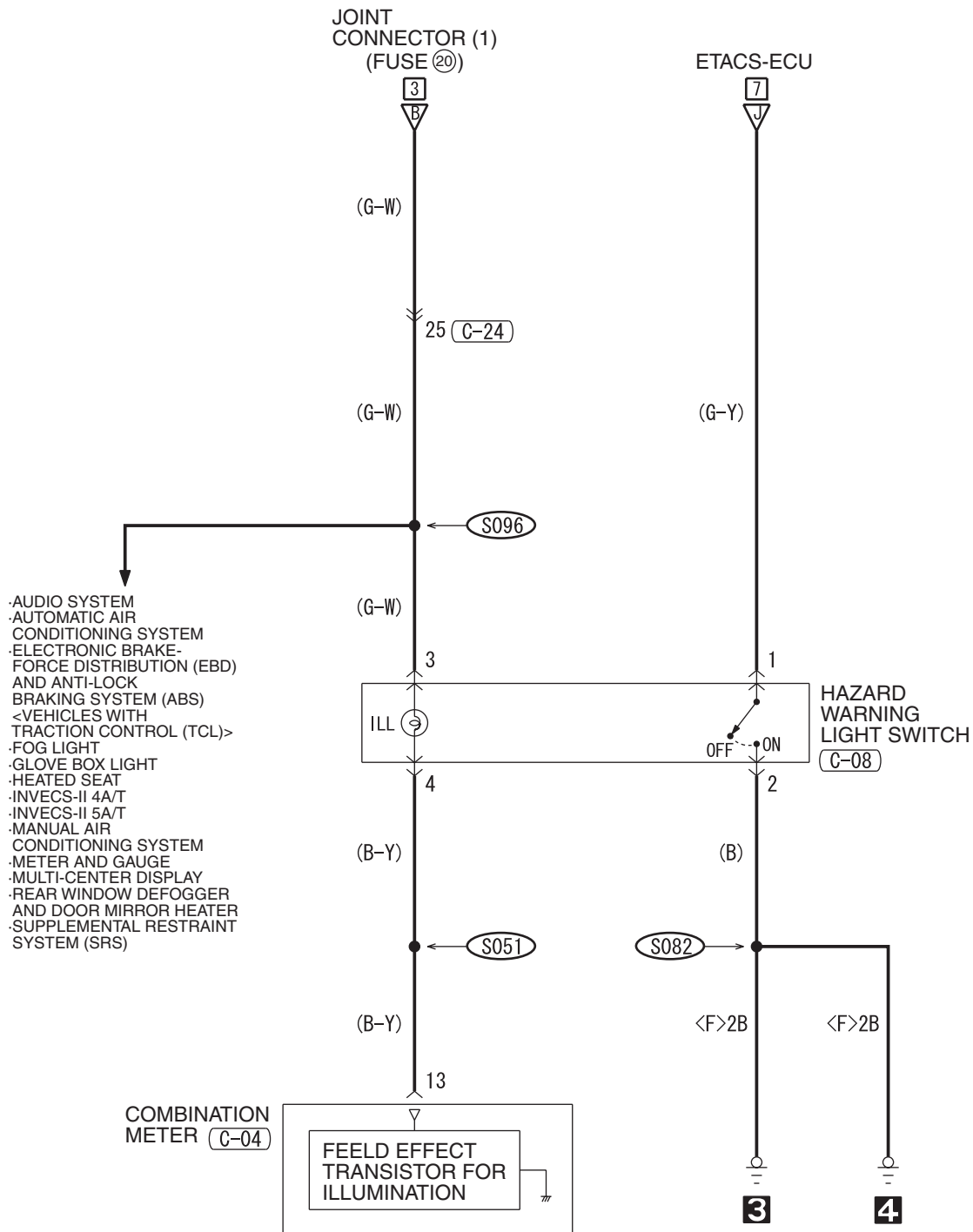

C-218
(MU803766)

51	52	53	54	55	56	57	58	59
60	61	62	63	64	65	66	67	68
69	70	71				72	73	74

WIRE COLOR CODE
 B : BLACK LG : LIGHT GREEN G : GREEN L : BLUE W : WHITE Y : YELLOW SB : SKY BLUE
 BR : BROWN O : ORANGE GR : GRAY R : RED P : PINK V : VIOLET PU : PURPLE

H6P09M00CB

TSB Revision

TURN-SIGNAL LIGHT AND HAZARD WARNING LIGHT (CONTINUED)

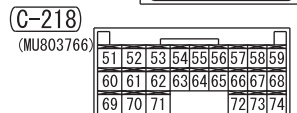
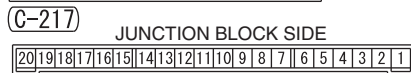
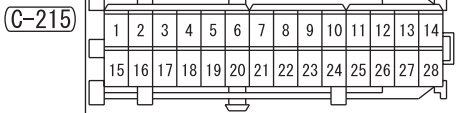
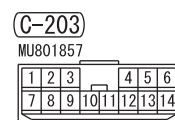
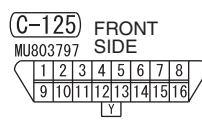
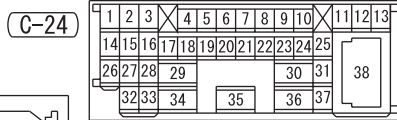
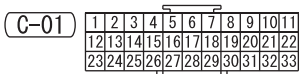
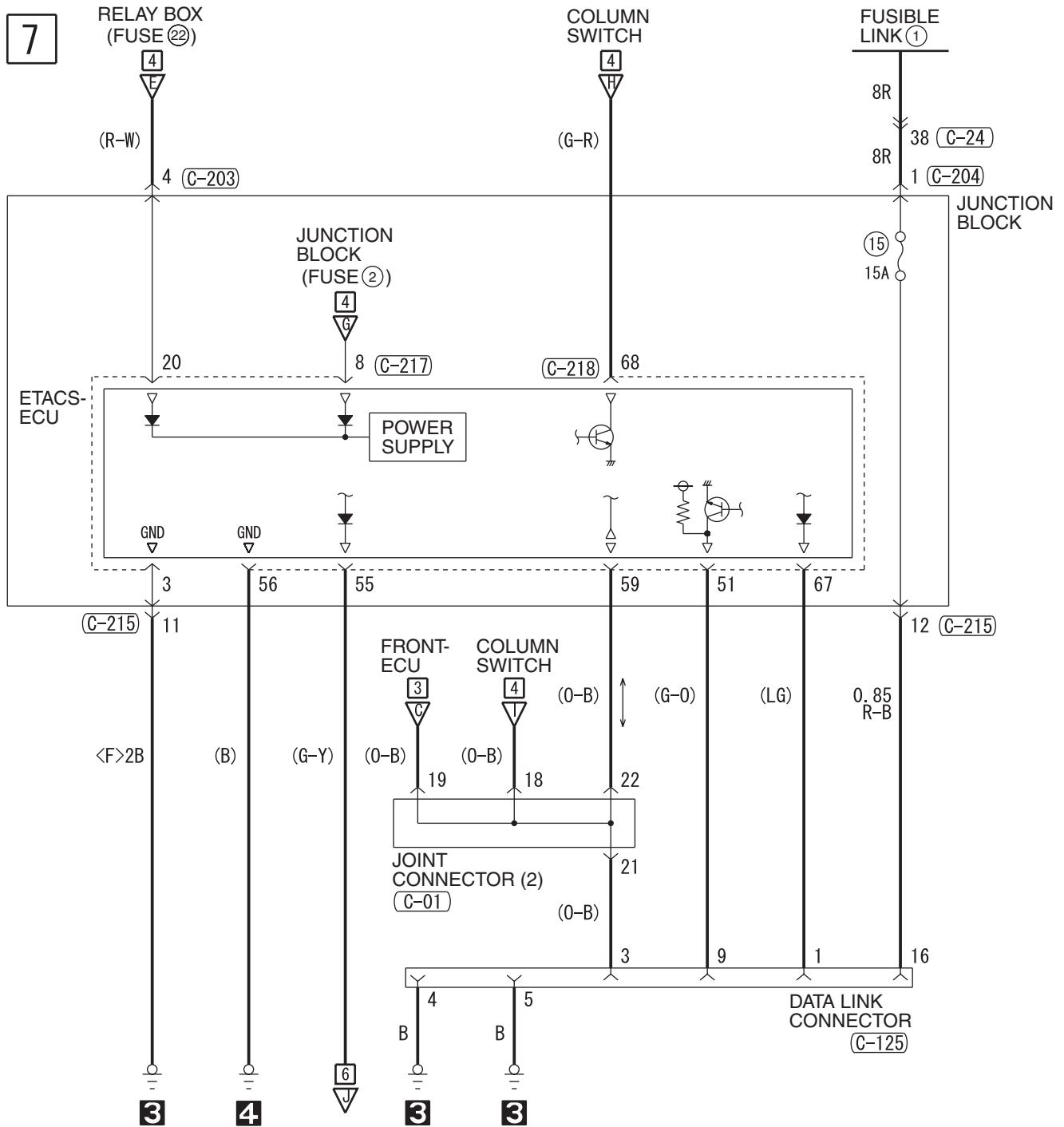

H6P09M00DA

NOTES

BACKUP LIGHT <M/T>

M1901003101836

1

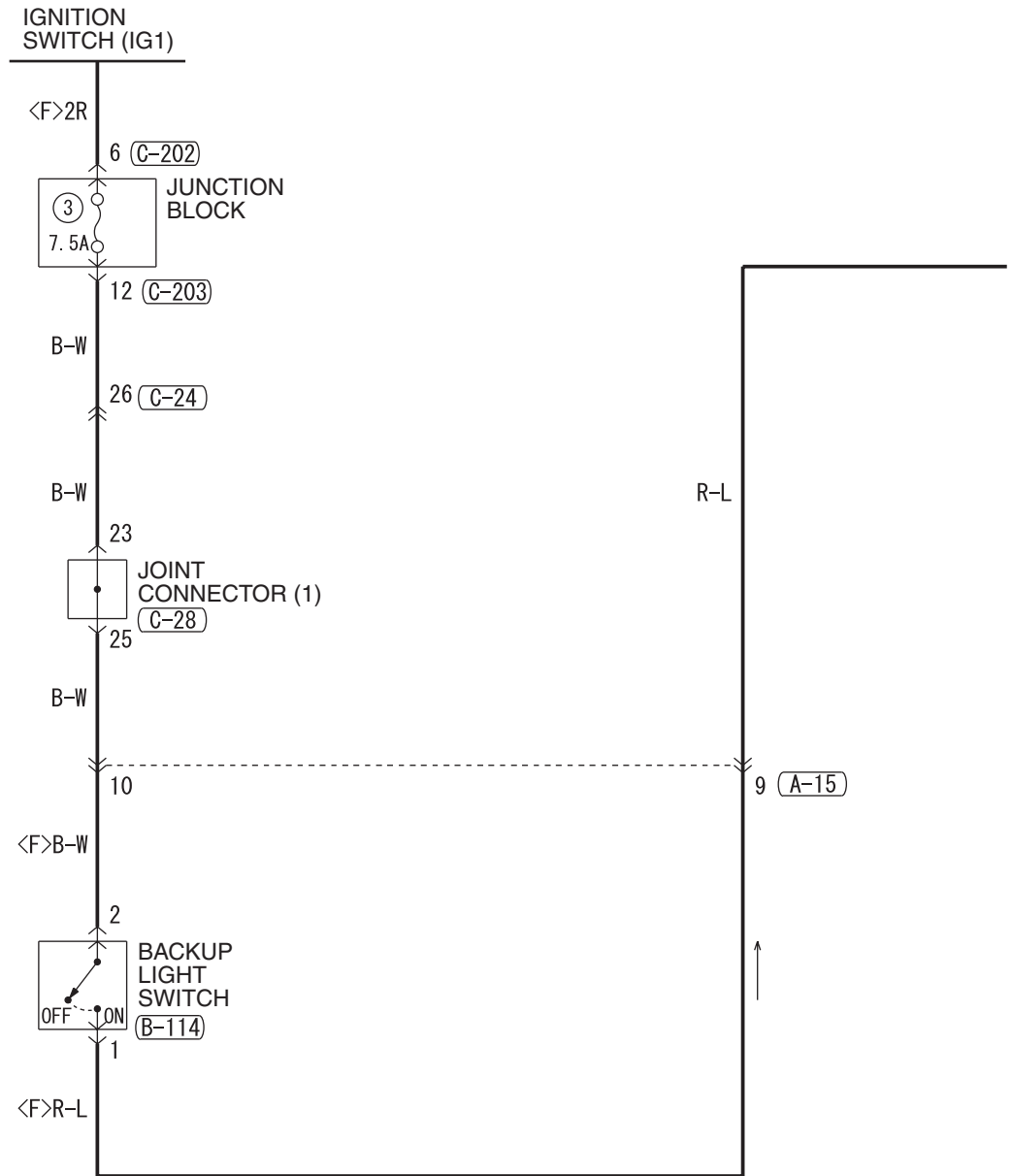

(A-15)

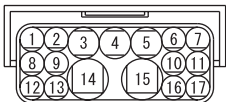

(B-114)



(C-24)

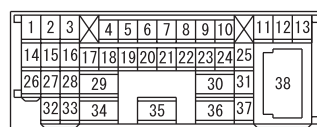

(C-26)

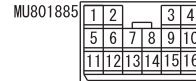

(C-28)

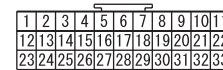

(C-202)



H6P09M01AA

TSB Revision

2

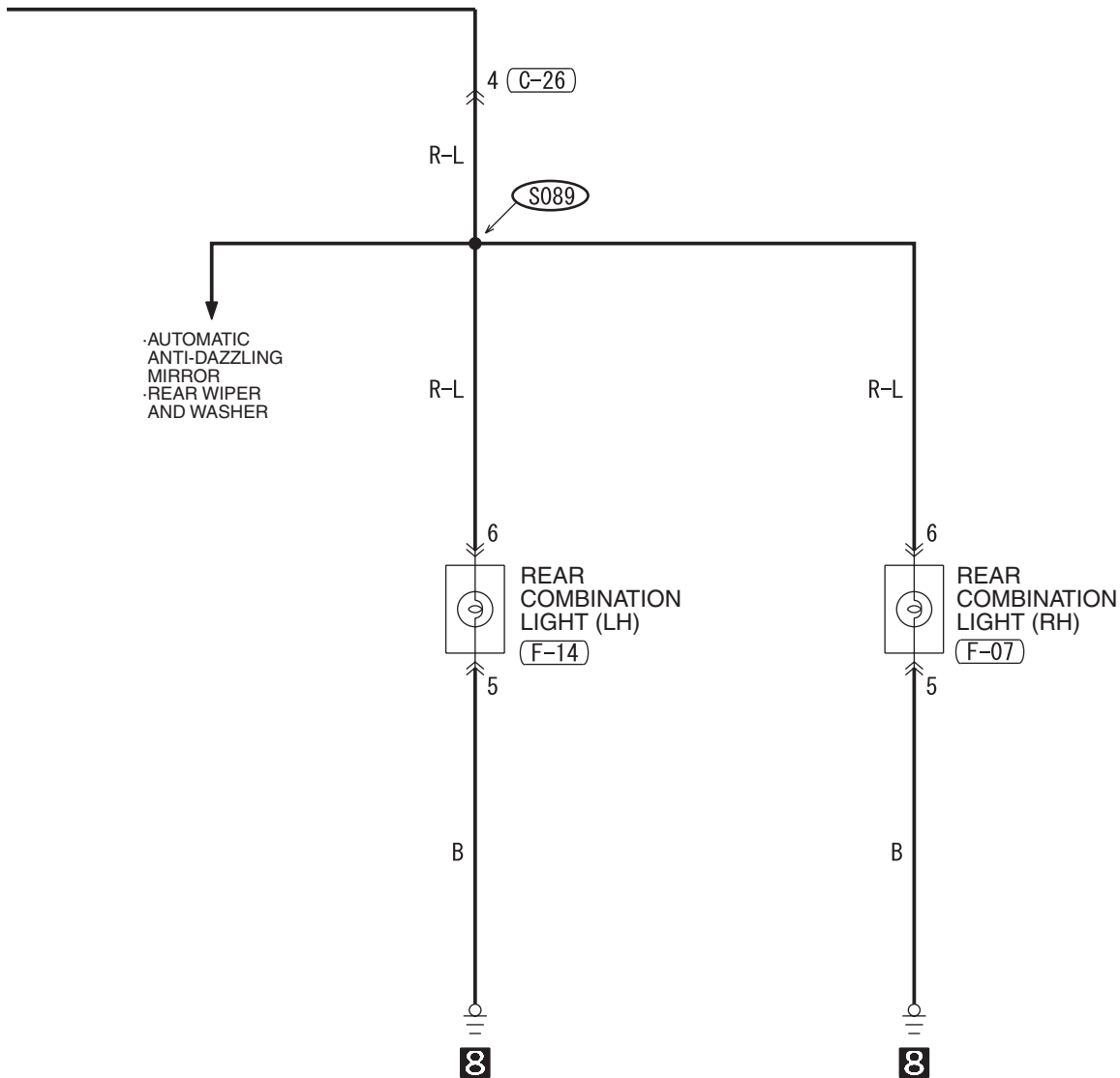

(C-203)

MU801857

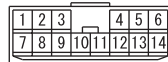

(F-07)

MU801698



(F-14)

MU801698



WIRE COLOR CODE

B: BLACK LG: LIGHT GREEN G: GREEN L: BLUE W: WHITE Y: YELLOW SB: SKY BLUE
 BR: BROWN O: ORANGE GR: GRAY R: RED P: PINK V: VIOLET PU: PURPLE

H6P09M01AB

TSB Revision

BACKUP LIGHT <A/T>

M1901003101847

1

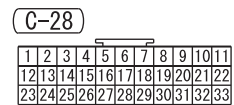
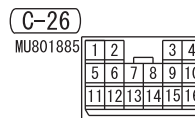
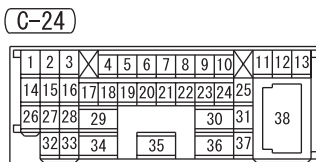
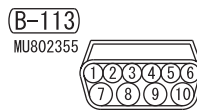
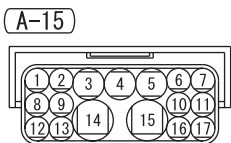
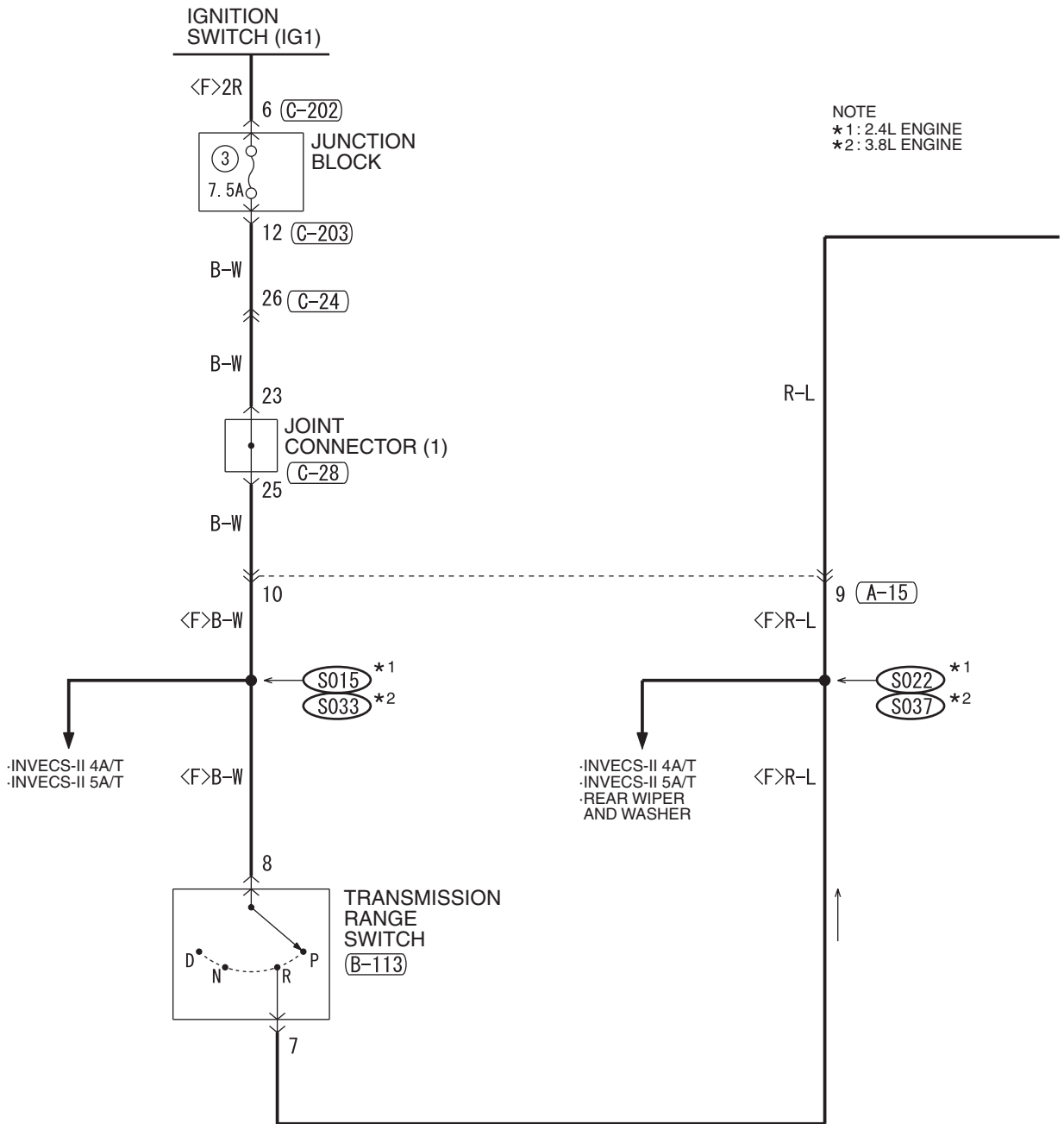

H6P09M02AA

2

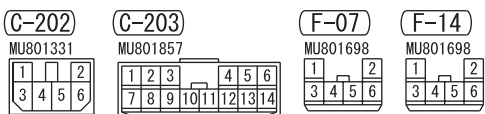
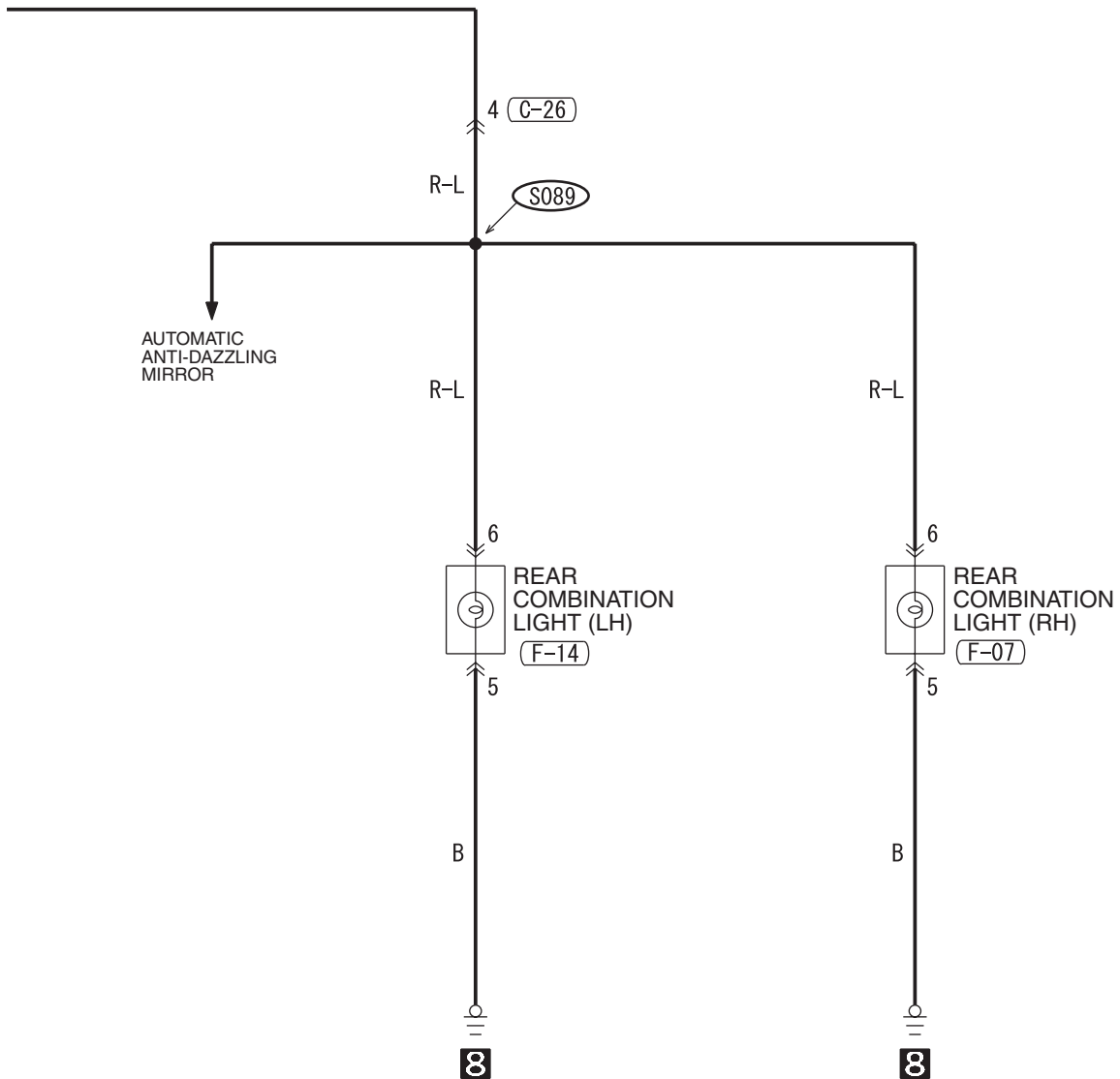

WIRE COLOR CODE
 B : BLACK LG : LIGHT GREEN G : GREEN L : BLUE W : WHITE Y : YELLOW SB : SKY BLUE
 BR : BROWN O : ORANGE GR : GRAY R : RED P : PINK V : VIOLET PU : PURPLE

H6P09M02AB

TSB Revision

STOPLIGHT

M1901003001680

1

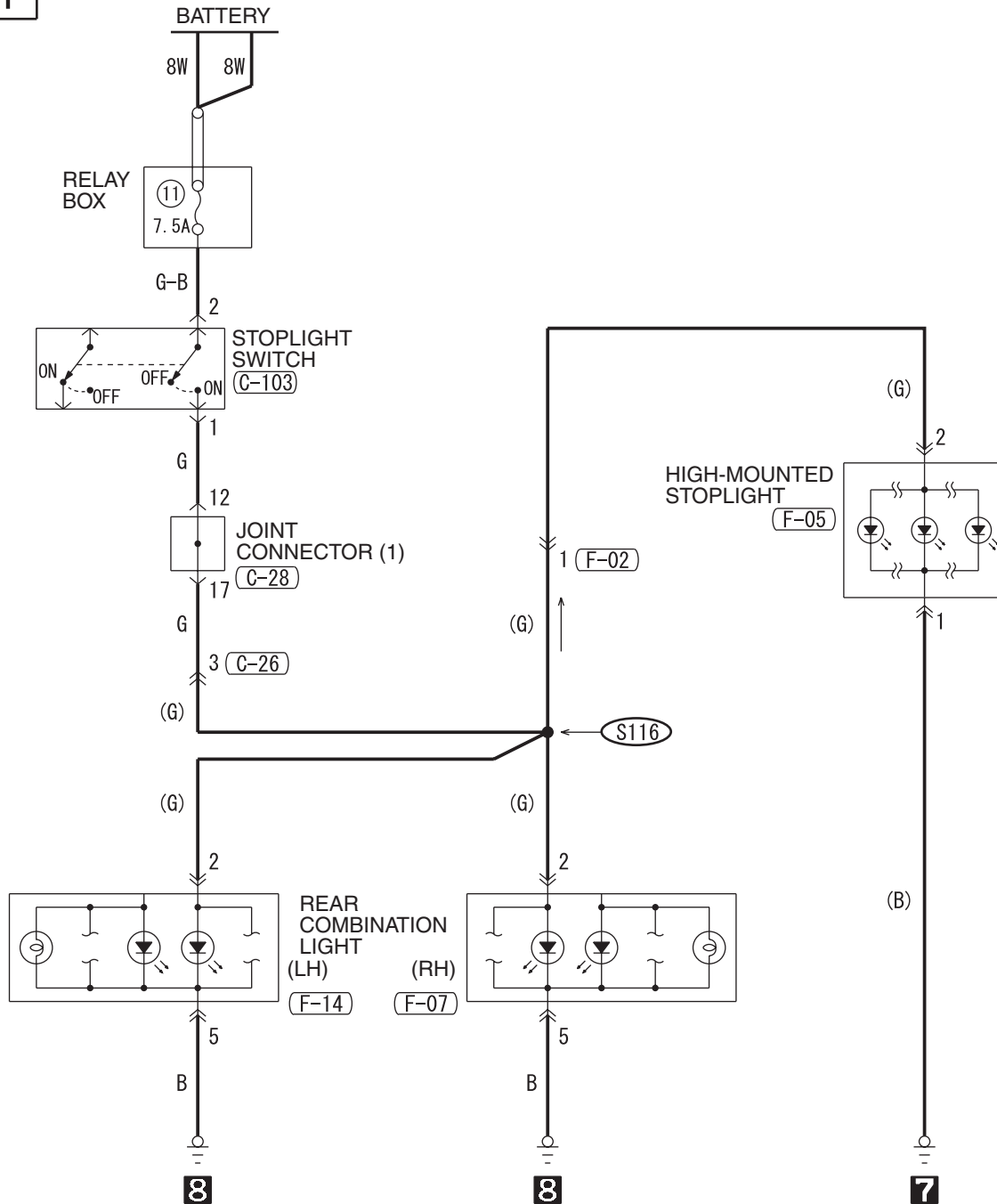

(C-26)

1	2	3	4
5	6	7	8
9	10	11	12
13	14	15	16

(C-28)

1	2	3	4	5	6	7	8	9	10	11
12	13	14	15	16	17	18	19	20	21	22
23	24	25	26	27	28	29	30	31	32	33

(C-103)

1	2
3	4

(F-02)

1	2
3	4
5	6

(F-05)

1	2
---	---

(F-07)

1	2
3	4
5	6

(F-14)

1	2
3	4
5	6

WIRE COLOR CODE

B : BLACK LG : LIGHT GREEN G : GREEN L : BLUE W : WHITE Y : YELLOW SB : SKY BLUE
BR : BROWN O : ORANGE GR : GRAY R : RED P : PINK V : VIOLET PU : PURPLE

H6P09M03AA

HORN

M1901003301272

1

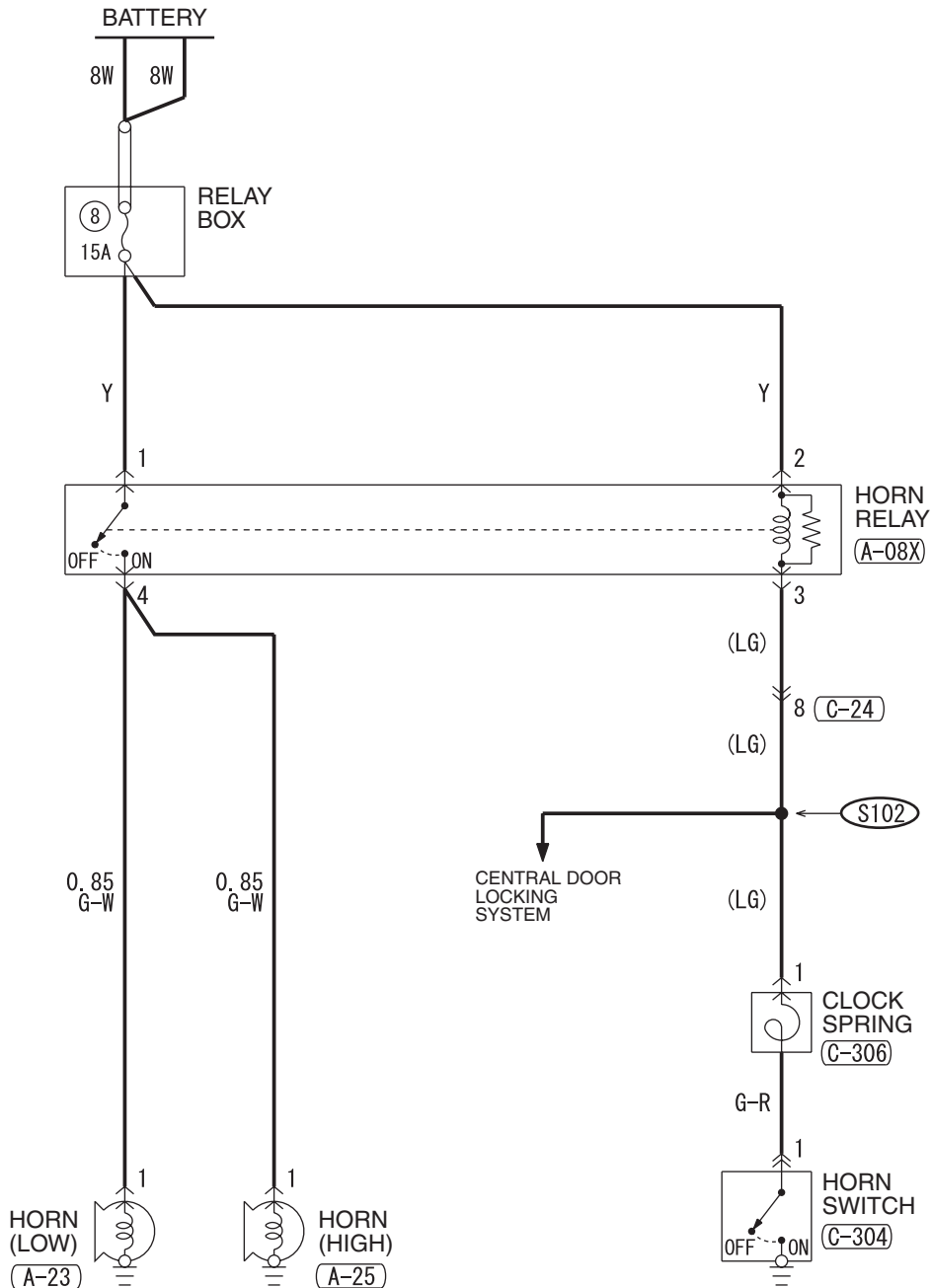

(A-08X)



(A-23)



(A-25)



(C-24)

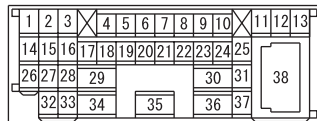

(C-304)



(C-306)

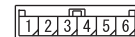

WIRE COLOR CODE
 B : BLACK SB : SKY BLUE
 BR : BROWN LG : LIGHT GREEN
 G : GREEN P : PINK GR : GRAY
 R : RED L : BLUE Y : YELLOW
 V : VIOLET W : WHITE O : ORANGE
 PU : PURPLE

H6P09M04AA

METER AND GAUGE <M/T>

M1901003501867

1

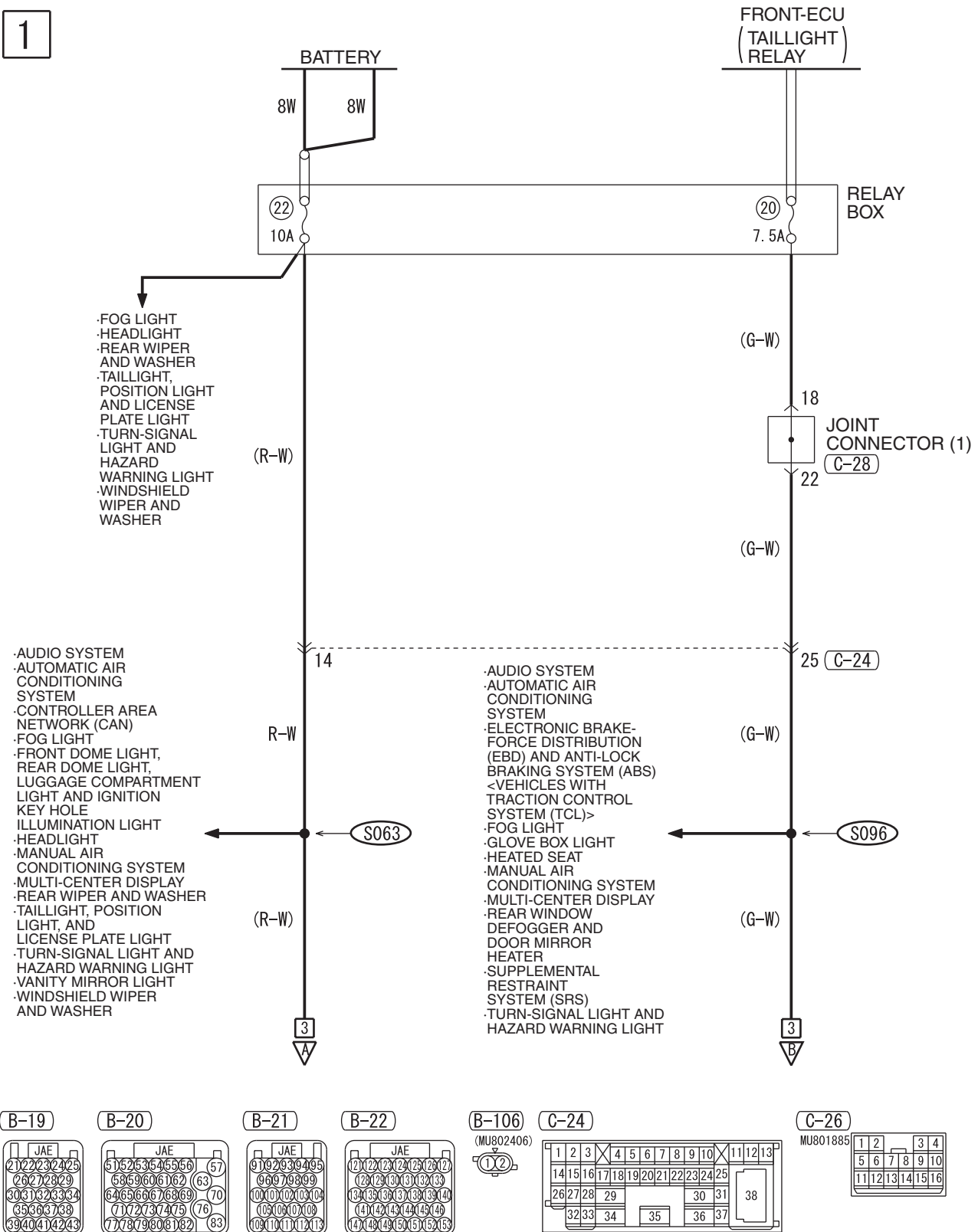

H6P10M00AA

2

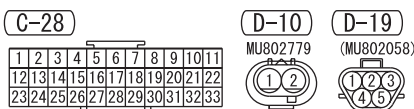
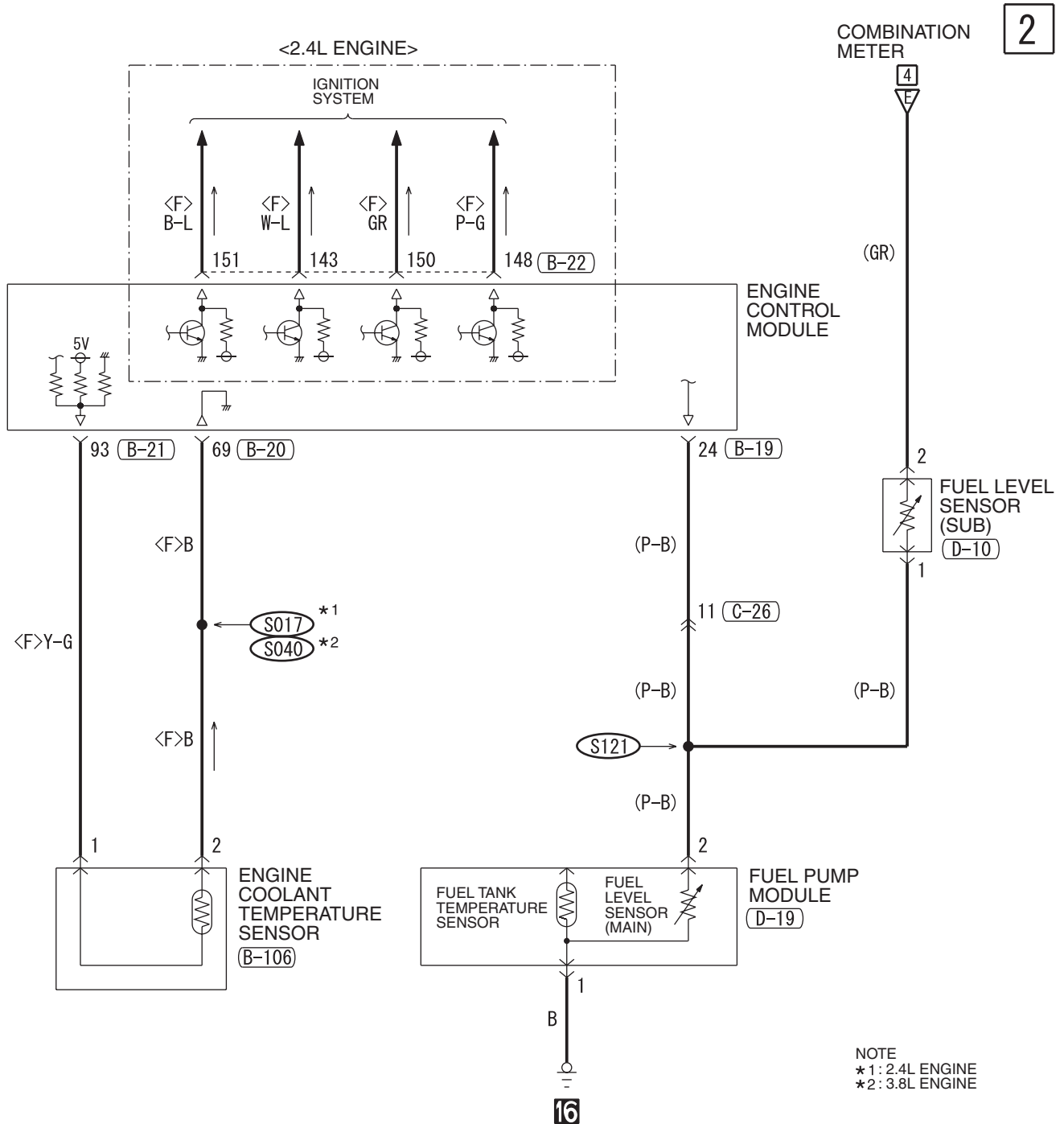

WIRE COLOR CODE
 B: BLACK LG: LIGHT GREEN G: GREEN L: BLUE
 BR: BROWN O: ORANGE GR: GRAY R: RED W: WHITE
 SB: SKY BLUE P: PINK Y: YELLOW V: VIOLET PU: PURPLE H6P10M00AB

TSB Revision

METER AND GAUGE <M/T> (CONTINUED)

3

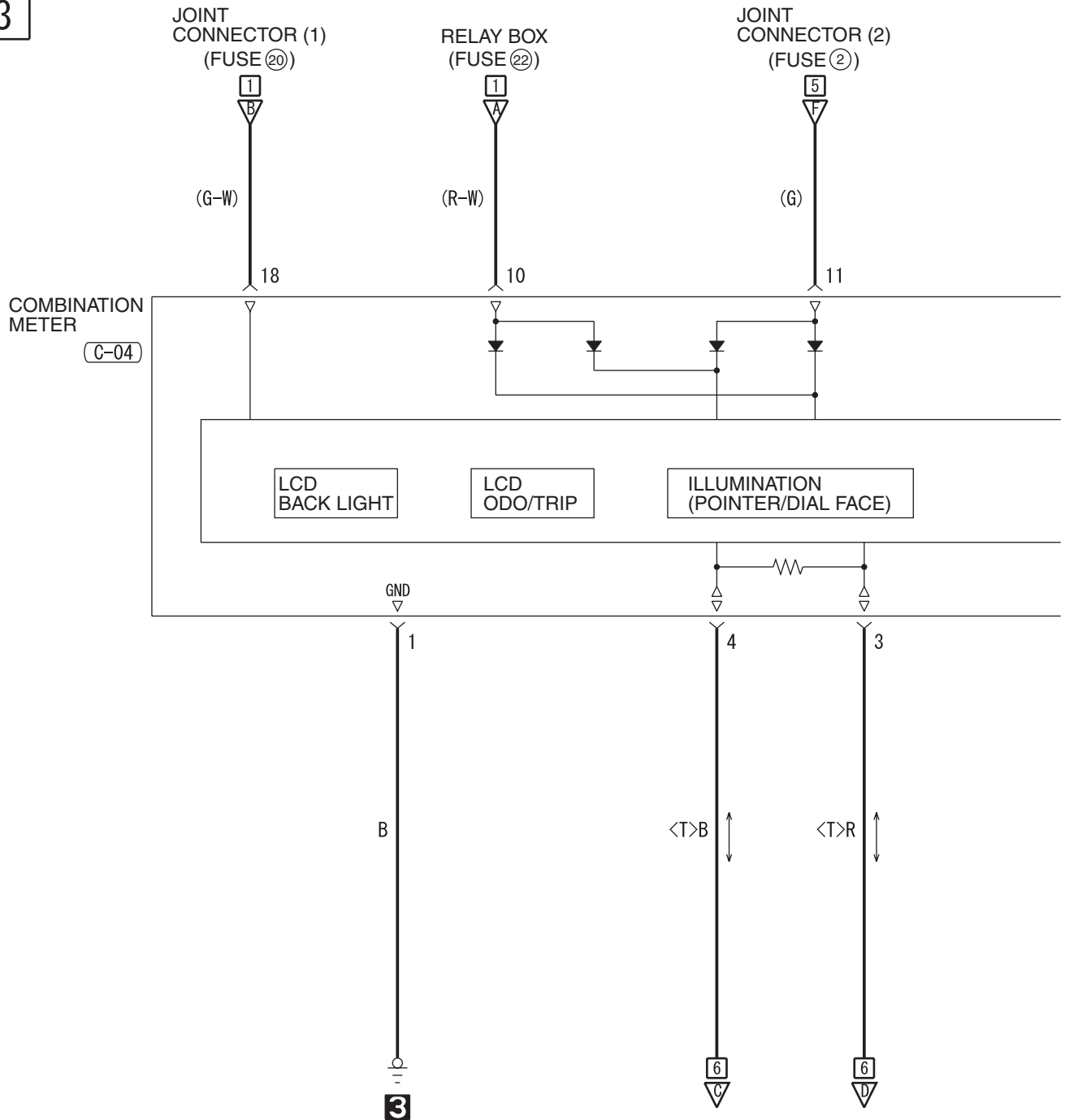

C-04

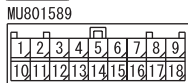

C-23

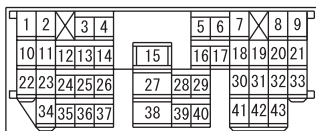

4

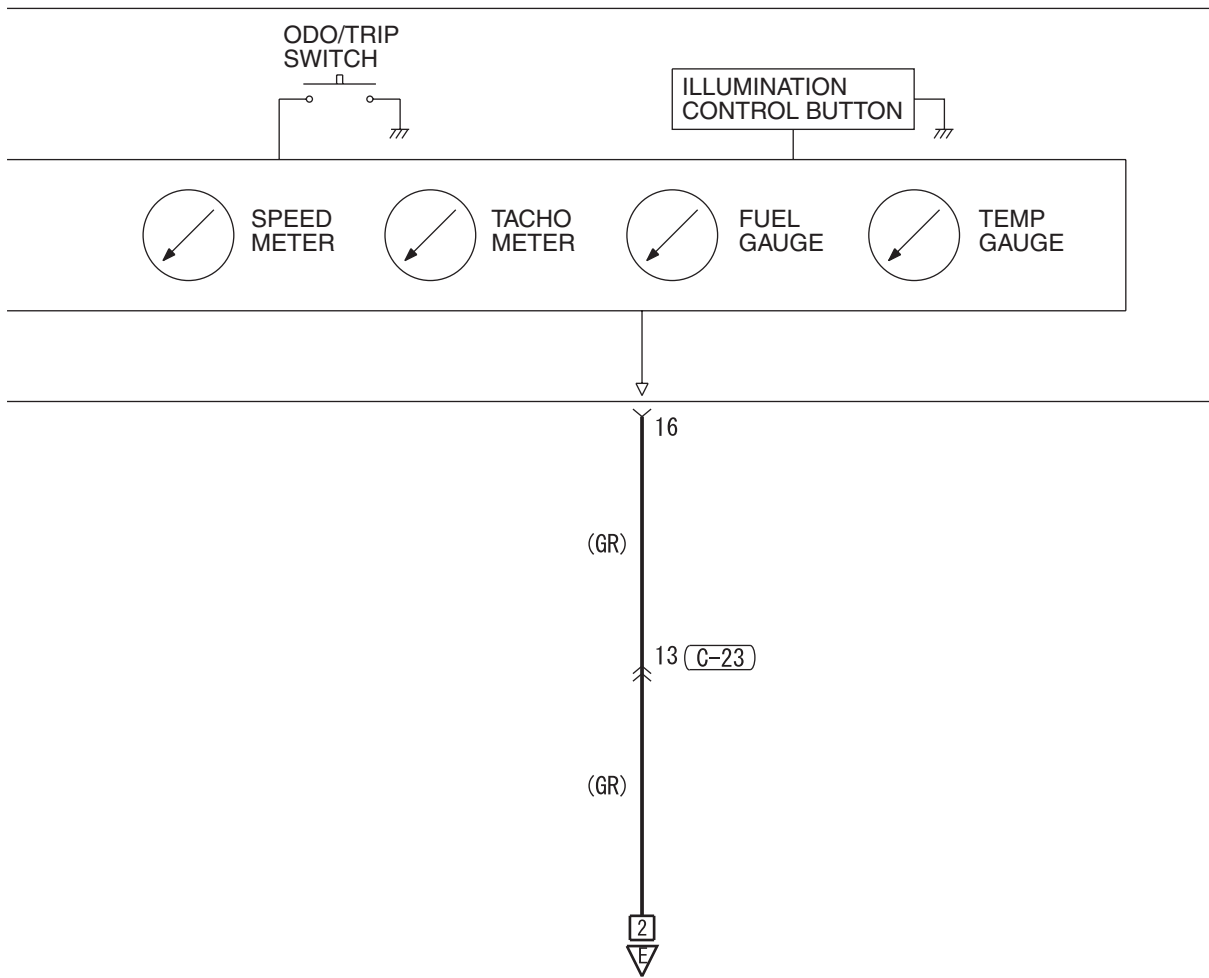

WIRE COLOR CODE
B : BLACK LG : LIGHT GREEN G : GREEN L : BLUE W : WHITE Y : YELLOW SB : SKY BLUE
BR : BROWN O : ORANGE GR : GRAY R : RED P : PINK V : VIOLET PU : PURPLE

H6P10M00BB

TSB Revision

METER AND GAUGE <M/T> (CONTINUED)

5

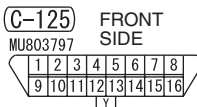
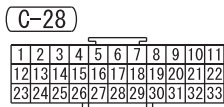
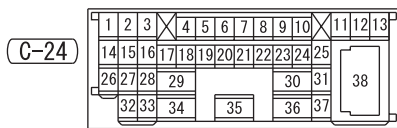
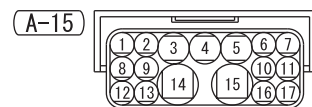
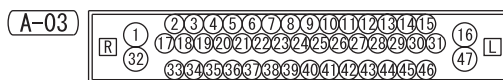
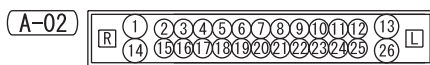
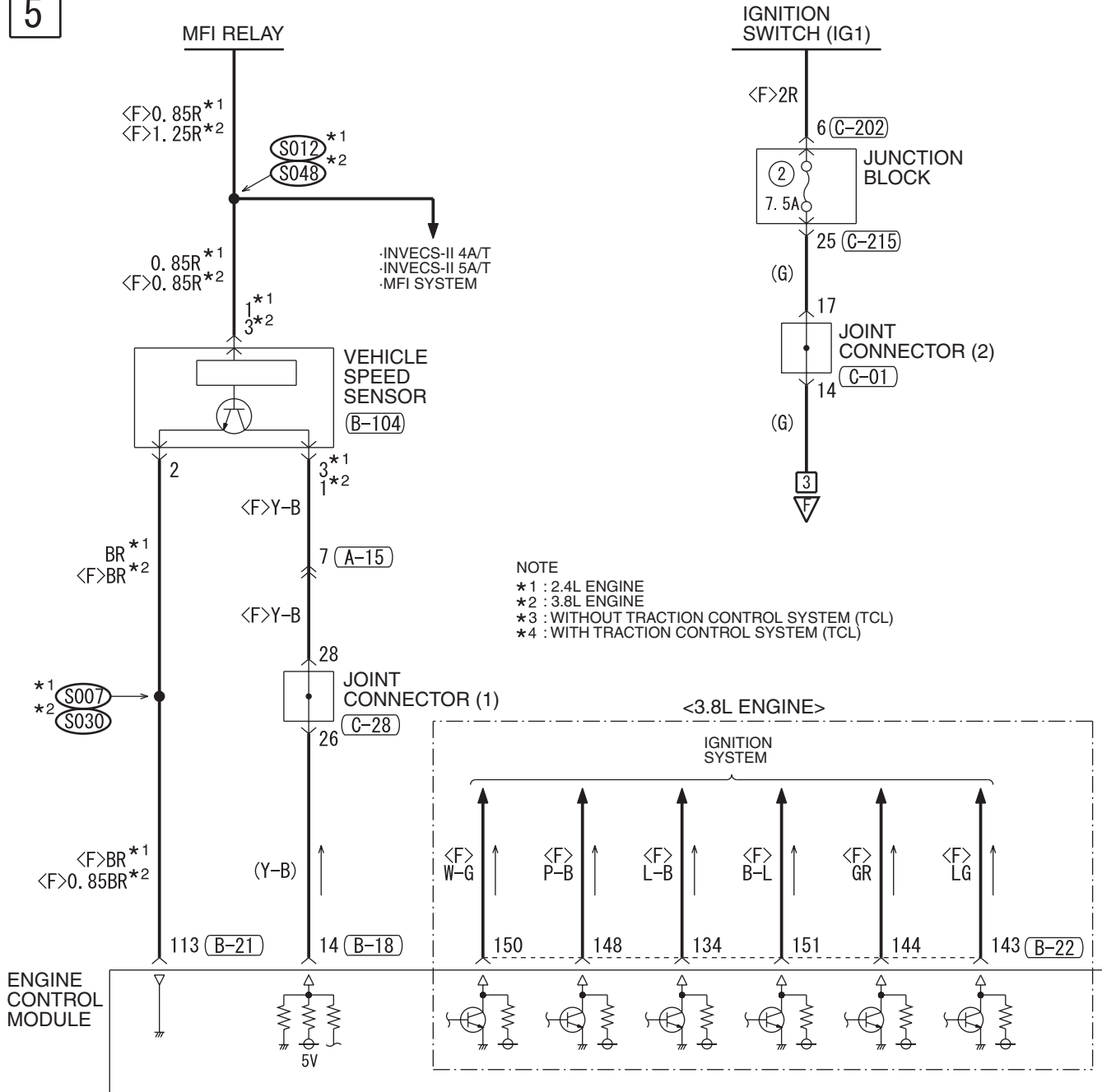

H6P10M00CA

6

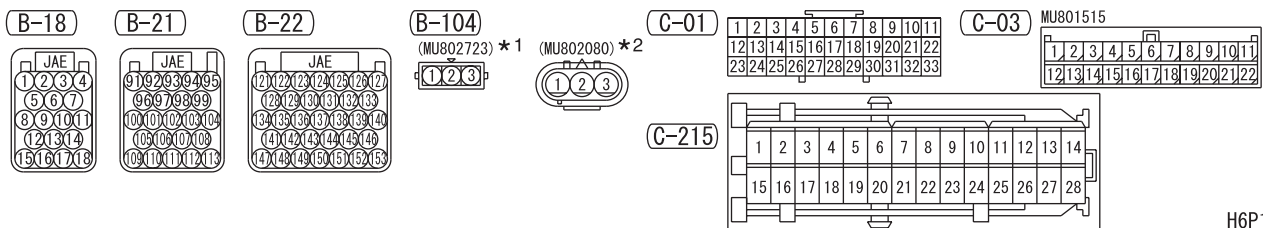
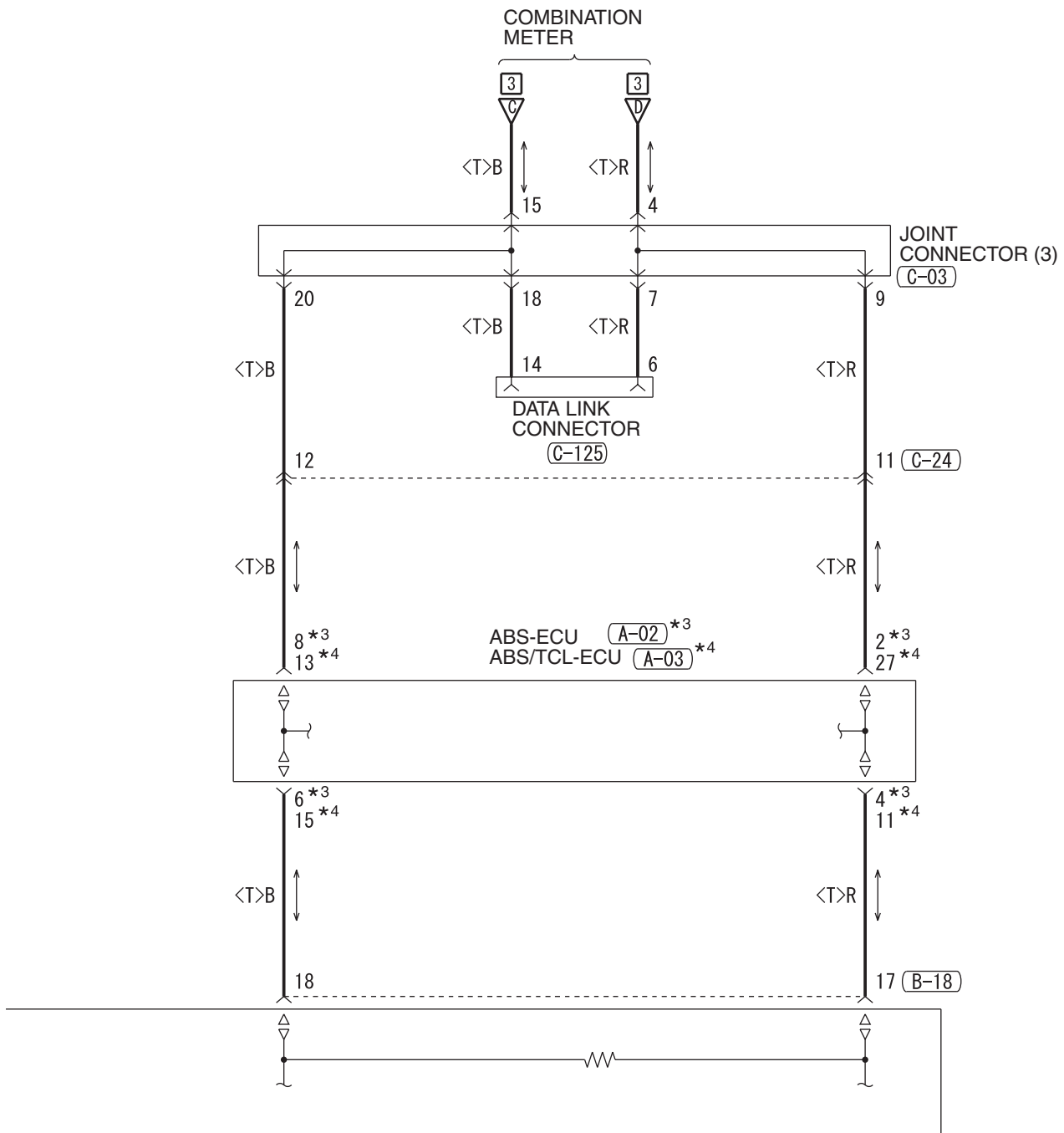

H6P10M00CB

METER AND GAUGE <A/T>

M1901003501878

1

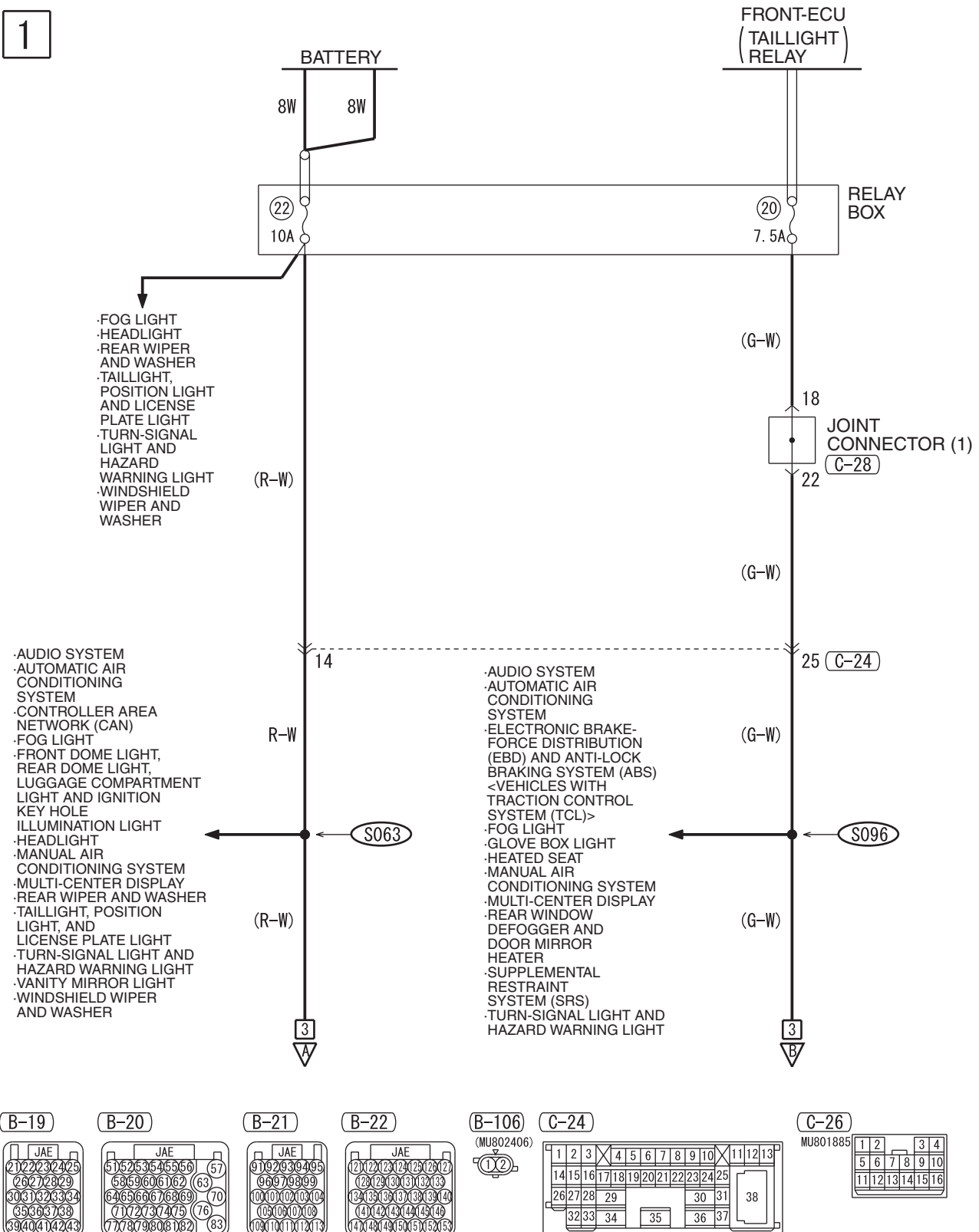

2

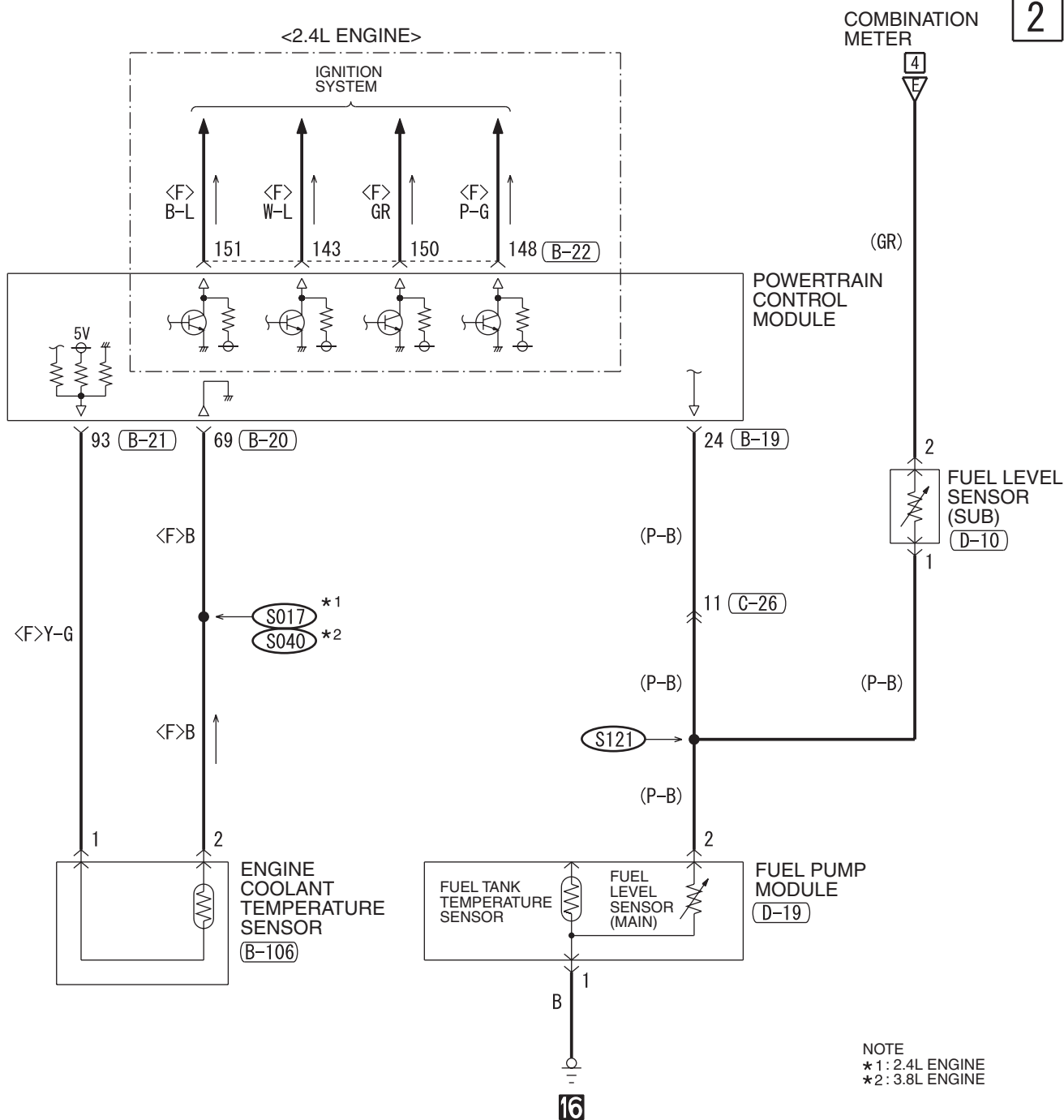

NOTE
*1: 2.4L ENGINE
*2: 3.8L ENGINE

C-28

1	2	3	4	5	6	7	8	9	10	11
12	13	14	15	16	17	18	19	20	21	22
23	24	25	26	27	28	29	30	31	32	33

D-10



D-19



WIRE COLOR CODE

B: BLACK LG: LIGHT GREEN G: GREEN L: BLUE
BR: BROWN O: ORANGE GR: GRAY R: RED W: WHITE
SB: SKY BLUE P: PINK Y: YELLOW V: VIOLET PU: PURPLE

H6P10M01AB

TSB Revision

METER AND GAUGE <A/T> (CONTINUED)

3

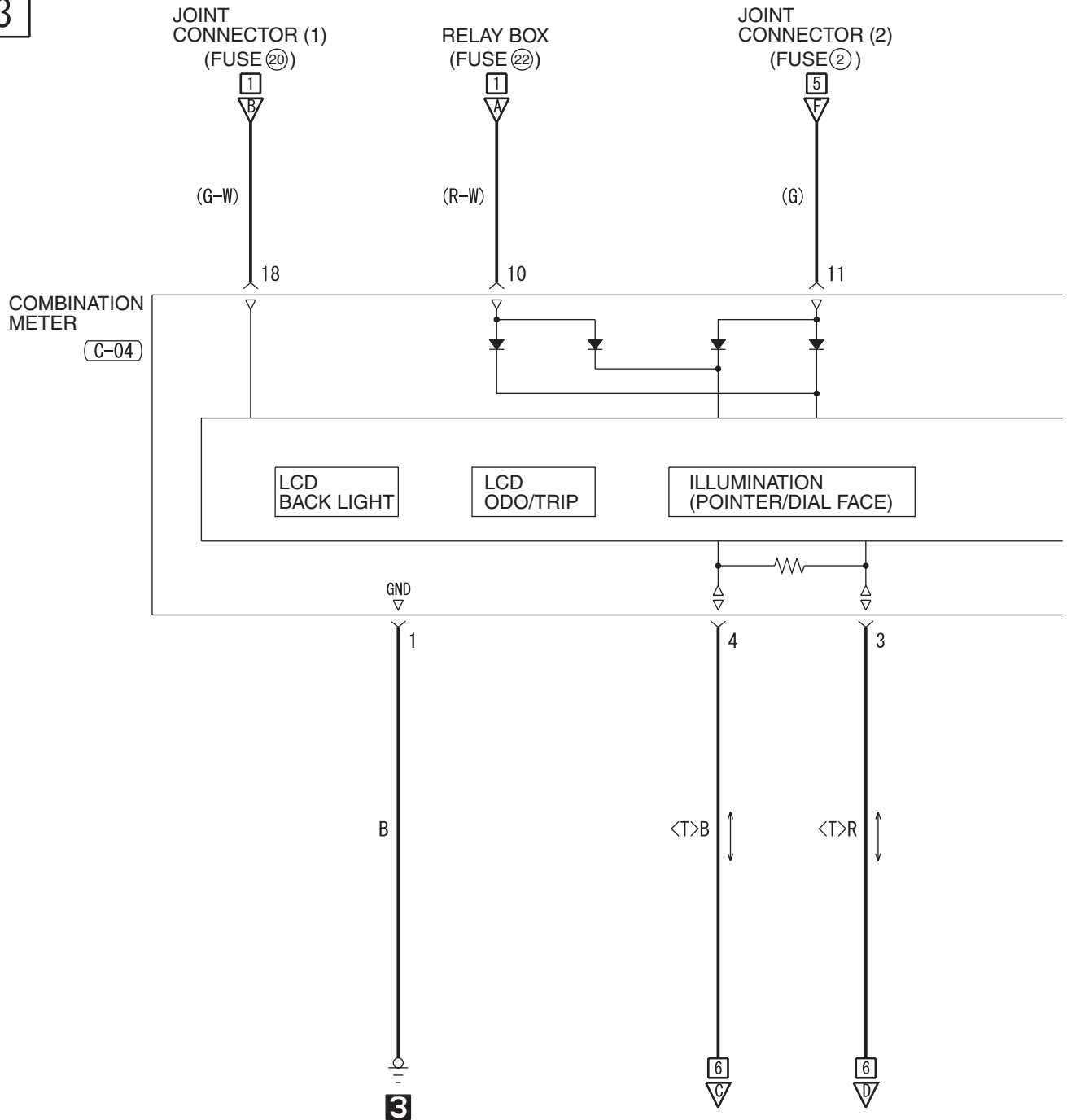

C-04

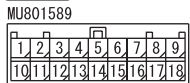

C-23

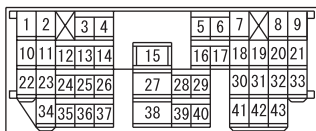

4

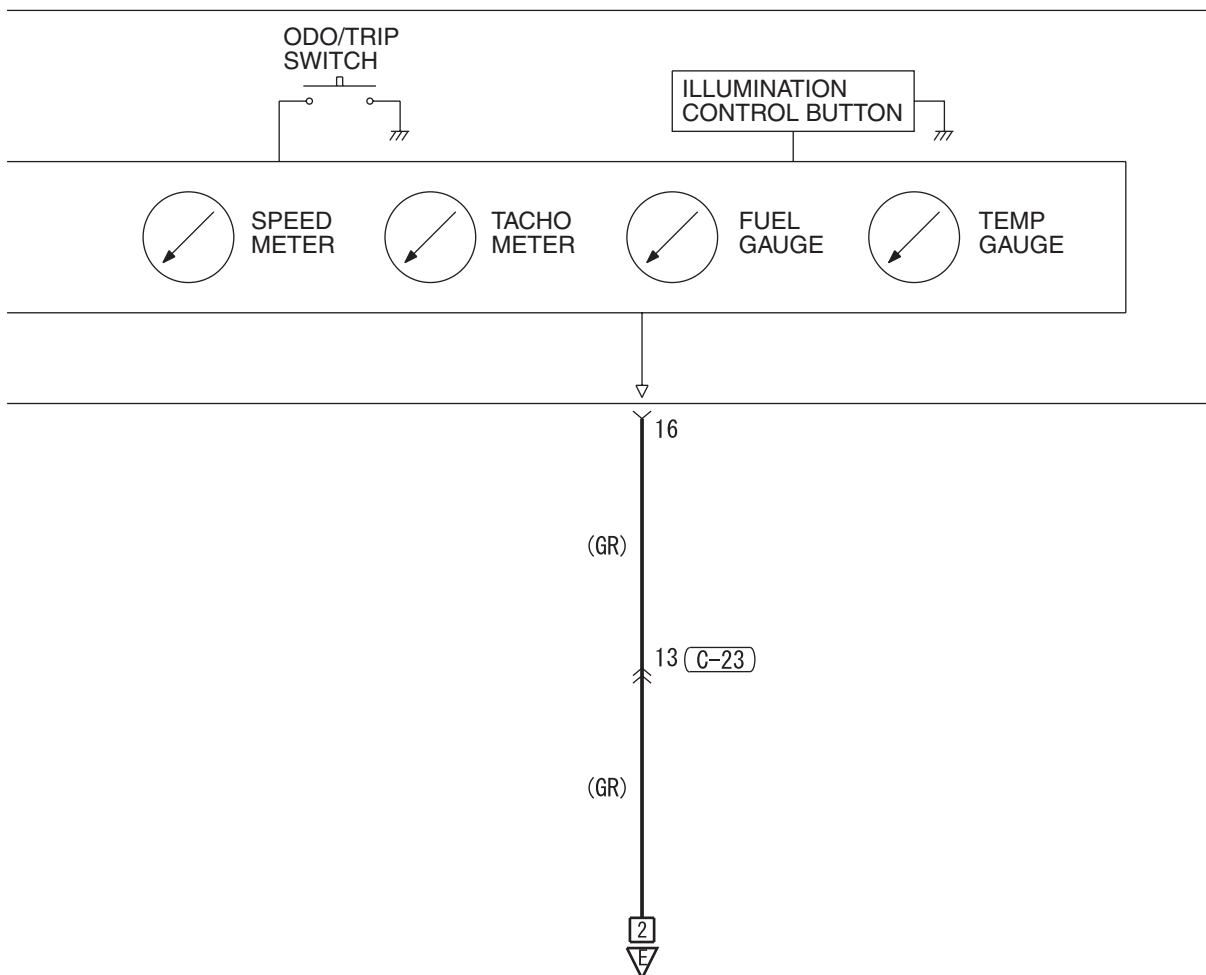

WIRE COLOR CODE
B : BLACK LG : LIGHT GREEN G : GREEN L : BLUE W : WHITE Y : YELLOW SB : SKY BLUE
BR : BROWN O : ORANGE GR : GRAY R : RED P : PINK V : VIOLET PU : PURPLE

H6P10M01BB

TSB Revision

METER AND GAUGE <A/T> (CONTINUED)

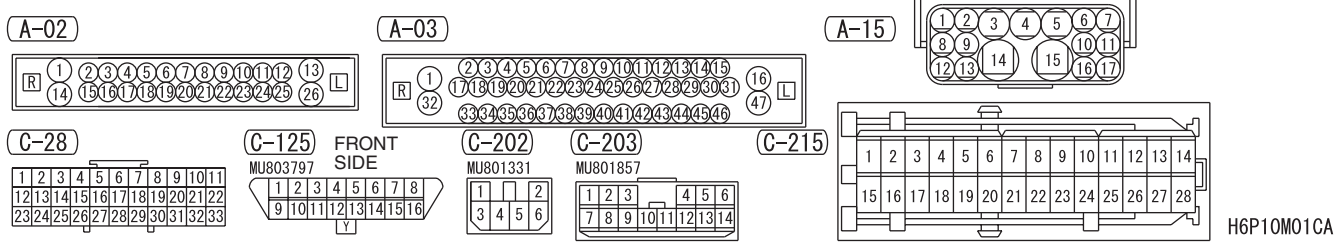
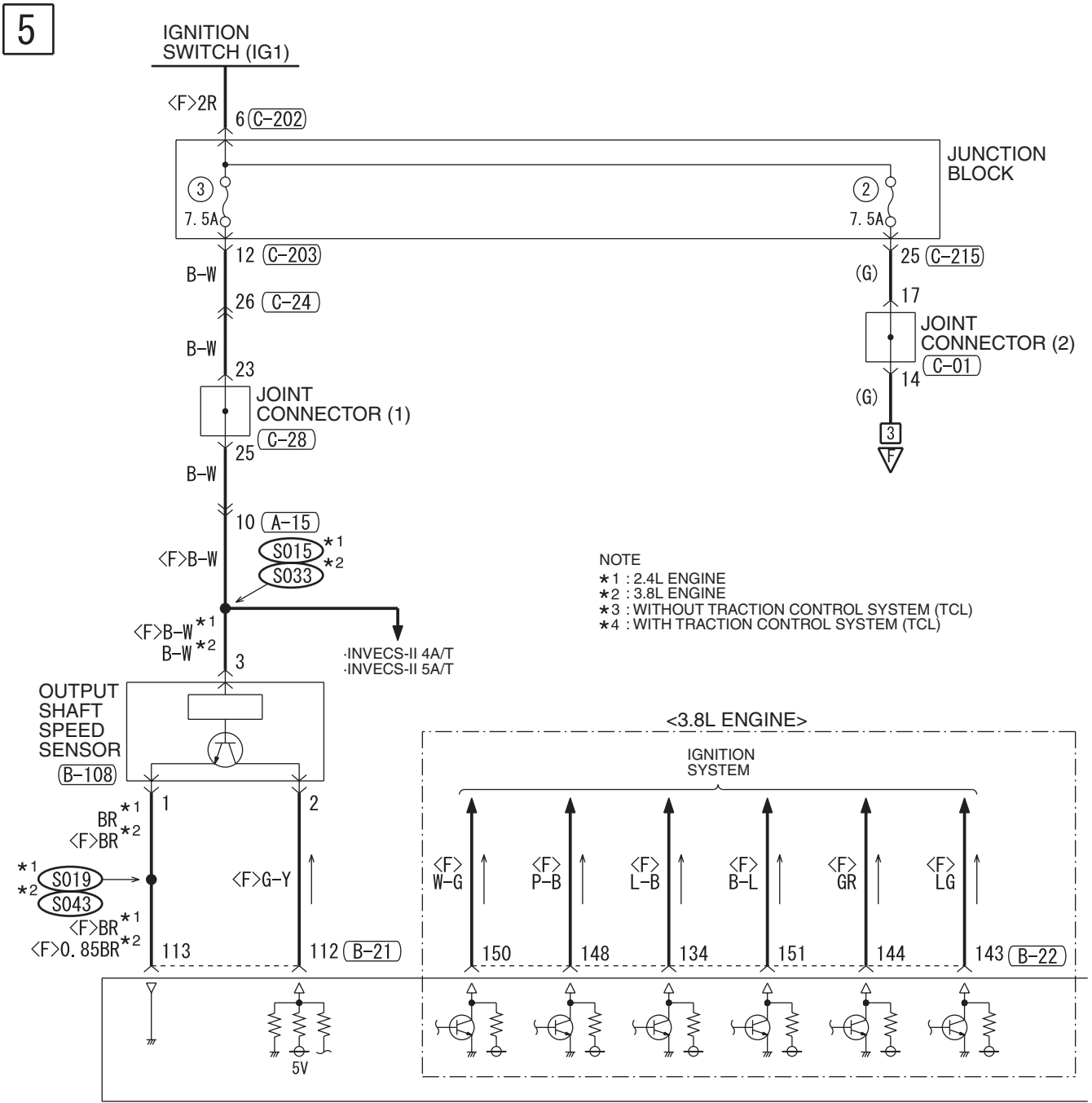

H6P10M01CA

6

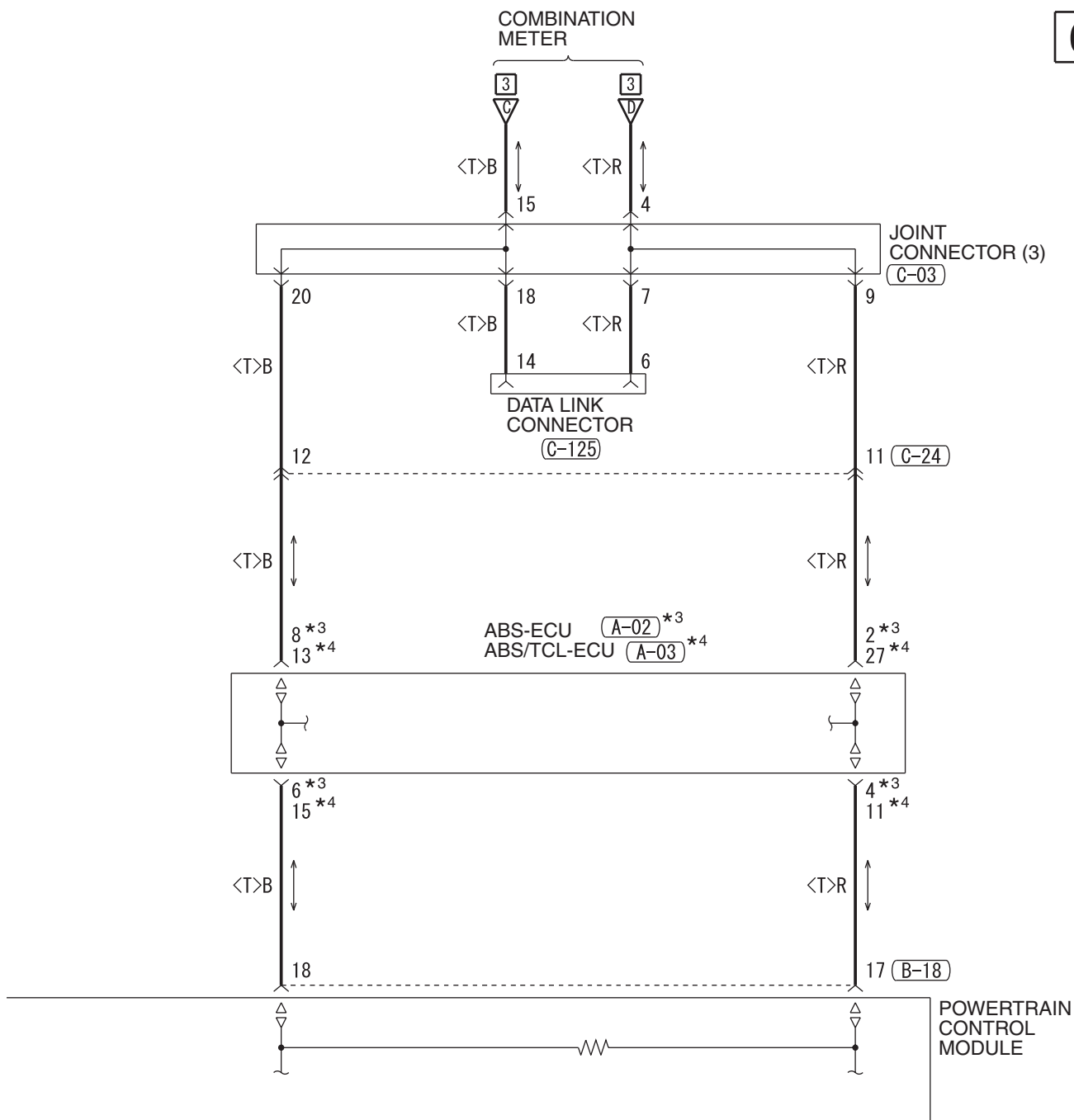

(B-18)

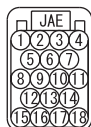

(B-21)

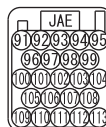

(B-22)

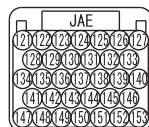

(B-108)



(C-01)



(C-03)

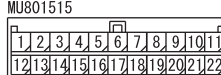

(C-24)

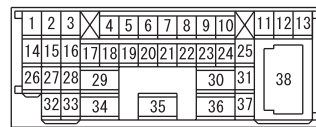

BRAKE WARNING LIGHT, OIL PRESSURE WARNING LIGHT, FUEL WARNING LIGHT <M/T>

M1901011801120

1

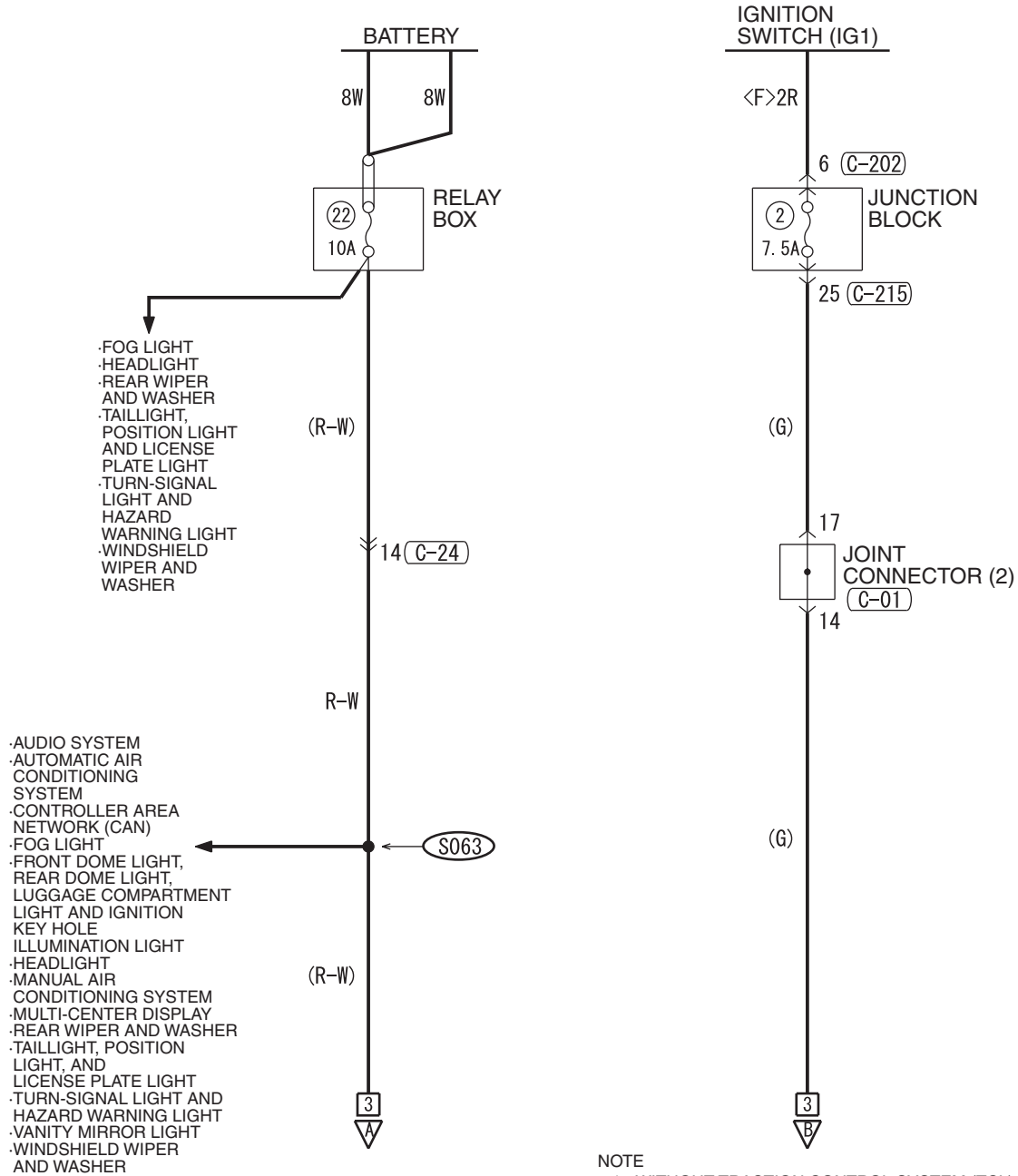

NOTE
* 1 : WITHOUT TRACTION CONTROL SYSTEM (TCL)
* 2 : WITH TRACTION CONTROL SYSTEM (TCL)

A-02



A-03

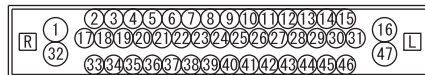

B-18



C-01



2

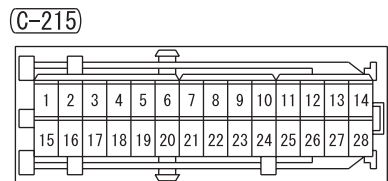
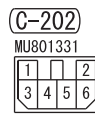
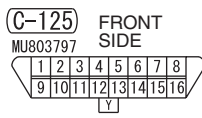
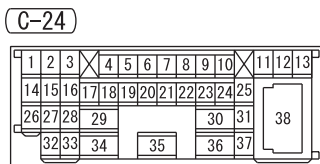
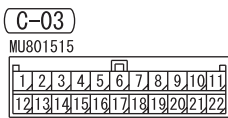
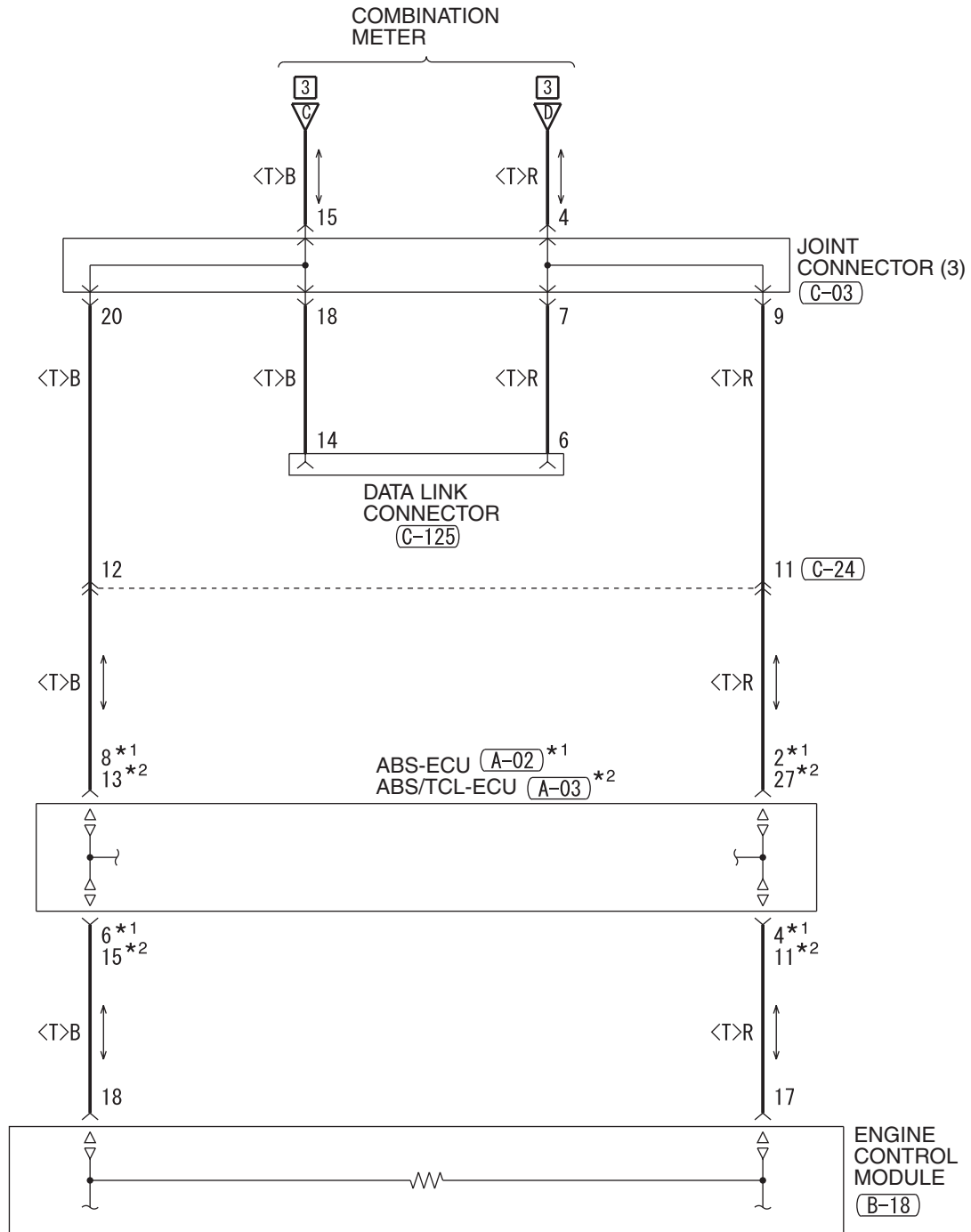

3
BRAKE WARNING LIGHT, OIL PRESSURE WARNING LIGHT, FUEL WARNING LIGHT <M/T>
(CONTINUED)

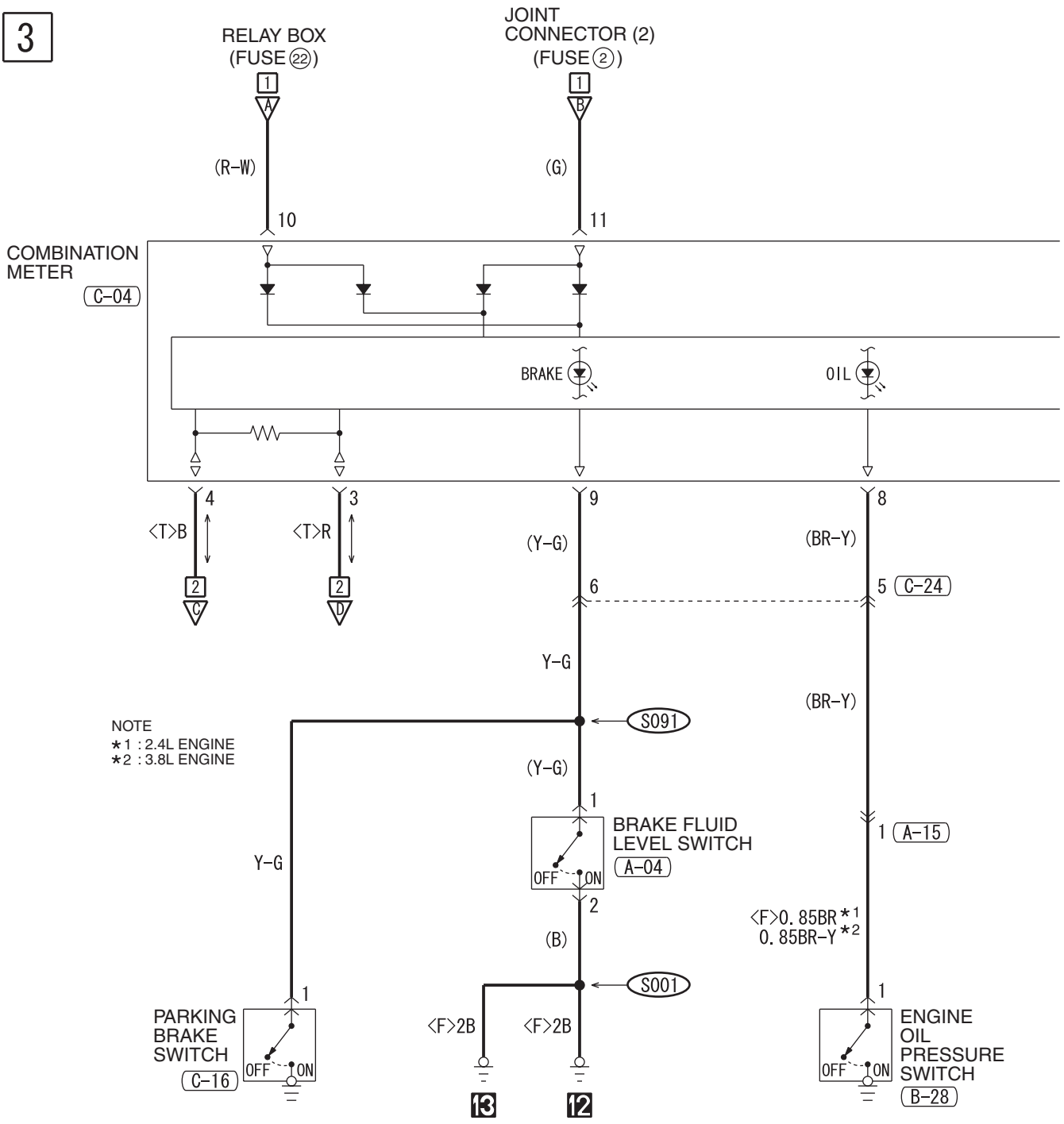

NOTE
*1 : 2.4L ENGINE
*2 : 3.8L ENGINE

<F>0.85BR *1
<F>0.85BR-Y *2

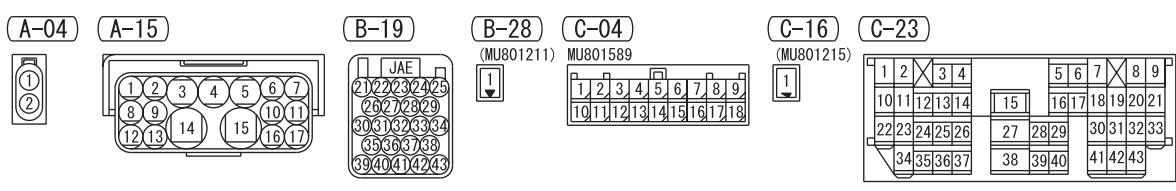

4

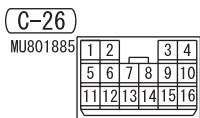
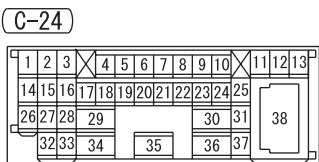
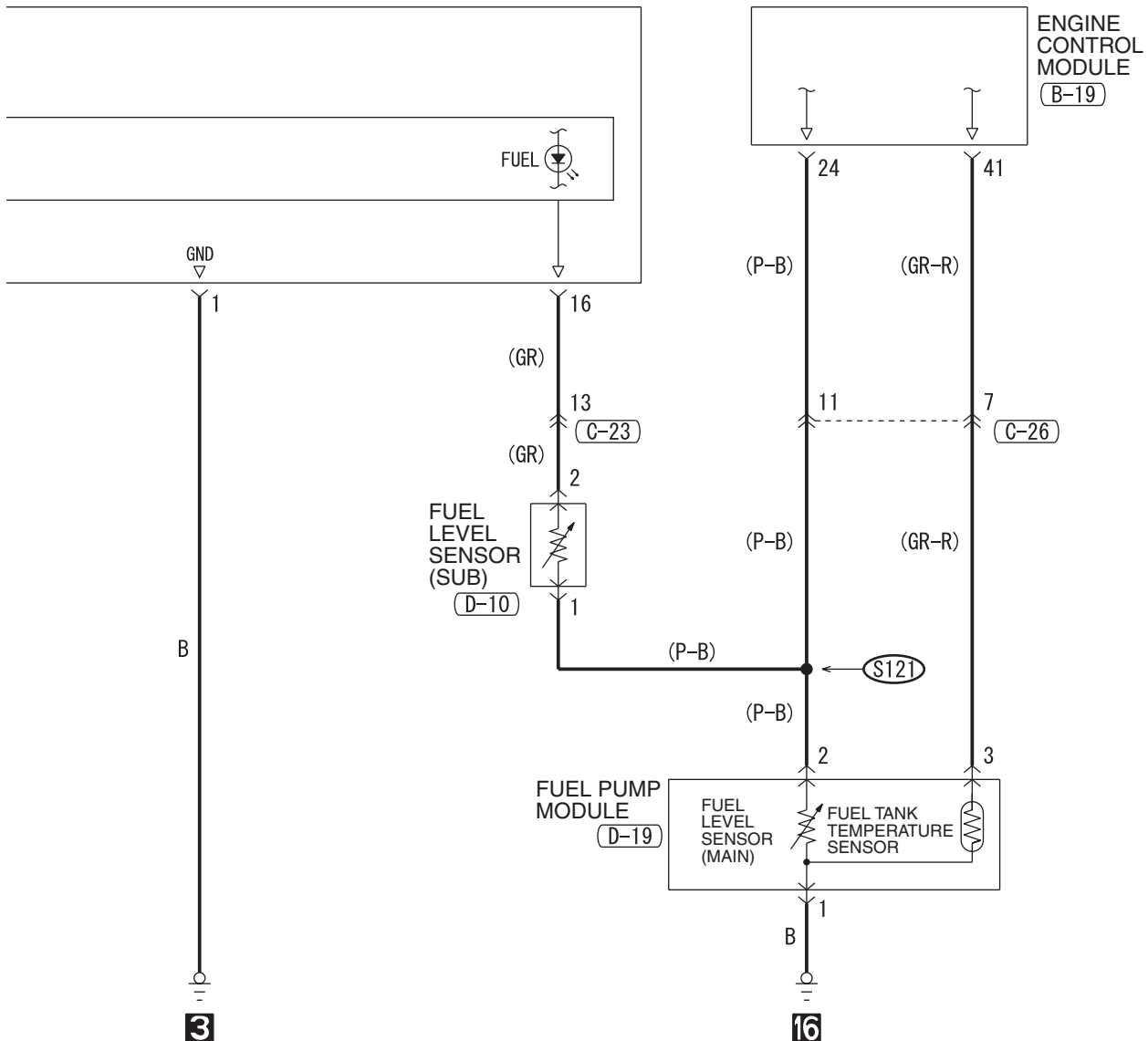

WIRE COLOR CODE
 B: BLACK LG: LIGHT GREEN G: GREEN L: BLUE
 BR: BROWN O: ORANGE GR: GRAY R: RED W: WHITE
 SB: SKY BLUE P: PINK Y: YELLOW V: VIOLET PU: PURPLE

H6P10M02BB

TSB Revision

BRAKE WARNING LIGHT, OIL PRESSURE WARNING LIGHT, FUEL WARNING LIGHT <A/T>

M1901011801131

1

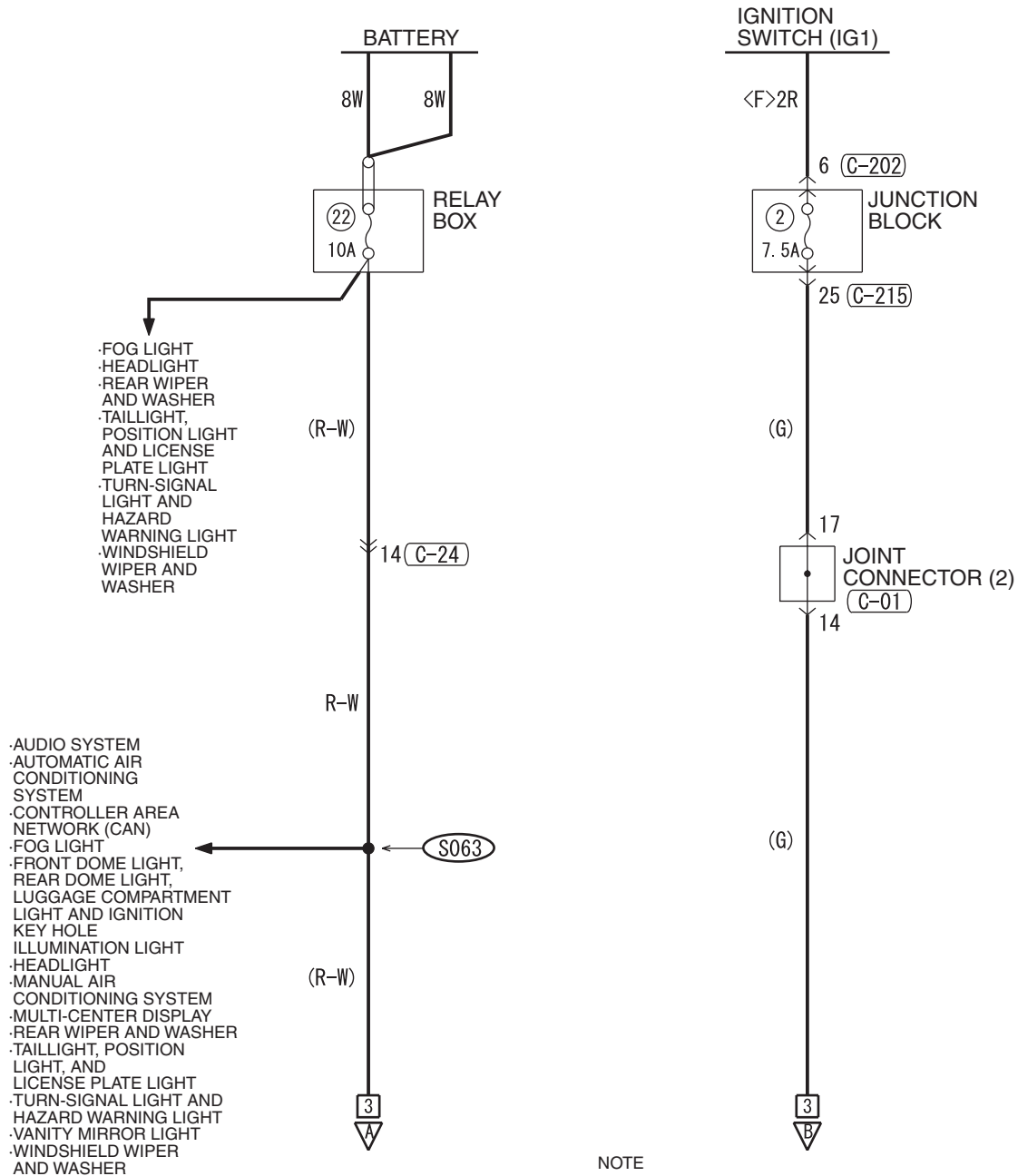

A-02



A-03

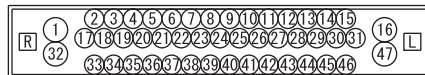

B-18



C-01

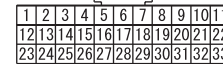

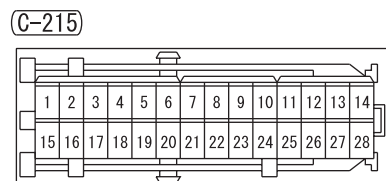
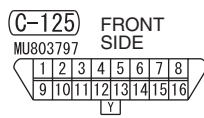
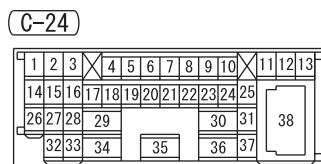
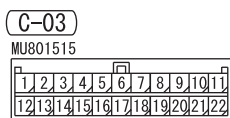
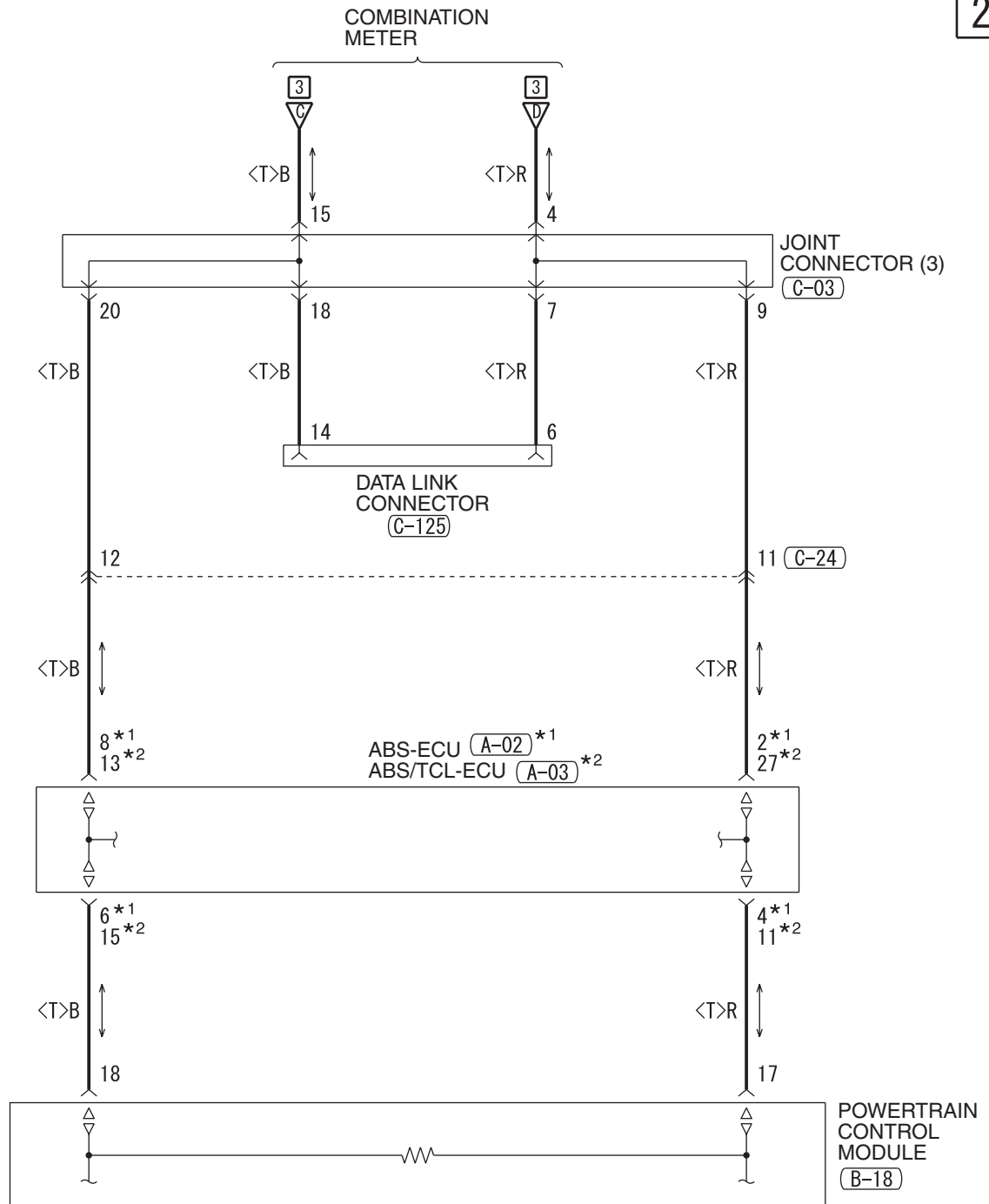

BRAKE WARNING LIGHT, OIL PRESSURE WARNING LIGHT, FUEL WARNING LIGHT <A/T>
(CONTINUED)

3

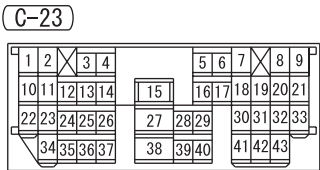
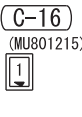
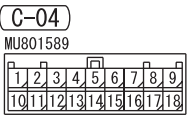
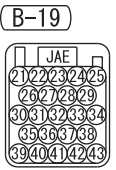
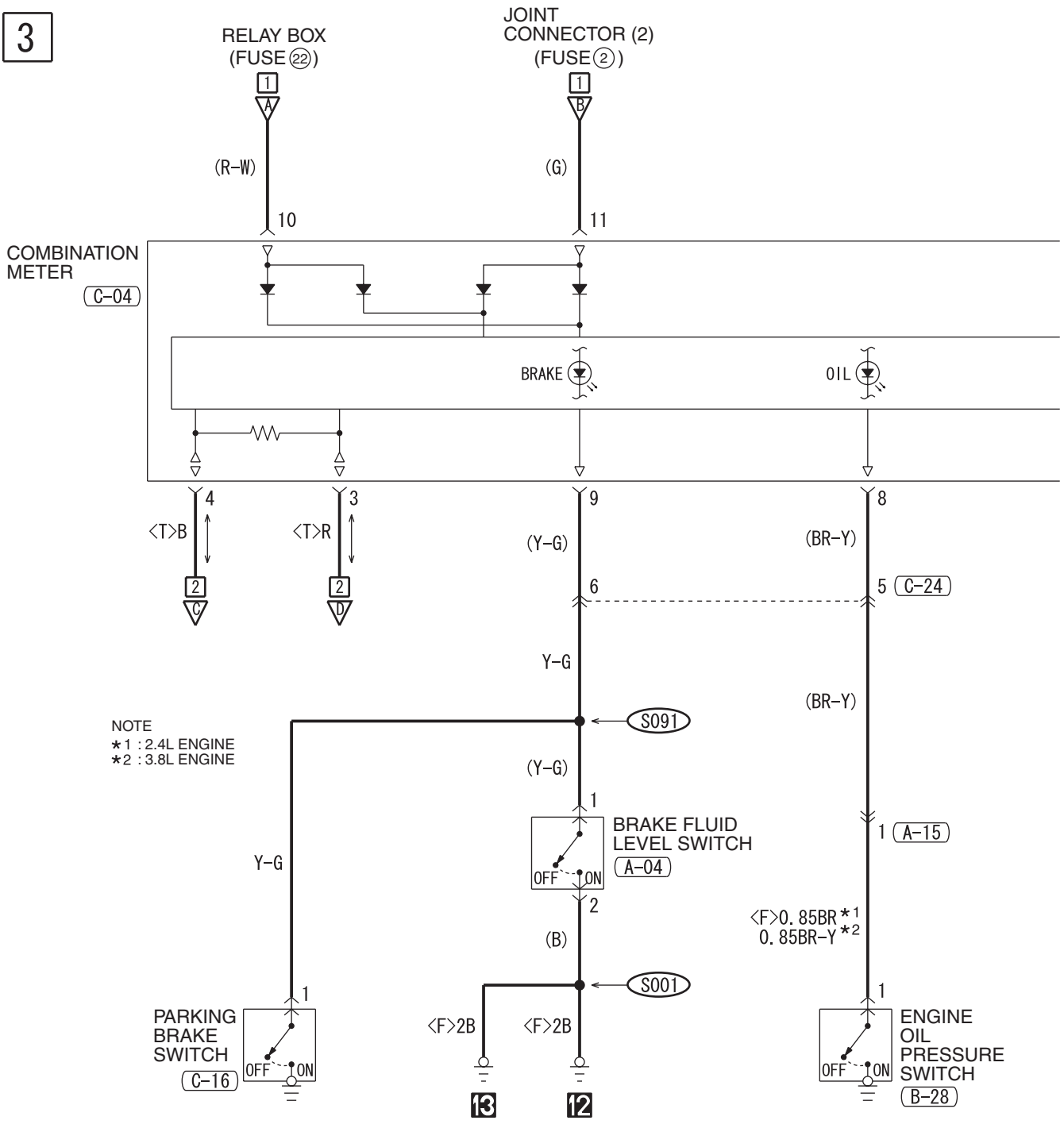

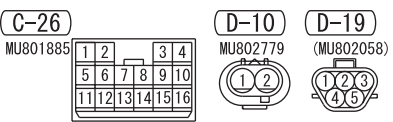
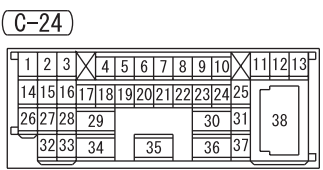
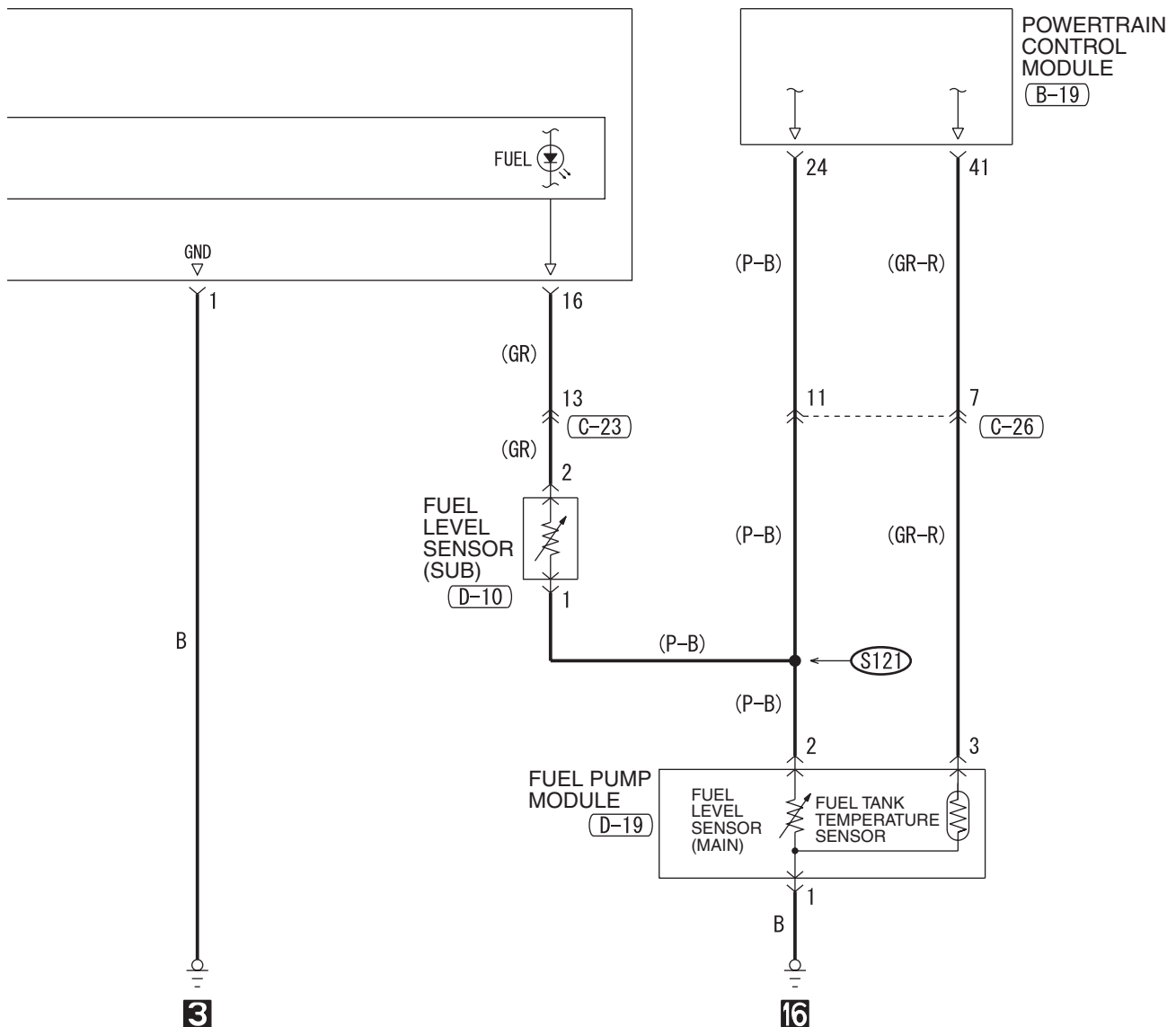

WIRE COLOR CODE
 B: BLACK LG: LIGHT GREEN G: GREEN L: BLUE
 BR: BROWN O: ORANGE GR: GRAY R: RED W: WHITE
 SB: SKY BLUE P: PINK Y: YELLOW V: VIOLET PU: PURPLE

H6P10M03BB

POWER WINDOWS

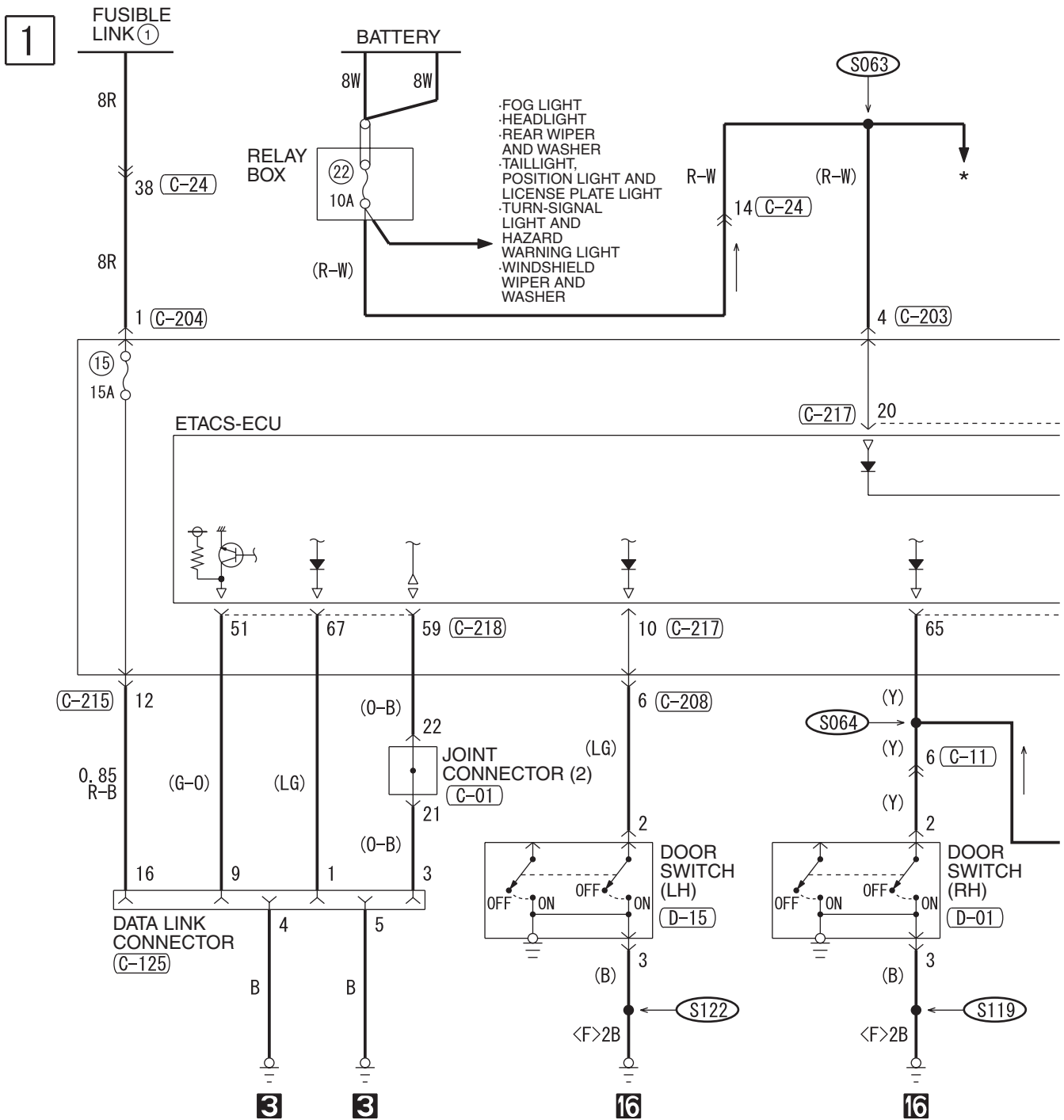

C-01



C-11

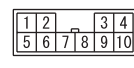

C-24

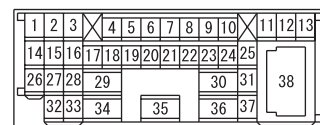

C-125 FRONT SIDE

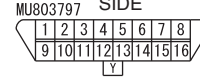

C-202



C-203

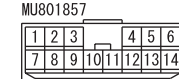

C-204



C-218



D-01



D-15



2

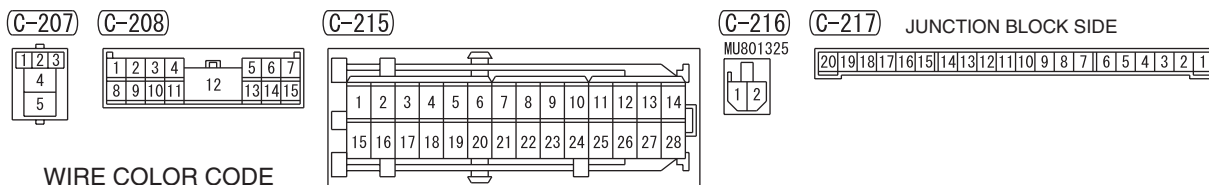
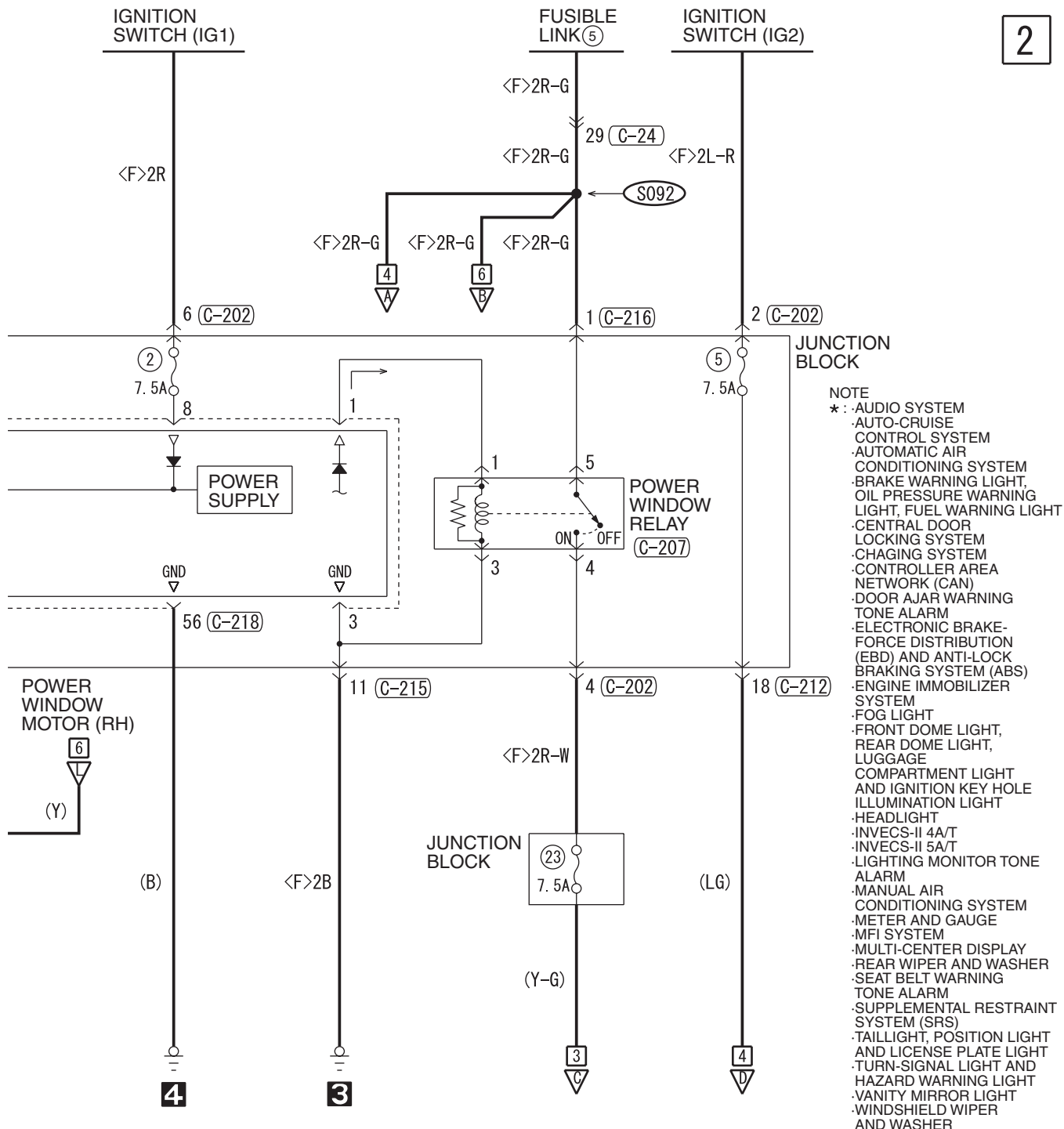

WIRE COLOR CODE
B : BLACK LG : LIGHT GREEN G : GREEN L : BLUE W : WHITE Y : YELLOW SB : SKY BLUE
BR : BROWN O : ORANGE GR : GRAY R : RED P : PINK V : VIOLET PU : PURPLE H6P11M00AB

POWER WINDOWS (CONTINUED)

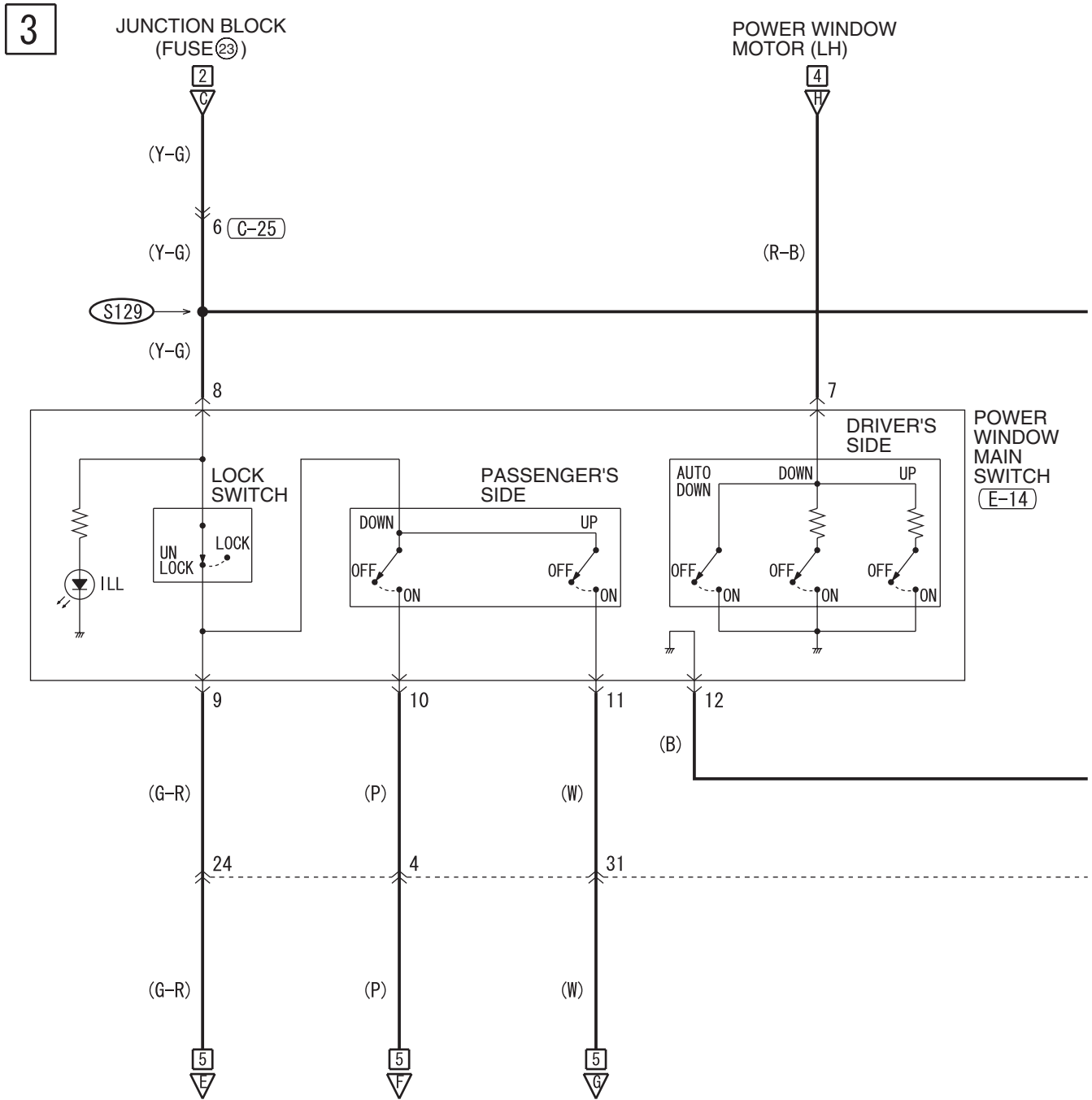

(C-25)

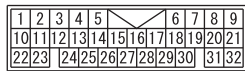

(E-14)

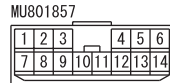

(E-16)

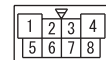

4

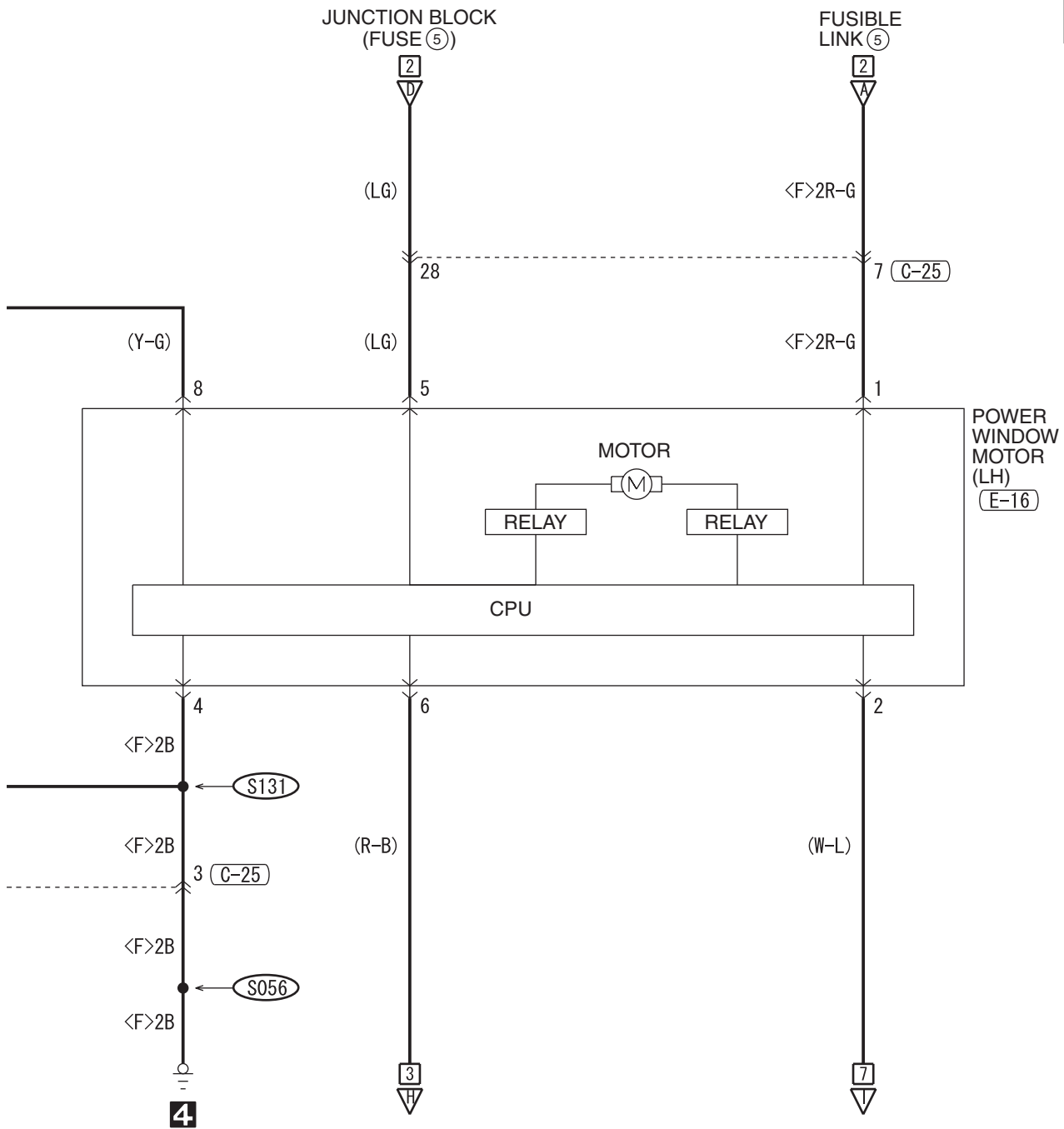

WIRE COLOR CODE
 B : BLACK LG : LIGHT GREEN G : GREEN L : BLUE W : WHITE Y : YELLOW SB : SKY BLUE
 BR : BROWN O : ORANGE GR : GRAY R : RED P : PINK V : VIOLET PU : PURPLE

H6P11M00BB

TSB Revision

POWER WINDOWS (CONTINUED)

5

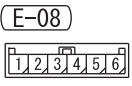
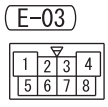
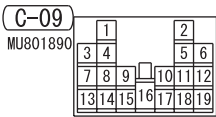
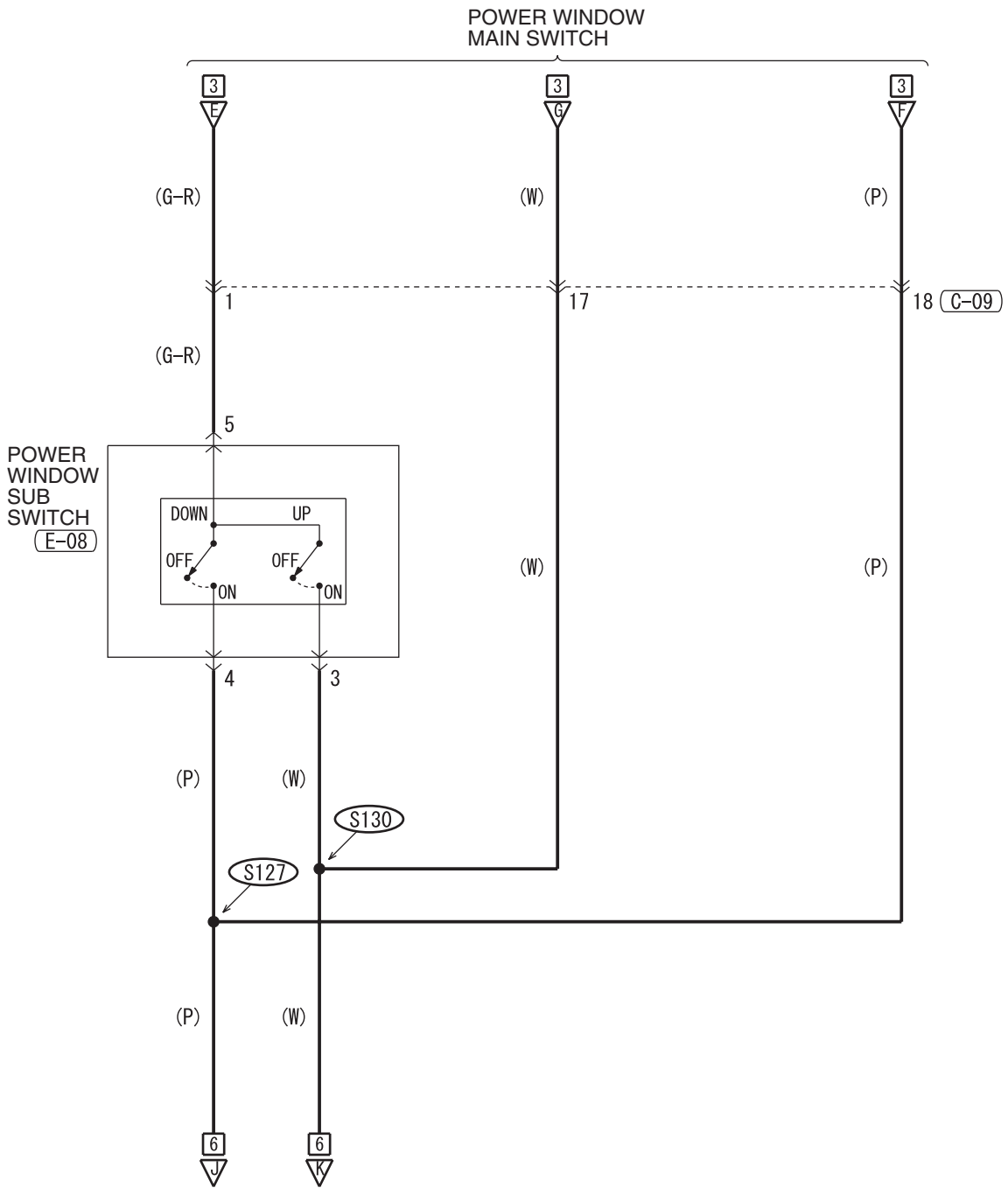

6

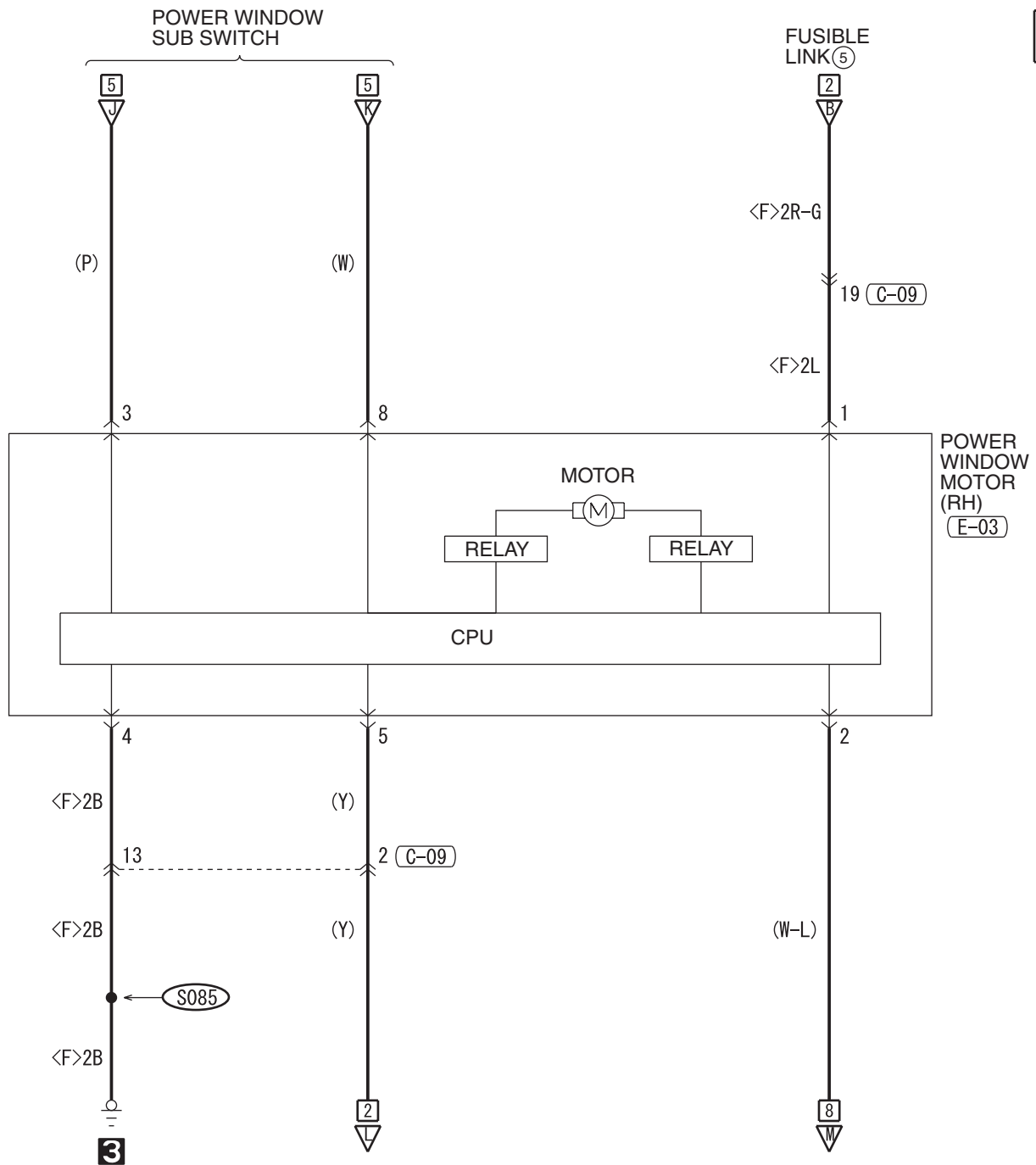

WIRE COLOR CODE

B: BLACK LG: LIGHT GREEN G: GREEN L: BLUE W: WHITE Y: YELLOW SB: SKY BLUE
BR: BROWN O: ORANGE GR: GRAY R: RED P: PINK V: VIOLET PU: PURPLE

H6P11M00CB

TSB Revision

POWER WINDOWS (CONTINUED)

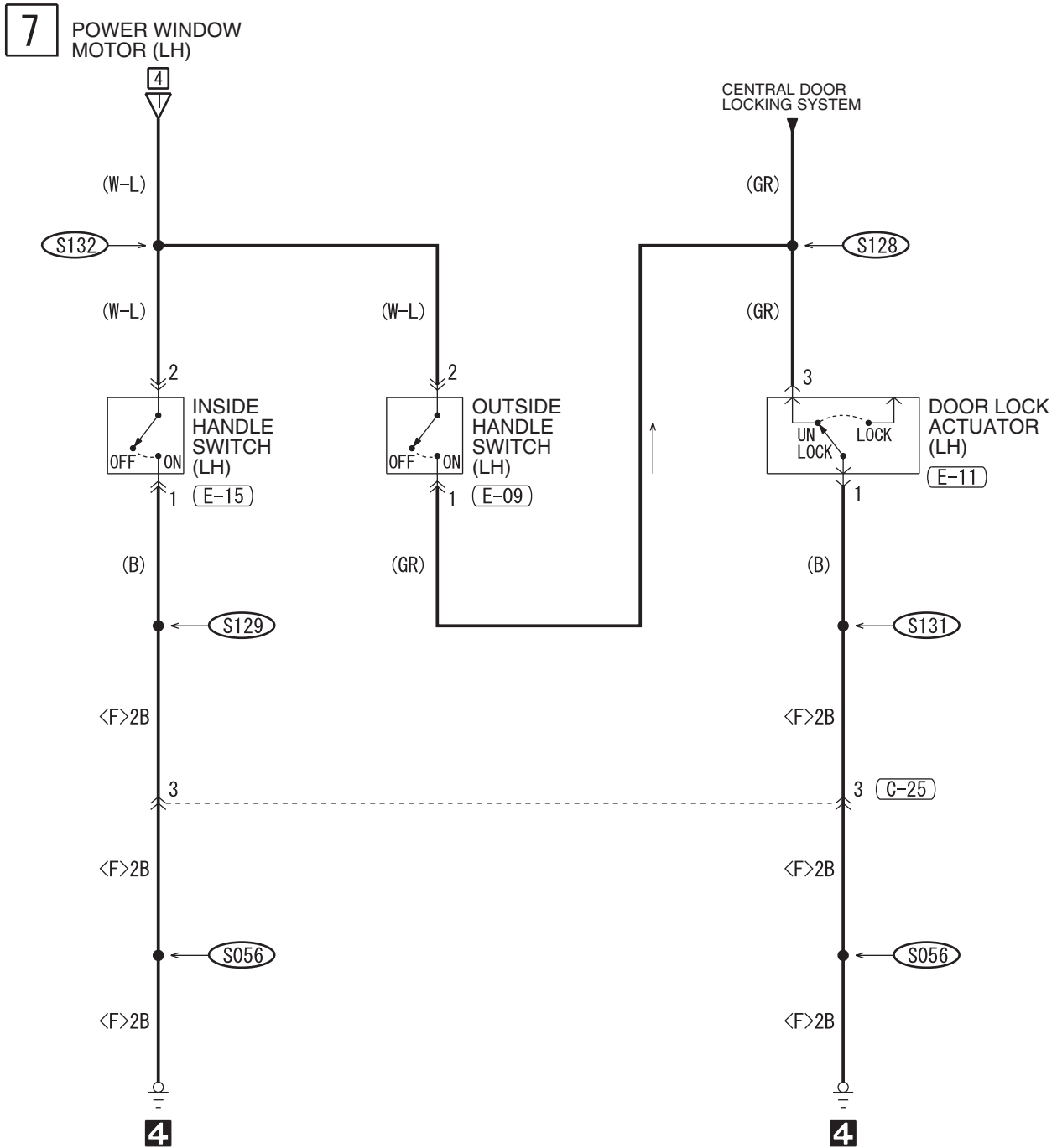

C-09
MU801890

1	2
3	4
5	6
7	8
9	10
11	12
13	14
15	16
17	18
19	

C-25

1	2	3	4	5	6	7	8	9
10	11	12	13	14	15	16	17	18
19	20	21	22	23	24	25	26	27
28	29	30	31	32				



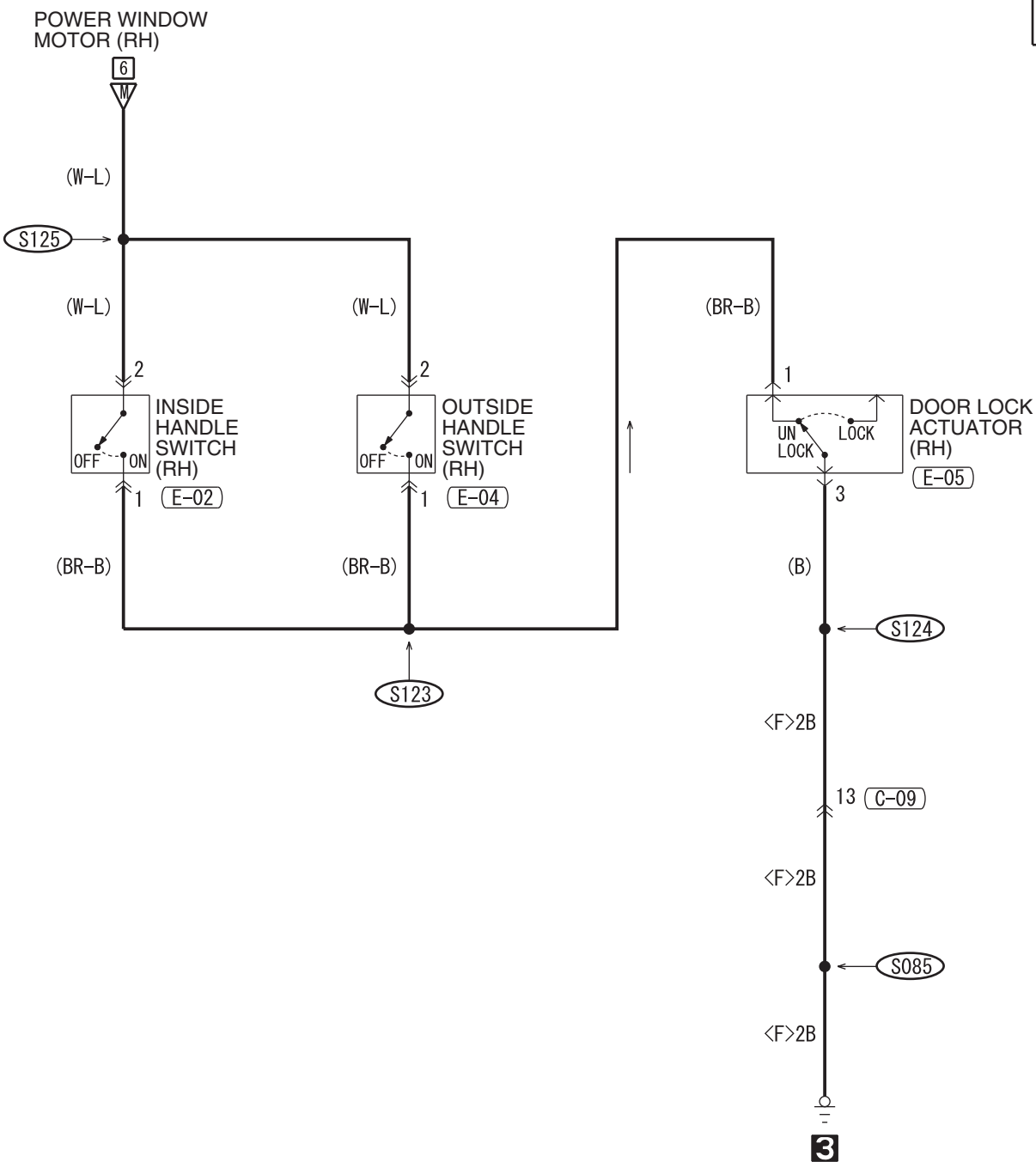

WIRE COLOR CODE

B: BLACK LG: LIGHT GREEN G: GREEN L: BLUE W: WHITE Y: YELLOW SB: SKY BLUE
BR: BROWN O: ORANGE GR: GRAY R: RED P: PINK V: VIOLET PU: PURPLE

CENTRAL DOOR LOCKING SYSTEM

M1901004702834

1

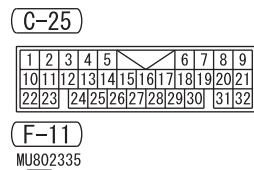
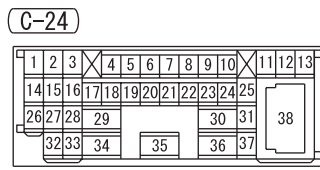
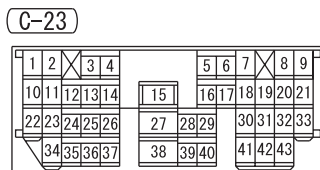
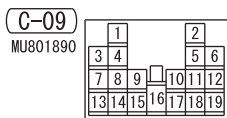
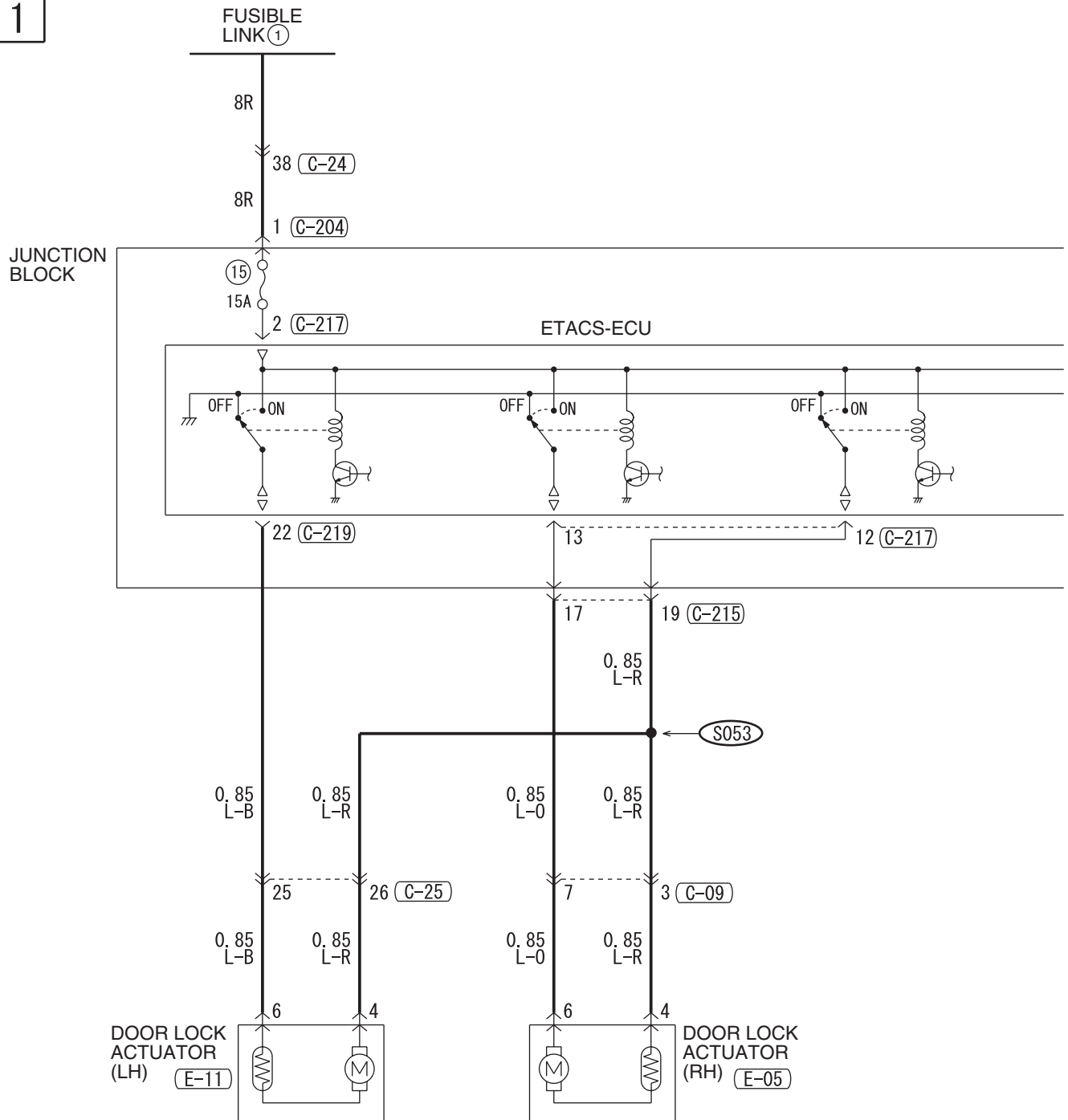

H6P11M01AA

2

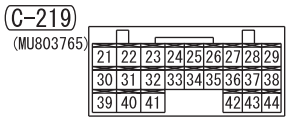
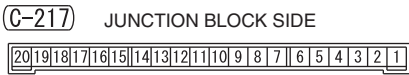
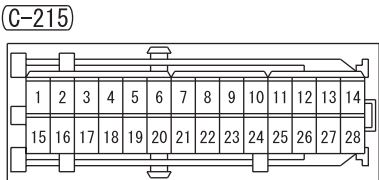
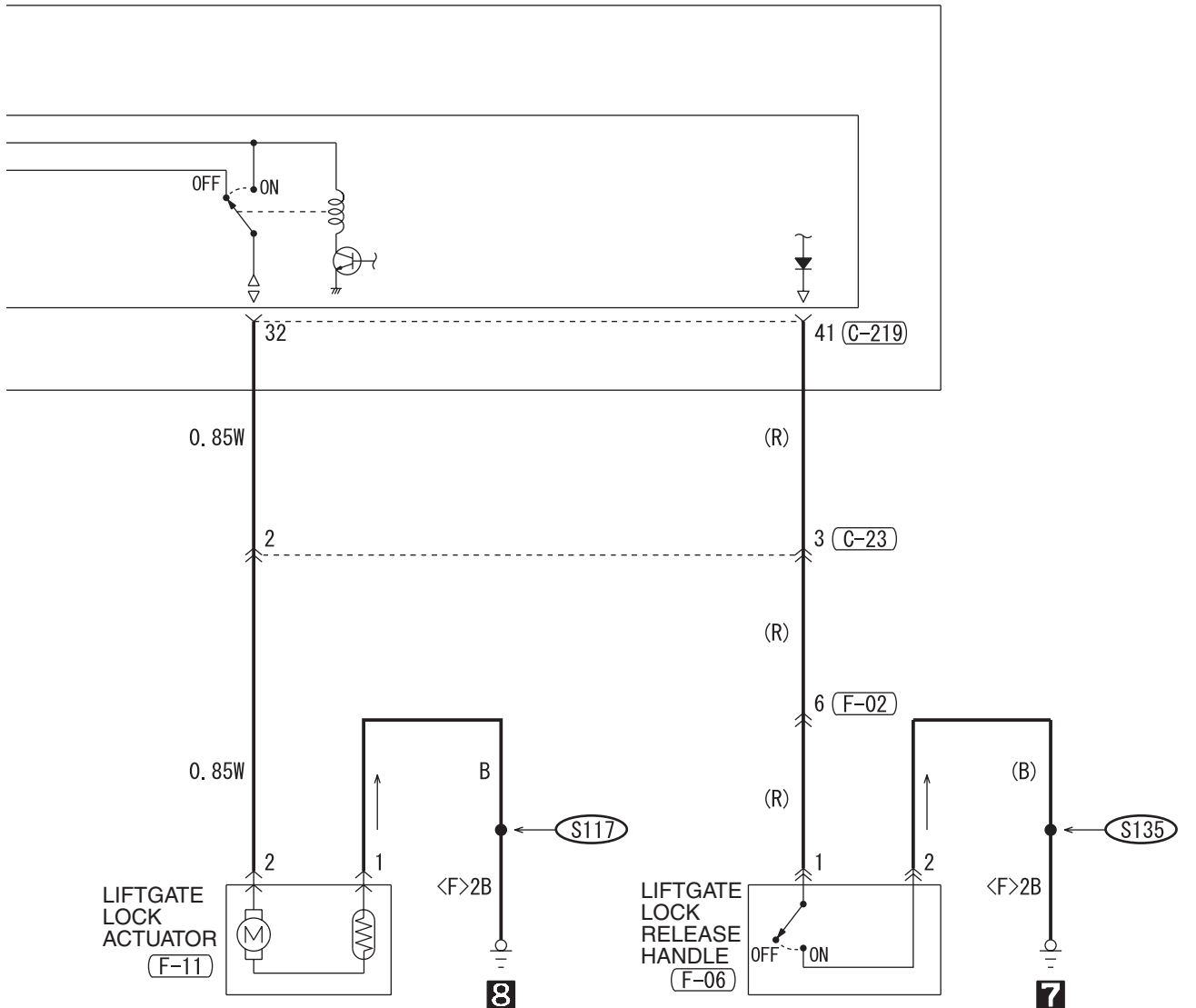

WIRE COLOR CODE
 B : BLACK LG : LIGHT GREEN G : GREEN L : BLUE
 BR : BROWN O : ORANGE GR : GRAY R : RED W : WHITE
 SB : SKY BLUE P : PINK Y : YELLOW V : VIOLET P : PURPLE H6P11M01AB

CENTRAL DOOR LOCKING SYSTEM (CONTINUED)

3

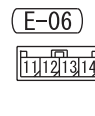
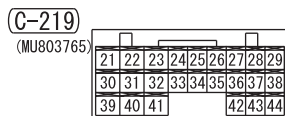
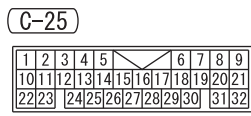
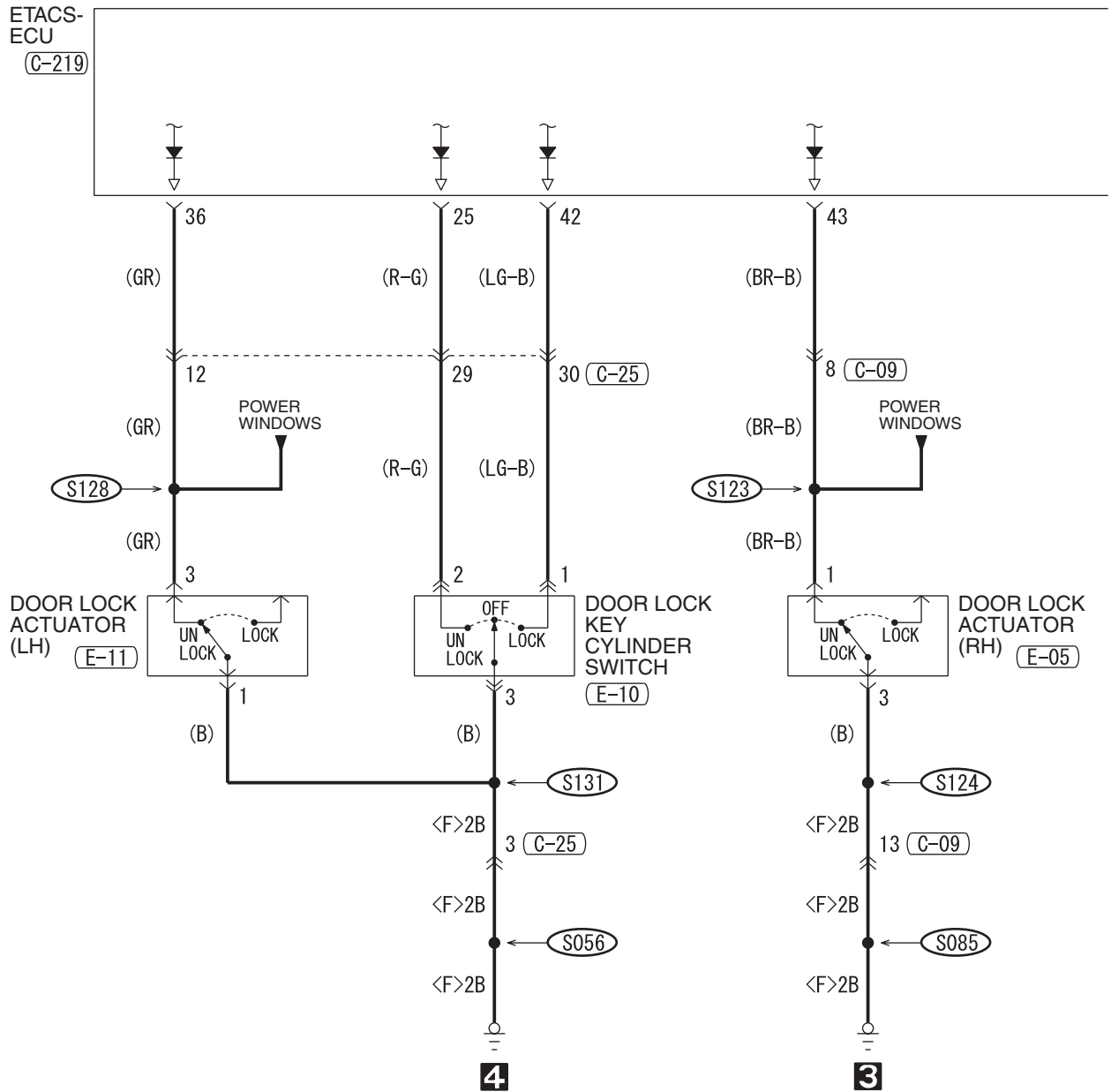

4

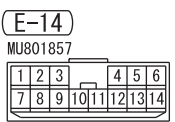
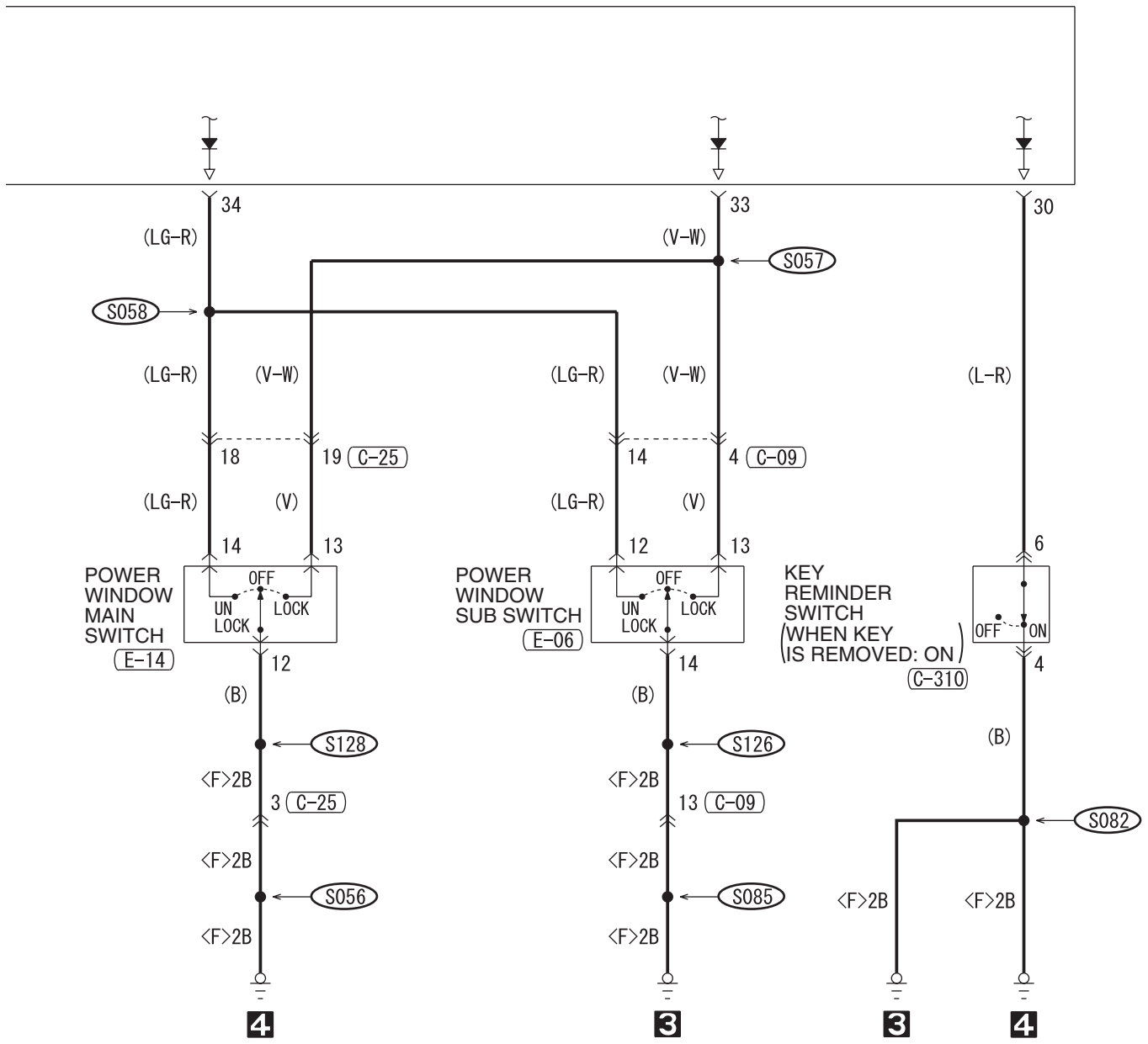

WIRE COLOR CODE
 B: BLACK LG: LIGHT GREEN G: GREEN L: BLUE W: WHITE Y: YELLOW SB: SKY BLUE
 BR: BROWN O: ORANGE GR: GRAY R: RED P: PINK V: VIOLET PU: PURPLE

H6P11M01BB

TSB Revision

CENTRAL DOOR LOCKING SYSTEM (CONTINUED)

5

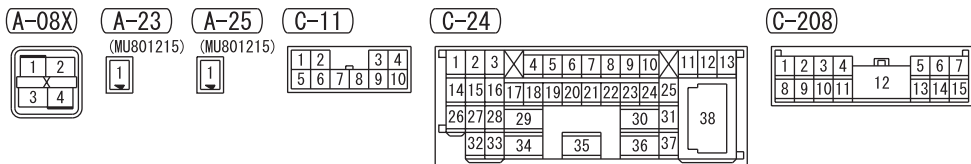
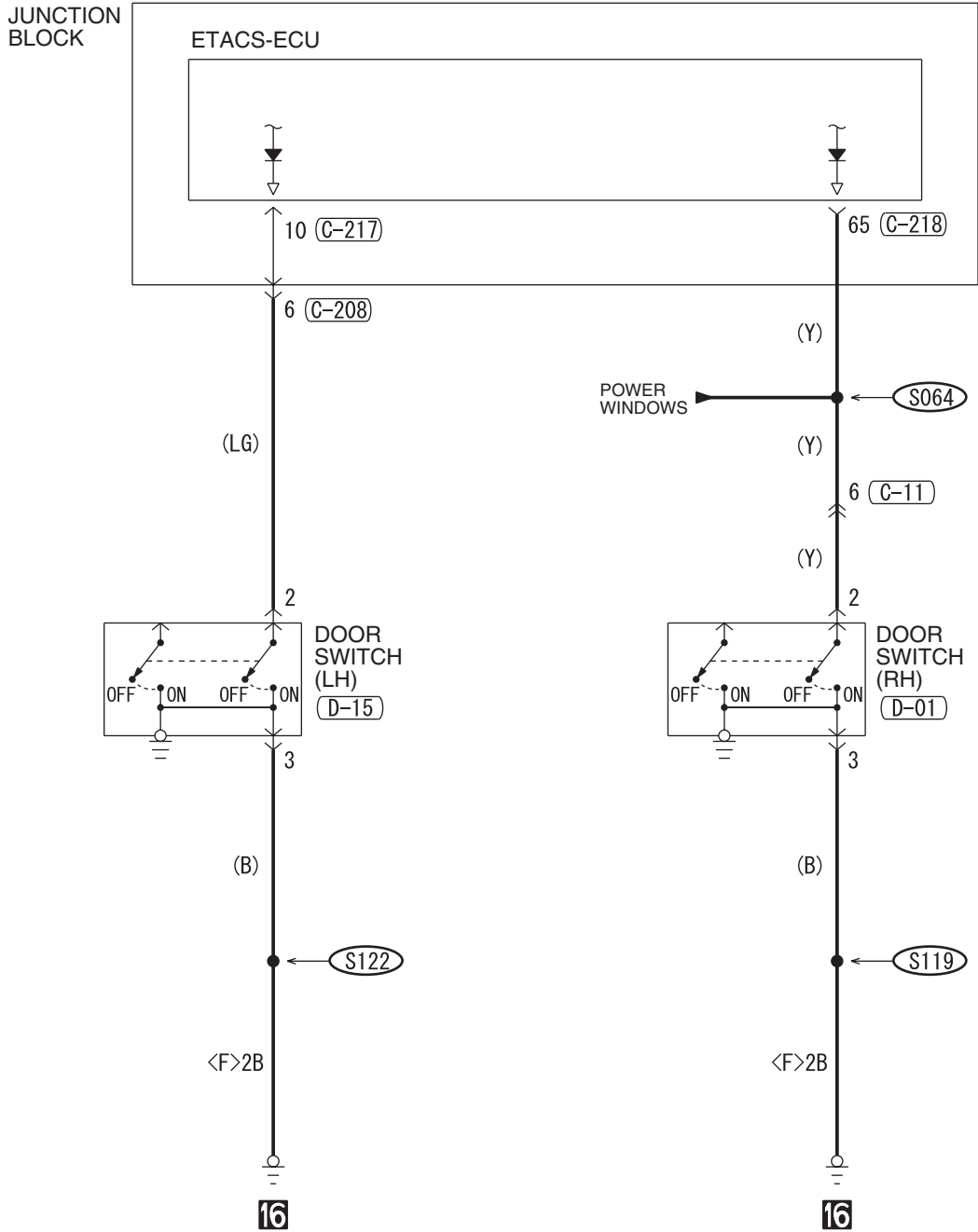

6

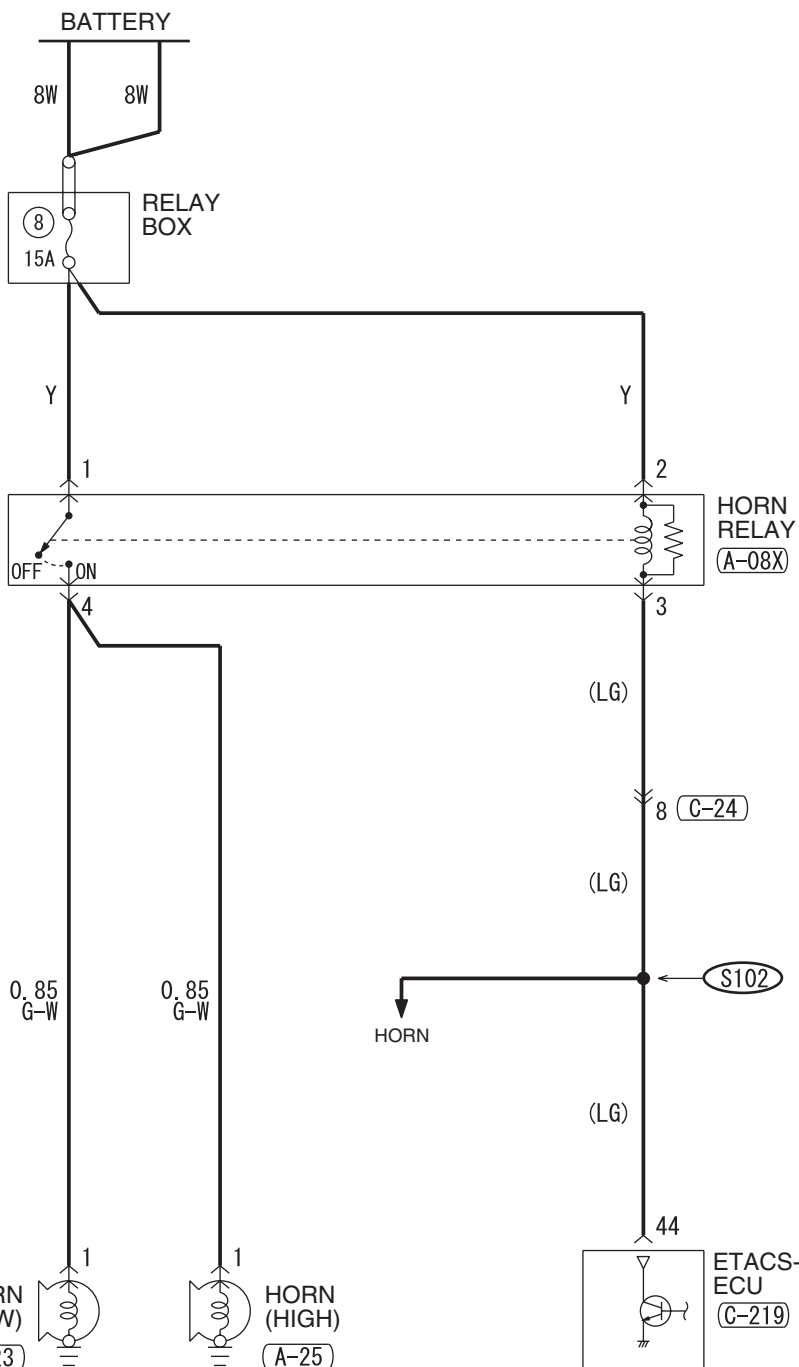

(C-217) JUNCTION BLOCK SIDE

20	19	18	17	16	15	14	13	12	11	10	9	8	7	6	5	4	3	2	1
----	----	----	----	----	----	----	----	----	----	----	---	---	---	---	---	---	---	---	---

(C-218) (MU803766)

51	52	53	54	55	56	57	58	59
60	61	62	63	64	65	66	67	68
69	70	71	72	73	74			

(C-219) (MU803765)

21	22	23	24	25	26	27	28	29
30	31	32	33	34	35	36	37	38
39	40	41	42	43	44			

(D-01) (MU801536)

1	2	3
---	---	---

(D-15) (MU801536)

1	2	3
---	---	---

WIRE COLOR CODE
 B: BLACK LG: LIGHT GREEN G: GREEN L: BLUE W: WHITE Y: YELLOW SB: SKY BLUE
 BR: BROWN O: ORANGE GR: GRAY R: RED P: PINK V: VIOLET PU: PURPLE

CENTRAL DOOR LOCKING SYSTEM (CONTINUED)

7

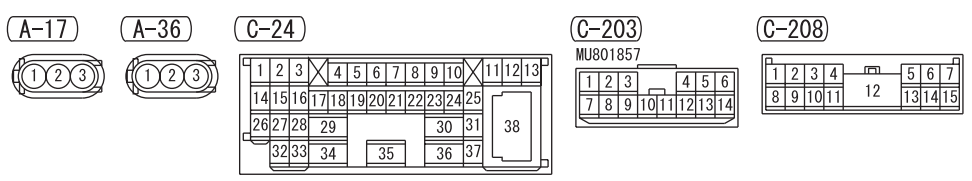
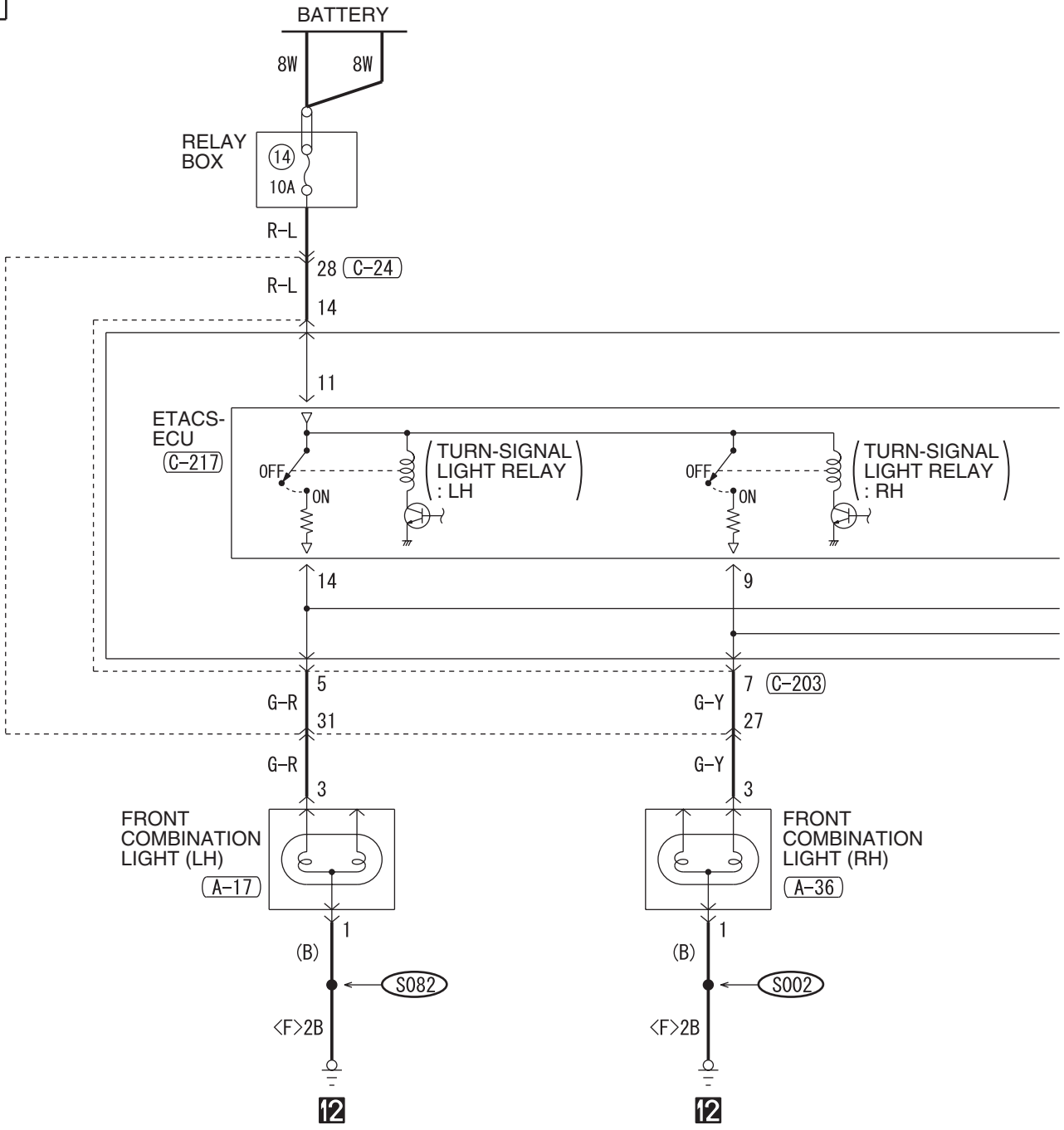

8

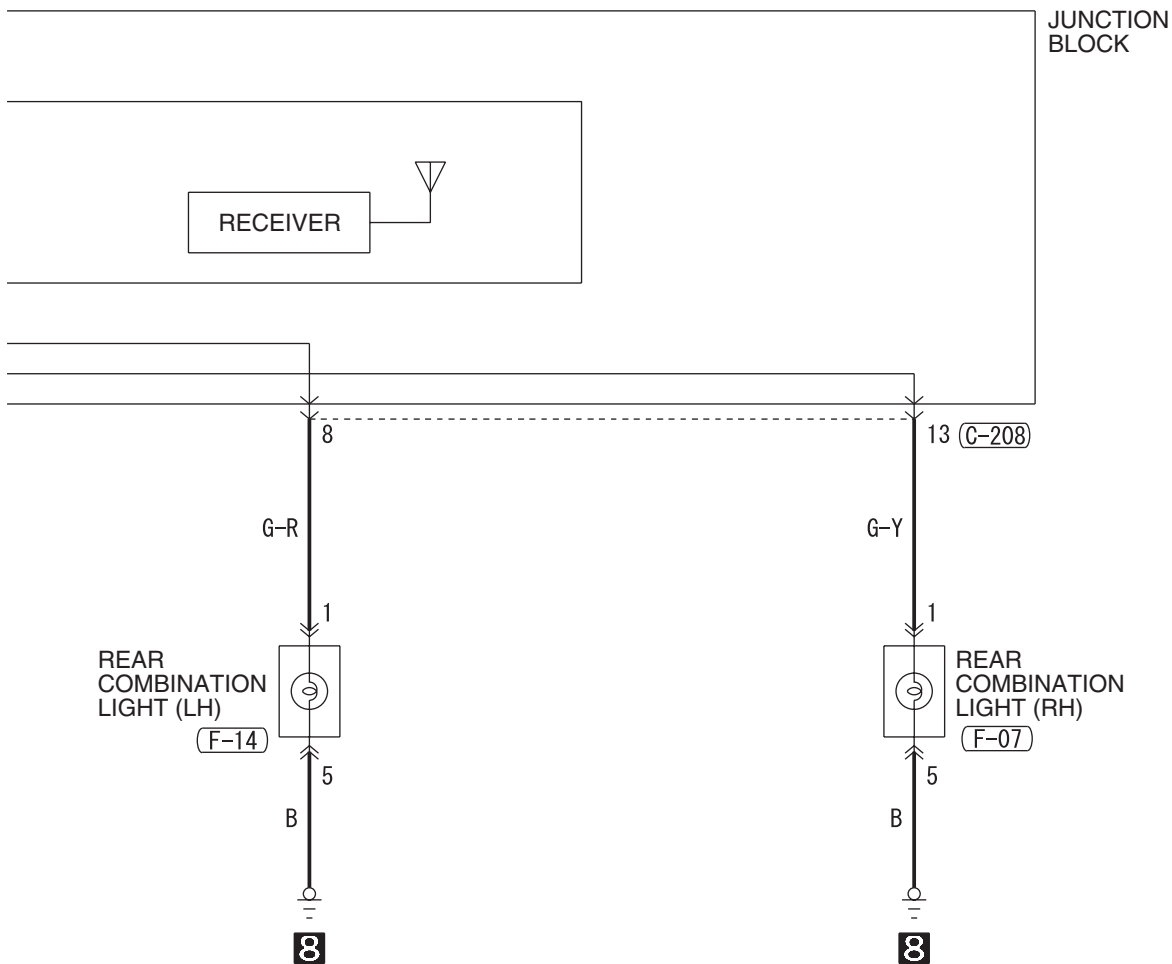
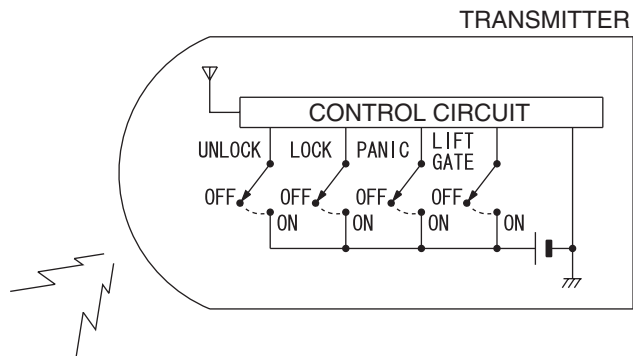

(C-217) JUNCTION BLOCK SIDE

20	19	18	17	16	15	14	13	12	11	10	9	8	7	6	5	4	3	2	1
----	----	----	----	----	----	----	----	----	----	----	---	---	---	---	---	---	---	---	---

(F-07)

MU801698					
1		2			
3	4	5	6		

(F-14)

MU801698					
1		2			
3	4	5	6		

WIRE COLOR CODE

B : BLACK LG : LIGHT GREEN G : GREEN L : BLUE W : WHITE Y : YELLOW SB : SKY BLUE
BR : BROWN O : ORANGE GR : GRAY R : RED P : PINK V : VIOLET PU : PURPLE

CENTRAL DOOR LOCKING SYSTEM (CONTINUED)

9

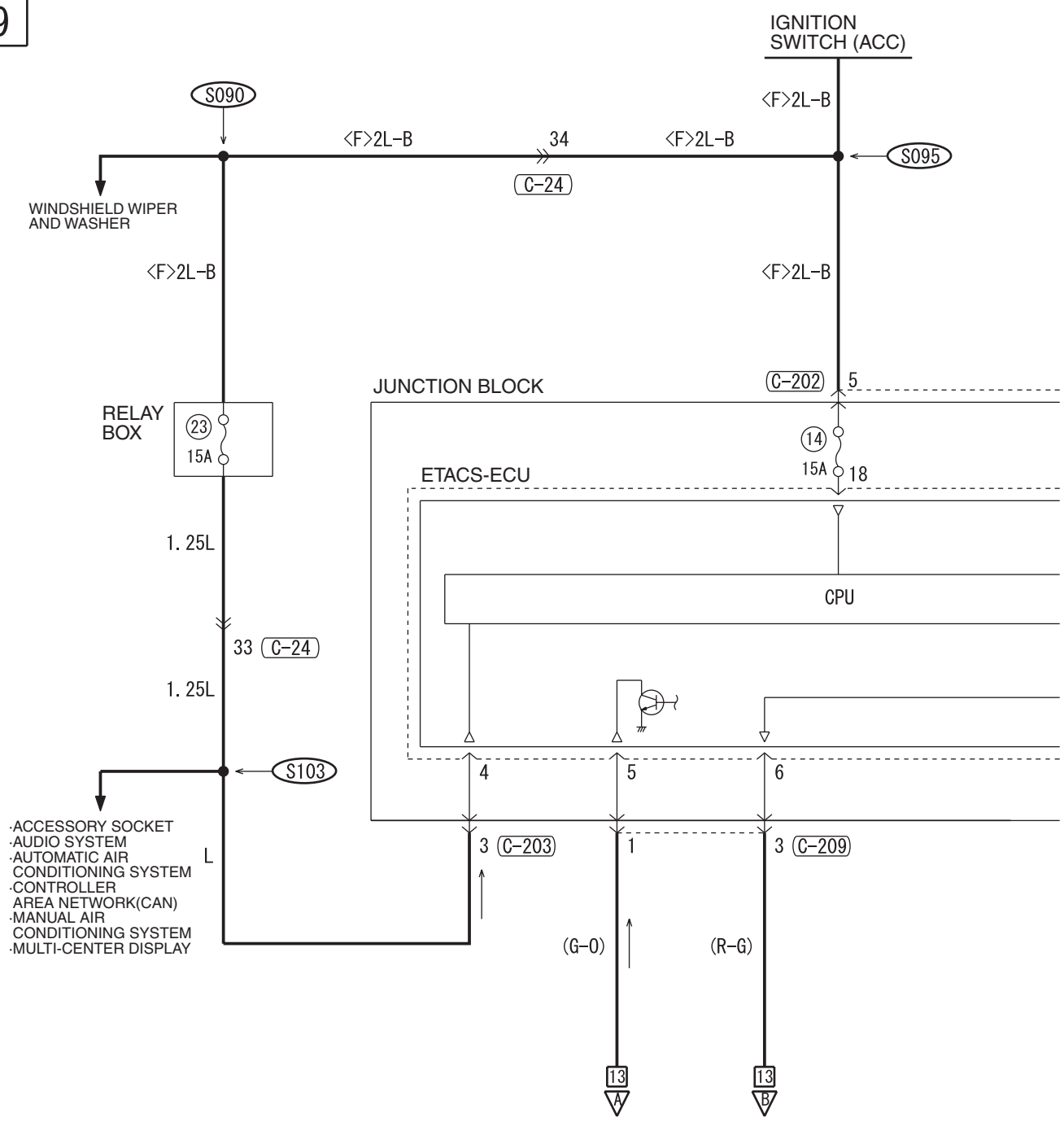

- ACCESSORY SOCKET
- AUDIO SYSTEM
- AUTOMATIC AIR CONDITIONING SYSTEM
- CONTROLLER AREA NETWORK(CAN)
- MANUAL AIR CONDITIONING SYSTEM
- MULTI-CENTER DISPLAY

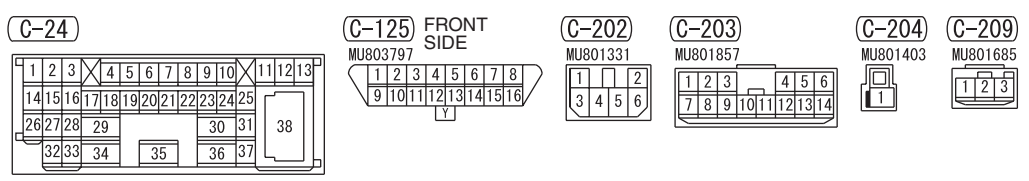

10

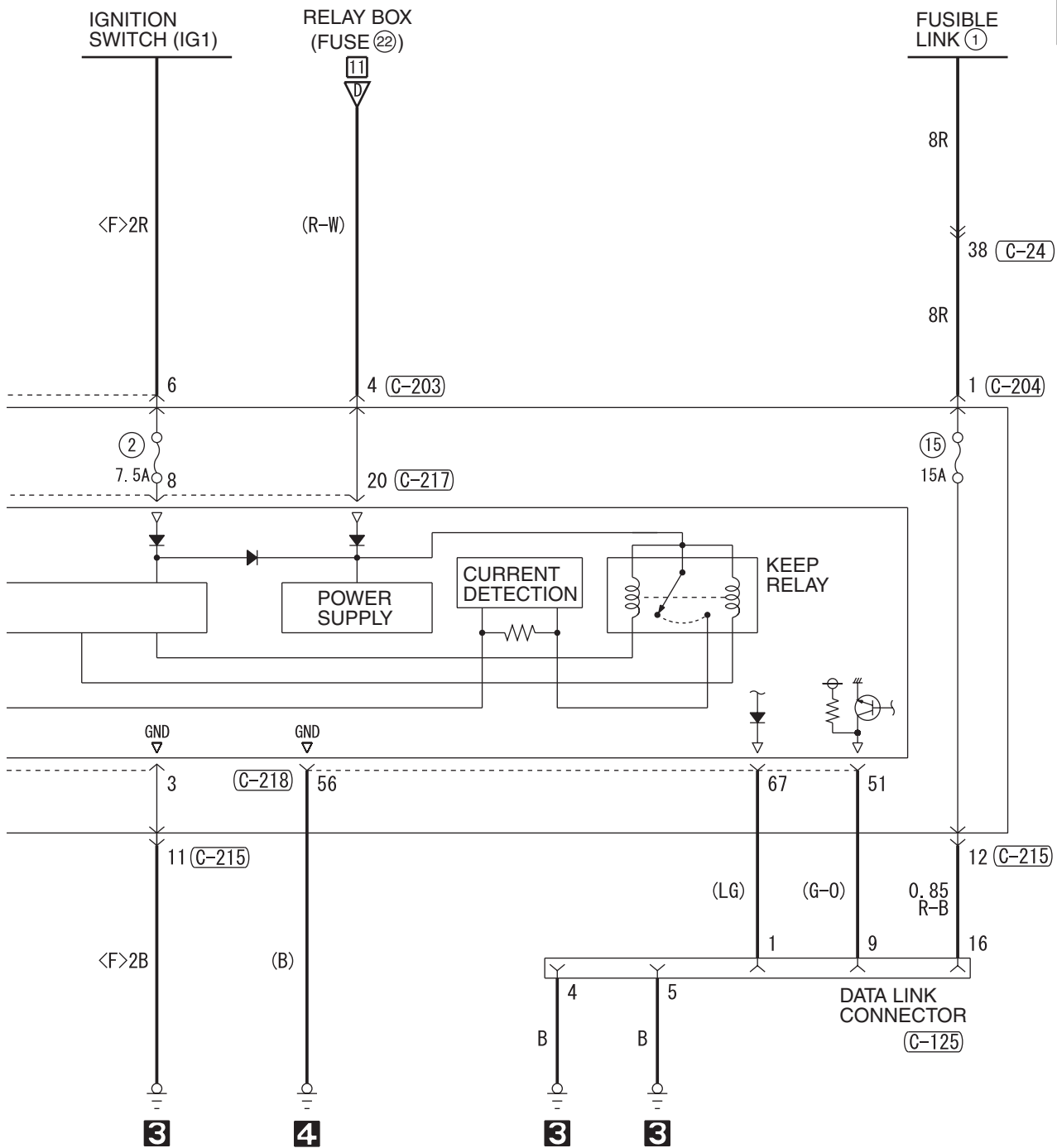

(C-215)

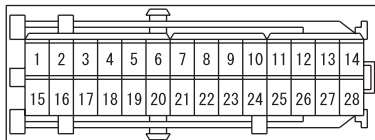

(C-217) JUNCTION BLOCK SIDE

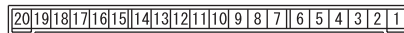

(C-218)

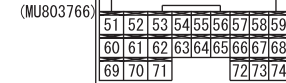

WIRE COLOR CODE
 B : BLACK LG : LIGHT GREEN G : GREEN L : BLUE
 BR : BROWN O : ORANGE GR : GRAY R : RED W : WHITE
 SB : SKY BLUE P : PINK Y : YELLOW V : VIOLET PU : PURPLE

H6P11M01EB

CENTRAL DOOR LOCKING SYSTEM (CONTINUED)

11

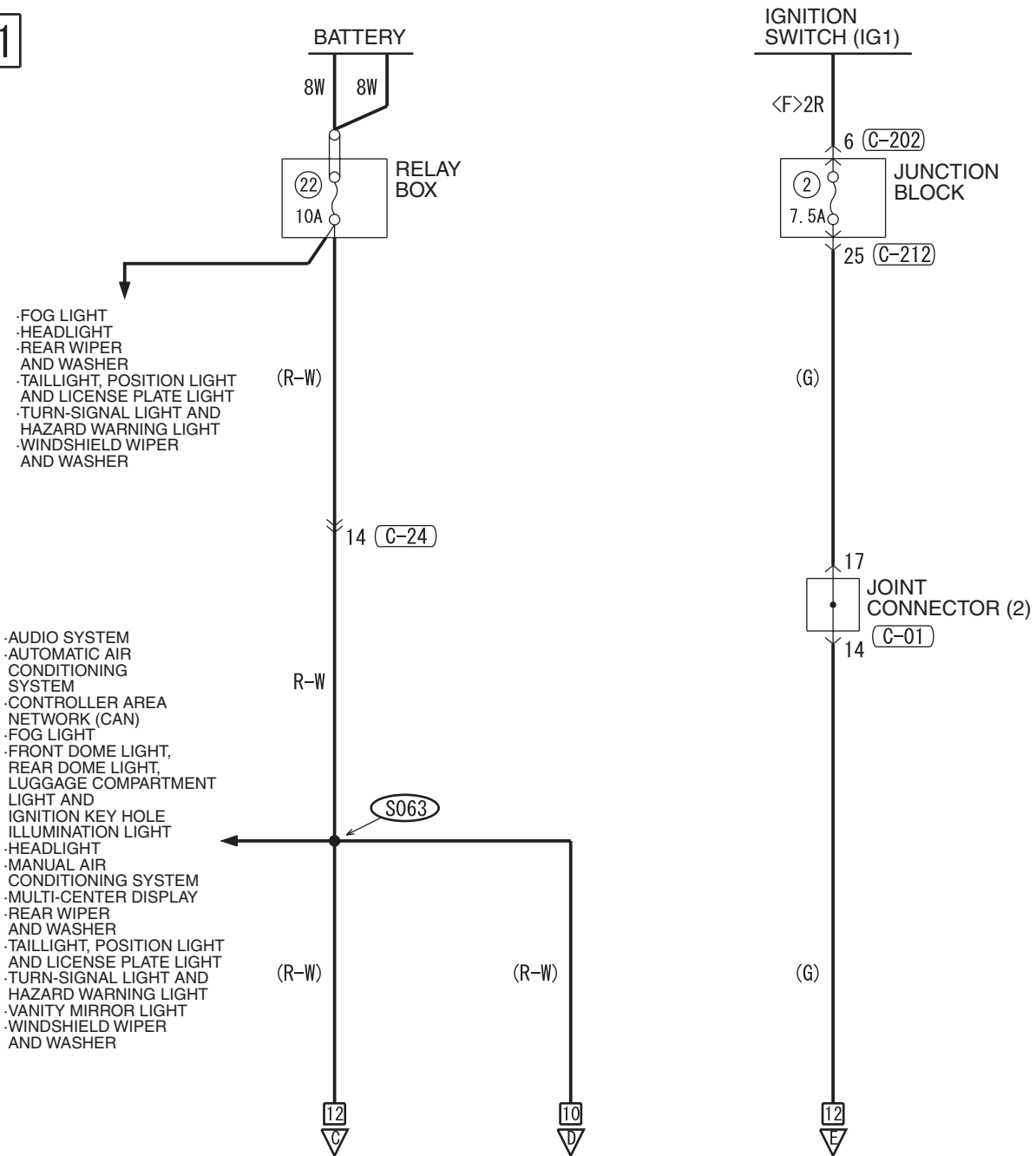

(C-01)



(C-03)

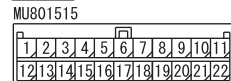

(C-04)

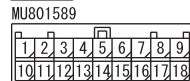

(C-24)

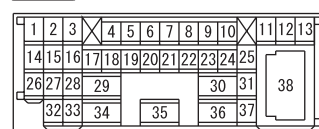

(C-125) FRONT SIDE

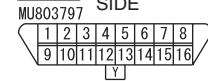

12

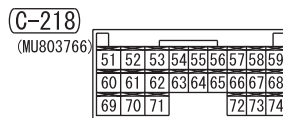
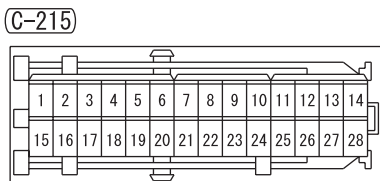
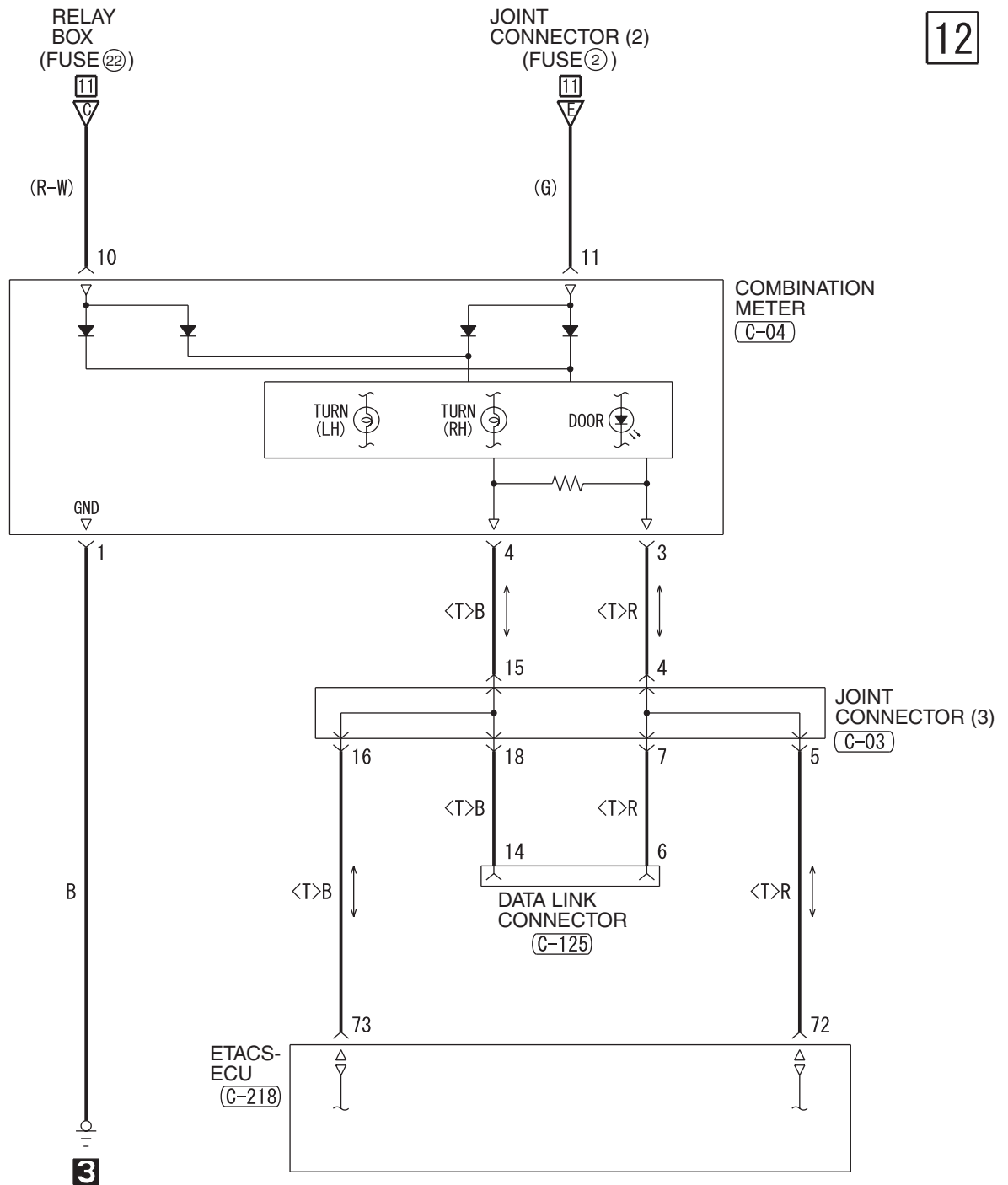

WIRE COLOR CODE
 B : BLACK SB : SKY BLUE
 BR : BROWN LG : LIGHT GREEN
 G : GREEN P : PINK GR : GRAY
 R : RED L : BLUE Y : YELLOW
 V : VIOLET W : WHITE O : ORANGE
 PU : PURPLE

H6P11M01FB

CENTRAL DOOR LOCKING SYSTEM (CONTINUED)

13

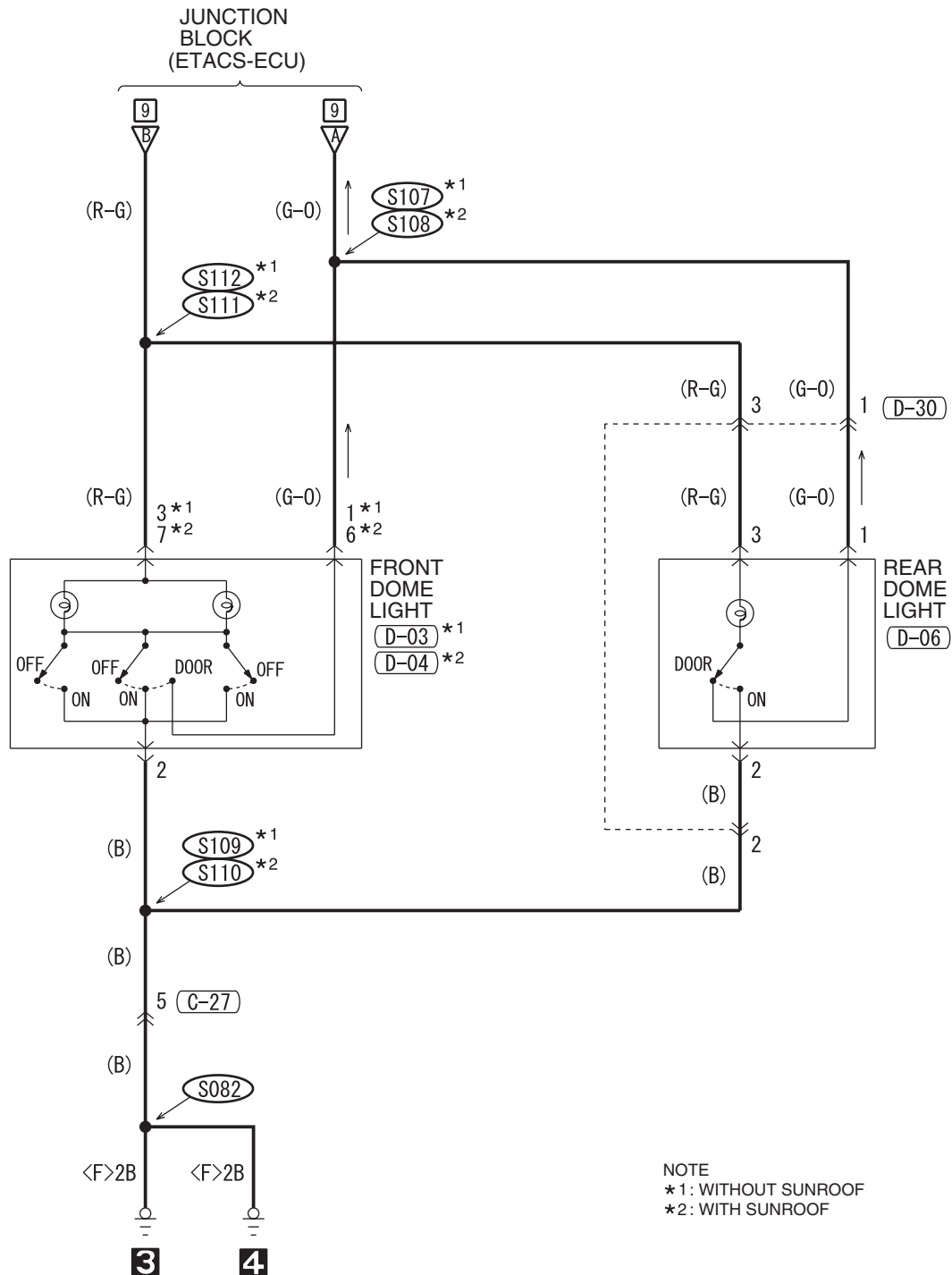

NOTE
* 1: WITHOUT SUNROOF
* 2: WITH SUNROOF

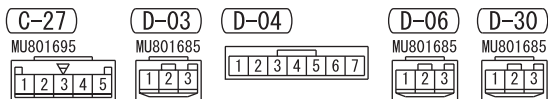

WIRE COLOR CODE
B : BLACK LG : LIGHT GREEN G : GREEN L : BLUE W : WHITE Y : YELLOW SB : SKY BLUE
BR : BROWN O : ORANGE GR : GRAY R : RED P : PINK V : VIOLET PU : PURPLE

NOTES

MANUAL AIR CONDITIONING SYSTEM <2.4L ENGINE>

M1901005501874

1

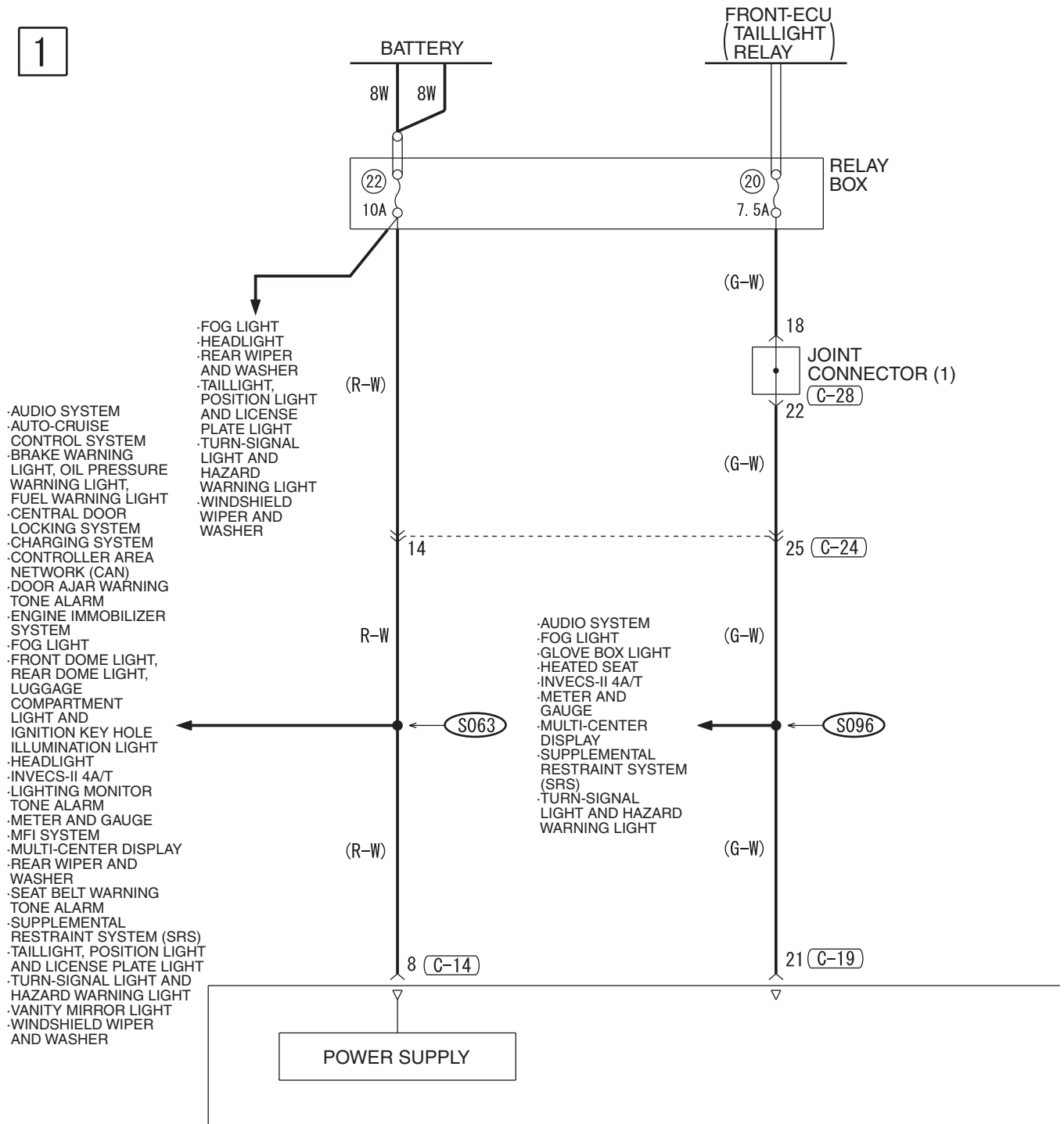

(C-01)

1	2	3	4	5	6	7	8	9	10	11
12	13	14	15	16	17	18	19	20	21	22
23	24	25	26	27	28	29	30	31	32	33

(C-14)

1	2	3	4	5	6	7	8
9	10	11	12	13	14	15	16

(C-19)

21	22	23	24	25	26
27	28	29	30	31	32

(C-24)

1	2	3	4	5	6	7	8	9	10	11	12	13
14	15	16	17	18	19	20	21	22	23	24	25	
26	27	28	29			30	31			38		
32	33	34		35		36	37					

(C-28)

1	2	3	4	5	6	7	8	9	10	11
12	13	14	15	16	17	18	19	20	21	22
23	24	25	26	27	28	29	30	31	32	33

2

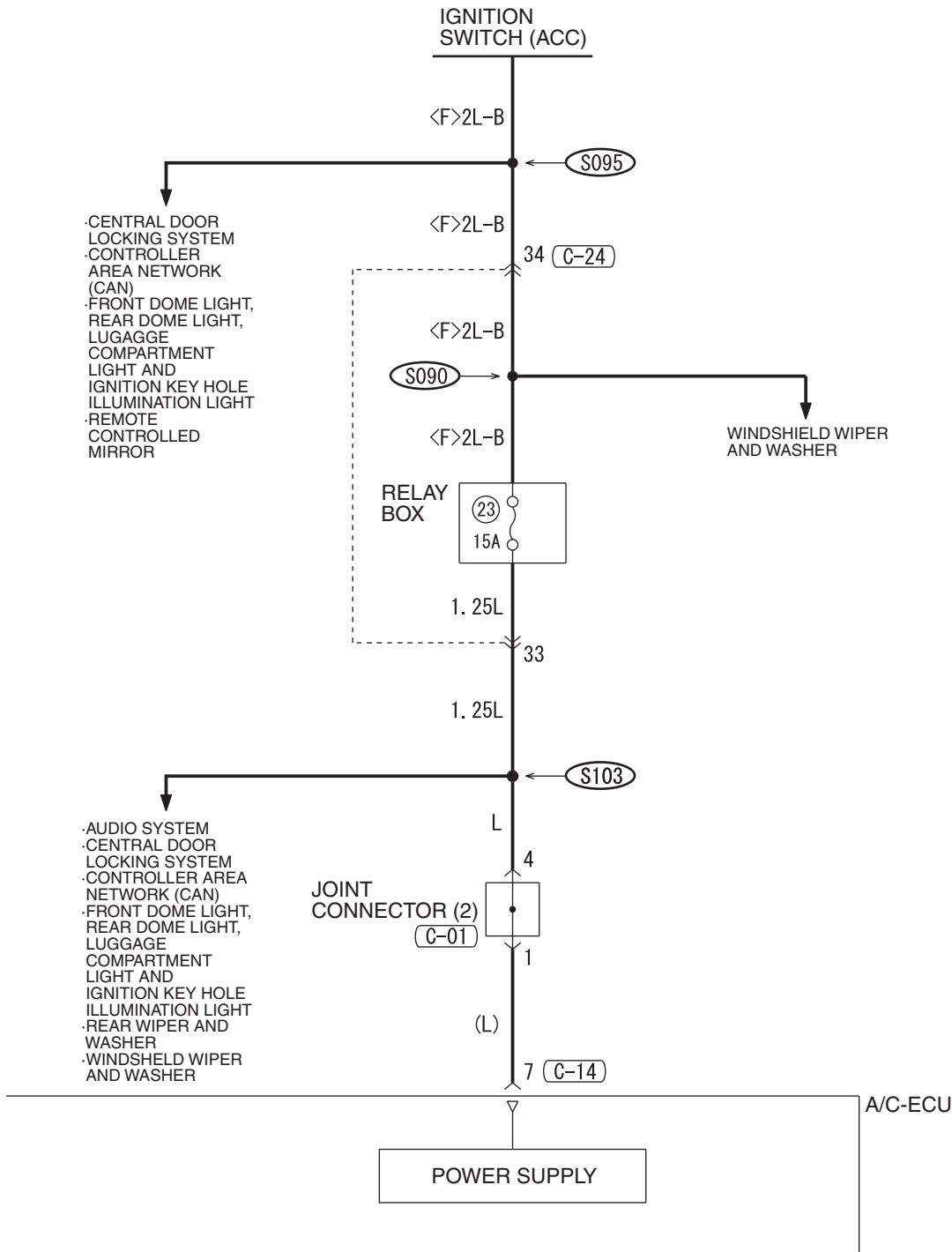

WIRE COLOR CODE
 B: BLACK LG: LIGHT GREEN G: GREEN L: BLUE W: WHITE Y: YELLOW SB: SKY BLUE
 BR: BROWN O: ORANGE GR: GRAY R: RED P: PINK V: VIOLET PU: PURPLE

MANUAL AIR CONDITIONING SYSTEM <2.4L ENGINE> (CONTINUED)

3

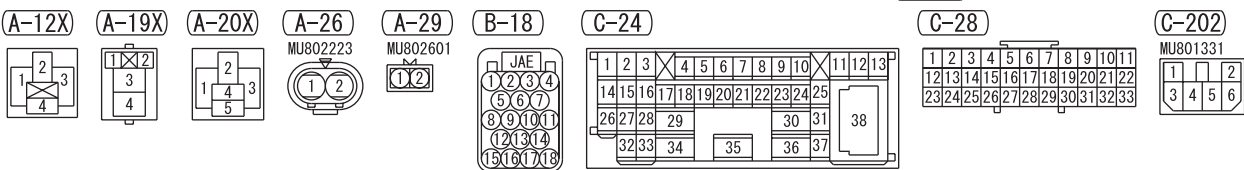
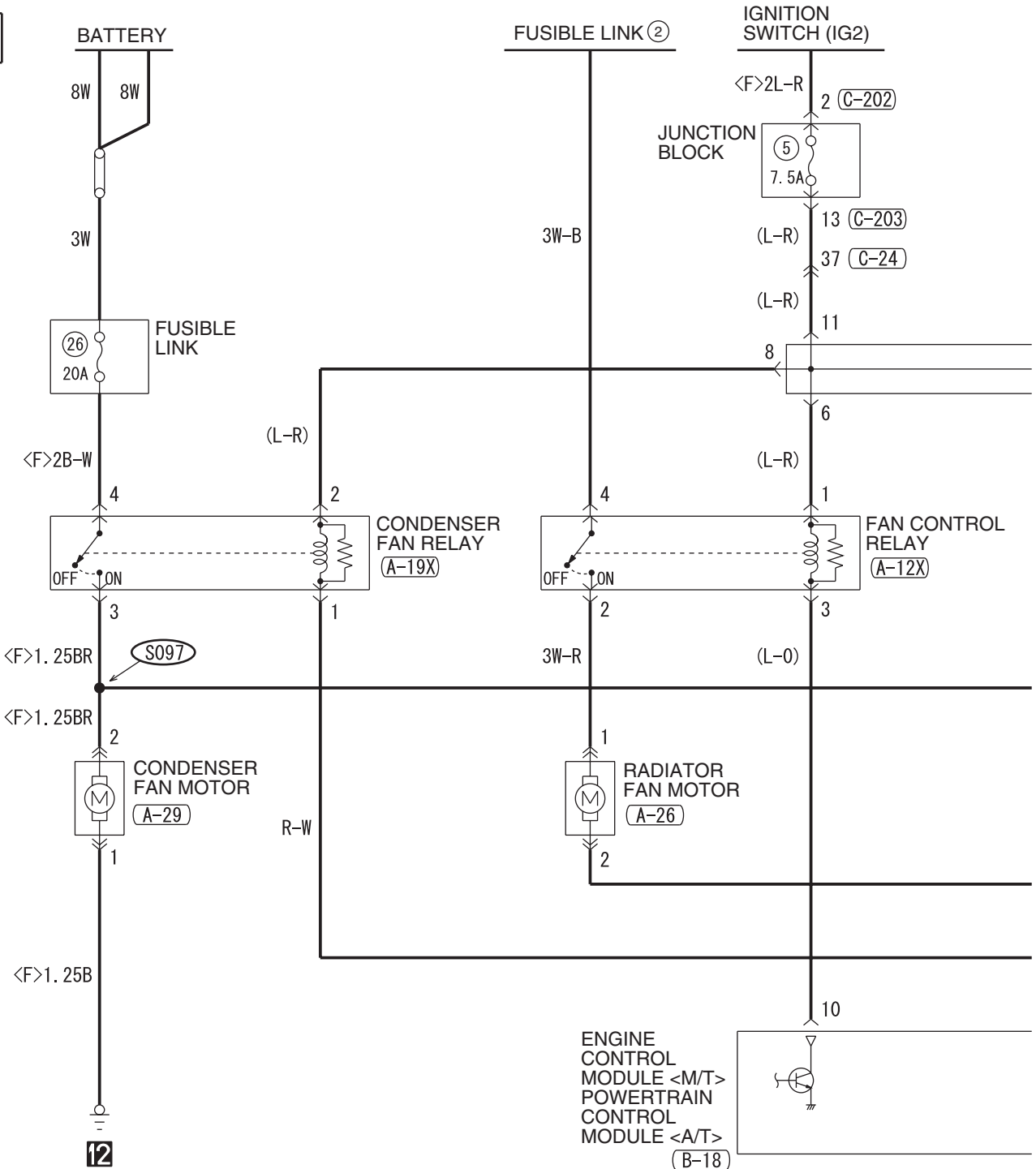

NOTE
 *1 : M/T
 *2 : A/T

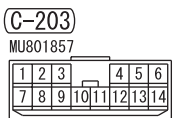
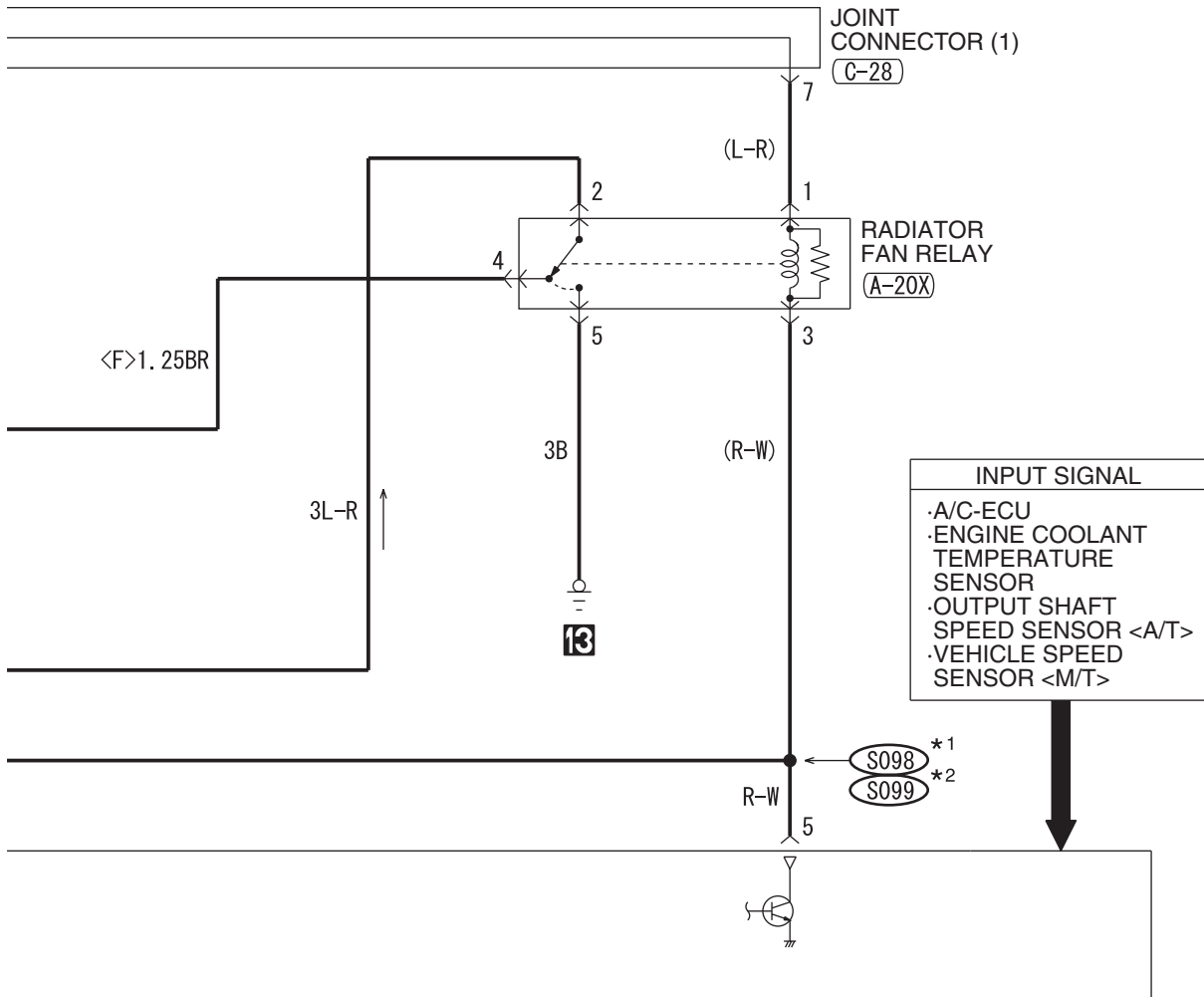

WIRE COLOR CODE
 B : BLACK LG : LIGHT GREEN G : GREEN L : BLUE
 BR : BROWN O : ORANGE GR : GRAY R : RED W : WHITE
 SB : SKY BLUE P : PINK Y : YELLOW V : VIOLET PU : PURPLE

MANUAL AIR CONDITIONING SYSTEM <2.4L ENGINE> (CONTINUED)

5

MODE SELECTION
DAMPER CONTROL
MOTOR AND POTENTIOMETER (C-104)

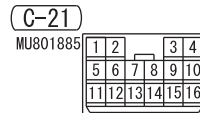
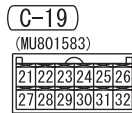
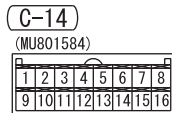
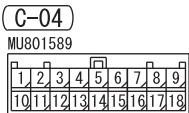
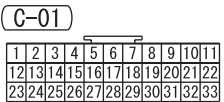
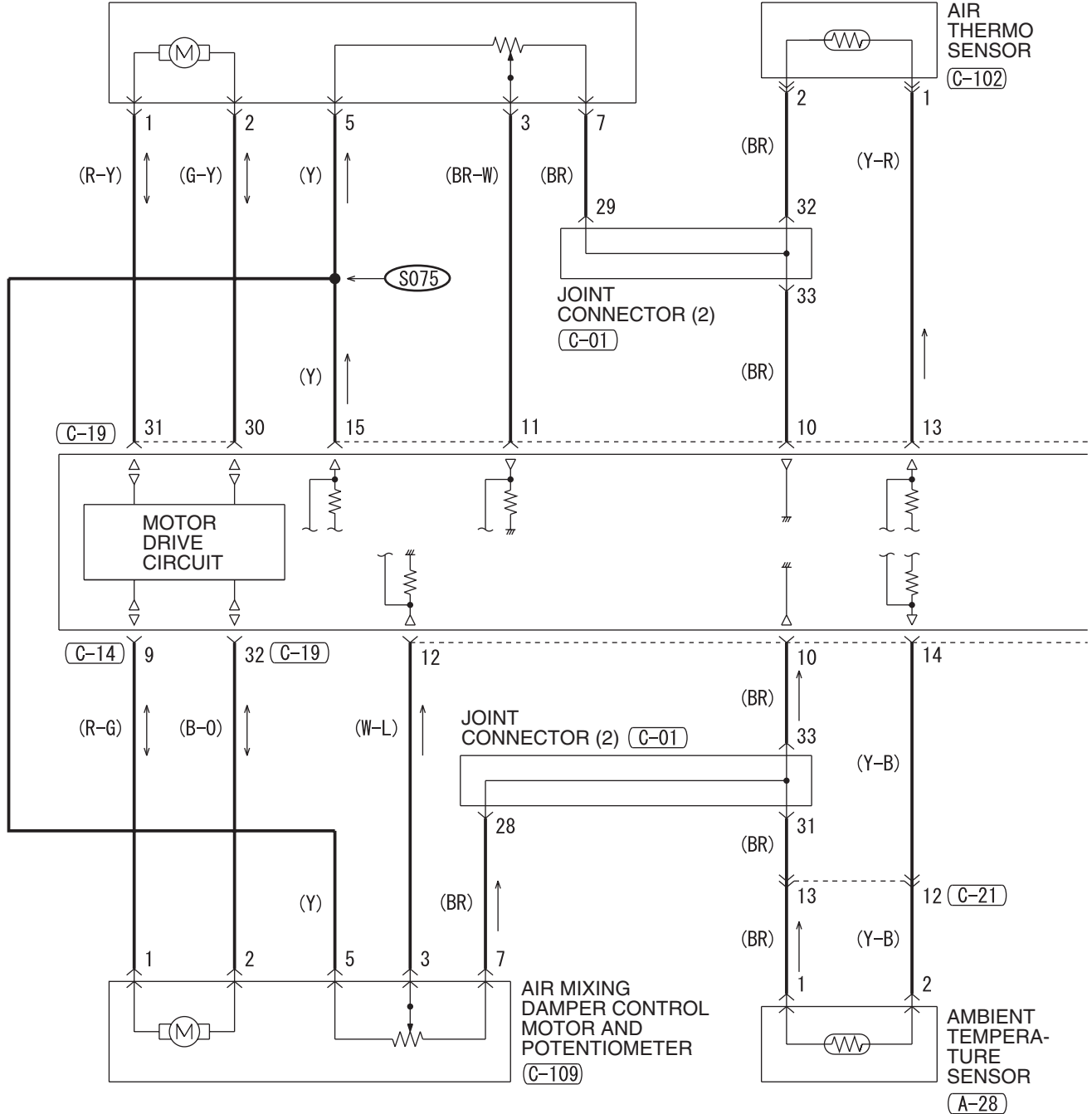

6

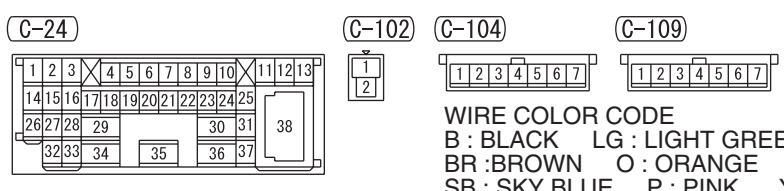
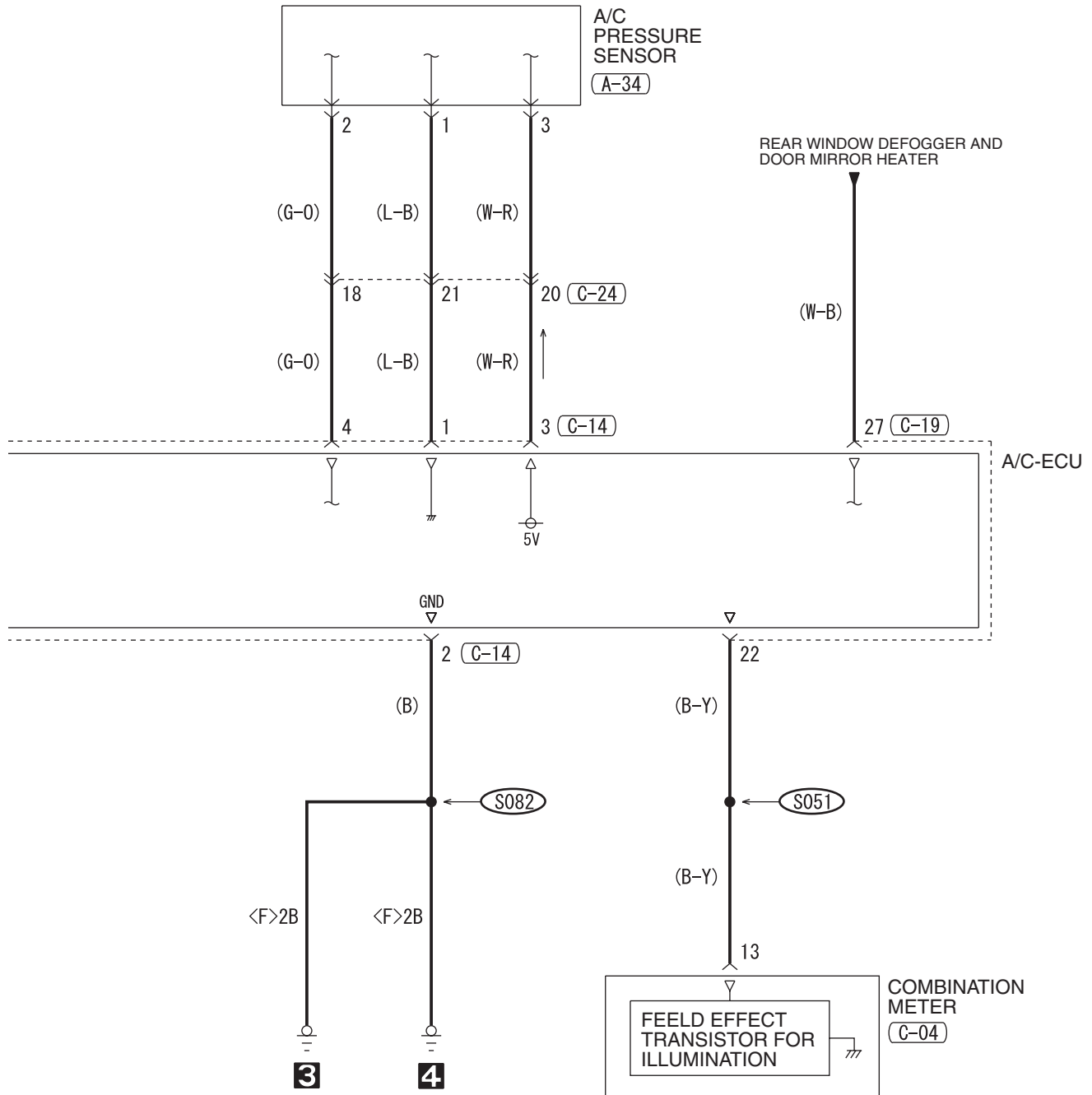

WIRE COLOR CODE
 B : BLACK LG : LIGHT GREEN G : GREEN L : BLUE
 BR : BROWN O : ORANGE GR : GRAY R : RED W : WHITE
 SB : SKY BLUE P : PINK Y : YELLOW V : VIOLET PU : PURPLE

MANUAL AIR CONDITIONING SYSTEM <2.4L ENGINE> (CONTINUED)

7

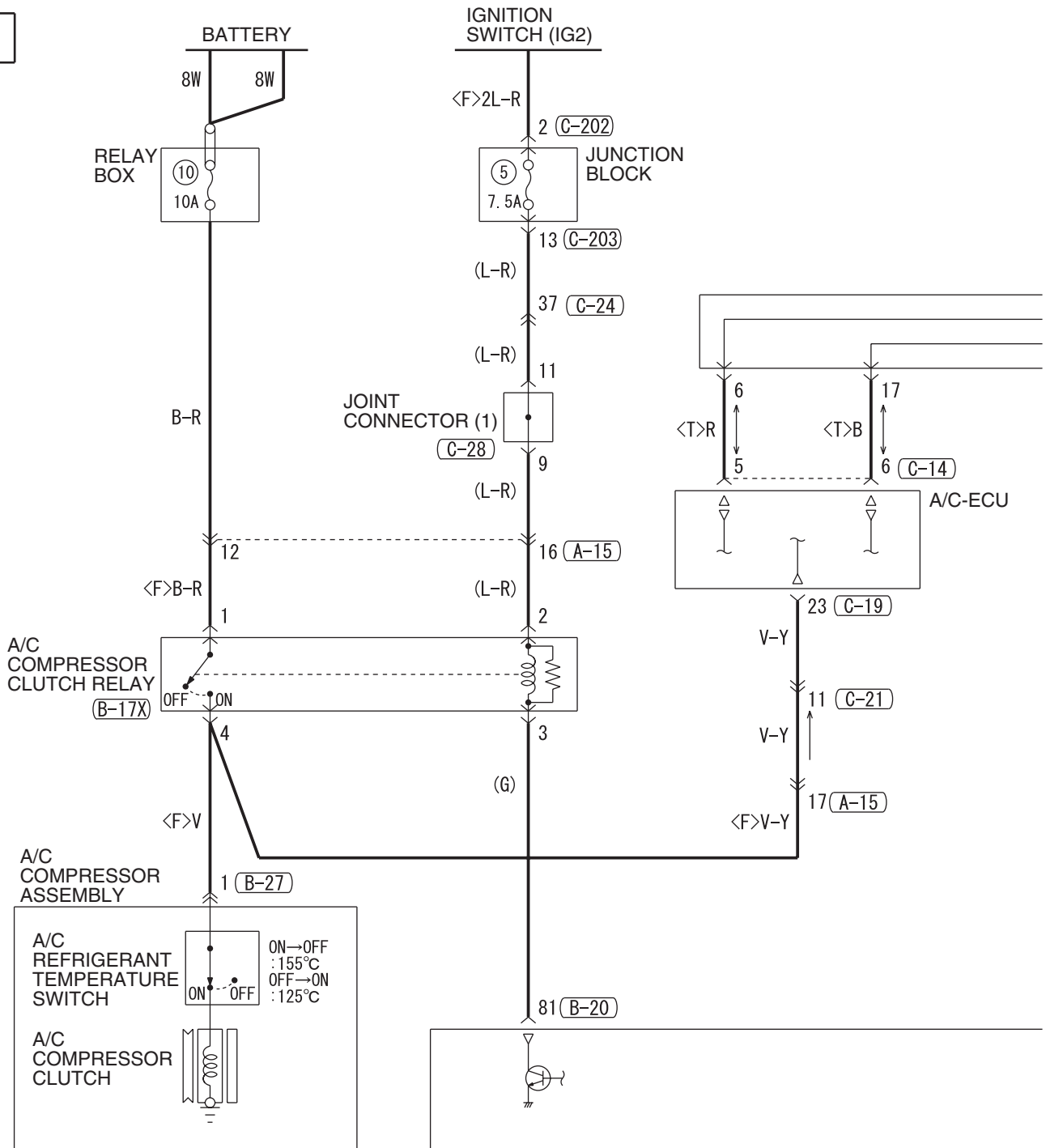

(A-02)

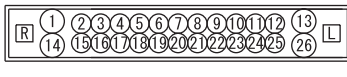

(A-15)

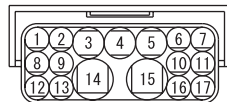

(B-17X)



(B-18)

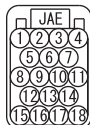

(B-20)

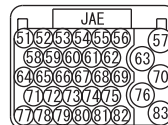

(B-27)



(C-03)

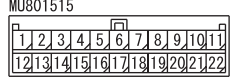

(C-202)



(C-203)

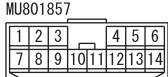

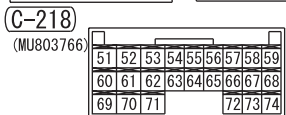
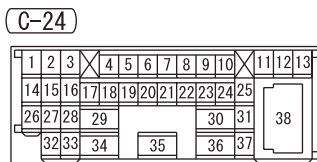
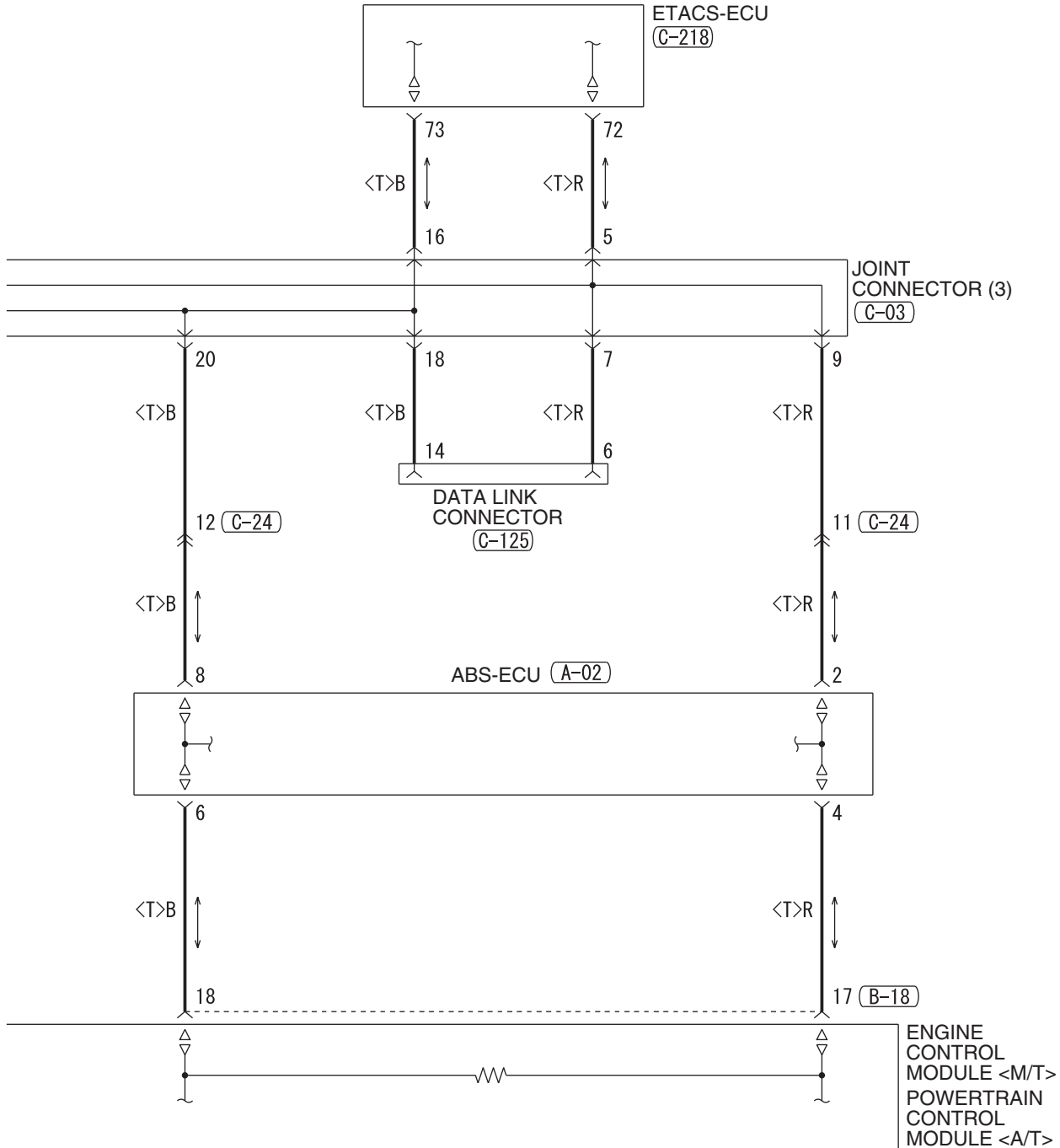

WIRE COLOR CODE

B : BLACK LG : LIGHT GREEN G : GREEN L : BLUE
 BR : BROWN O : ORANGE GR : GRAY R : RED W : WHITE
 SB : SKY BLUE P : PINK Y : YELLOW V : VIOLET PU : PURPLE

H6P12M00DB

MANUAL AIR CONDITIONING SYSTEM <2.4L ENGINE> (CONTINUED)

9

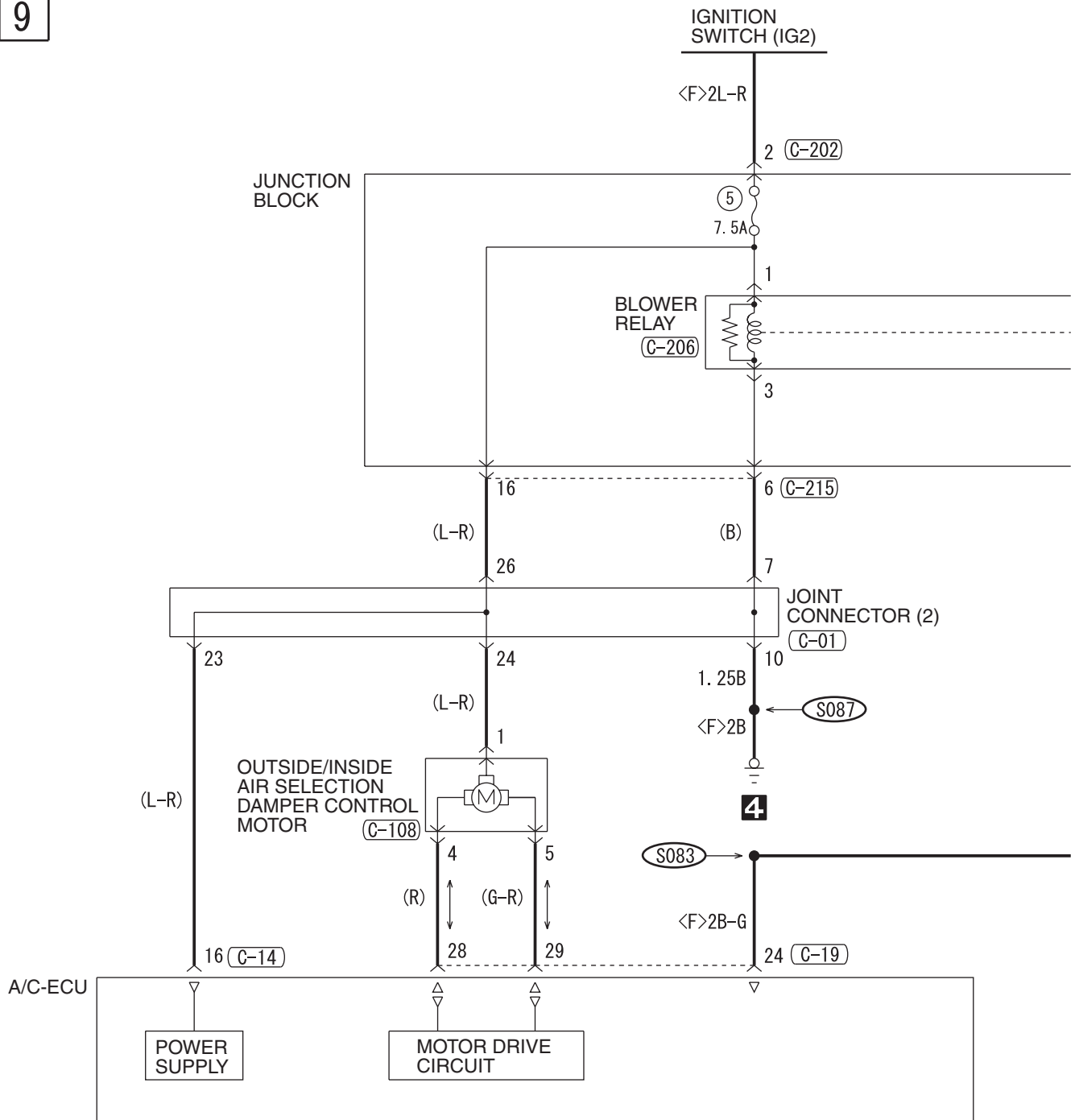

C-01



C-12



C-14



C-19



C-24

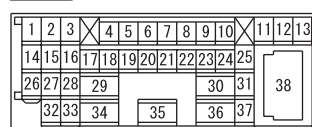

C-106



C-108

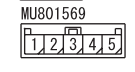

10

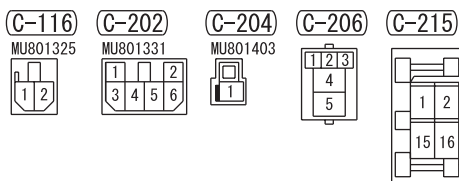
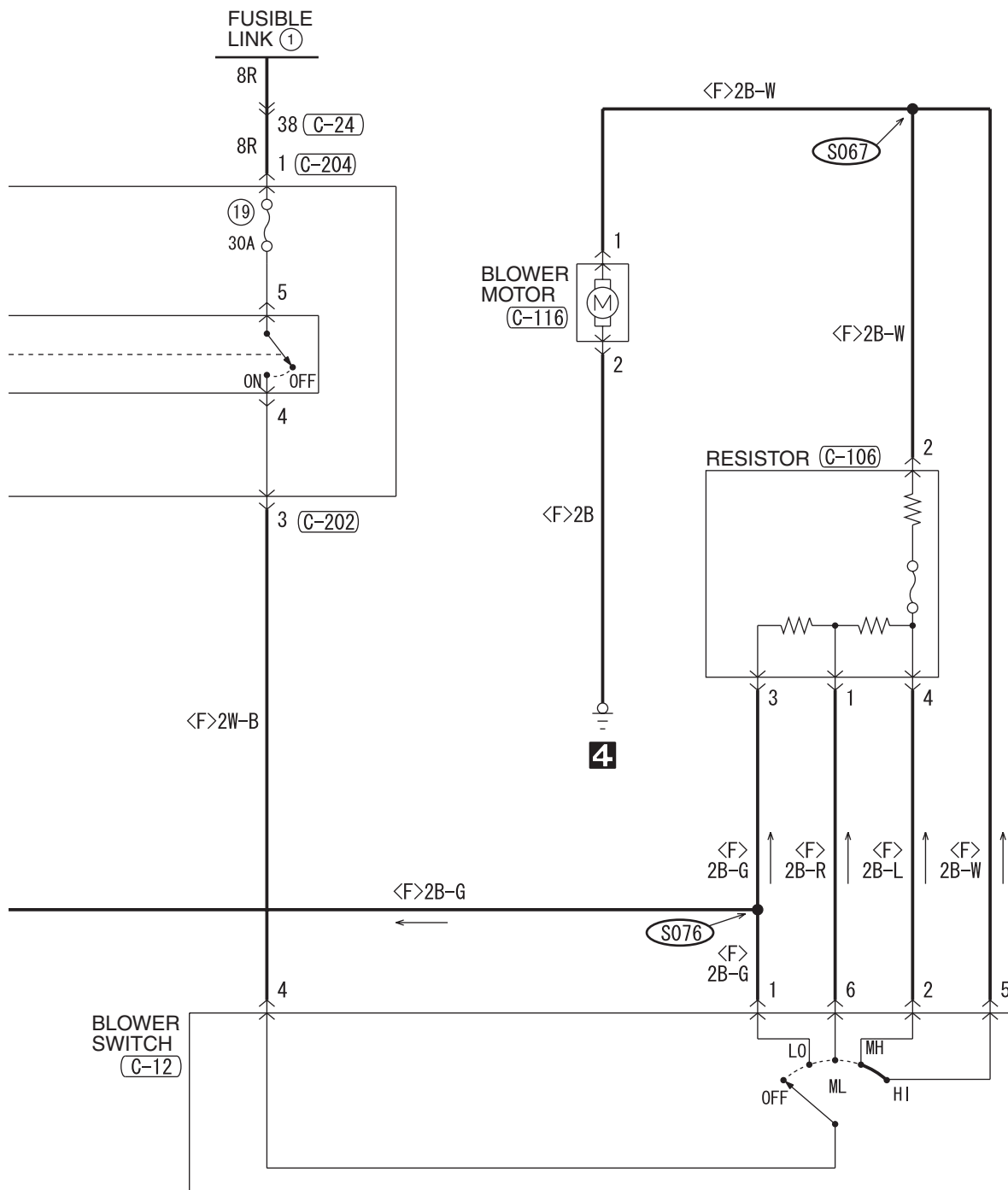

WIRE COLOR CODE
 B : BLACK SB : SKY BLUE
 BR : BROWN LG : LIGHT GREEN
 G : GREEN P : PINK GR : GRAY
 R : RED L : BLUE Y : YELLOW
 V : VIOLET W : WHITE O : ORANGE
 PU : PURPLE

H6P12M00EB

TSB Revision

MANUAL AIR CONDITIONING SYSTEM <3.8L ENGINE>

M1901005501885

1

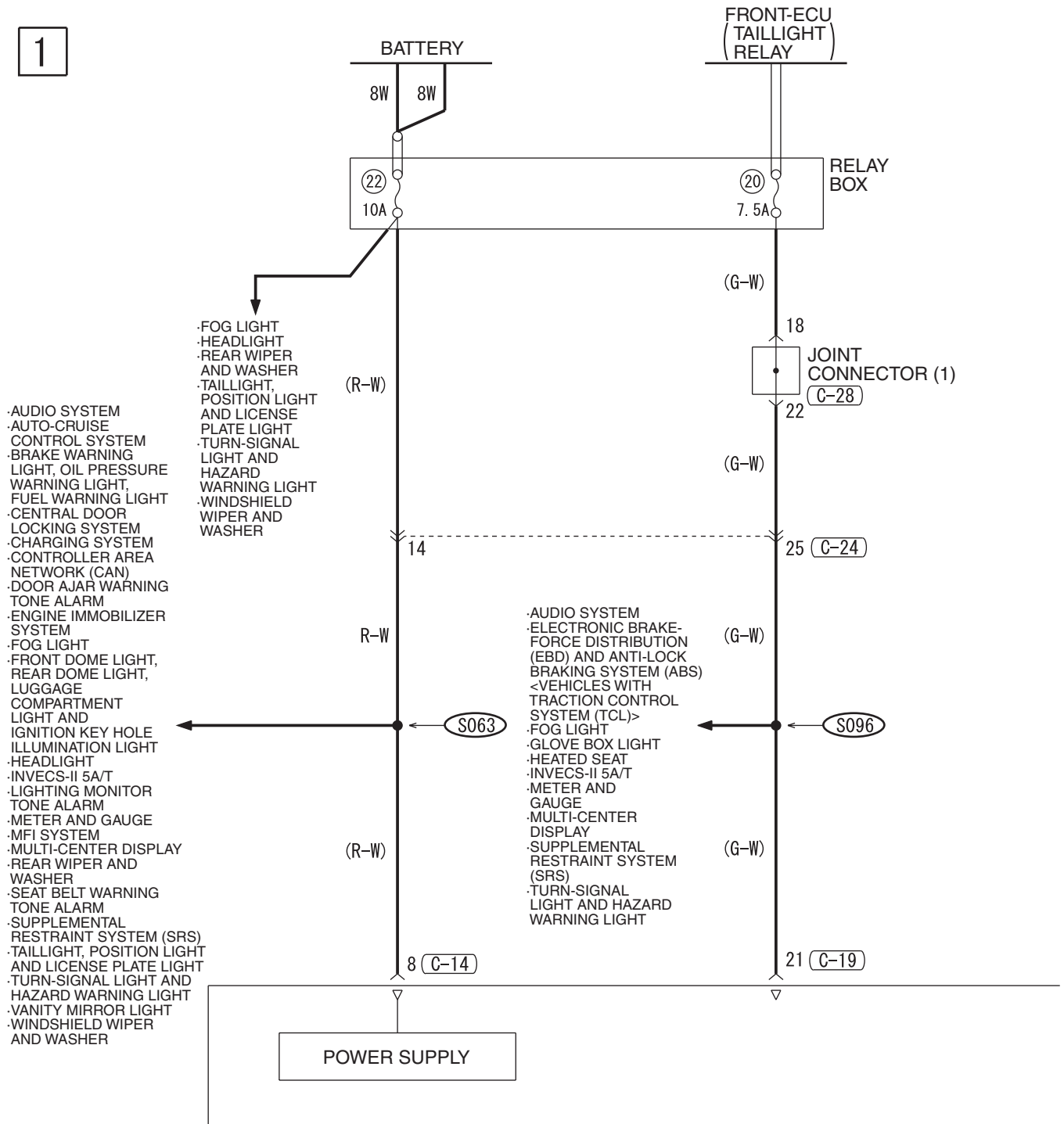

(C-01)

1	2	3	4	5	6	7	8	9	10	11
12	13	14	15	16	17	18	19	20	21	22
23	24	25	26	27	28	29	30	31	32	33

(C-14)

1	2	3	4	5	6	7	8
9	10	11	12	13	14	15	16

(C-19)

21	22	23	24	25	26
27	28	29	30	31	32

(C-24)

1	2	3	4	5	6	7	8	9	10	11	12	13
14	15	16	17	18	19	20	21	22	23	24	25	
26	27	28	29			30	31					
32	33	34		35		36	37			38		

(C-28)

1	2	3	4	5	6	7	8	9	10	11
12	13	14	15	16	17	18	19	20	21	22
23	24	25	26	27	28	29	30	31	32	33

2

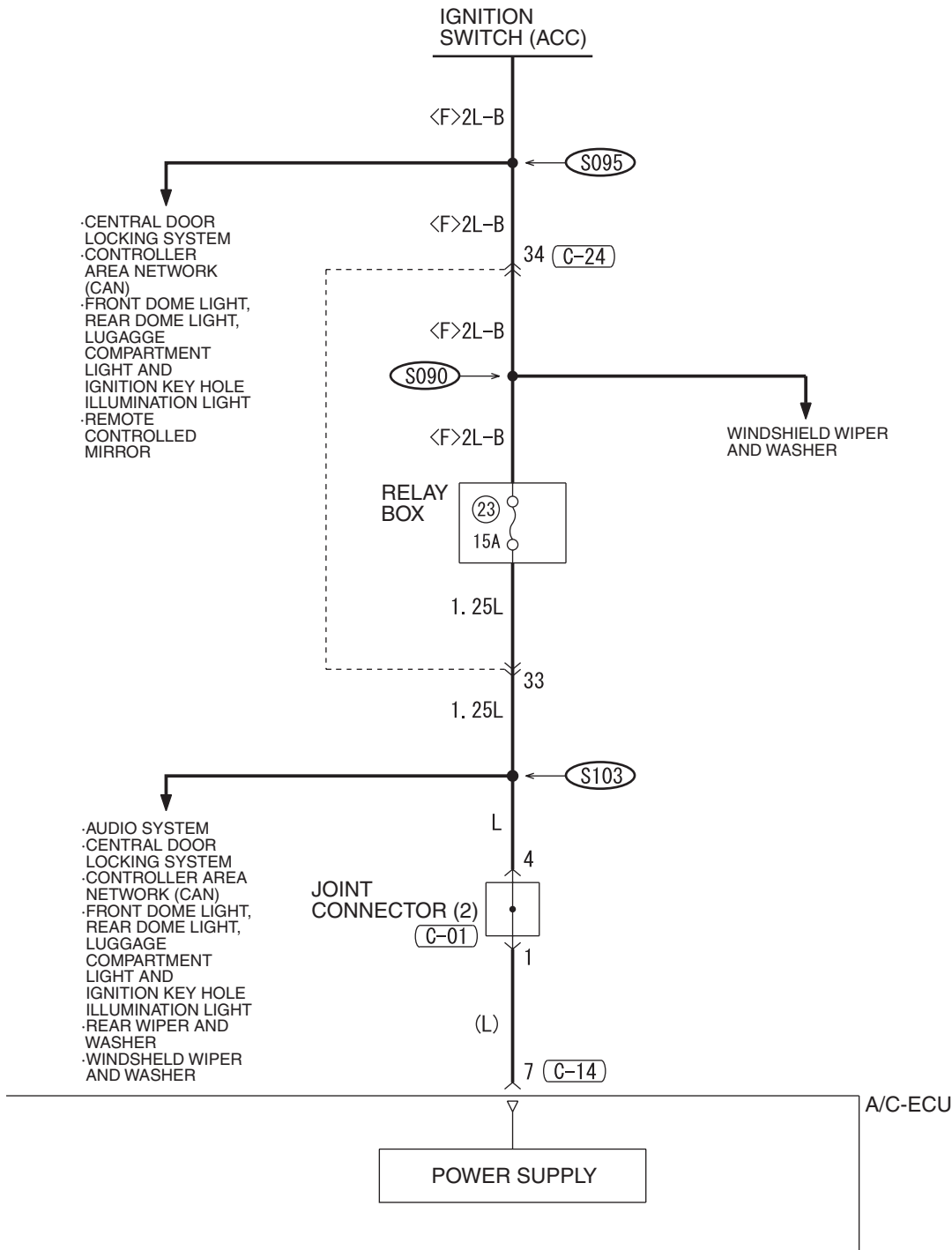

WIRE COLOR CODE
 B: BLACK LG: LIGHT GREEN G: GREEN L: BLUE W: WHITE Y: YELLOW SB: SKY BLUE
 BR: BROWN O: ORANGE GR: GRAY R: RED P: PINK V: VIOLET PU: PURPLE

MANUAL AIR CONDITIONING SYSTEM <3.8L ENGINE> (CONTINUED)

3

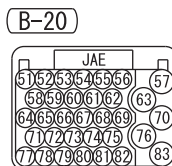
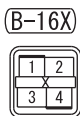
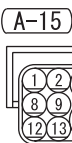
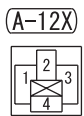
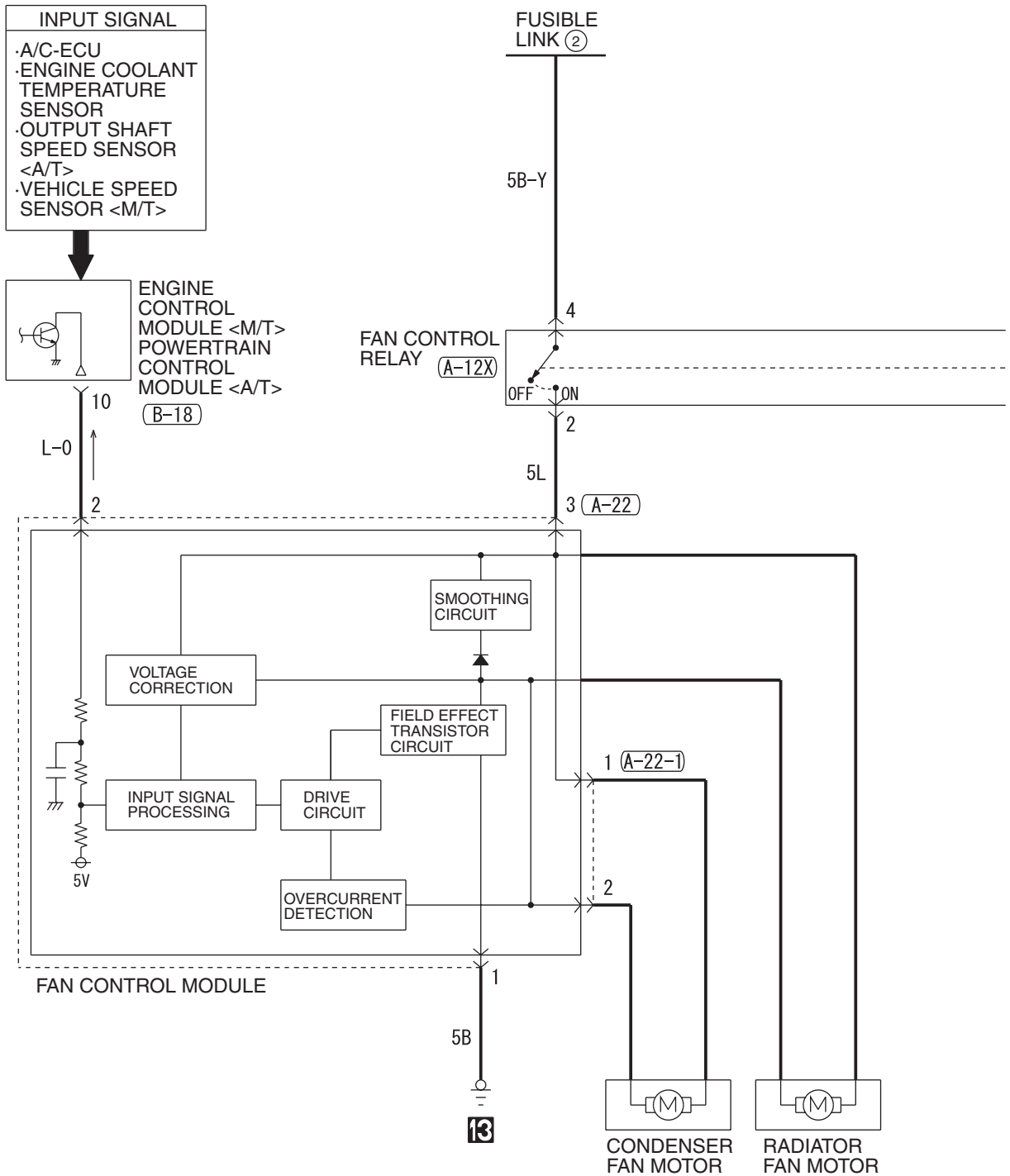

4

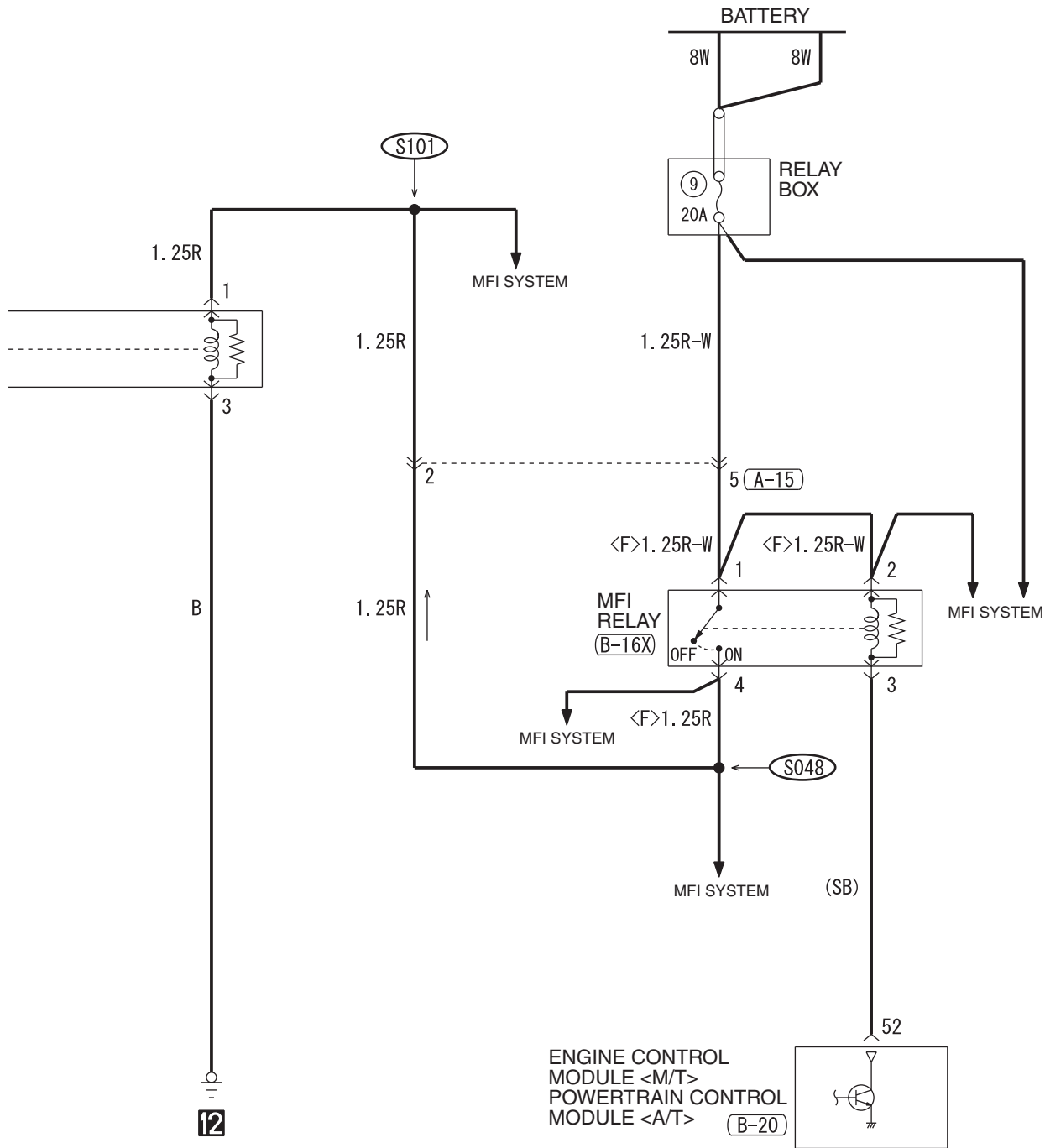

WIRE COLOR CODE
 B: BLACK LG: LIGHT GREEN G: GREEN L: BLUE W: WHITE Y: YELLOW SB: SKY BLUE
 BR: BROWN O: ORANGE GR: GRAY R: RED P: PINK V: VIOLET PU: PURPLE

H6P12M01BB

TSB Revision

MANUAL AIR CONDITIONING SYSTEM <3.8L ENGINE> (CONTINUED)

5

MODE SELECTION
DAMPER CONTROL
MOTOR AND POTENTIOMETER (C-104)

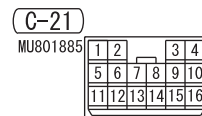
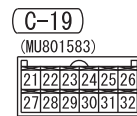
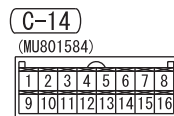
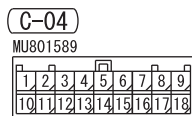
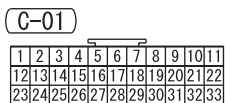
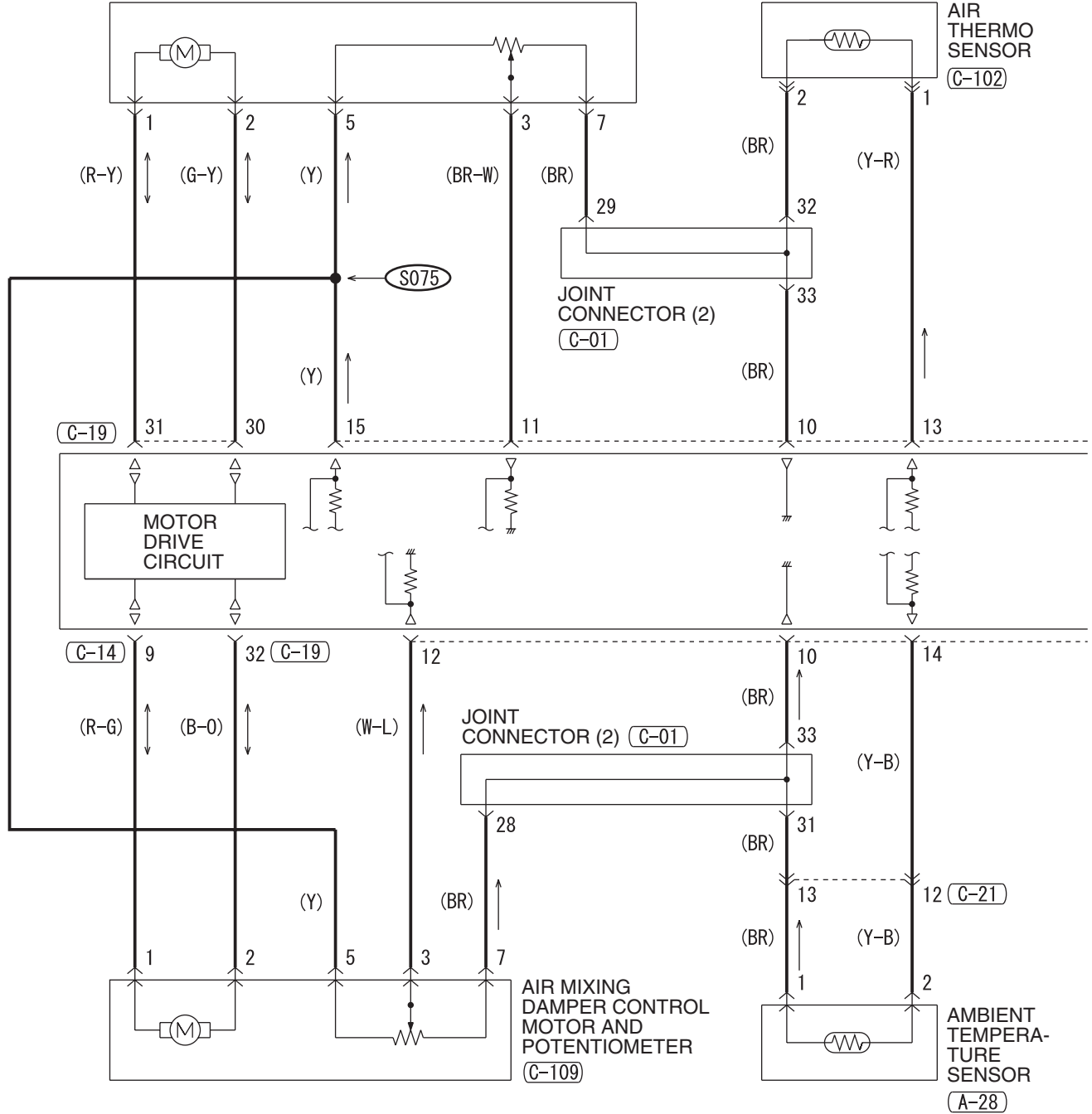

6

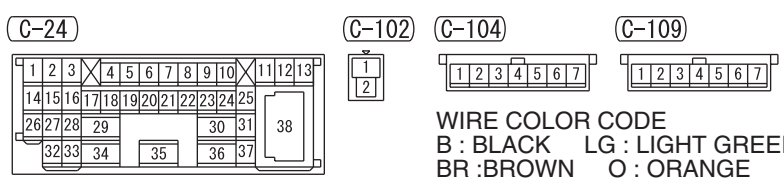
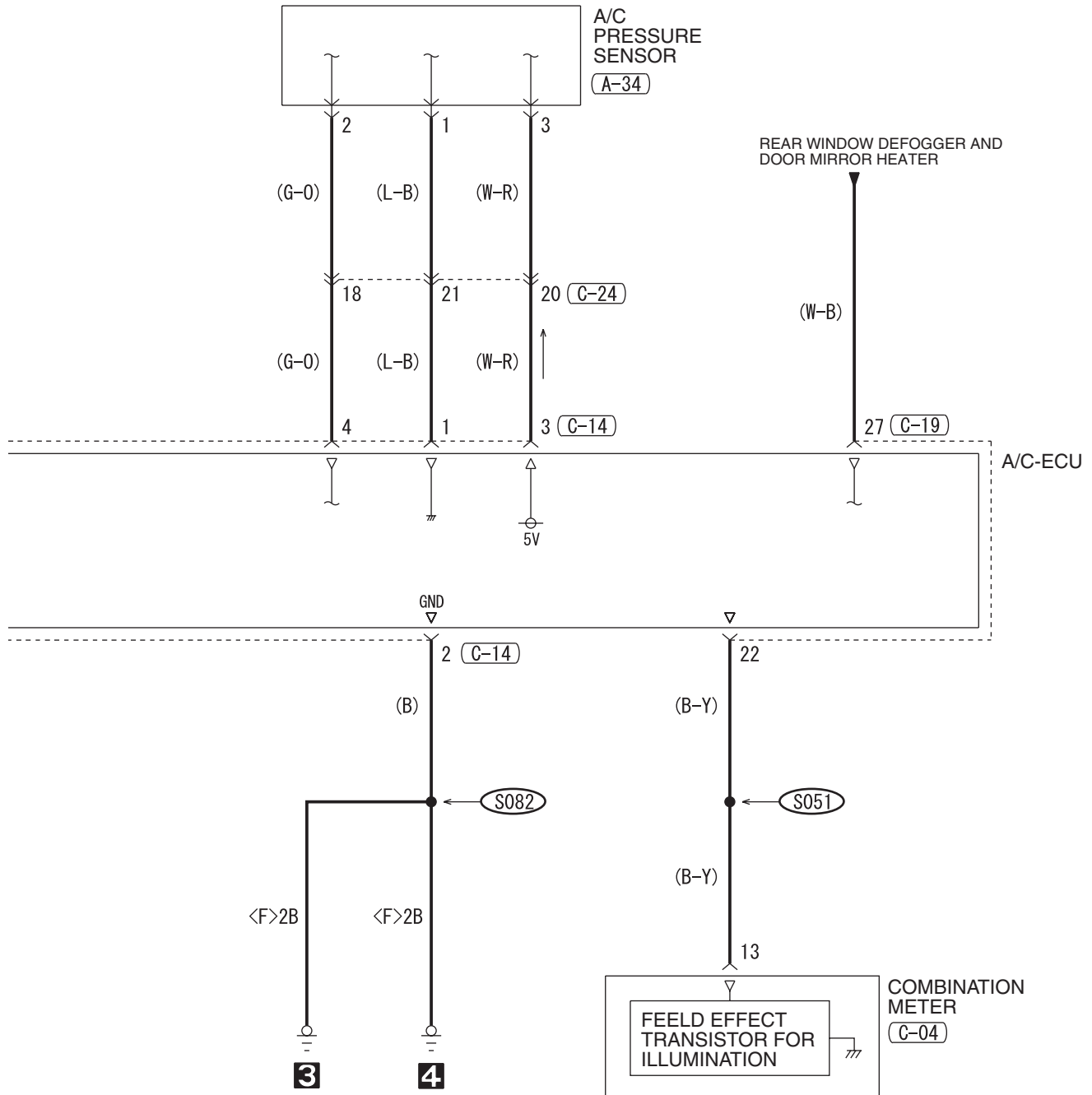

WIRE COLOR CODE
 B : BLACK LG : LIGHT GREEN G : GREEN L : BLUE
 BR : BROWN O : ORANGE GR : GRAY R : RED W : WHITE
 SB : SKY BLUE P : PINK Y : YELLOW V : VIOLET PU : PURPLE

H6P12M01CB

TSB Revision

MANUAL AIR CONDITIONING SYSTEM <3.8L ENGINE> (CONTINUED)

7

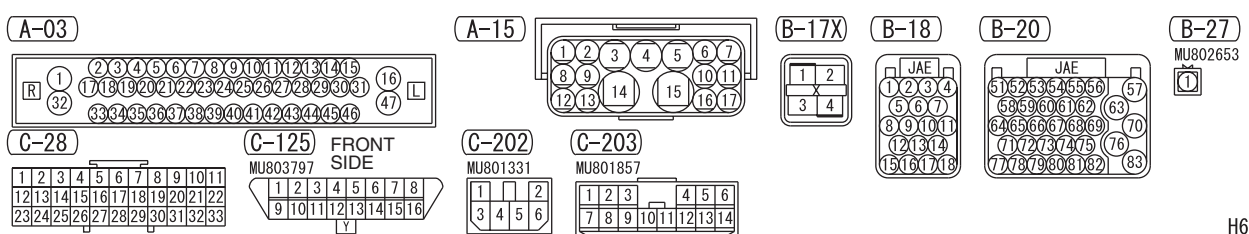
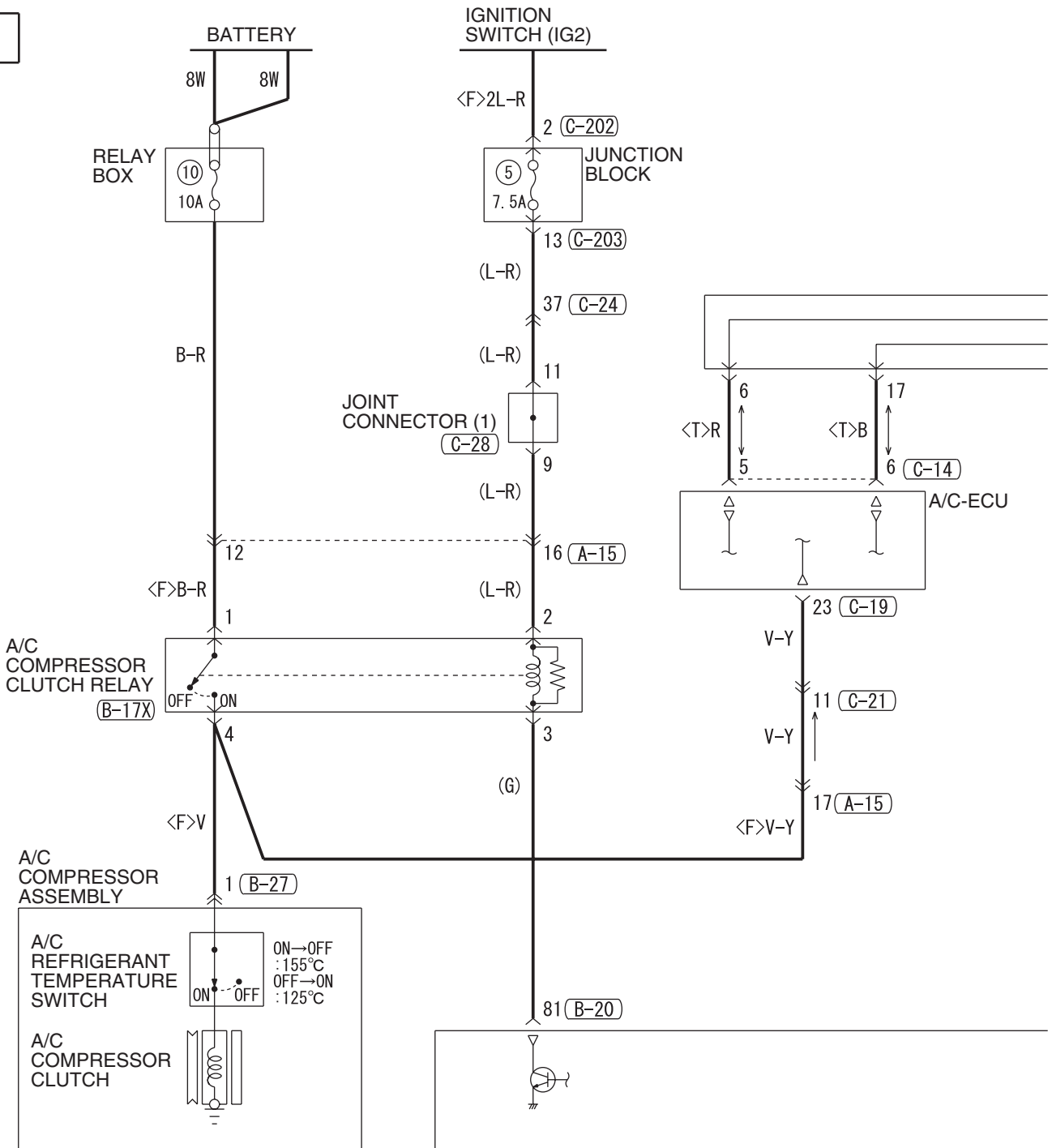

8

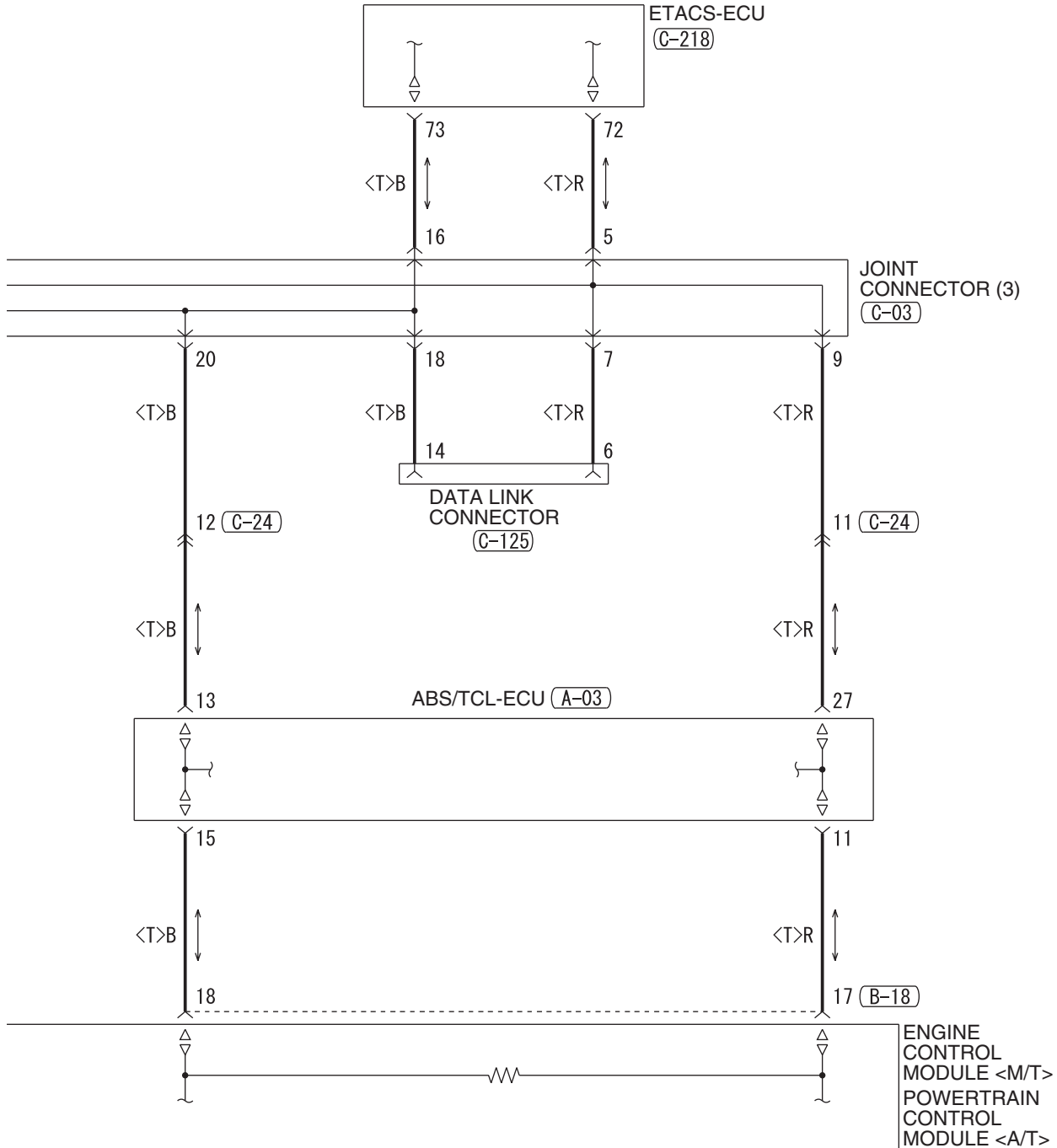

(C-03)

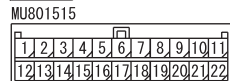

(C-14)

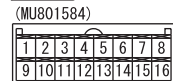

(C-19)

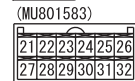

(C-21)

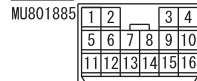

(C-24)

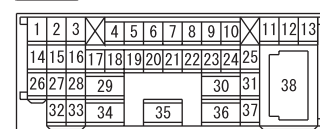

(C-218)

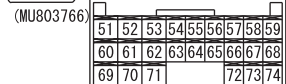

WIRE COLOR CODE

B: BLACK LG: LIGHT GREEN
G: GREEN L: BLUE BR: BROWN O: ORANGE GR: GRAY R: RED W: WHITE
SB: SKY BLUE P: PINK Y: YELLOW V: VIOLET PU: PURPLE H6P12M01DB

MANUAL AIR CONDITIONING SYSTEM <3.8L ENGINE> (CONTINUED)

9

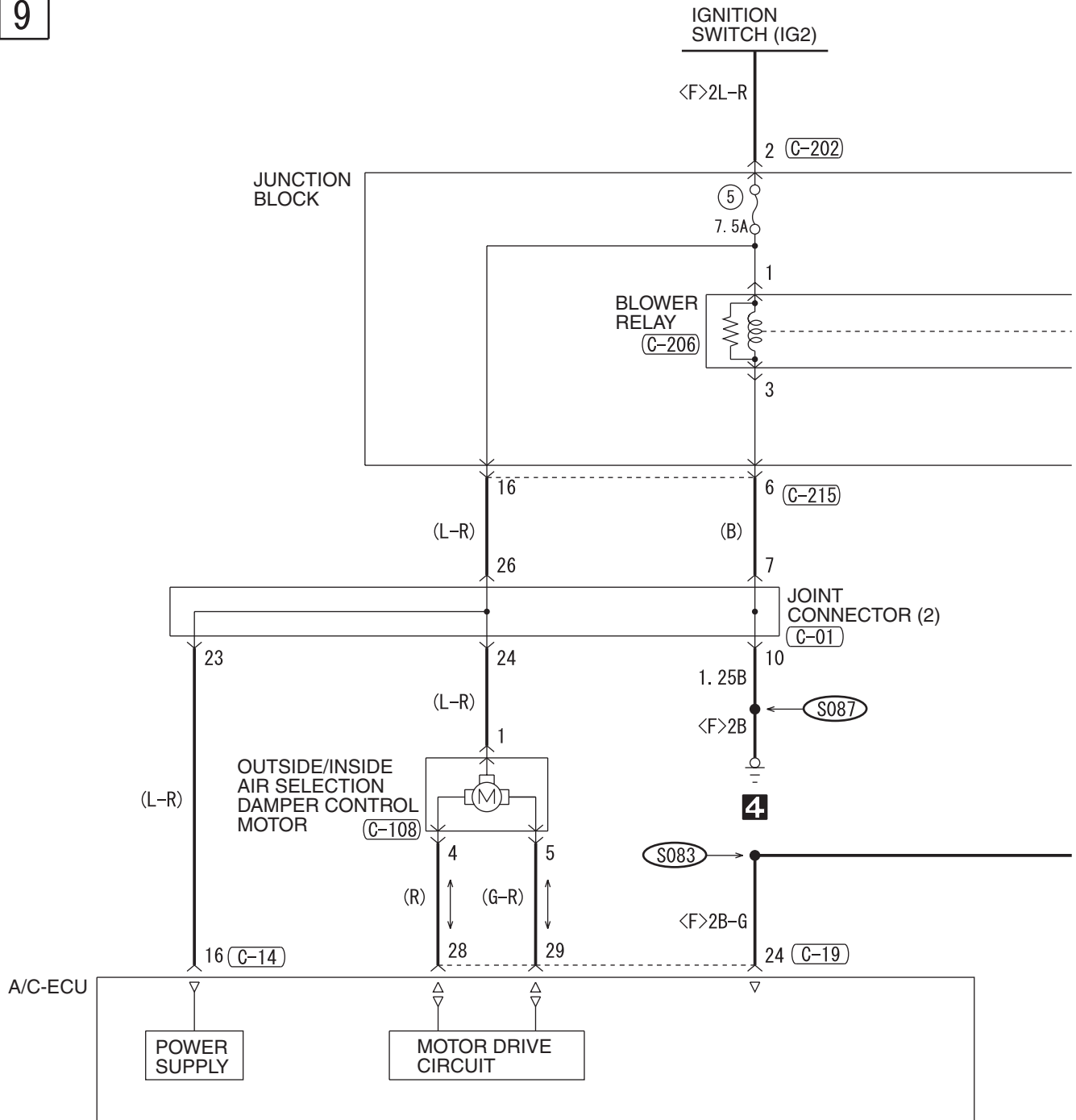

C-01

1	2	3	4	5	6	7	8	9	10	11
12	13	14	15	16	17	18	19	20	21	22
23	24	25	26	27	28	29	30	31	32	33

C-12

1	2
3	4
5	6

C-14

1	2	3	4	5	6	7	8
9	10	11	12	13	14	15	16

C-19

21	22	23	24	25	26
27	28	29	30	31	32

C-24

1	2	3	4	5	6	7	8	9	10	11	12	13
14	15	16	17	18	19	20	21	22	23	24	25	
26	27	28	29		30	31	38					
32	33	34		35	36	37						

C-106

1	2
3	4

C-108

1	2	3	4	5
---	---	---	---	---

10

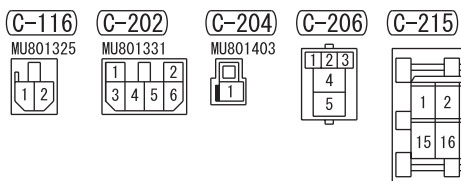
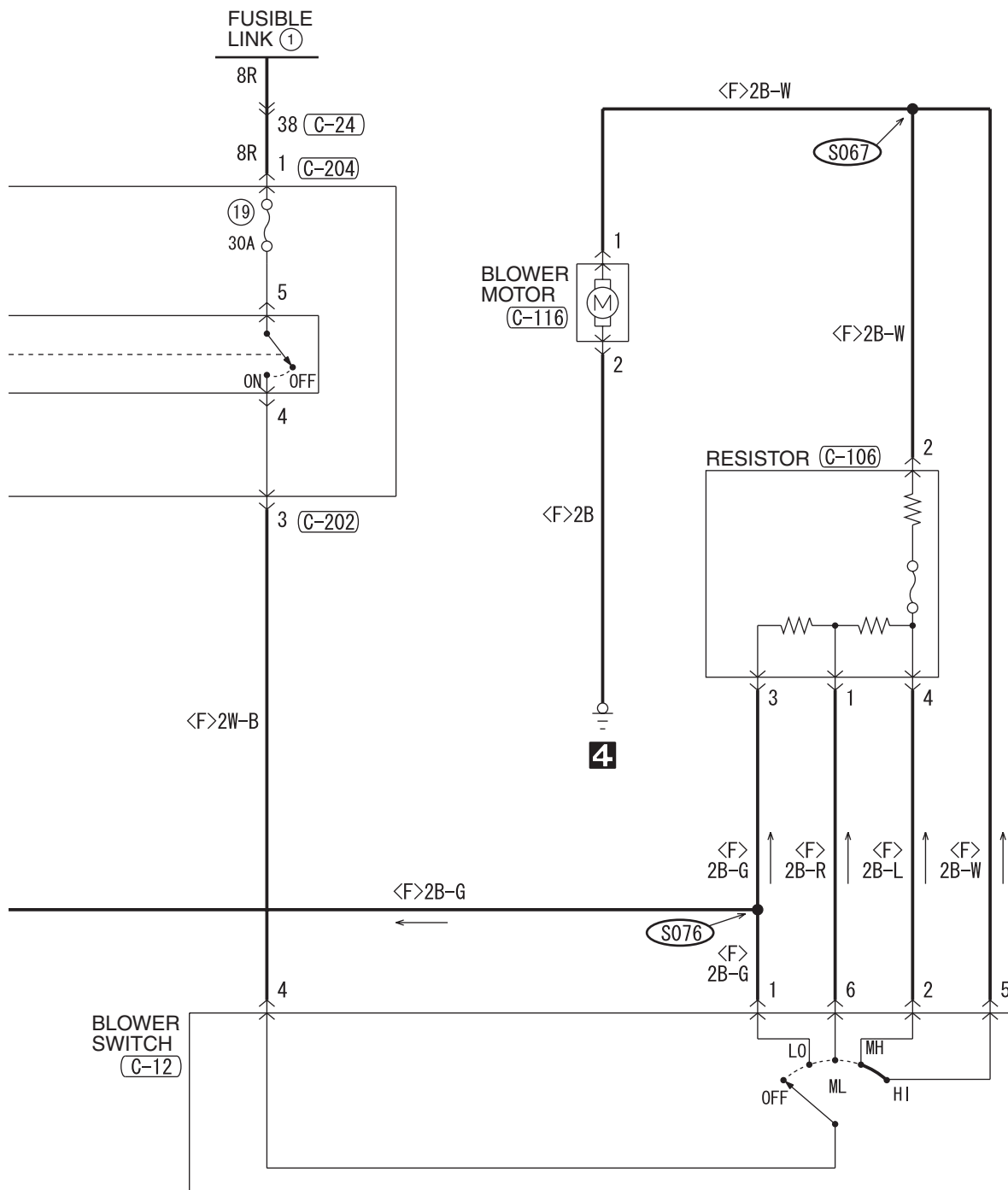

WIRE COLOR CODE
 B : BLACK SB : SKY BLUE
 BR : BROWN LG : LIGHT GREEN
 G : GREEN P : PINK GR : GRAY
 R : RED L : BLUE Y : YELLOW
 V : VIOLET W : WHITE O : ORANGE
 PU : PURPLE

H6P12M01EB

TSB Revision

AUTOMATIC AIR CONDITIONING SYSTEM <3.8L ENGINE>

M1901005600696

1

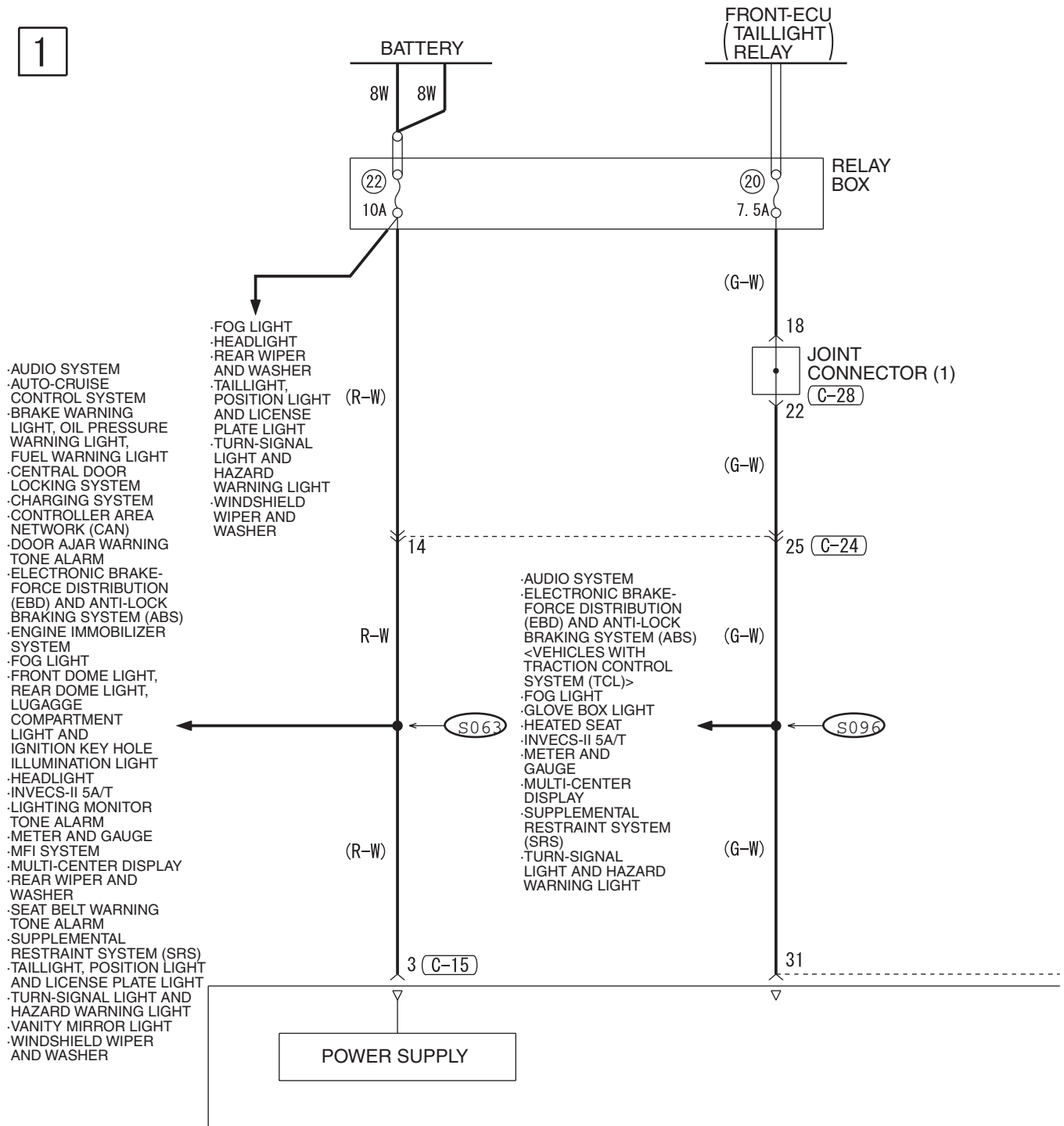

(C-01)

1	2	3	4	5	6	7	8	9	10	11
12	13	14	15	16	17	18	19	20	21	22
23	24	25	26	27	28	29	30	31	32	33

(C-15)

(MU801585)

1	2	3	4	5	6	7	8	9	10
11	12	13	14	15	16	17	18	19	20

(C-20)

(MU801584)

21	22	23	24	25	26	27	28
29	30	31	32	33	34	35	36

(C-24)

1	2	3	4	5	6	7	8	9	10	11	12	13
14	15	16	17	18	19	20	21	22	23	24	25	38
26	27	28	29			30	31					
32	33	34		35		36	37					

(C-28)

1	2	3	4	5	6	7	8	9	10	11
12	13	14	15	16	17	18	19	20	21	22
23	24	25	26	27	28	29	30	31	32	33

2

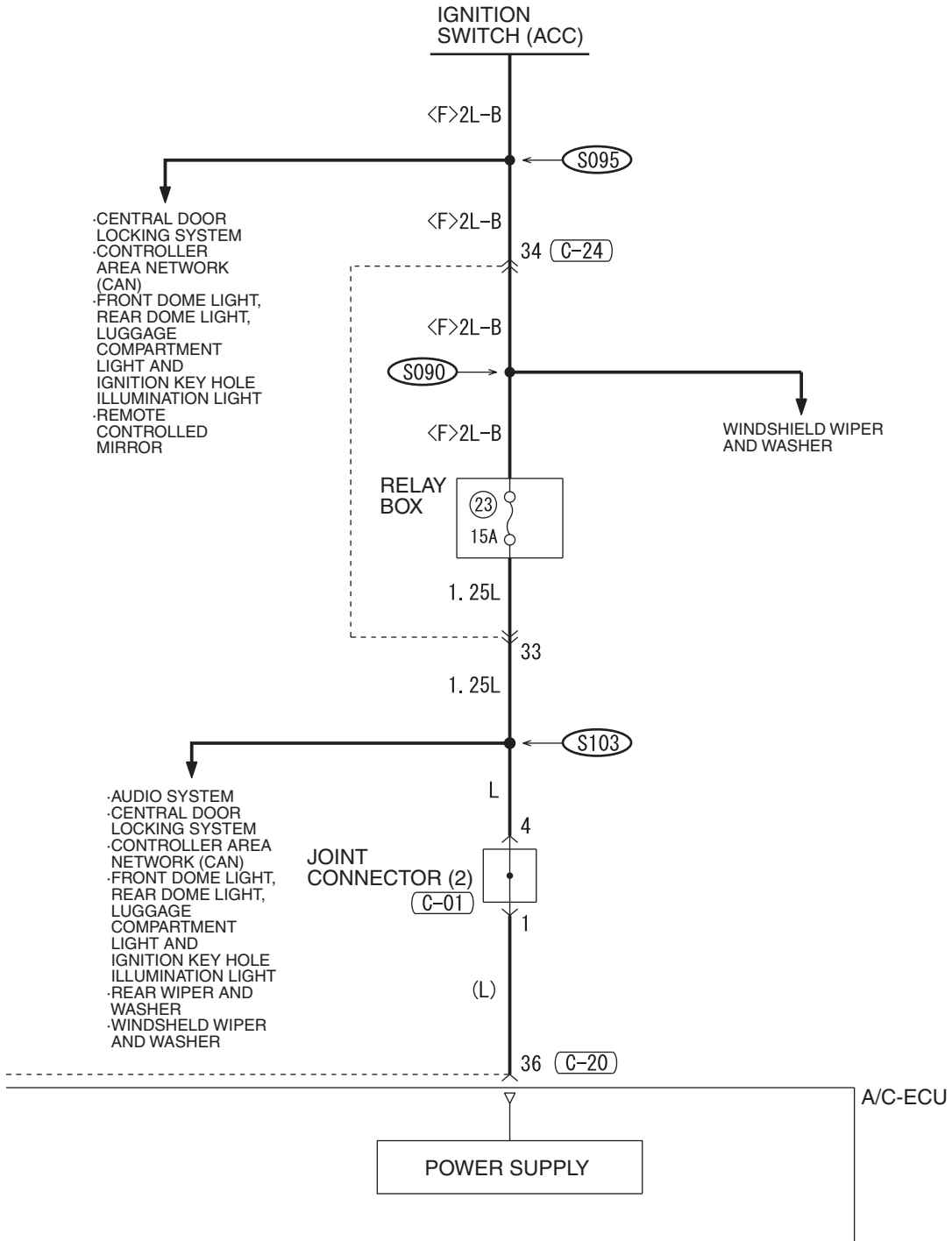

WIRE COLOR CODE
 B: BLACK LG: LIGHT GREEN G: GREEN L: BLUE W: WHITE Y: YELLOW SB: SKY BLUE
 BR: BROWN O: ORANGE GR: GRAY R: RED P: PINK V: VIOLET PU: PURPLE

TSB Revision

AUTOMATIC AIR CONDITIONING SYSTEM <3.8L ENGINE> (CONTINUED)

3

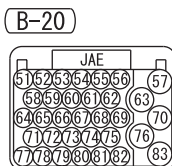
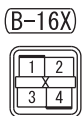
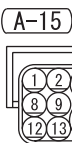
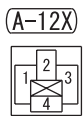
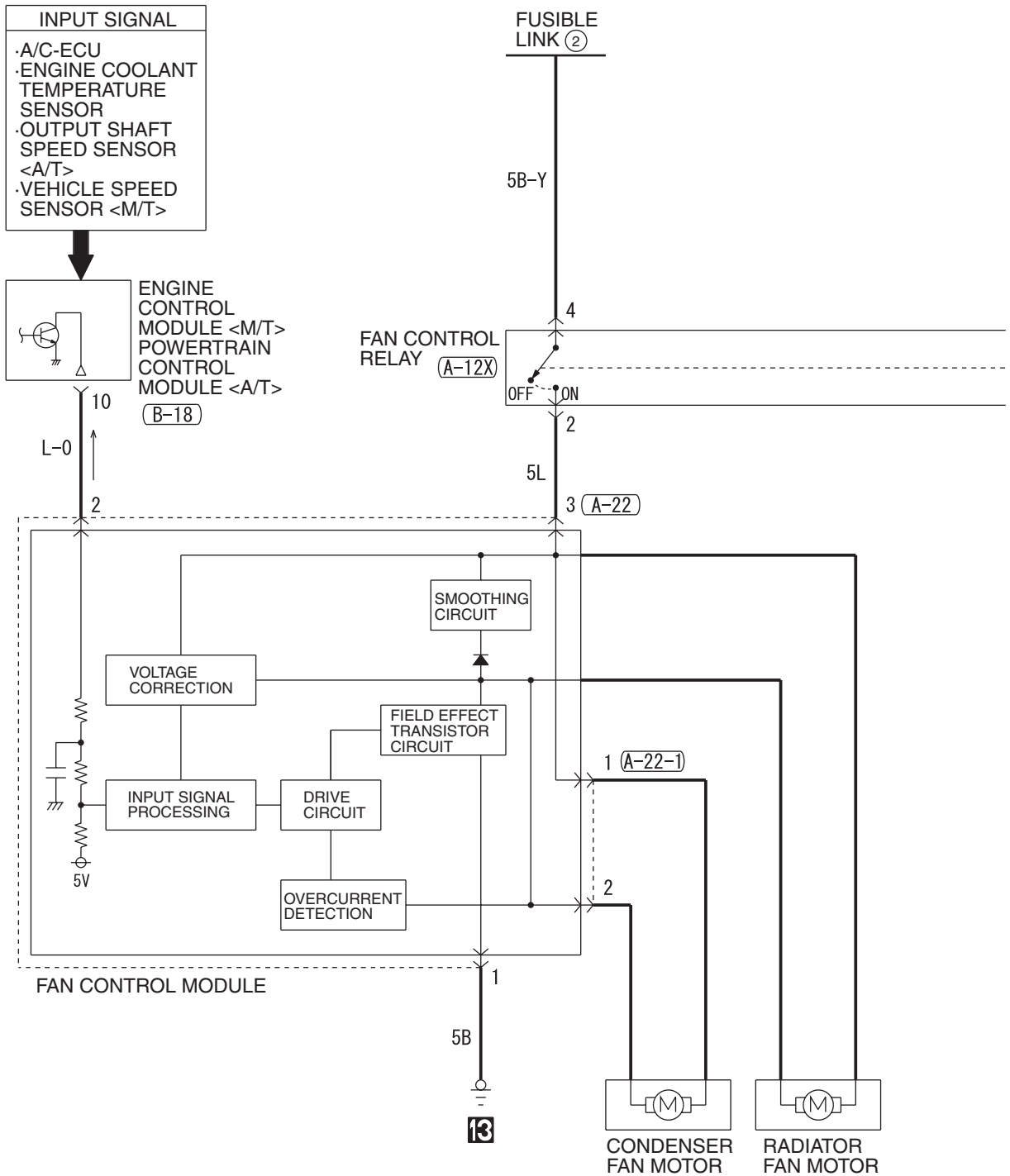

4

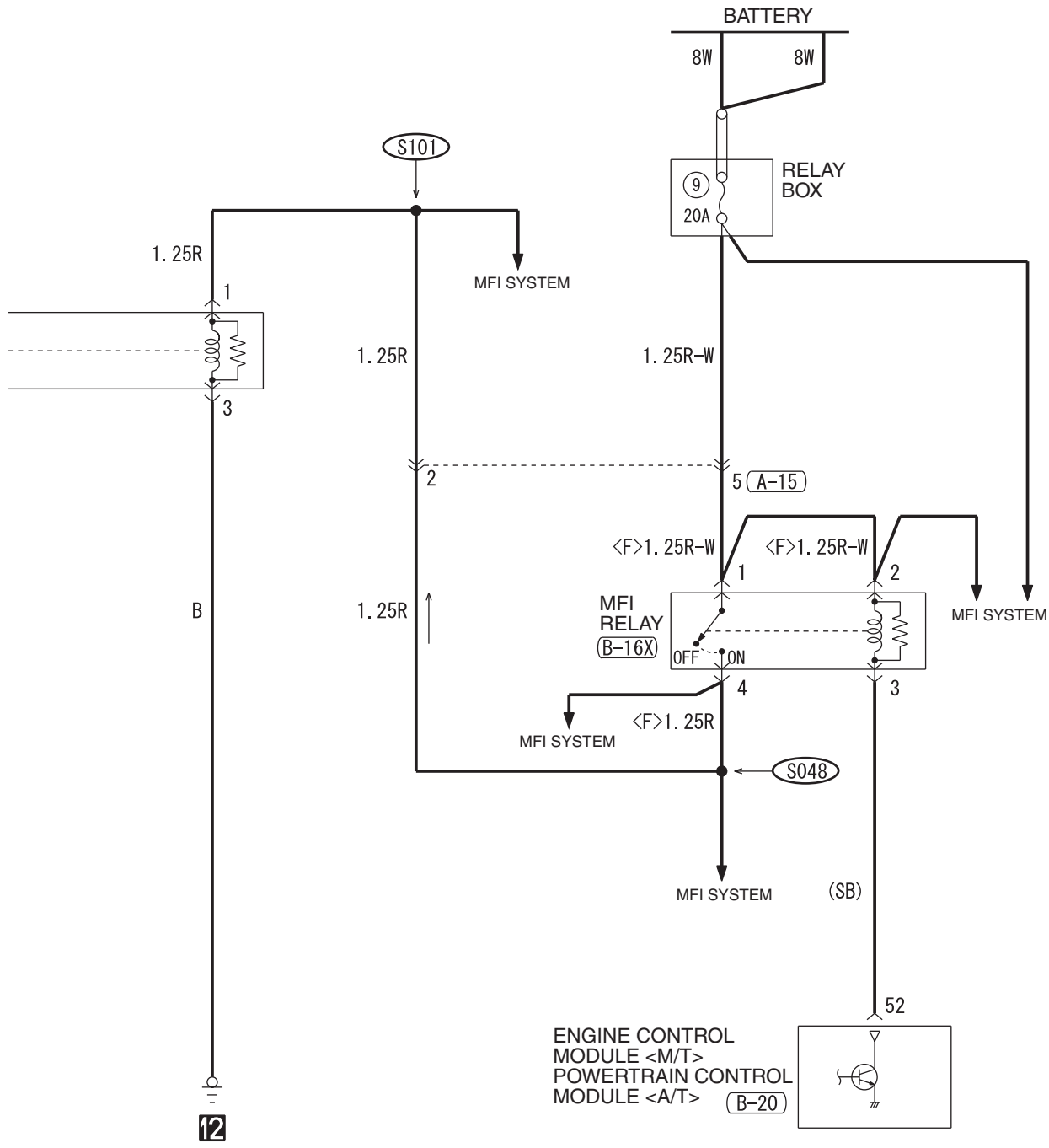

WIRE COLOR CODE
 B: BLACK LG: LIGHT GREEN G: GREEN L: BLUE W: WHITE Y: YELLOW SB: SKY BLUE
 BR: BROWN O: ORANGE GR: GRAY R: RED P: PINK V: VIOLET PU: PURPLE

H6P12M02BB

TSB Revision

AUTOMATIC AIR CONDITIONING SYSTEM <3.8L ENGINE> (CONTINUED)

5

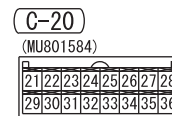
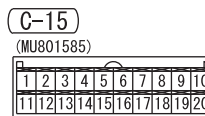
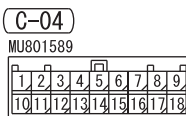
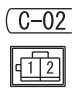
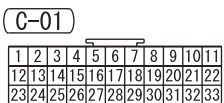
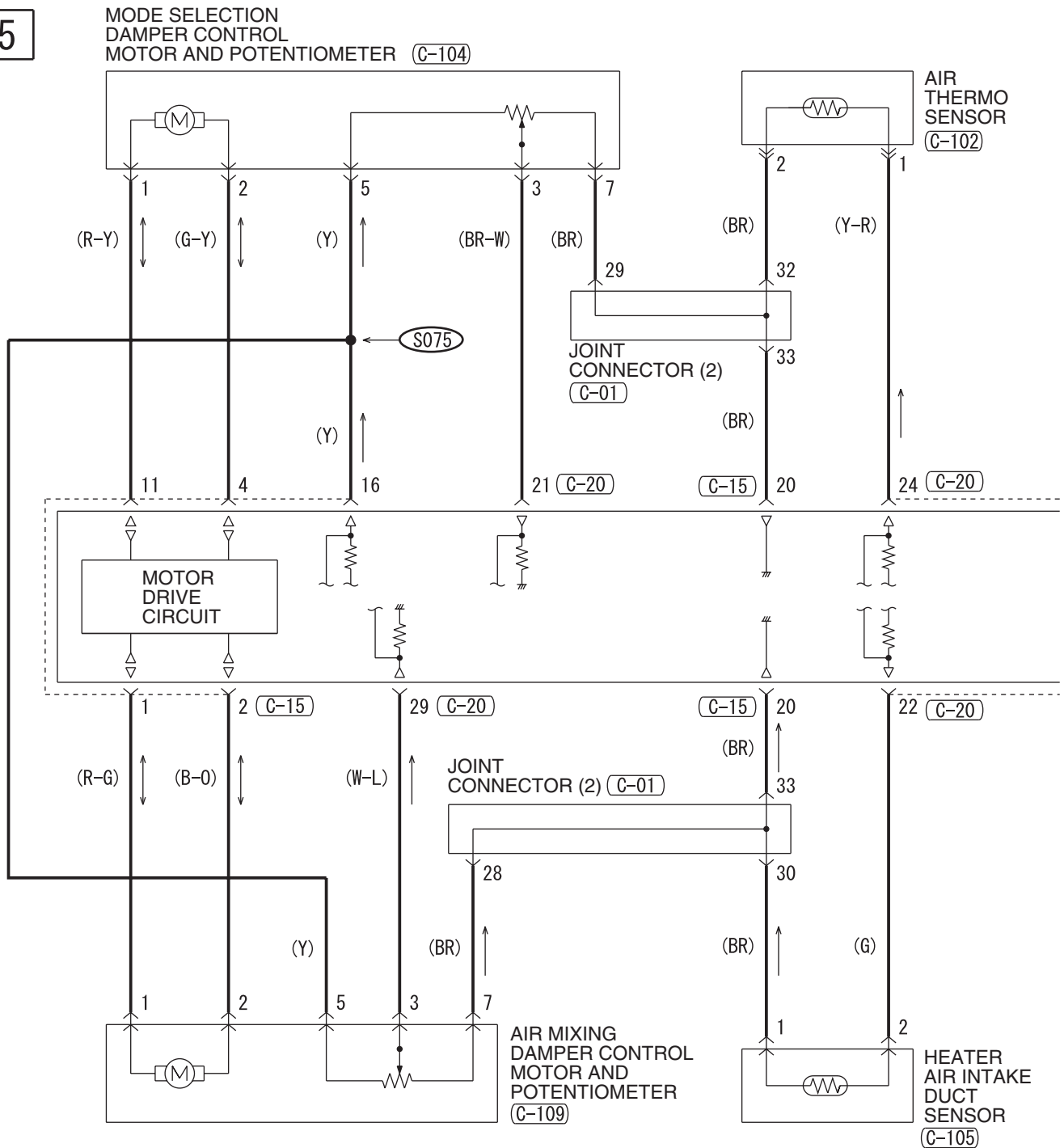

6

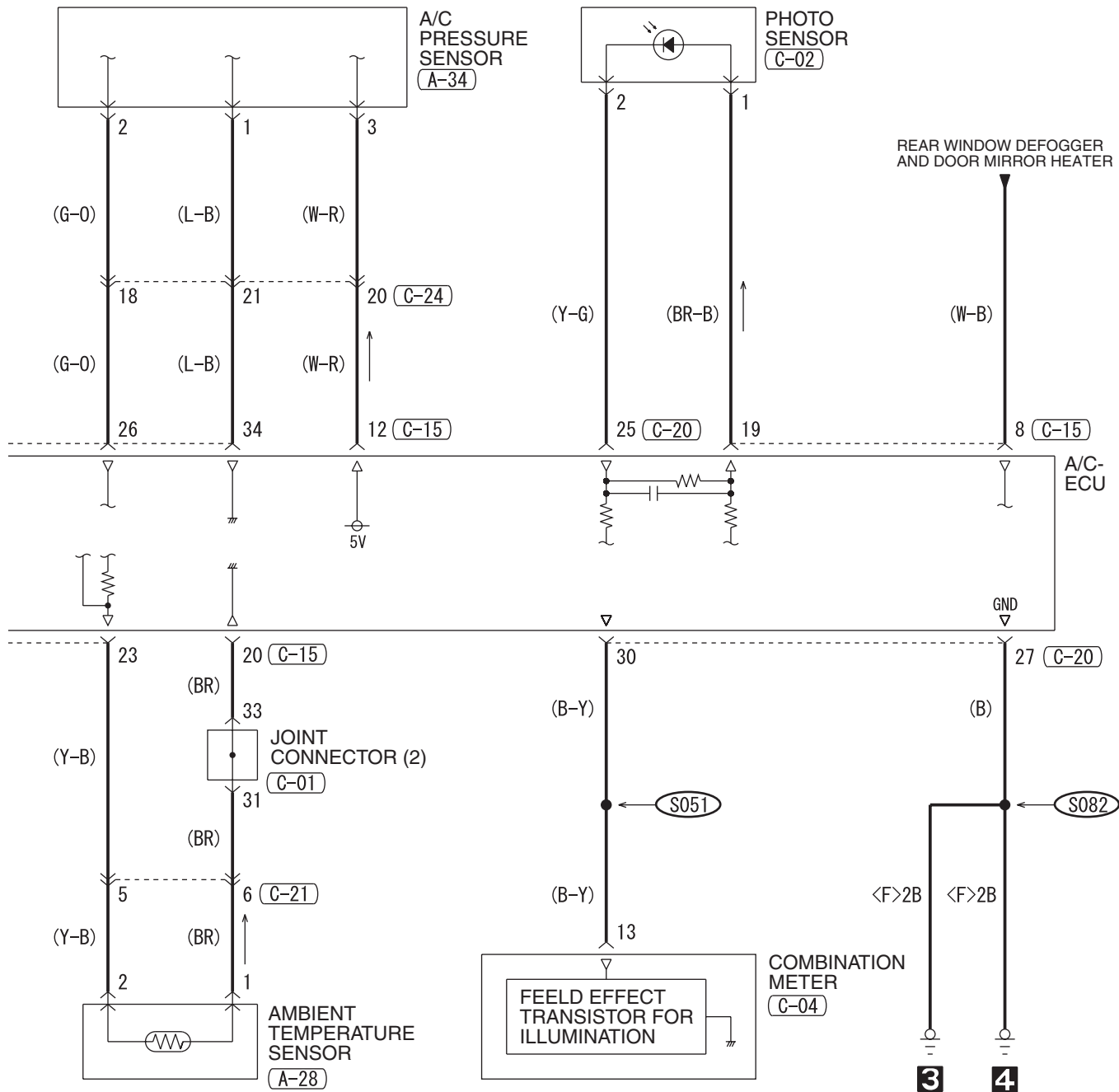

(C-21)

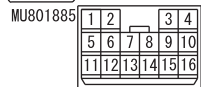

(C-24)

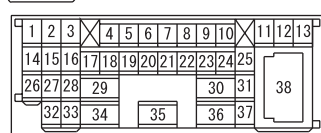

(C-102)



(C-104)

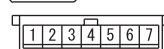

(C-105)



(C-109)

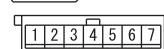

WIRE COLOR CODE

B: BLACK LG: LIGHT GREEN G: GREEN L: BLUE
BR: BROWN O: ORANGE GR: GRAY R: RED W: WHITE
SB: SKY BLUE P: PINK Y: YELLOW V: VIOLET
PU: PURPLE

H6P12M02CB

AUTOMATIC AIR CONDITIONING SYSTEM <3.8L ENGINE> (CONTINUED)

7

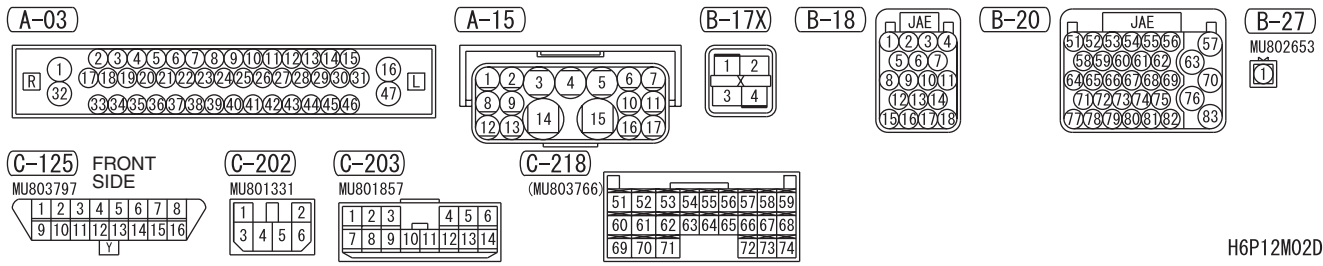
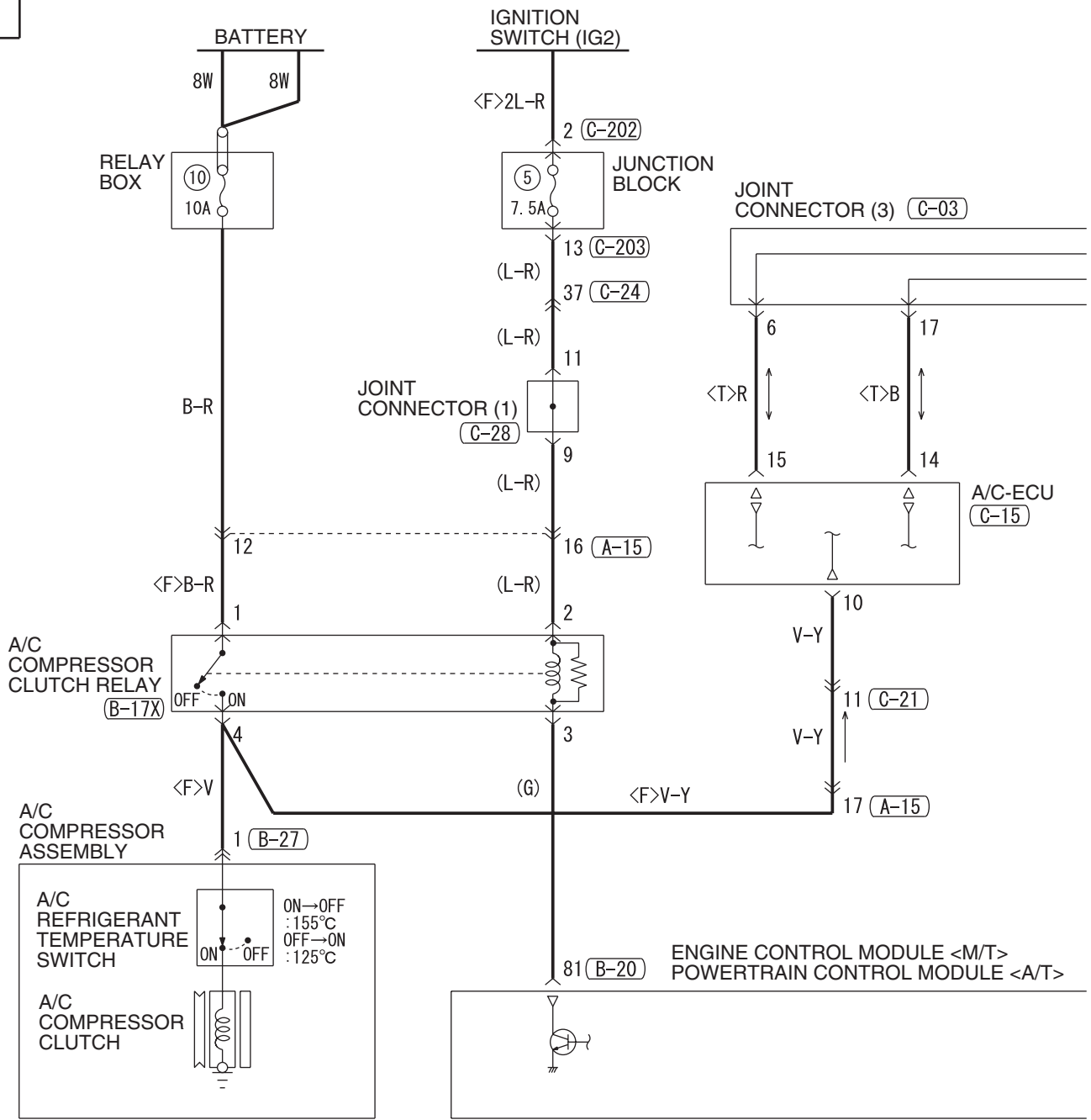

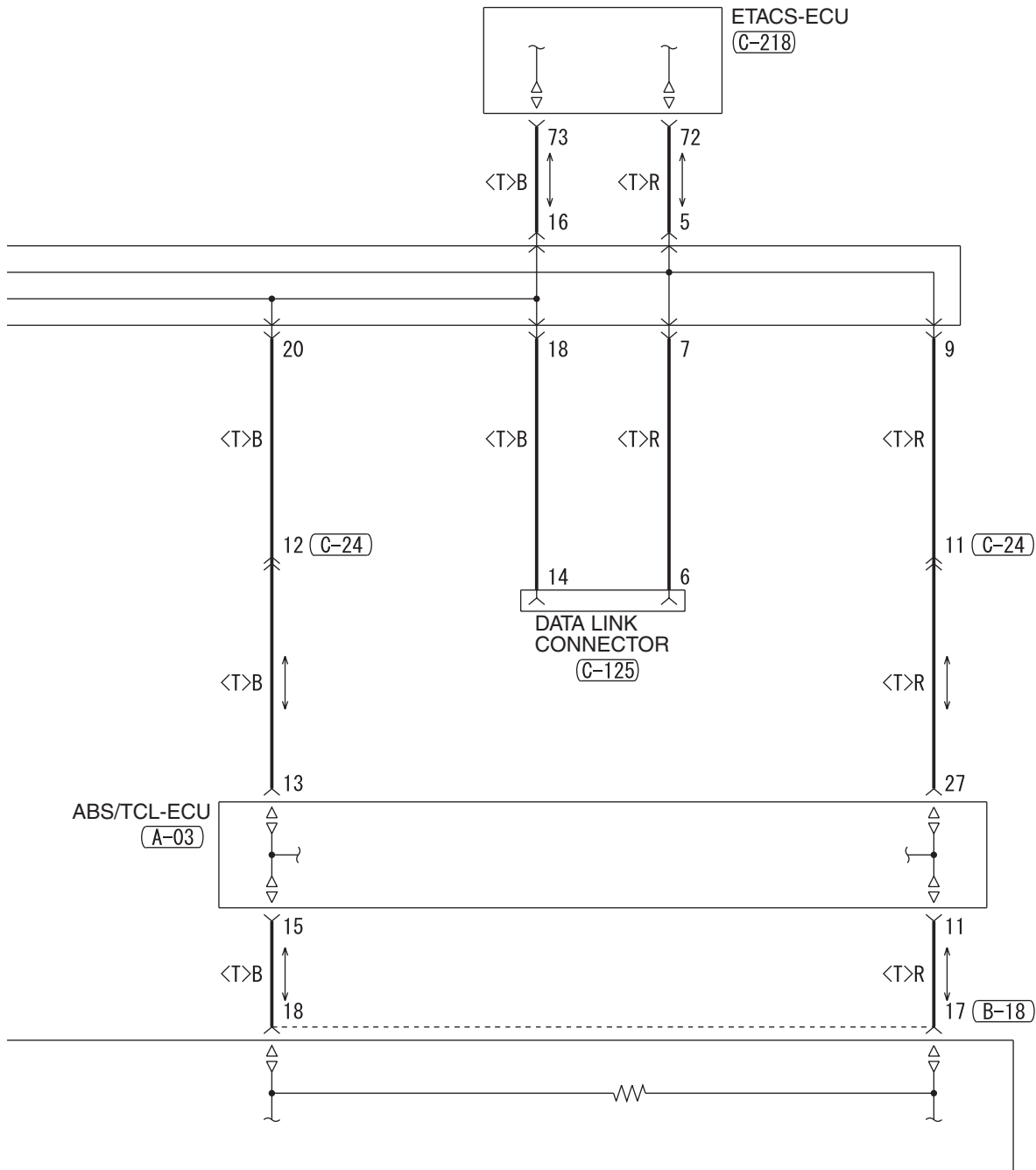

(C-03)

MU801515

1	2	3	4	5	6	7	8	9	10	11
12	13	14	15	16	17	18	19	20	21	22

(C-15)

(MU801585)

1	2	3	4	5	6	7	8	9	10
11	12	13	14	15	16	17	18	19	20

(C-21)

MU801885

1	2	3	4
5	6	7	8
9	10	11	12
13	14	15	16

(C-24)

1	2	3	4	5	6	7	8	9	10	11	12	13
14	15	16	17	18	19	20	21	22	23	24	25	
26	27	28	29			30	31		38			
32	33	34		35		36	37					

(C-28)

1	2	3	4	5	6	7	8	9	10	11
12	13	14	15	16	17	18	19	20	21	22
23	24	25	26	27	28	29	30	31	32	33

WIRE COLOR CODE

B : BLACK LG : LIGHT GREEN G : GREEN L : BLUE W : WHITE Y : YELLOW SB : SKY BLUE
 BR : BROWN O : ORANGE GR : GRAY R : RED P : PINK V : VIOLET PU : PURPLE

AUTOMATIC AIR CONDITIONING SYSTEM <3.8L ENGINE> (CONTINUED)

9

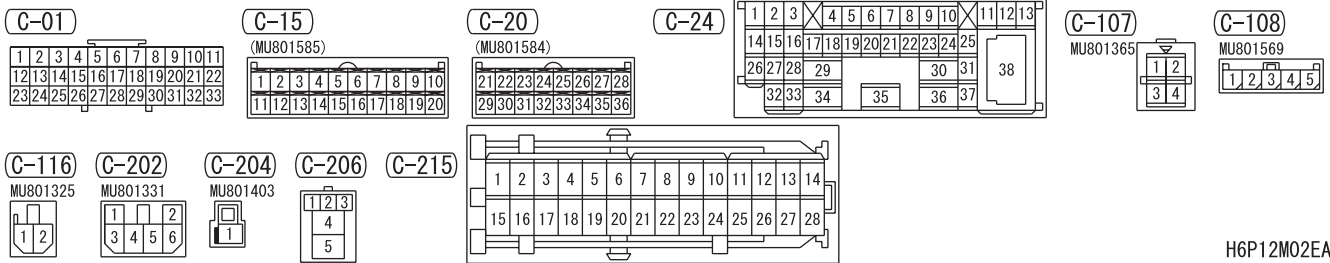
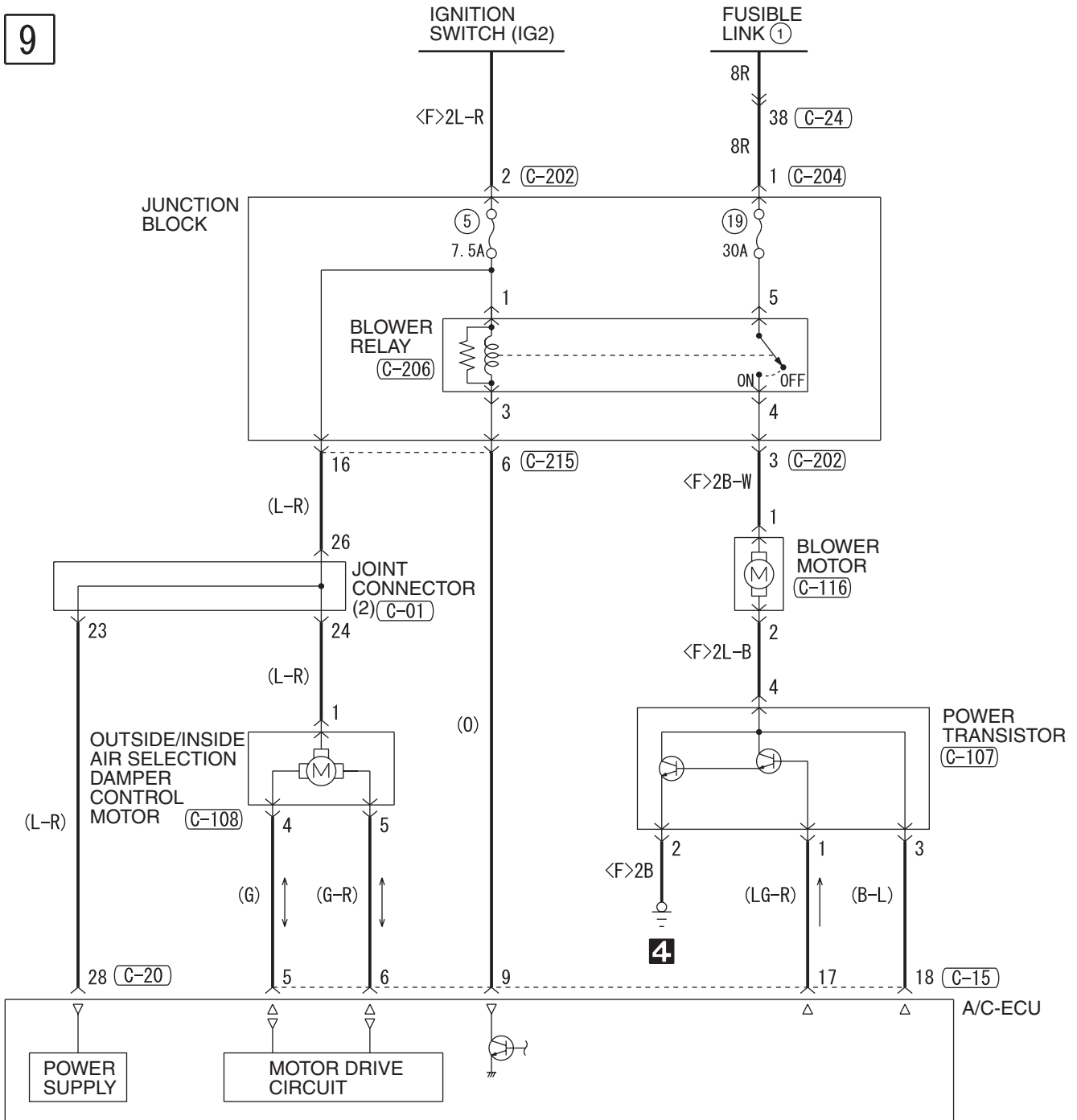

H6P12M02EA

NOTES

WINDSHIELD WIPER AND WASHER <M/T>

M1901006101727

1

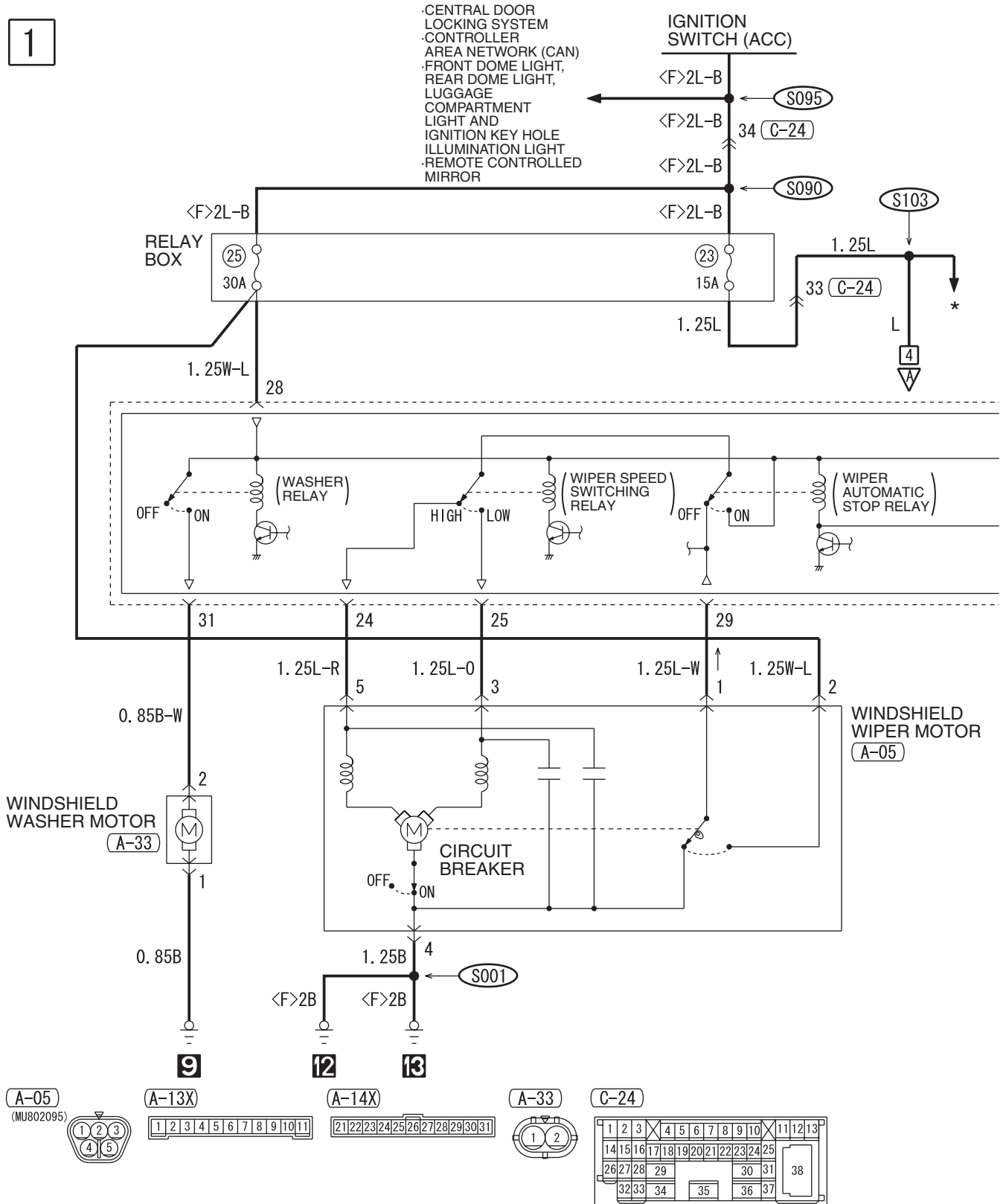

H6P13M00AA

2

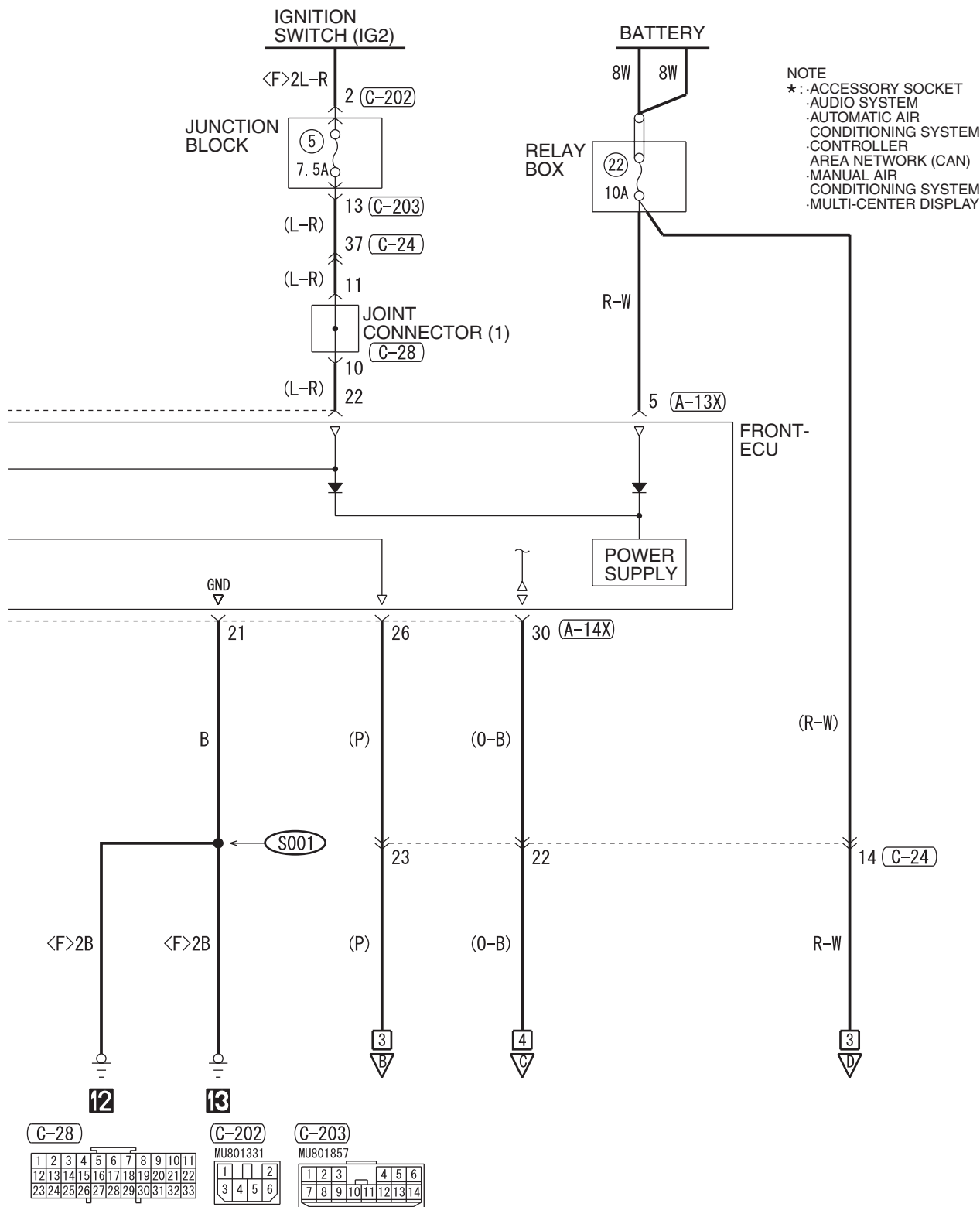

WIRE COLOR CODE
 B : BLACK LG : LIGHT GREEN G : GREEN L : BLUE W : WHITE Y : YELLOW SB : SKY BLUE
 BR : BROWN O : ORANGE GR : GRAY R : RED P : PINK V : VIOLET PU : PURPLE

WINDSHIELD WIPER AND WASHER <M/T> (CONTINUED)

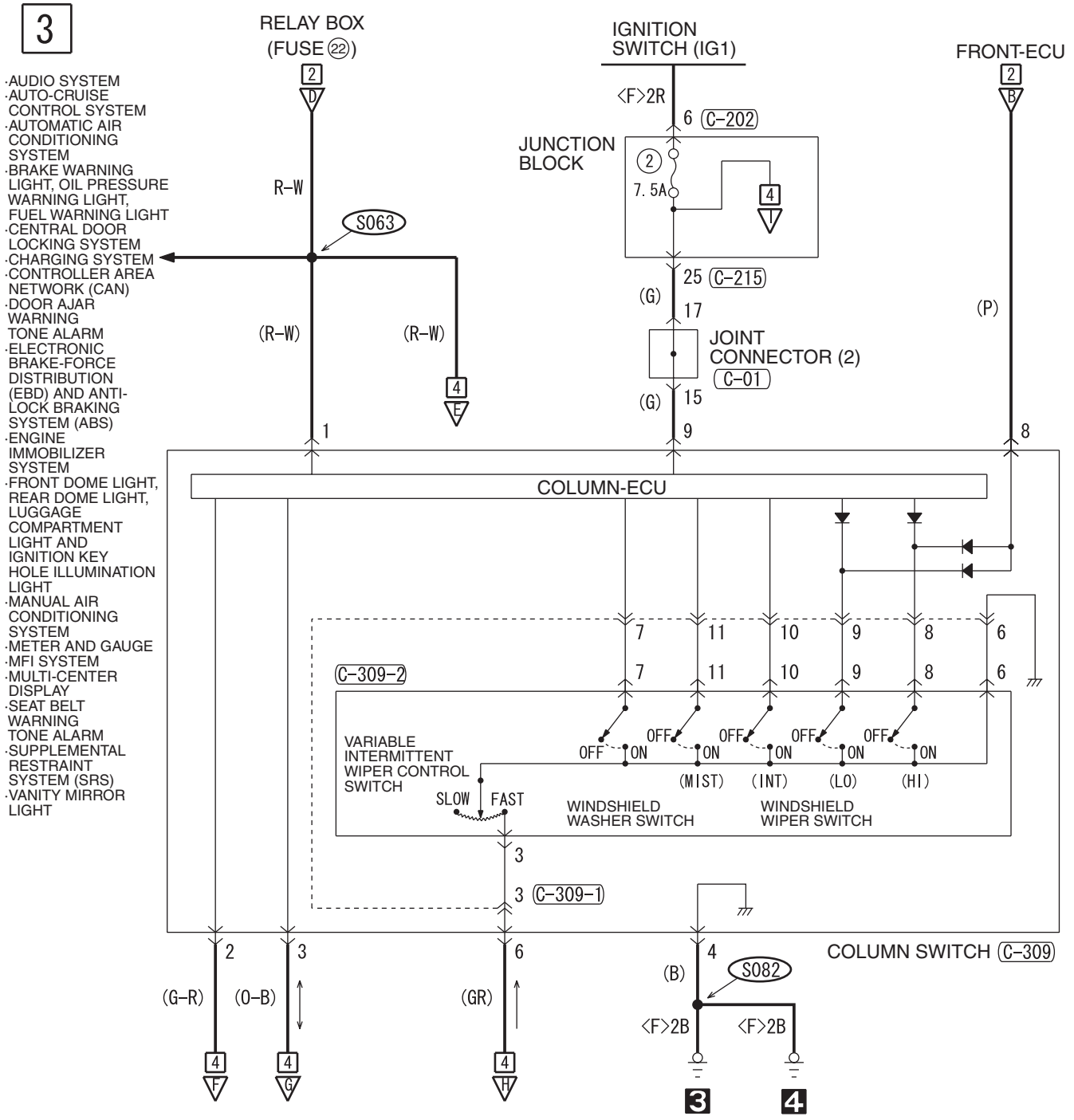

- 3**
- AUDIO SYSTEM
 - AUTO-CRUISE CONTROL SYSTEM
 - AUTOMATIC AIR CONDITIONING SYSTEM
 - BRAKE WARNING LIGHT, OIL PRESSURE WARNING LIGHT, FUEL WARNING LIGHT
 - CENTRAL DOOR LOCKING SYSTEM
 - CHARGING SYSTEM
 - CONTROLLER AREA NETWORK (CAN)
 - DOOR AJAR WARNING TONE ALARM
 - ELECTRONIC BRAKE-FORCE DISTRIBUTION (EBD) AND ANTI-LOCK BRAKING SYSTEM (ABS)
 - ENGINE IMMOBILIZER SYSTEM
 - FRONT DOME LIGHT, REAR DOME LIGHT, LUGGAGE COMPARTMENT LIGHT AND IGNITION KEY HOLE ILLUMINATION LIGHT
 - MANUAL AIR CONDITIONING SYSTEM
 - METER AND GAUGE
 - MFI SYSTEM
 - MULTI-CENTER DISPLAY
 - SEAT BELT WARNING TONE ALARM
 - SUPPLEMENTAL RESTRAINT SYSTEM (SRS)
 - VANITY MIRROR LIGHT

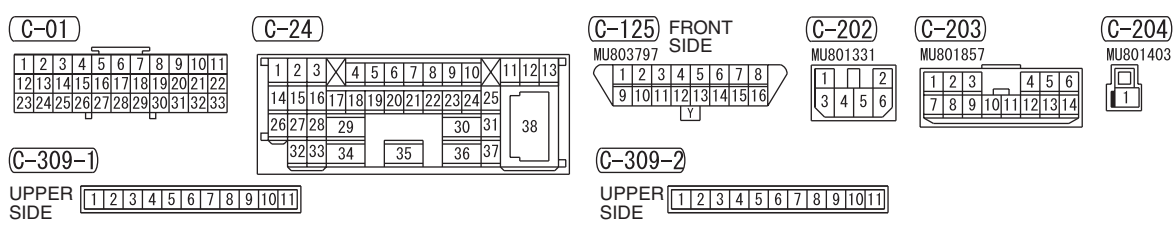

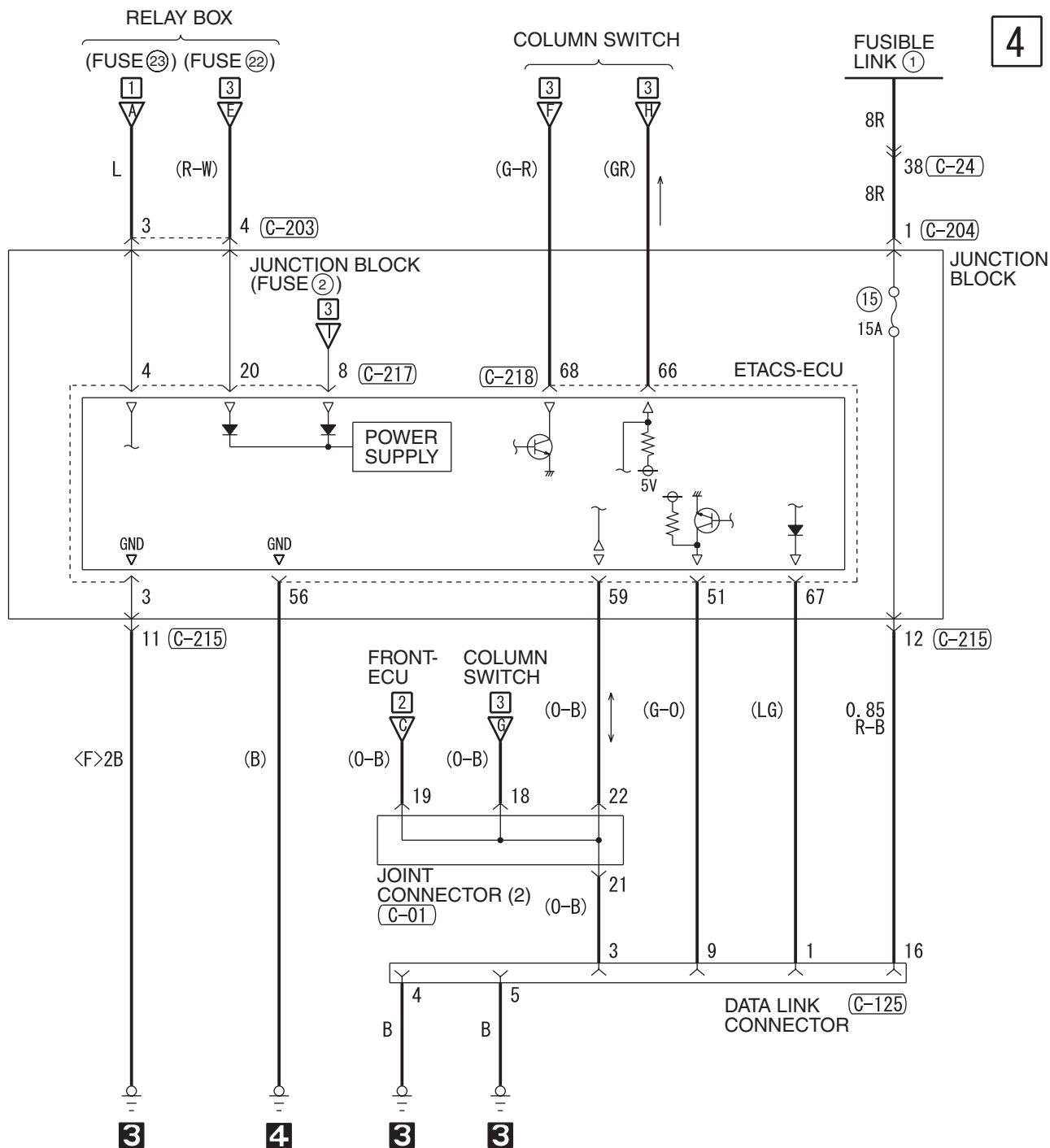

4

(C-215)

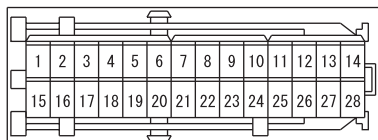

(C-217) JUNCTION BLOCK SIDE

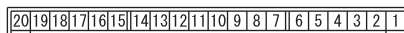

(C-218)



(C-309)

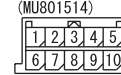

WIRE COLOR CODE
 B : BLACK LG : LIGHT GREEN G : GREEN L : BLUE
 BR : BROWN O : ORANGE GR : GRAY R : RED W : WHITE
 SB : SKY BLUE P : PINK Y : YELLOW V : VIOLET PU : PURPLE

H6P13M00BB

WINDSHIELD WIPER AND WASHER <M/T> (CONTINUED)

5

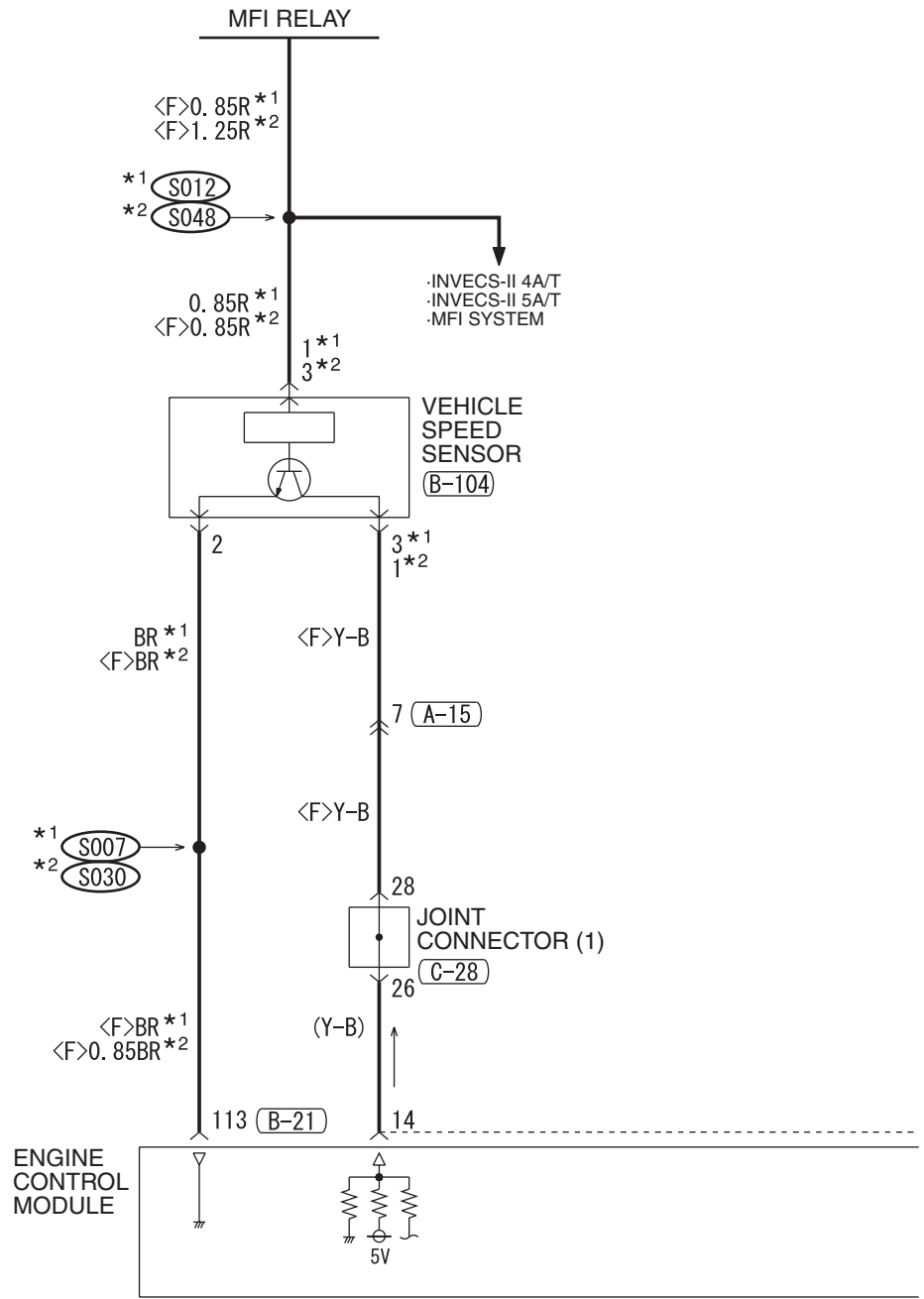

NOTE

- *1 : 2.4L ENGINE
- *2 : 3.8L ENGINE
- *3 : WITHOUT TRACTION CONTROL SYSTEM (TCL)
- *4 : WITH TRACTION CONTROL SYSTEM (TCL)

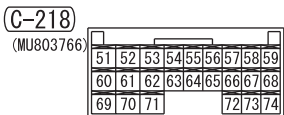
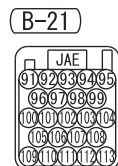
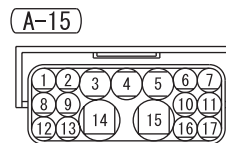
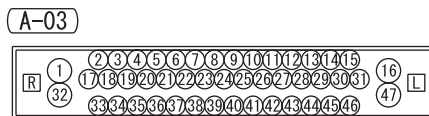
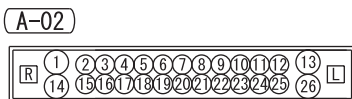

6

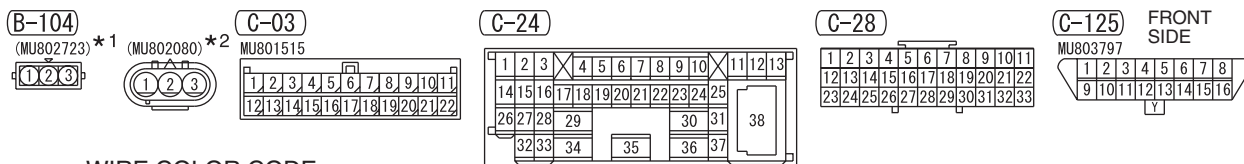
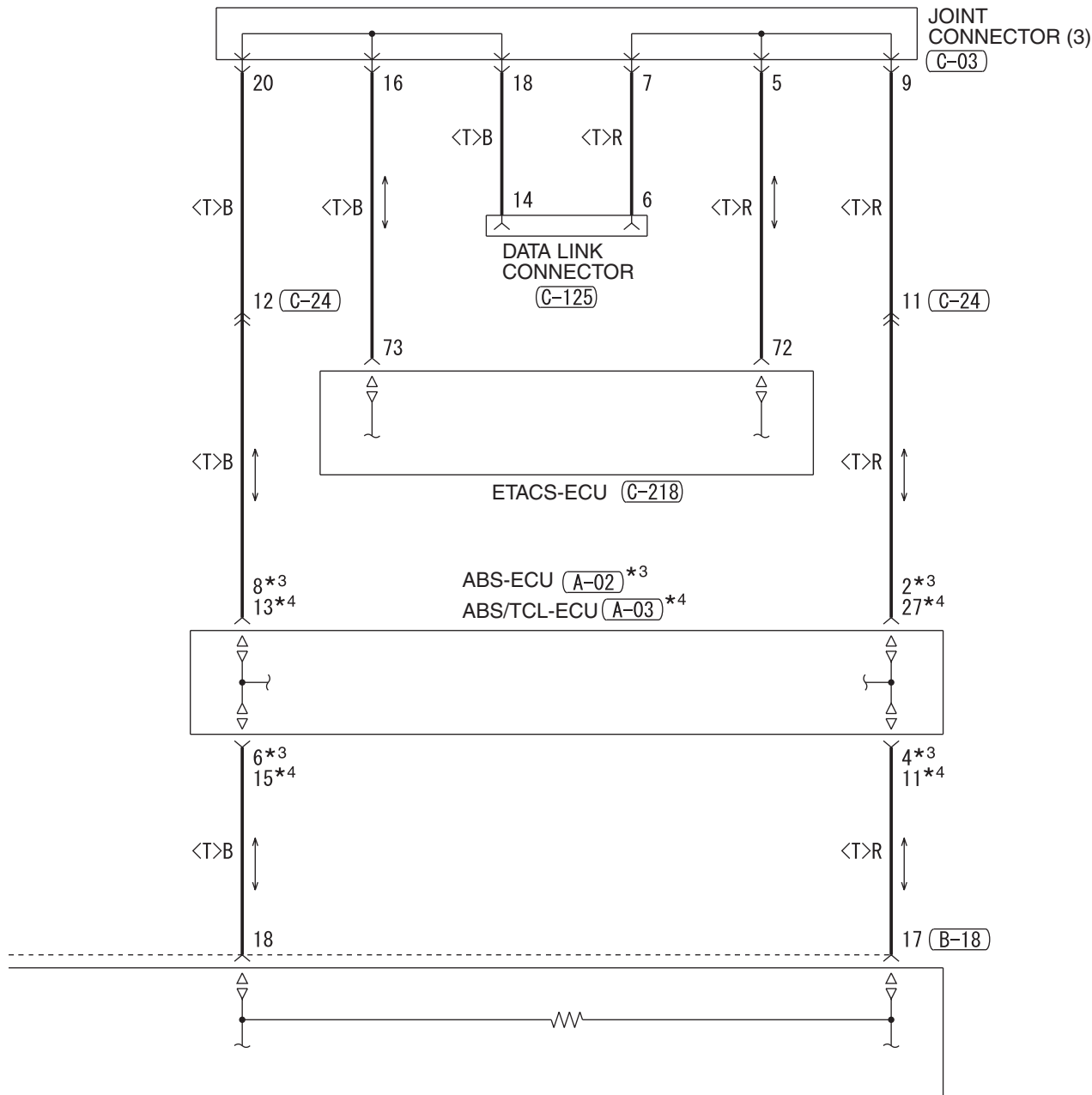

WIRE COLOR CODE
 B : BLACK LG : LIGHT GREEN G : GREEN L : BLUE W : WHITE Y : YELLOW SB : SKY BLUE
 BR : BROWN O : ORANGE GR : GRAY R : RED P : PINK V : VIOLET PU : PURPLE H6P13M00CB

WINDSHIELD WIPER AND WASHER <A/T>

M1901006101738

1

- CENTRAL DOOR LOCKING SYSTEM
- CONTROLLER
- AREA NETWORK (CAN)
- FRONT DOME LIGHT, REAR DOME LIGHT, LUGGAGE COMPARTMENT LIGHT AND IGNITION KEY HOLE ILLUMINATION LIGHT
- REMOTE CONTROLLED MIRROR

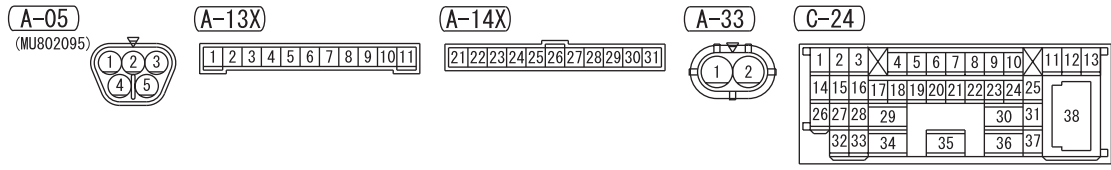
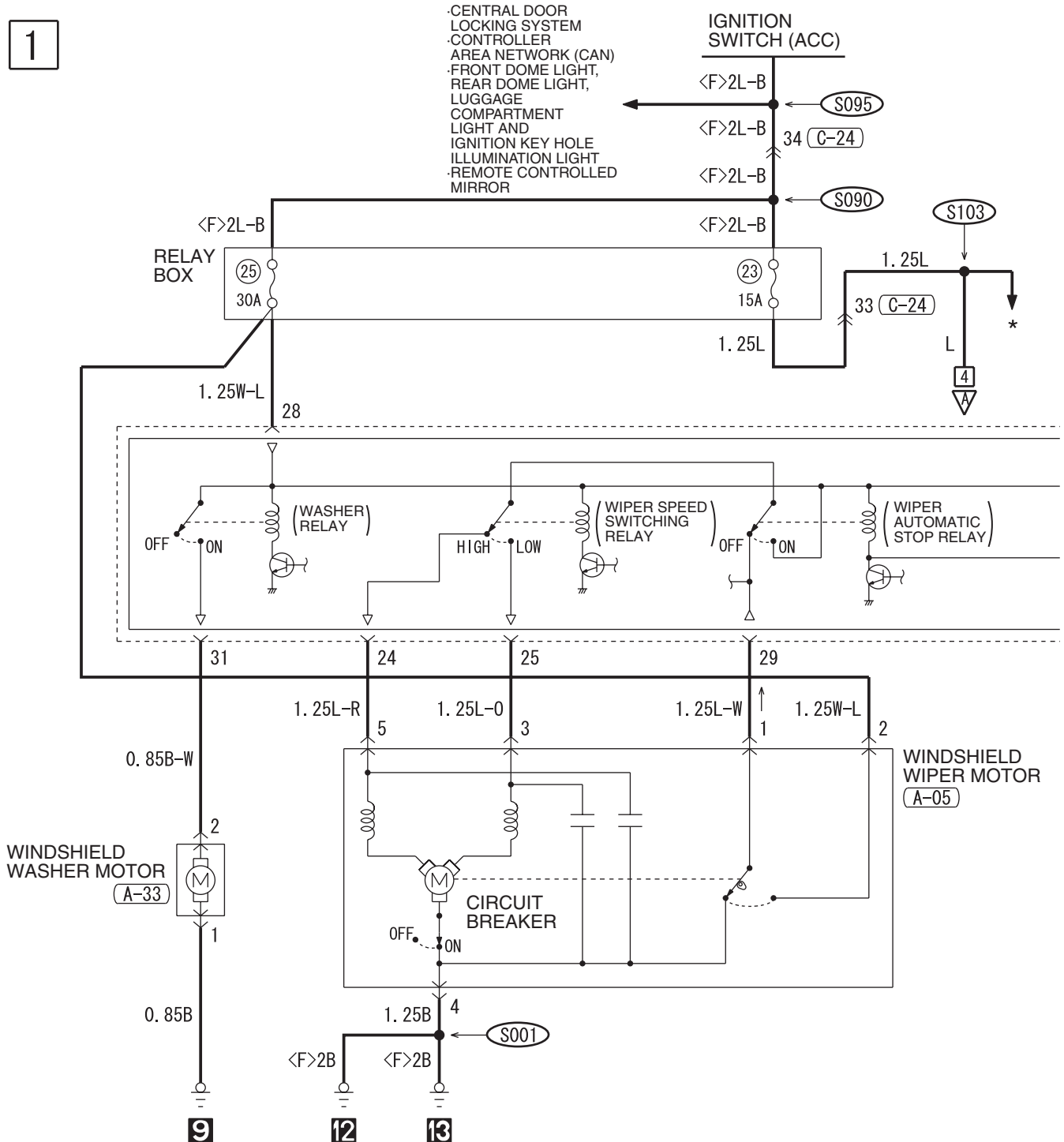

2

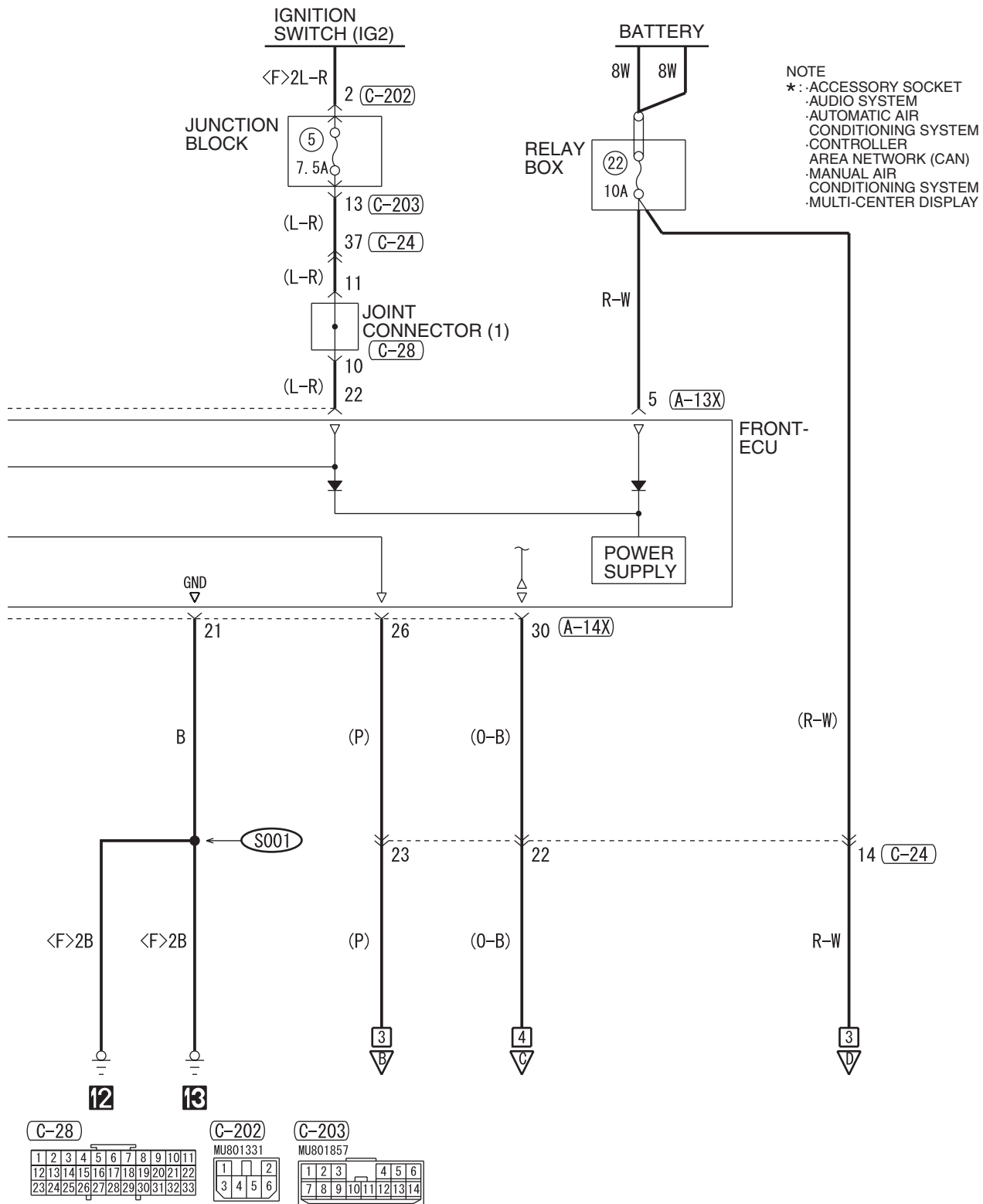

WIRE COLOR CODE
 B : BLACK LG : LIGHT GREEN G : GREEN L : BLUE W : WHITE Y : YELLOW SB : SKY BLUE
 BR : BROWN O : ORANGE GR : GRAY R : RED P : PINK V : VIOLET PU : PURPLE

WINDSHIELD WIPER AND WASHER <A/T> (CONTINUED)

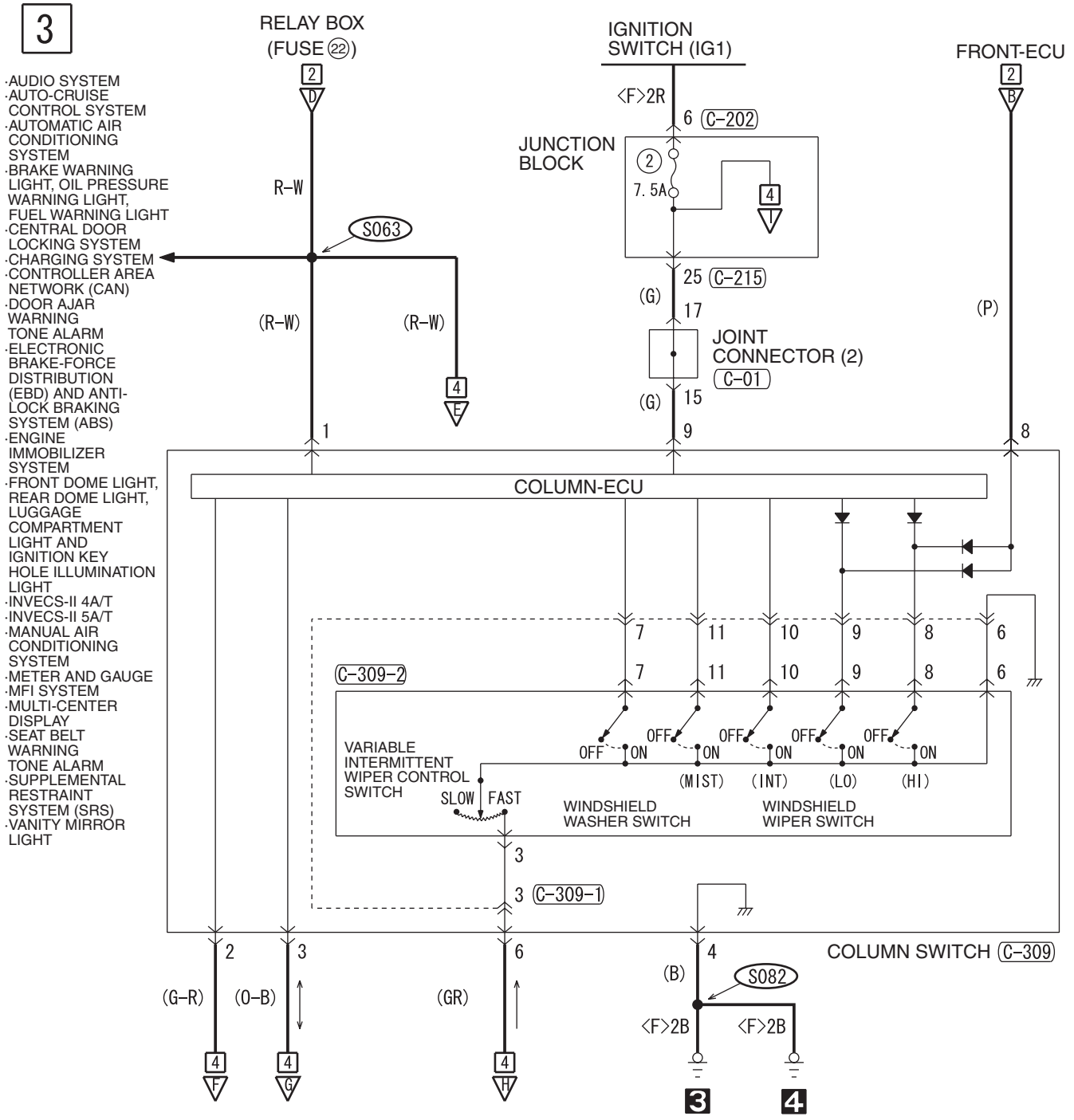

- AUDIO SYSTEM
- AUTO-CRUISE CONTROL SYSTEM
- AUTOMATIC AIR CONDITIONING SYSTEM
- BRAKE WARNING LIGHT, OIL PRESSURE WARNING LIGHT, FUEL WARNING LIGHT
- CENTRAL DOOR LOCKING SYSTEM
- CHARGING SYSTEM
- CONTROLLER AREA NETWORK (CAN)
- DOOR AJAR WARNING
- TONE ALARM
- ELECTRONIC BRAKE-FORCE DISTRIBUTION (EBD) AND ANTI-LOCK BRAKING SYSTEM (ABS)
- ENGINE IMMOBILIZER SYSTEM
- FRONT DOME LIGHT, REAR DOME LIGHT, LUGGAGE COMPARTMENT LIGHT AND IGNITION KEY HOLE ILLUMINATION LIGHT
- INVECS-II 4A/T
- INVECS-II 5A/T
- MANUAL AIR CONDITIONING SYSTEM
- METER AND GAUGE MFI SYSTEM
- MULTI-CENTER DISPLAY
- SEAT BELT WARNING
- TONE ALARM
- SUPPLEMENTAL RESTRAINT SYSTEM (SRS)
- VANITY MIRROR LIGHT

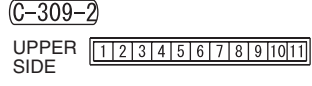
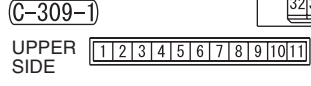
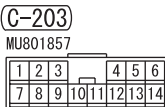
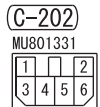
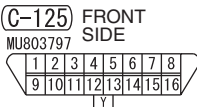
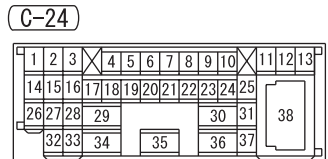
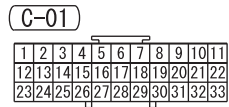

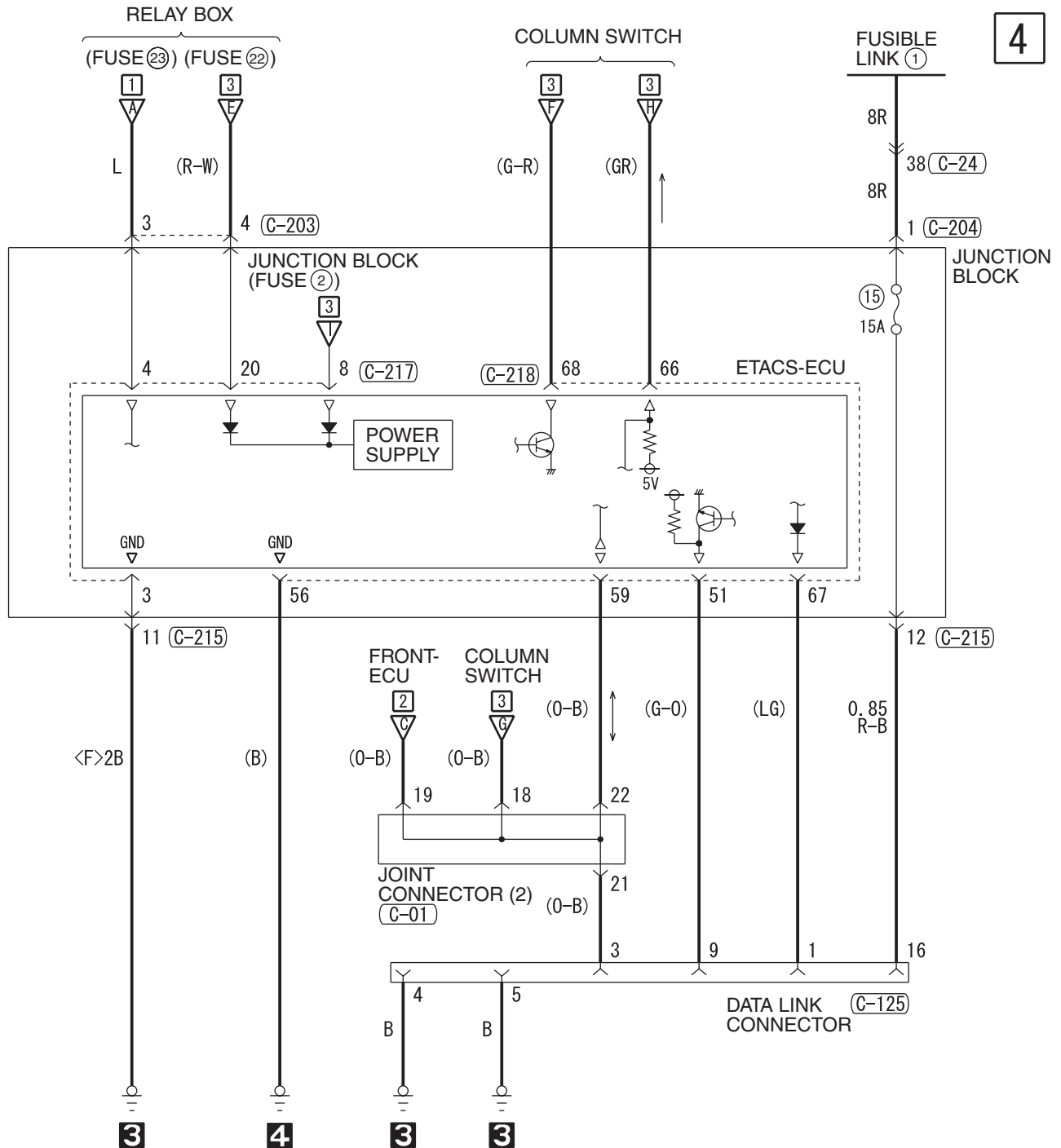

(C-215)

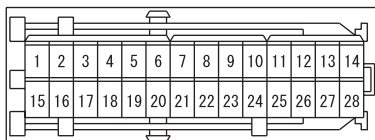

(C-217) JUNCTION BLOCK SIDE

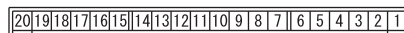

(C-218)



(C-309)

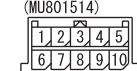

WIRE COLOR CODE
 B : BLACK LG : LIGHT GREEN G : GREEN L : BLUE
 BR : BROWN O : ORANGE GR : GRAY R : RED W : WHITE
 SB : SKY BLUE P : PINK Y : YELLOW V : VIOLET PU : PURPLE

H6P13M01BB

WINDSHIELD WIPER AND WASHER <A/T> (CONTINUED)

5

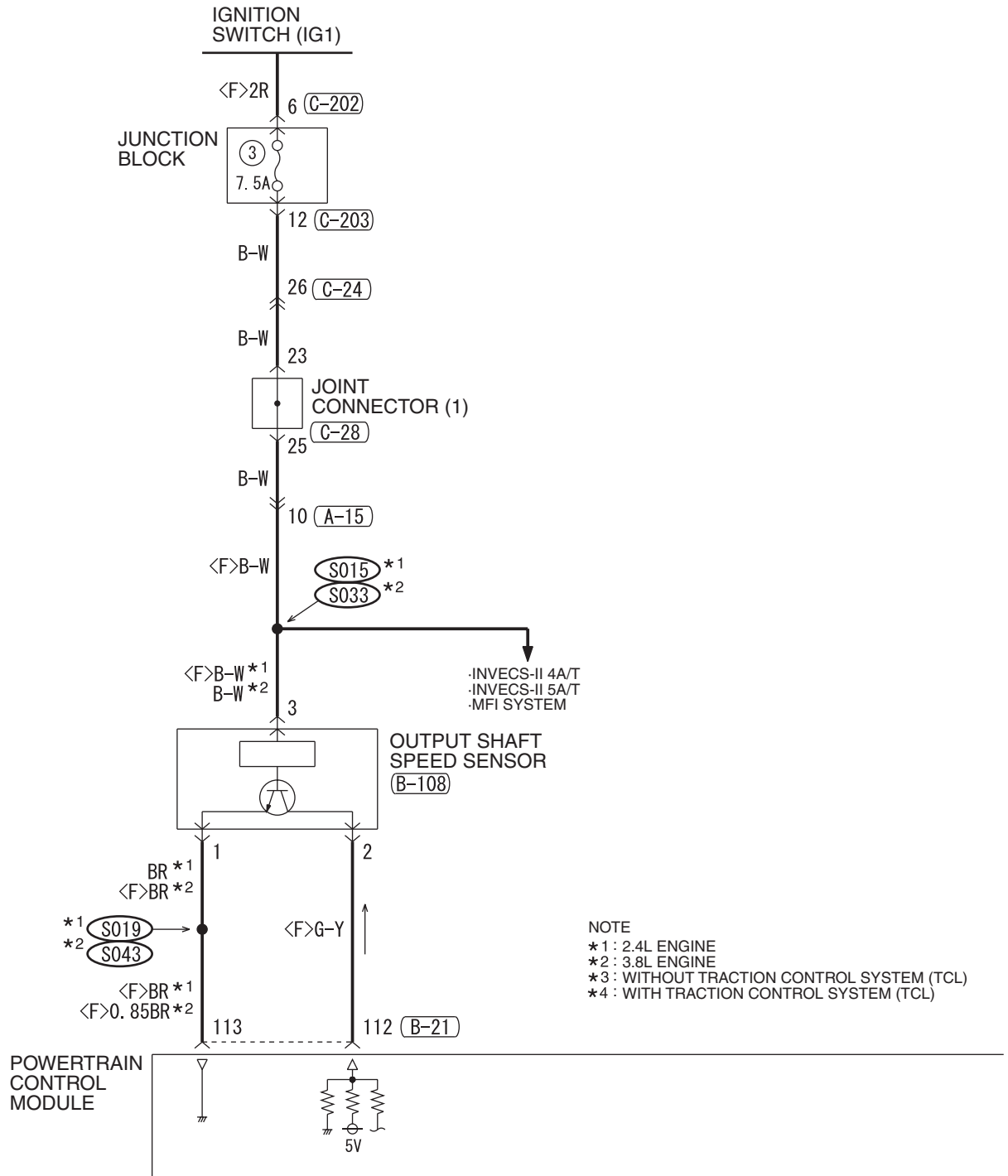

(A-02)

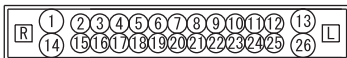

(A-03)

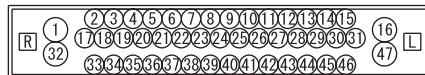

(A-15)

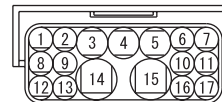

(B-18)



(B-21)

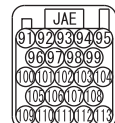

(C-218)

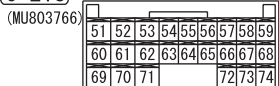

6

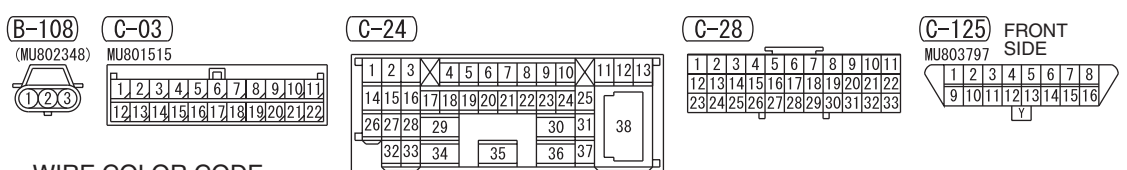
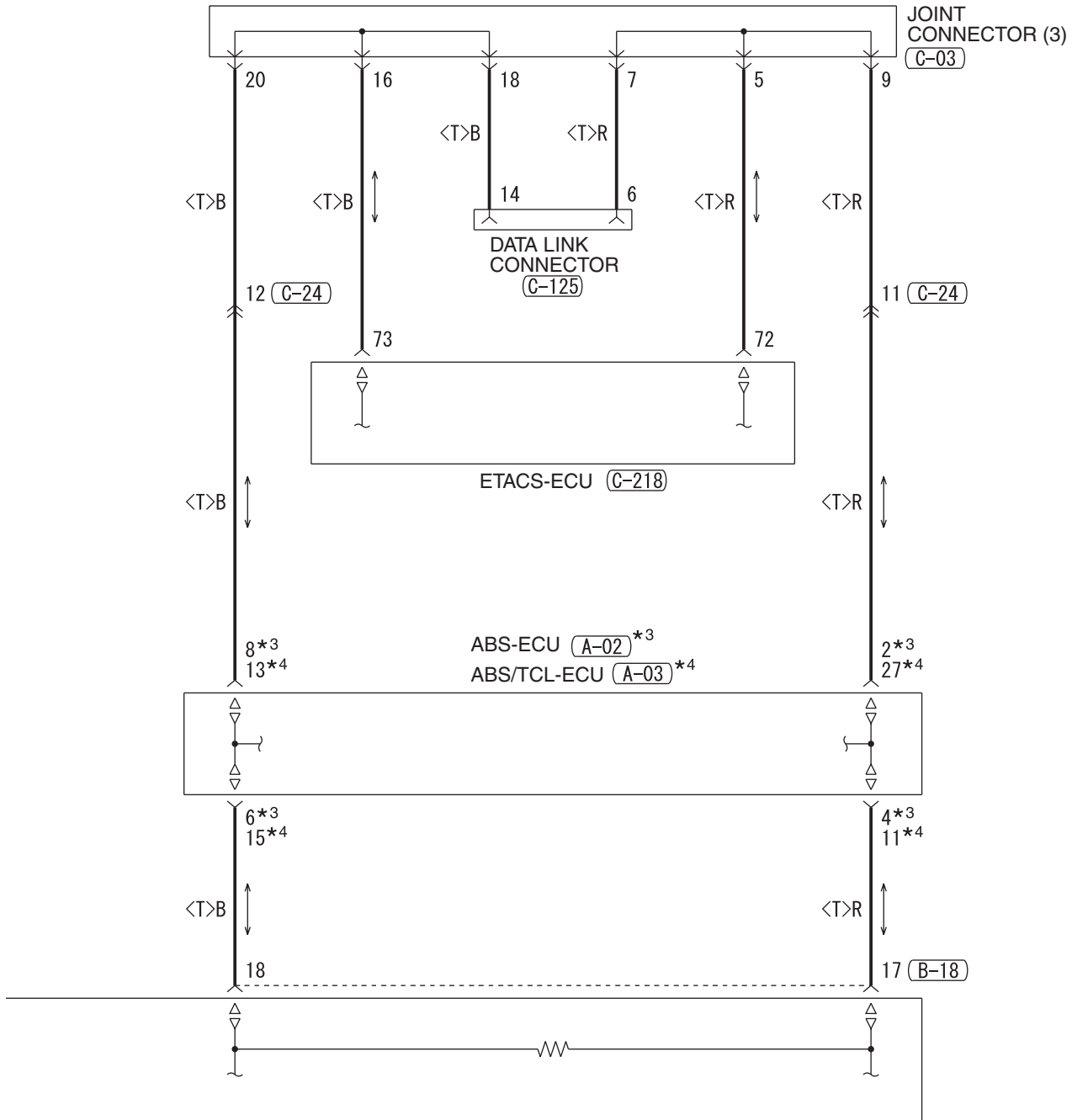

WIRE COLOR CODE
 B: BLACK LG: LIGHT GREEN G: GREEN L: BLUE W: WHITE Y: YELLOW SB: SKY BLUE
 BR: BROWN O: ORANGE GR: GRAY R: RED P: PINK V: VIOLET PU: PURPLE

H6P13M01CB

TSB Revision

REAR WIPER AND WASHER <M/T>

M1901006201423

1

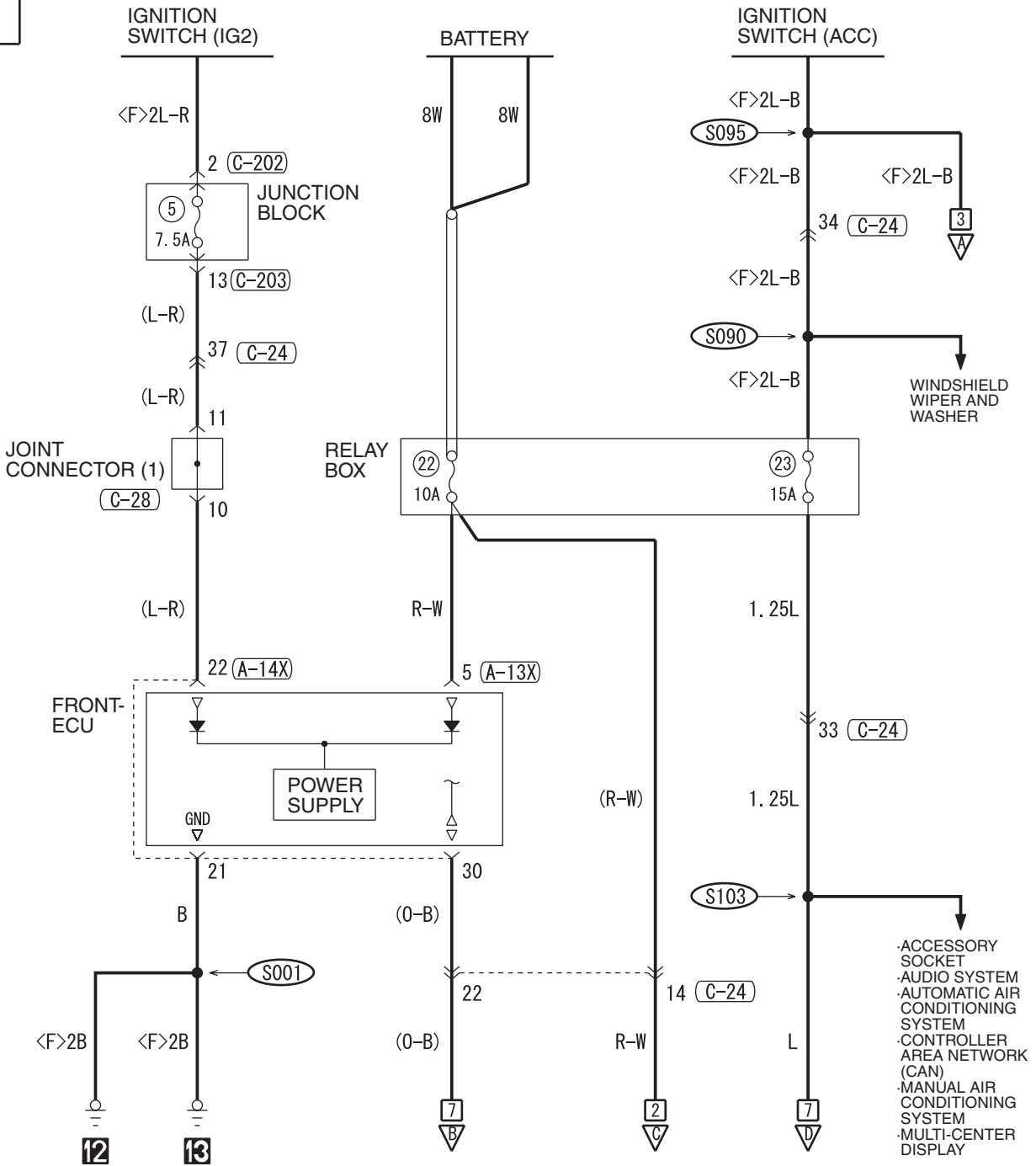

(A-13X)

1	2	3	4	5	6	7	8	9	10	11
---	---	---	---	---	---	---	---	---	----	----

(A-14X)

21	22	23	24	25	26	27	28	29	30	31
----	----	----	----	----	----	----	----	----	----	----

(C-01)

1	2	3	4	5	6	7	8	9	10	11
12	13	14	15	16	17	18	19	20	21	22
23	24	25	26	27	28	29	30	31	32	33

(C-24)

1	2	3	4	5	6	7	8	9	10	11	12	13
14	15	16	17	18	19	20	21	22	23	24	25	
26	27	28	29			30	31			38		
32	33	34		35		36	37					

(C-28)

1	2	3	4	5	6	7	8	9	10	11
12	13	14	15	16	17	18	19	20	21	22
23	24	25	26	27	28	29	30	31	32	33

(C-309-2)

1	2	3	4	5	6	7	8	9	10	11
---	---	---	---	---	---	---	---	---	----	----

UPPER SIDE

H6P13M02AA

2

- AUDIO SYSTEM
- AUTO-CRUISE CONTROL SYSTEM
- AUTOMATIC AIR CONDITIONING SYSTEM
- BRAKE WARNING LIGHT, OIL PRESSURE WARNING LIGHT, FUEL WARNING LIGHT
- CENTRAL DOOR LOCKING SYSTEM
- CHARGING SYSTEM
- CONTROLLER AREA NETWORK (CAN)
- DOOR AJAR WARNING TONE ALARM
- ELECTRONIC BRAKE-FORCE DISTRIBUTION (EBD) AND ANTI-LOCK BRAKING SYSTEM (ABS)
- ENGINE IMMOBILIZER SYSTEM
- FRONT DOME LIGHT, REAR DOME LIGHT, LUGGAGE COMPARTMENT LIGHT AND IGNITION KEY HOLE ILLUMINATION LIGHT
- MANUAL AIR CONDITIONING SYSTEM
- METER AND GAUGE
- MFI SYSTEM
- MULTI-CENTER DISPLAY
- SEAT BELT WARNING TONE ALARM
- SUPPLEMENTAL RESTRAINT SYSTEM (SRS)
- VANITY MIRROR LIGHT

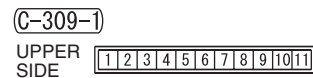
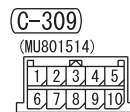
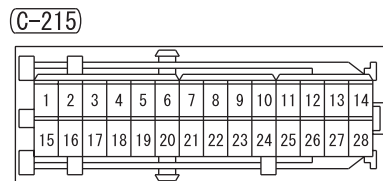
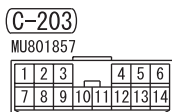
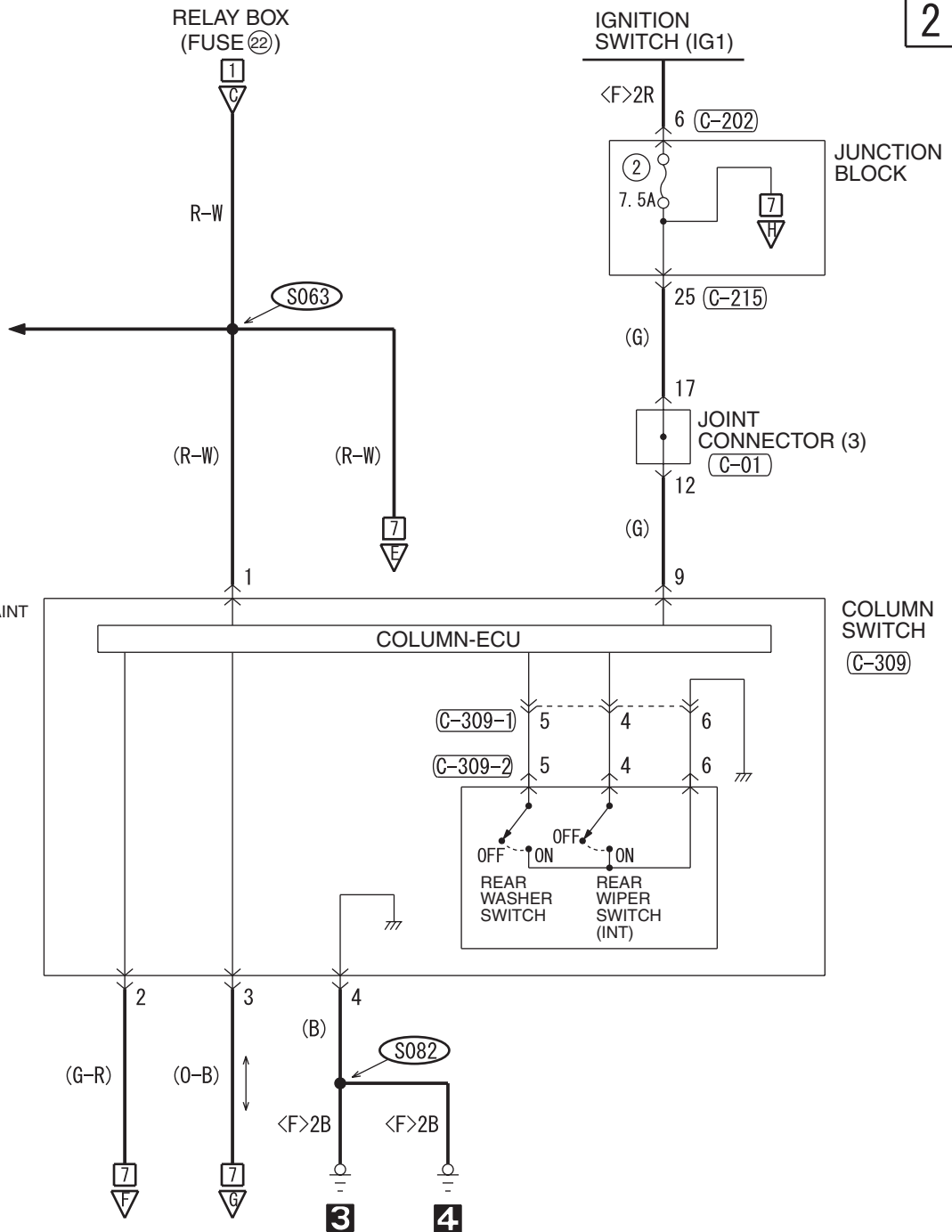

WIRE COLOR CODE

B: BLACK LG: LIGHT GREEN G: GREEN L: BLUE W: WHITE Y: YELLOW SB: SKY BLUE
BR: BROWN O: ORANGE GR: GRAY R: RED P: PINK V: VIOLET PU: PURPLE

H6P13M02AB

REAR WIPER AND WASHER <M/T> (CONTINUED)

3

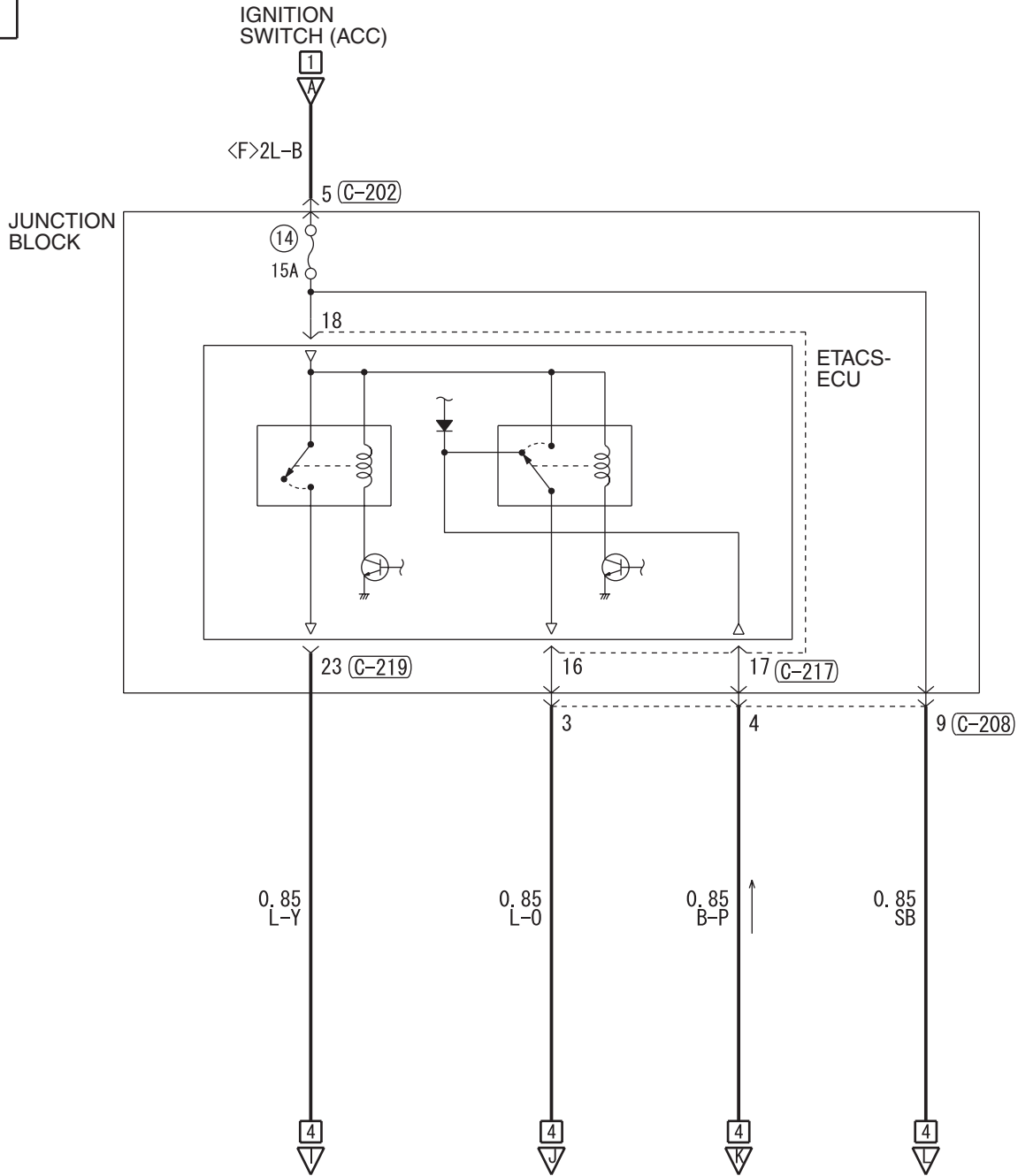

(A-32)

(C-24)

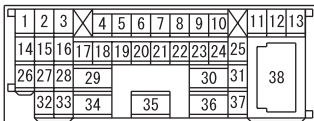

(C-202)



(C-208)

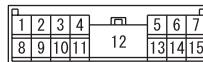

(C-217)

JUNCTION BLOCK SIDE

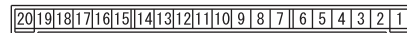

4

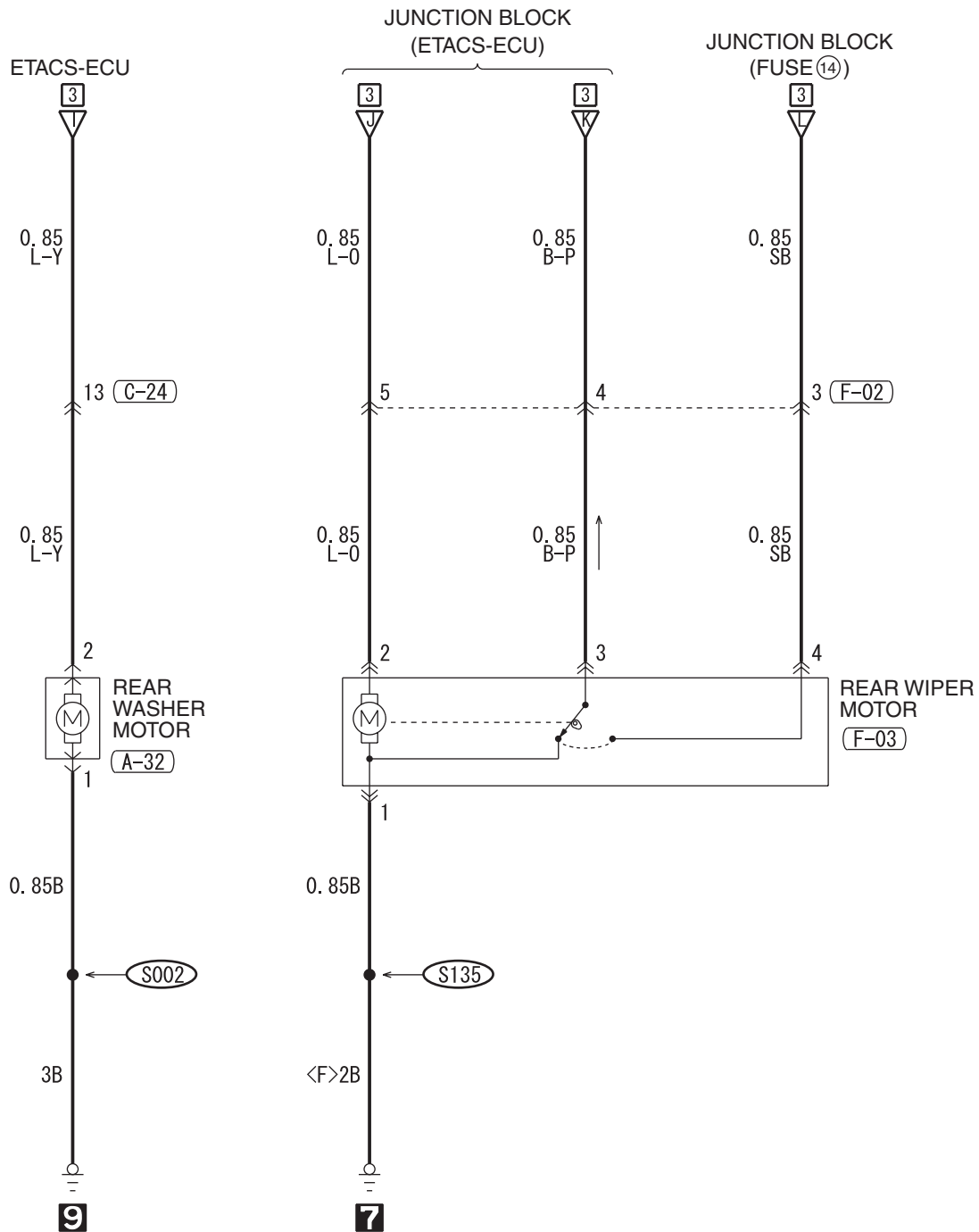

(C-219)
 (MU803765)

21	22	23	24	25	26	27	28	29
30	31	32	33	34	35	36	37	38
39	40	41		42	43	44		

(F-02)

MU801697

1	2
3	4
5	6

(F-03)

MU801445

1	2	3	4
---	---	---	---

WIRE COLOR CODE

B : BLACK LG : LIGHT GREEN G : GREEN L : BLUE W : WHITE Y : YELLOW SB : SKY BLUE
 BR : BROWN O : ORANGE GR : GRAY R : RED P : PINK V : VIOLET PU : PURPLE

H6P13M02BB

REAR WIPER AND WASHER <M/T> (CONTINUED)

5

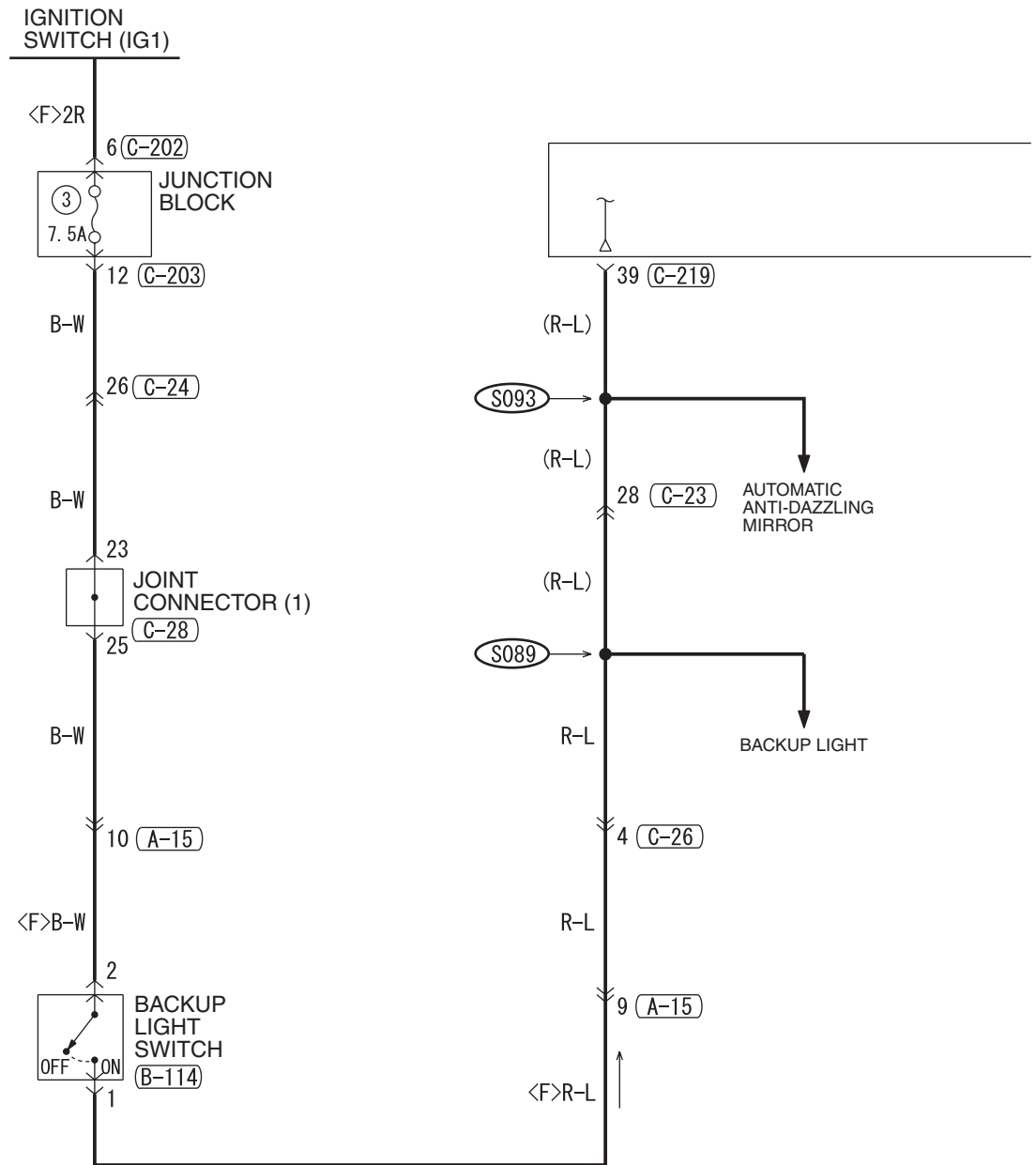

NOTE
 * 1 : WITHOUT TRACTION CONTROL SYSTEM (TCL)
 * 2 : WITH TRACTION CONTROL SYSTEM (TCL)

A-02

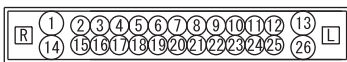

A-03

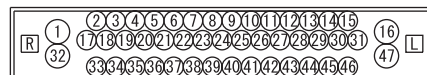

A-15

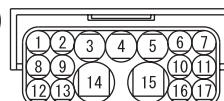

B-18



C-28



C-125 FRONT SIDE

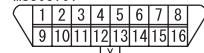

C-202



C-203

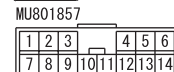

C-218



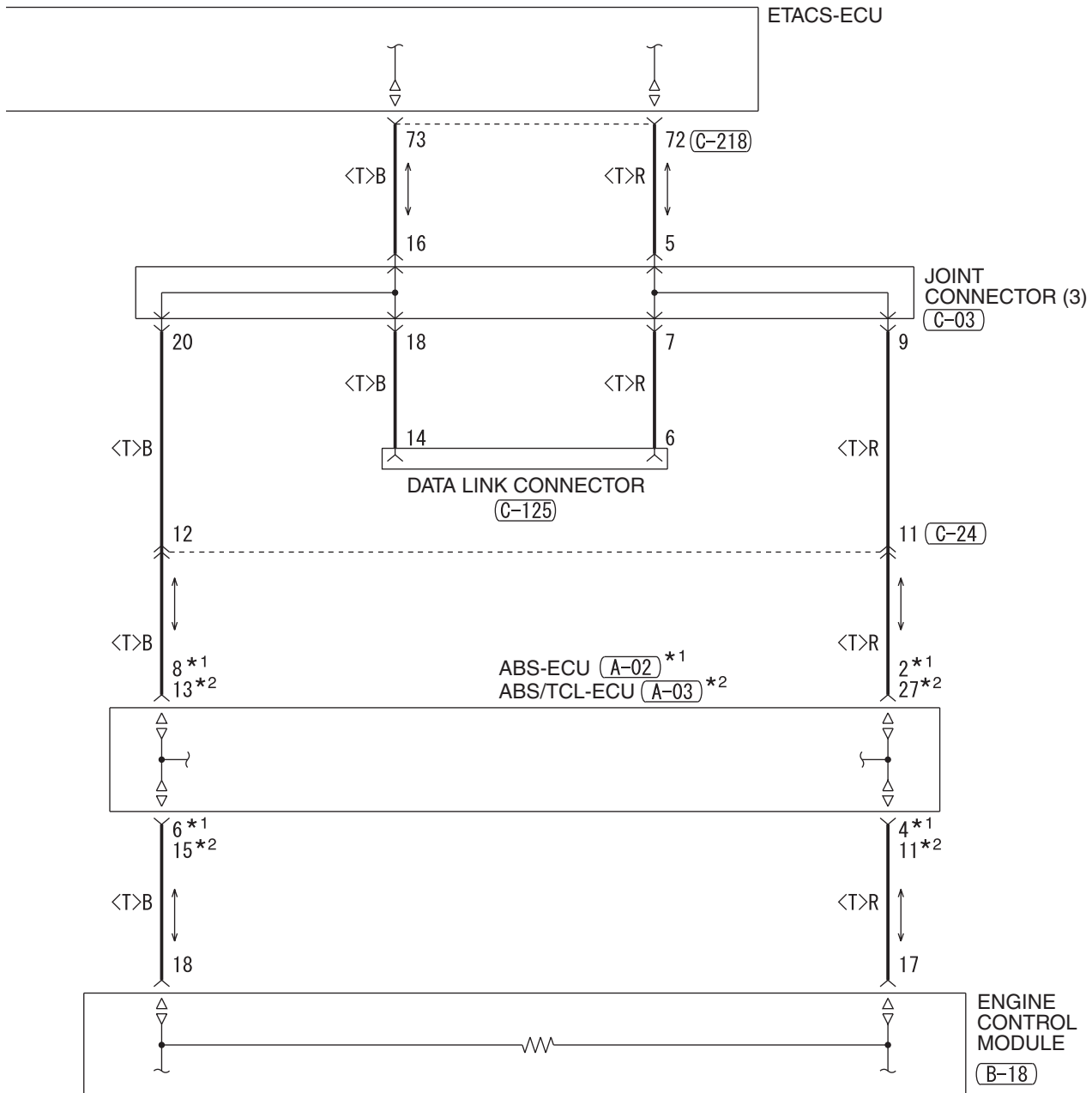

(B-114)



(C-03)

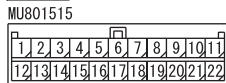

(C-23)

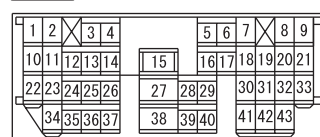

(C-24)

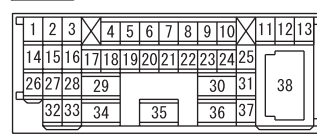

(C-26)

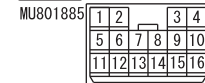

(C-219)



REAR WIPER AND WASHER <M/T> (CONTINUED)

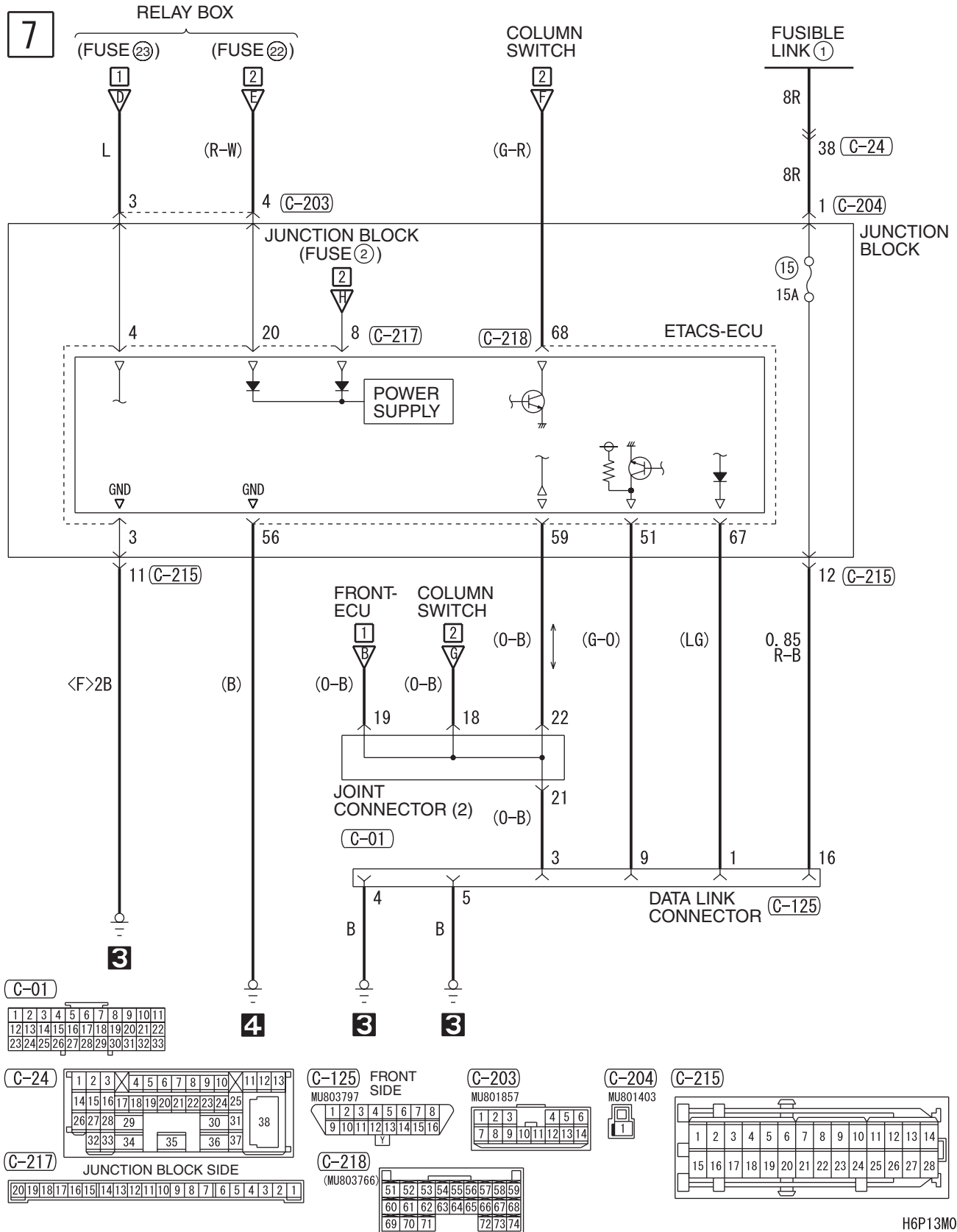

NOTES

REAR WIPER AND WASHER <A/T>

1

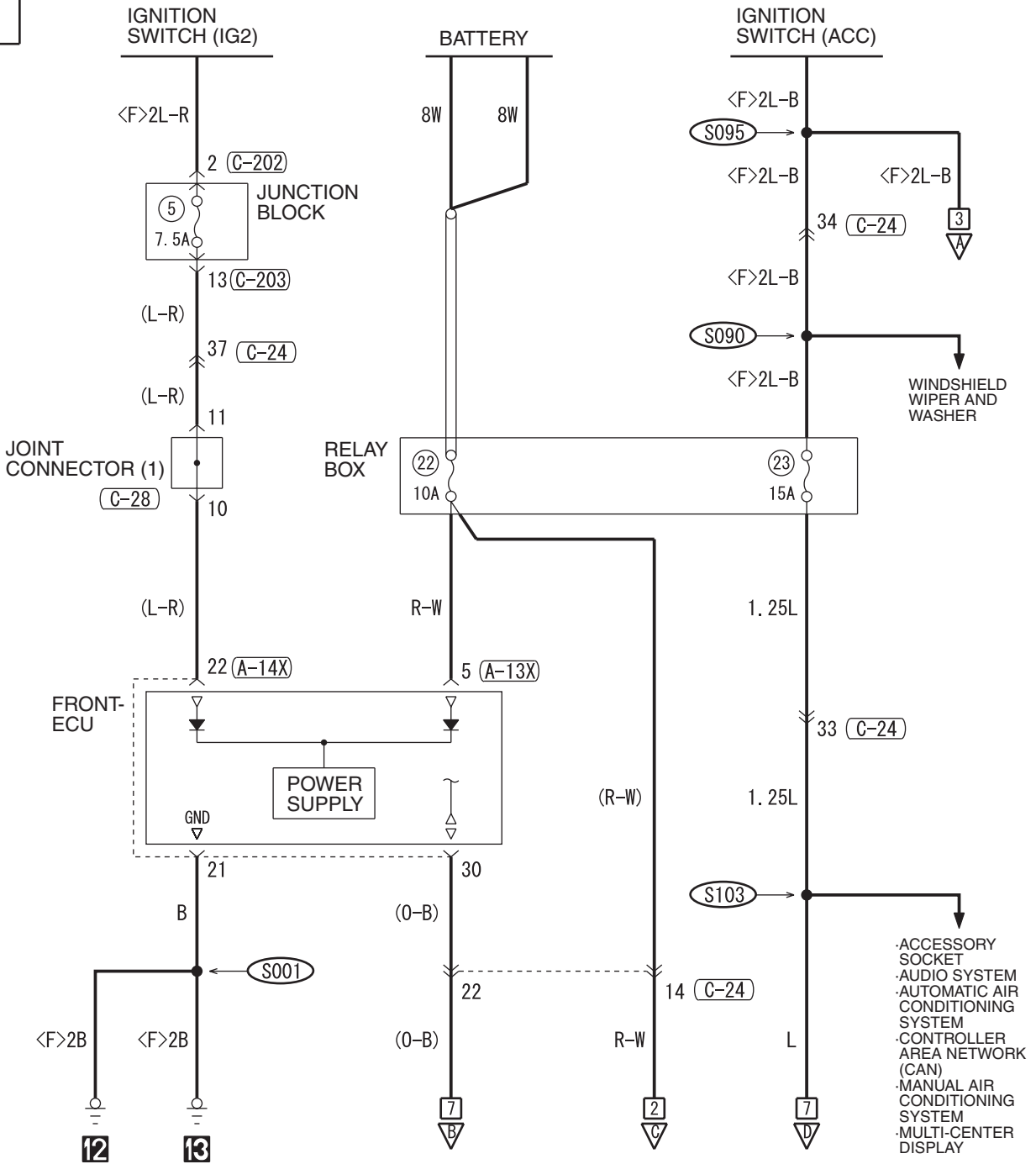

(A-13X)

1	2	3	4	5	6	7	8	9	10	11
---	---	---	---	---	---	---	---	---	----	----

(A-14X)

21	22	23	24	25	26	27	28	29	30	31
----	----	----	----	----	----	----	----	----	----	----

(C-01)

1	2	3	4	5	6	7	8	9	10	11
12	13	14	15	16	17	18	19	20	21	22
23	24	25	26	27	28	29	30	31	32	33

(C-24)

1	2	3	4	5	6	7	8	9	10	11	12	13
14	15	16	17	18	19	20	21	22	23	24	25	
26	27	28	29					30	31			
32	33	34		35		36	37			38		

(C-28)

1	2	3	4	5	6	7	8	9	10	11
12	13	14	15	16	17	18	19	20	21	22
23	24	25	26	27	28	29	30	31	32	33

(C-309-2)

UPPER SIDE

1	2	3	4	5	6	7	8	9	10	11
---	---	---	---	---	---	---	---	---	----	----

2

- AUDIO SYSTEM
- AUTO-CRUISE CONTROL SYSTEM
- AUTOMATIC AIR CONDITIONING SYSTEM
- BRAKE WARNING LIGHT, OIL PRESSURE WARNING LIGHT, FUEL WARNING LIGHT
- CENTRAL DOOR LOCKING SYSTEM
- CHARGING SYSTEM
- CONTROLLER AREA NETWORK (CAN)
- DOOR AJAR WARNING TONE ALARM
- ELECTRONIC BRAKE-FORCE DISTRIBUTION (EBD) AND ANTI-LOCK BRAKING SYSTEM (ABS)
- ENGINE IMMOBILIZER SYSTEM
- FRONT DOME LIGHT, REAR DOME LIGHT, LUGGAGE COMPARTMENT LIGHT AND IGNITION KEY HOLE ILLUMINATION LIGHT
- INVECS-II 4A/T
- INVECS-II 5A/T
- METER AND GAUGE
- MFI SYSTEM
- MULTI-CENTER DISPLAY
- SEAT BELT WARNING TONE ALARM
- SUPPLEMENTAL RESTRAINT SYSTEM (SRS)
- VANITY MIRROR LIGHT

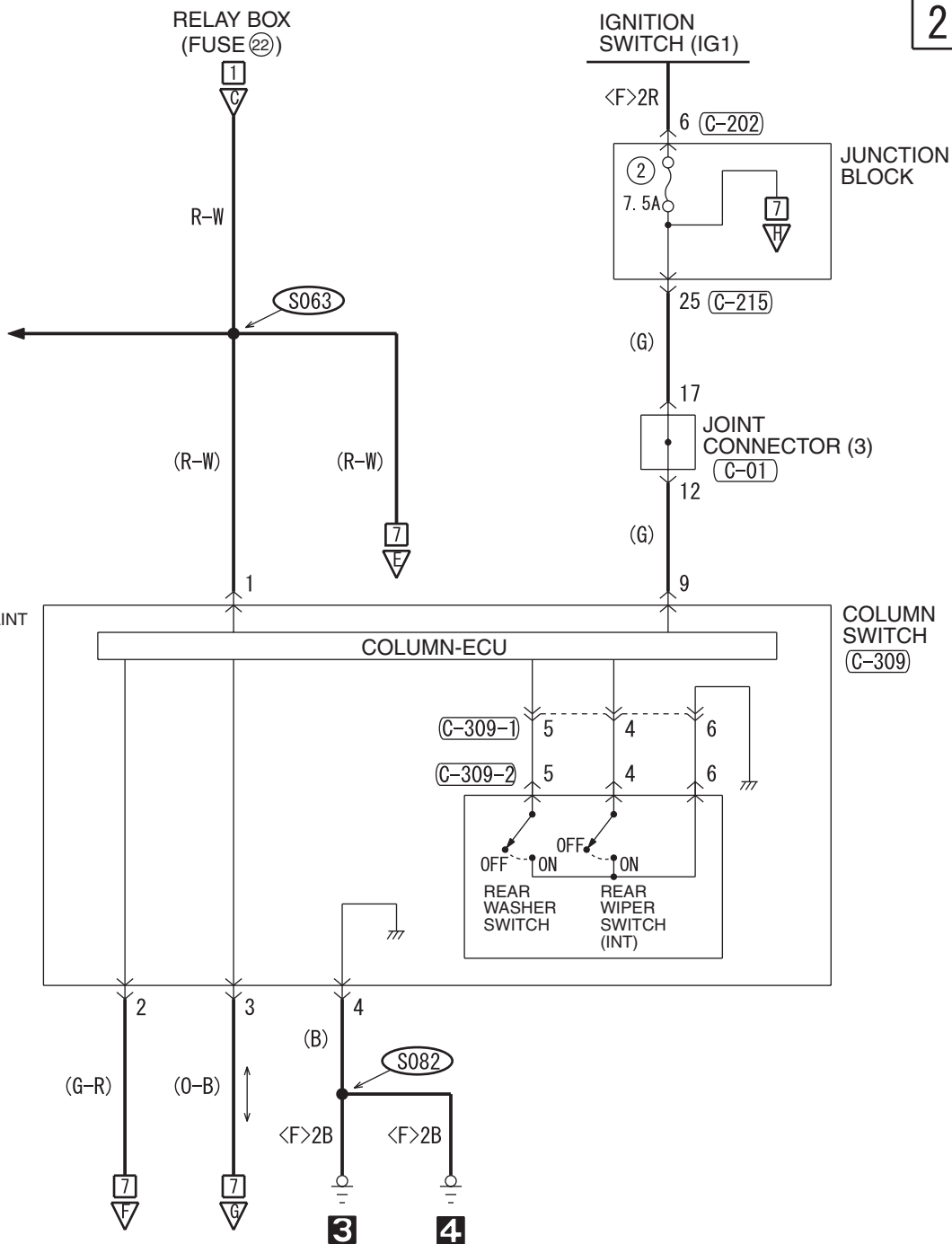

(C-202)



(C-203)

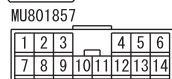

(C-215)

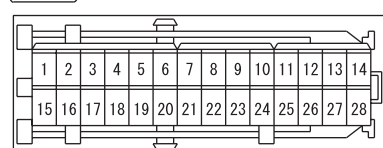

(C-309)

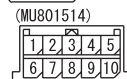

(C-309-1)

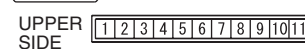

WIRE COLOR CODE

B: BLACK LG: LIGHT GREEN G: GREEN L: BLUE W: WHITE Y: YELLOW SB: SKY BLUE
BR: BROWN O: ORANGE GR: GRAY R: RED P: PINK V: VIOLET PU: PURPLE

H6P13M03AB

REAR WIPER AND WASHER <A/T> (CONTINUED)

3

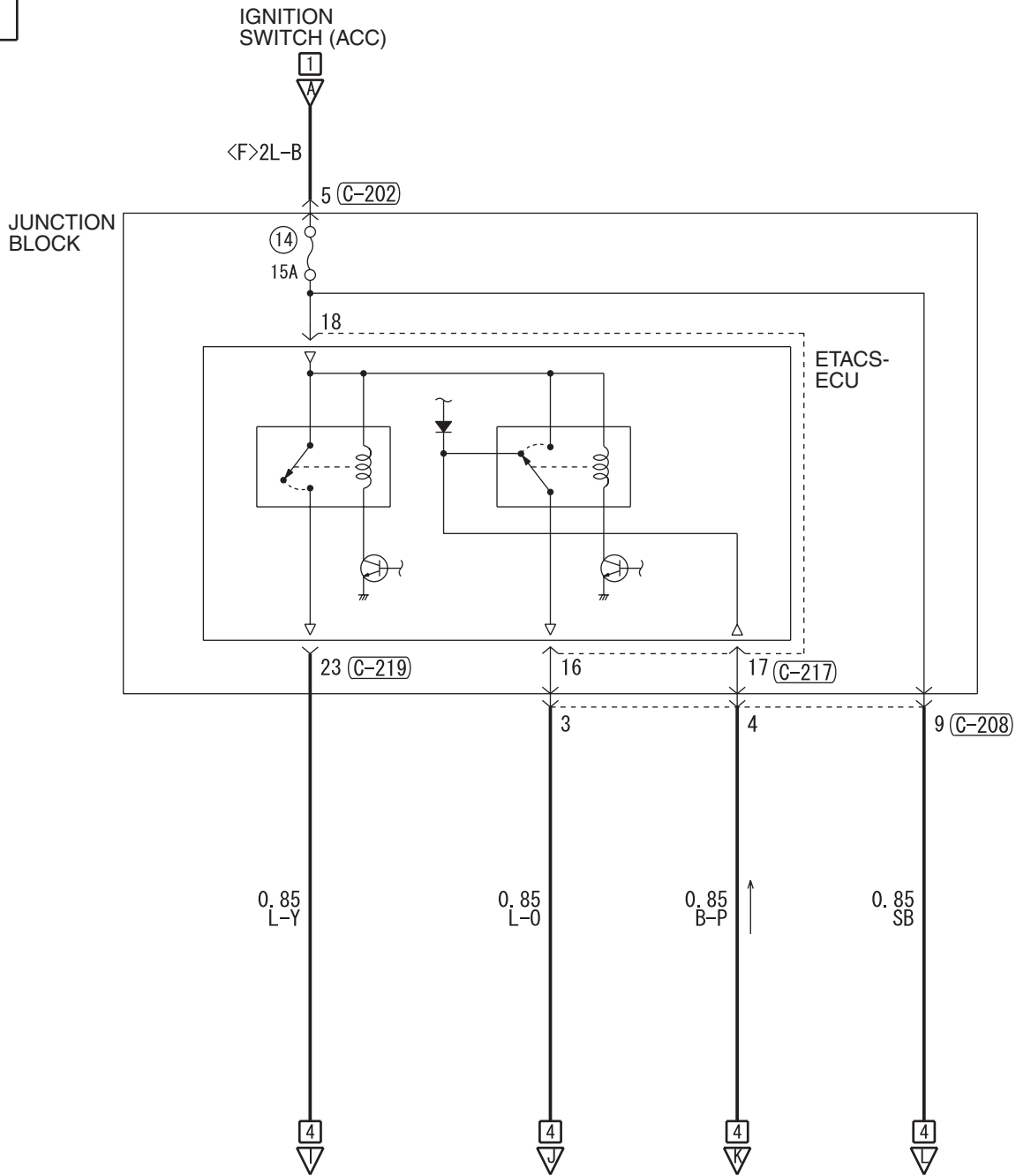

(A-32)

(C-24)

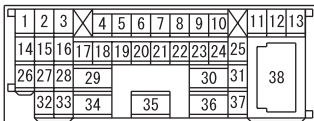

(C-202)



(C-208)

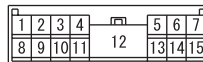

(C-217)

JUNCTION BLOCK SIDE

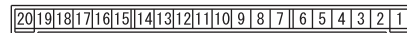

4

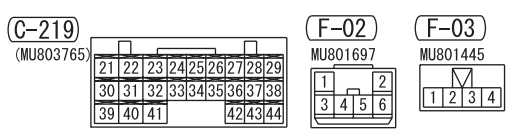
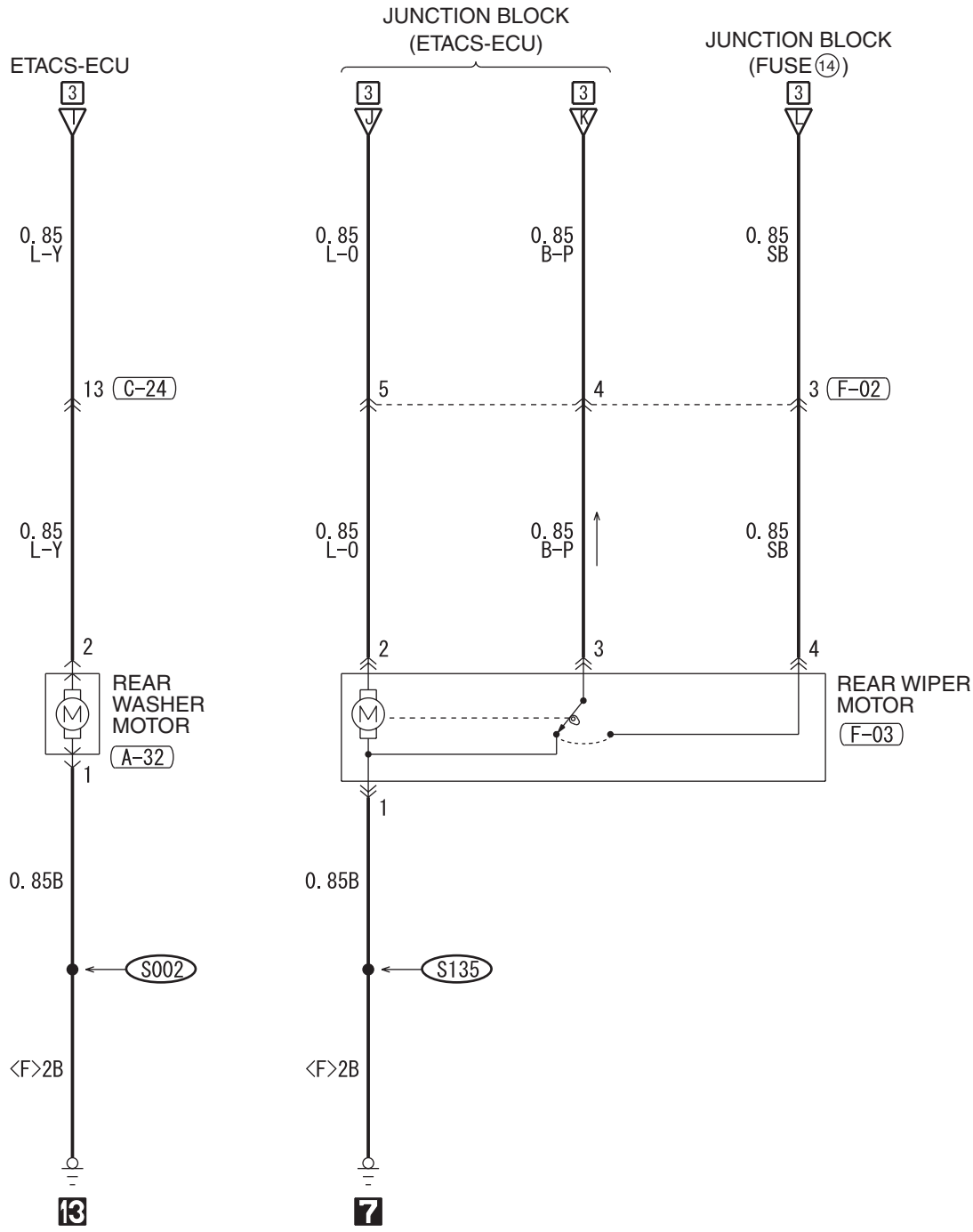

WIRE COLOR CODE
 B : BLACK LG : LIGHT GREEN G : GREEN L : BLUE W : WHITE Y : YELLOW SB : SKY BLUE
 BR : BROWN O : ORANGE GR : GRAY R : RED P : PINK V : VIOLET PU : PURPLE

REAR WIPER AND WASHER <A/T> (CONTINUED)

5

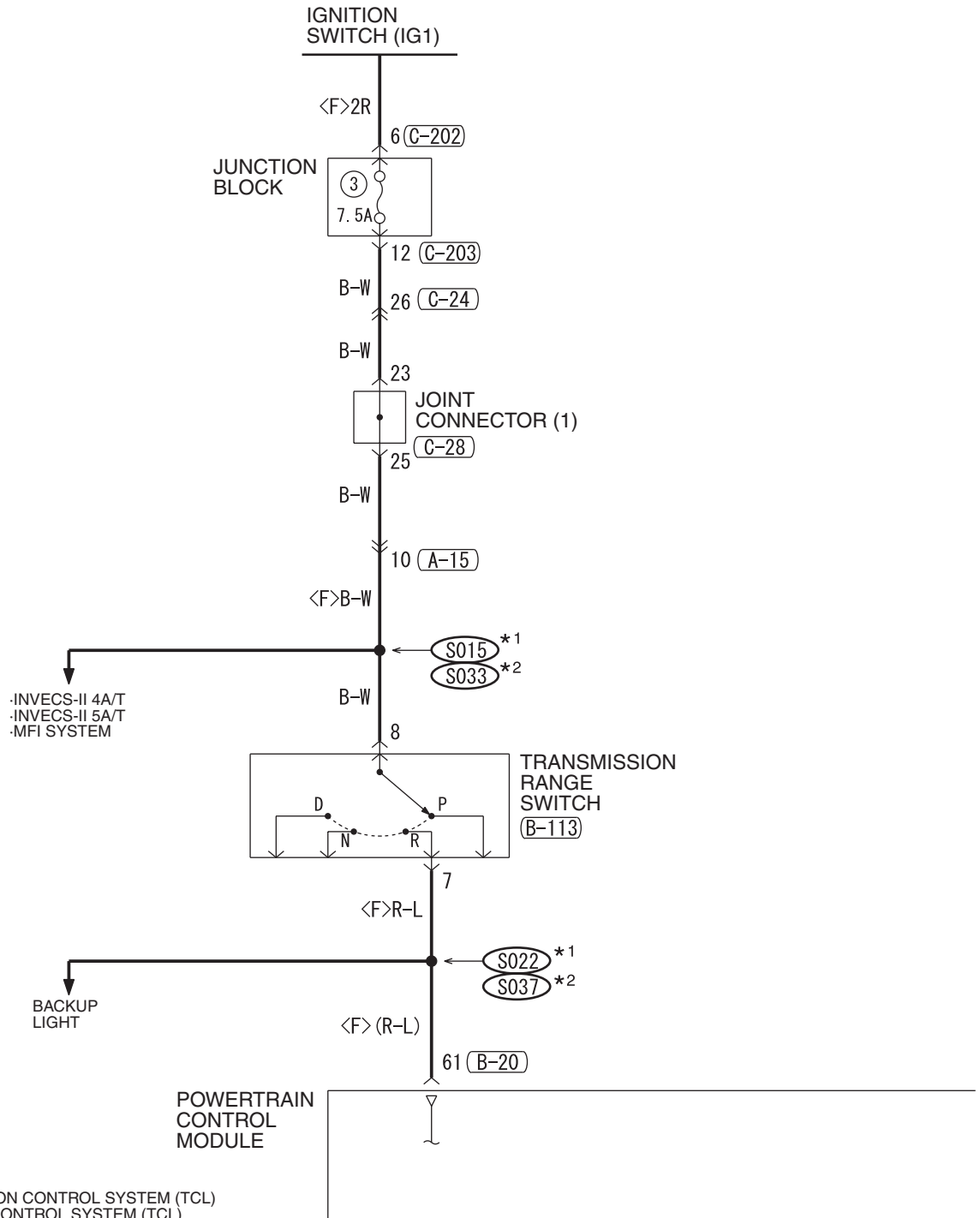

NOTE

- *1: 2.4L ENGINE
- *2: 3.8L ENGINE
- *3: WITHOUT TRACTION CONTROL SYSTEM (TCL)
- *4: WITH TRACTION CONTROL SYSTEM (TCL)

(A-02)

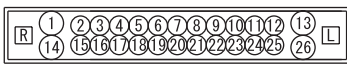

(A-03)

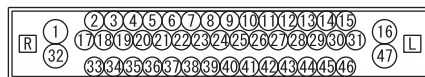

(A-15)

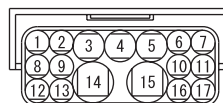

(B-18)

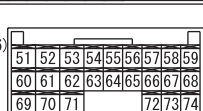
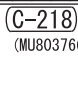
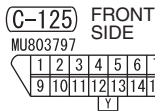
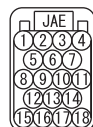

6

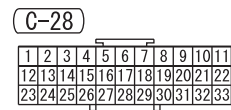
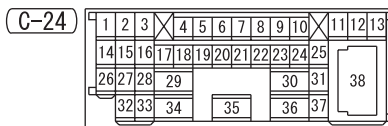
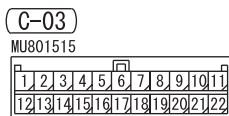
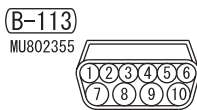
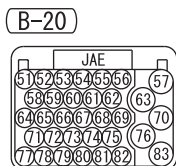
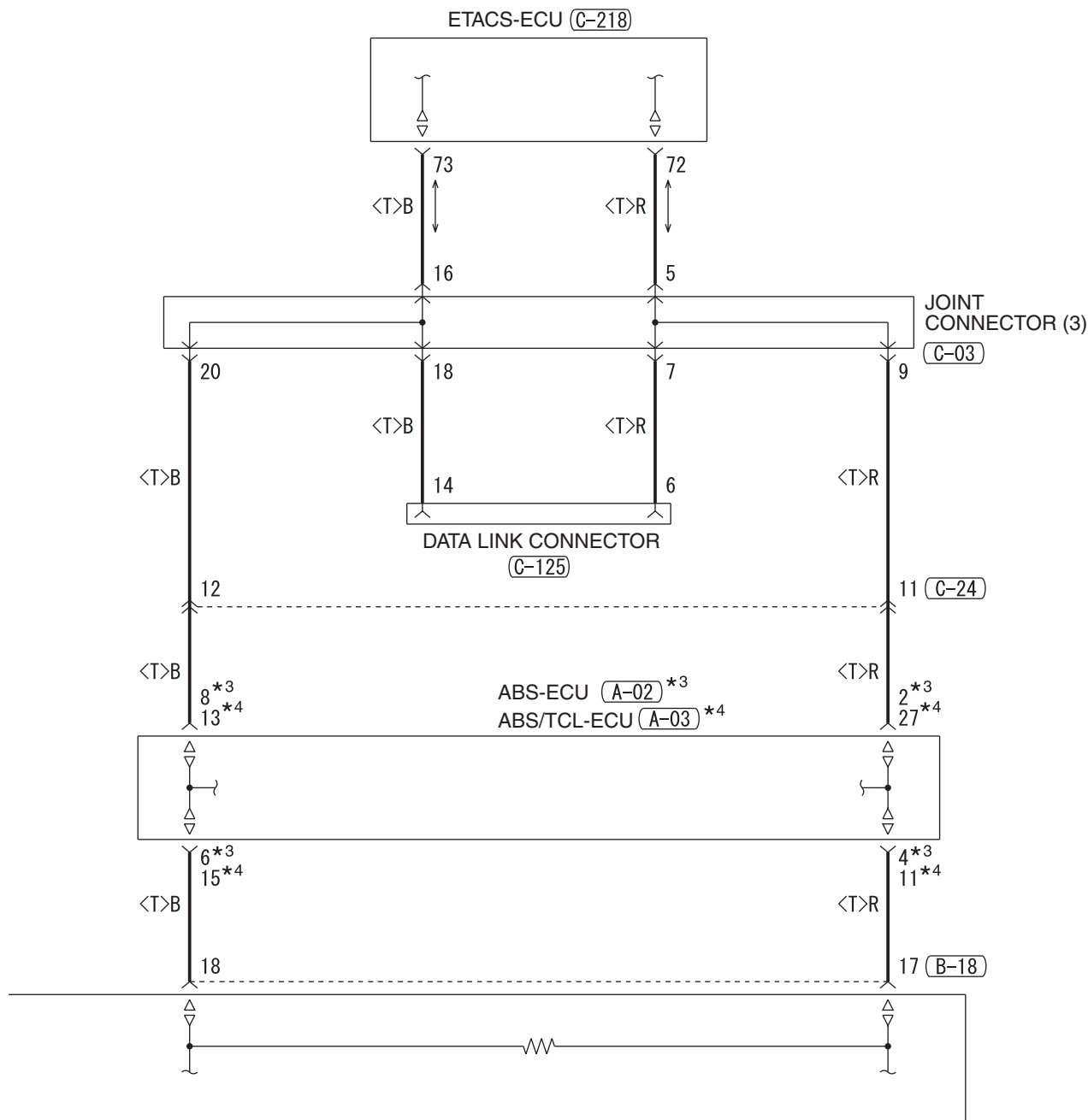

WIRE COLOR CODE
 B : BLACK LG : LIGHT GREEN G : GREEN L : BLUE
 BR : BROWN O : ORANGE GR : GRAY R : RED W : WHITE
 SB : SKY BLUE P : PINK Y : YELLOW V : VIOLET PU : PURPLE

H6P13M03CB

REAR WIPER AND WASHER <A/T> (CONTINUED)

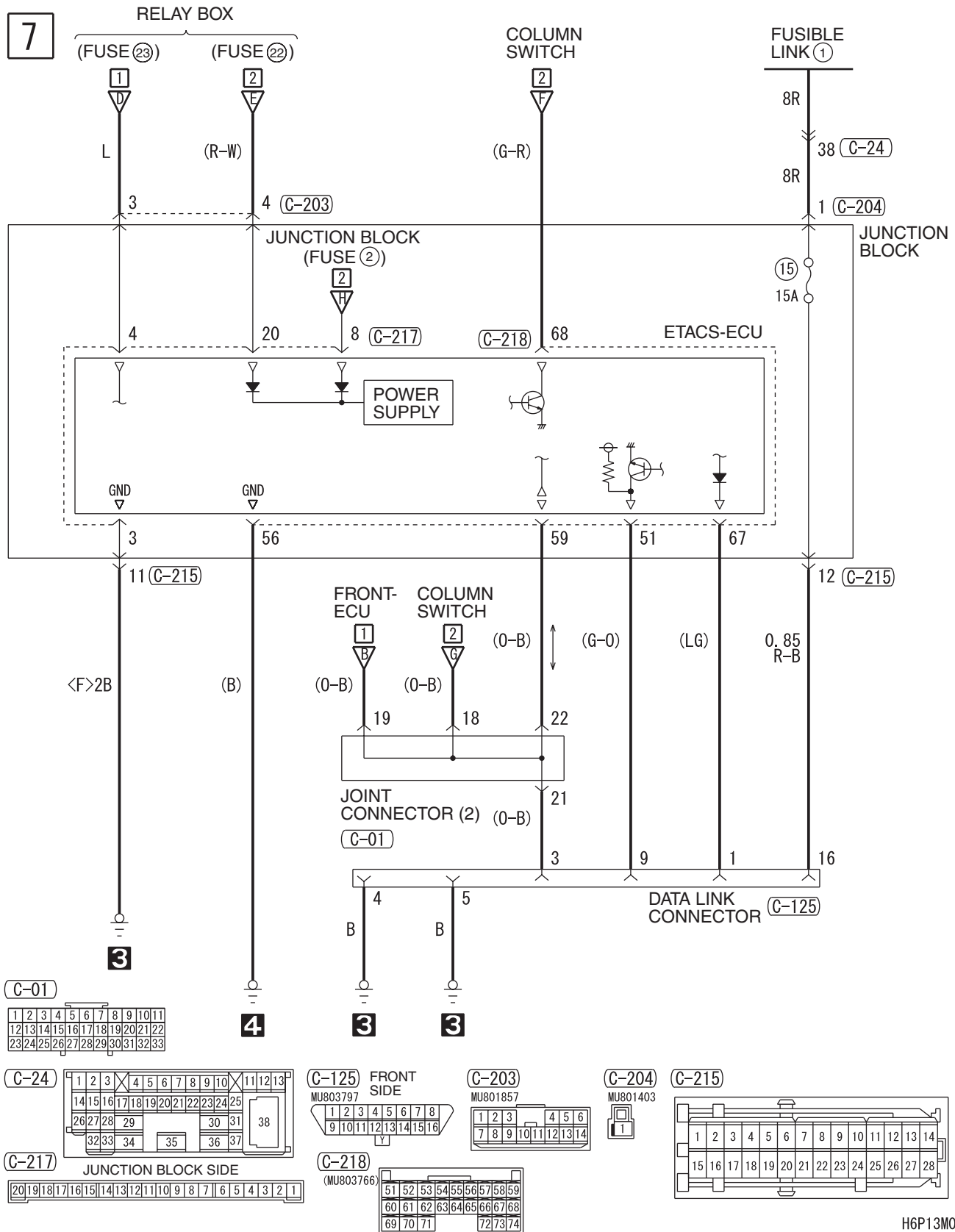

NOTES

REAR WINDOW DEFOGGER AND DOOR MIRROR HEATER

M1901013500951

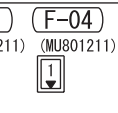
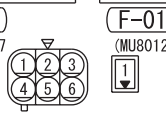
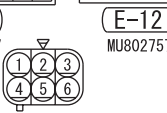
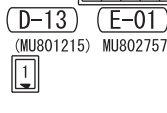
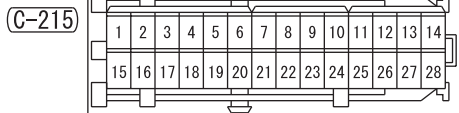
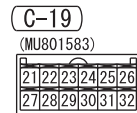
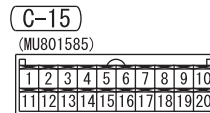
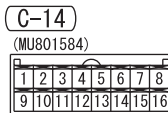
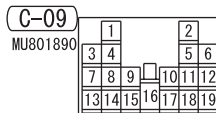
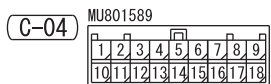
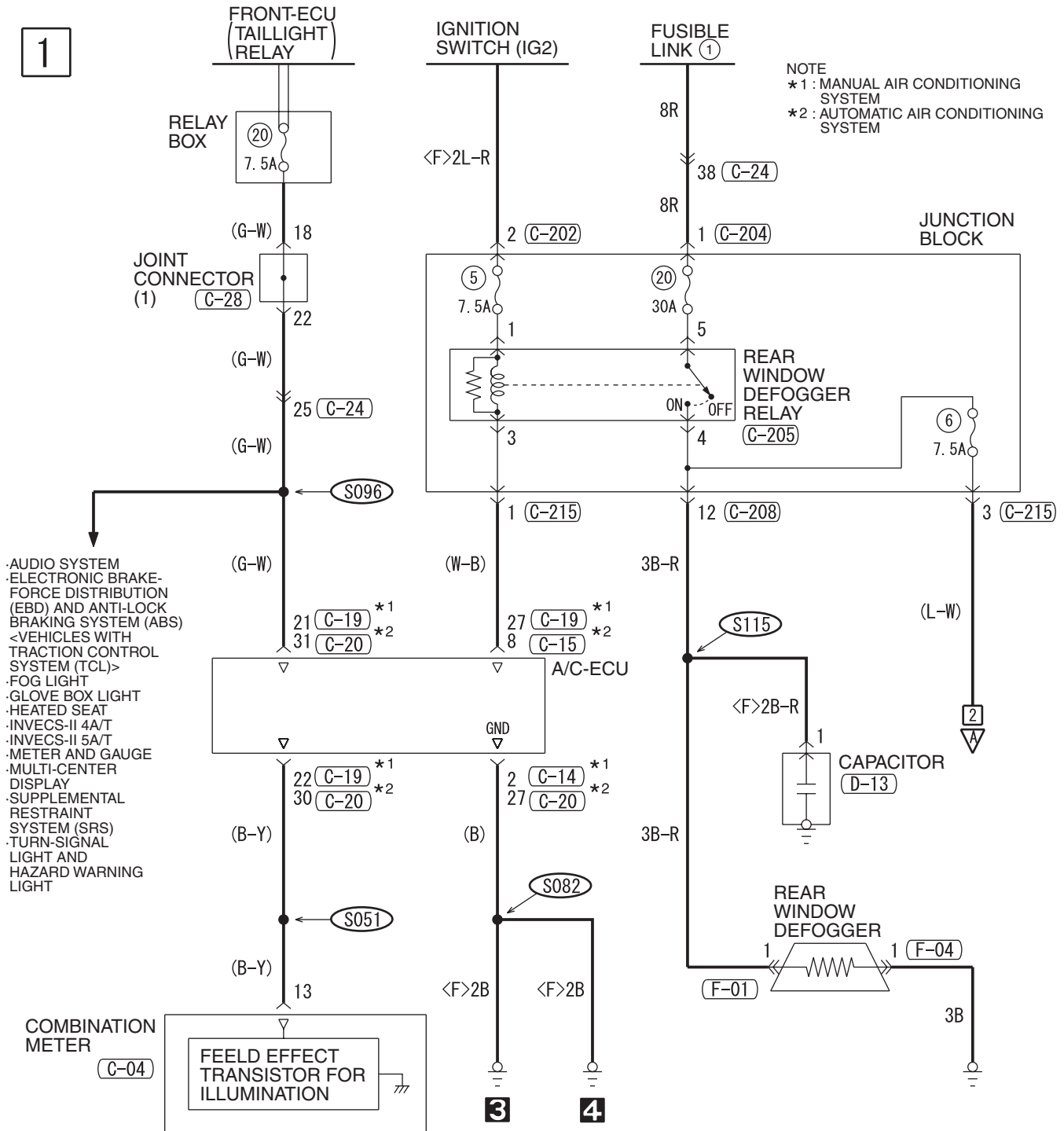

H6P13M04AA

2

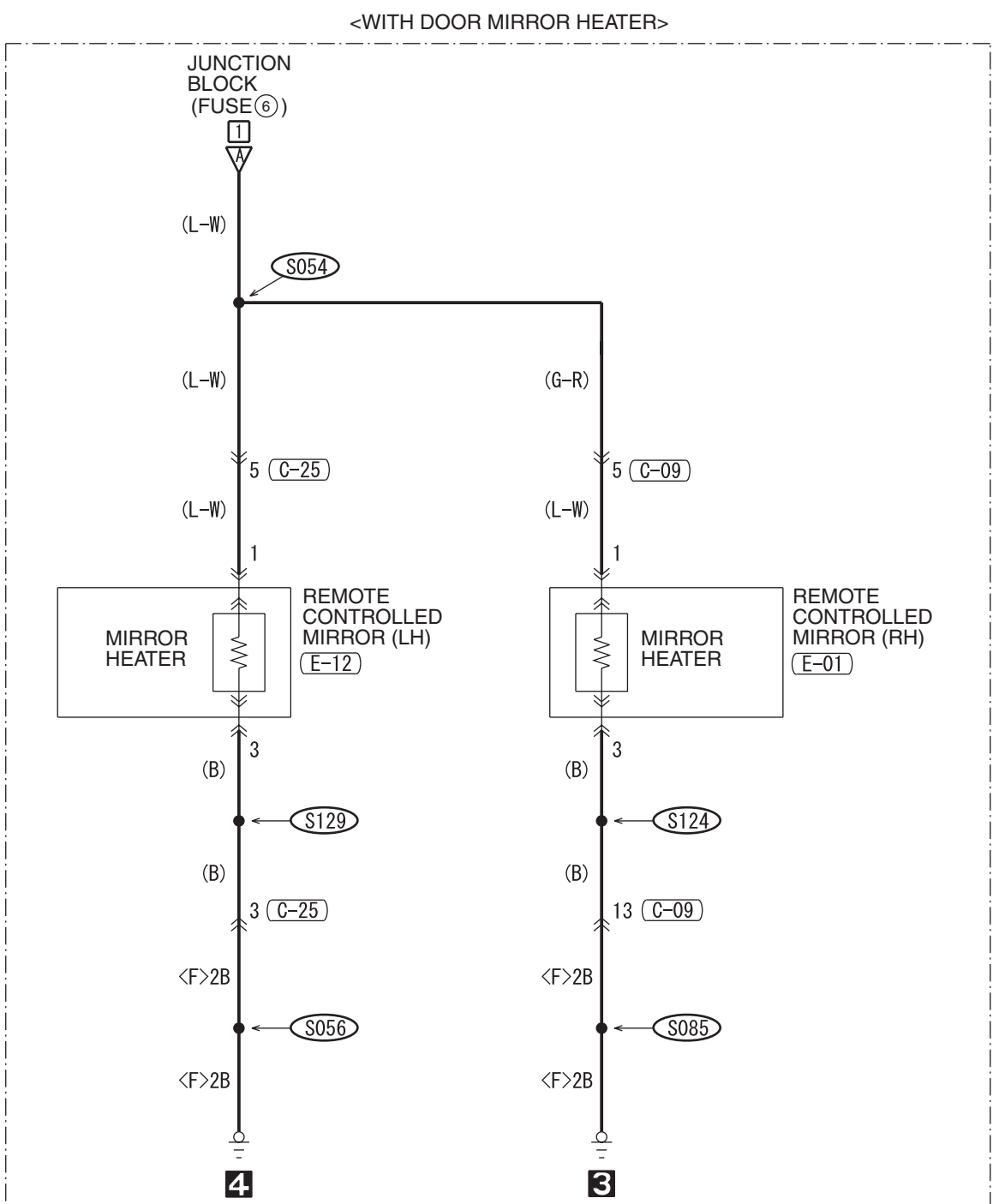

C-20 (MU801584)	C-24	C-25	C-202 MU801331	C-204 MU801403	C-205	C-208

WIRE COLOR CODE
 B : BLACK LG : LIGHT GREEN G : GREEN L : BLUE
 BR : BROWN O : ORANGE GR : GRAY R : RED W : WHITE
 SB : SKY BLUE P : PINK Y : YELLOW V : VIOLET PU : PURPLE
 H6P13M04AB

REMOTE CONTROLLED MIRROR

M1901006501457

1

- AUDIO SYSTEM
- AUTOMATIC AIR
- CONDITIONING SYSTEM
- CENTRAL DOOR
- LOCKING SYSTEM
- CONTROLLER AREA
- NETWORK (CAN)
- FRONT DOME LIGHT,
- REAR DOME LIGHT,
- LUGGAGE
- COMPARTMENT LIGHT
- AND IGNITION KEY HOLE
- ILLUMINATION LIGHT
- MANUAL AIR
- CONDITIONING SYSTEM
- MULTI-CENTER DISPLAY
- REAR WIPER AND
- WASHER
- WINDSHIELD WIPER
- AND WASHER

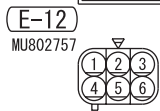
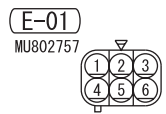
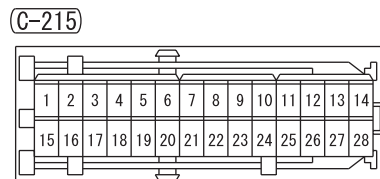
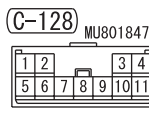
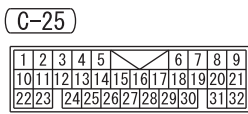
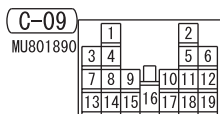
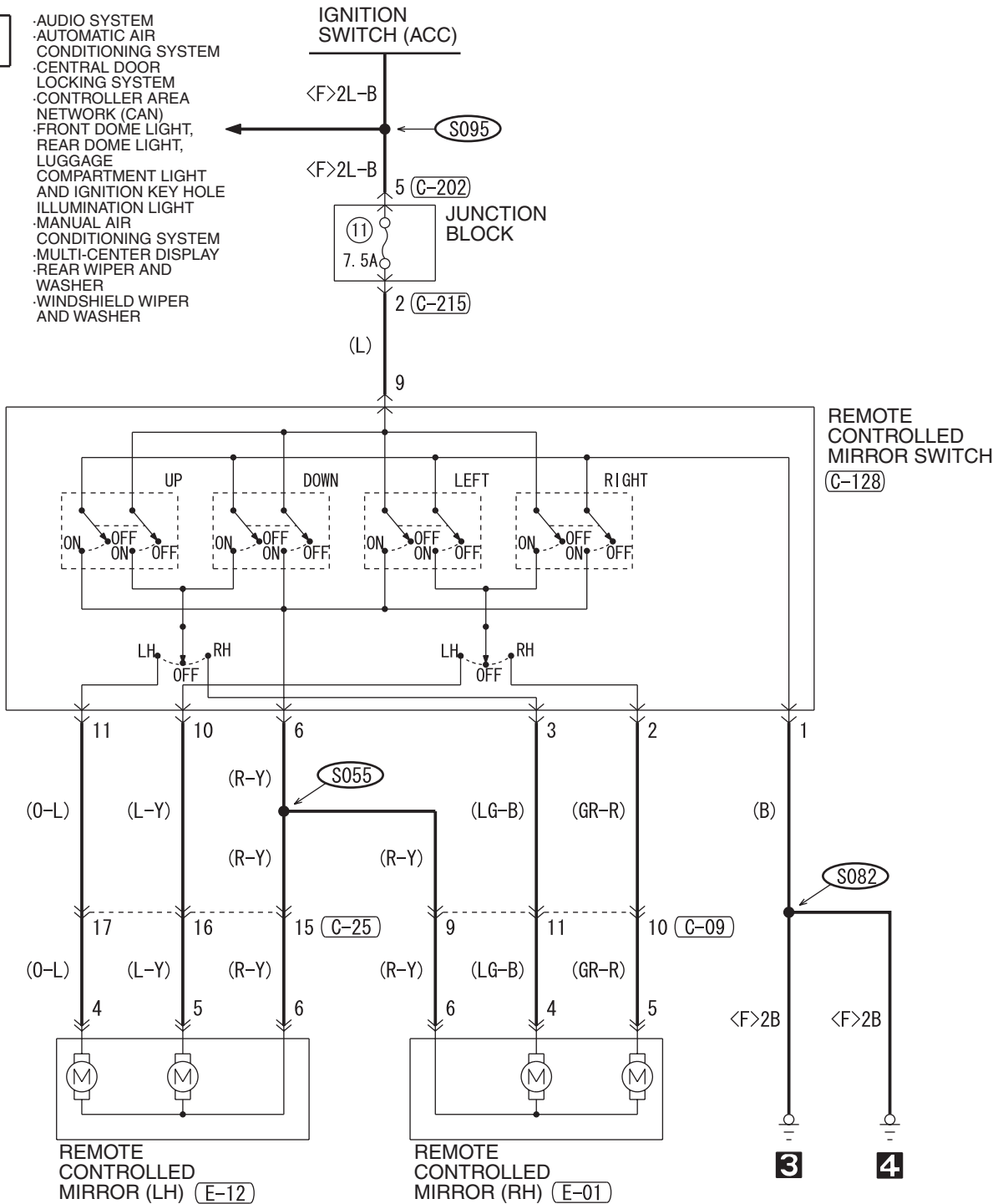

H6P13M05AA

NOTES

AUTOMATIC ANTI-DAZZLING MIRROR

M1901006800262

1

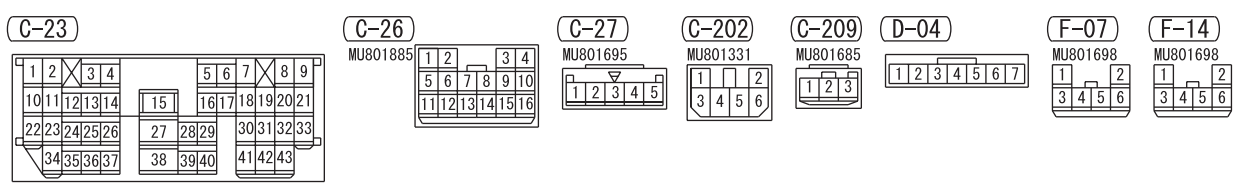
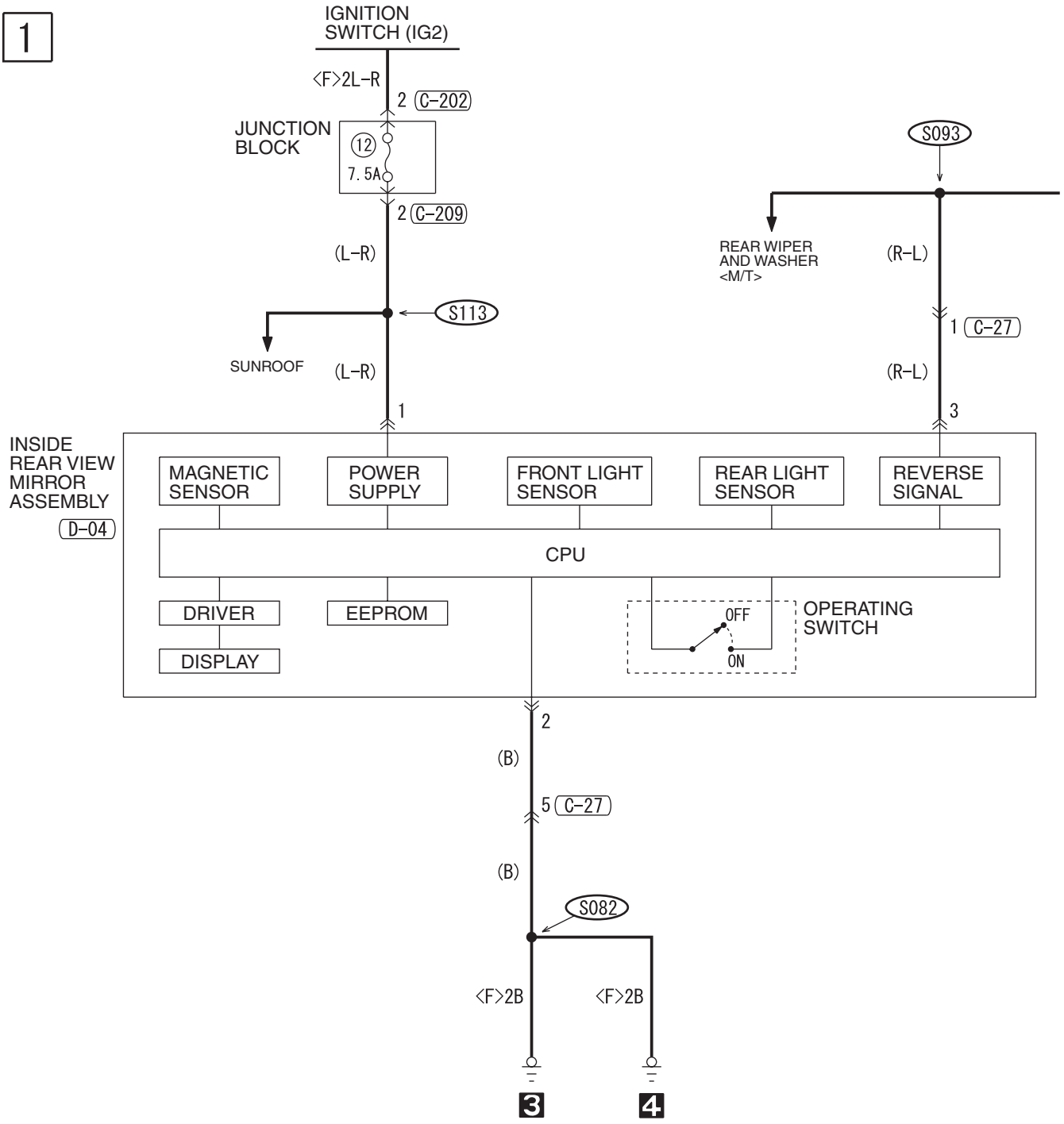

H6P13M06AA

2

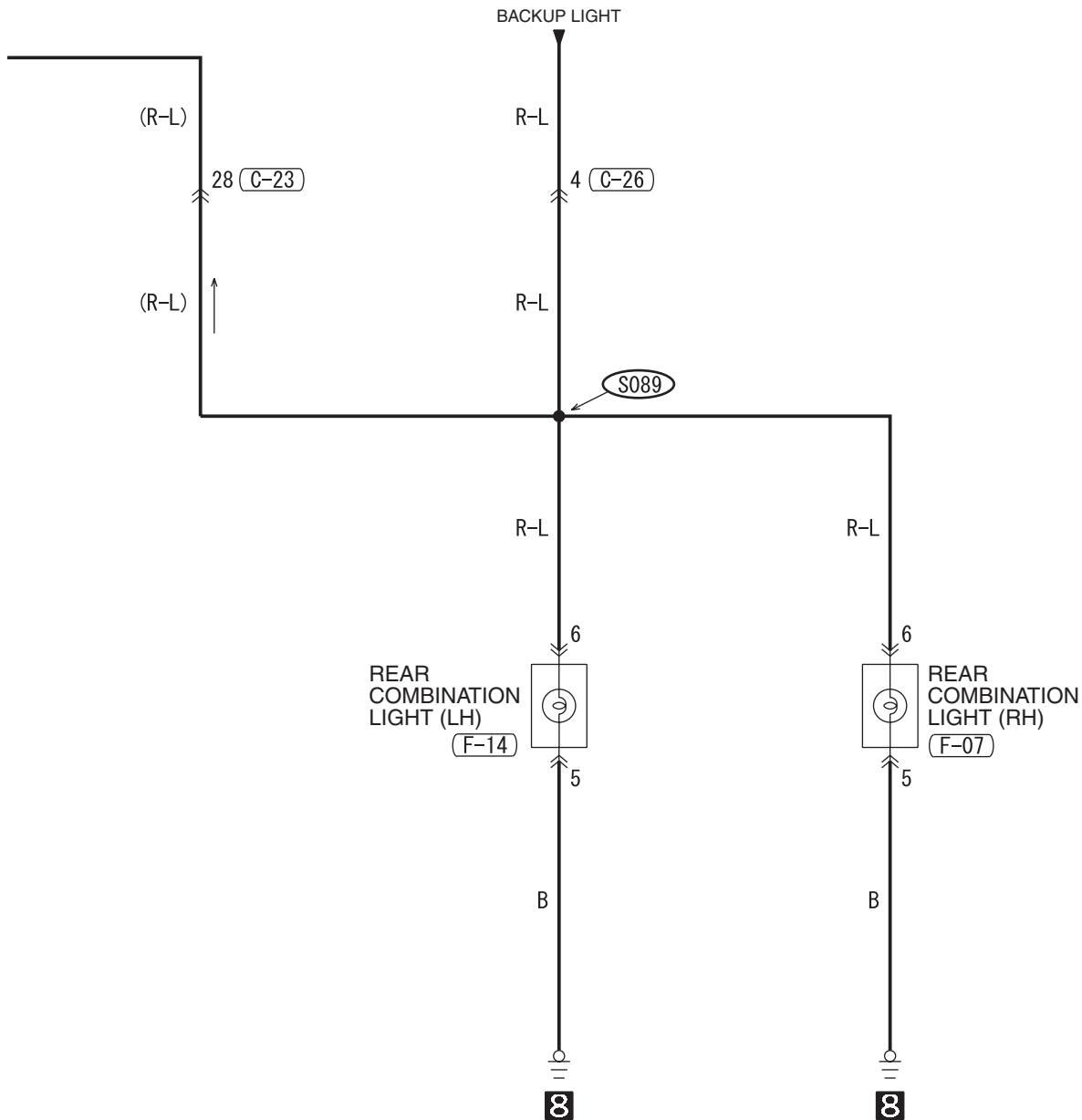

WIRE COLOR CODE
 B: BLACK LG: LIGHT GREEN G: GREEN L: BLUE W: WHITE Y: YELLOW SB: SKY BLUE
 BR: BROWN O: ORANGE GR: GRAY R: RED P: PINK V: VIOLET PU: PURPLE

H6P13M06AB

TSB Revision

AUDIO SYSTEM <VEHICLES WITHOUT AUDIO AMPLIFIER>

M1901015601883

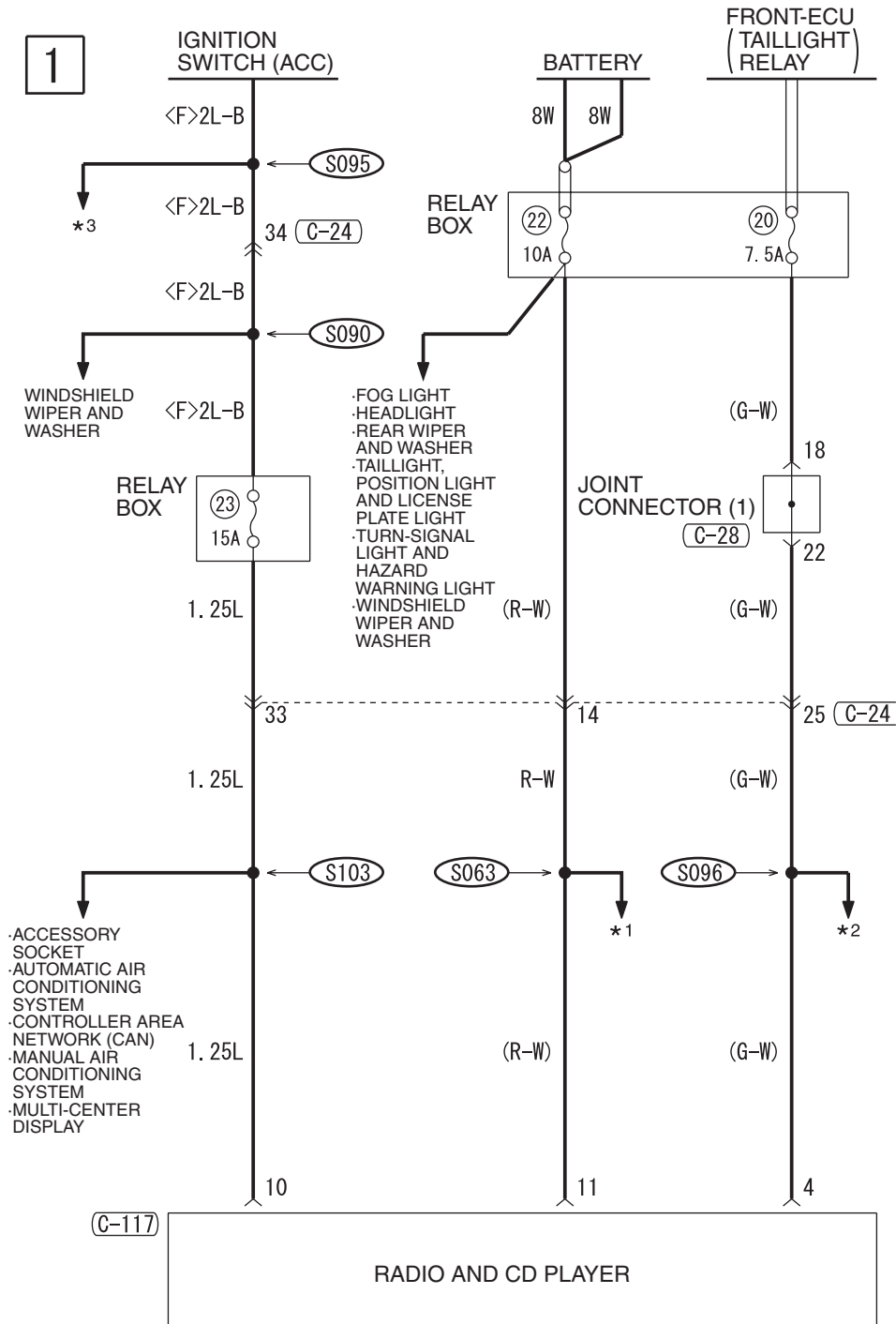

NOTE

- *1: -AUTO-CRUISE CONTROL SYSTEM
- AUTOMATIC AIR CONDITIONING SYSTEM
- BRAKE WARNING LIGHT, OIL PRESSURE WARNING LIGHT, FUEL WARNING LIGHT
- CENTRAL DOOR LOCKING SYSTEM
- CHARGING SYSTEM
- CONTROLLER AREA NETWORK (CAN)
- DOOR AJAR WARNING TONE ALARM
- ELECTRONIC BRAKE-FORCE DISTRIBUTION (EBD) AND ANTI-LOCK BRAKING SYSTEM (ABS)
- ENGINE IMMOBILIZER SYSTEM
- FOG LIGHT
- FRONT DOME LIGHT, REAR DOME LIGHT, LUGGAGE COMPARTMENT LIGHT AND IGNITION KEY HOLE ILLUMINATION LIGHT
- HEADLIGHT
- INVECS-II 4A/T
- INVECS-II 5A/T
- LIGHTING MONITOR TONE ALARM
- MANUAL AIR CONDITIONING SYSTEM
- METER AND GAUGE
- MFI SYSTEM
- MULTI-CENTER DISPLAY
- REAR WIPER AND WASHER
- SEAT BELT WARNING TONE ALARM
- SUPPLEMENTAL RESTRAINT SYSTEM (SRS)
- TAILLIGHT, POSITION LIGHT AND LICENSE PLATE LIGHT
- TURN-SIGNAL LIGHT AND HAZARD WARNING LIGHT
- VANITY MIRROR LIGHT
- WINDSHIELD WIPER AND WASHER

- *2: -AUTOMATIC AIR CONDITIONING SYSTEM
- ELECTRONIC BRAKE-FORCE DISTRIBUTION (EBD) AND ANTI-LOCK BRAKING SYSTEM (ABS)
- <VEHICLES WITH TRACTION CONTROL SYSTEM (TCL)>
- FOG LIGHT
- GLOVE BOX LIGHT
- HEATED SEAT
- INVECS-II 4A/T
- INVECS-II 5A/T
- MANUAL AIR CONDITIONING SYSTEM
- METER AND GAUGE
- MULTI-CENTER DISPLAY
- REAR WINDOW DEFOGGER AND DOOR MIRROR HEATER
- SUPPLEMENTAL RESTRAINT SYSTEM (SRS)
- TURN-SIGNAL LIGHT AND HAZARD WARNING LIGHT

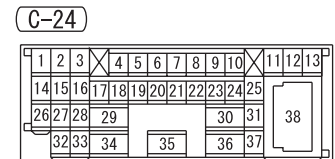
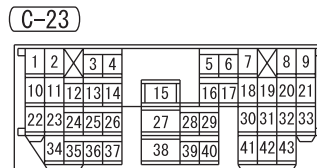
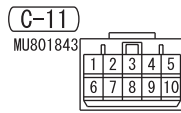
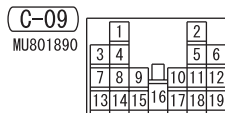
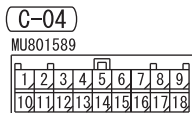

H6P14M00AA

2

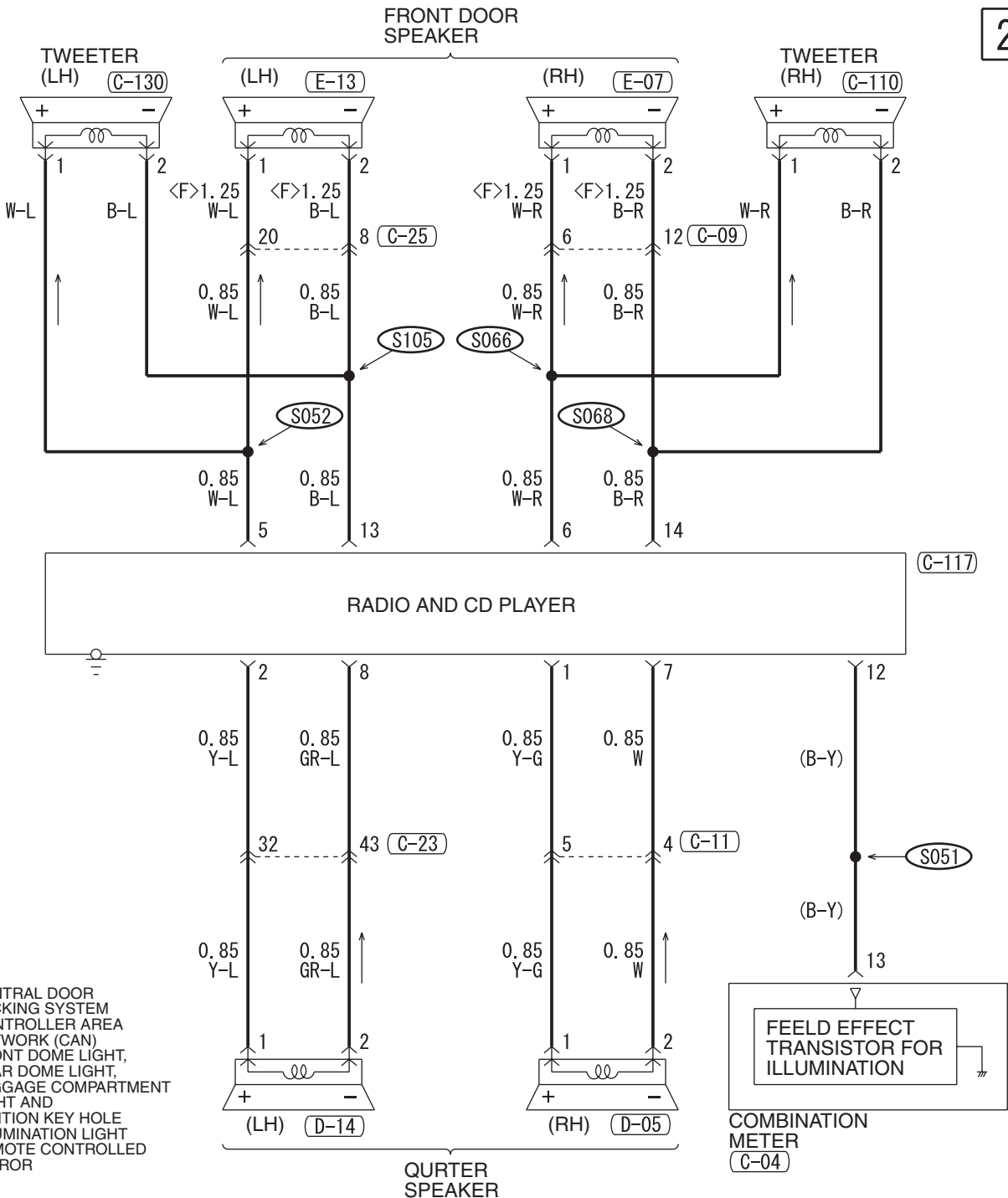

NOTE
 *3: -CENTRAL DOOR LOCKING SYSTEM
 -CONTROLLER AREA NETWORK (CAN)
 -FRONT DOME LIGHT, REAR DOME LIGHT, LUGGAGE COMPARTMENT LIGHT AND IGNITION KEY HOLE ILLUMINATION LIGHT
 -REMOTE CONTROLLED MIRROR

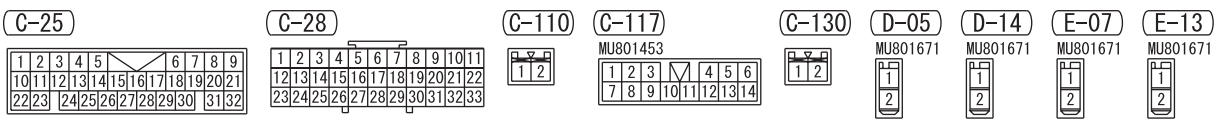

WIRE COLOR CODE
 B : BLACK LG : LIGHT GREEN G : GREEN L : BLUE
 BR : BROWN O : ORANGE GR : GRAY R : RED W : WHITE
 SB : SKY BLUE P : PINK Y : YELLOW V : VIOLET PU : PURPLE

AUDIO SYSTEM <VEHICLES WITHOUT AUDIO AMPLIFIER> (CONTINUED)

3

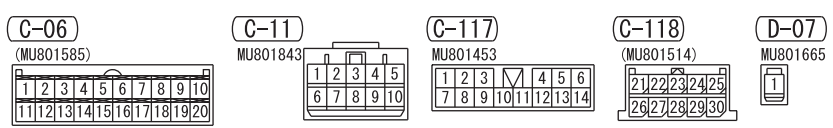
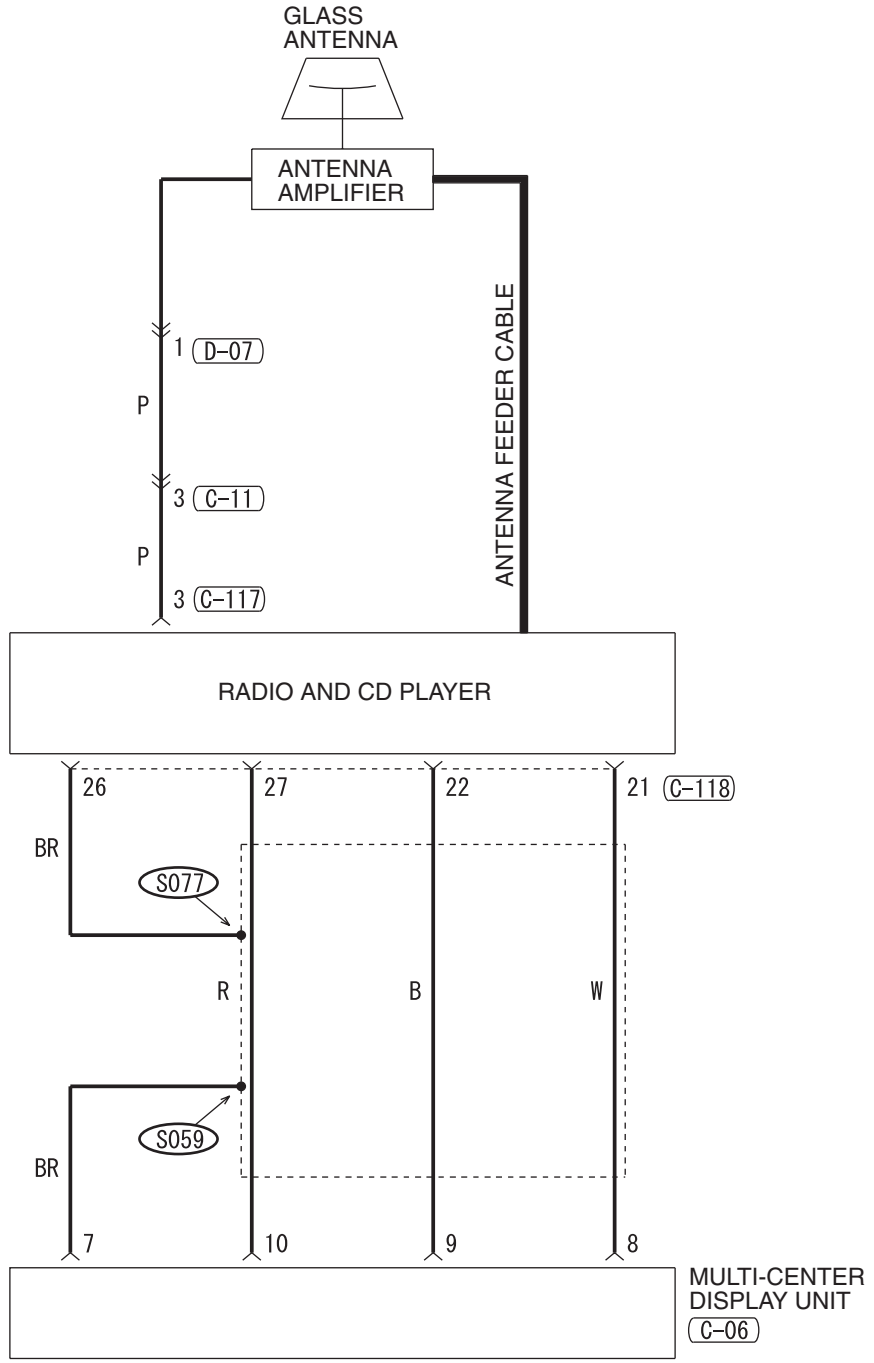

WIRE COLOR CODE
 B : BLACK LG : LIGHT GREEN G : GREEN L : BLUE W : WHITE Y : YELLOW SB : SKY BLUE
 BR : BROWN O : ORANGE GR : GRAY R : RED P : PINK V : VIOLET PU : PURPLE

NOTES

AUDIO SYSTEM <VEHICLES WITH AUDIO AMPLIFIER>

M1901015601894

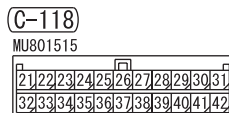
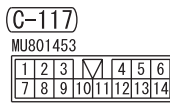
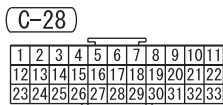
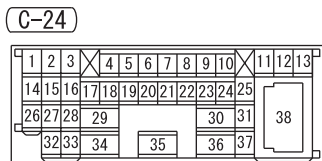
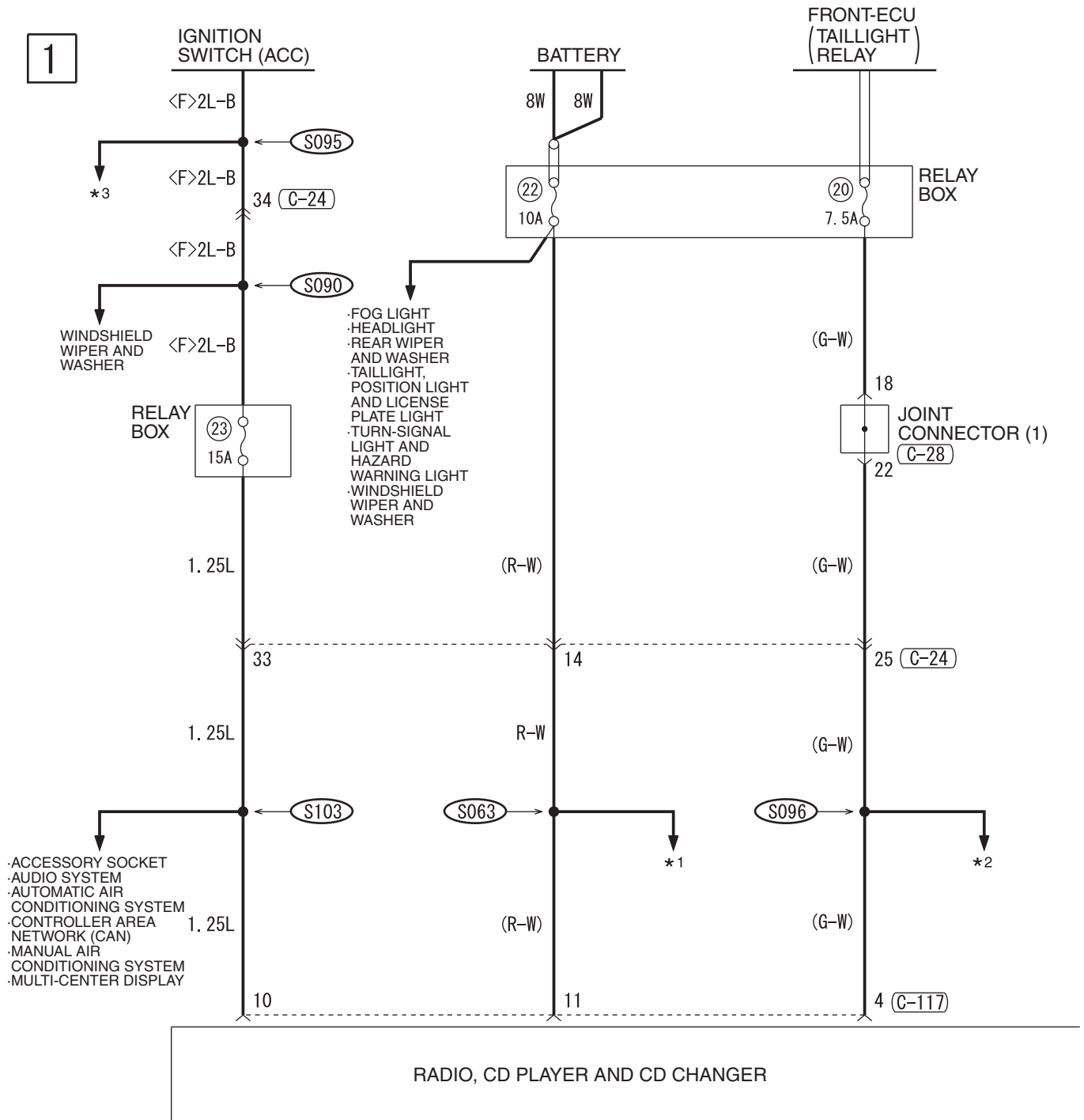

2

NOTE

- *1: .AUTO-CRUISE CONTROL SYSTEM
.AUTOMATIC AIR CONDITIONING SYSTEM
.BRAKE WARNING LIGHT, OIL PRESSURE WARNING LIGHT, FUEL WARNING LIGHT
.CENTRAL DOOR LOCKING SYSTEM
.CHARGING SYSTEM
.CONTROLLER AREA NETWORK (CAN)
.DOOR AJAR WARNING TONE ALARM
.ELECTRONIC BRAKE-FORCE DISTRIBUTION (EBD) AND ANTI-LOCK BRAKING SYSTEM (ABS)
.ENGINE IMMOBILIZER SYSTEM
.FOG LIGHT
.FRONT DOME LIGHT, REAR DOME LIGHT, LUGGAGE COMPARTMENT LIGHT AND IGNITION KEY HOLE ILLUMINATION LIGHT
.HEADLIGHT
.INVECS-II 4A/T
.INVECS-II 5A/T
.LIGHTING MONITOR TONE ALARM
.MANUAL AIR CONDITIONING SYSTEM
.METER AND GAUGE
.MFI SYSTEM
.MULTI-CENTER DISPLAY
.REAR WIPER AND WASHER
.SEAT BELT WARNING TONE ALARM
.SUPPLEMENTAL RESTRAINT SYSTEM (SRS)
.TAILLIGHT, POSITION LIGHT AND LICENSE PLATE LIGHT
.TURN-SIGNAL LIGHT AND HAZARD WARNING LIGHT
.VANITY MIRROR LIGHT
.WINDSHIELD WIPER AND WASHER

- *2: .AUTOMATIC AIR CONDITIONING SYSTEM
.ELECTRONIC BRAKE-FORCE DISTRIBUTION (EBD) AND ANTI-LOCK BRAKING SYSTEM (ABS) <VEHICLES WITH TRACTION CONTROL SYSTEM (TCL)>
.FOG LIGHT
.GLOVE BOX LIGHT
.HEATED SEAT
.INVECS-II 4A/T
.INVECS-II 5A/T
.MANUAL AIR CONDITIONING SYSTEM
.METER AND GAUGE
.MULTI-CENTER DISPLAY
.REAR WINDOW DEFOGGER AND DOOR MIRROR HEATER
.SUPPLEMENTAL RESTRAINT SYSTEM (SRS)
.TURN-SIGNAL LIGHT AND HAZARD WARNING LIGHT

- *3: .CENTRAL DOOR LOCKING SYSTEM
.CONTROLLER AREA NETWORK (CAN)
.FRONT DOME LIGHT, REAR DOME LIGHT, LUGGAGE COMPARTMENT LIGHT AND IGNITION KEY HOLE ILLUMINATION LIGHT
.REMOTE CONTROLLED MIRROR

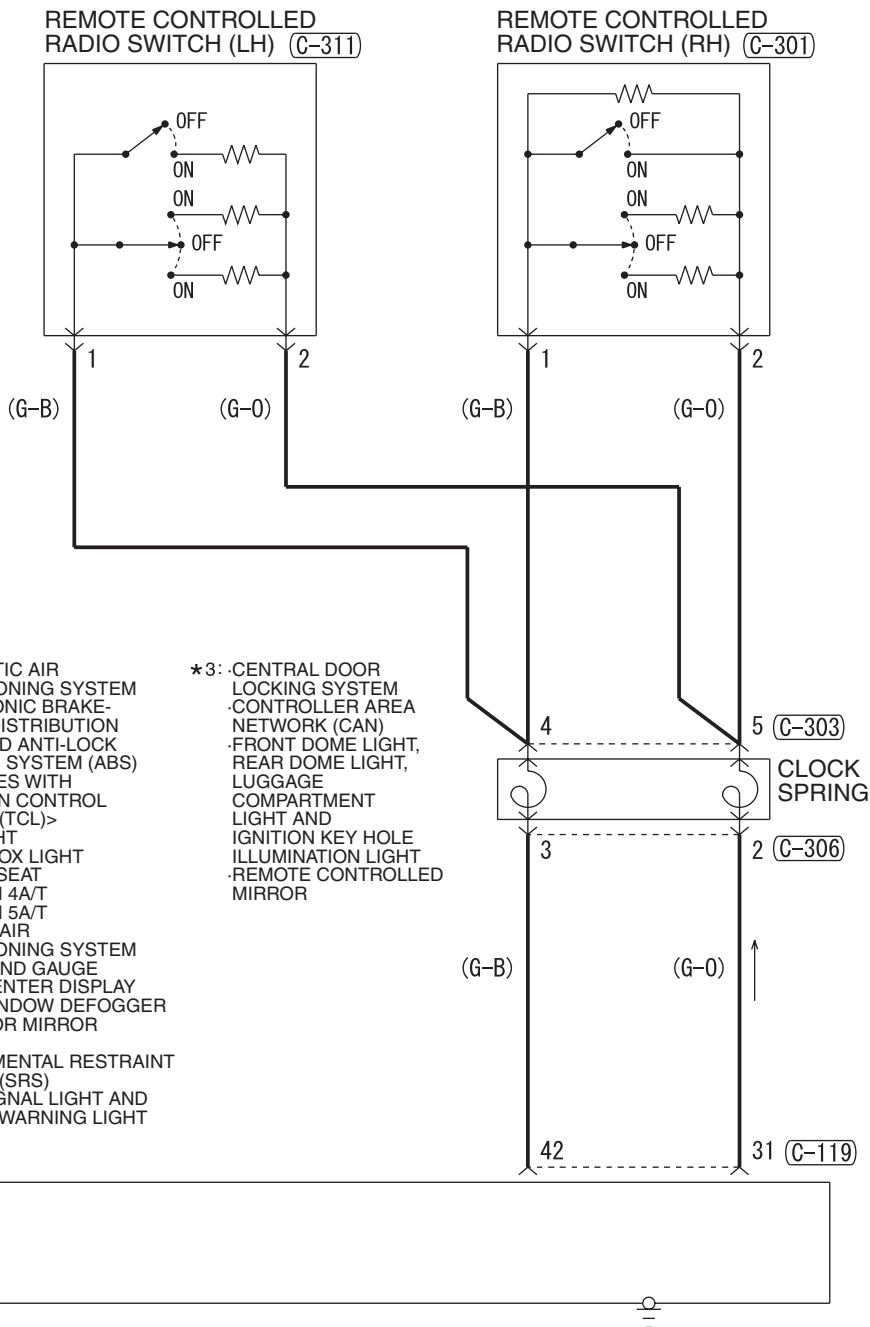

(C-306)

(C-311)

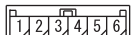

WIRE COLOR CODE

B : BLACK LG : LIGHT GREEN G : GREEN L : BLUE W : WHITE Y : YELLOW SB : SKY BLUE
BR : BROWN O : ORANGE GR : GRAY R : RED P : PINK V : VIOLET PU : PURPLE

H6P14M01AB

AUDIO SYSTEM <VEHICLES WITH AUDIO AMPLIFIER> (CONTINUED)

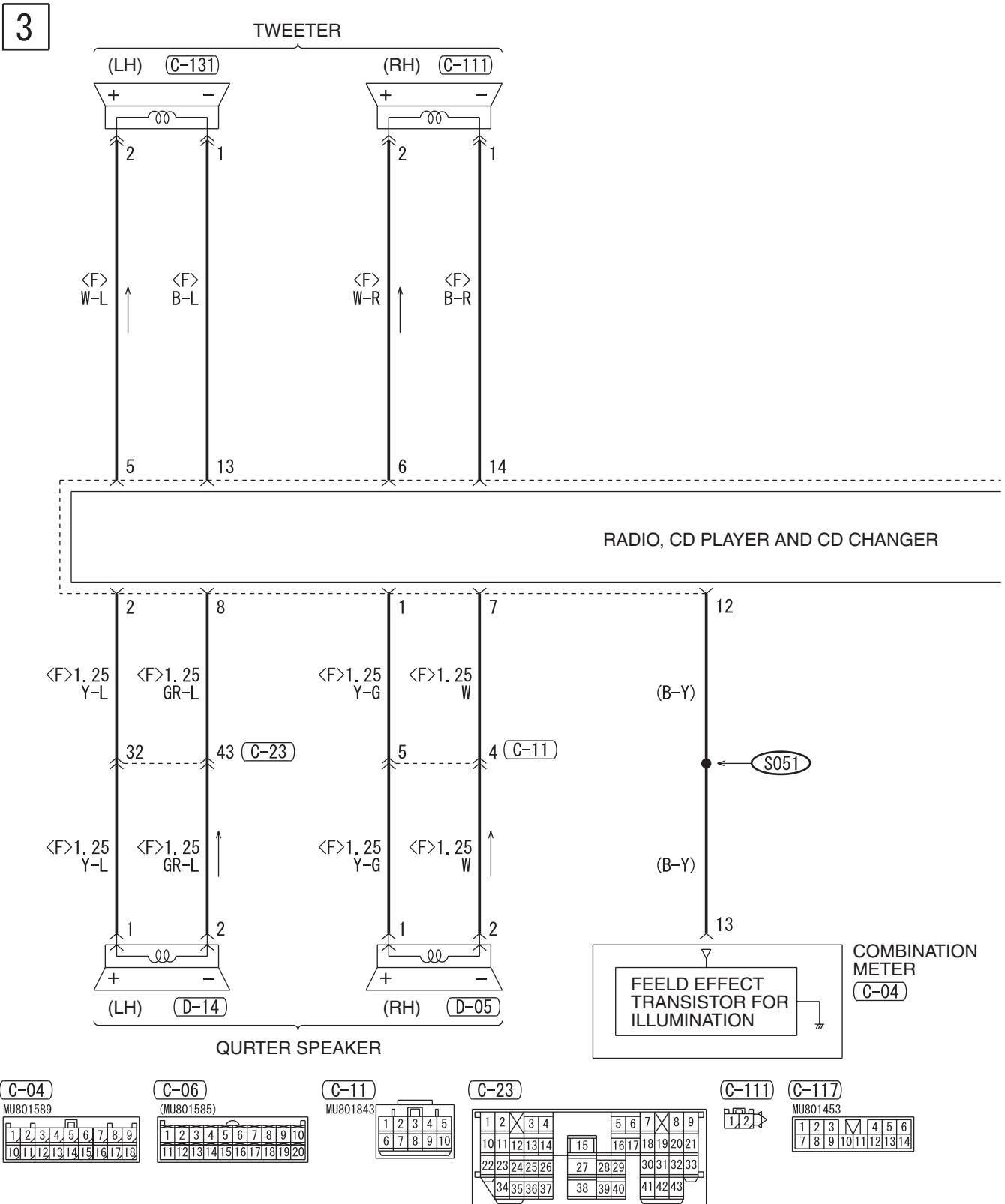

4

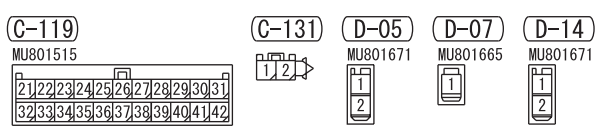
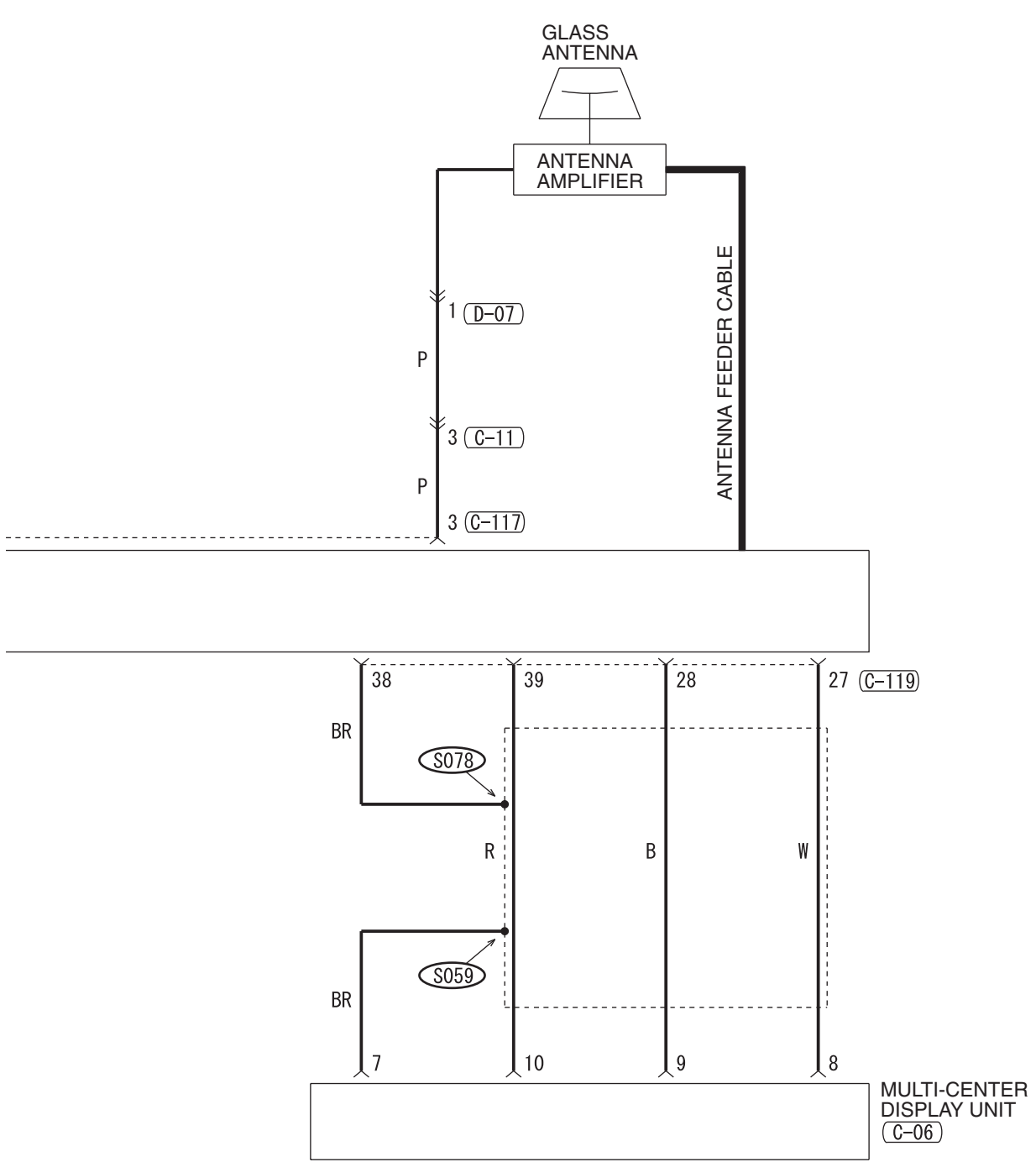

WIRE COLOR CODE
 B: BLACK LG: LIGHT GREEN G: GREEN L: BLUE W: WHITE Y: YELLOW SB: SKY BLUE
 BR: BROWN O: ORANGE GR: GRAY R: RED P: PINK V: VIOLET PU: PURPLE

H6P14M01BB

AUDIO SYSTEM <VEHICLES WITH AUDIO AMPLIFIER> (CONTINUED)

5

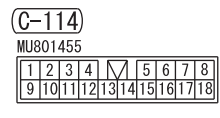
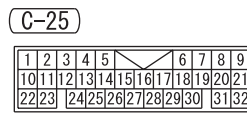
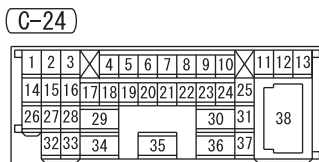
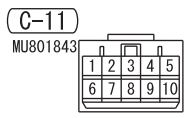
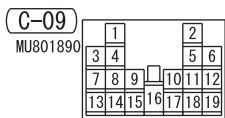
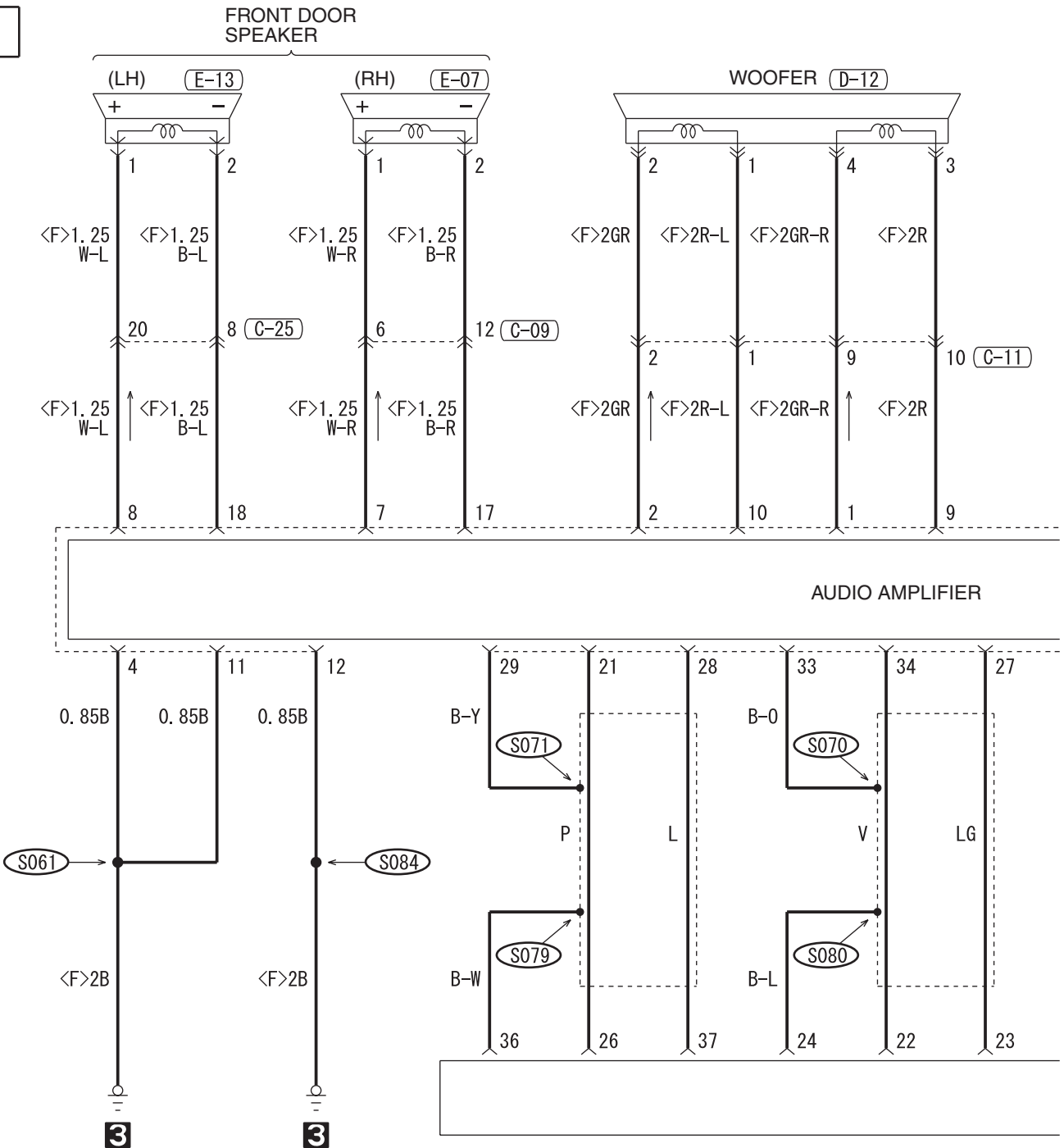

6

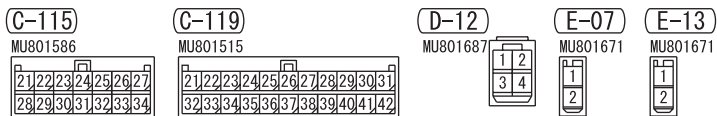
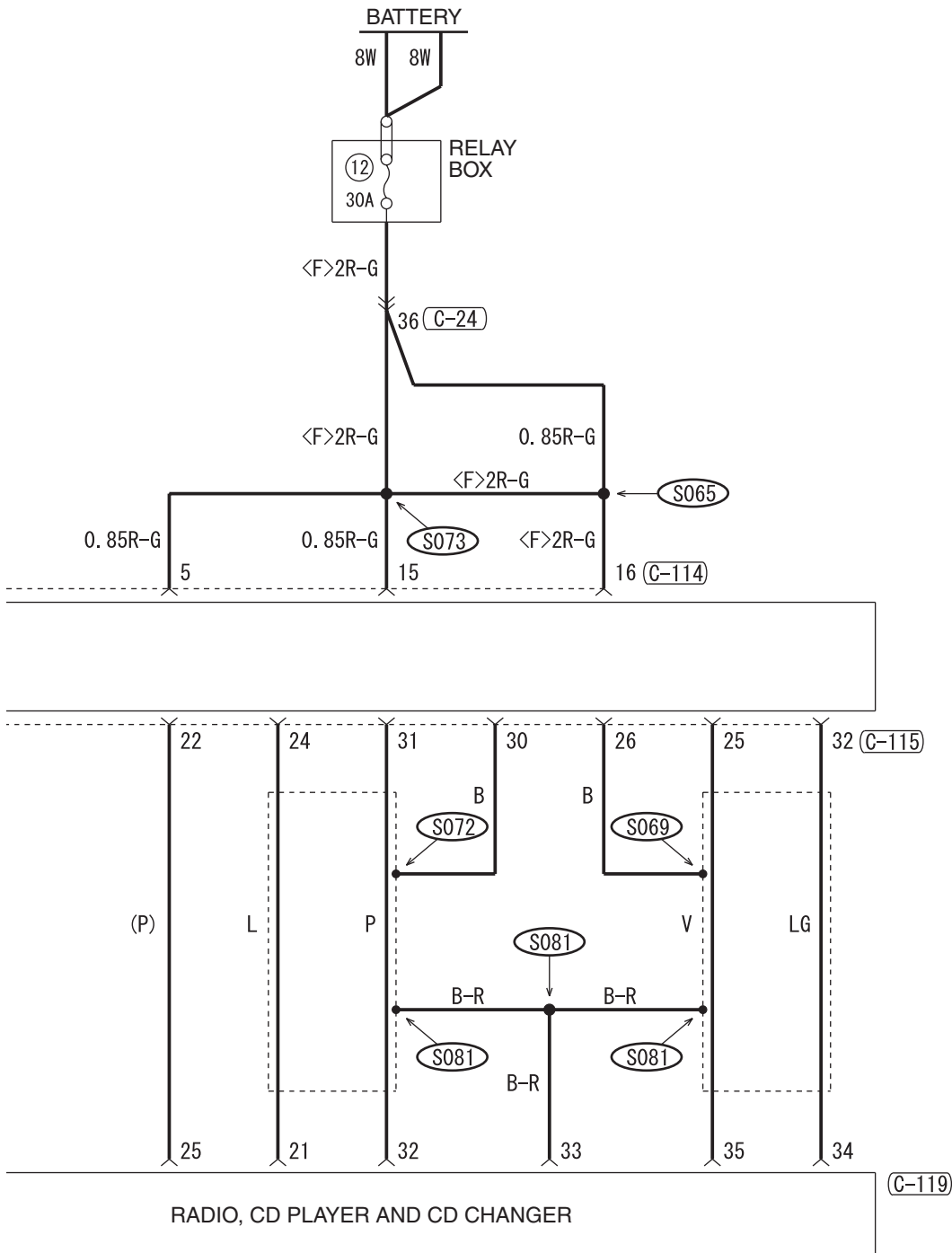

WIRE COLOR CODE
 B : BLACK LG : LIGHT GREEN G : GREEN L : BLUE W : WHITE Y : YELLOW SB : SKY BLUE
 BR : BROWN O : ORANGE GR : GRAY R : RED P : PINK V : VIOLET PU : PURPLE

H6P14M01CB

ACCESSORY SOCKET

M1901019100337

1

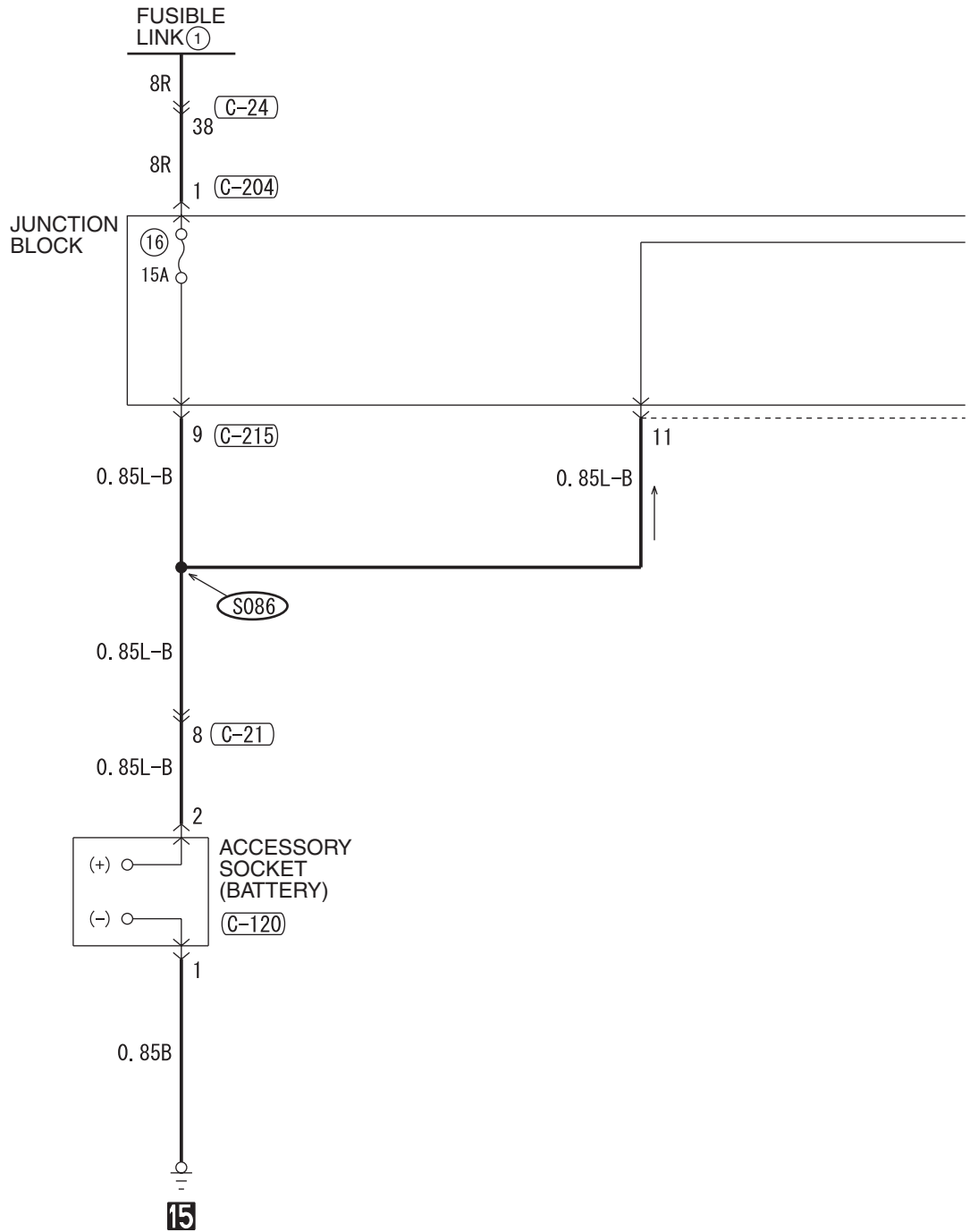

(C-01)



(C-13)



(C-21)

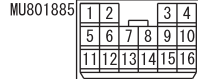

(C-24)

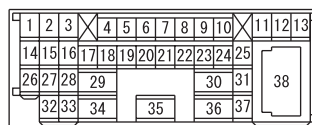

(C-120)



(C-201)

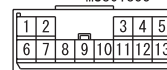

MU801855

(C-204)



MU801403

H6P14M02AA

2

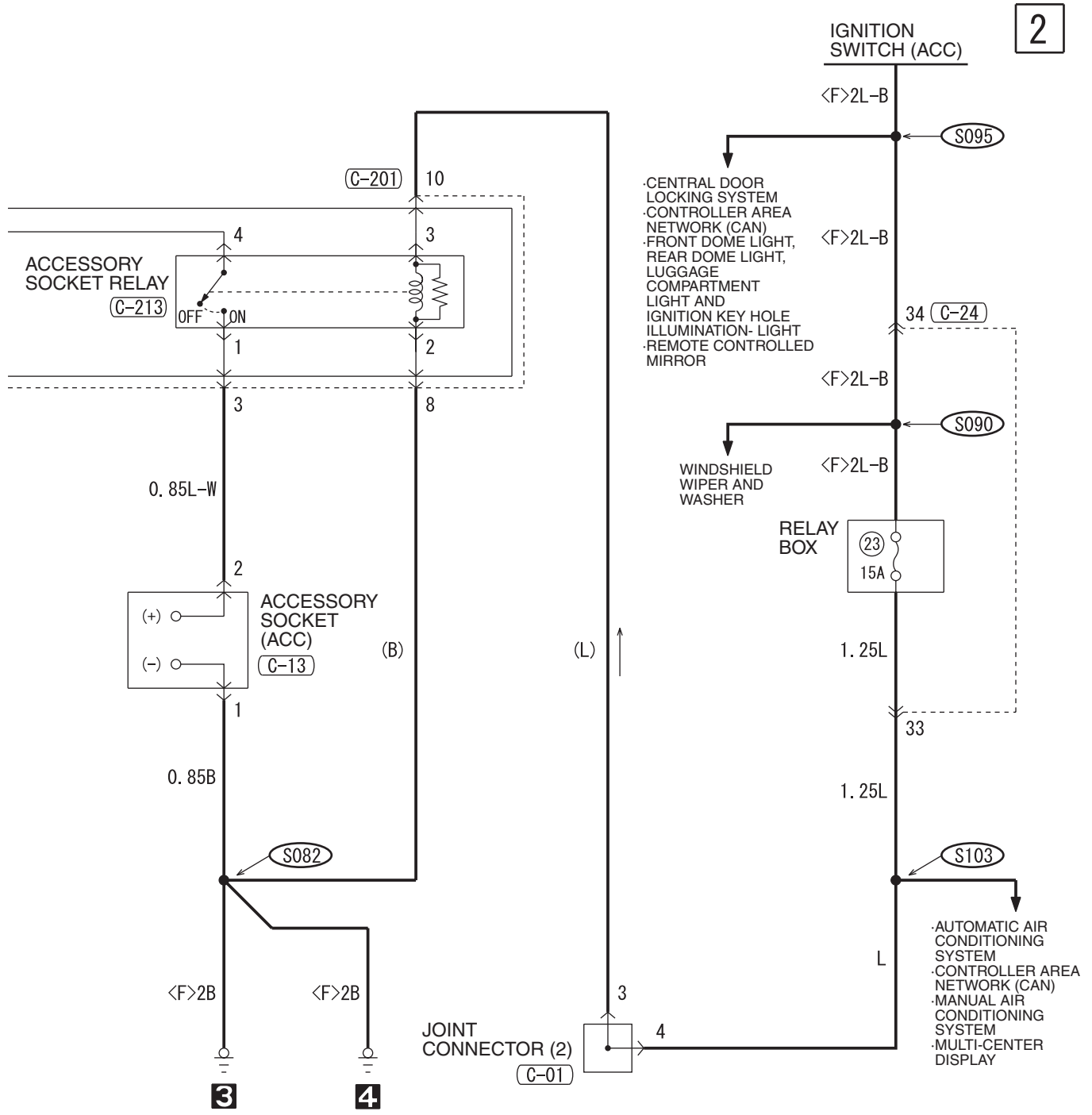

(C-213) (C-215)

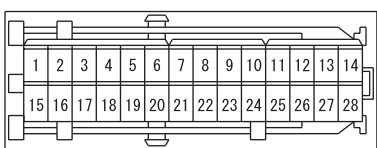

WIRE COLOR CODE
 B : BLACK LG : LIGHT GREEN G : GREEN L : BLUE
 BR : BROWN O : ORANGE GR : GRAY R : RED W : WHITE
 SB : SKY BLUE P : PINK Y : YELLOW V : VIOLET PU : PURPLE

MULTI-CENTER DISPLAY

1

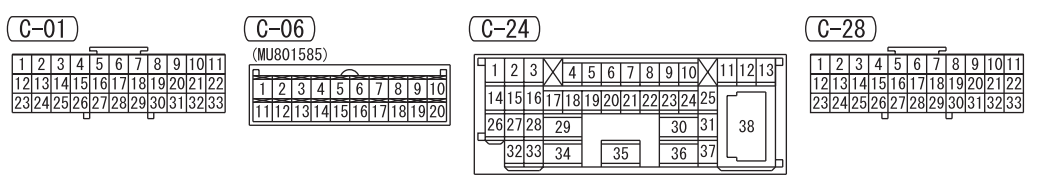
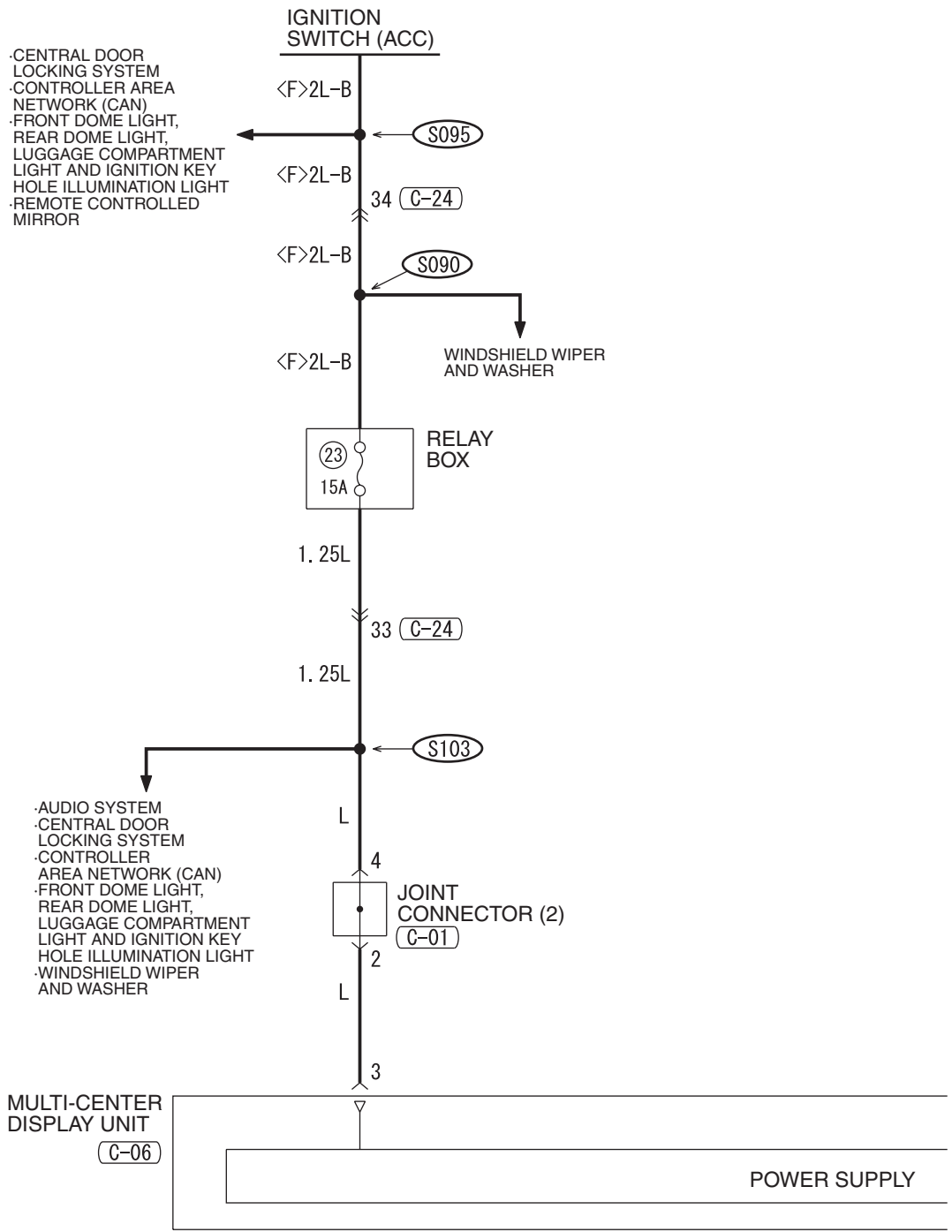

2

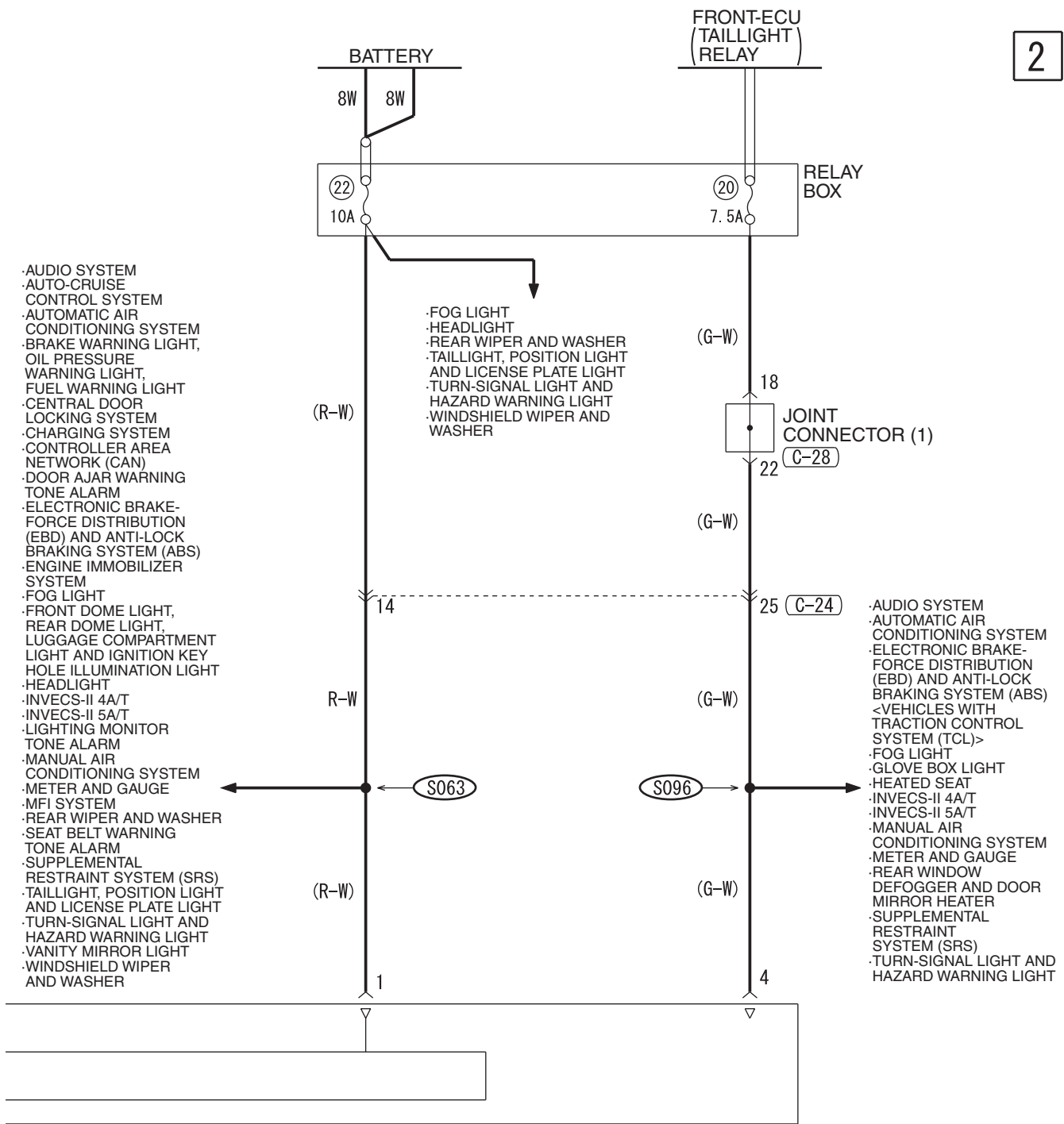

WIRE COLOR CODE
 B: BLACK LG: LIGHT GREEN G: GREEN L: BLUE W: WHITE Y: YELLOW SB: SKY BLUE
 BR: BROWN O: ORANGE GR: GRAY R: RED P: PINK V: VIOLET PU: PURPLE

H6P14M03AB

MULTI-CENTER DISPLAY (CONTINUED)

3

<TYPE 1>

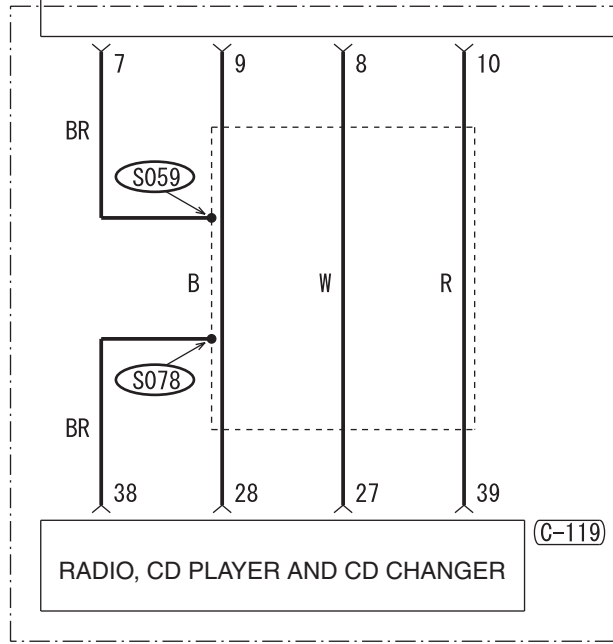
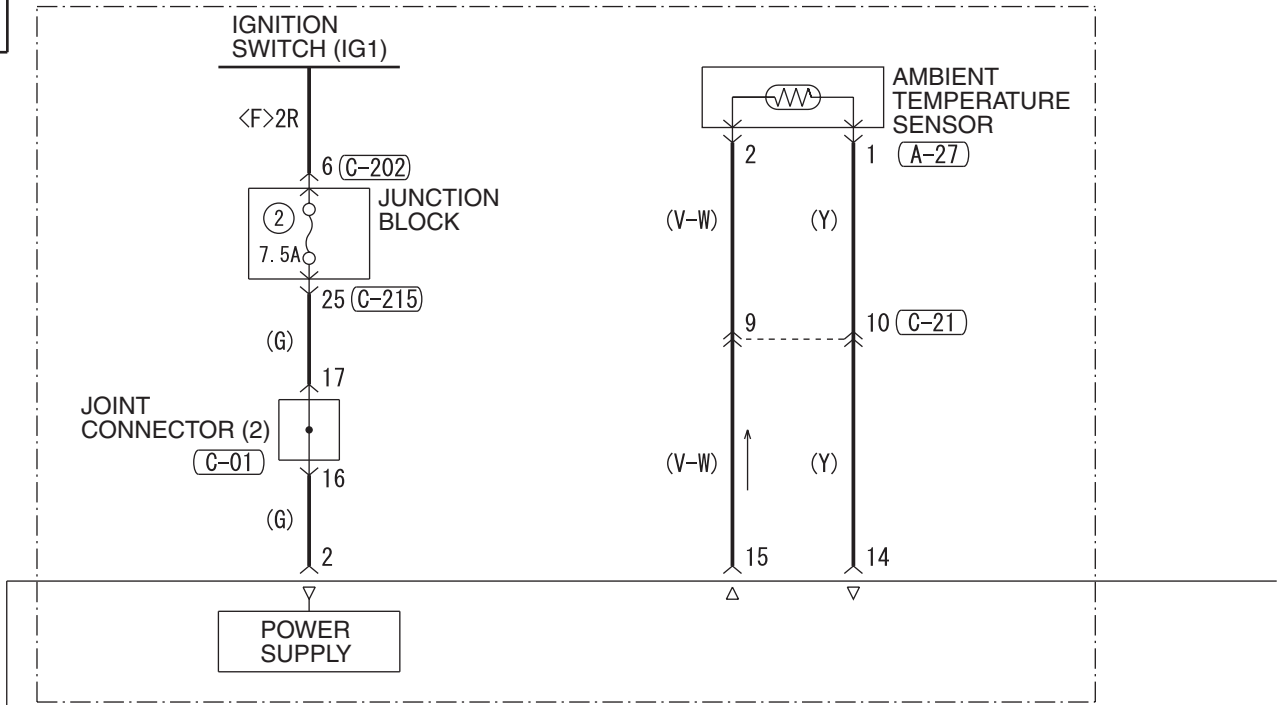

RADIO, CD PLAYER AND CD CHANGER (C-119)

<VEHICLES WITH AUDIO AMPLIFIER>

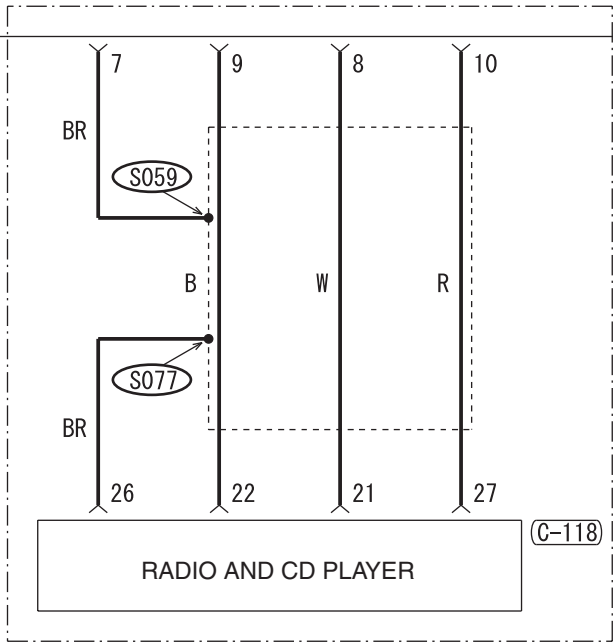

RADIO AND CD PLAYER (C-118)

<VEHICLES WITHOUT AUDIO AMPLIFIER>

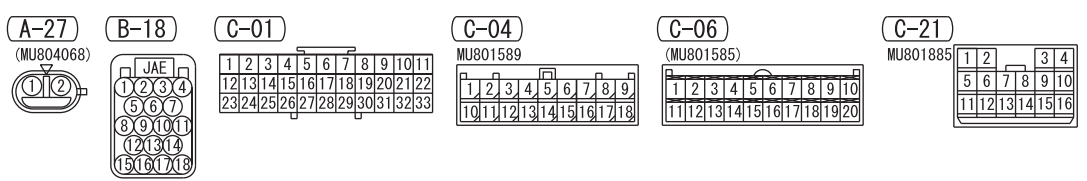

4

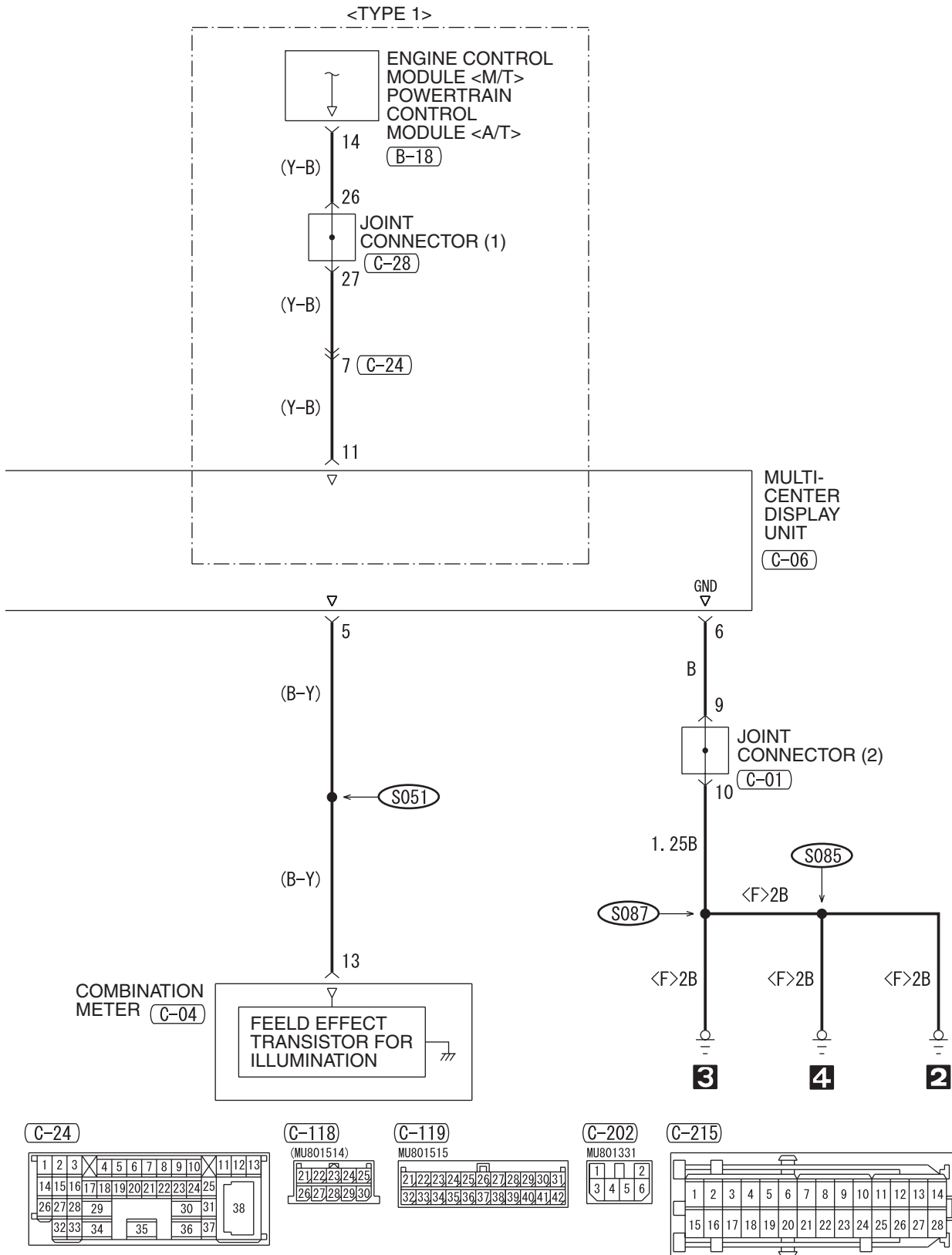

SUNROOF

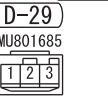
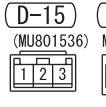
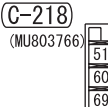
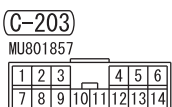
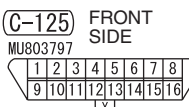
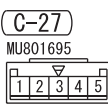
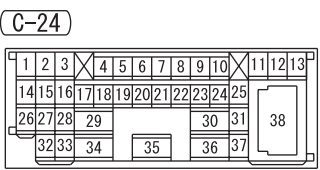
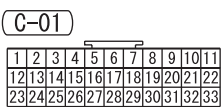
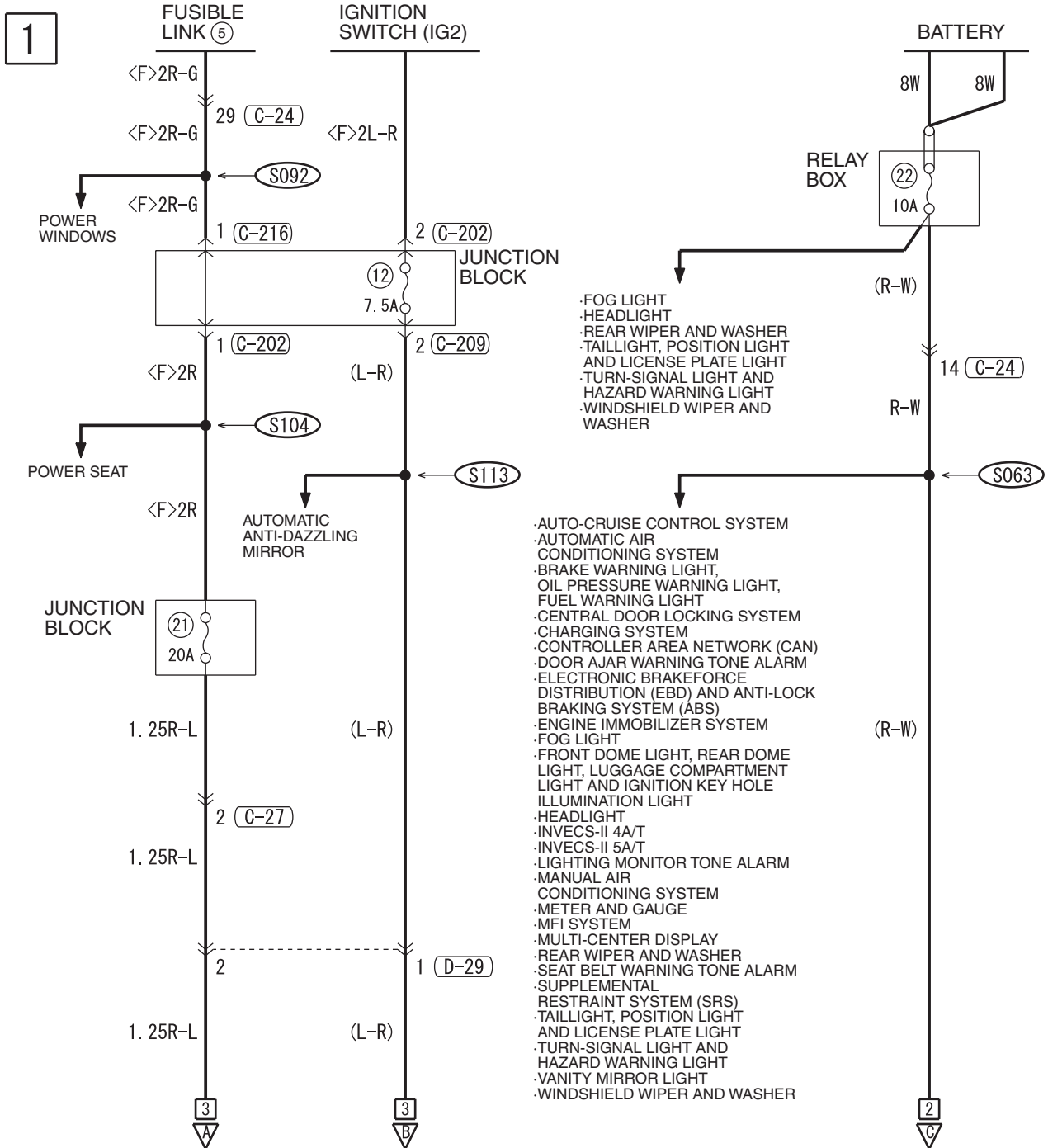

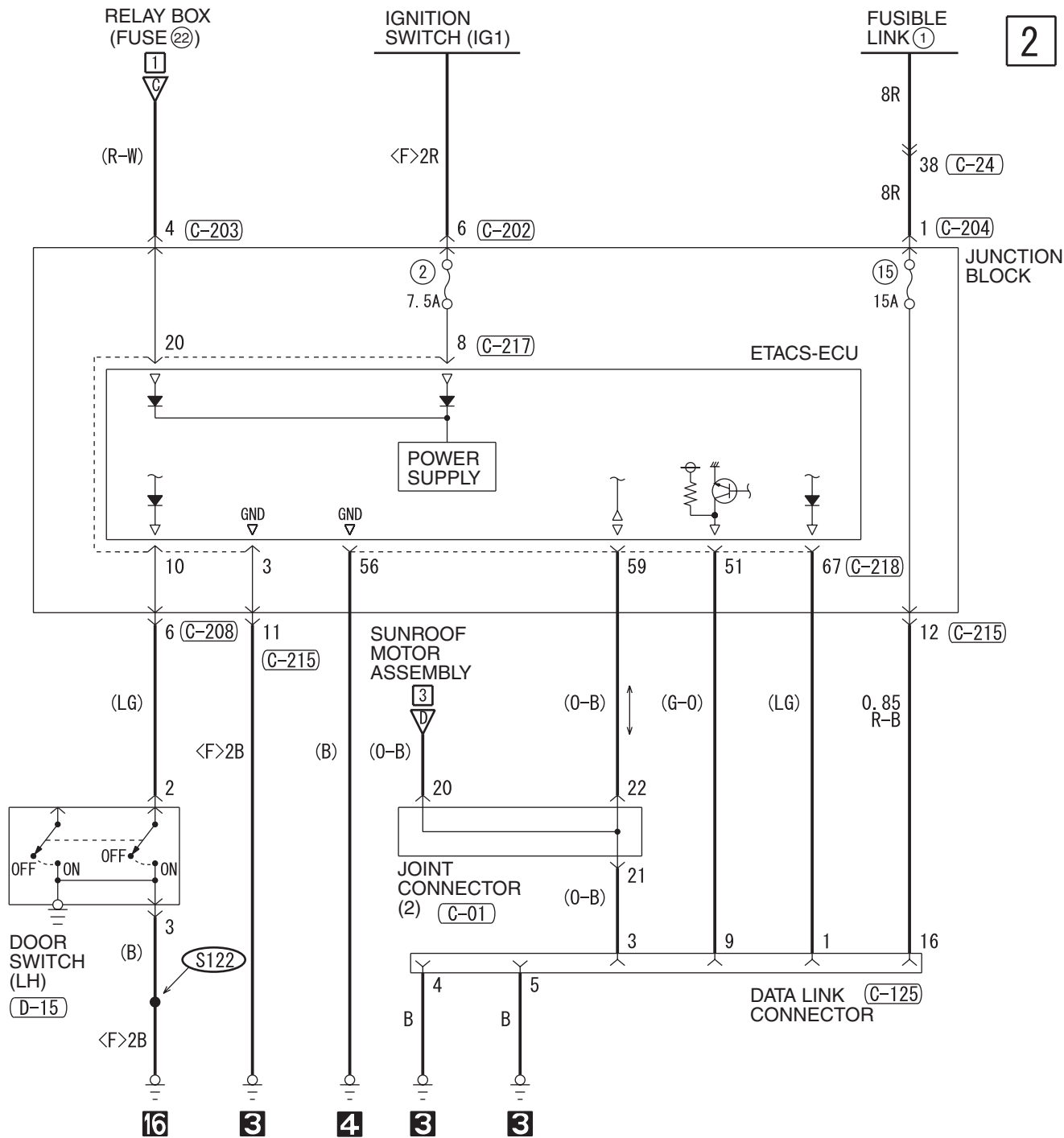

(C-208)

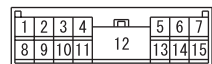

(C-209)



(C-215)

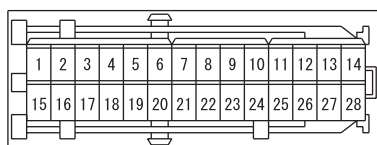

(C-216)



(C-217)

JUNCTION BLOCK SIDE

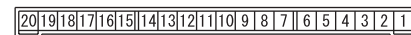

WIRE COLOR CODE

B: BLACK LG: LIGHT GREEN G: GREEN L: BLUE W: WHITE Y: YELLOW SB: SKY BLUE
BR: BROWN O: ORANGE GR: GRAY R: RED P: PINK V: VIOLET PU: PURPLE

H6P15M00AB

SUNROOF (CONTINUED)

3

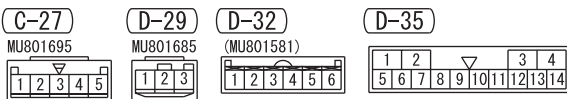
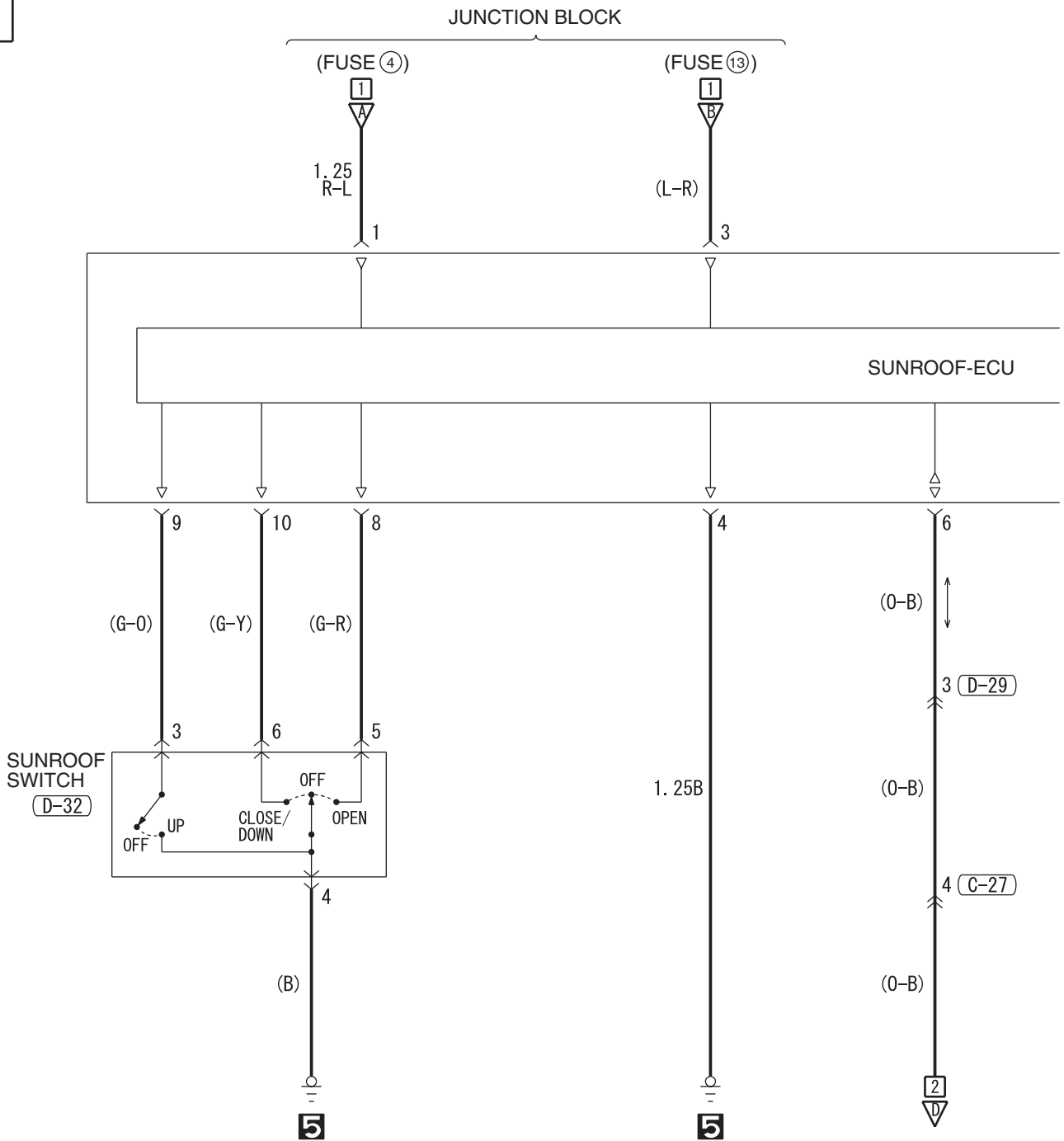

SUNROOF MOTOR ASSEMBLY (D-35)

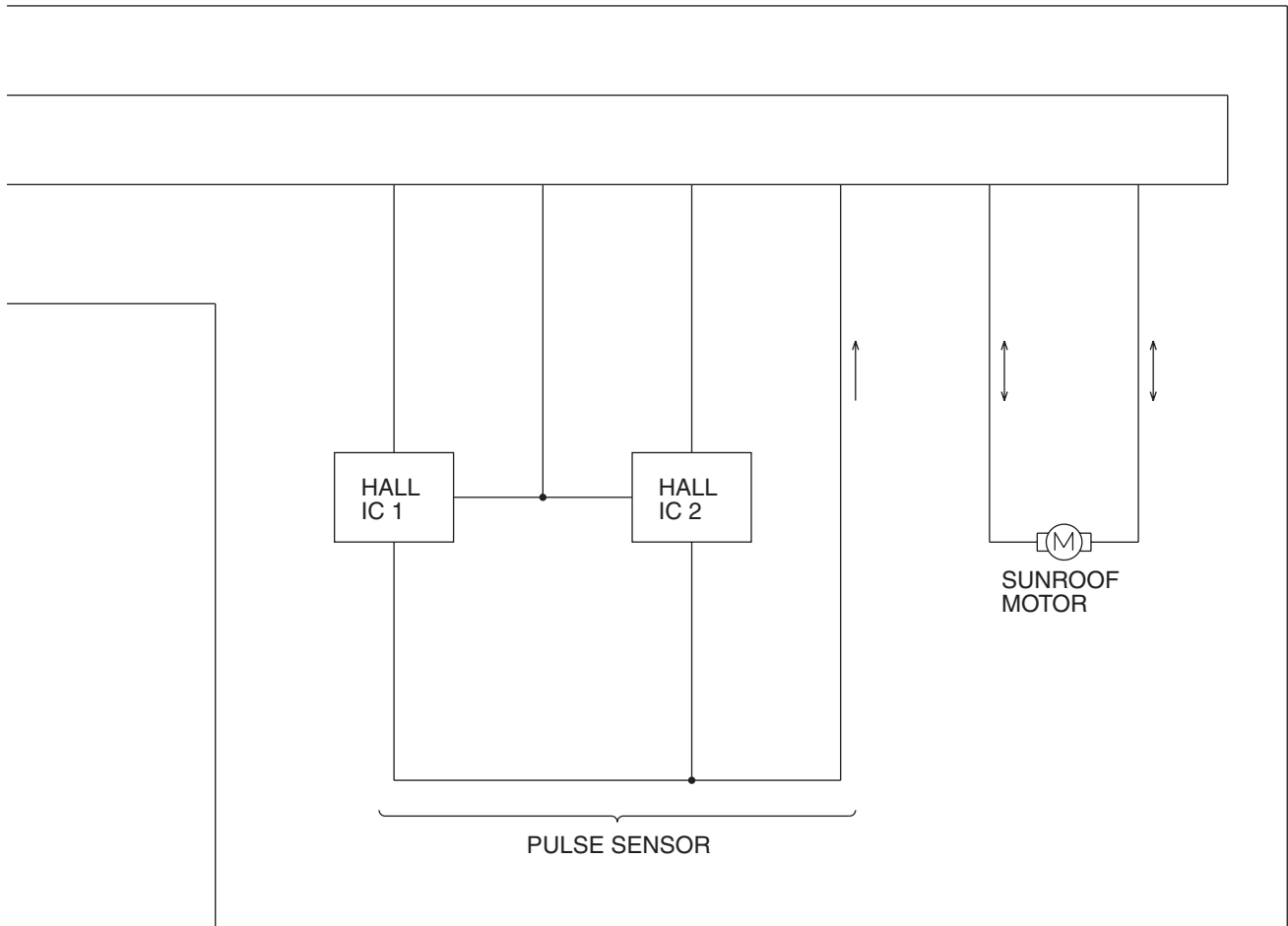

WIRE COLOR CODE
B: BLACK LG: LIGHT GREEN G: GREEN L: BLUE W: WHITE Y: YELLOW SB: SKY BLUE
BR: BROWN O: ORANGE GR: GRAY R: RED P: PINK V: VIOLET PU: PURPLE

H6P15M00BB

TSB Revision

AUTO-CRUISE CONTROL SYSTEM <2.4L ENGINE-M/T>

M1901009301850

1

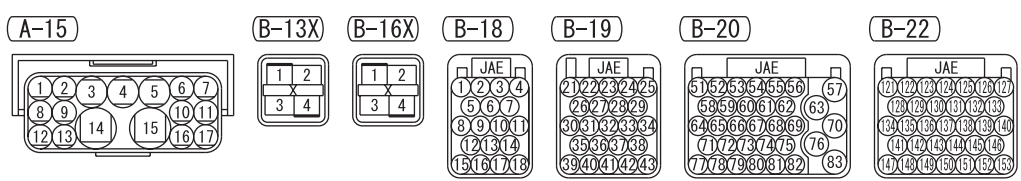
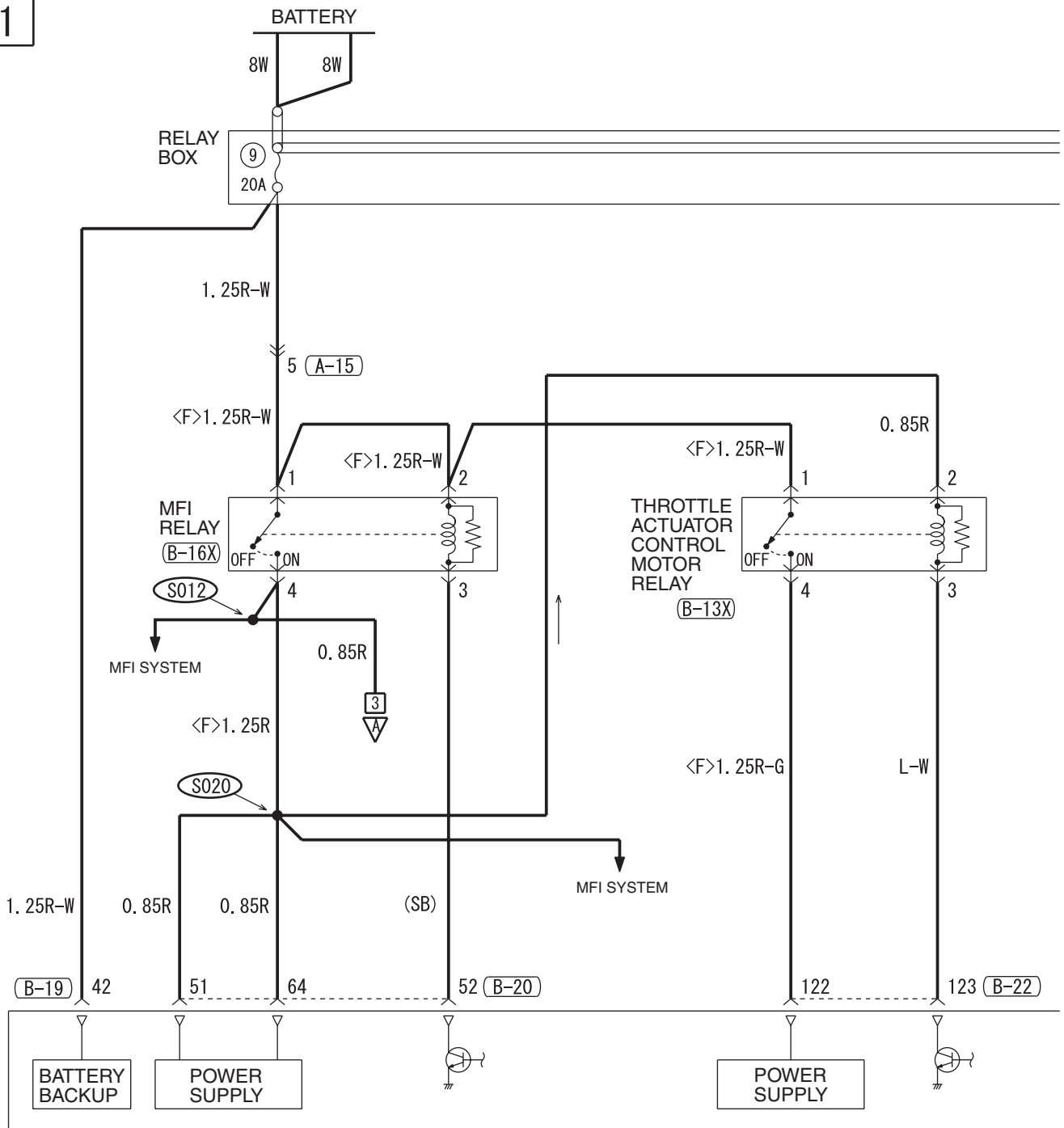

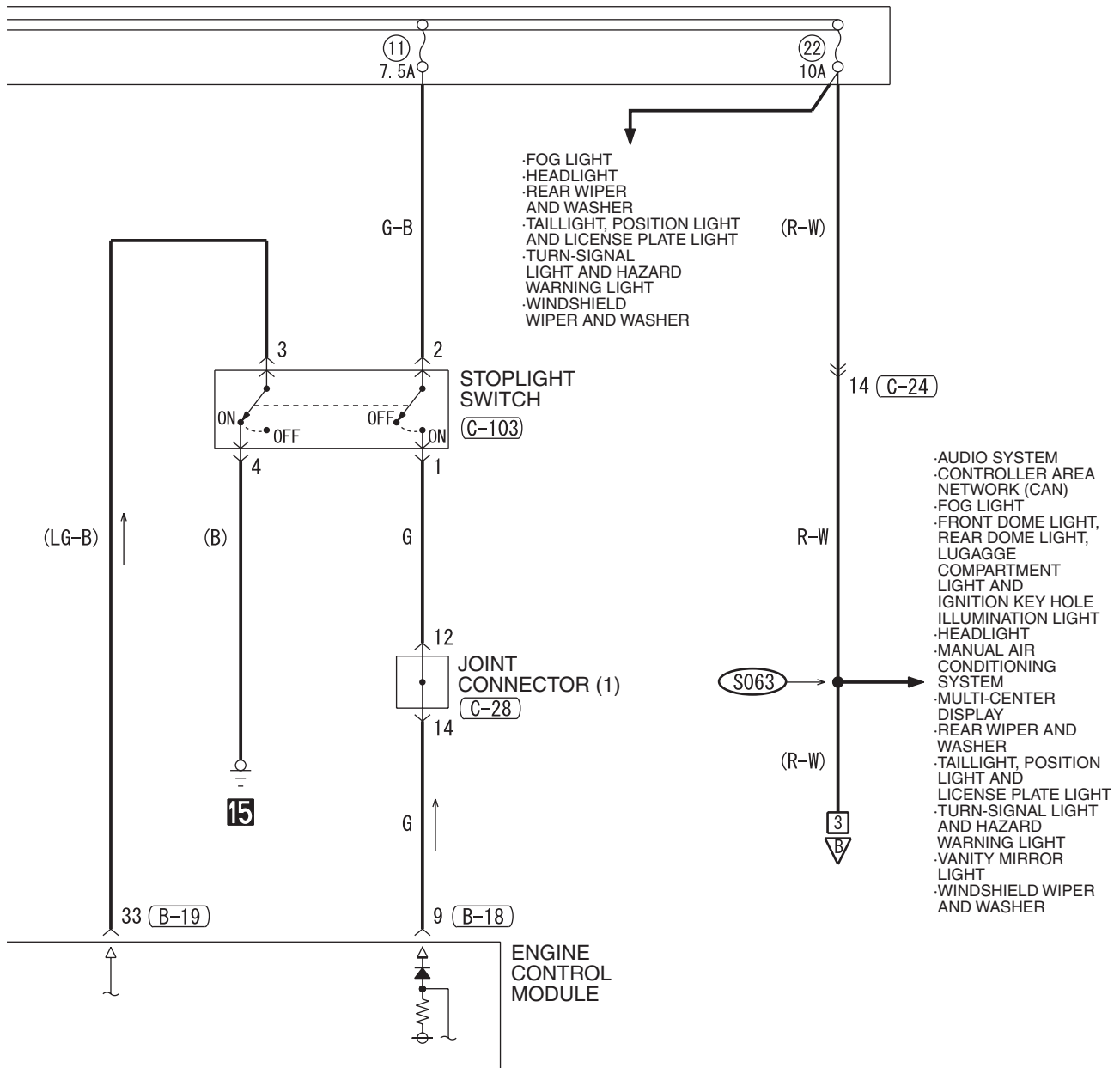

(C-24)

1	2	3	4	5	6	7	8	9	10	11	12	13
14	15	16	17	18	19	20	21	22	23	24	25	38
26	27	28	29	30	31	32	33	34	35	36	37	

(C-28)

1	2	3	4	5	6	7	8	9	10	11
12	13	14	15	16	17	18	19	20	21	22
23	24	25	26	27	28	29	30	31	32	33

(C-103)

MU801491			
1	2		
3	4		

WIRE COLOR CODE

B : BLACK LG : LIGHT GREEN G : GREEN L : BLUE
 BR : BROWN O : ORANGE GR : GRAY R : RED W : WHITE
 SB : SKY BLUE P : PINK Y : YELLOW V : VIOLET PU : PURPLE

H6P15M01AB

AUTO-CRUISE CONTROL SYSTEM <2.4L ENGINE-M/T> (CONTINUED)

3

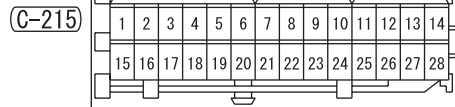
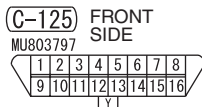
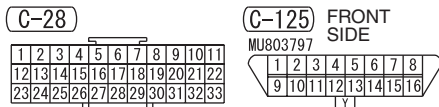
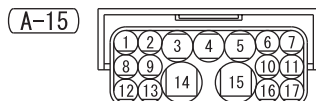
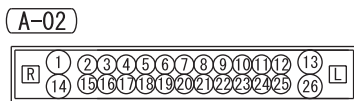
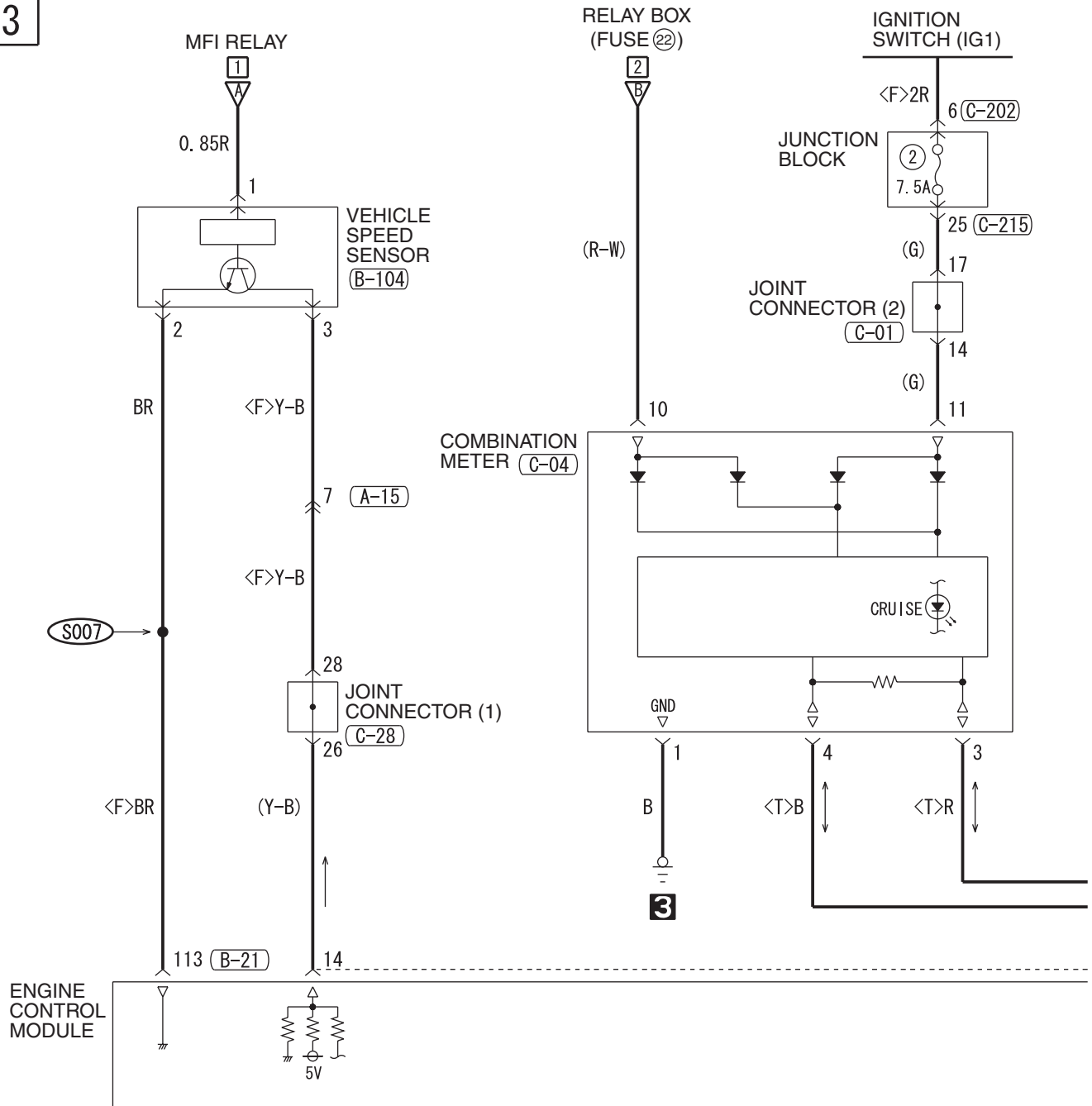

H6P15M01BA

4

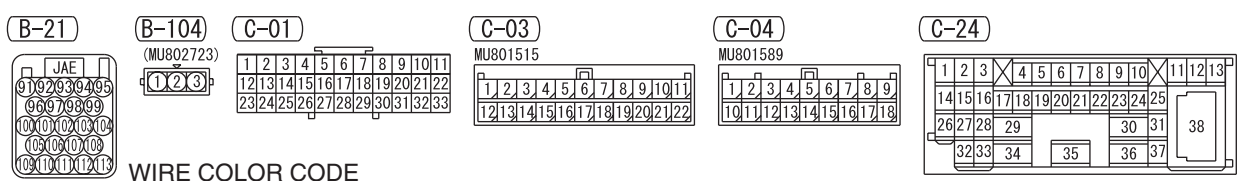
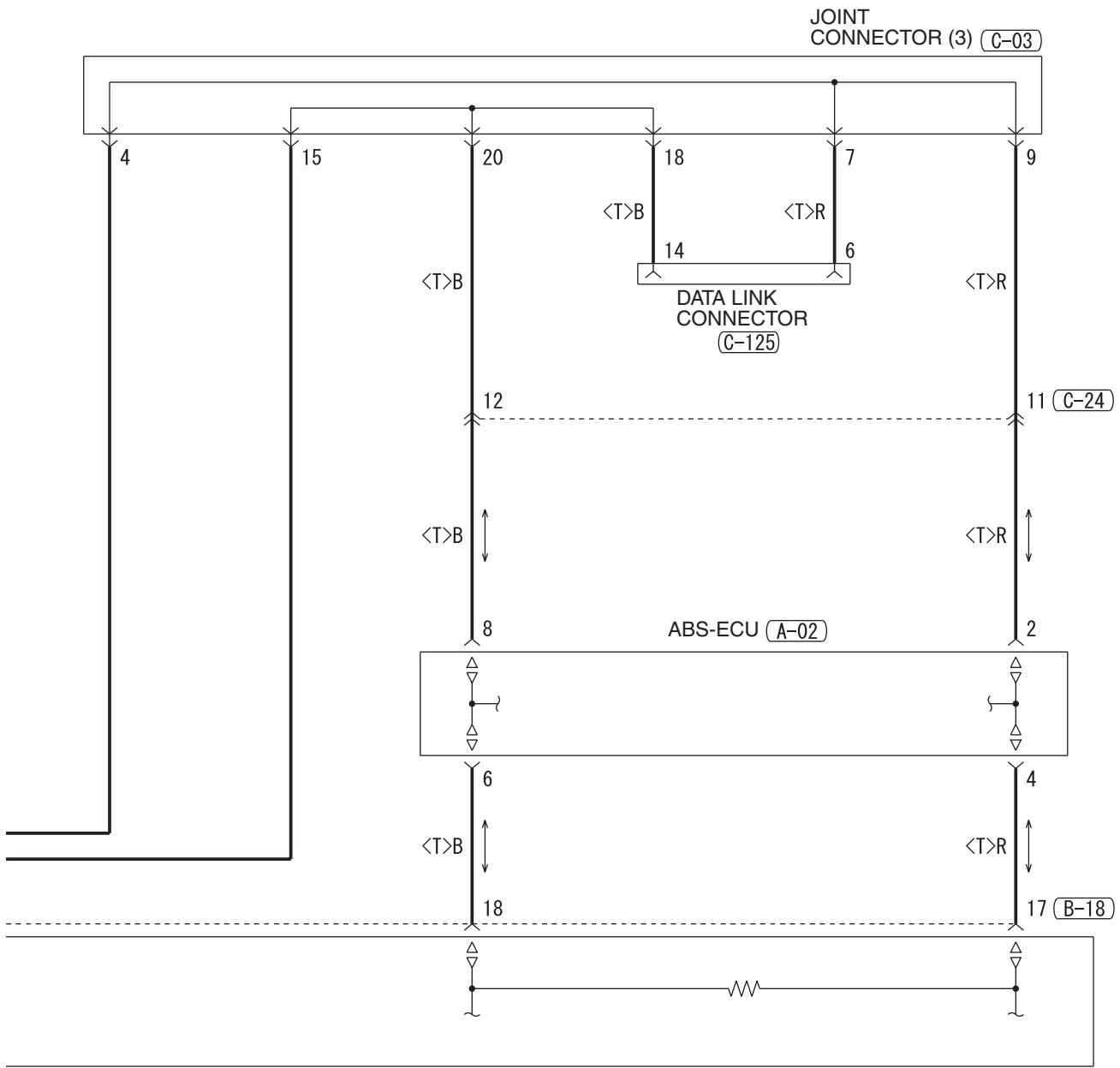

WIRE COLOR CODE
 B: BLACK LG: LIGHT GREEN G: GREEN L: BLUE W: WHITE Y: YELLOW SB: SKY BLUE
 BR: BROWN O: ORANGE GR: GRAY R: RED P: PINK V: VIOLET PU: PURPLE H6P15M01BB

TSB Revision

AUTO-CRUISE CONTROL SYSTEM <2.4L ENGINE-M/T> (CONTINUED)

5

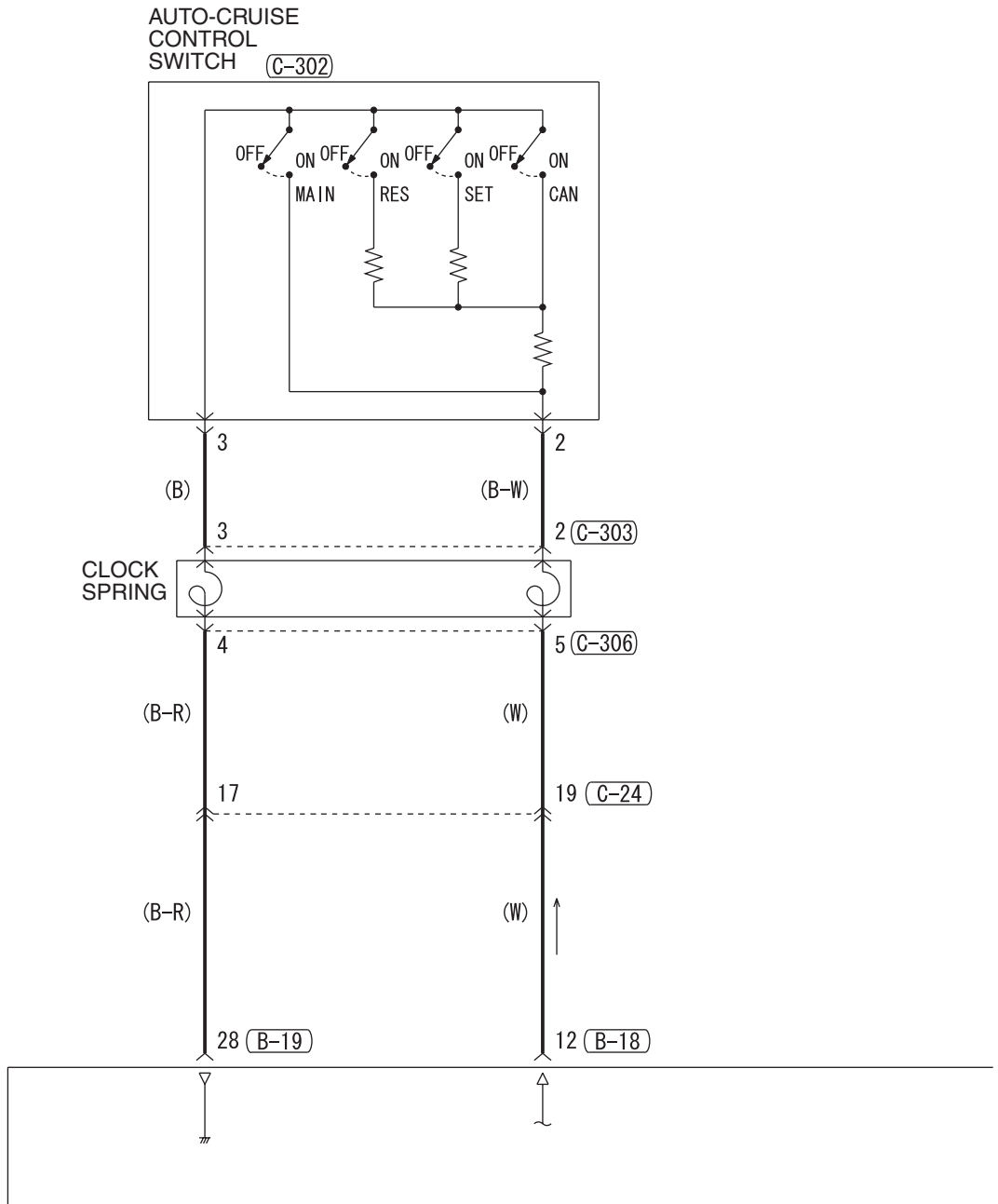

(B-18)

(B-19)

(C-24)

(C-129)

(C-302)

(C-303)

(C-306)

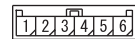
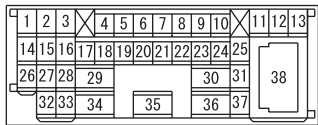
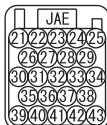
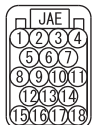

6

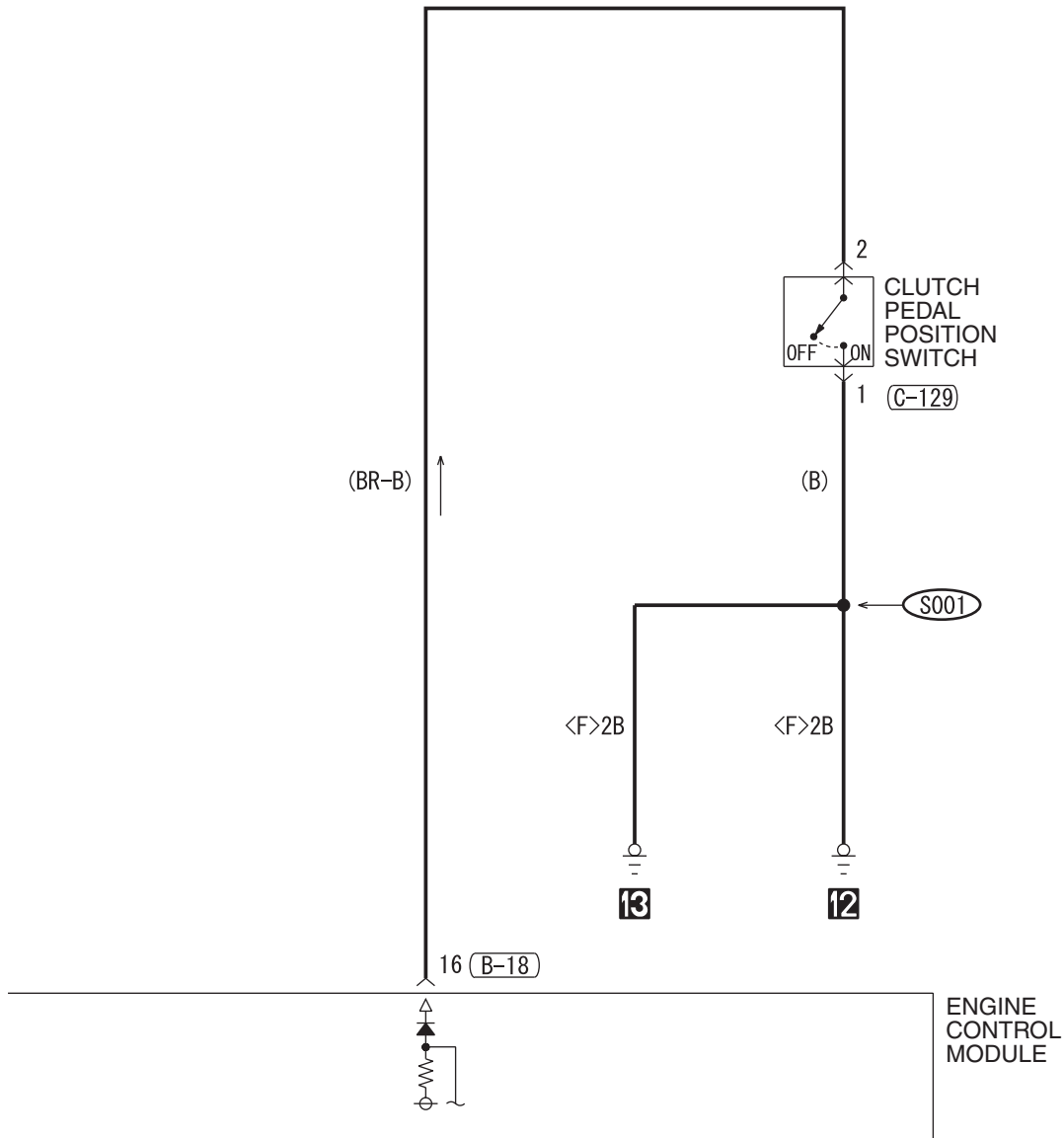

WIRE COLOR CODE
 B: BLACK LG: LIGHT GREEN G: GREEN L: BLUE W: WHITE Y: YELLOW SB: SKY BLUE
 BR: BROWN O: ORANGE GR: GRAY R: RED P: PINK V: VIOLET PU: PURPLE

H6P15M01CB

TSB Revision

AUTO-CRUISE CONTROL SYSTEM <2.4L ENGINE-M/T> (CONTINUED)

7

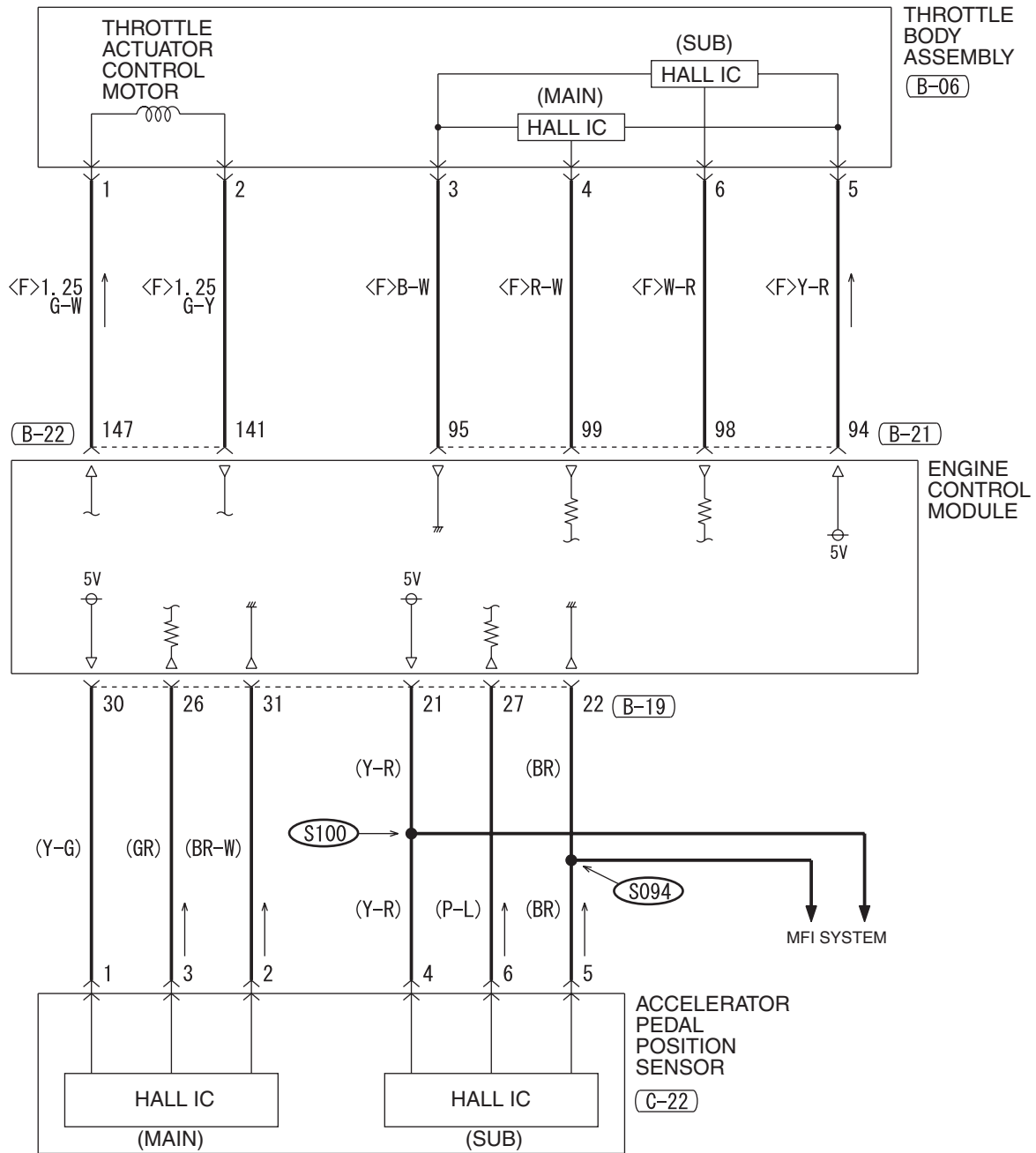

8

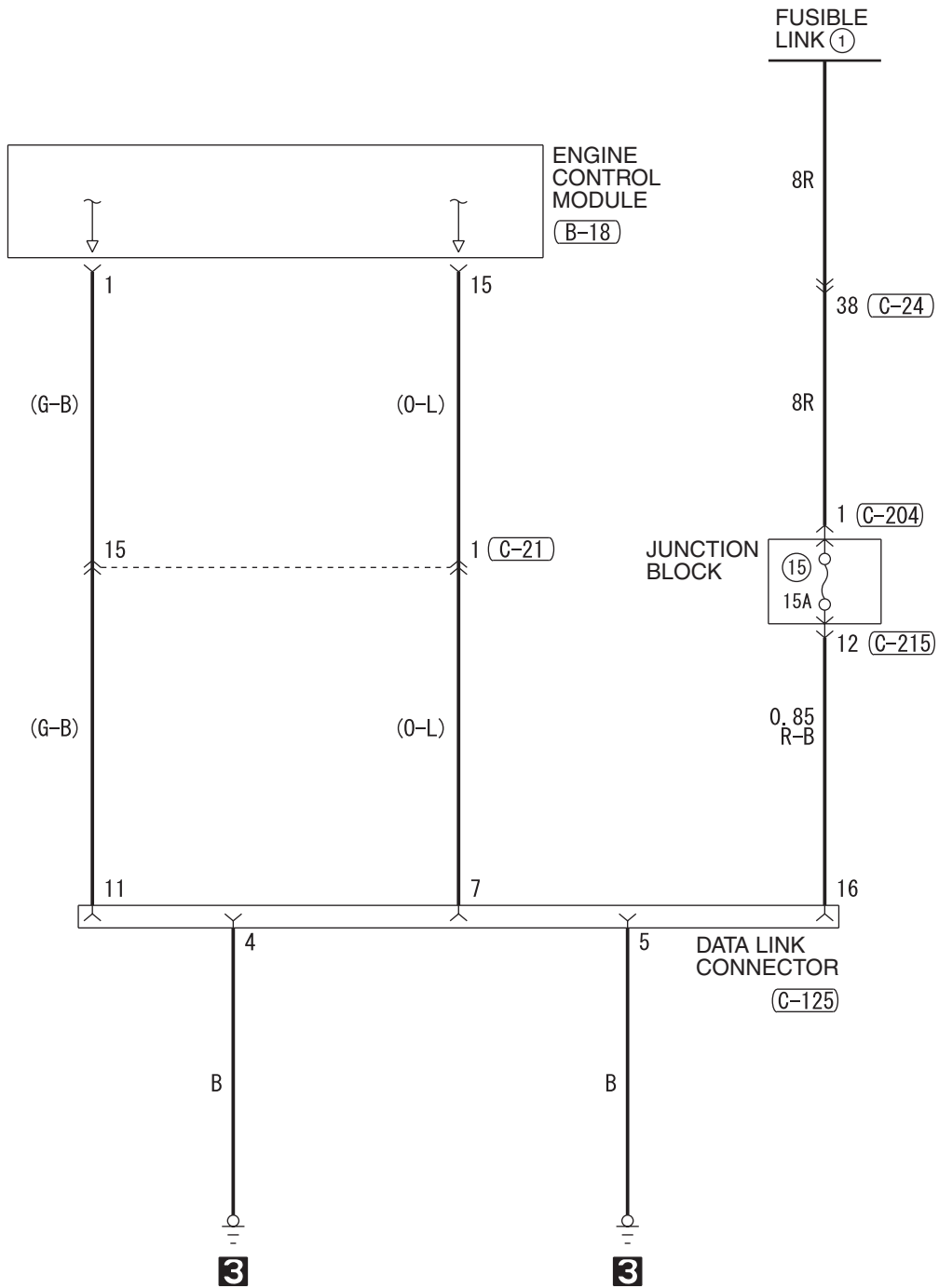

C-24

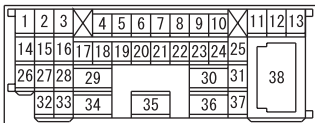

C-125 FRONT SIDE



C-204



C-215

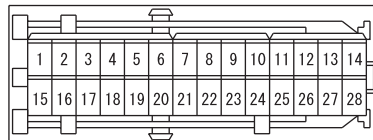

AUTO-CRUISE CONTROL SYSTEM <2.4L ENGINE-A/T>

M1901009301861

1

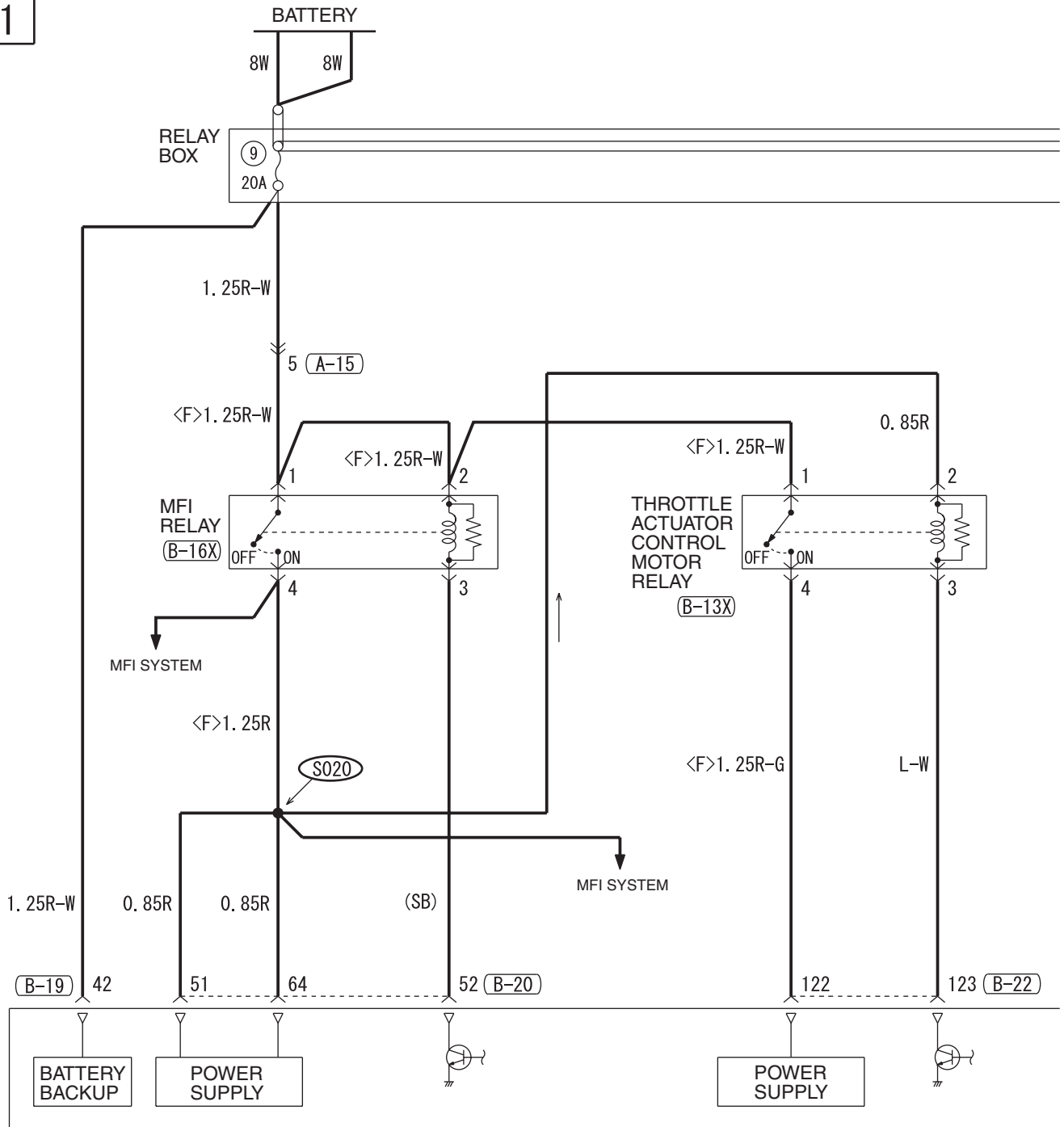

(A-15)

(B-13X)

(B-16X)

(B-18)

(B-19)

(B-20)

(B-22)

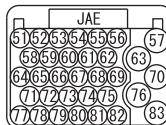
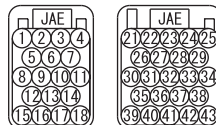
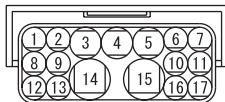

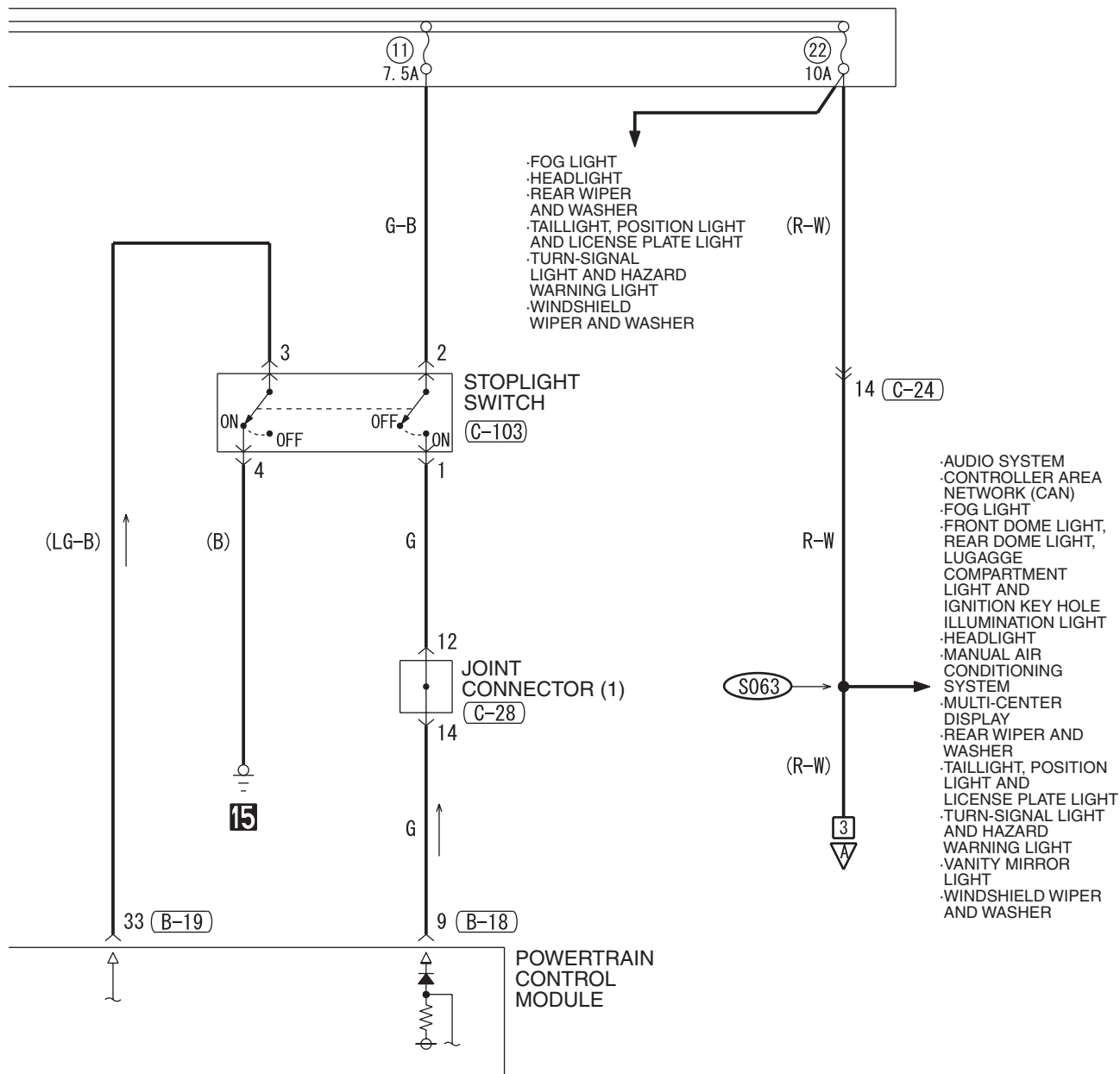

(C-24)

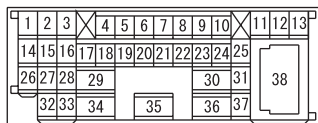

(C-28)



(C-103)



WIRE COLOR CODE
 B : BLACK LG : LIGHT GREEN G : GREEN L : BLUE
 BR : BROWN O : ORANGE GR : GRAY R : RED W : WHITE
 SB : SKY BLUE P : PINK Y : YELLOW V : VIOLET PU : PURPLE

H6P15M02AB

AUTO-CRUISE CONTROL SYSTEM <2.4L ENGINE-A/T> (CONTINUED)

3

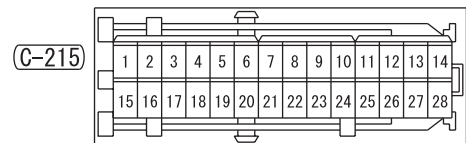
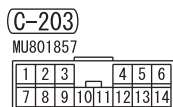
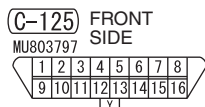
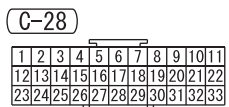
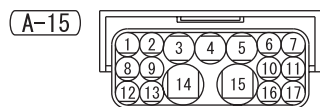
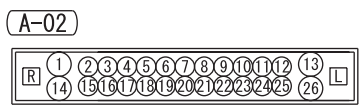
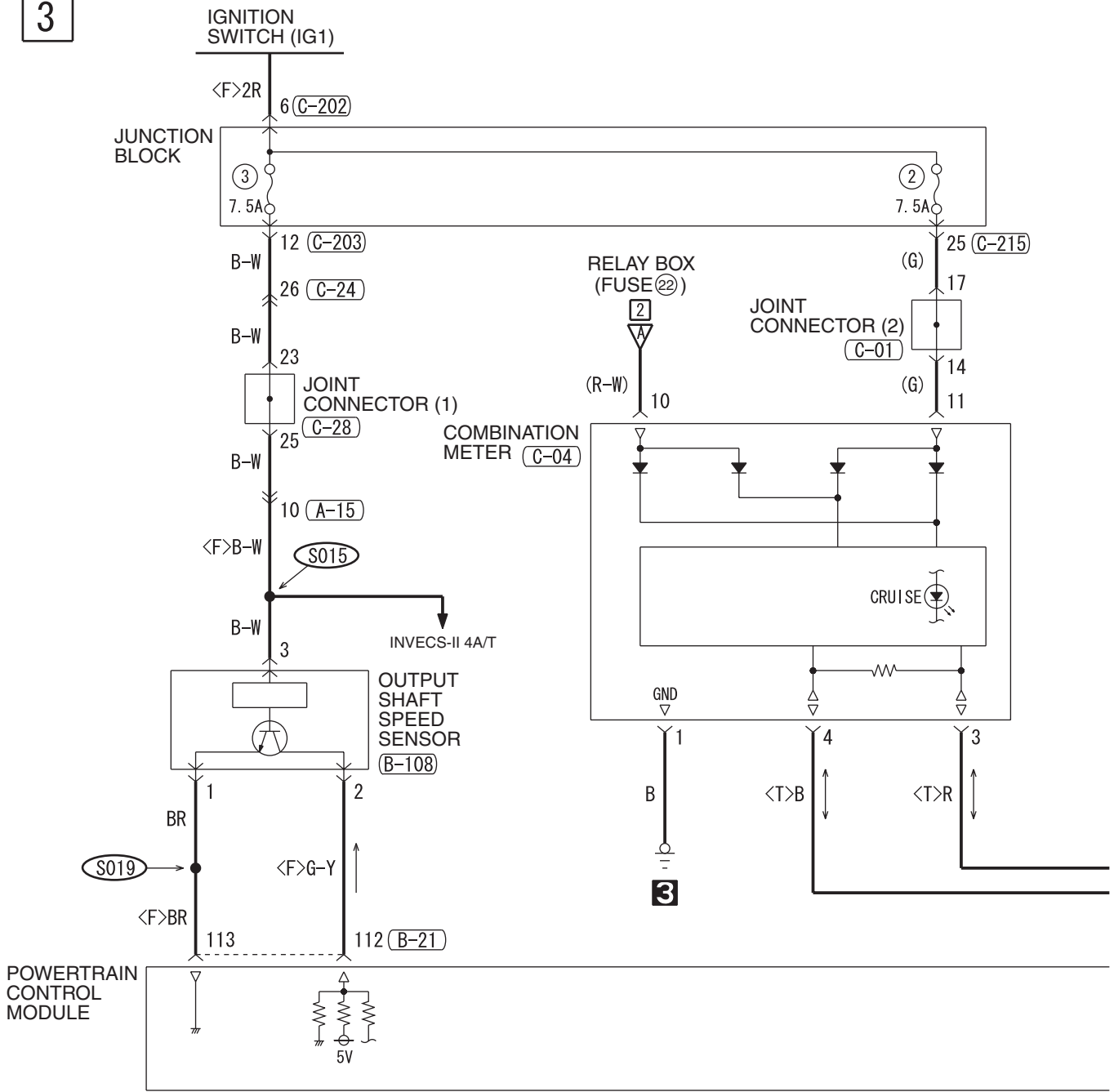

H6P15M02BA

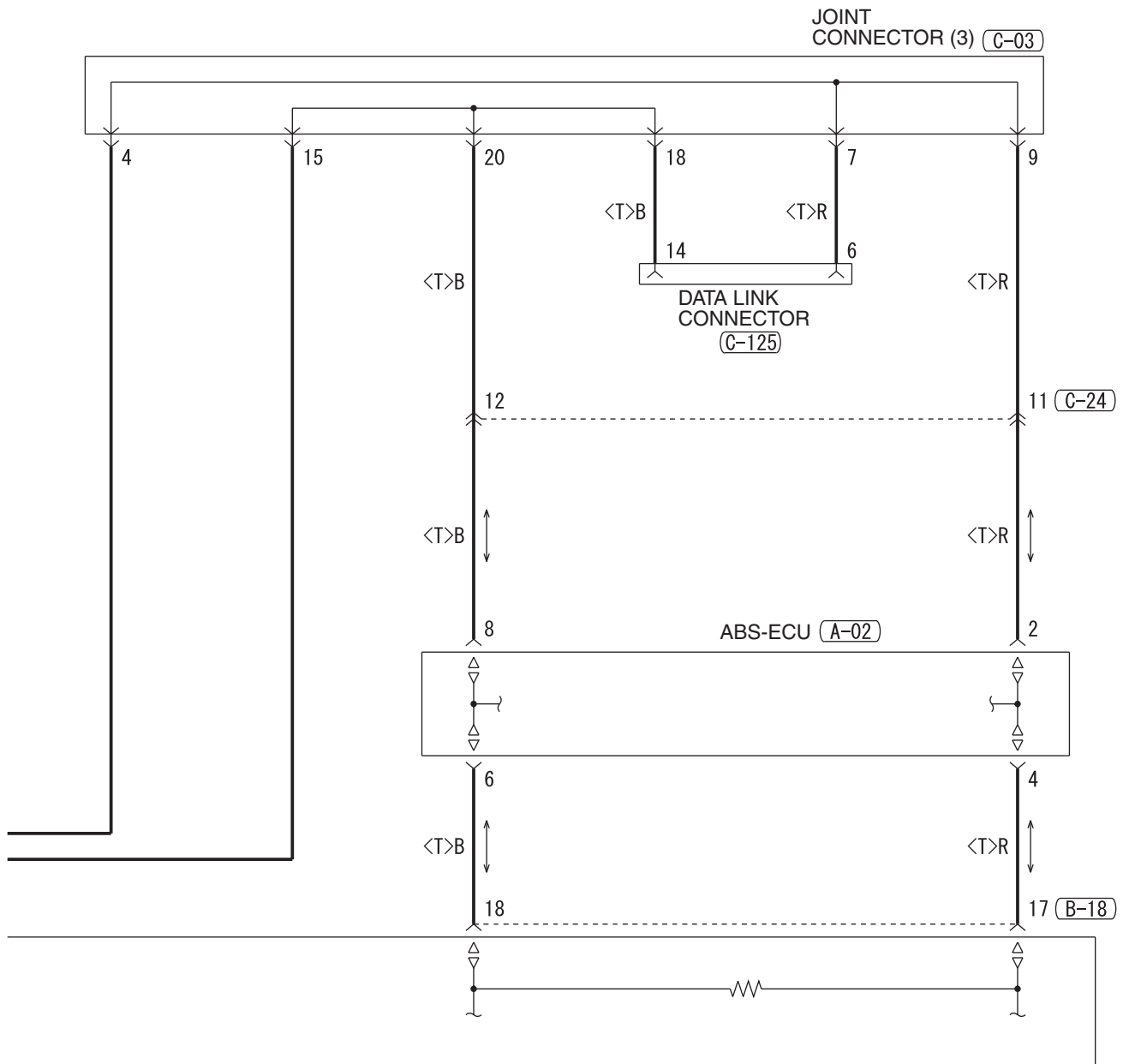

(B-21)

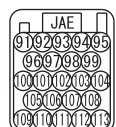

(B-108)



(C-01)

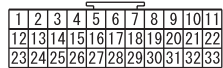

(C-03)

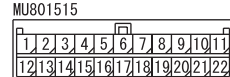

(C-04)

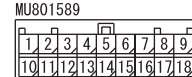

(C-24)

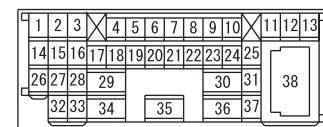

WIRE COLOR CODE

B : BLACK LG : LIGHT GREEN G : GREEN L : BLUE W : WHITE Y : YELLOW SB : SKY BLUE
 BR : BROWN O : ORANGE GR : GRAY R : RED P : PINK V : VIOLET PU : PURPLE H6P15M02BB

AUTO-CRUISE CONTROL SYSTEM <2.4L ENGINE-A/T> (CONTINUED)

5

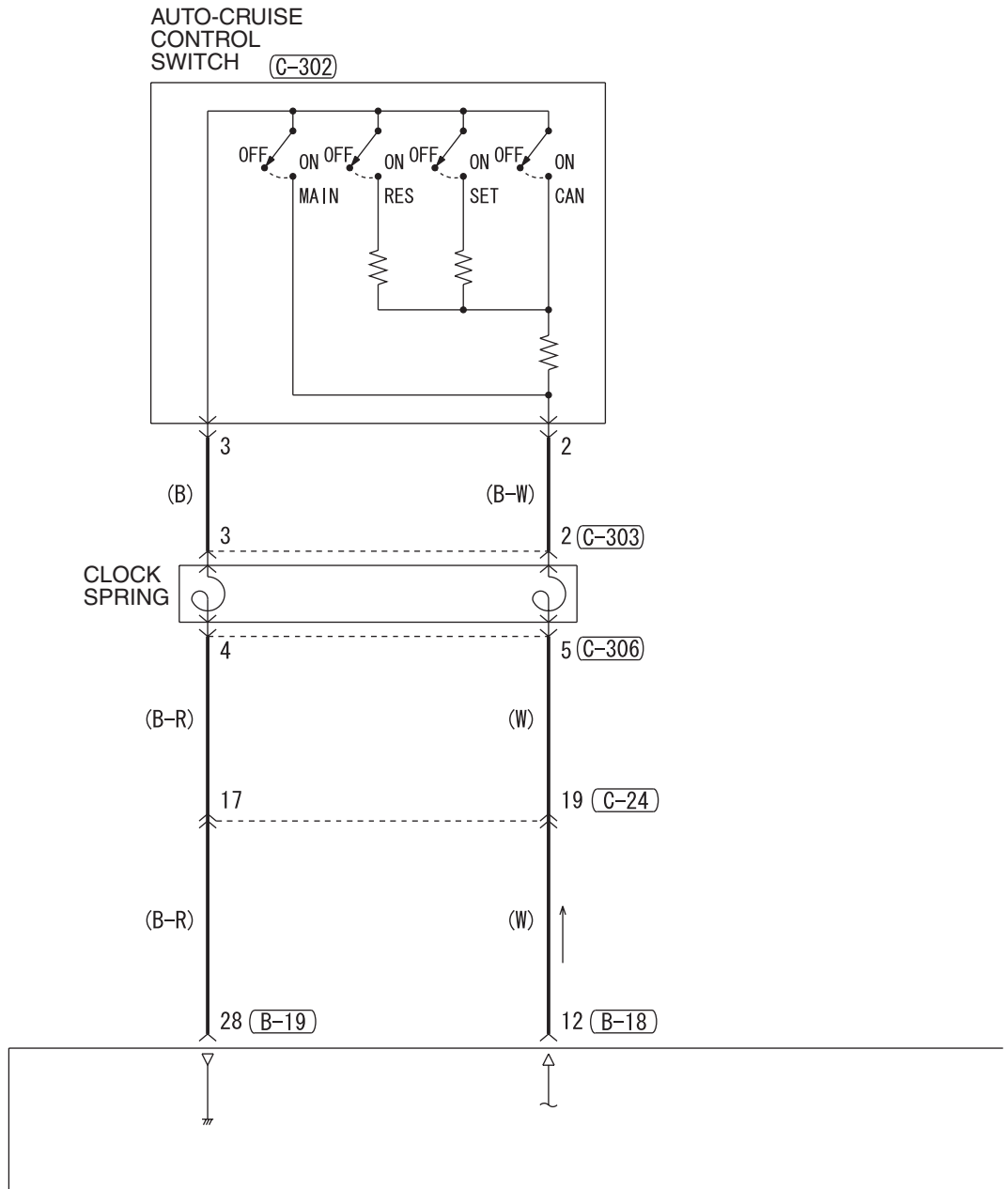

(A-15)

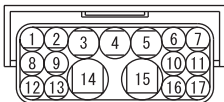

(B-18)

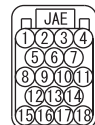

(B-19)

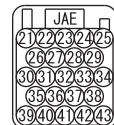

(B-20)

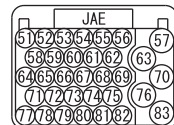

(B-113)

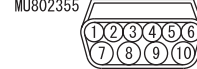

(C-24)

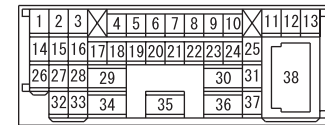

6

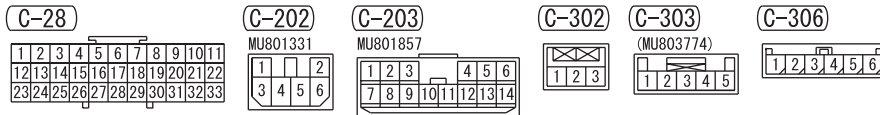
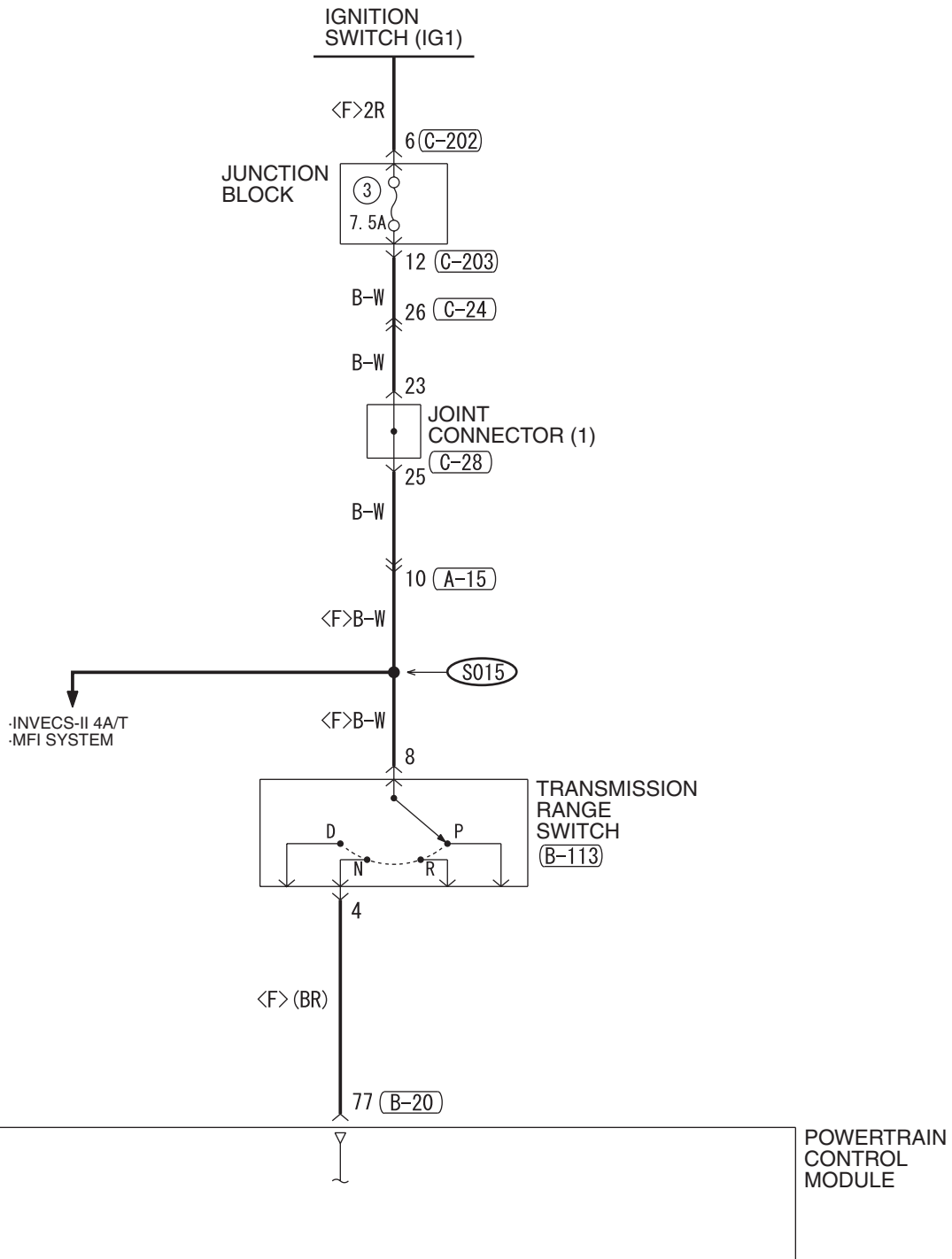

WIRE COLOR CODE
 B : BLACK LG : LIGHT GREEN G : GREEN L : BLUE W : WHITE Y : YELLOW SB : SKY BLUE
 BR : BROWN O : ORANGE GR : GRAY R : RED P : PINK V : VIOLET PU : PURPLE

H6P15M02CB

TSB Revision

AUTO-CRUISE CONTROL SYSTEM <2.4L ENGINE-A/T> (CONTINUED)

7

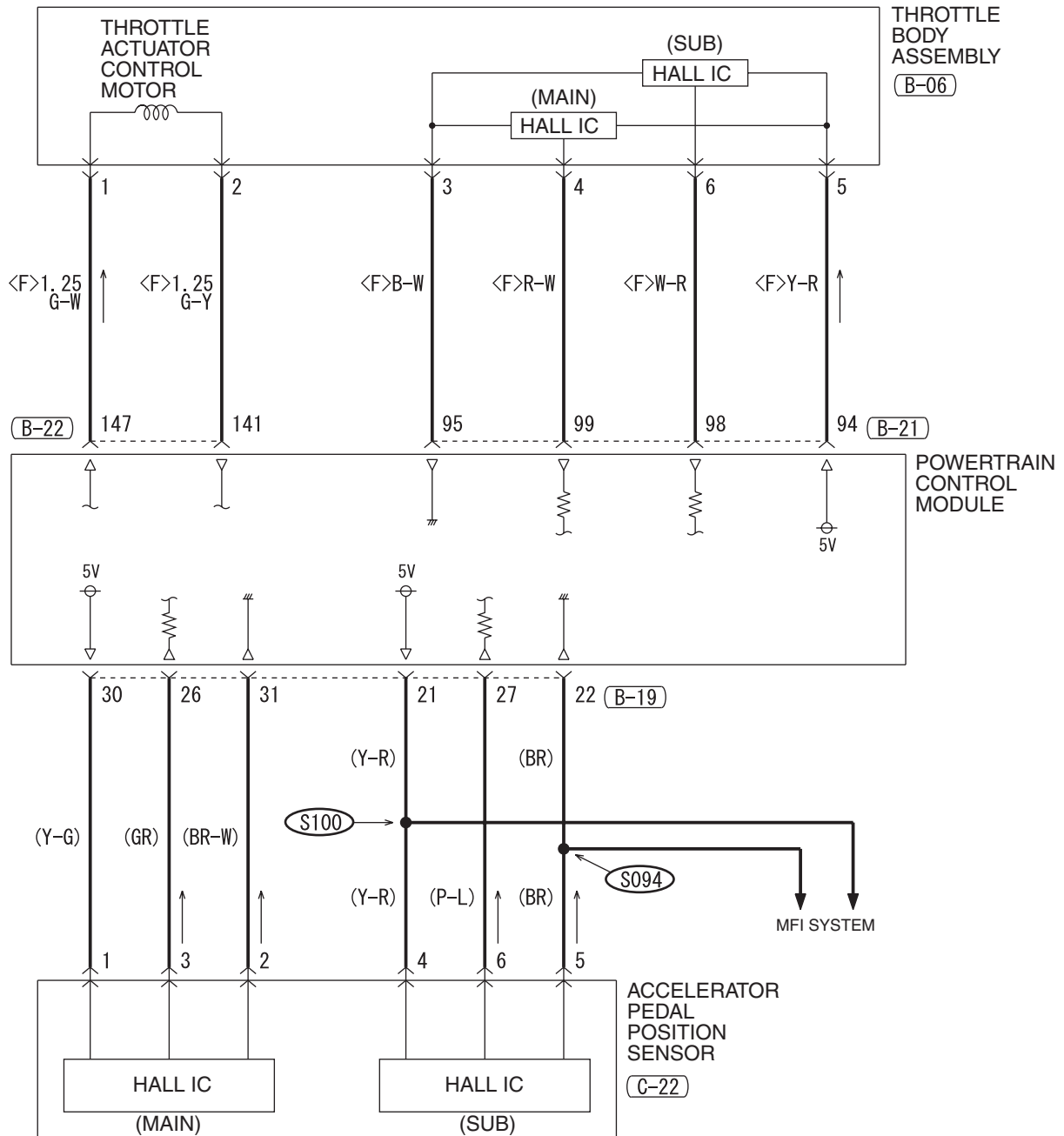

8

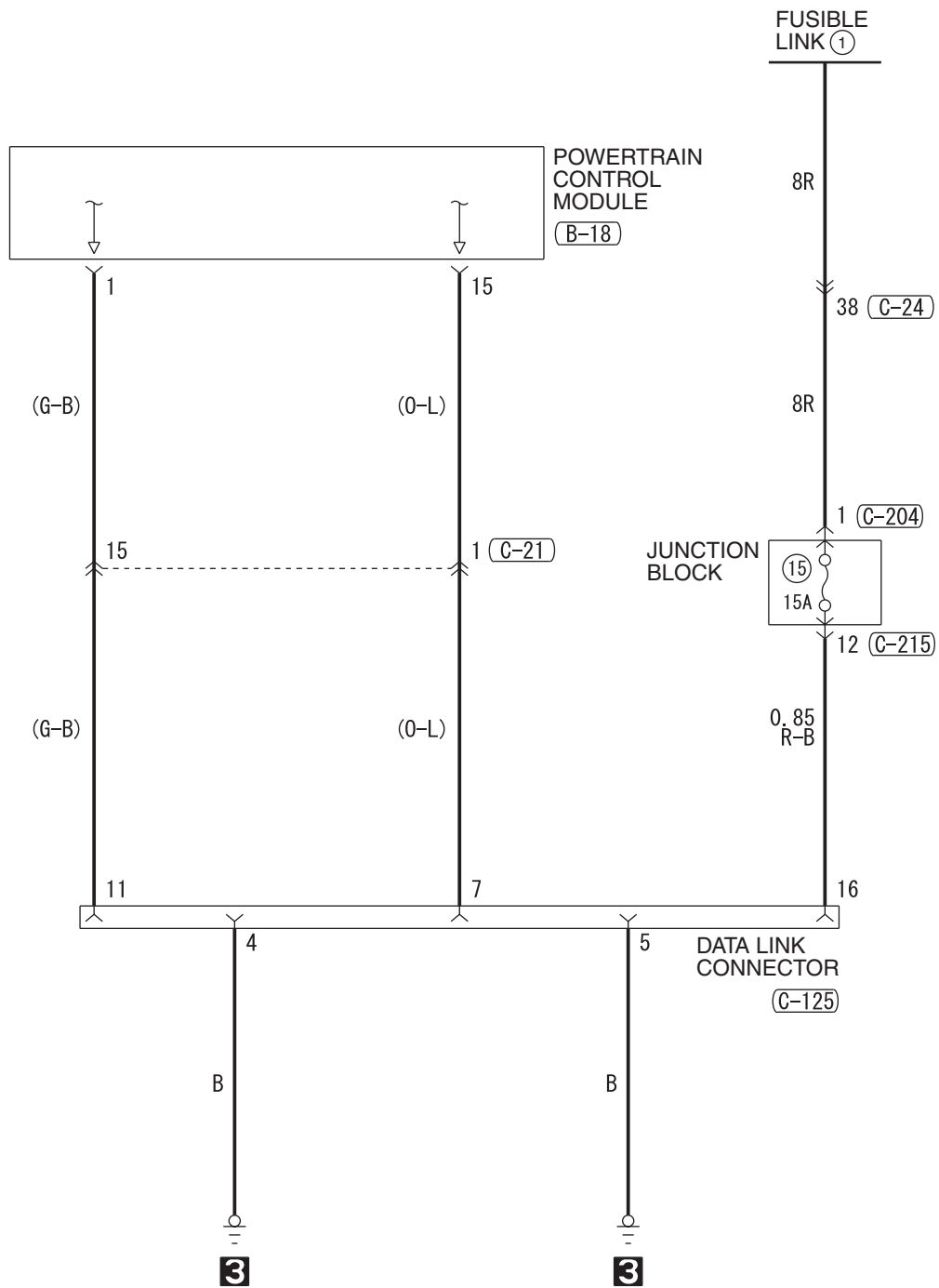

(C-24)

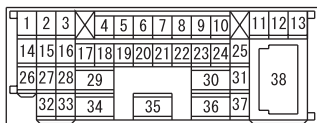

(C-125) FRONT SIDE



(C-204)



(C-215)

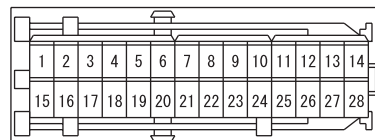

AUTO-CRUISE CONTROL SYSTEM <3.8L ENGINE-M/T>

M1901009301872

1

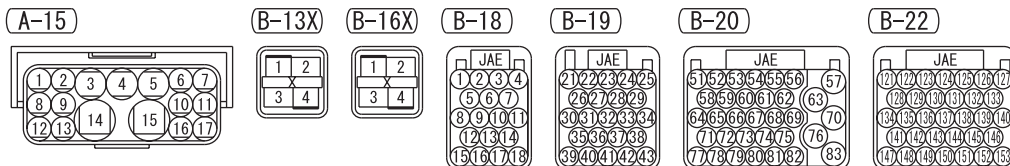
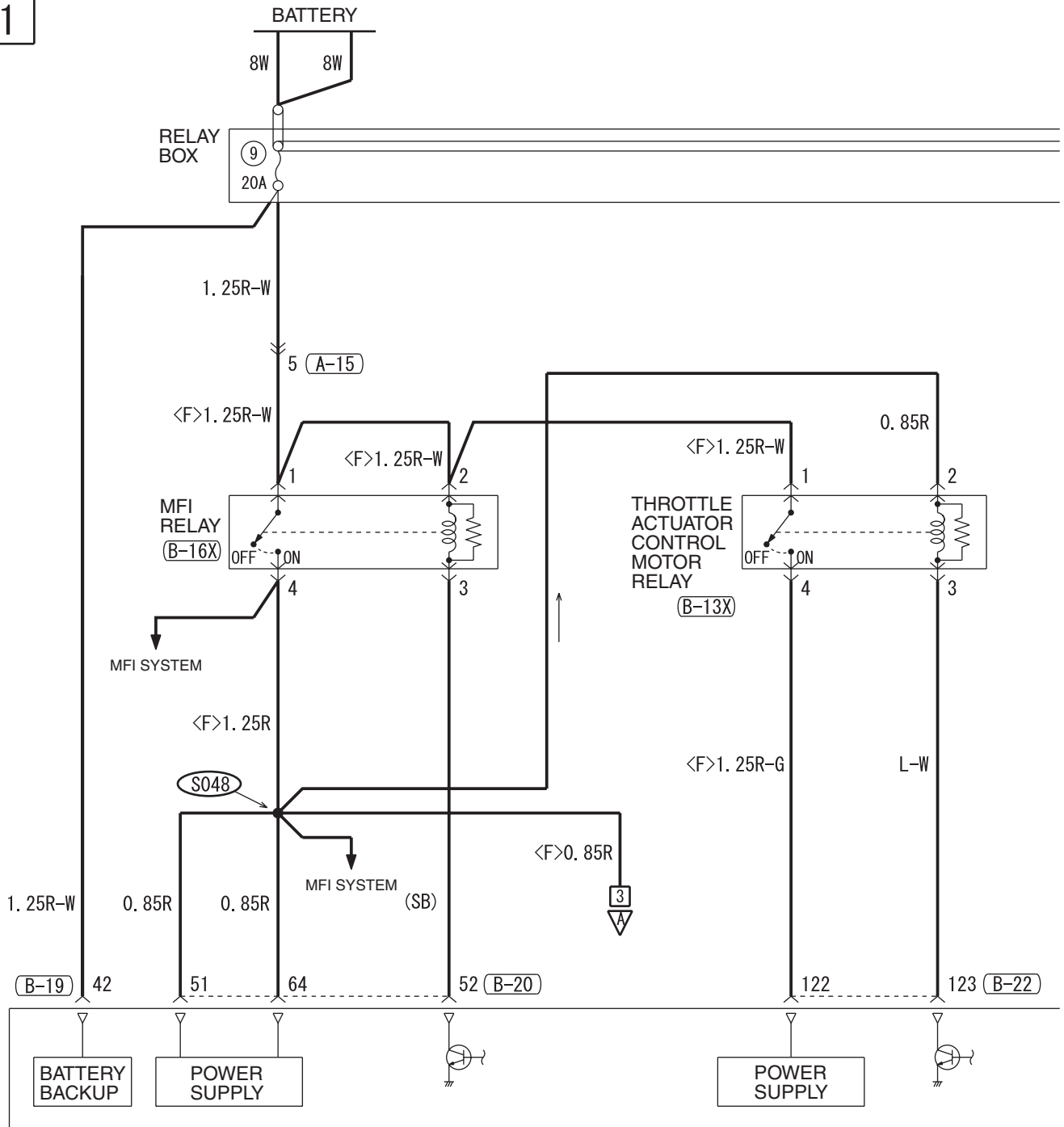

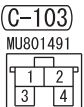
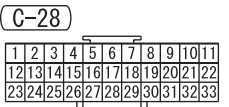
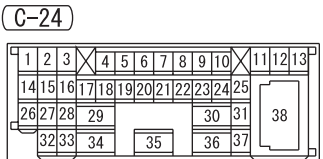
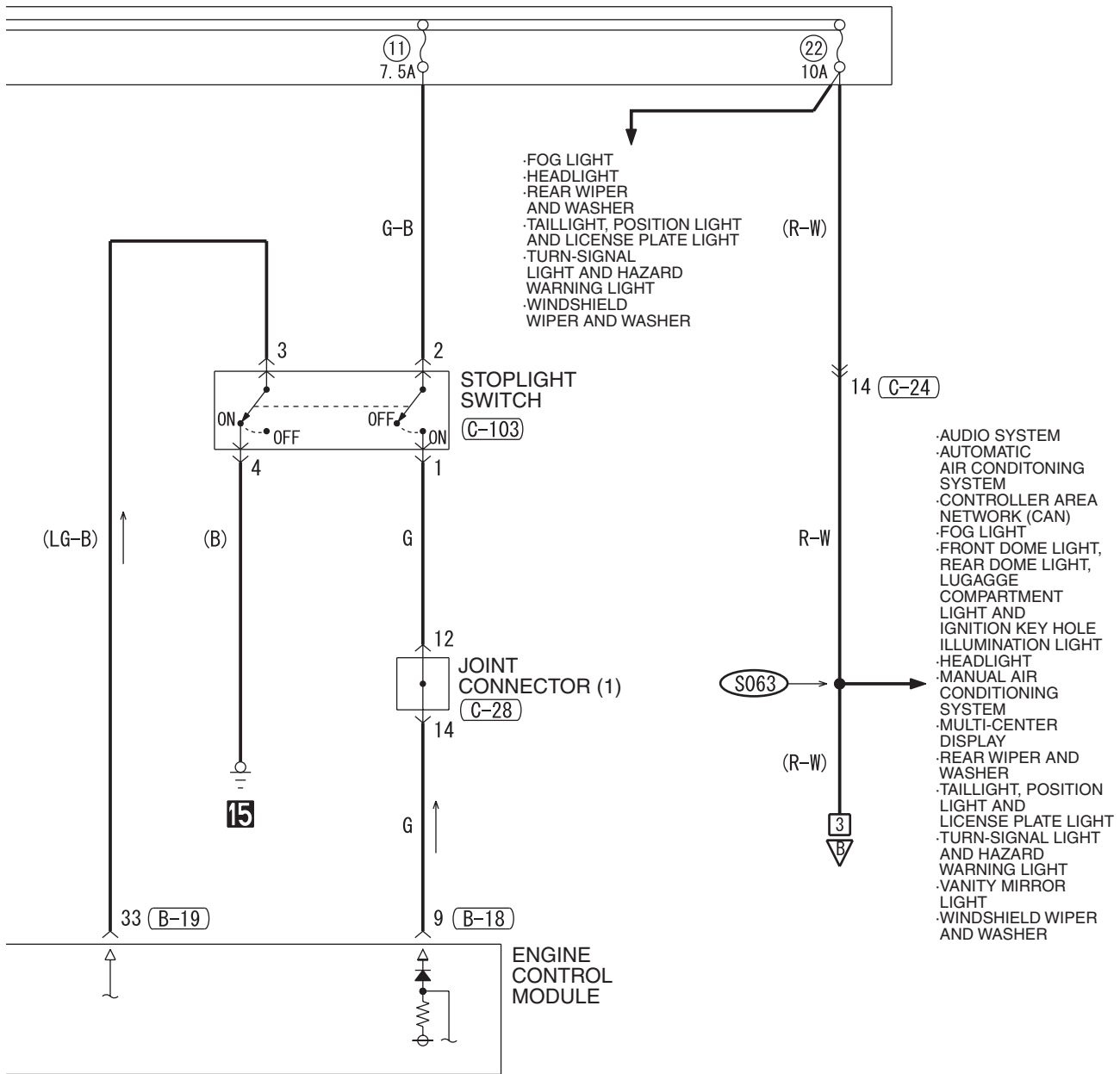

WIRE COLOR CODE
 B : BLACK LG : LIGHT GREEN G : GREEN L : BLUE
 BR : BROWN O : ORANGE GR : GRAY R : RED W : WHITE
 SB : SKY BLUE P : PINK Y : YELLOW V : VIOLET PU : PURPLE

H6P15M03AB

AUTO-CRUISE CONTROL SYSTEM <3.8L ENGINE-M/T> (CONTINUED)

3

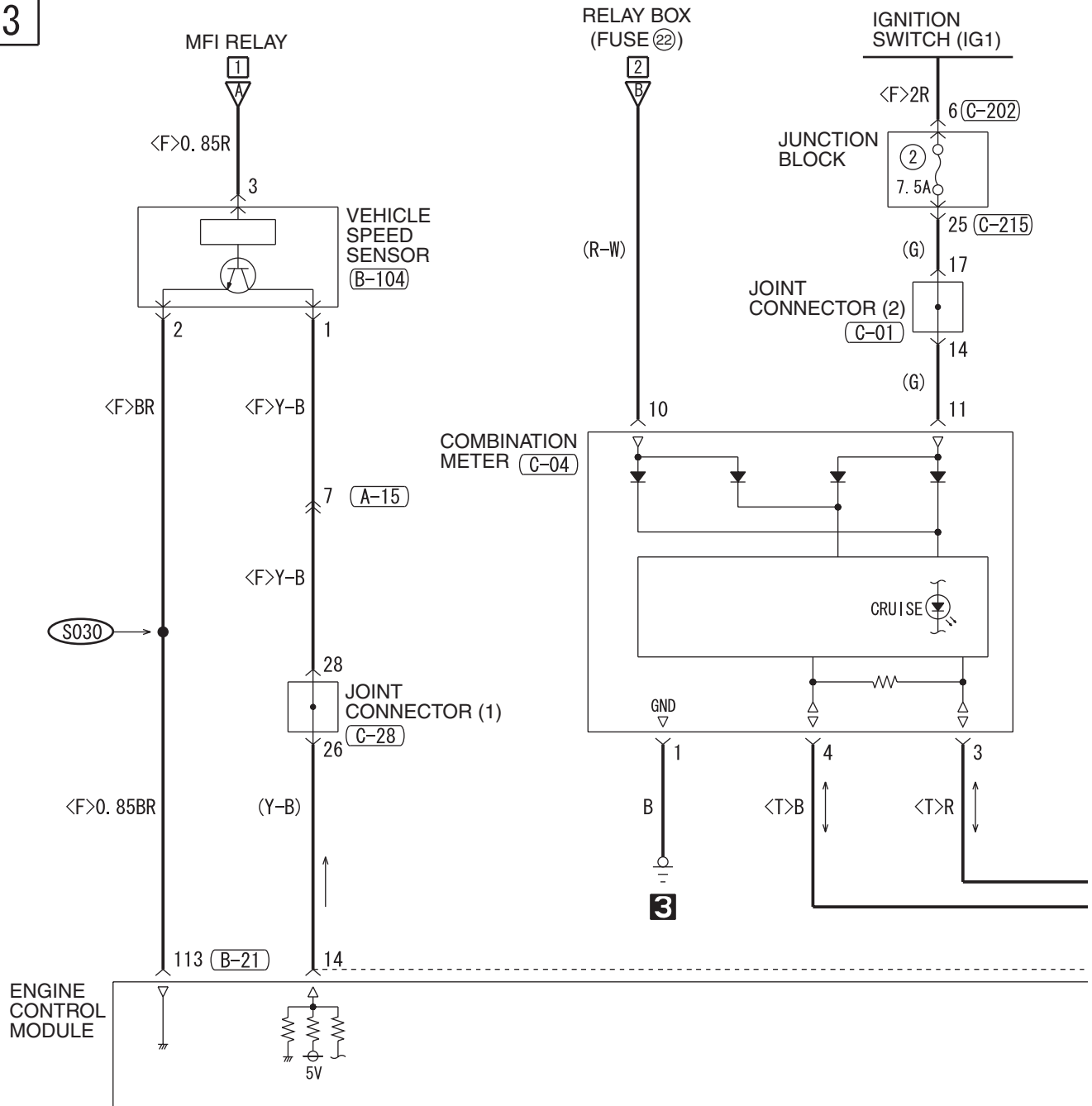

(A-03)

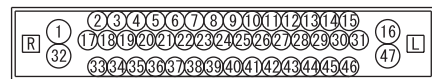

(A-15)

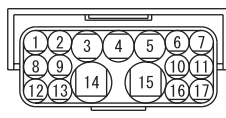

(B-18)



(C-28)



(C-125) FRONT SIDE

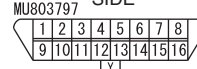

(C-202)



(C-215)

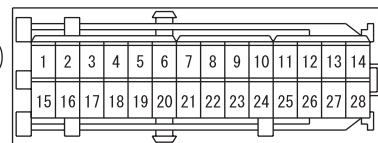

H6P15M03BA

4

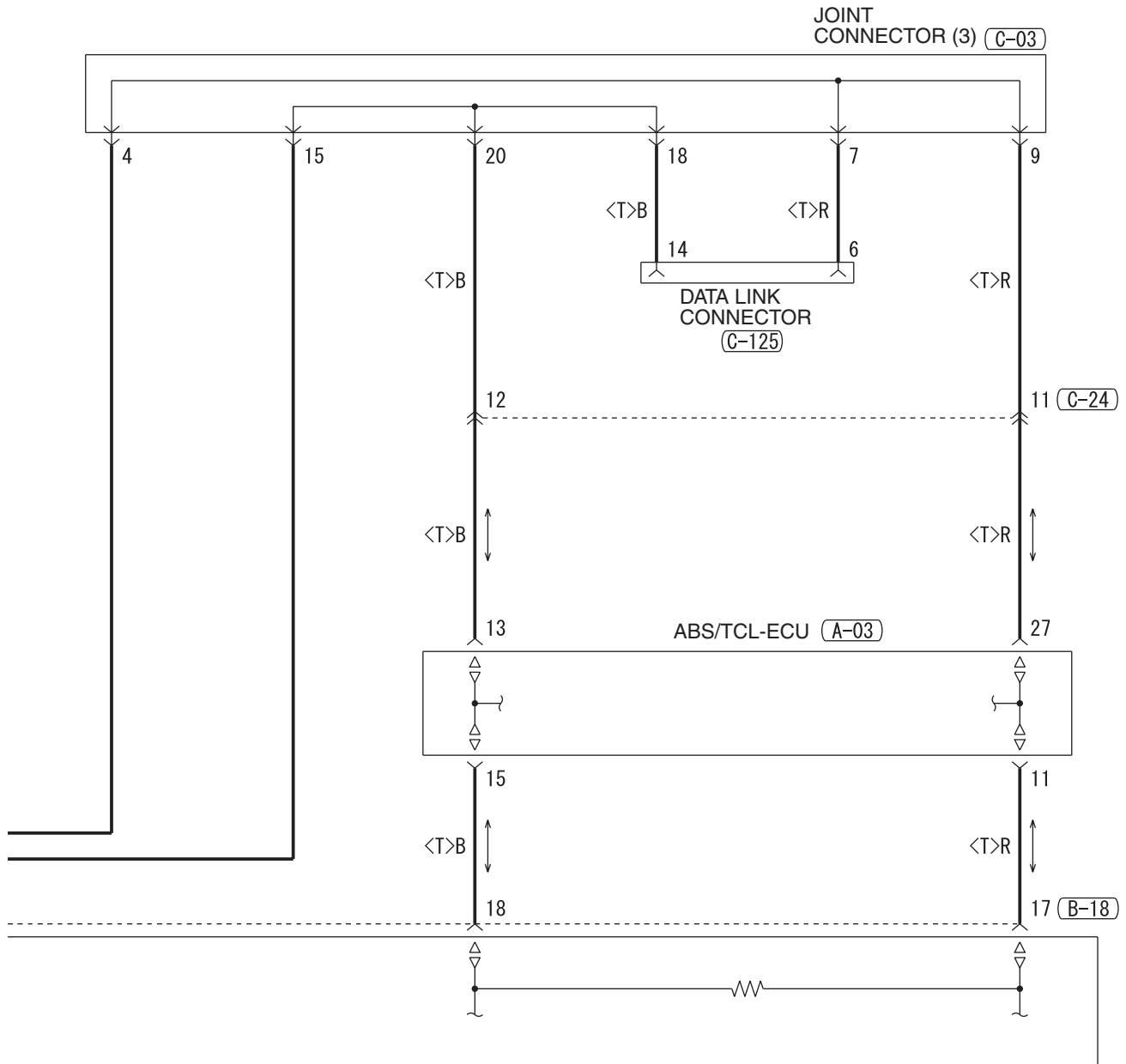

(B-21)



(B-104)



(C-01)

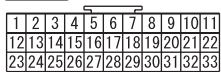

(C-03)

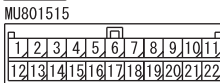

(C-04)

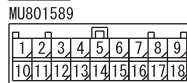

(C-24)

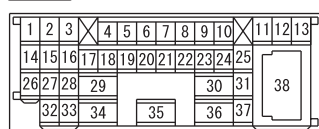

WIRE COLOR CODE

B : BLACK LG : LIGHT GREEN G : GREEN L : BLUE W : WHITE Y : YELLOW SB : SKY BLUE
 BR : BROWN O : ORANGE GR : GRAY R : RED P : PINK V : VIOLET PU : PURPLE H6P15M03BB

AUTO-CRUISE CONTROL SYSTEM <3.8L ENGINE-M/T> (CONTINUED)

5

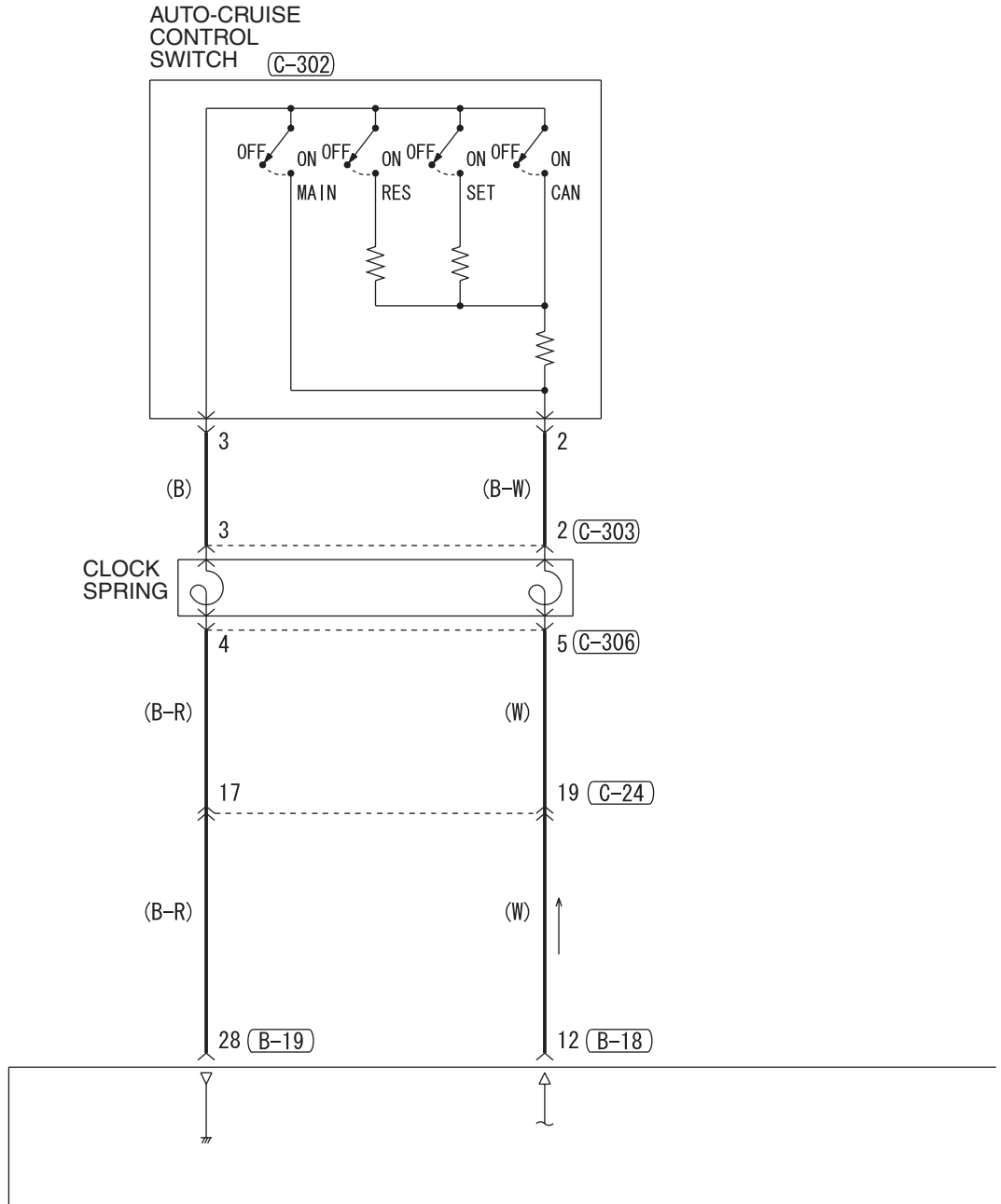

(B-18)



(B-19)

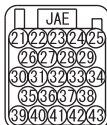

(C-24)

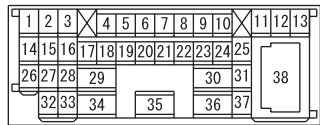

(C-129)



(C-302)



(C-303)



(C-306)

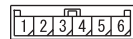

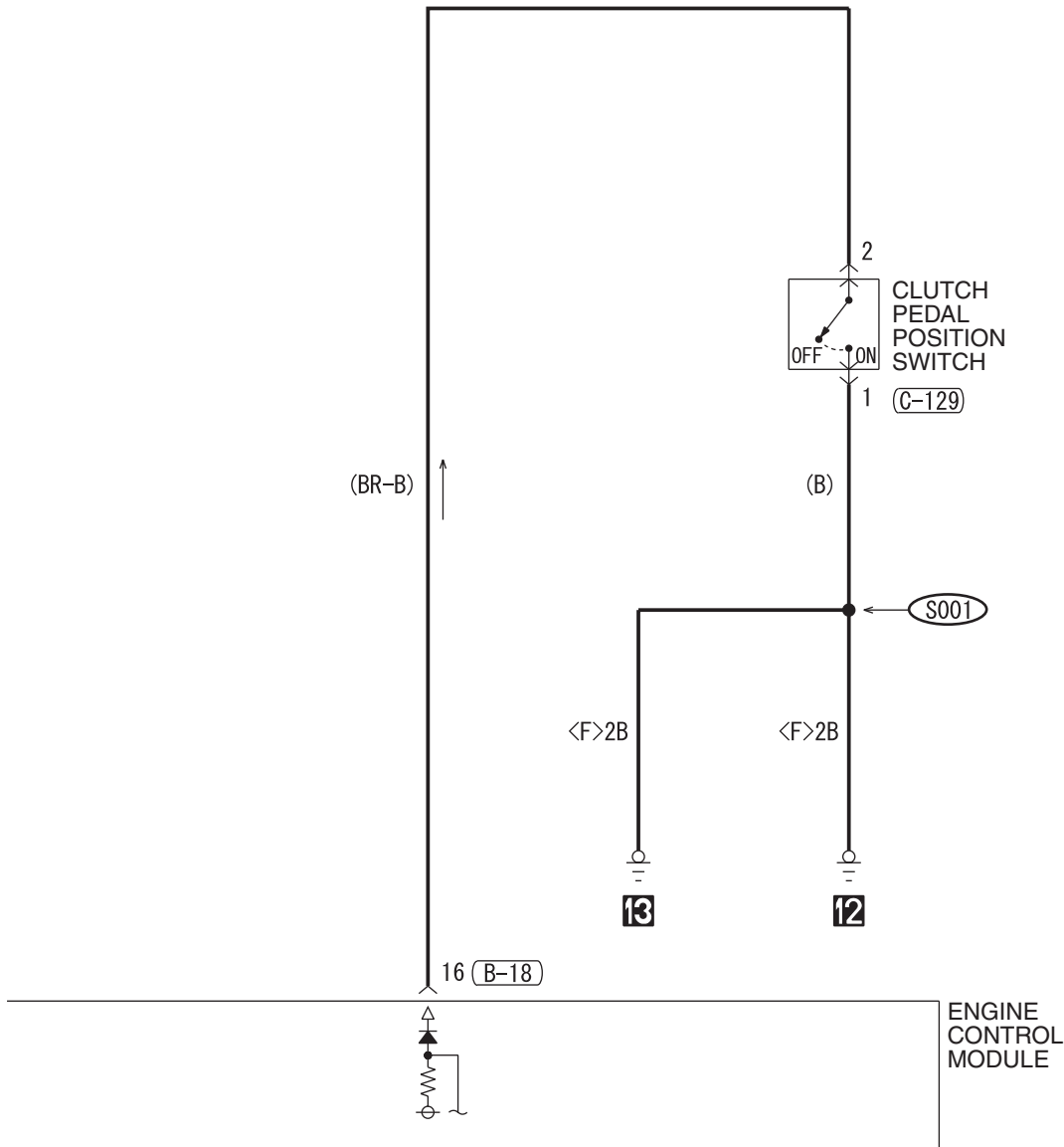

WIRE COLOR CODE
 B: BLACK LG: LIGHT GREEN G: GREEN L: BLUE W: WHITE Y: YELLOW SB: SKY BLUE
 BR: BROWN O: ORANGE GR: GRAY R: RED P: PINK V: VIOLET PU: PURPLE

H6P15M03CB

AUTO-CRUISE CONTROL SYSTEM <3.8L ENGINE-M/T> (CONTINUED)

7

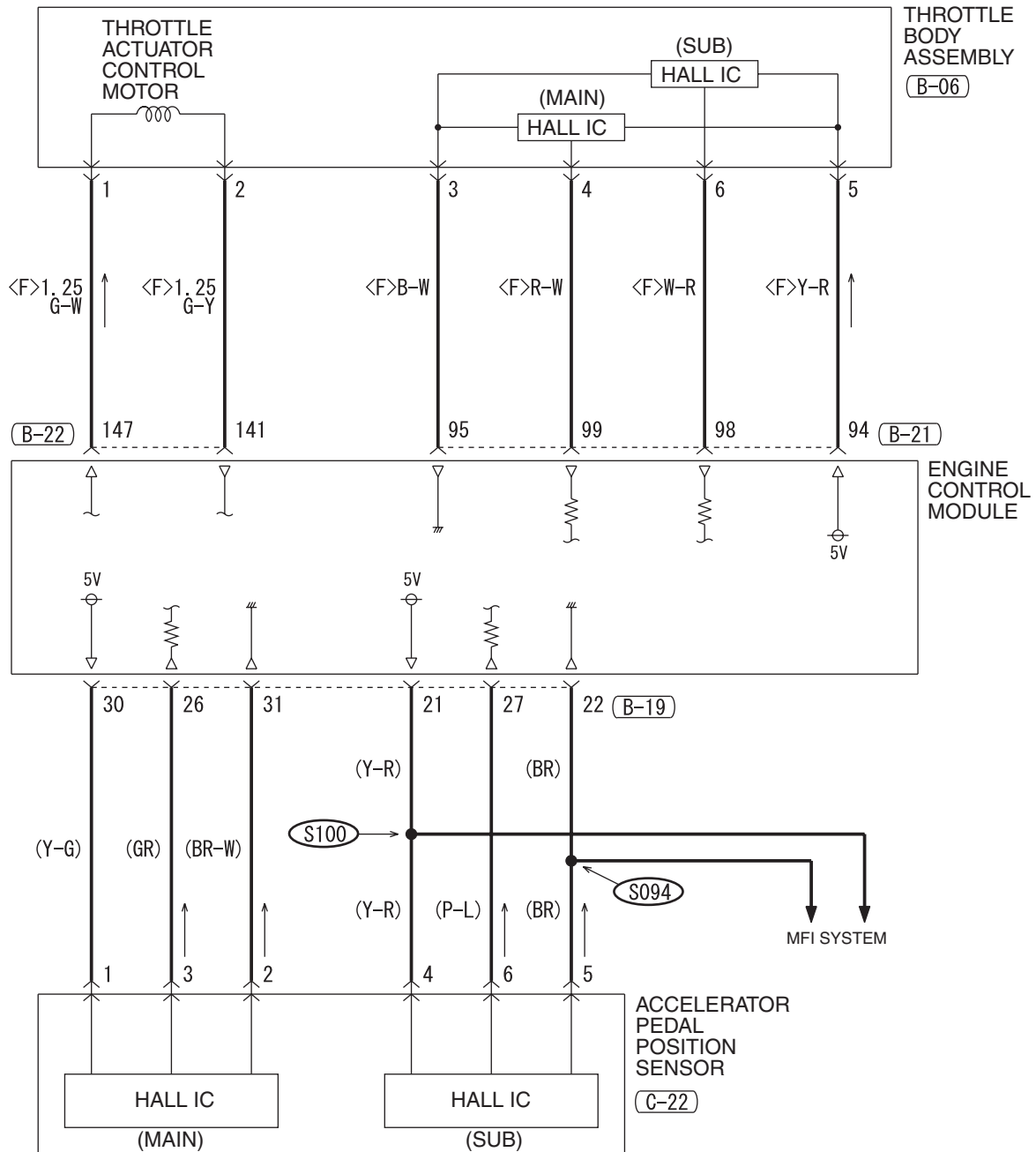

8

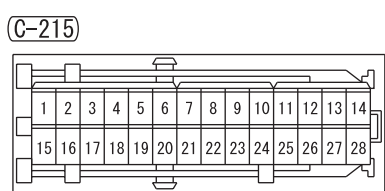
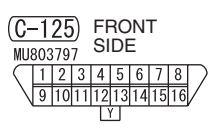
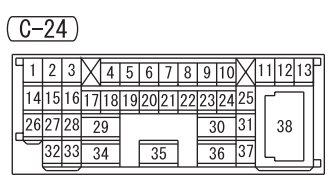
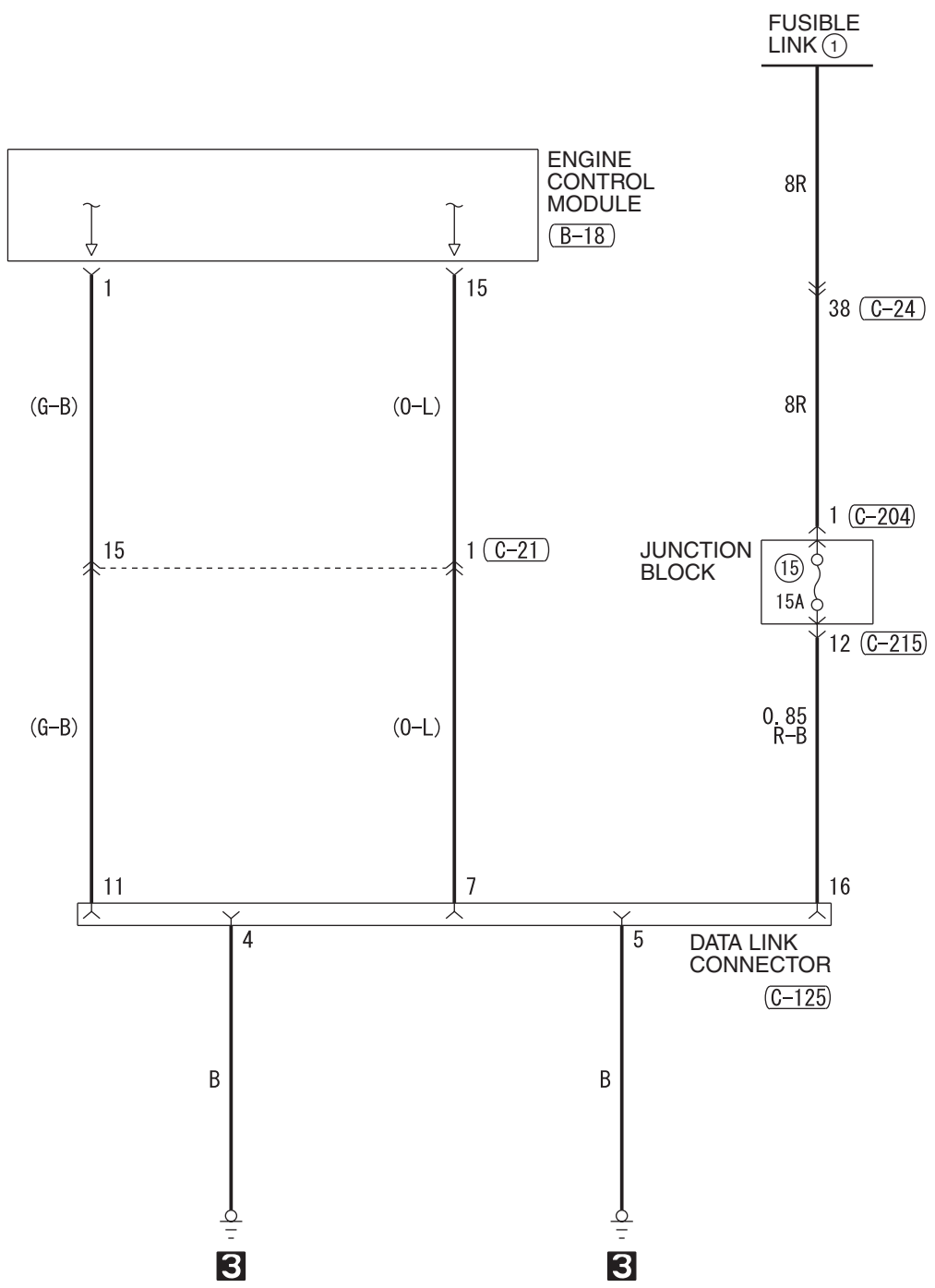

AUTO-CRUISE CONTROL SYSTEM <3.8L ENGINE-A/T>

M1901009301883

1

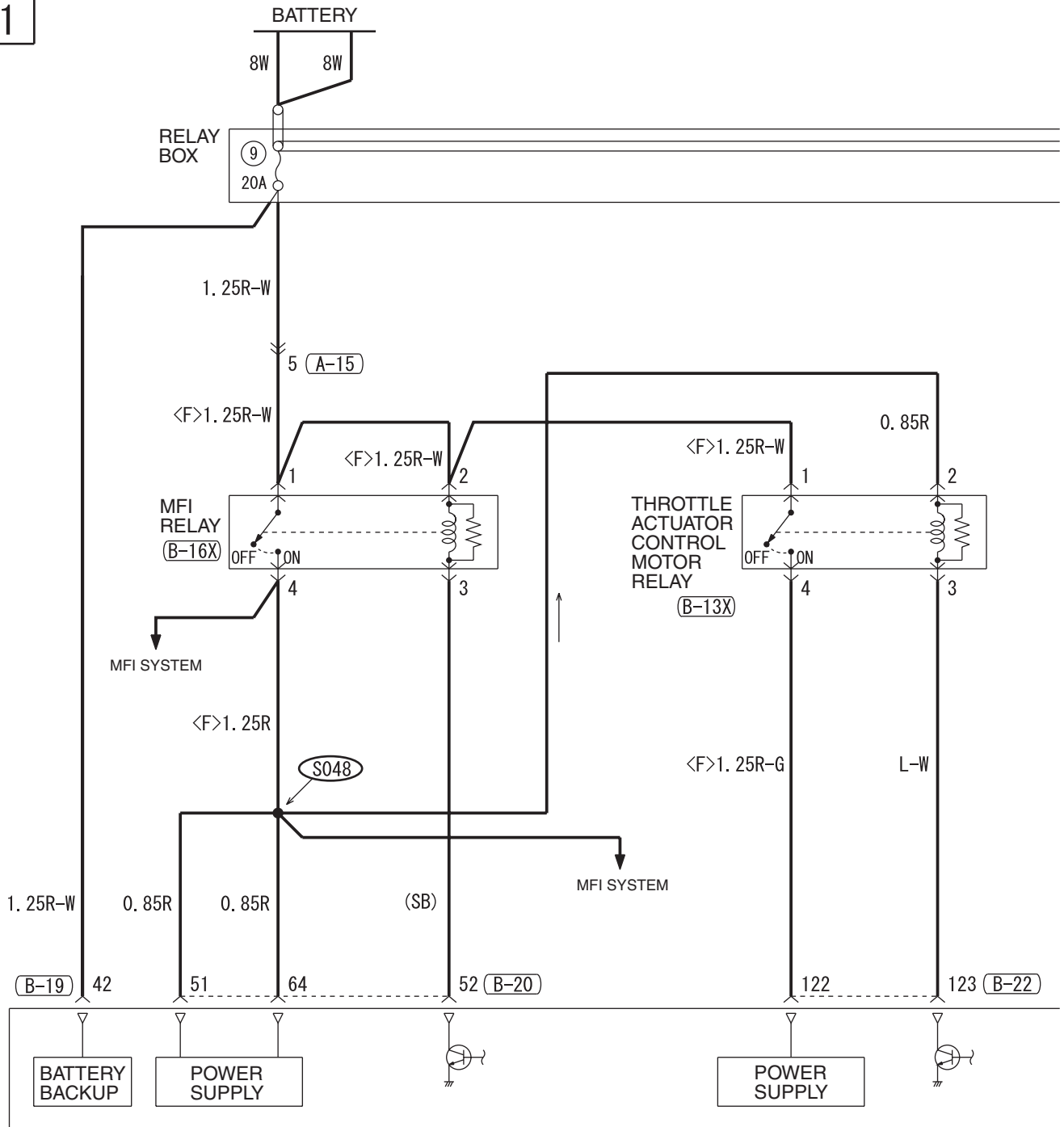

(A-15)

(B-13X)

(B-16X)

(B-18)

(B-19)

(B-20)

(B-22)

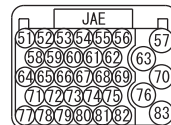
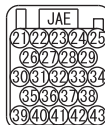
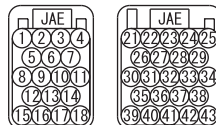
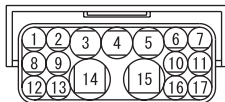

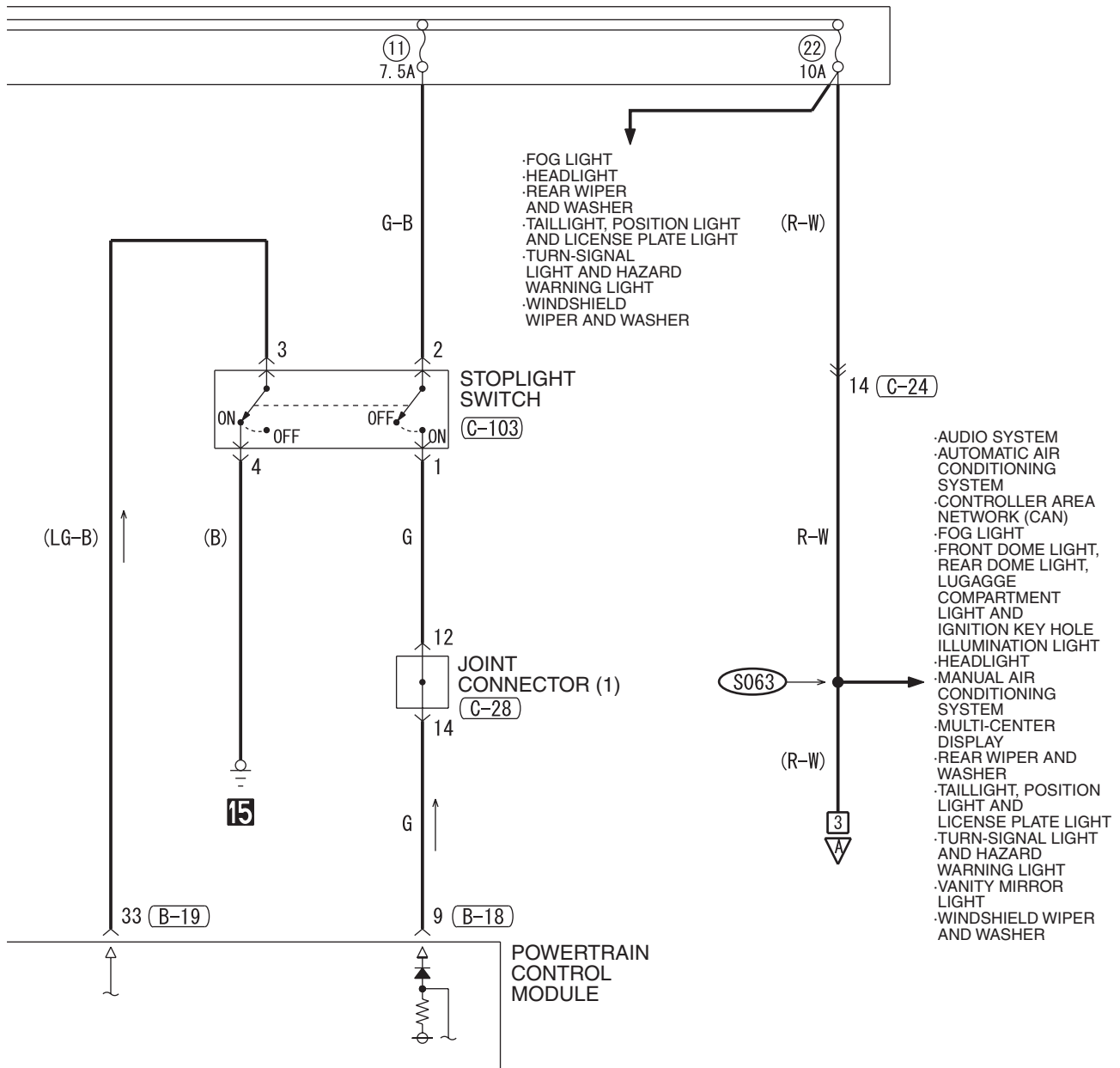

C-24

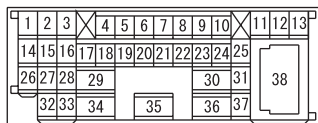

C-28



C-103



WIRE COLOR CODE
 B : BLACK LG : LIGHT GREEN G : GREEN L : BLUE
 BR : BROWN O : ORANGE GR : GRAY R : RED W : WHITE
 SB : SKY BLUE P : PINK Y : YELLOW V : VIOLET PU : PURPLE

H6P15M04AB

AUTO-CRUISE CONTROL SYSTEM <3.8L ENGINE-A/T> (CONTINUED)

3

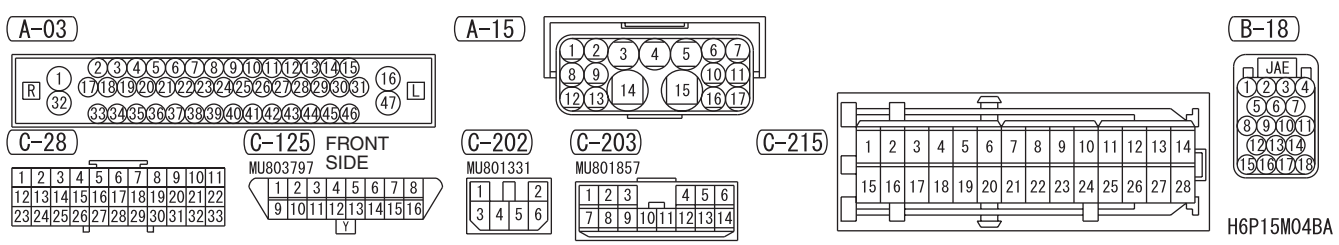
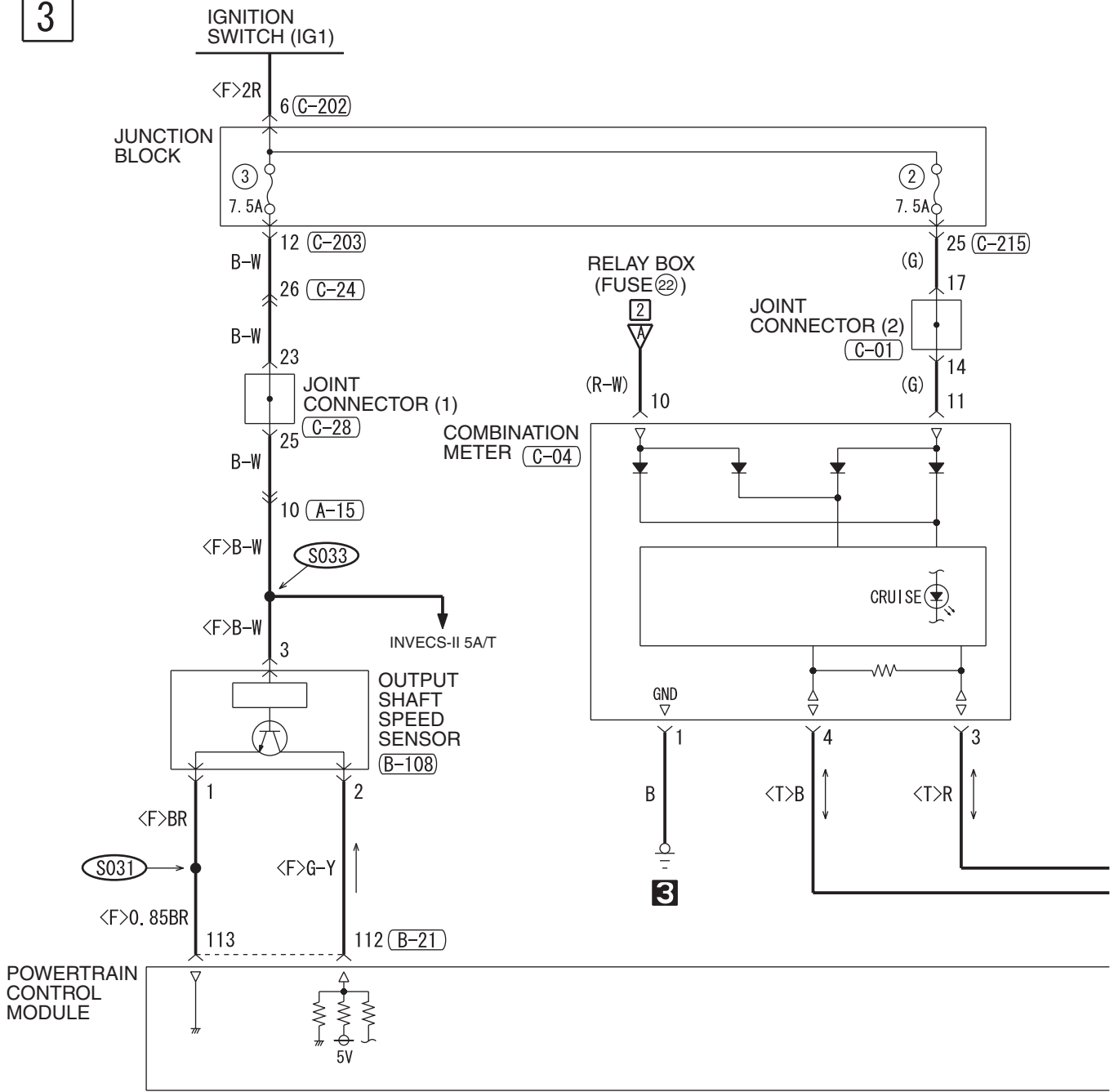

H6P15M04BA

4

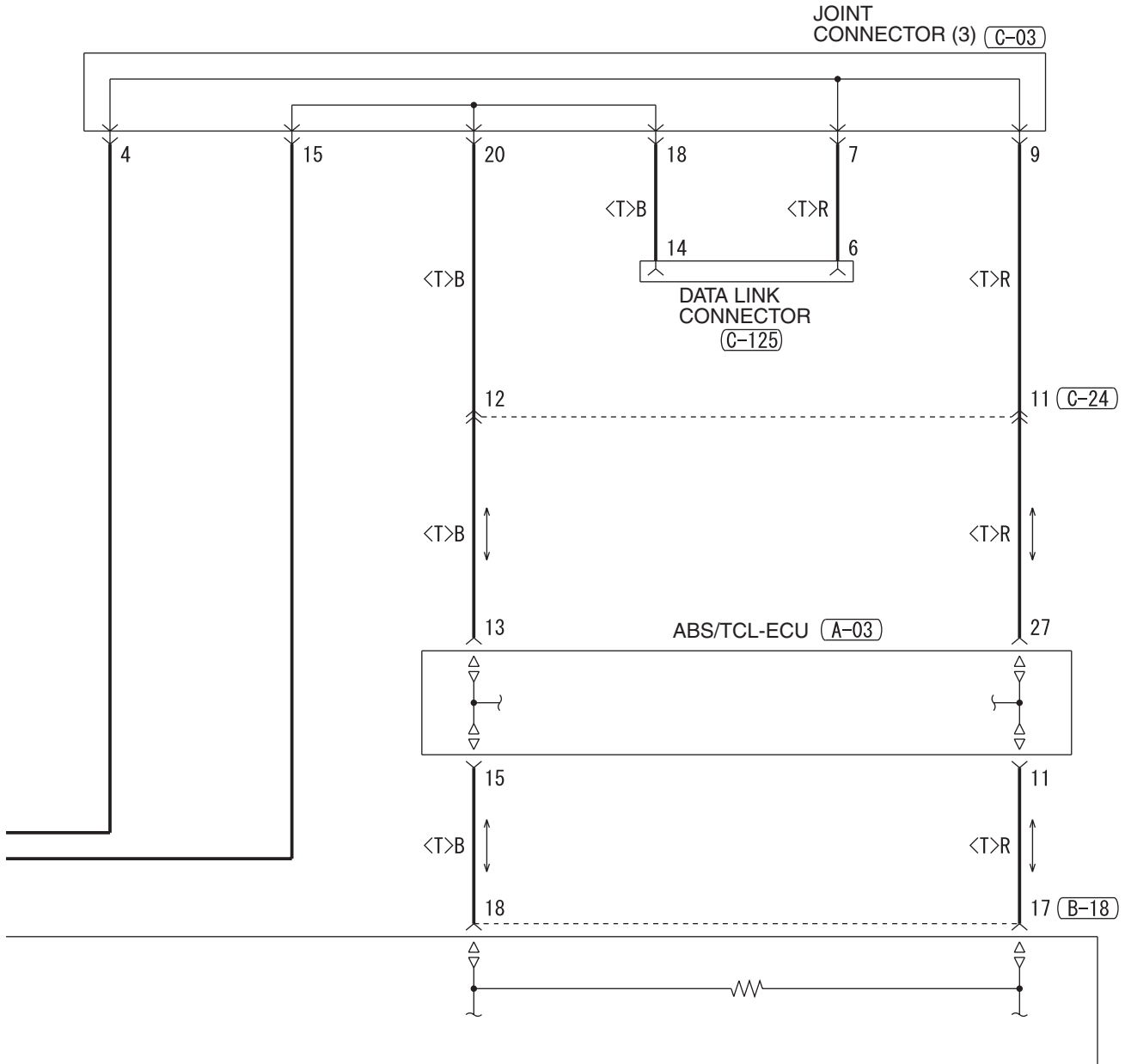

(B-21)



(B-108)



(C-01)



(C-03)

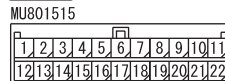

(C-04)

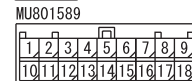

(C-24)

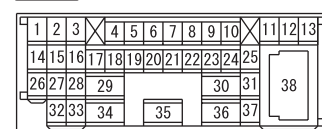

WIRE COLOR CODE

B : BLACK LG : LIGHT GREEN G : GREEN L : BLUE W : WHITE Y : YELLOW SB : SKY BLUE
 BR : BROWN O : ORANGE GR : GRAY R : RED P : PINK V : VIOLET PU : PURPLE H6P15M04BB

TSB Revision

AUTO-CRUISE CONTROL SYSTEM <3.8L ENGINE-A/T> (CONTINUED)

5

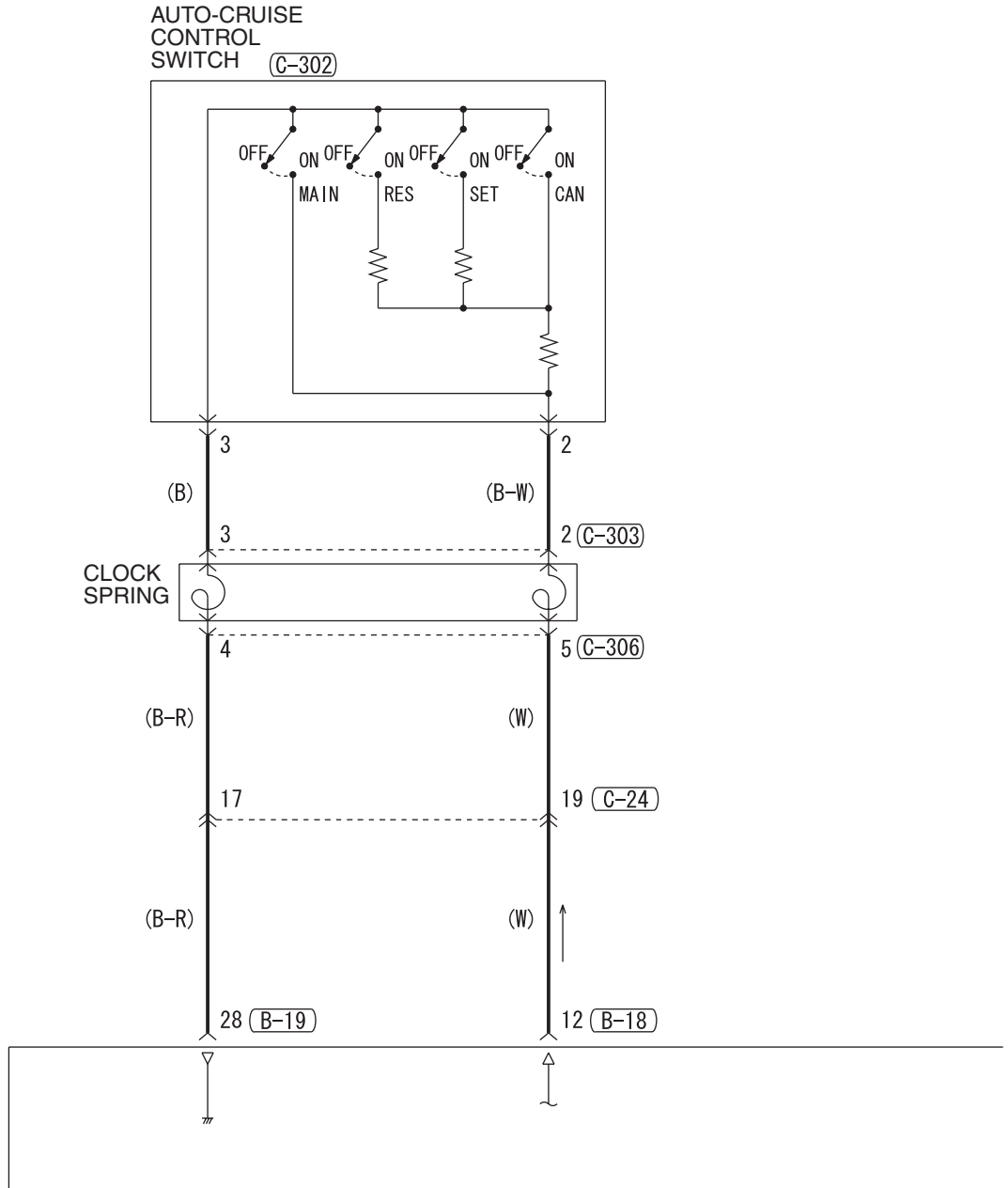

(A-15)

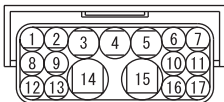

(B-18)



(B-19)

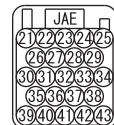

(B-20)

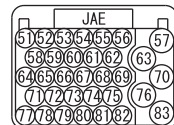

(B-113)

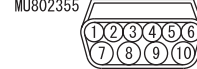

(C-24)

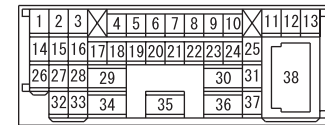

6

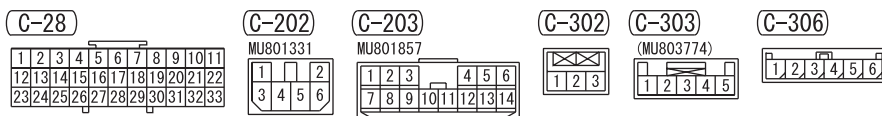
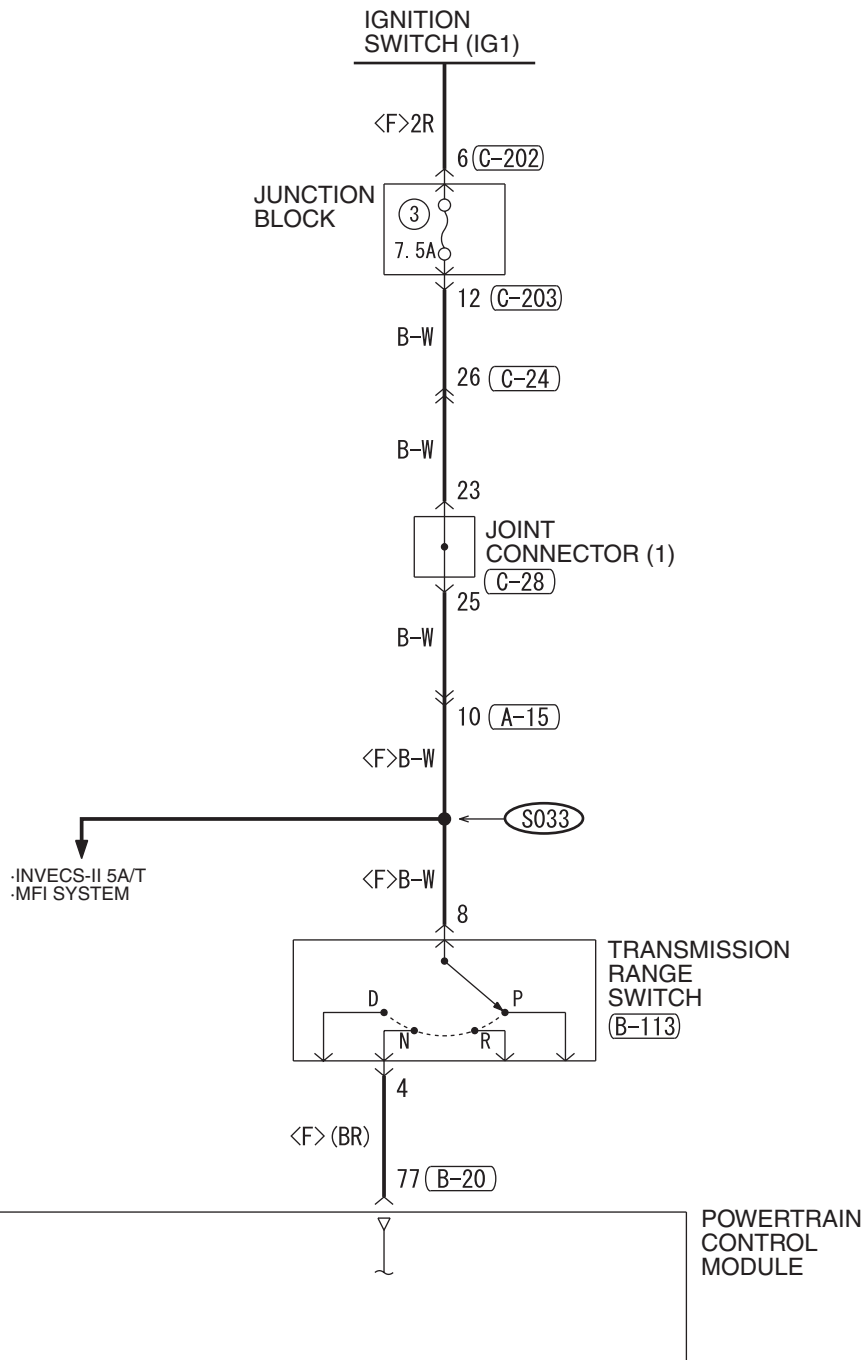

WIRE COLOR CODE
 B : BLACK LG : LIGHT GREEN G : GREEN L : BLUE
 BR : BROWN O : ORANGE GR : GRAY R : RED W : WHITE
 SB : SKY BLUE P : PINK Y : YELLOW V : VIOLET PU : PURPLE

H6P15M04CB

AUTO-CRUISE CONTROL SYSTEM <3.8L ENGINE-A/T> (CONTINUED)

7

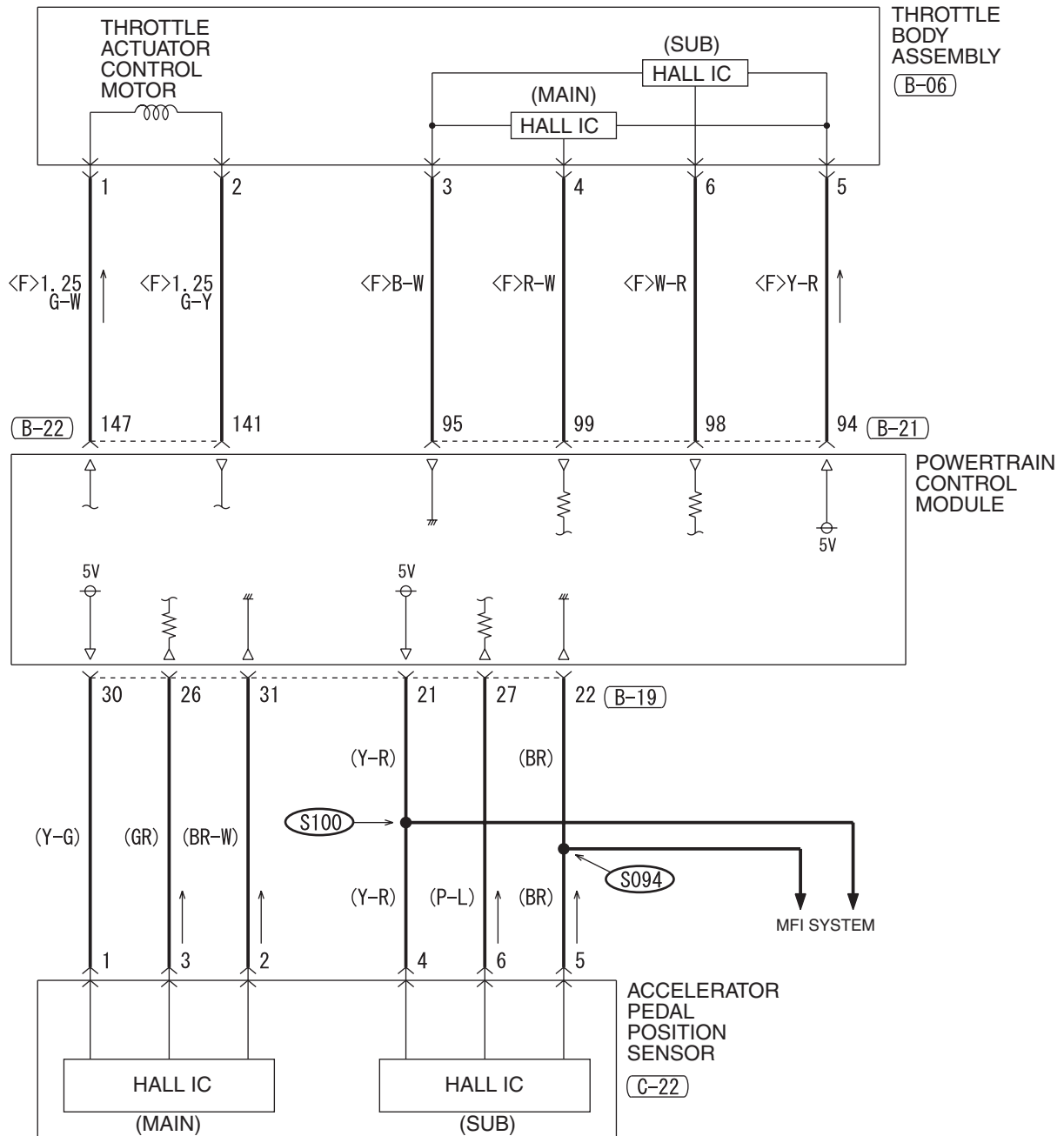

8

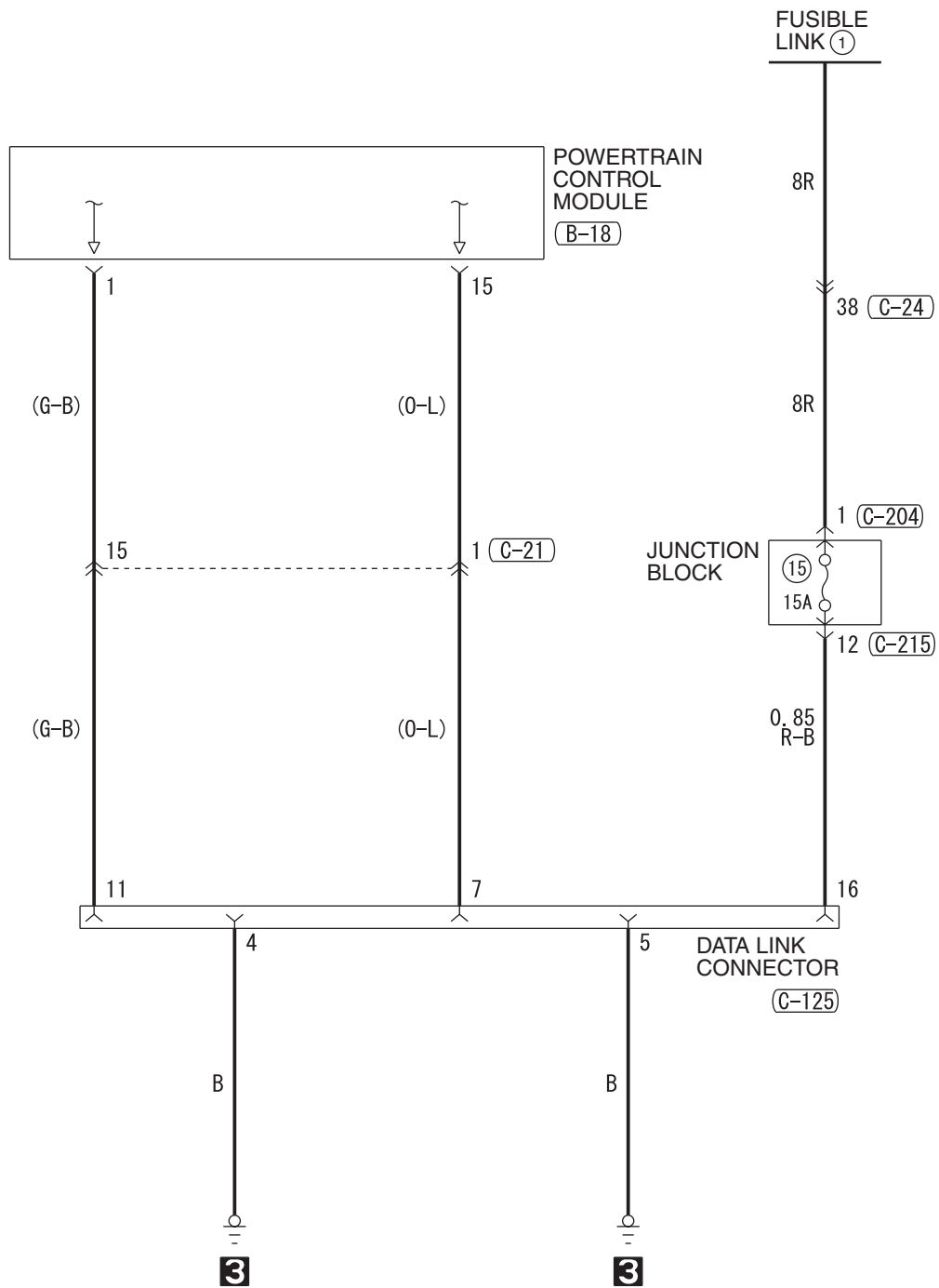

(C-24)

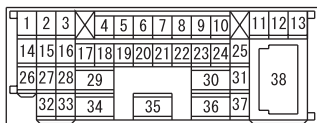

(C-125) FRONT SIDE



(C-204)



(C-215)

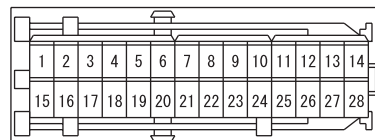

ELECTRONIC BRAKE-FORCE DISTRIBUTION (EBD) AND ANTI-LOCK BRAKING SYSTEM (ABS) <VEHICLES WITHOUT TRACTION CONTROL SYSTEM (TCL)>

M1901017100245

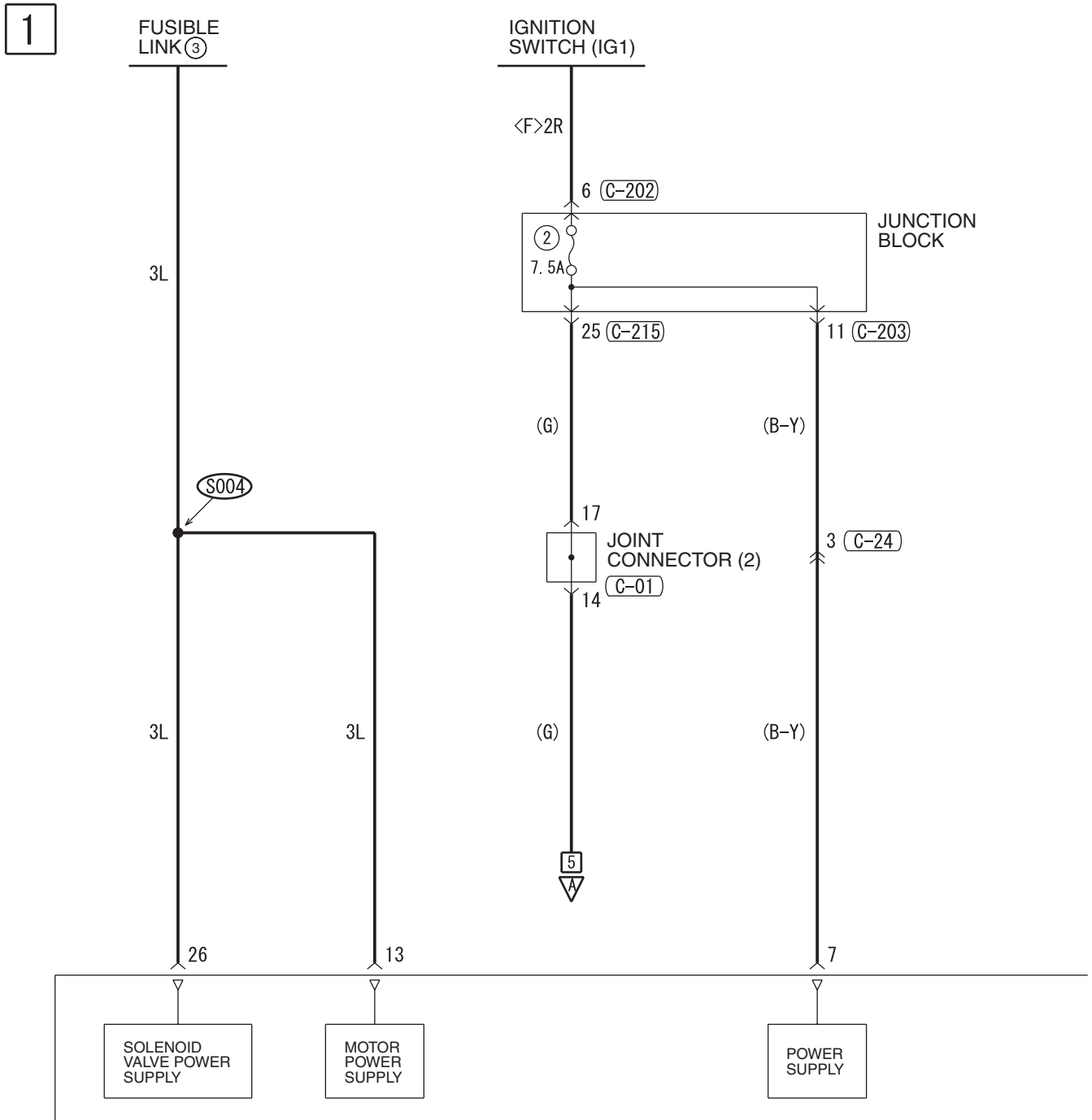

(A-02)

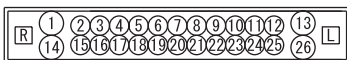

(C-01)



(C-24)

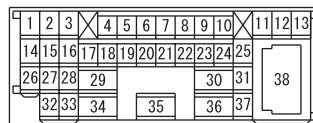

(C-28)



(C-103)



2

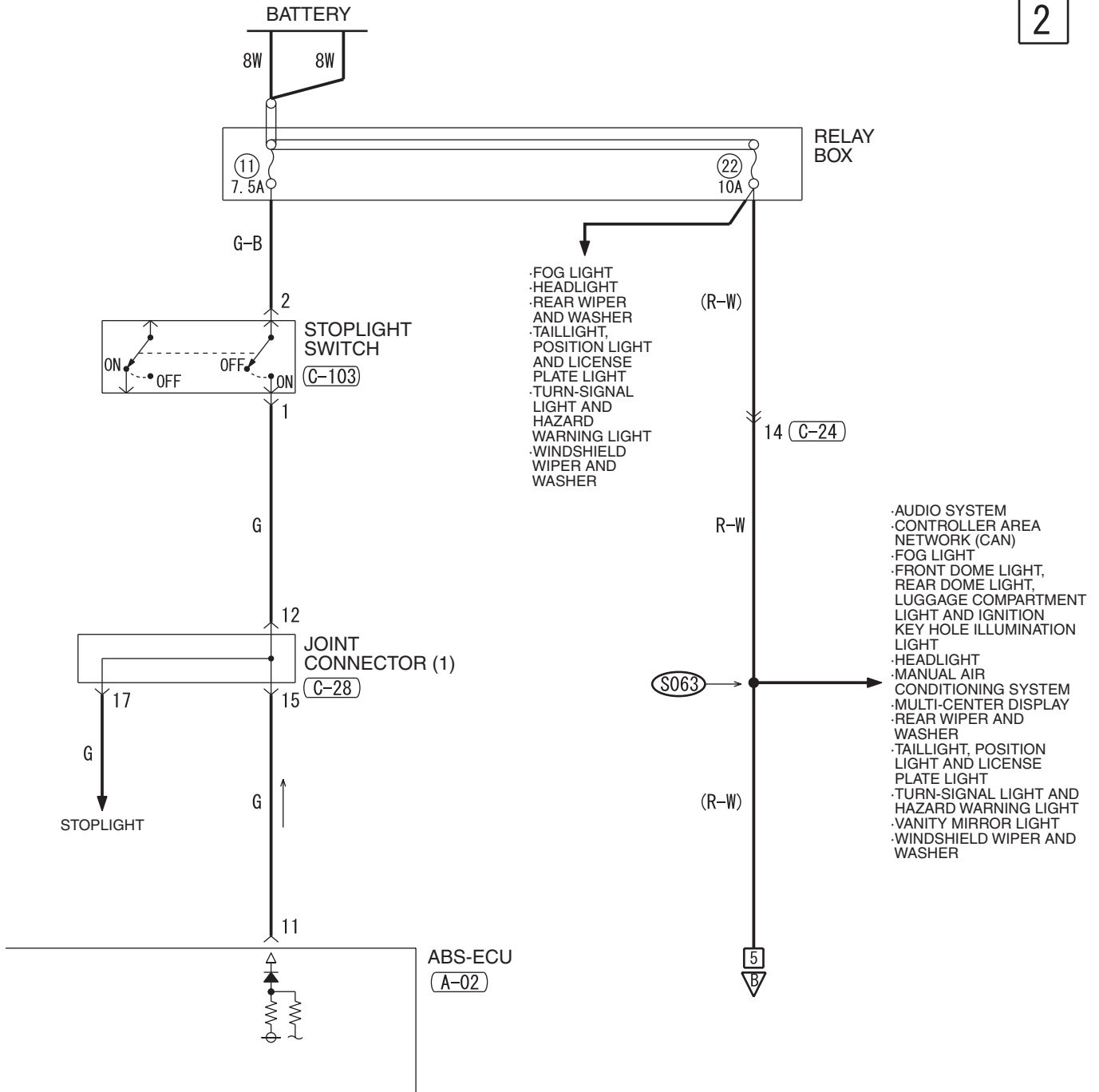

(C-202)



(C-203)

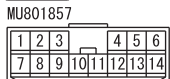

(C-215)

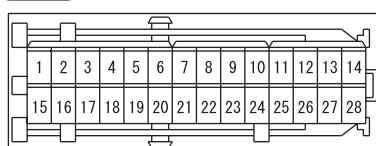

WIRE COLOR CODE

- B : BLACK SB : SKY BLUE
- BR : BROWN LG : LIGHT GREEN
- G : GREEN P : PINK GR : GRAY
- R : RED L : BLUE Y : YELLOW
- V : VIOLET W : WHITE O : ORANGE
- PU : PURPLE

ELECTRONIC BRAKE-FORCE DISTRIBUTION (EBD) AND ANTI-LOCK BRAKING SYSTEM (ABS) <VEHICLES WITHOUT TRACTION CONTROL SYSTEM (TCL)> (CONTINUED)

3

ABS-ECU (A-02)

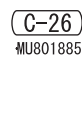
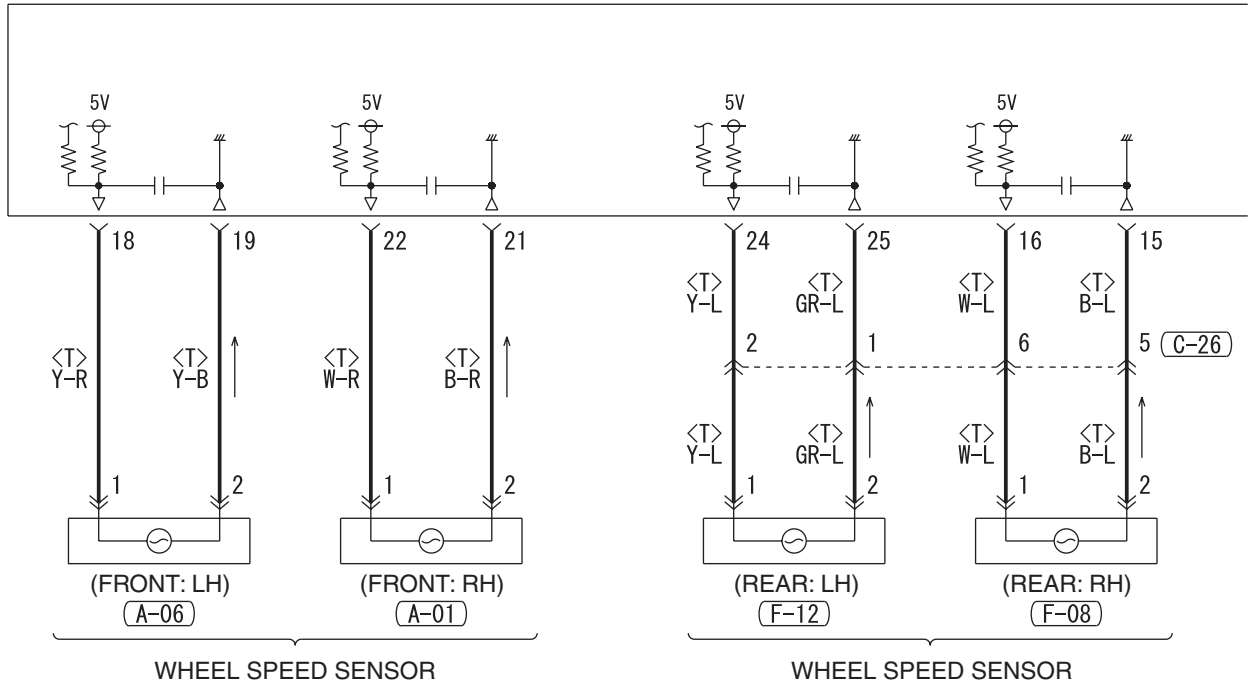

4

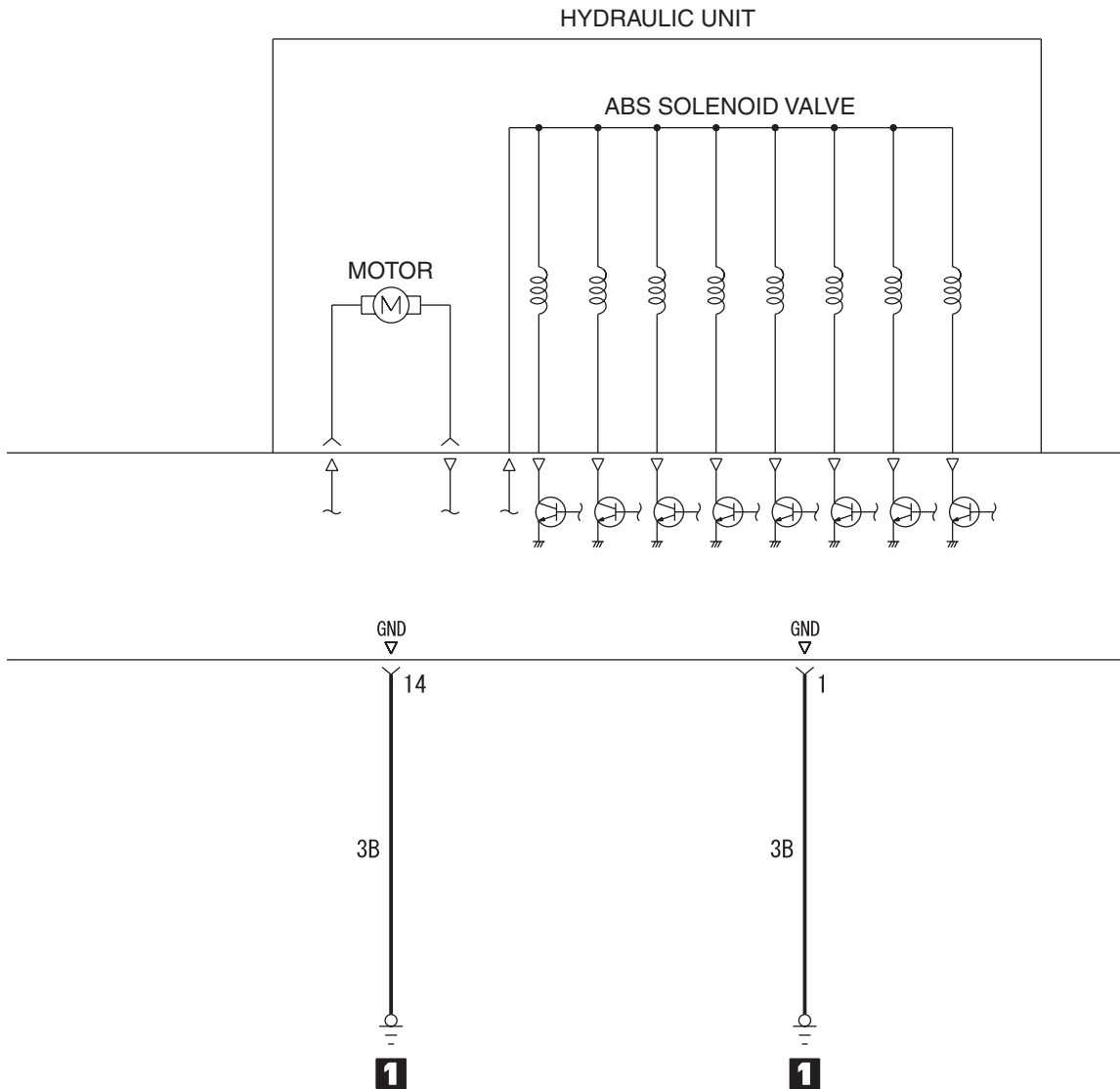

WIRE COLOR CODE
 B:BLACK LG:LIGHT GREEN G:GREEN L:BLUE W:WHITE Y:YELLOW SB:SKY BLUE
 BR:BROWN O:ORANGE GR:GRAY R:RED P:PINK V:VIOLET PU:PURPLE

H6P15M05BB

TSB Revision

ELECTRONIC BRAKE-FORCE DISTRIBUTION (EBD) AND ANTI-LOCK BRAKING SYSTEM (ABS) <VEHICLES WITHOUT TRACTION CONTROL SYSTEM (TCL)> (CONTINUED)

5

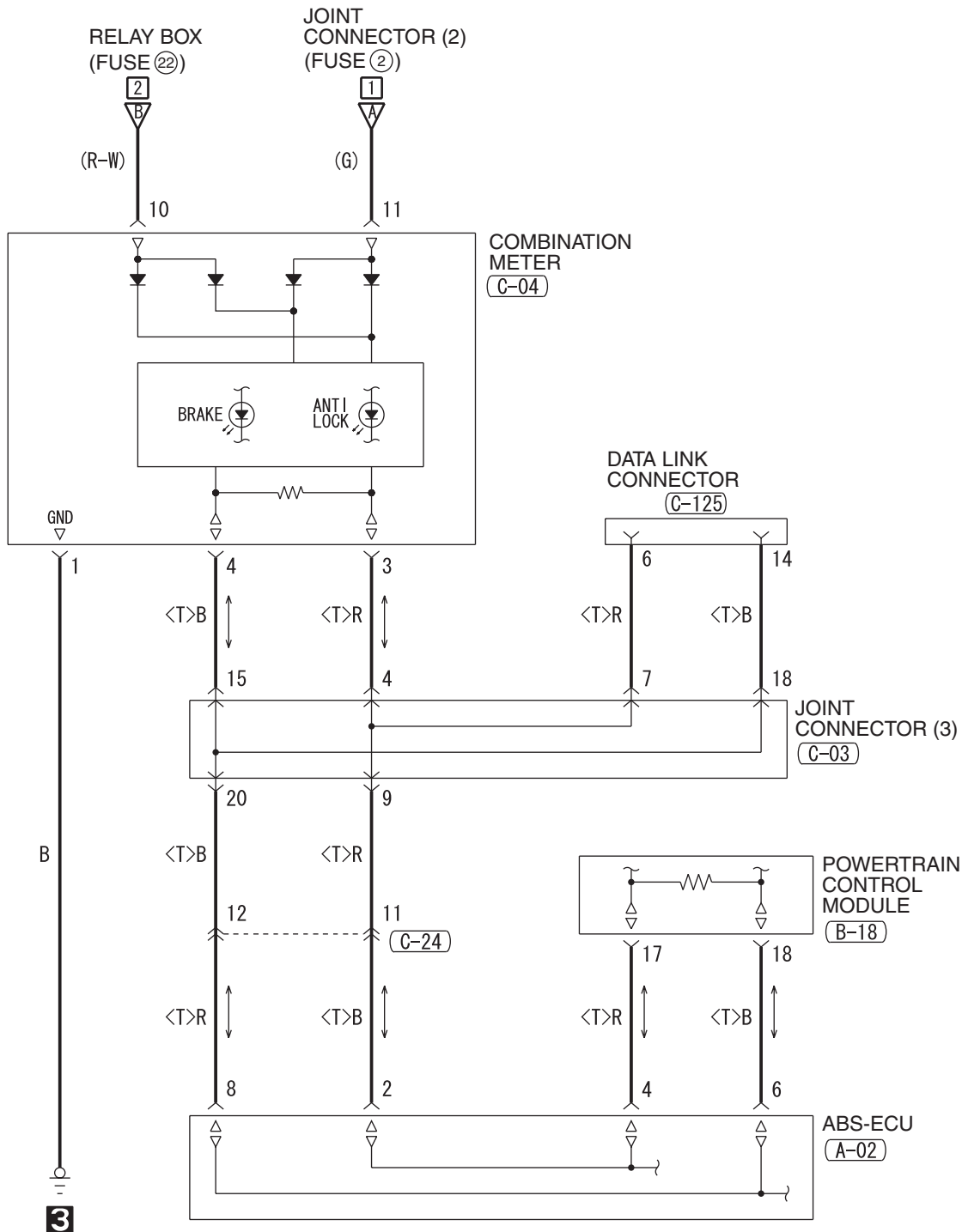

(A-02)

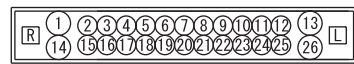

(C-125) FRONT SIDE
MU803797



(B-18)



(C-03)

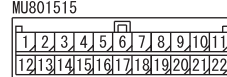

(C-04)

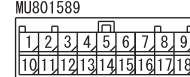

(C-24)

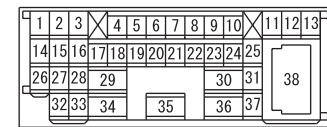

NOTES

ELECTRONIC BRAKE-FORCE DISTRIBUTION (EBD) AND ANTI-LOCK BRAKING SYSTEM (ABS) <VEHICLES WITH TRACTION CONTROL SYSTEM (TCL)>

M1901017100256

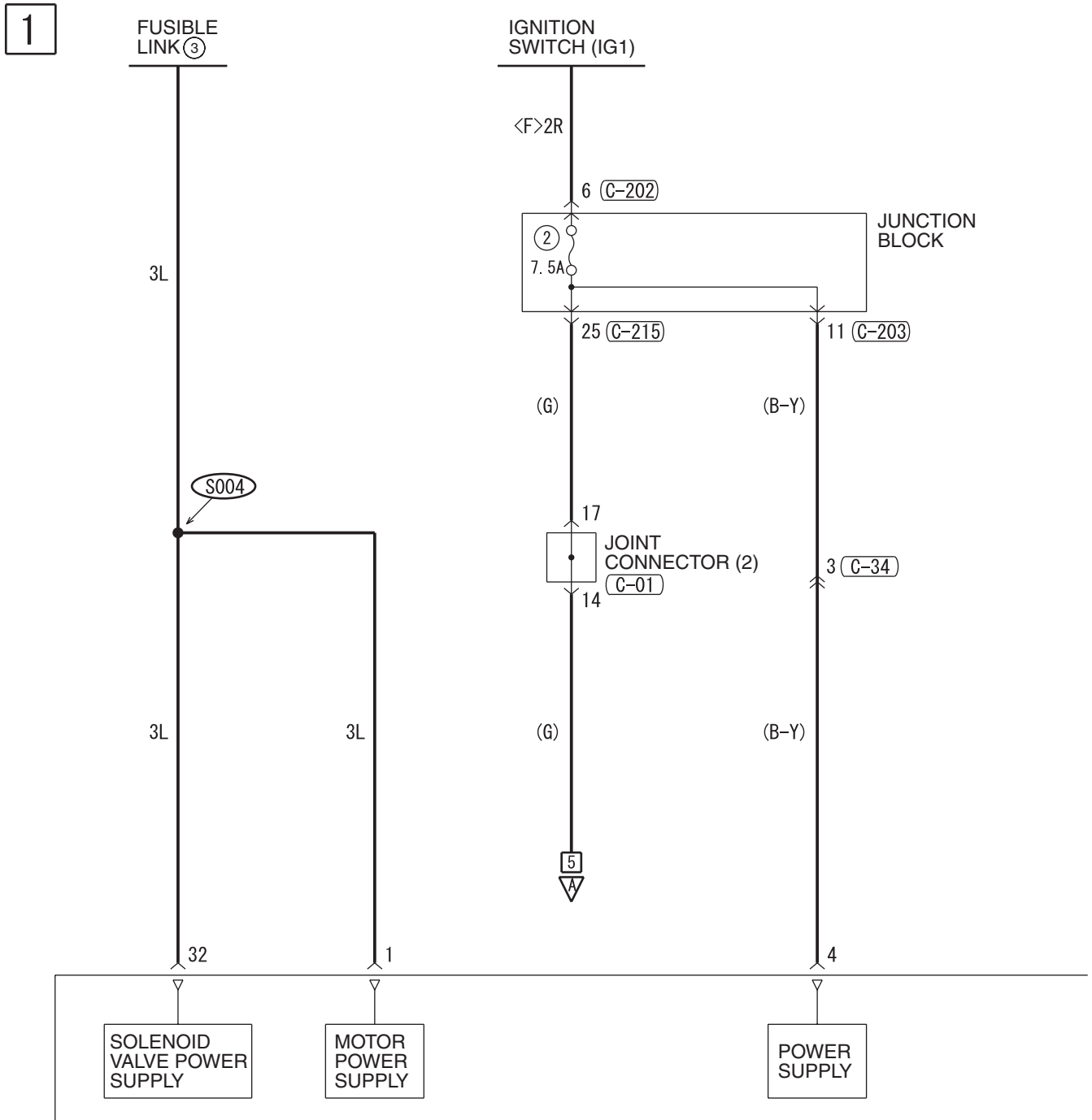

(A-03)

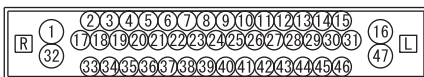

(C-01)



(C-24)

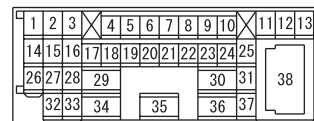

(C-28)



2

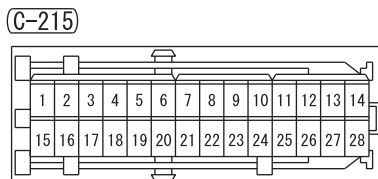
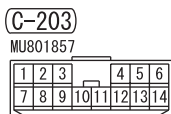
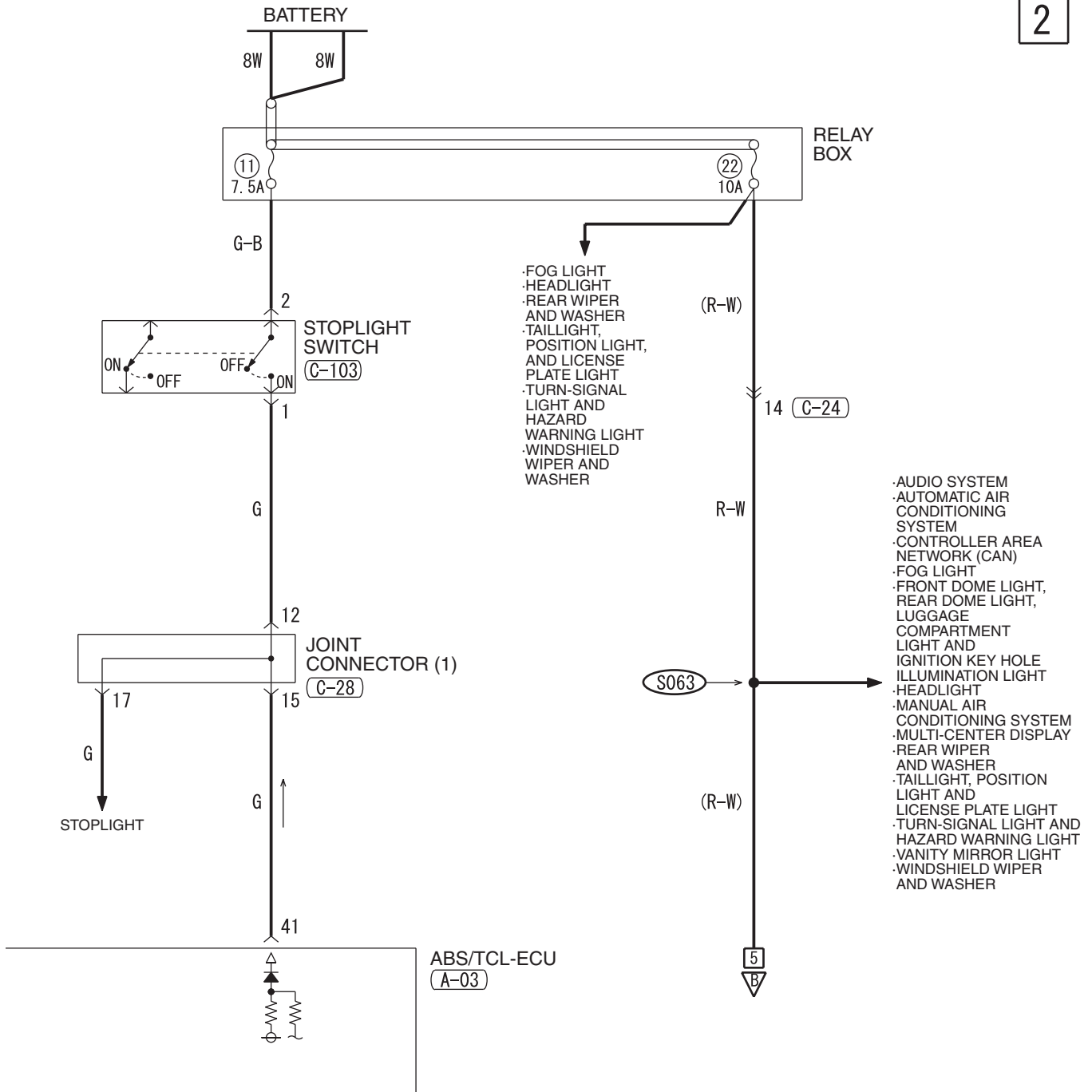

WIRE COLOR CODE
 B : BLACK SB : SKY BLUE
 BR : BROWN LG : LIGHT GREEN
 G : GREEN P : PINK GR : GRAY
 R : RED L : BLUE Y : YELLOW
 V : VIOLET W : WHITE O : ORANGE
 PU : PURPLE

H6P15M06AB

ELECTRONIC BRAKE-FORCE DISTRIBUTION (EBD) AND ANTI-LOCK BRAKING SYSTEM (ABS) <VEHICLES WITH TRACTION CONTROL SYSTEM (TCL)> (CONTINUED)

3

ABS/TCL-ECU (A-03)

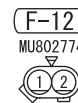
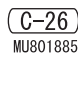
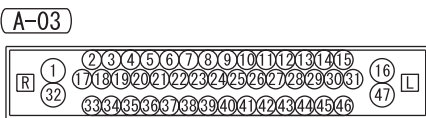
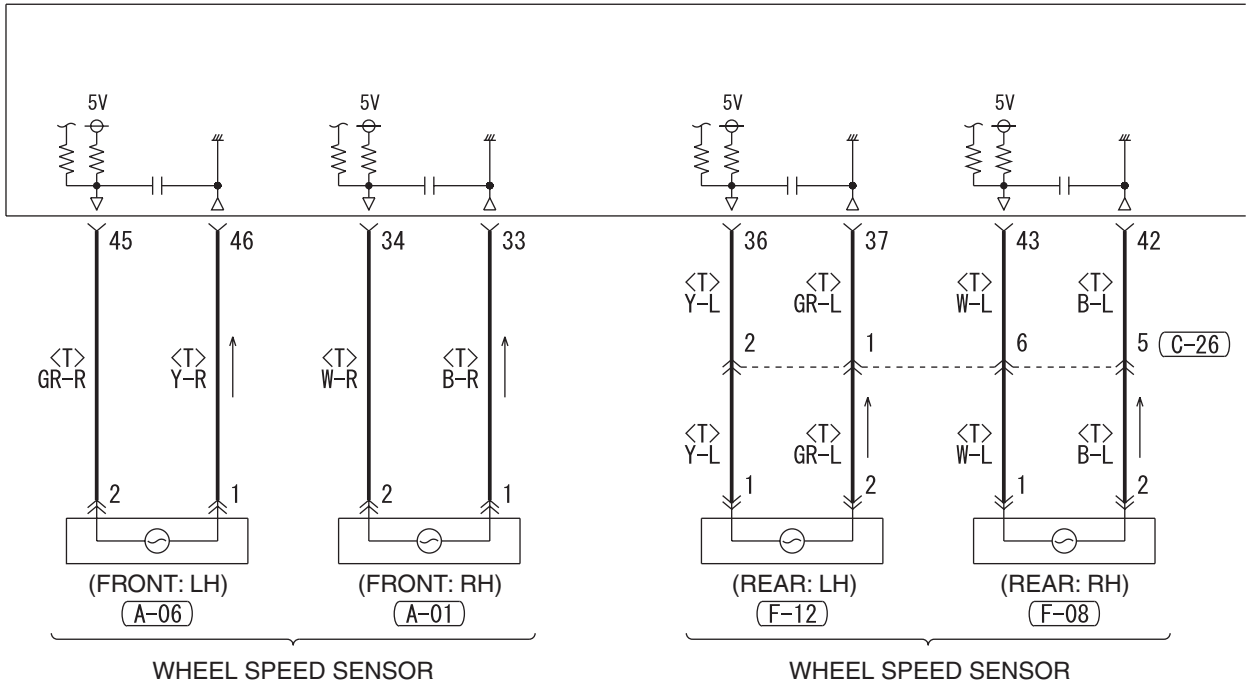

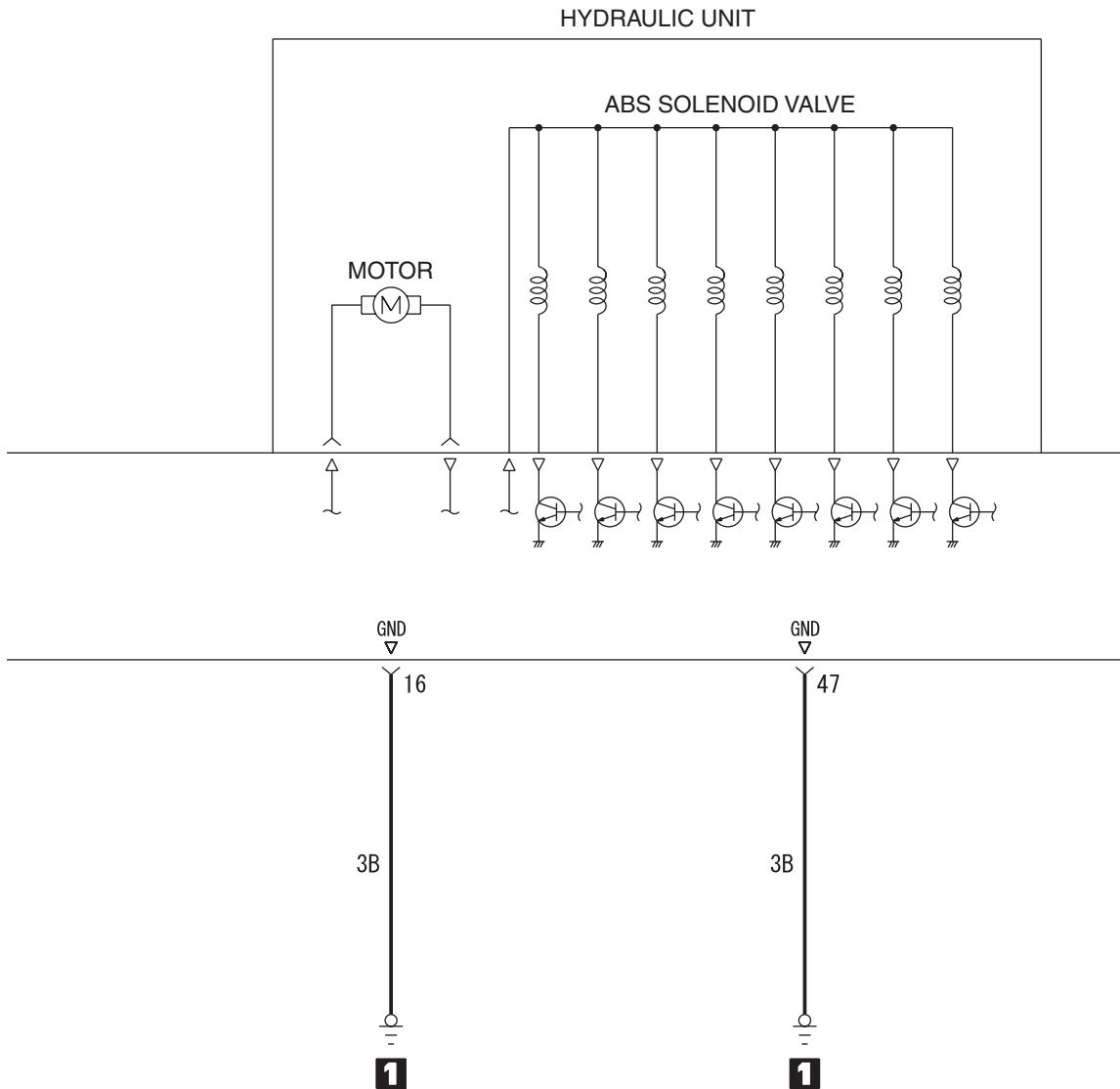

WIRE COLOR CODE
B:BLACK LG:LIGHT GREEN G:GREEN L:BLUE W:WHITE Y:YELLOW SB:SKY BLUE
BR:BROWN O:ORANGE GR:GRAY R:RED P:PINK V:VIOLET PU:PURPLE

H6P15M06BB

ELECTRONIC BRAKE-FORCE DISTRIBUTION (EBD) AND ANTI-LOCK BRAKING SYSTEM (ABS) <VEHICLES WITH TRACTION CONTROL SYSTEM (TCL)> (CONTINUED)

5

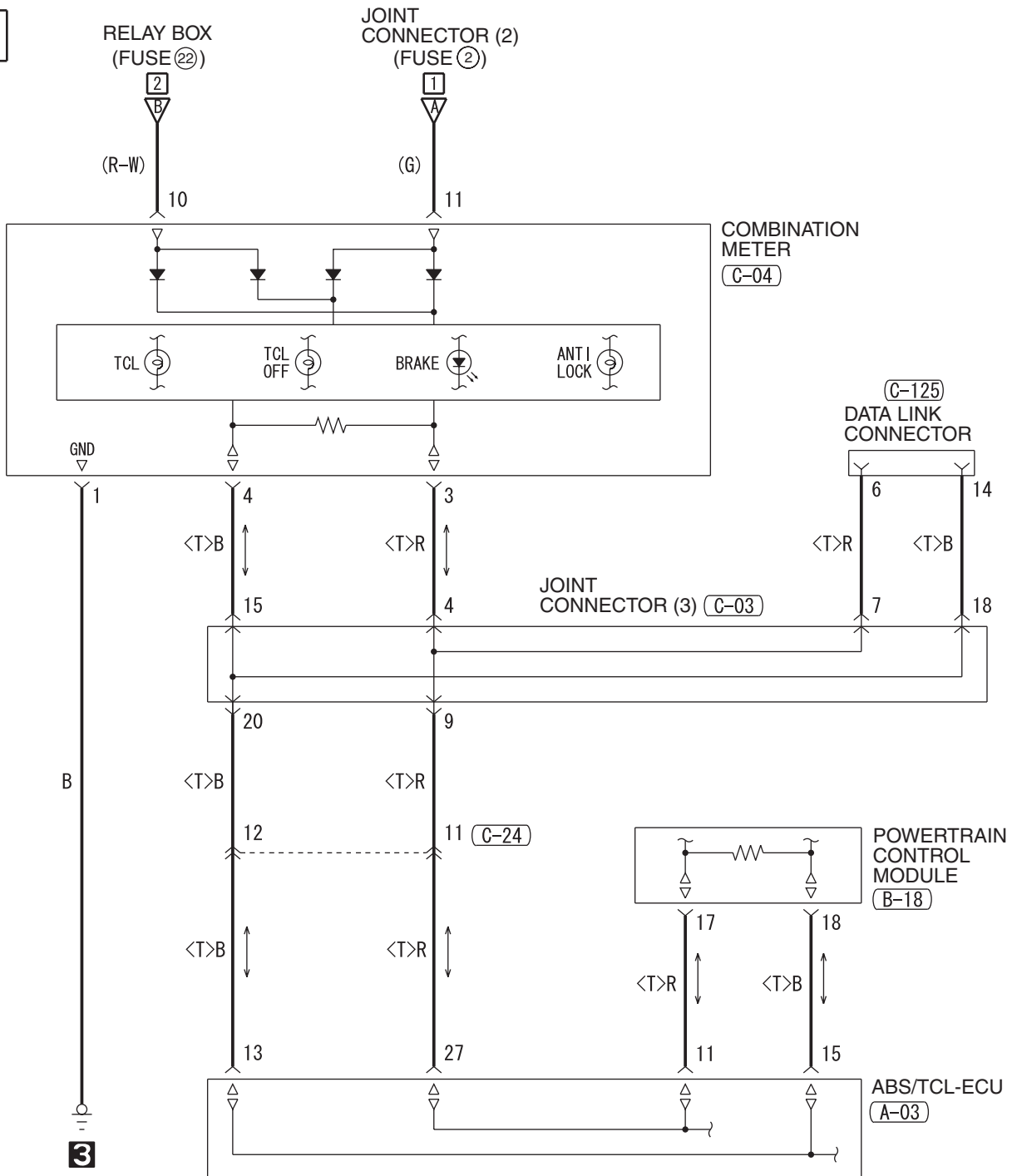

A-03

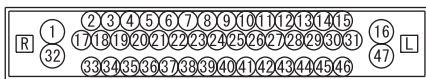

B-18

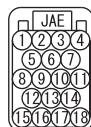

C-03

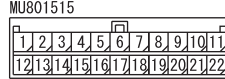

C-04

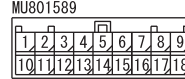

C-24

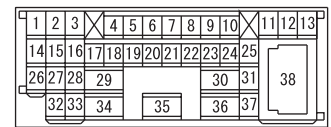

6

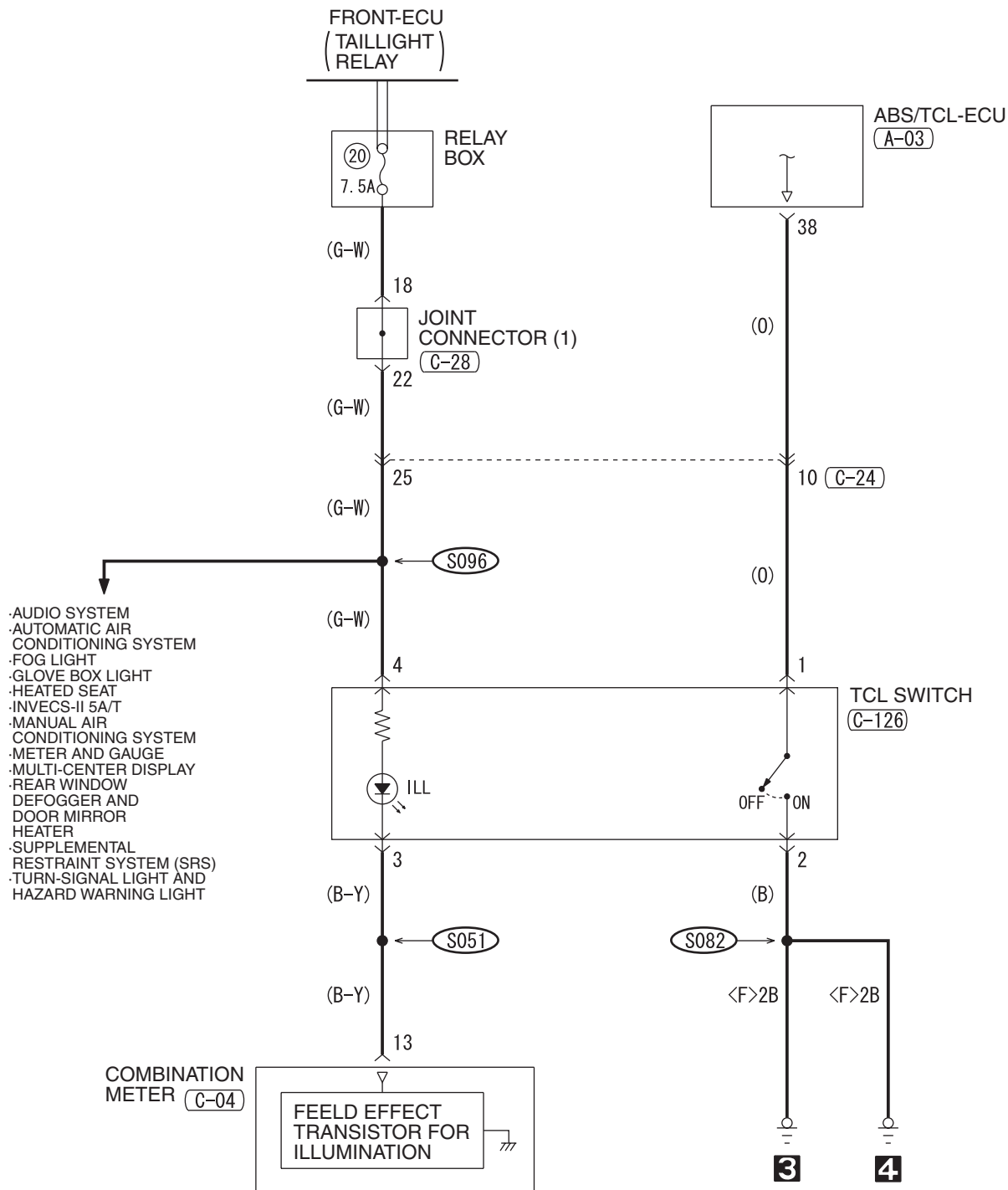

(C-28)



(C-125) FRONT SIDE

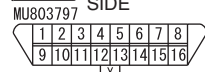

(C-126)

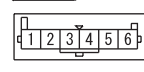

WIRE COLOR CODE

B : BLACK LG : LIGHT GREEN G : GREEN L : BLUE W : WHITE Y : YELLOW SB : SKY BLUE
 BR : BROWN O : ORANGE GR : GRAY R : RED P : PINK V : VIOLET PU : PURPLE

H5P15M06CB

TSB Revision

ENGINE IMMOBILIZER SYSTEM <2.4L ENGINE-M/T>

M1901013601939

1

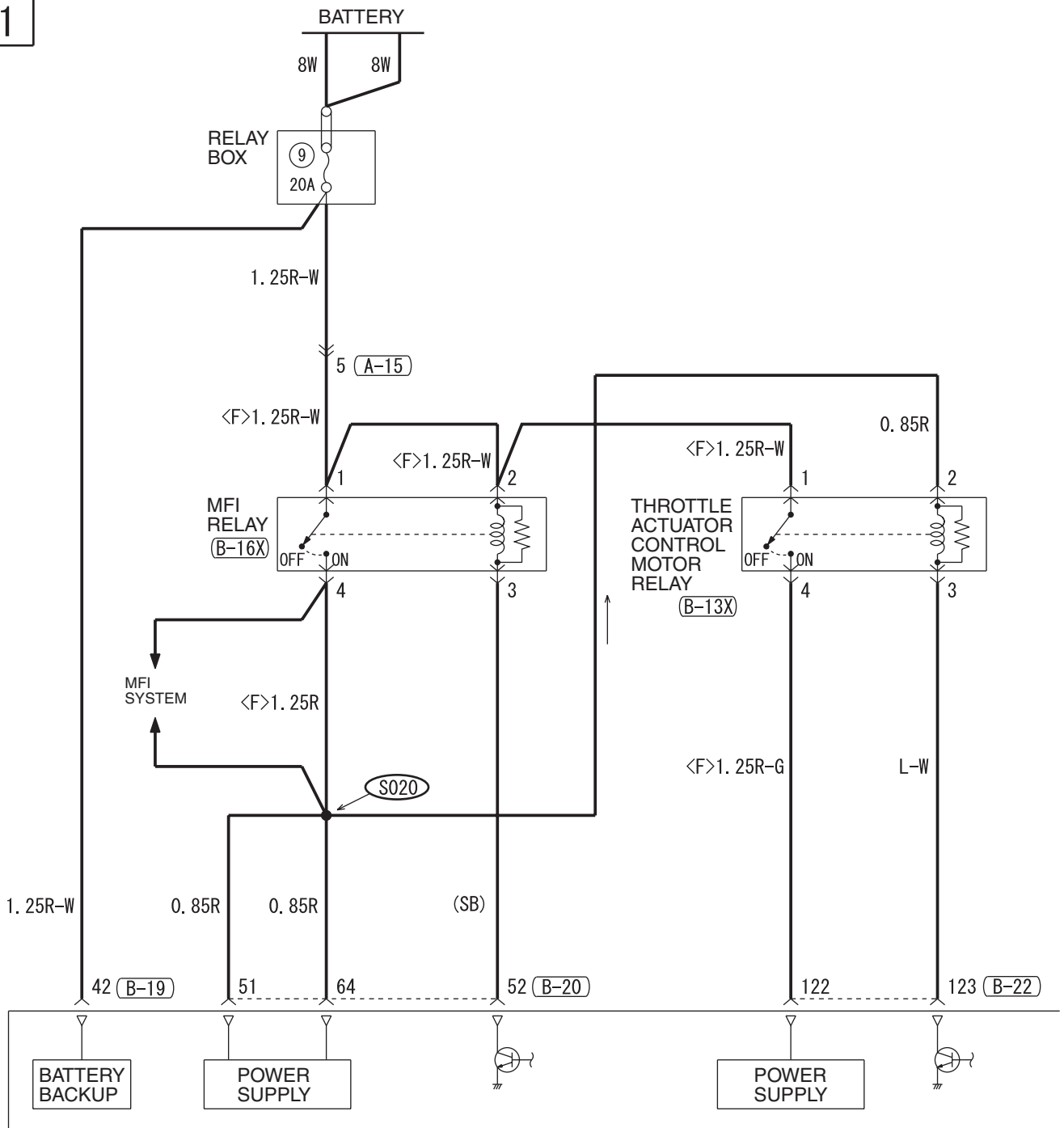

(A-02)

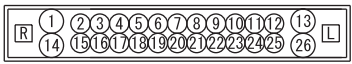

(A-15)

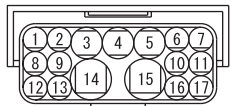

(B-13X)



(B-16X)



(B-18)

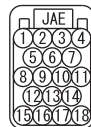

(B-19)



(B-20)

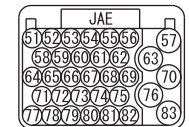

2

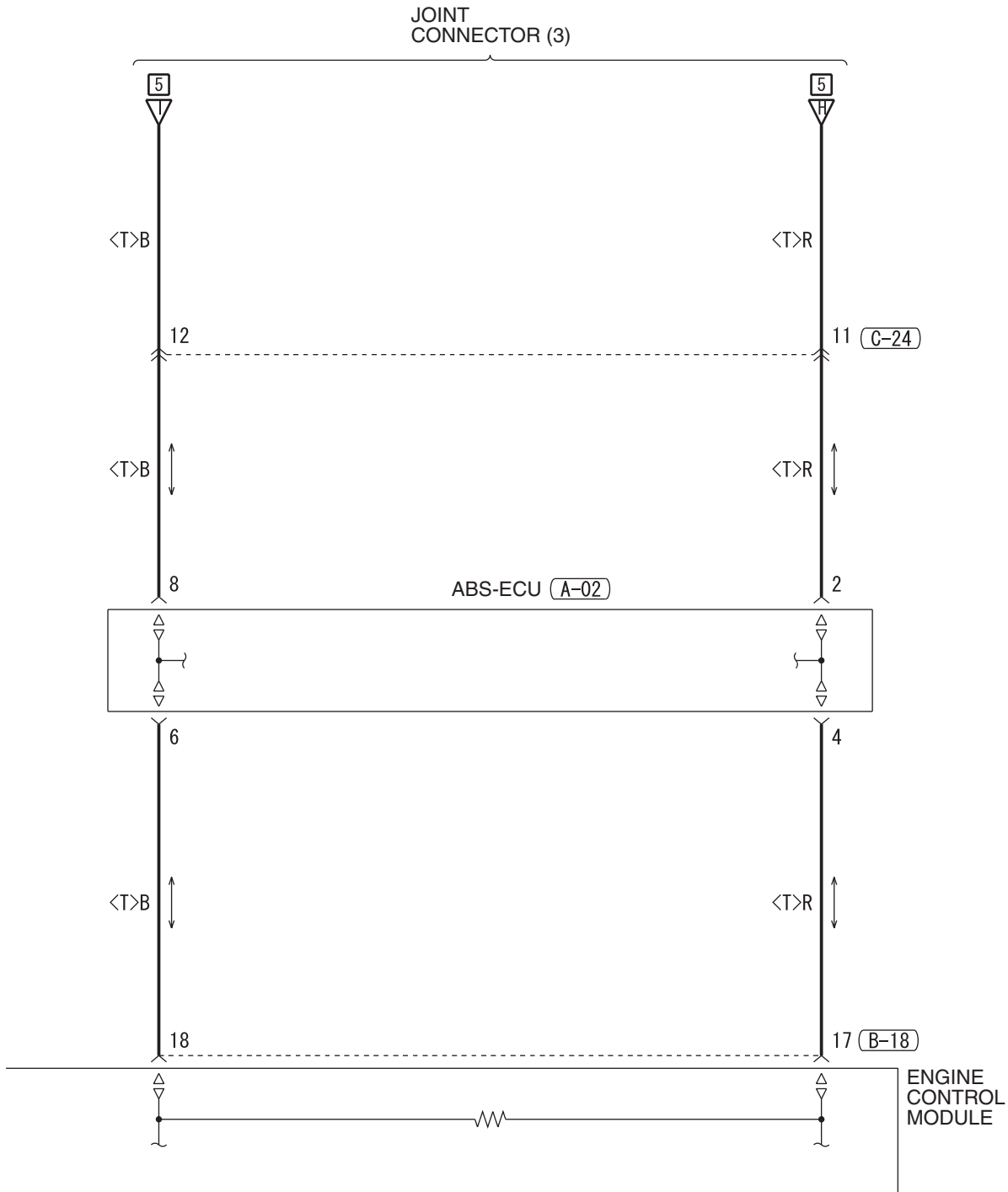

(B-22)

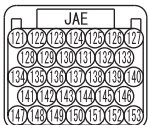

(C-24)

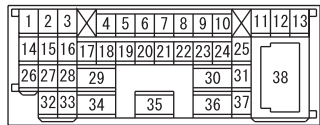

WIRE COLOR CODE
 B : BLACK LG : LIGHT GREEN G : GREEN L : BLUE
 BR : BROWN O : ORANGE GR : GRAY R : RED W : WHITE
 SB : SKY BLUE P : PINK Y : YELLOW V : VIOLET PU : PURPLE

H6P15M09AB

TSB Revision

ENGINE IMMOBILIZER SYSTEM <2.4L ENGINE-M/T> (CONTINUED)

3

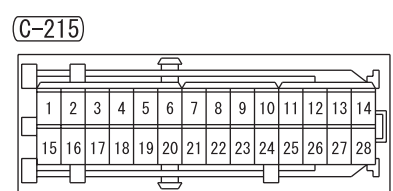
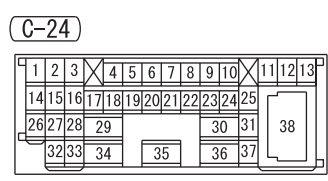
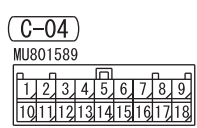
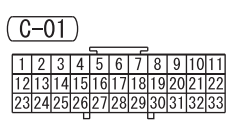
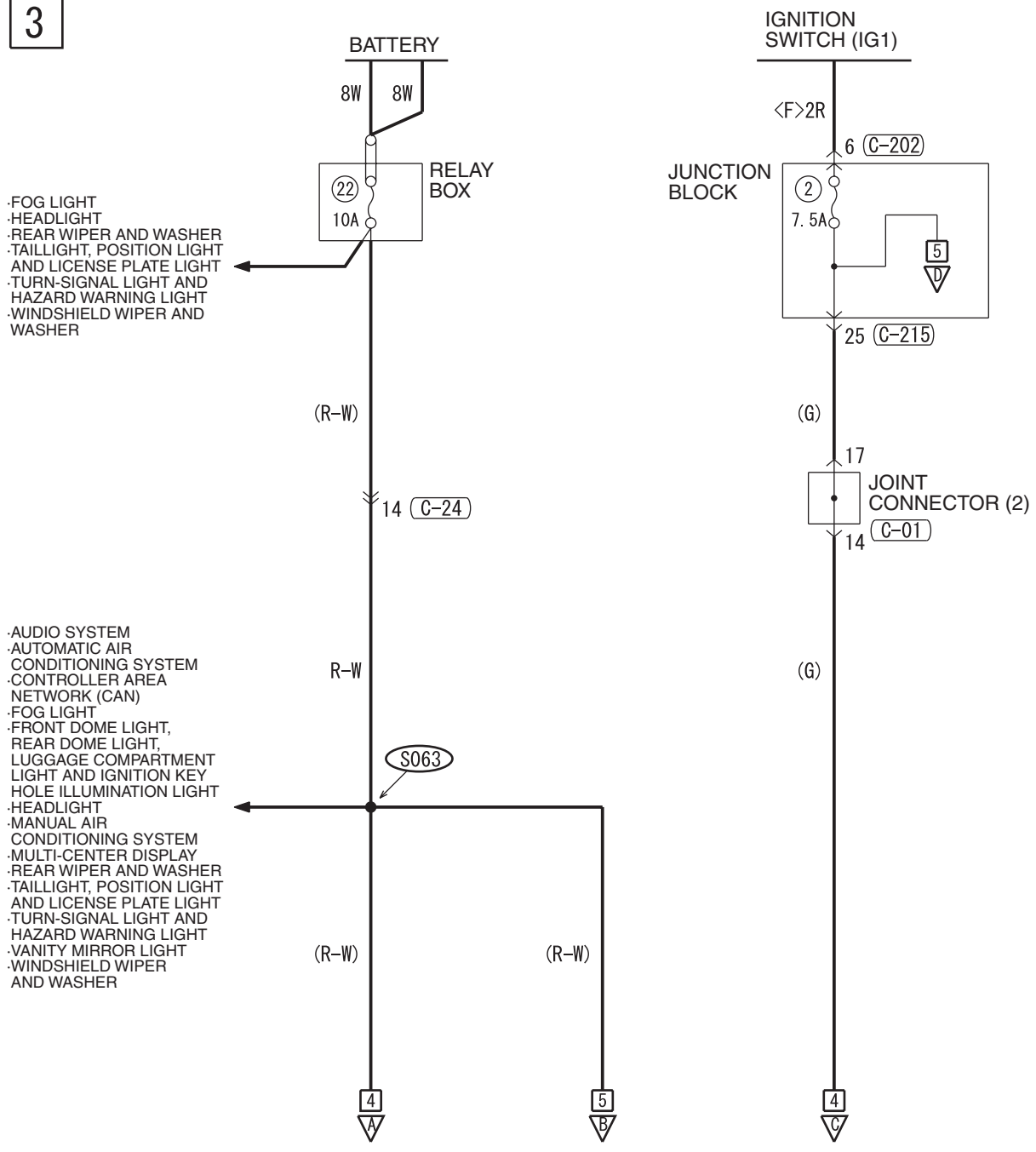

4

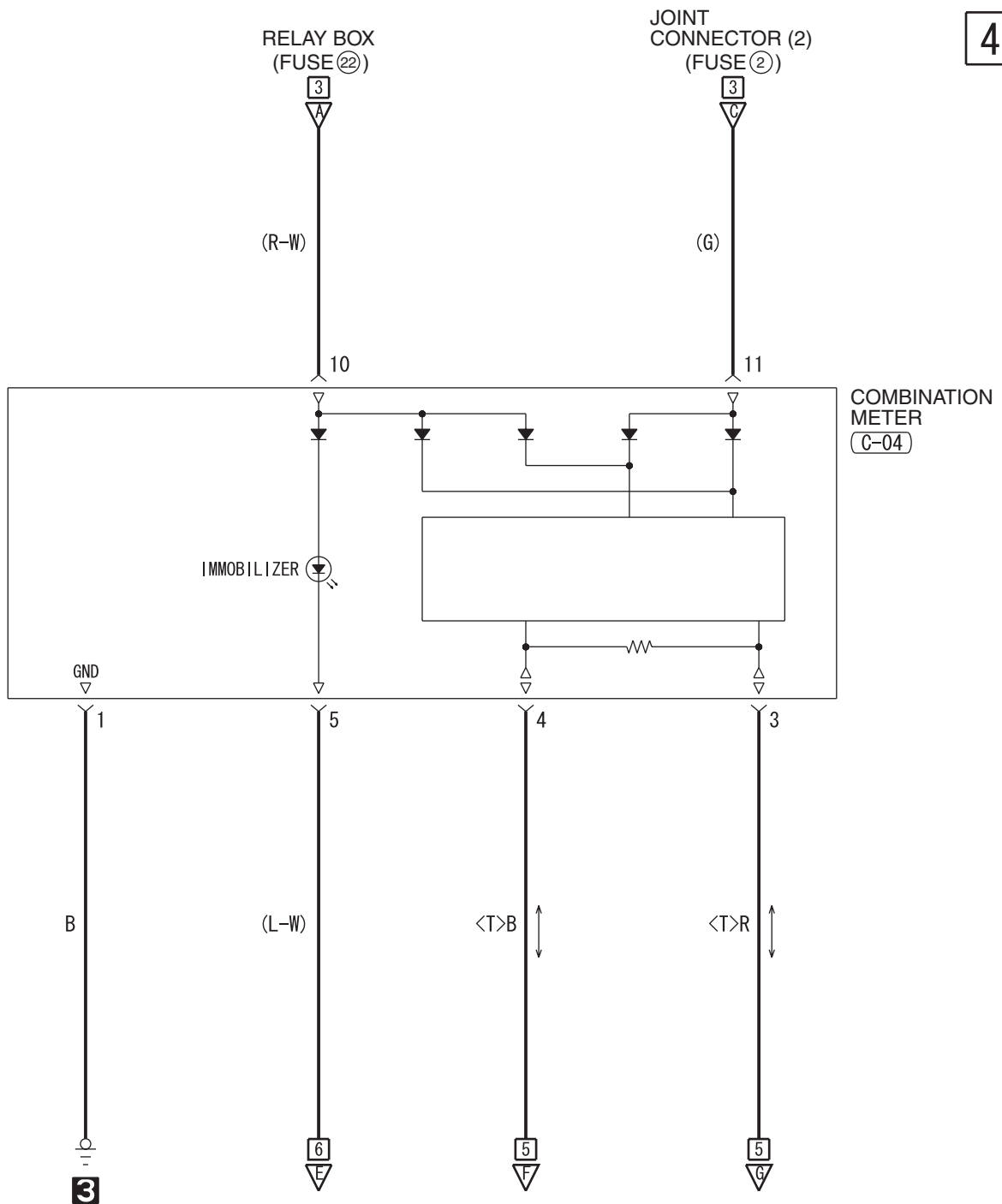

WIRE COLOR CODE
 B: BLACK LG: LIGHT GREEN G: GREEN L: BLUE W: WHITE Y: YELLOW SB: SKY BLUE
 BR: BROWN O: ORANGE GR: GRAY R: RED P: PINK V: VIOLET PU: PURPLE

H6P15M09BB

TSB Revision

ENGINE IMMOBILIZER SYSTEM <2.4L ENGINE-M/T> (CONTINUED)

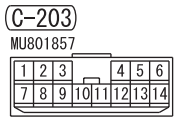
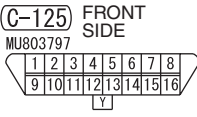
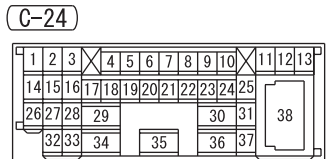
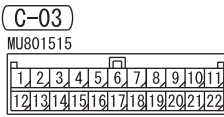
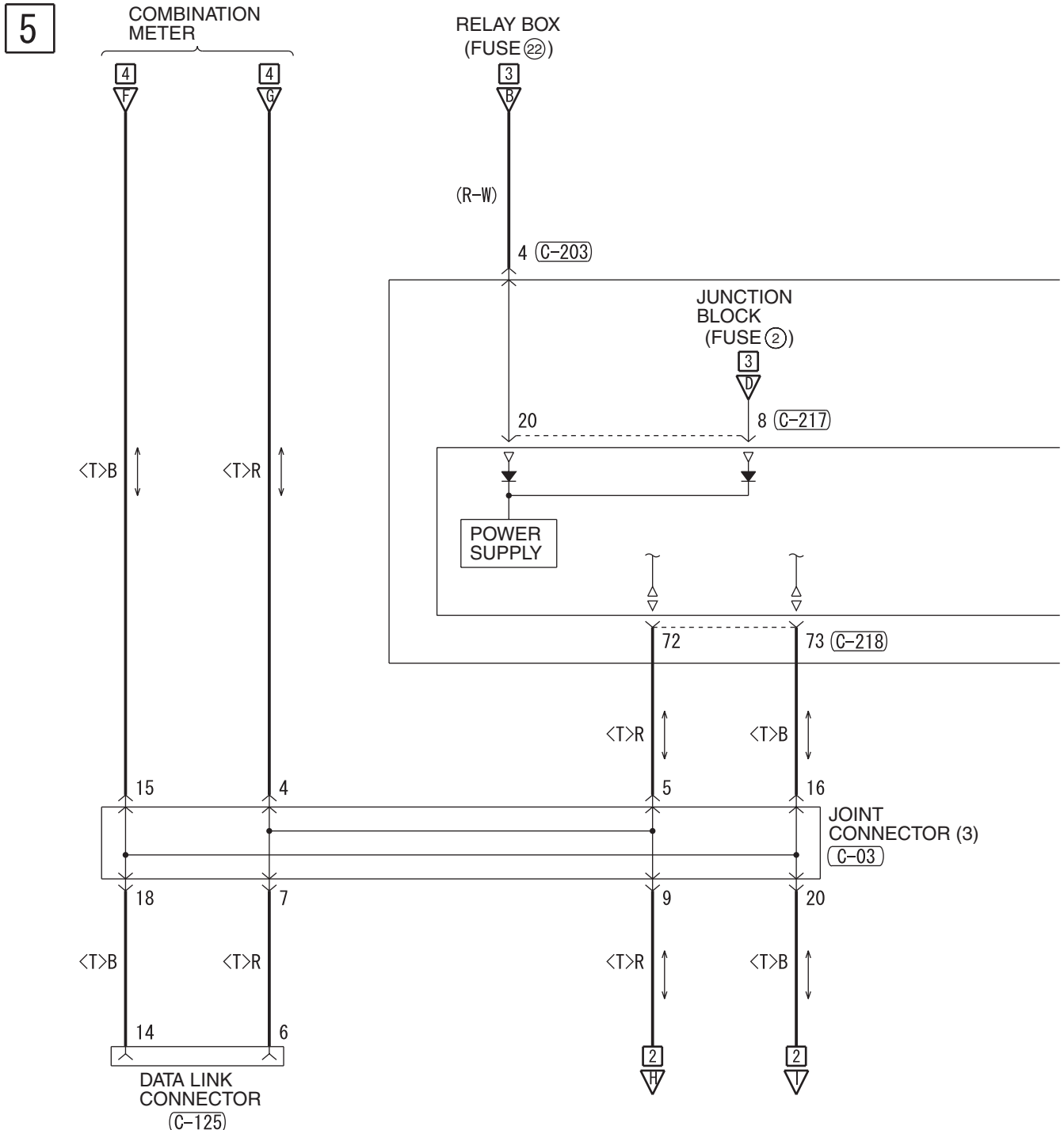

6

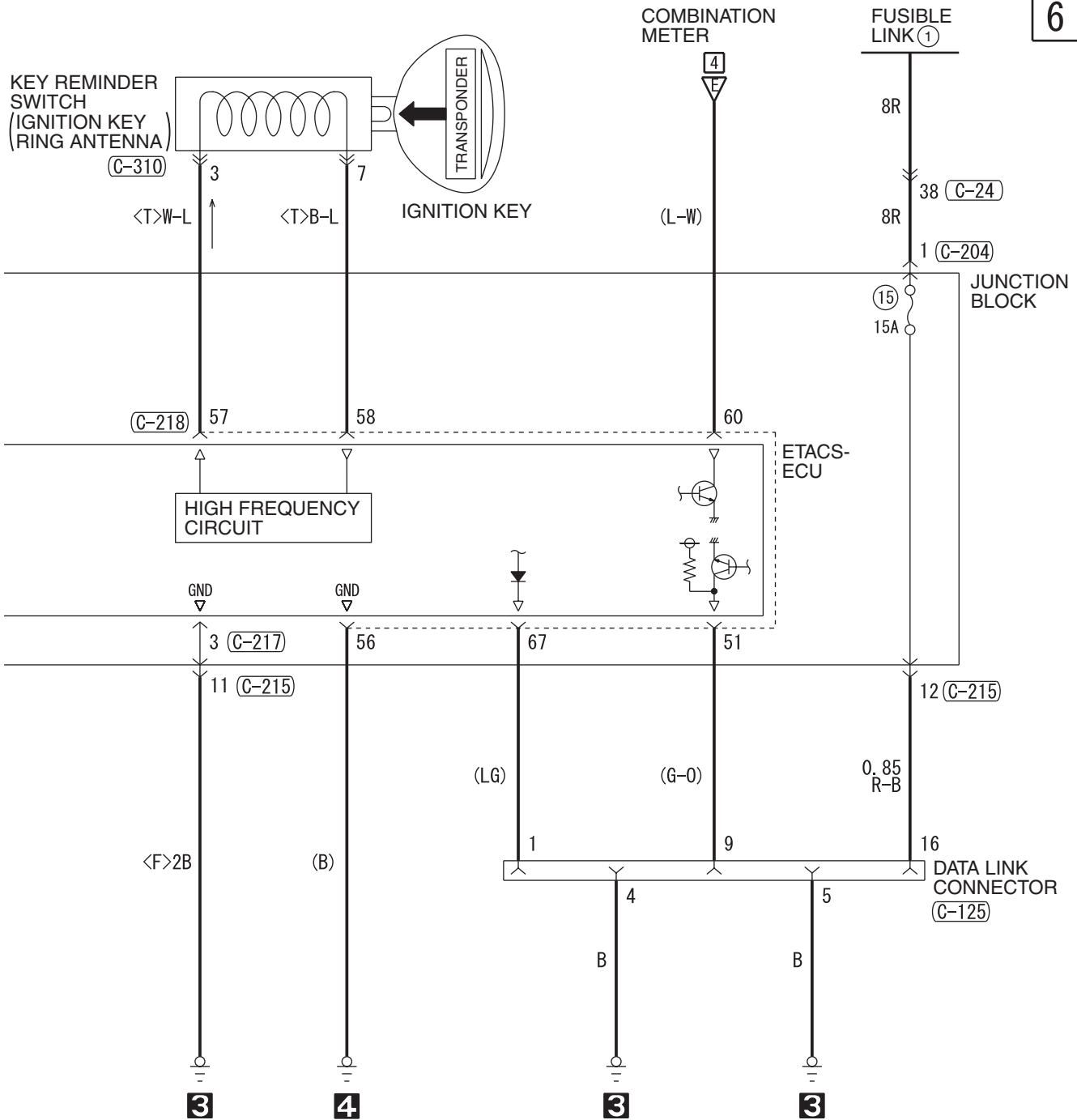

(C-215)

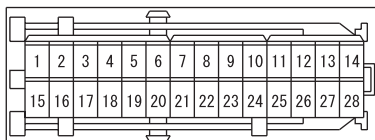

(C-217) JUNCTION BLOCK SIDE

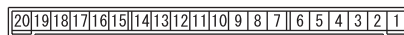

(C-218) (MU803766)



(C-310) MU801547

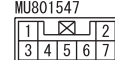

WIRE COLOR CODE
 B : BLACK LG : LIGHT GREEN G : GREEN L : BLUE
 BR : BROWN O : ORANGE GR : GRAY R : RED W : WHITE
 SB : SKY BLUE P : PINK Y : YELLOW V : VIOLET PU : PURPLE

H6P15M09CB

ENGINE IMMOBILIZER SYSTEM <2.4L ENGINE-A/T>

M1901013601940

1

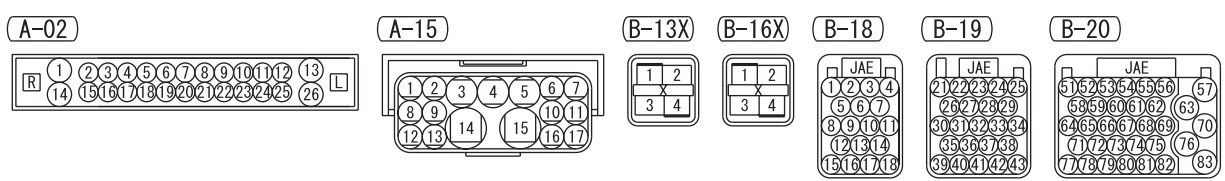
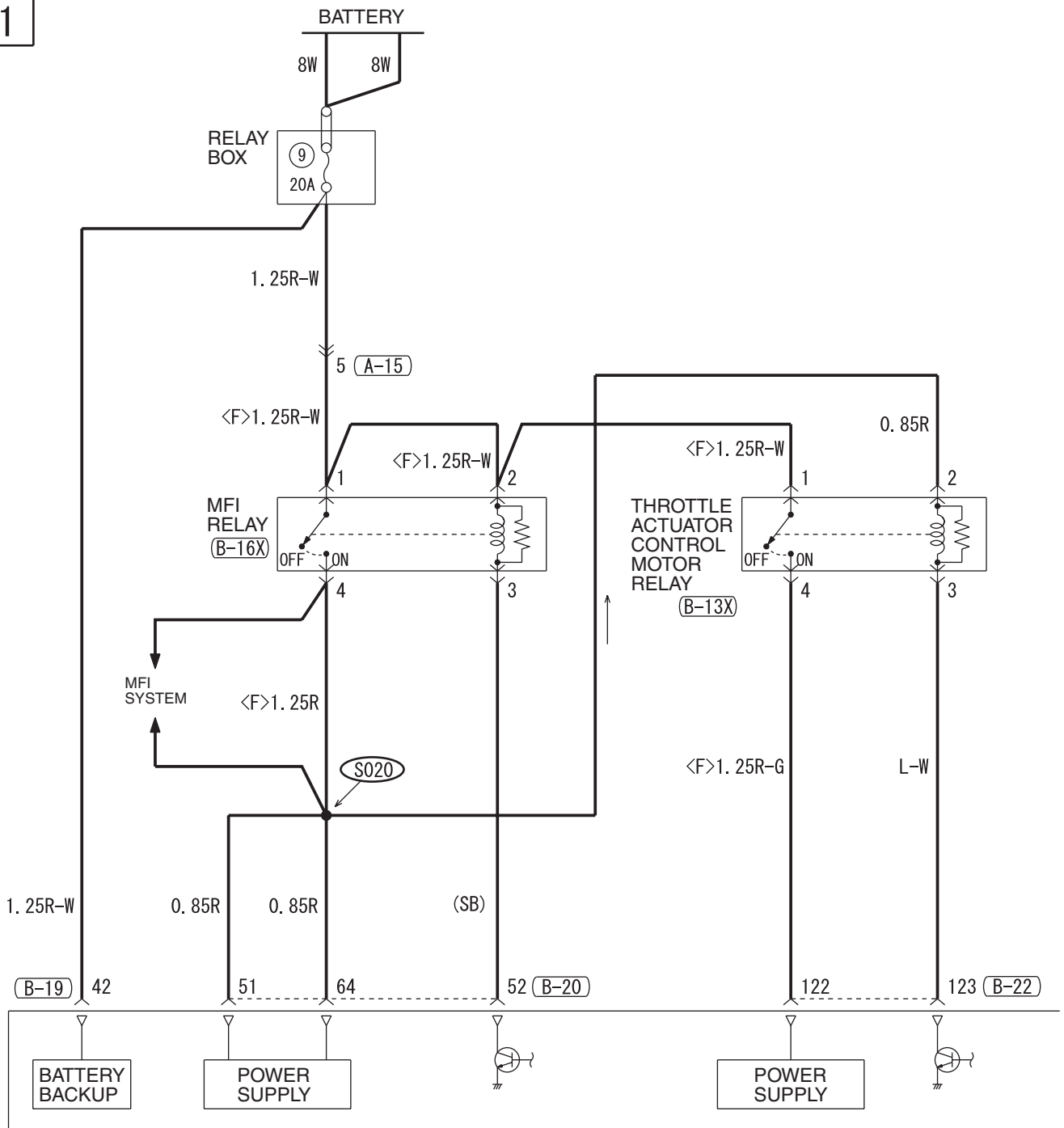

2

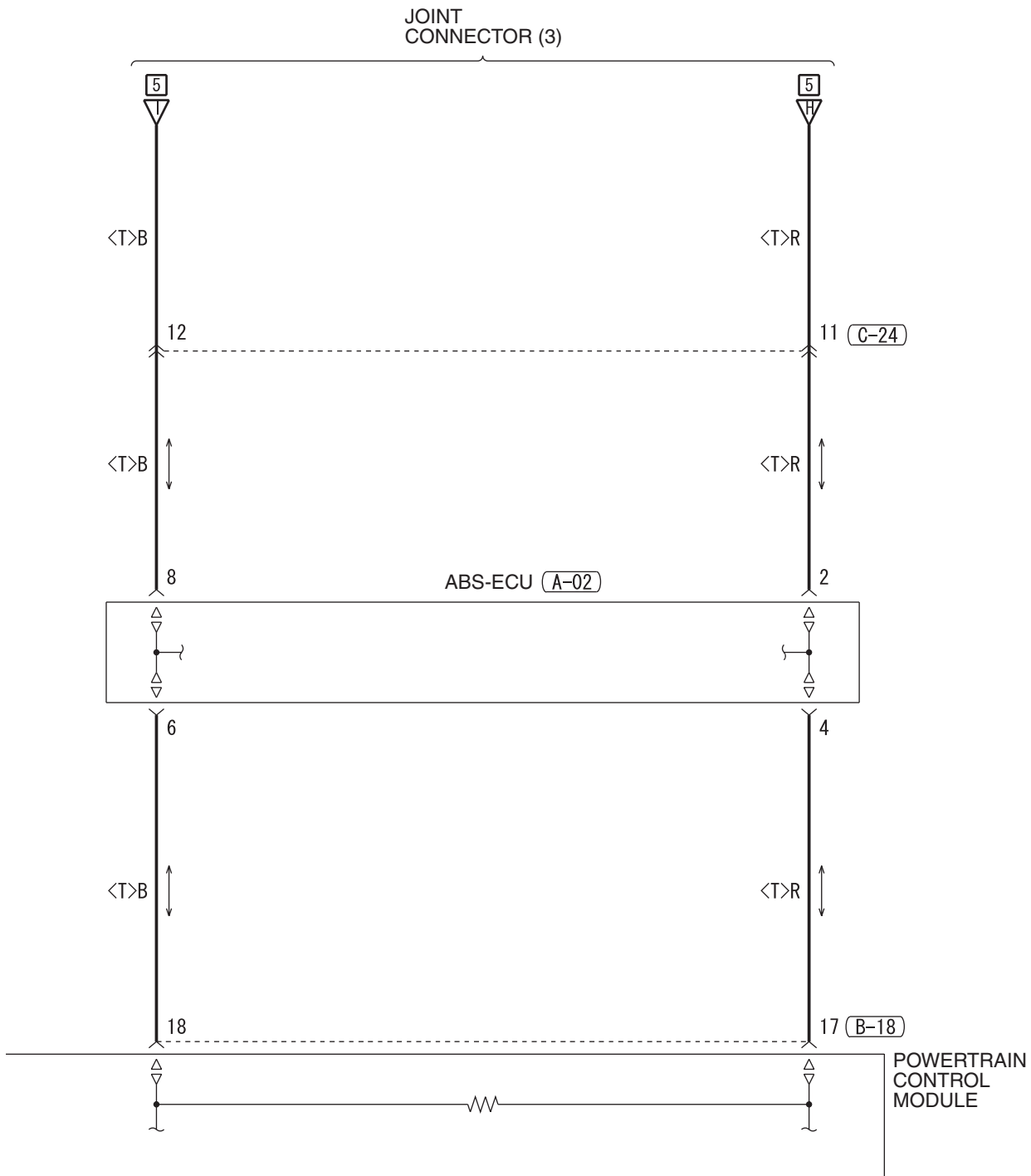

(B-22)

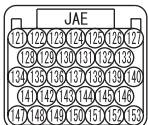

(C-24)

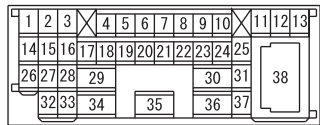

WIRE COLOR CODE
 B : BLACK LG : LIGHT GREEN G : GREEN L : BLUE
 BR : BROWN O : ORANGE GR : GRAY R : RED W : WHITE
 SB : SKY BLUE P : PINK Y : YELLOW V : VIOLET PU : PURPLE

TSB Revision

ENGINE IMMOBILIZER SYSTEM <2.4L ENGINE-A/T> (CONTINUED)

3

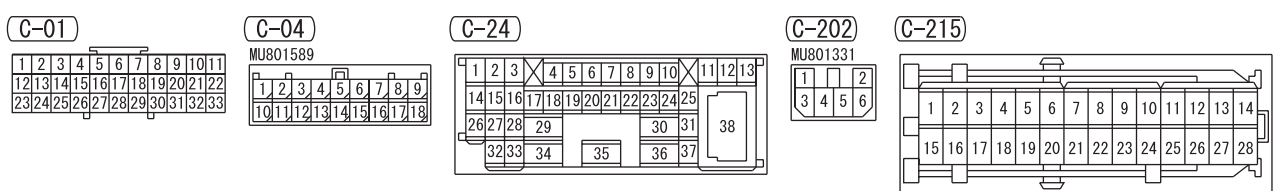
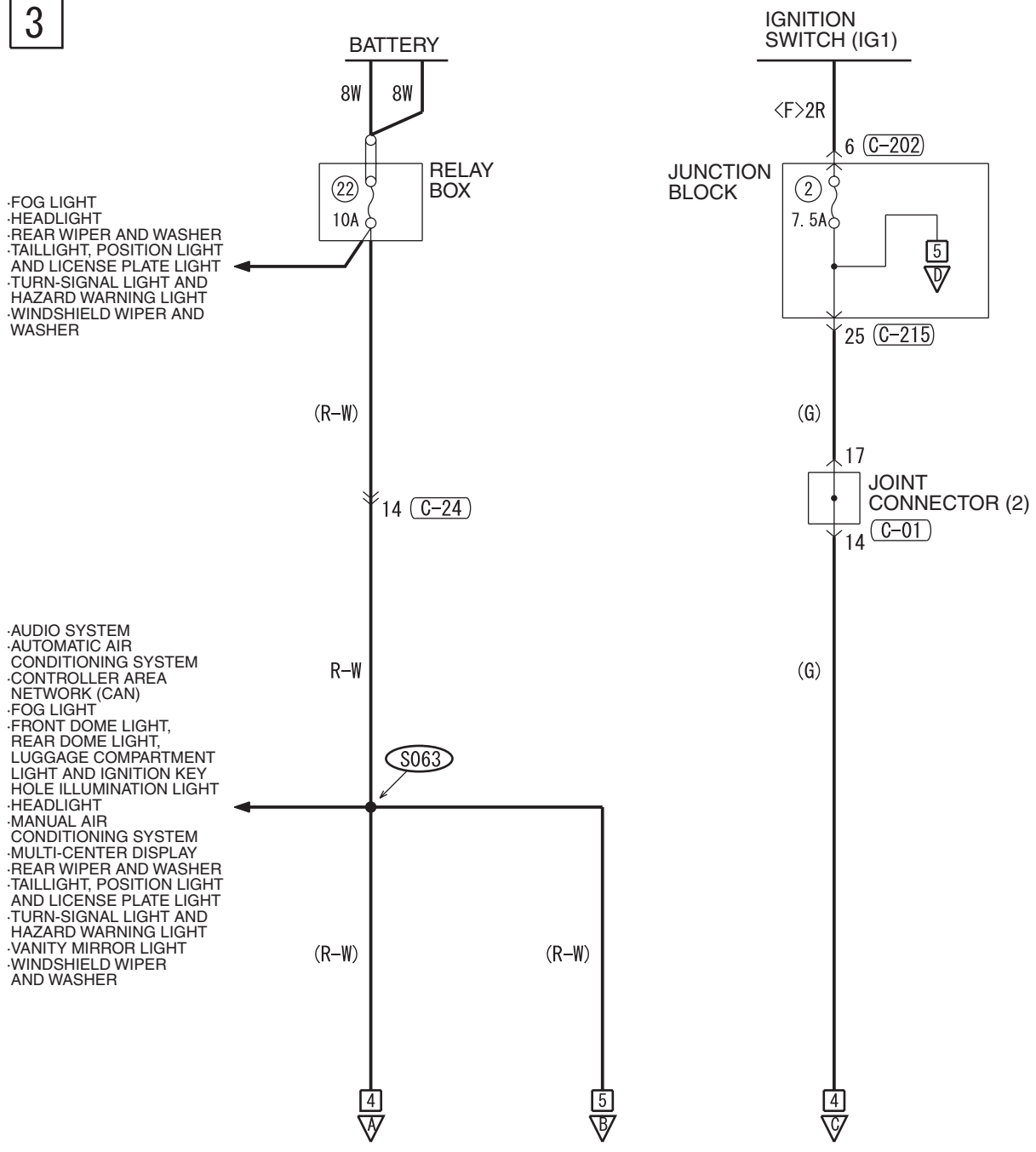

4

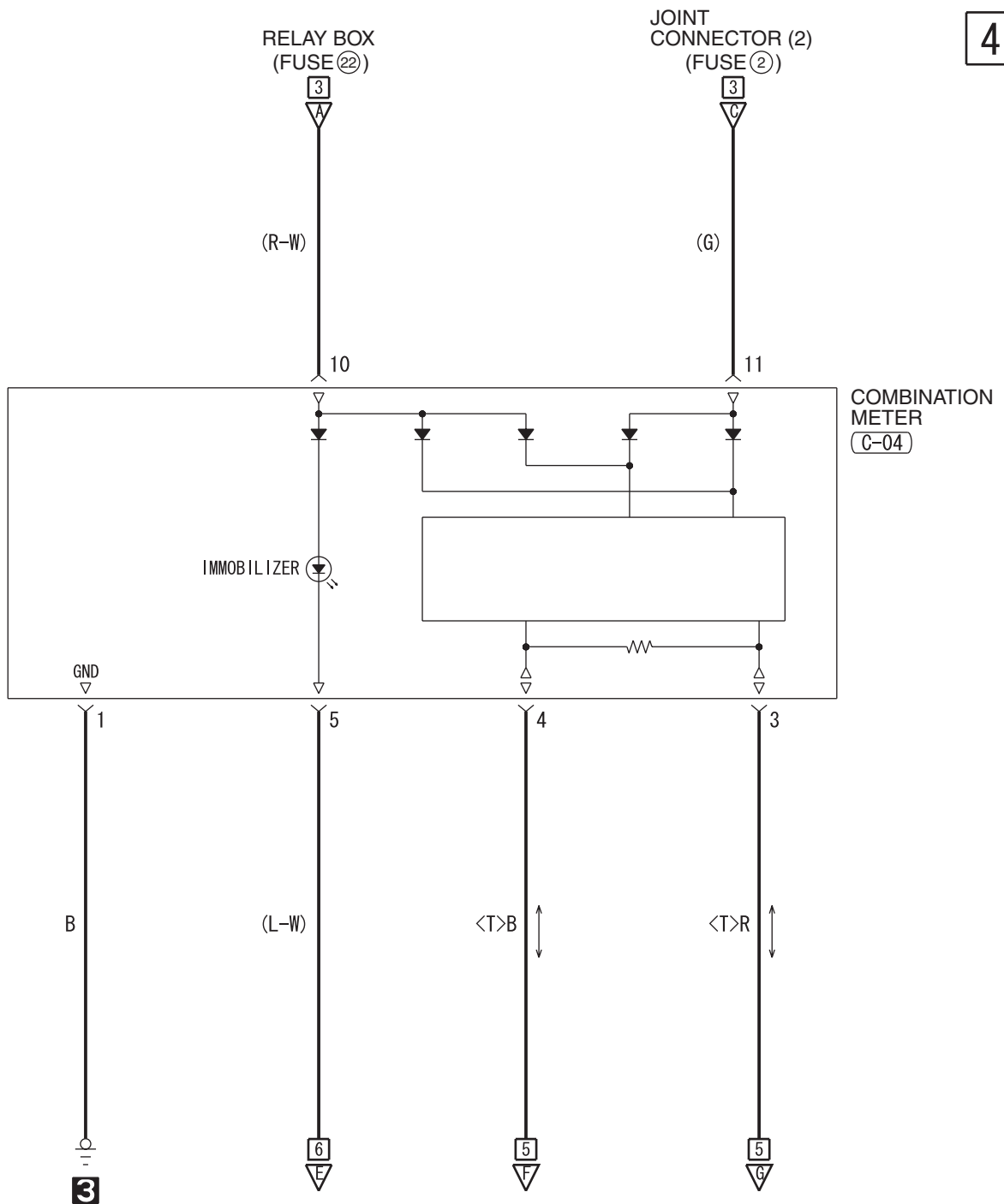

ENGINE IMMOBILIZER SYSTEM <2.4L ENGINE-A/T> (CONTINUED)

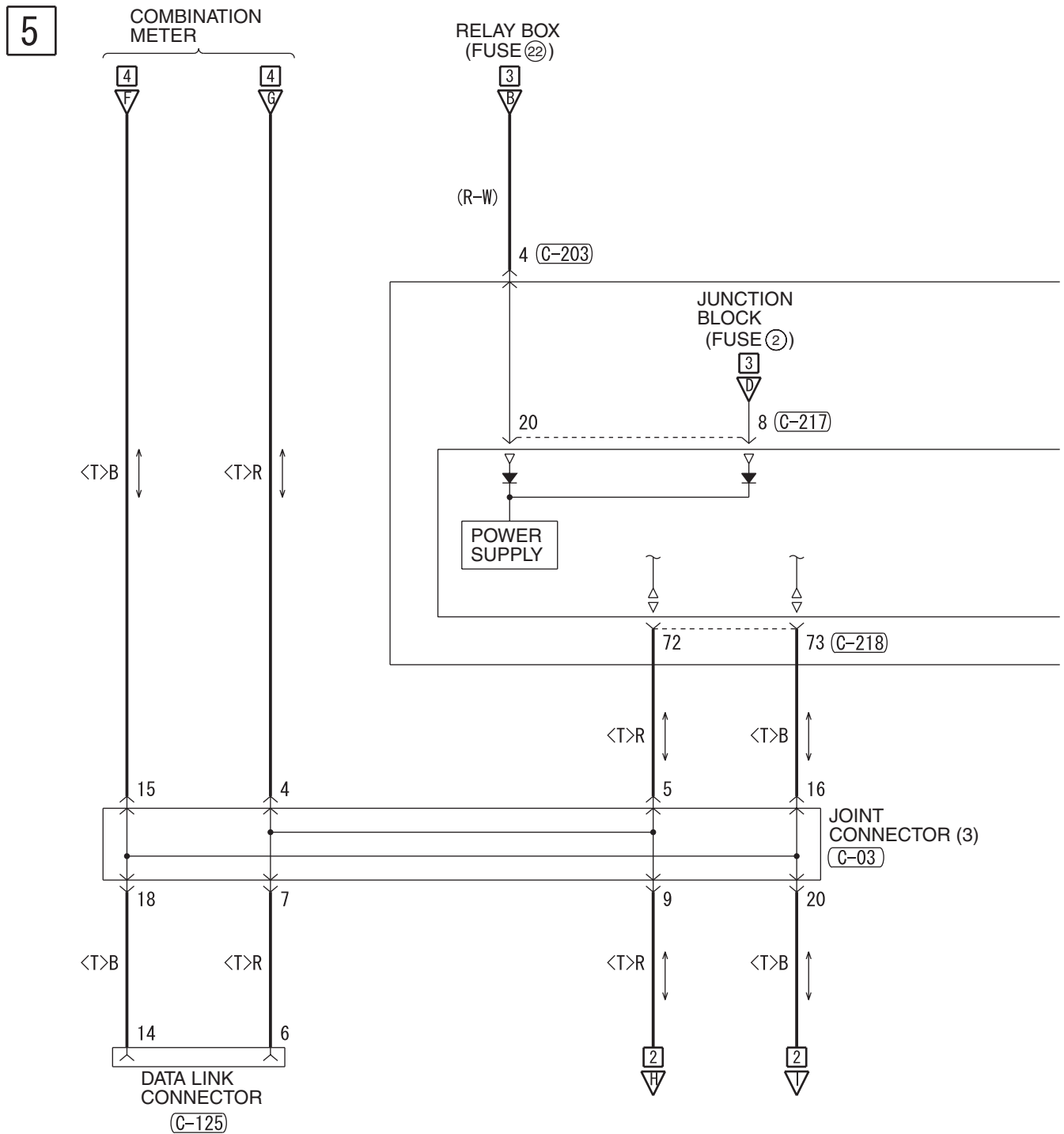

(C-03)

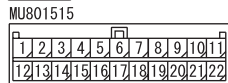

(C-24)

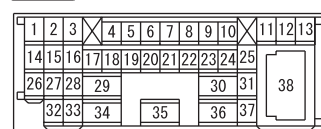

(C-125) FRONT SIDE

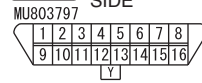

(C-203)

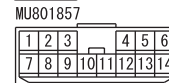

(C-204)



6

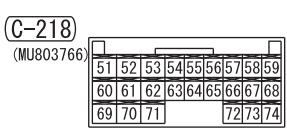
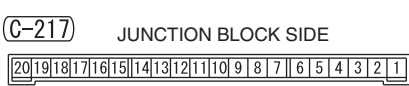
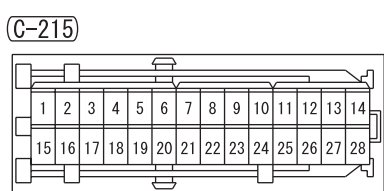
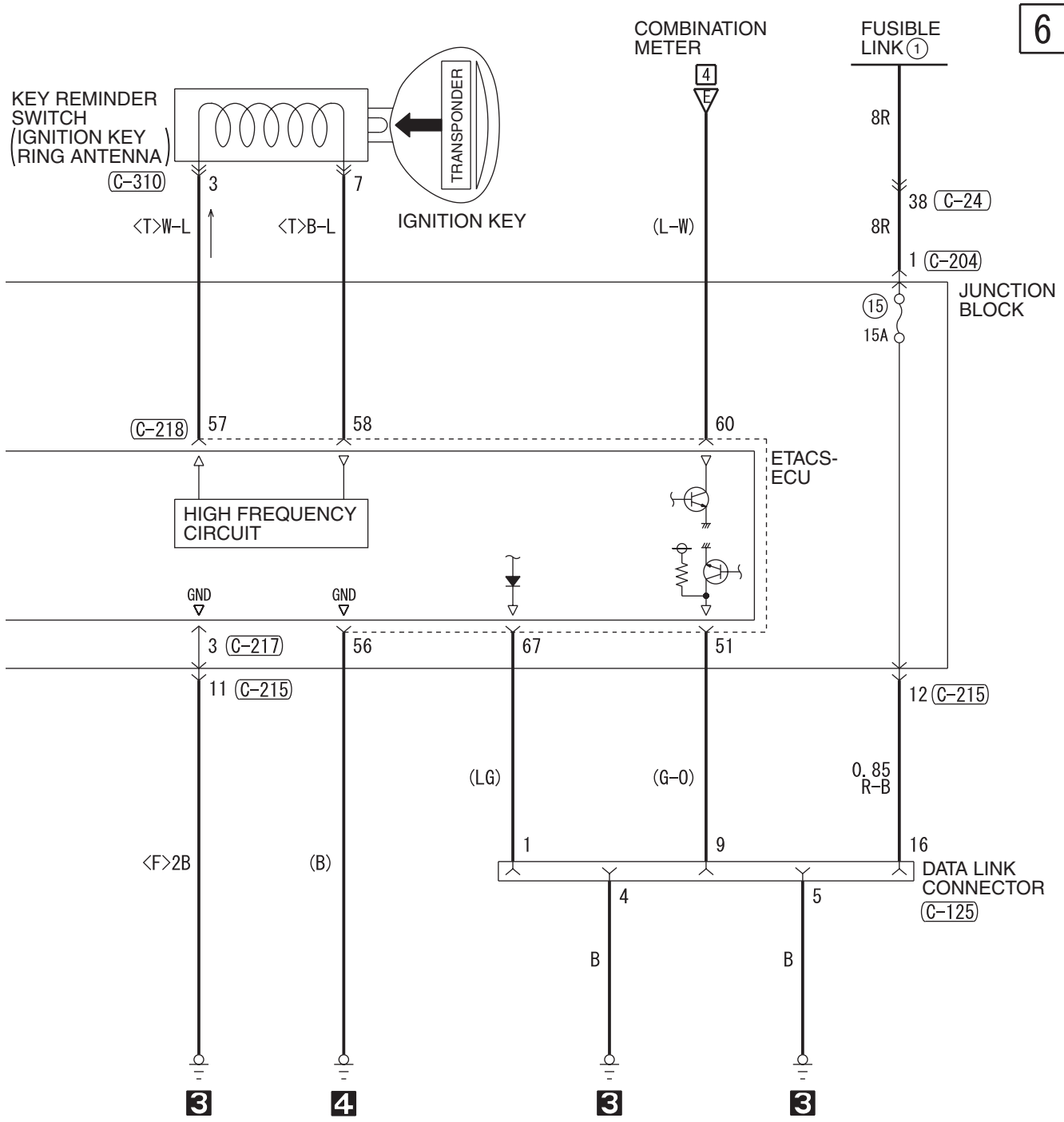

WIRE COLOR CODE
 B : BLACK LG : LIGHT GREEN G : GREEN L : BLUE
 BR : BROWN O : ORANGE GR : GRAY R : RED W : WHITE
 SB : SKY BLUE P : PINK Y : YELLOW V : VIOLET PU : PURPLE

TSB Revision

ENGINE IMMOBILIZER SYSTEM <3.8L ENGINE-M/T>

M1901013601951

1

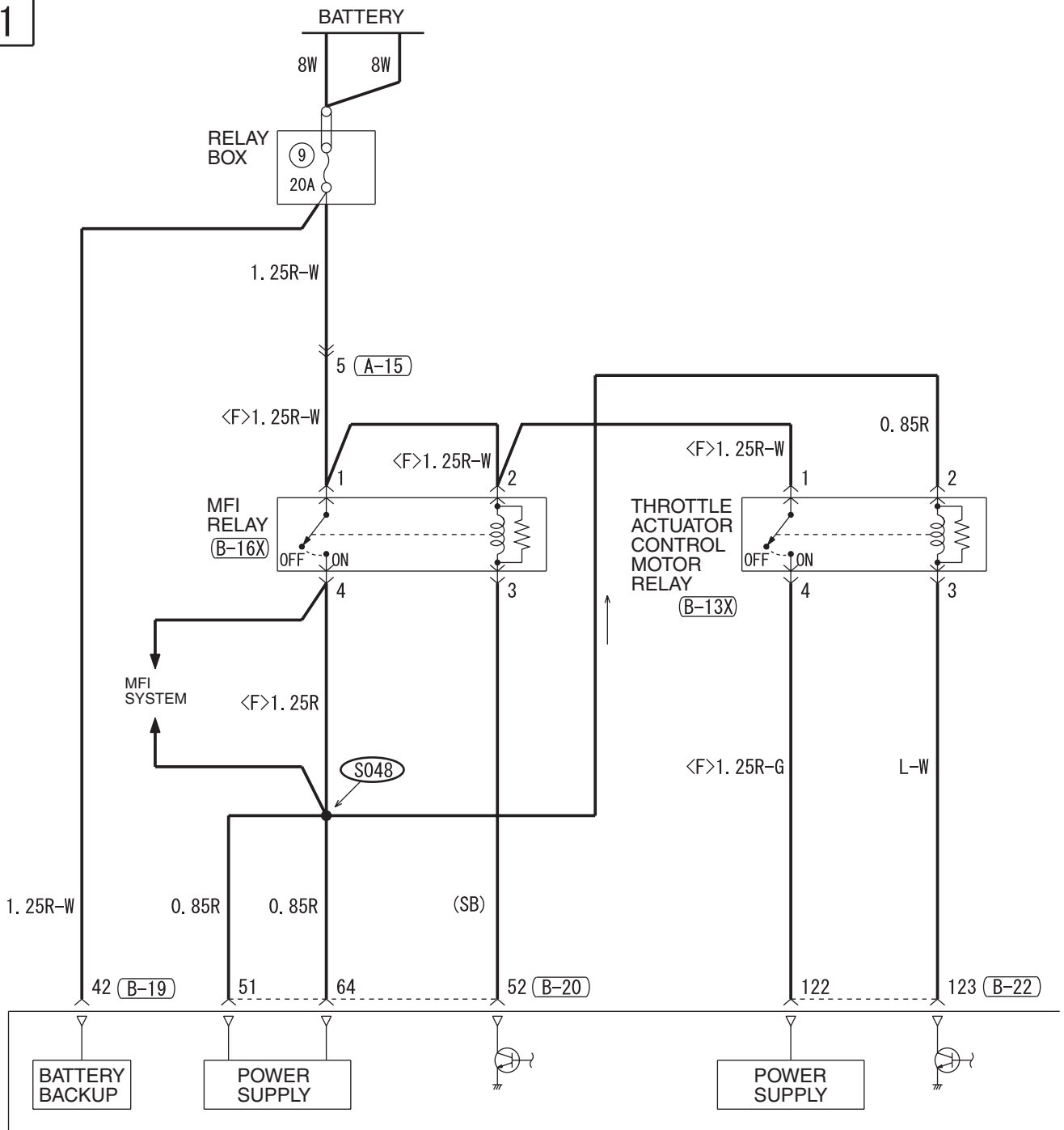

(A-03)

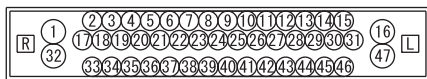

(A-15)

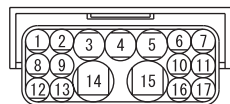

(B-13X)



(B-16X)



(B-18)



(B-19)



(B-20)

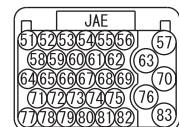

H6P15M11AA

2

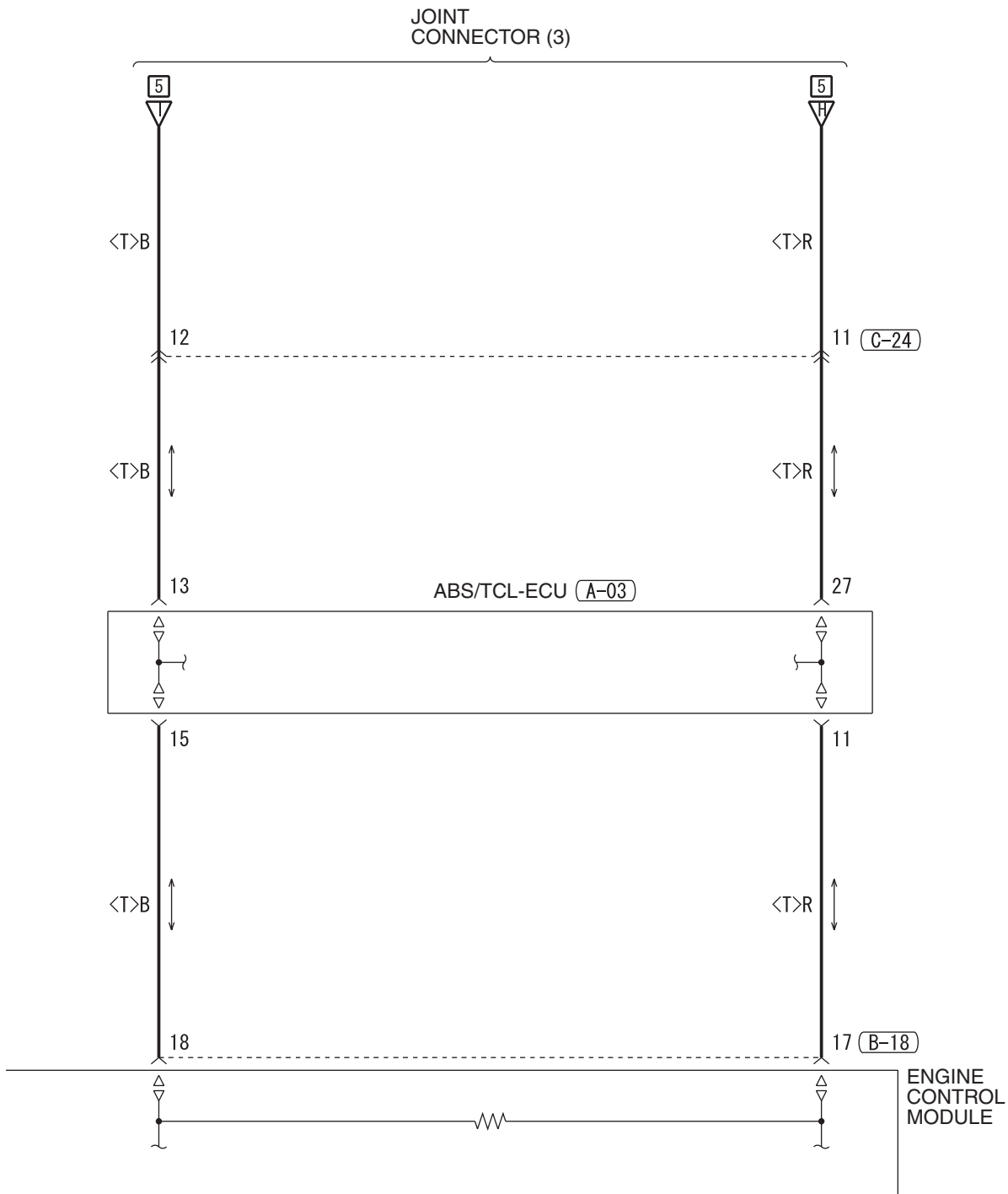

(B-22)

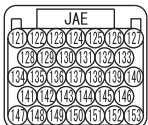

(C-24)

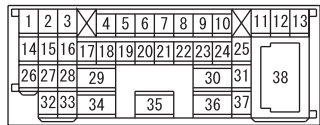

WIRE COLOR CODE
 B : BLACK LG : LIGHT GREEN G : GREEN L : BLUE
 BR : BROWN O : ORANGE GR : GRAY R : RED W : WHITE
 SB : SKY BLUE P : PINK Y : YELLOW V : VIOLET PU : PURPLE

ENGINE IMMOBILIZER SYSTEM <3.8L ENGINE-M/T> (CONTINUED)

3

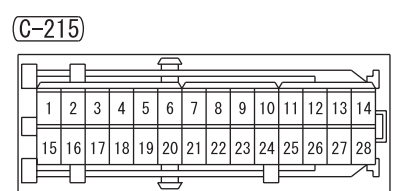
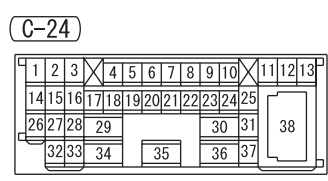
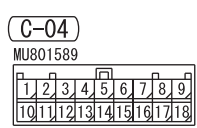
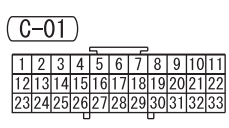
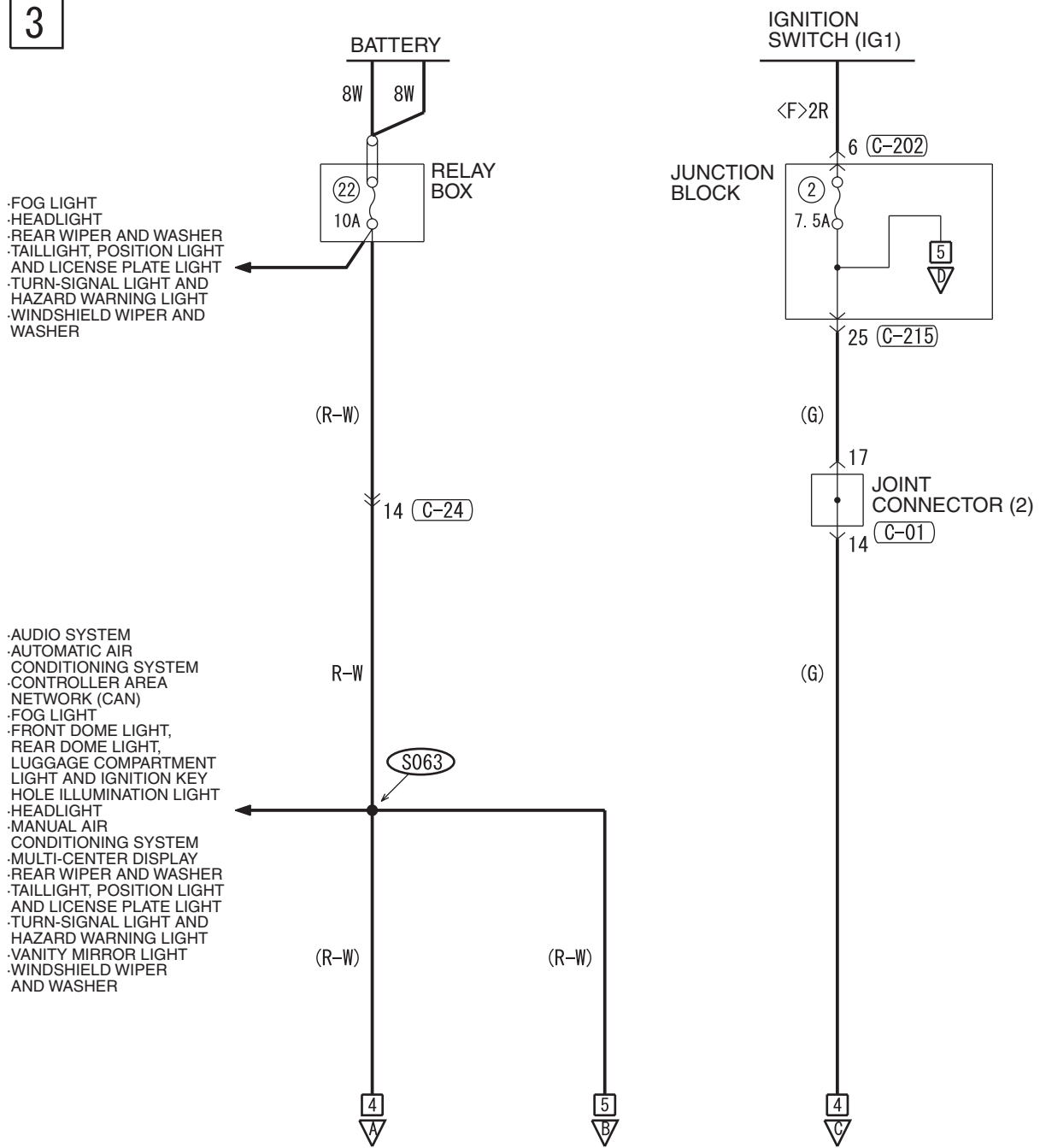

4

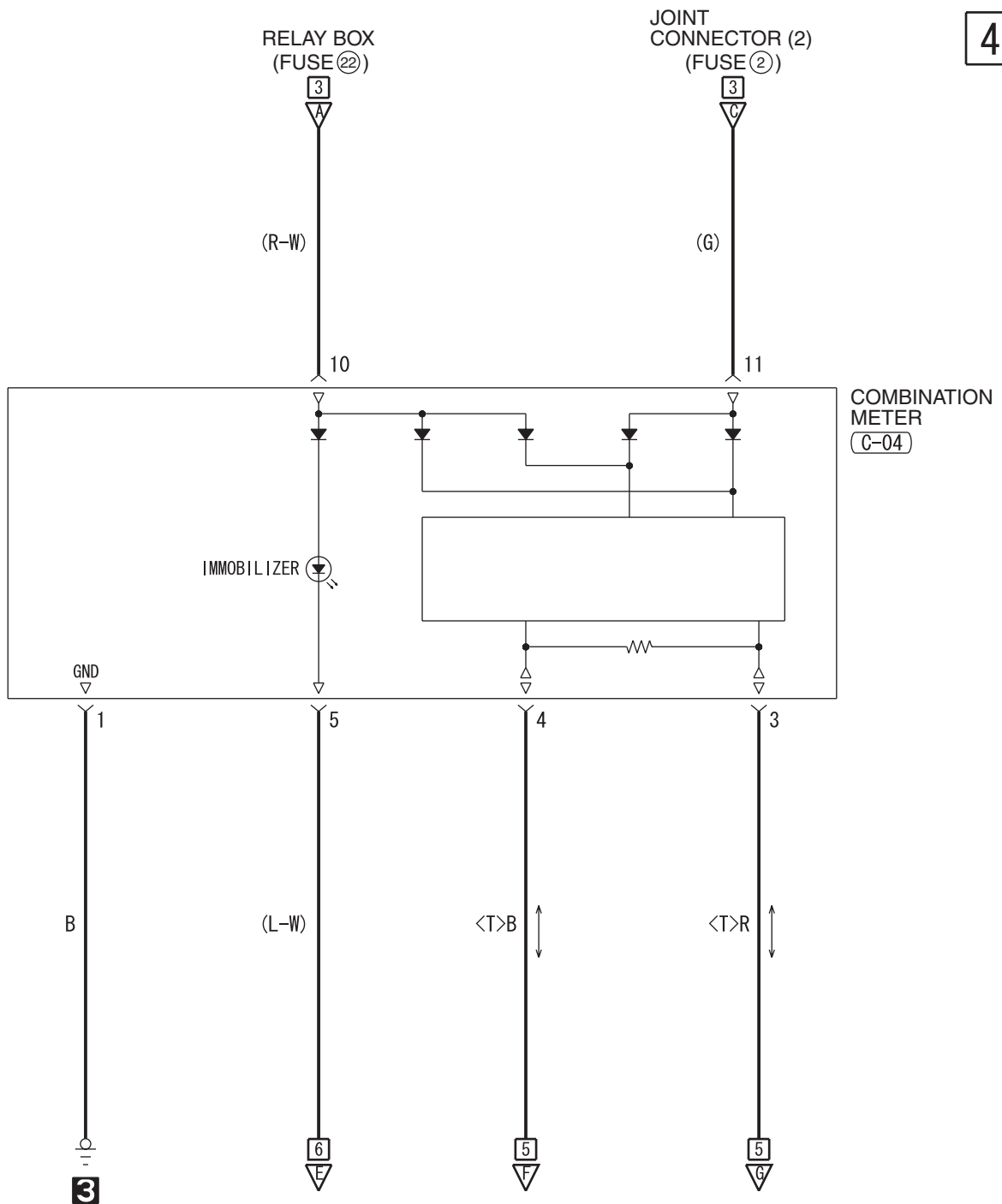

WIRE COLOR CODE
 B: BLACK LG: LIGHT GREEN G: GREEN L: BLUE W: WHITE Y: YELLOW SB: SKY BLUE
 BR: BROWN O: ORANGE GR: GRAY R: RED P: PINK V: VIOLET PU: PURPLE

H6P15M11BB

TSB Revision

ENGINE IMMOBILIZER SYSTEM <3.8L ENGINE-M/T> (CONTINUED)

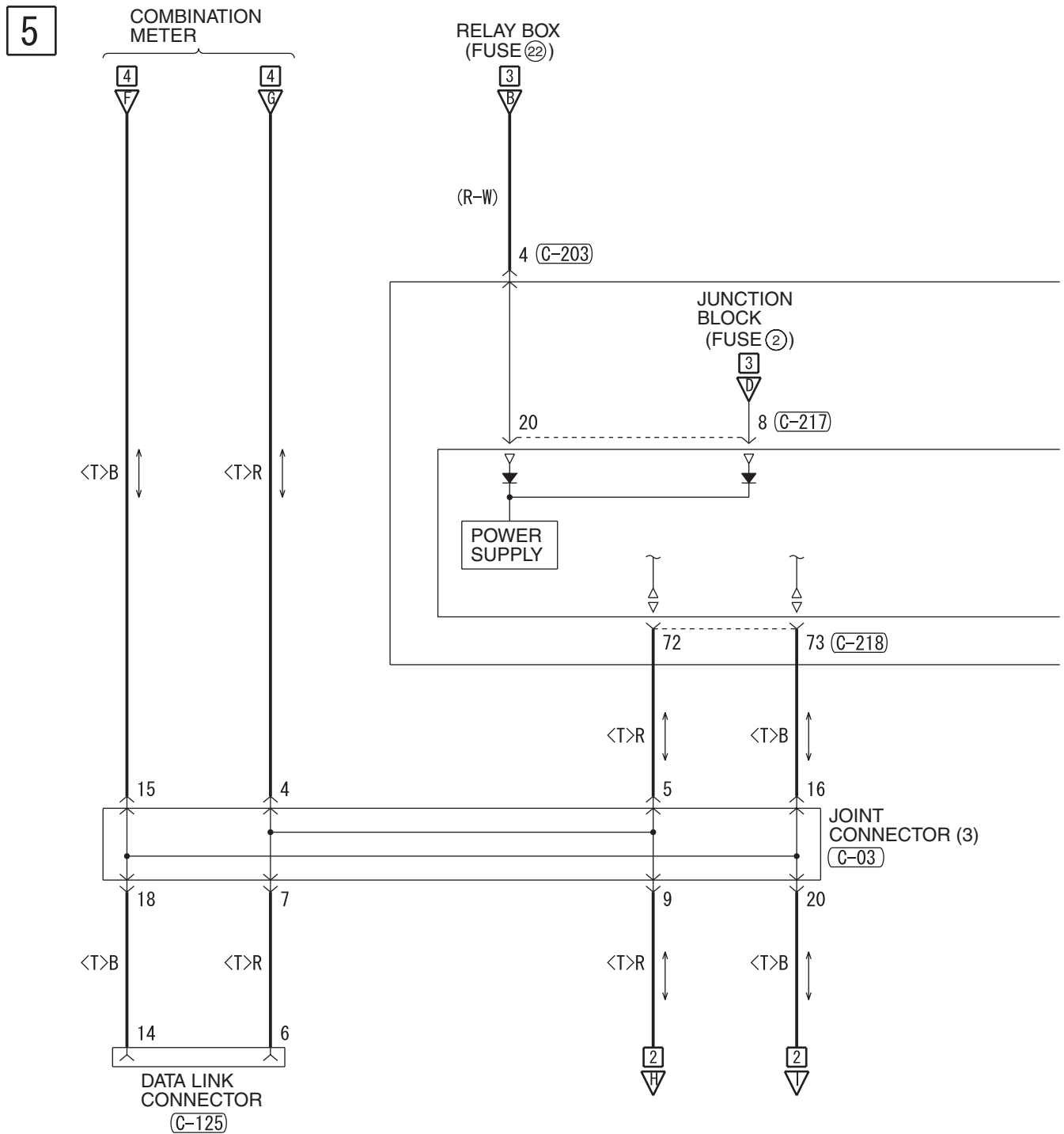

C-03

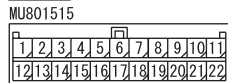

C-24

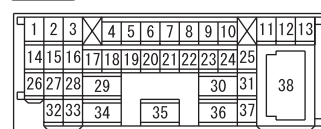

C-125 FRONT SIDE

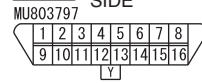

C-203

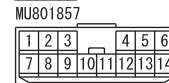

C-204



6

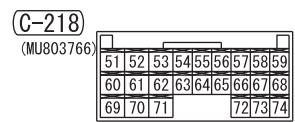
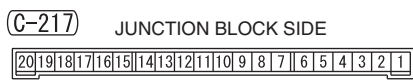
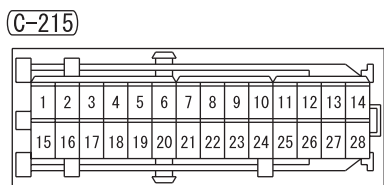
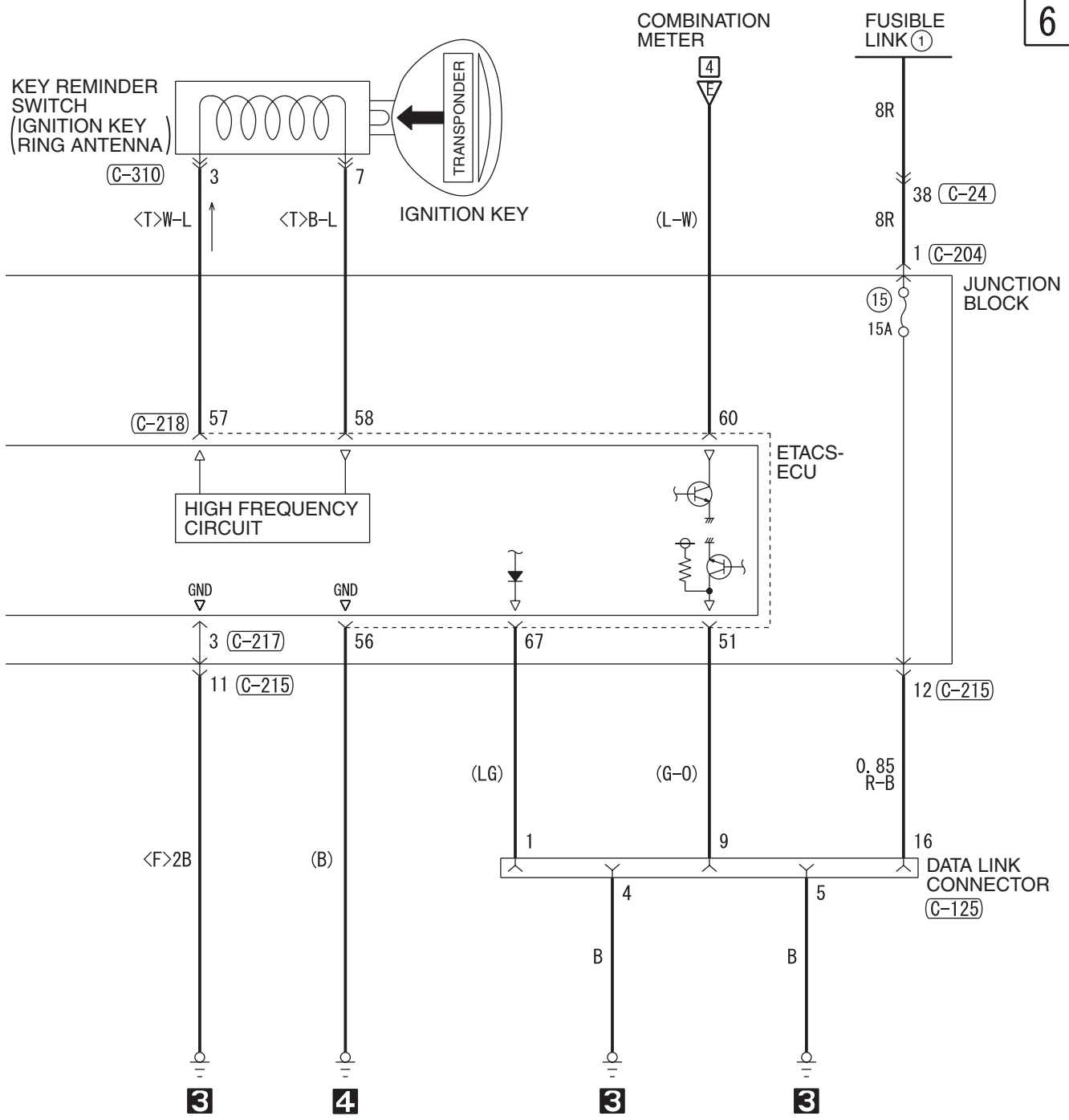

WIRE COLOR CODE
 B: BLACK LG: LIGHT GREEN G: GREEN L: BLUE
 BR: BROWN O: ORANGE GR: GRAY R: RED W: WHITE
 SB: SKY BLUE P: PINK Y: YELLOW V: VIOLET PU: PURPLE

TSB Revision

ENGINE IMMOBILIZER SYSTEM <3.8L ENGINE-A/T>

M1901013601962

1

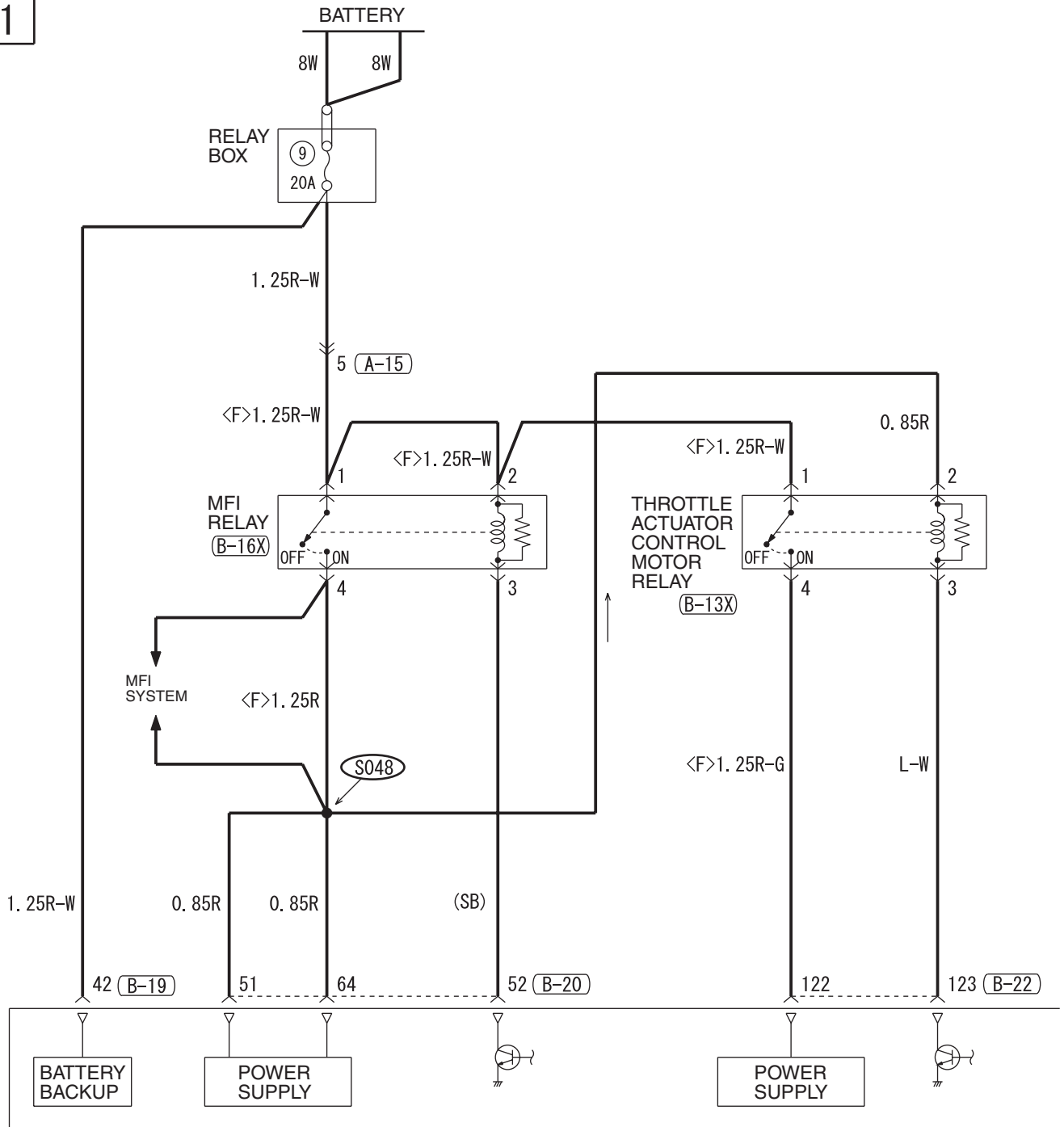

(A-03)

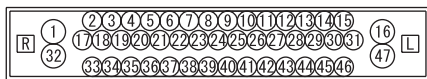

(A-15)

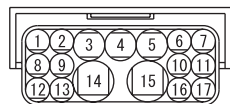

(B-13X)



(B-16X)



(B-18)



(B-19)



(B-20)

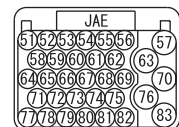

H6P15M12AA

2

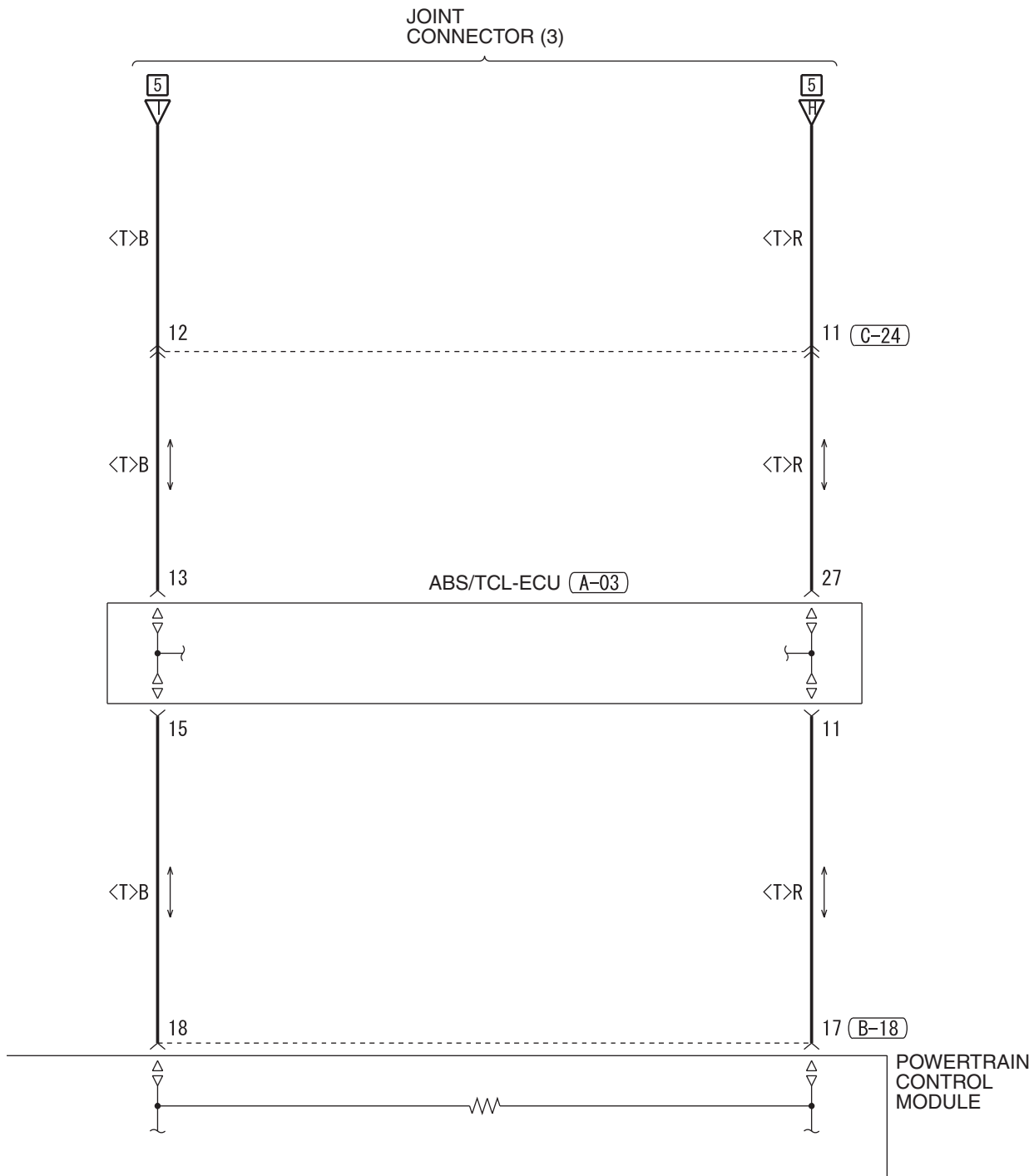

(B-22)

(C-24)

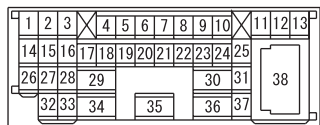
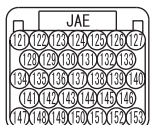

WIRE COLOR CODE
 B : BLACK LG : LIGHT GREEN G : GREEN L : BLUE
 BR : BROWN O : ORANGE GR : GRAY R : RED W : WHITE
 SB : SKY BLUE P : PINK Y : YELLOW V : VIOLET PU : PURPLE

TSB Revision

ENGINE IMMOBILIZER SYSTEM <3.8L ENGINE-A/T> (CONTINUED)

3

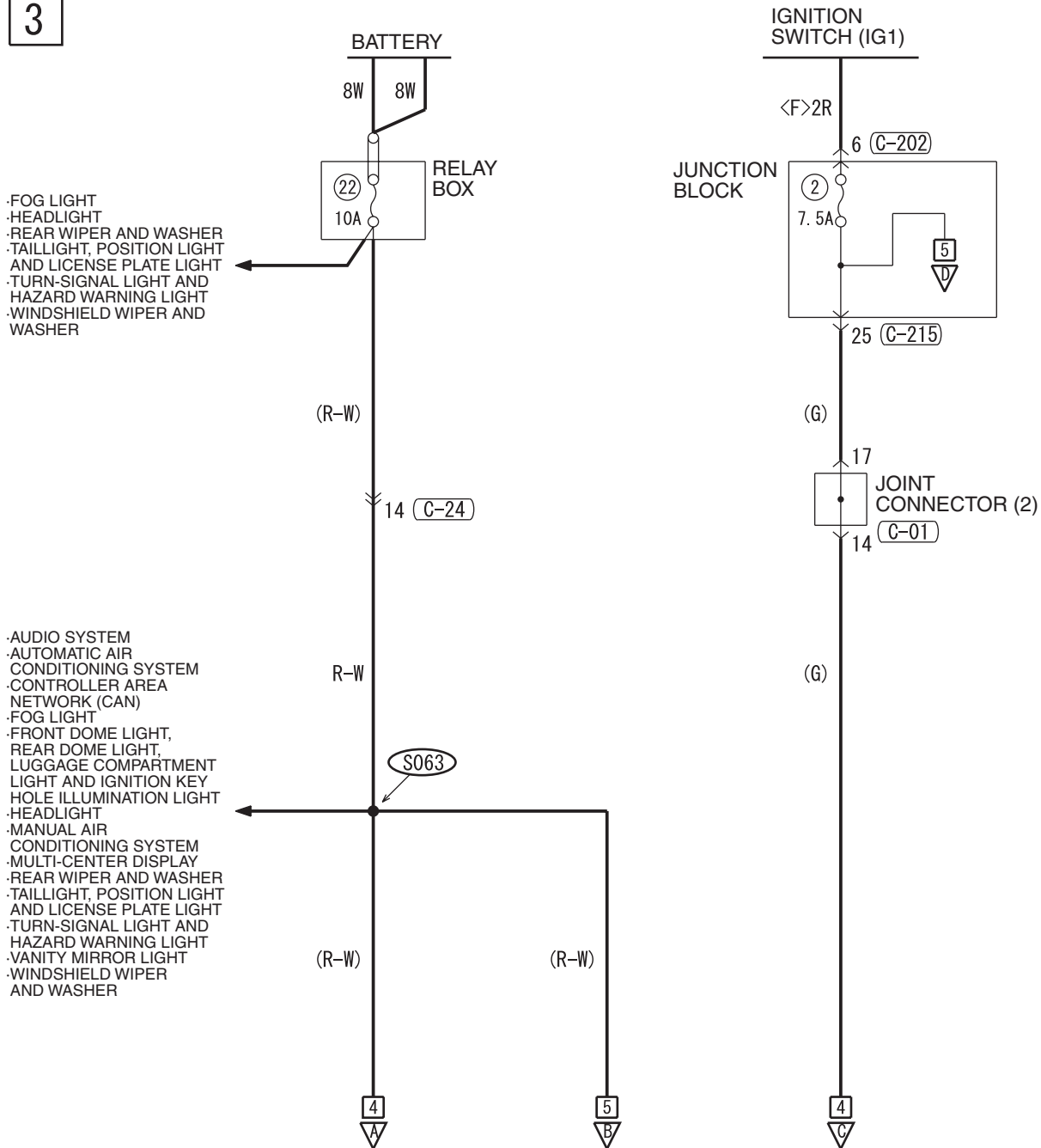

(C-01)



(C-04)

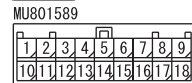

(C-24)

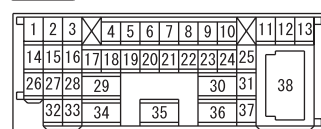

(C-202)



(C-215)

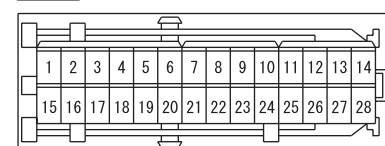

4

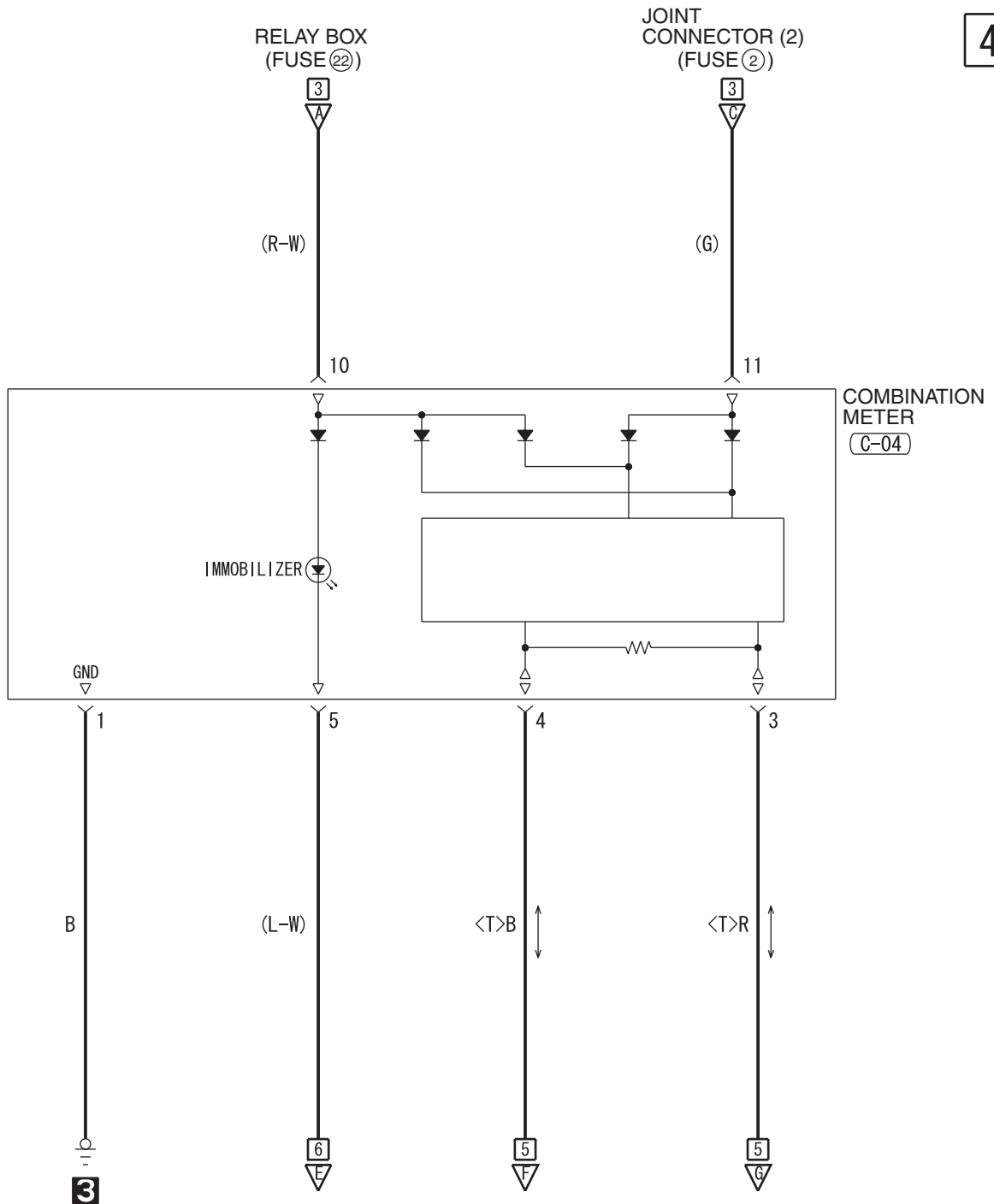

WIRE COLOR CODE
 B : BLACK LG : LIGHT GREEN G : GREEN L : BLUE W : WHITE Y : YELLOW SB : SKY BLUE
 BR : BROWN O : ORANGE GR : GRAY R : RED P : PINK V : VIOLET PU : PURPLE

H6P15M12BB

TSB Revision

ENGINE IMMOBILIZER SYSTEM <3.8L ENGINE-A/T> (CONTINUED)

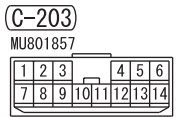
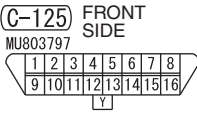
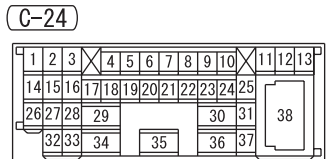
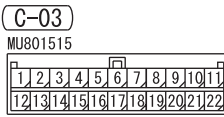
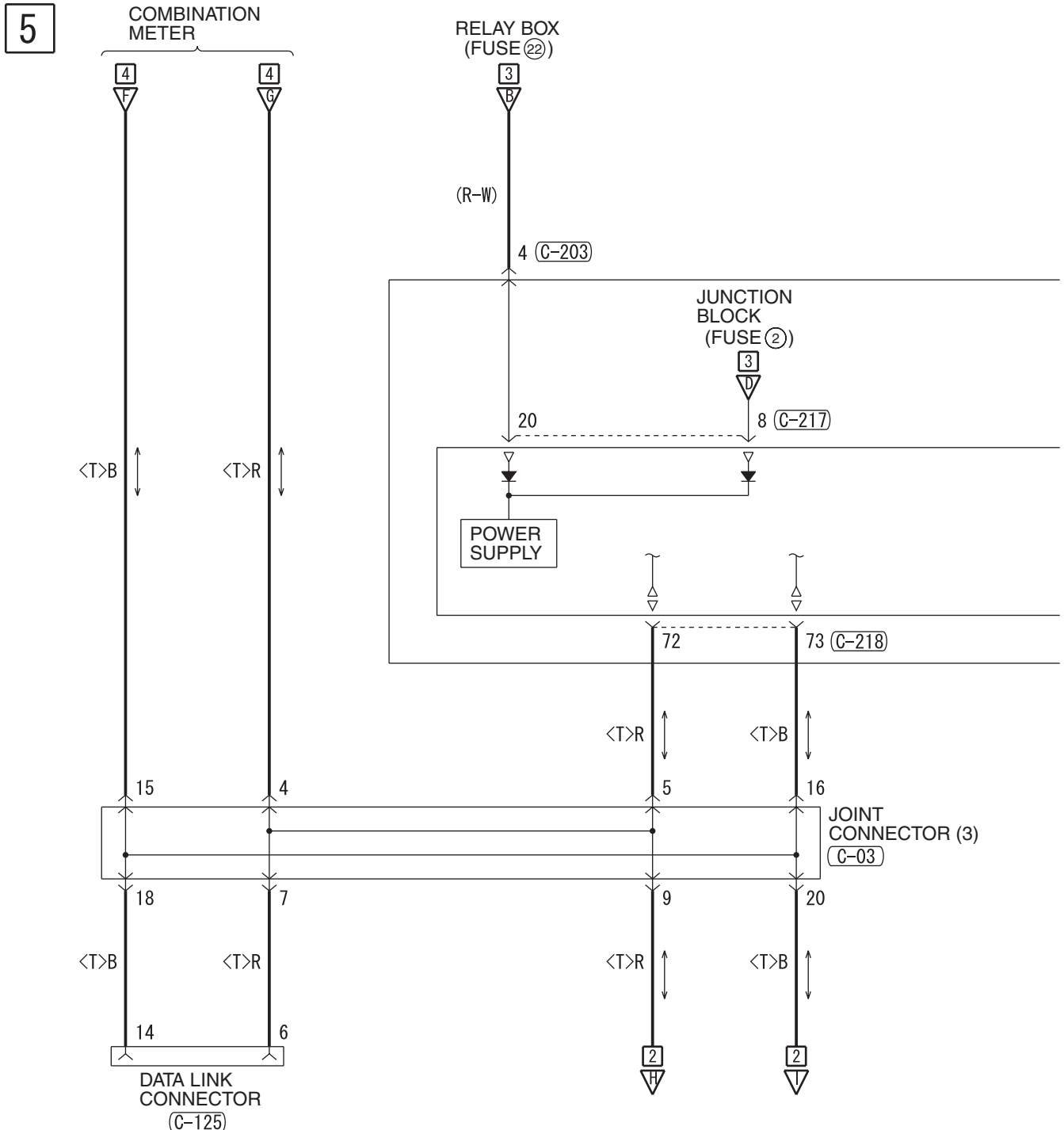

6

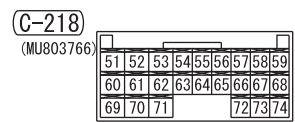
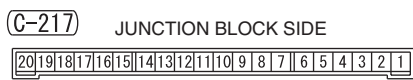
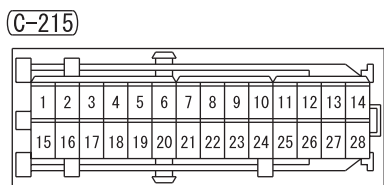
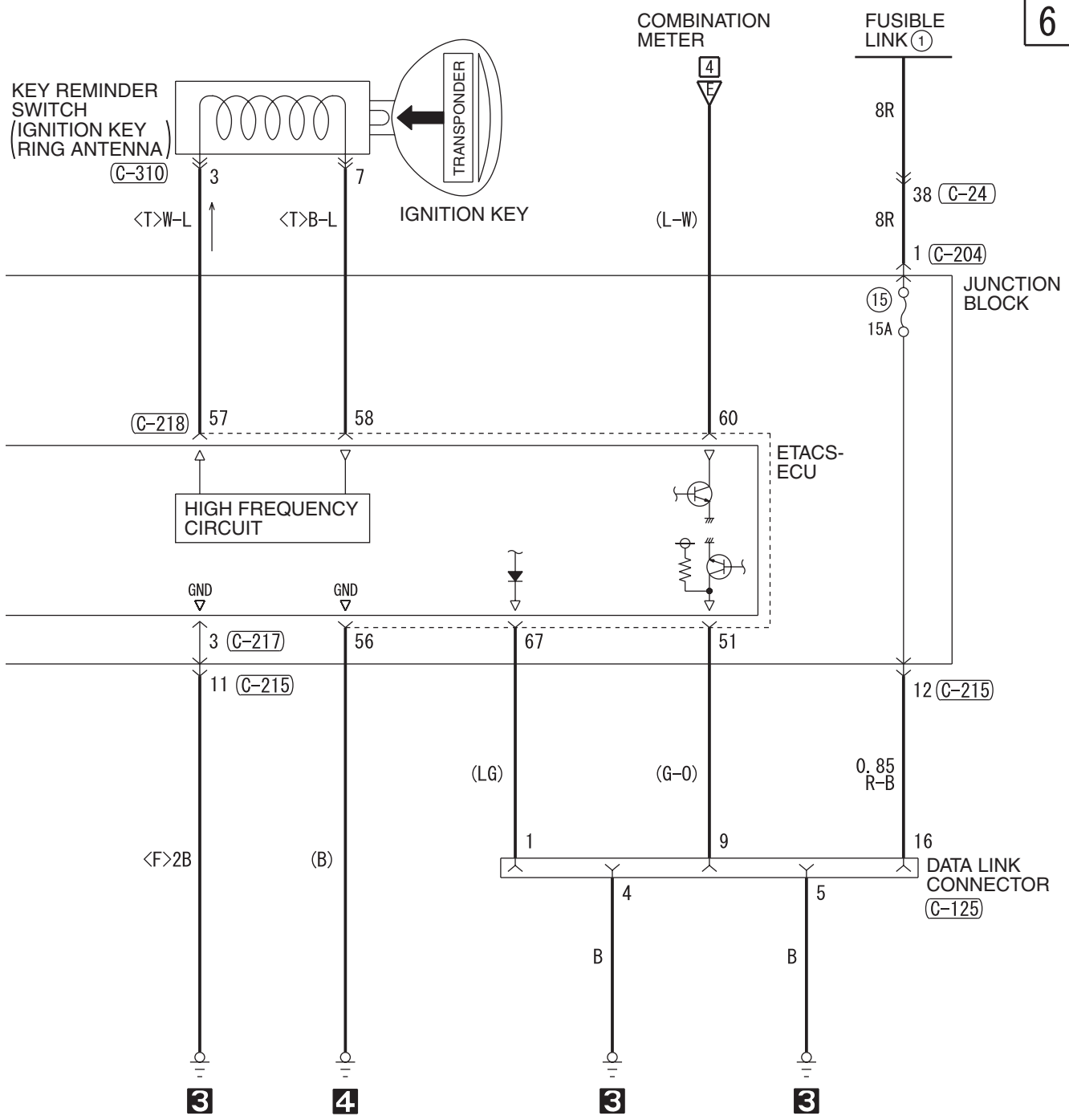

WIRE COLOR CODE
 B : BLACK LG : LIGHT GREEN G : GREEN L : BLUE
 BR : BROWN O : ORANGE GR : GRAY R : RED W : WHITE
 SB : SKY BLUE P : PINK Y : YELLOW V : VIOLET PU : PURPLE

H6P15M12CB

TSB Revision

SUPPLEMENTAL RESTRAINT SYSTEM (SRS)

M1901009701773

1

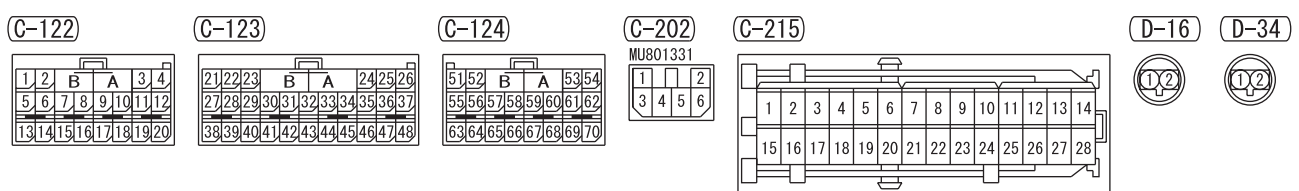
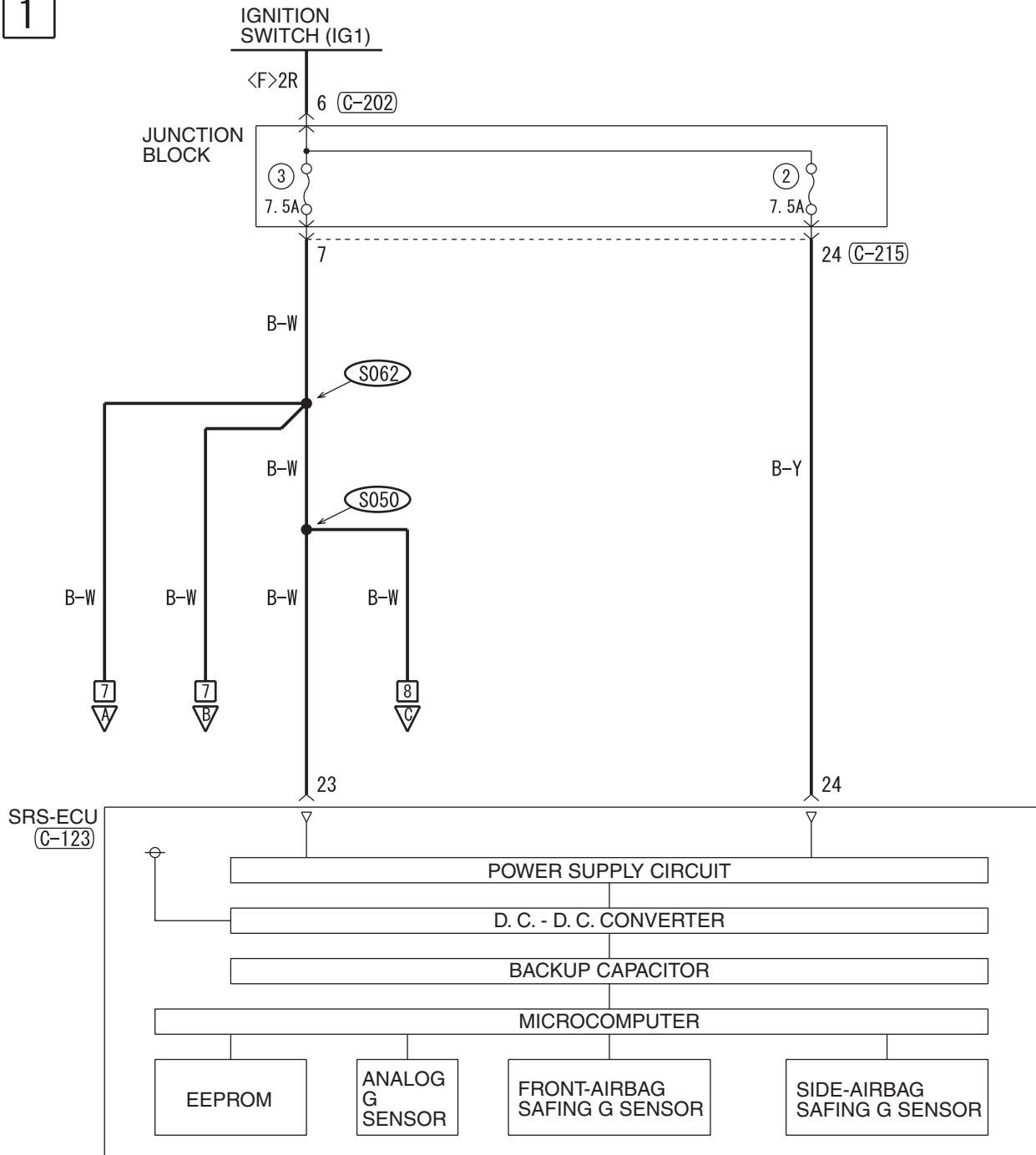

2

NOTE
·CONNECTOR LOCK SWITCH
(CONNECTOR COUPLED: ON
CONNECTOR UNCOUPLED: OFF)
*: CONNECTOR LOCK SWITCH

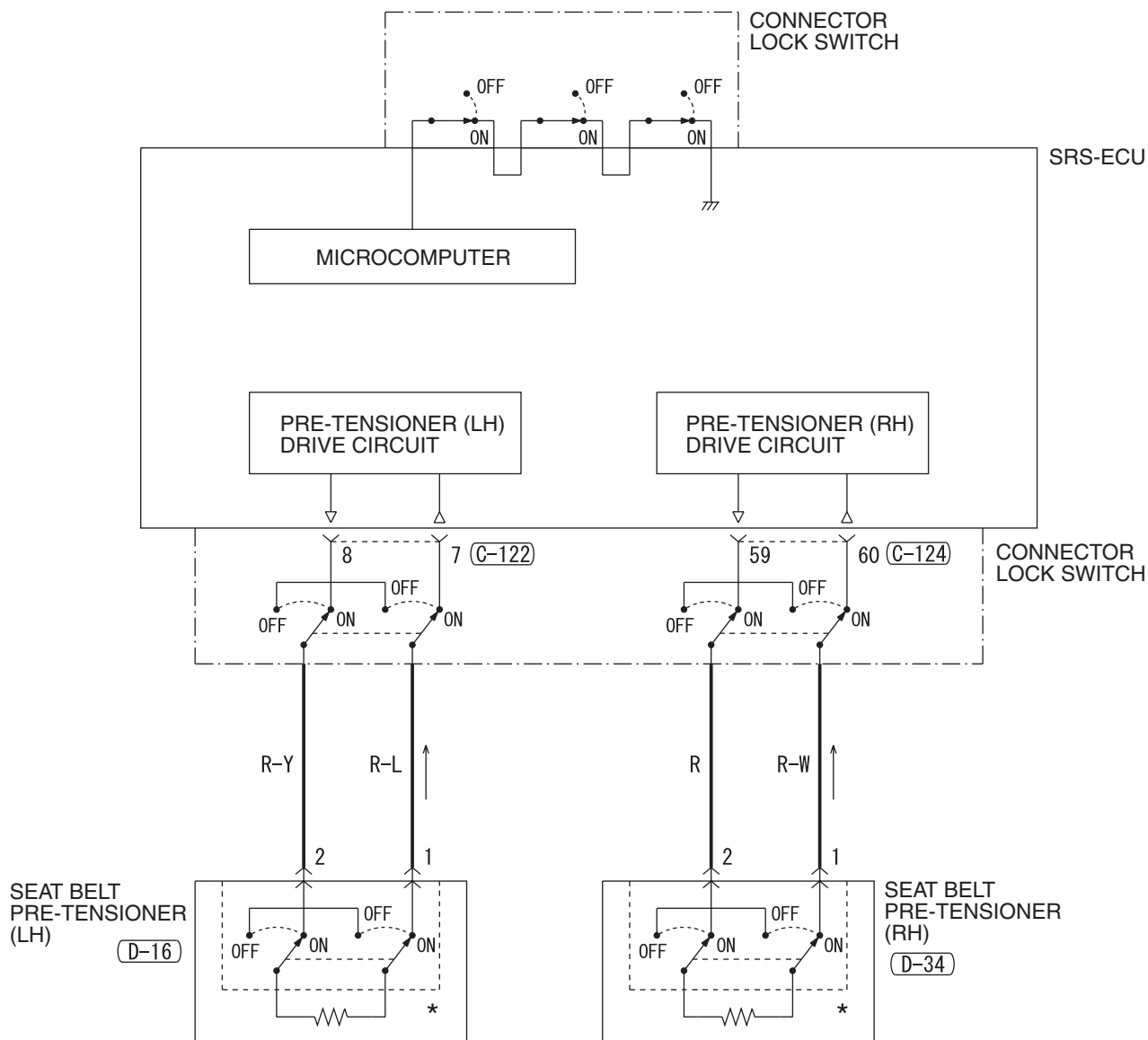

WIRE COLOR CODE
B: BLACK LG: LIGHT GREEN G: GREEN L: BLUE W: WHITE Y: YELLOW SB: SKY BLUE
BR: BROWN O: ORANGE GR: GRAY R: RED P: PINK V: VIOLET PU: PURPLE

H6P15M13AB

TSB Revision

SUPPLEMENTAL RESTRAINT SYSTEM (SRS) (CONTINUED)

3

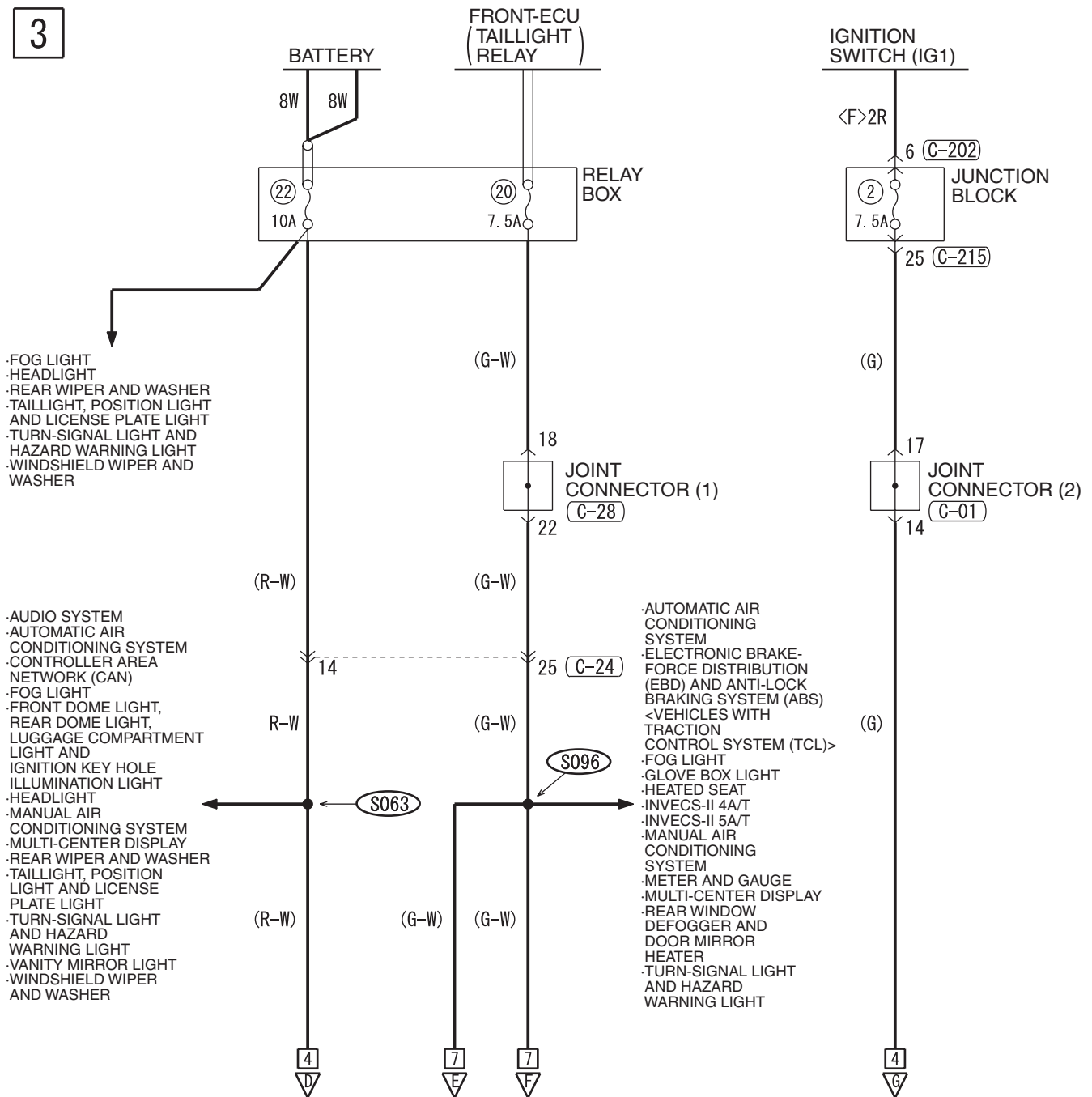

(C-01)

1	2	3	4	5	6	7	8	9	10	11
12	13	14	15	16	17	18	19	20	21	22
23	24	25	26	27	28	29	30	31	32	33

(C-03)

MU801515

1	2	3	4	5	6	7	8	9	10	11
12	13	14	15	16	17	18	19	20	21	22

(C-04)

MU801589

1	2	3	4	5	6	7	8	9
10	11	12	13	14	15	16	17	18

(C-24)

1	2	3	4	5	6	7	8	9	10	11	12	13
14	15	16	17	18	19	20	21	22	23	24	25	
26	27	28	29			30	31			38		
32	33	34		35		36	37					

(C-28)

1	2	3	4	5	6	7	8	9	10	11
12	13	14	15	16	17	18	19	20	21	22
23	24	25	26	27	28	29	30	31	32	33

4

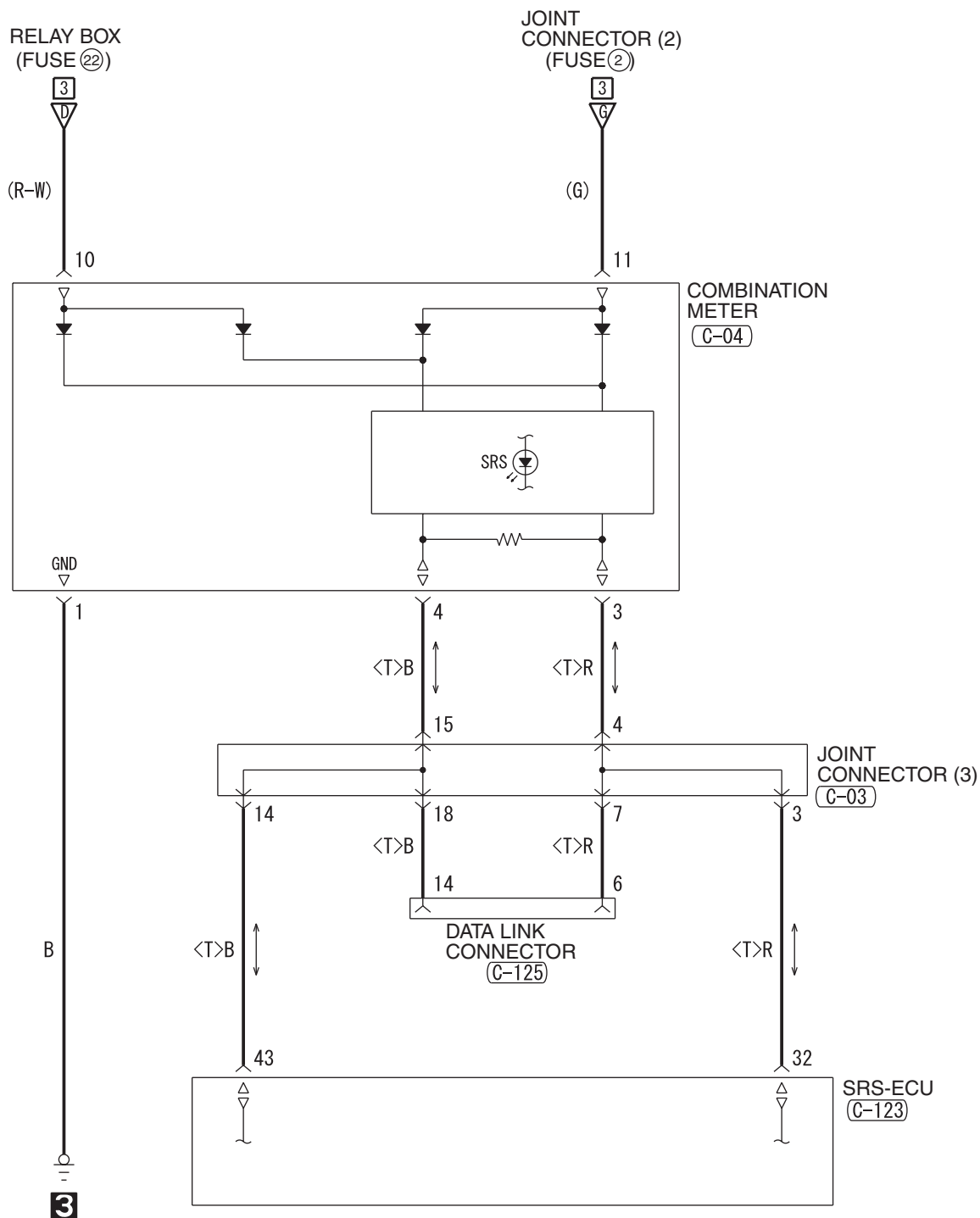

(C-123)



(C-125) FRONT SIDE

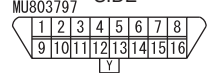

(C-202)



(C-215)

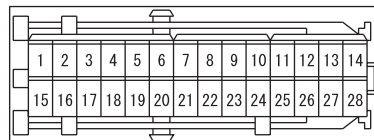

WIRE COLOR CODE

B: BLACK LG: LIGHT GREEN G: GREEN L: BLUE W: WHITE Y: YELLOW SB: SKY BLUE
BR: BROWN O: ORANGE GR: GRAY R: RED P: PINK V: VIOLET PU: PURPLE

H6P15M13BB

SUPPLEMENTAL RESTRAINT SYSTEM (SRS) (CONTINUED)

5

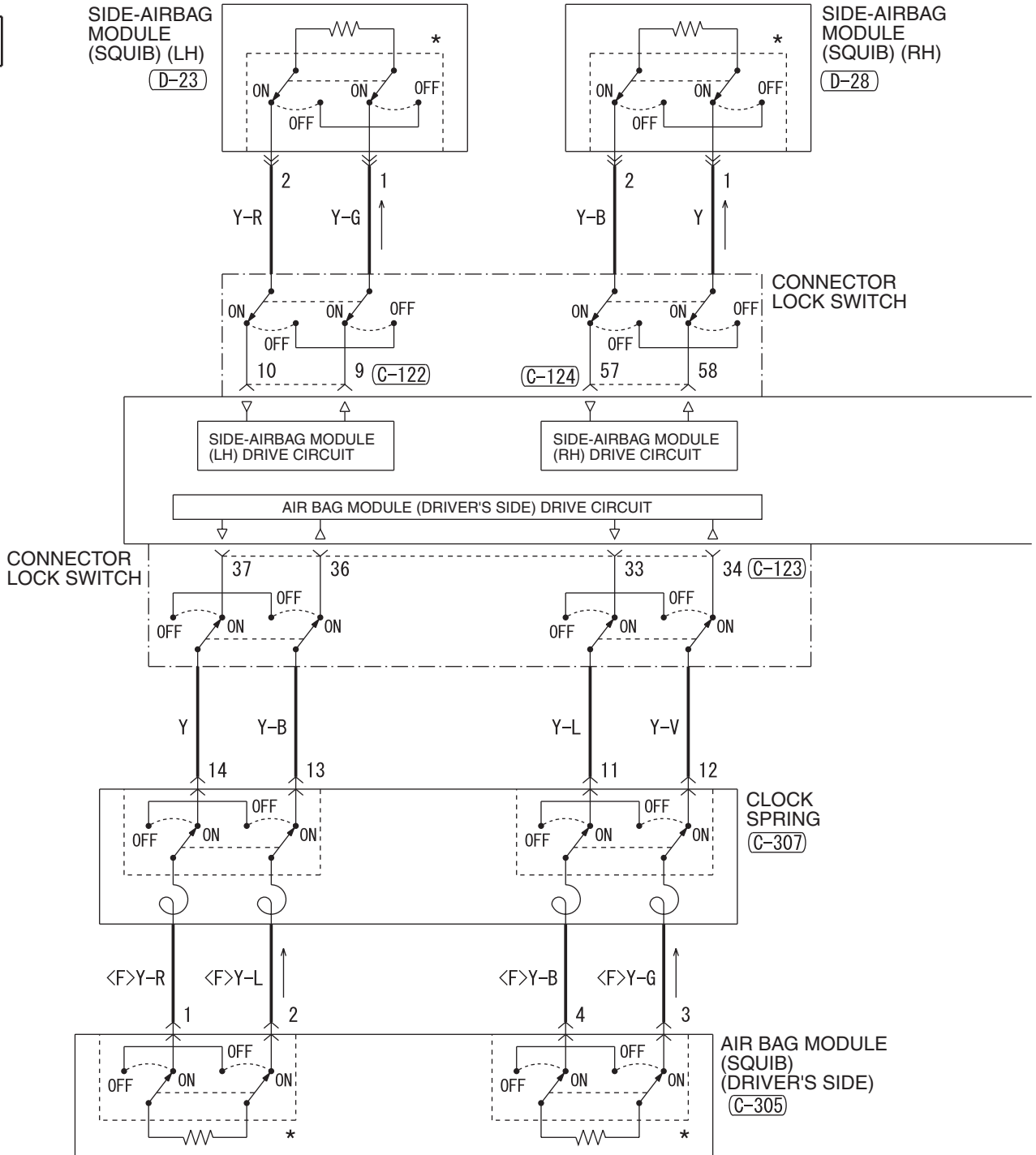

(C-112)

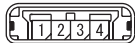

(C-122)

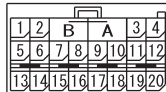

(C-123)

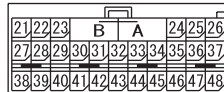

(C-124)

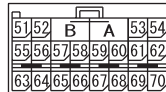

(C-305)

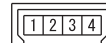

(C-307)



(D-17)



(D-23)



(D-28)



6

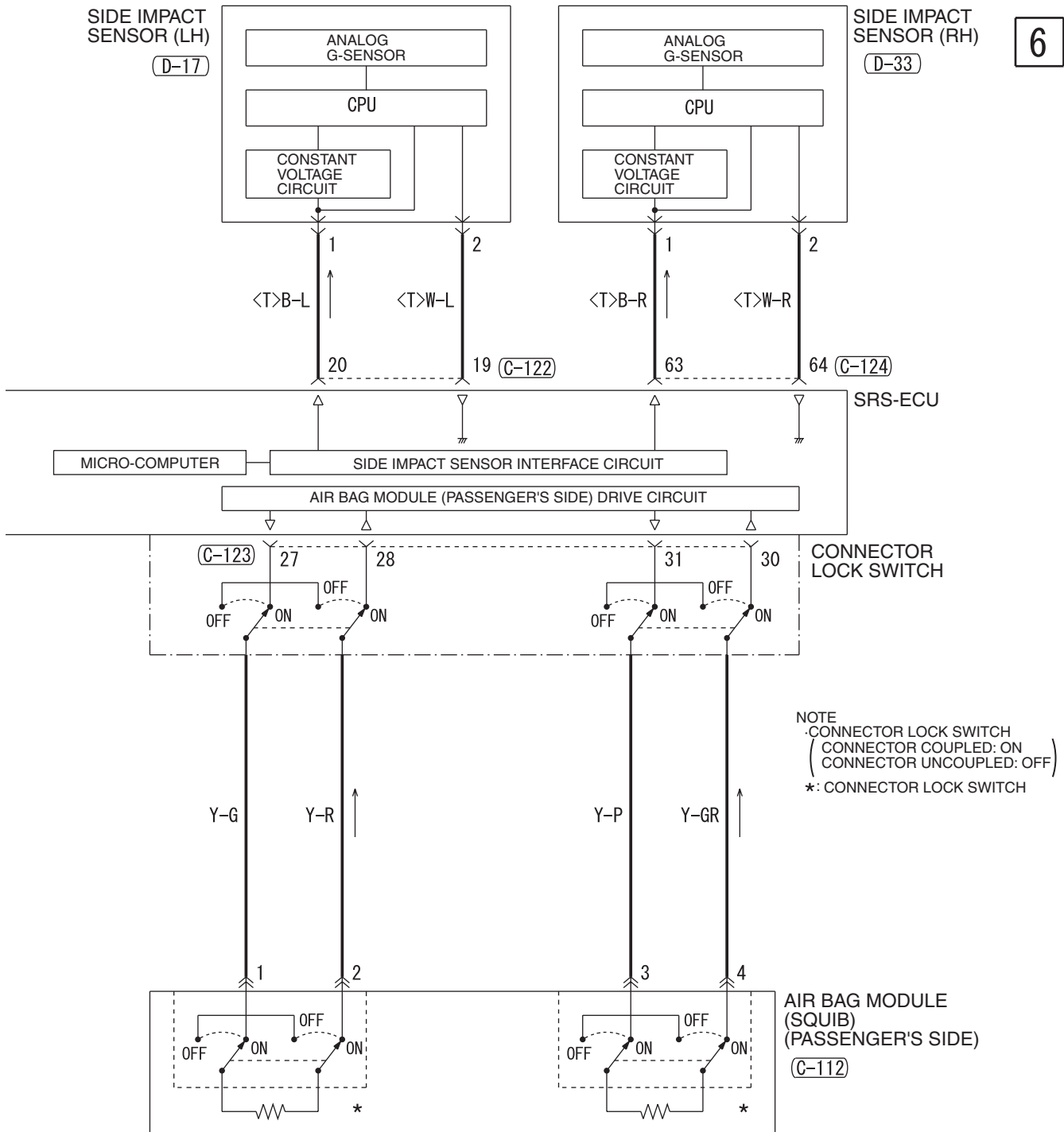

NOTE
 .CONNECTOR LOCK SWITCH
 (CONNECTOR COUPLED: ON
 CONNECTOR UNCOUPLED: OFF)
 *: CONNECTOR LOCK SWITCH

(D-33)



WIRE COLOR CODE
 B : BLACK LG : LIGHT GREEN G : GREEN L : BLUE W : WHITE Y : YELLOW SB : SKY BLUE
 BR : BROWN O : ORANGE GR : GRAY R : RED P : PINK V : VIOLET PU : PURPLE

H6P15M13CB

TSB Revision

SUPPLEMENTAL RESTRAINT SYSTEM (SRS) (CONTINUED)

7

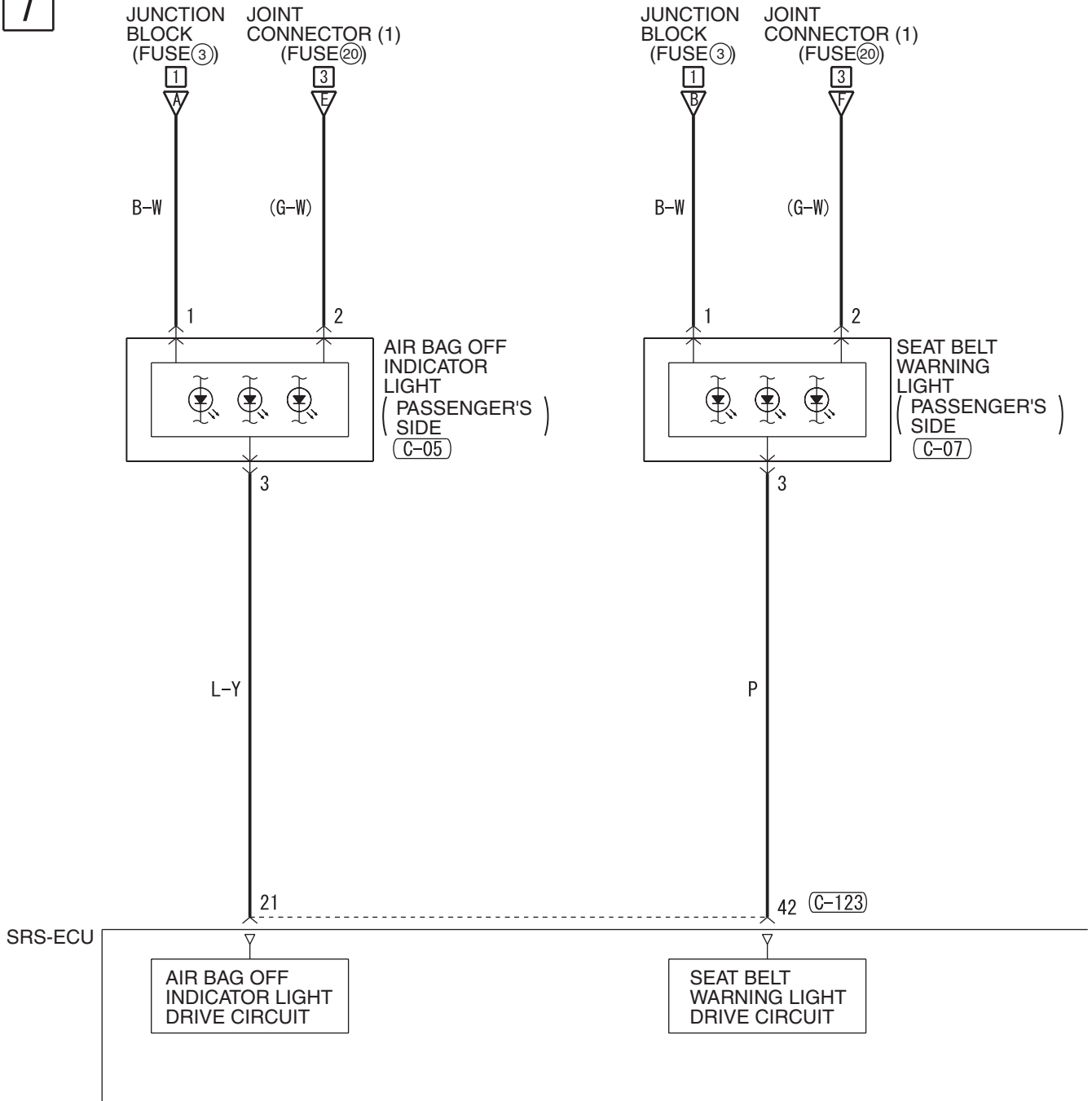

(C-05)

(C-07)

(C-23)

(C-123)

(C-124)

(D-26)

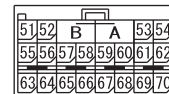
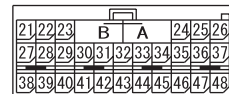
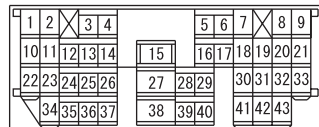

8

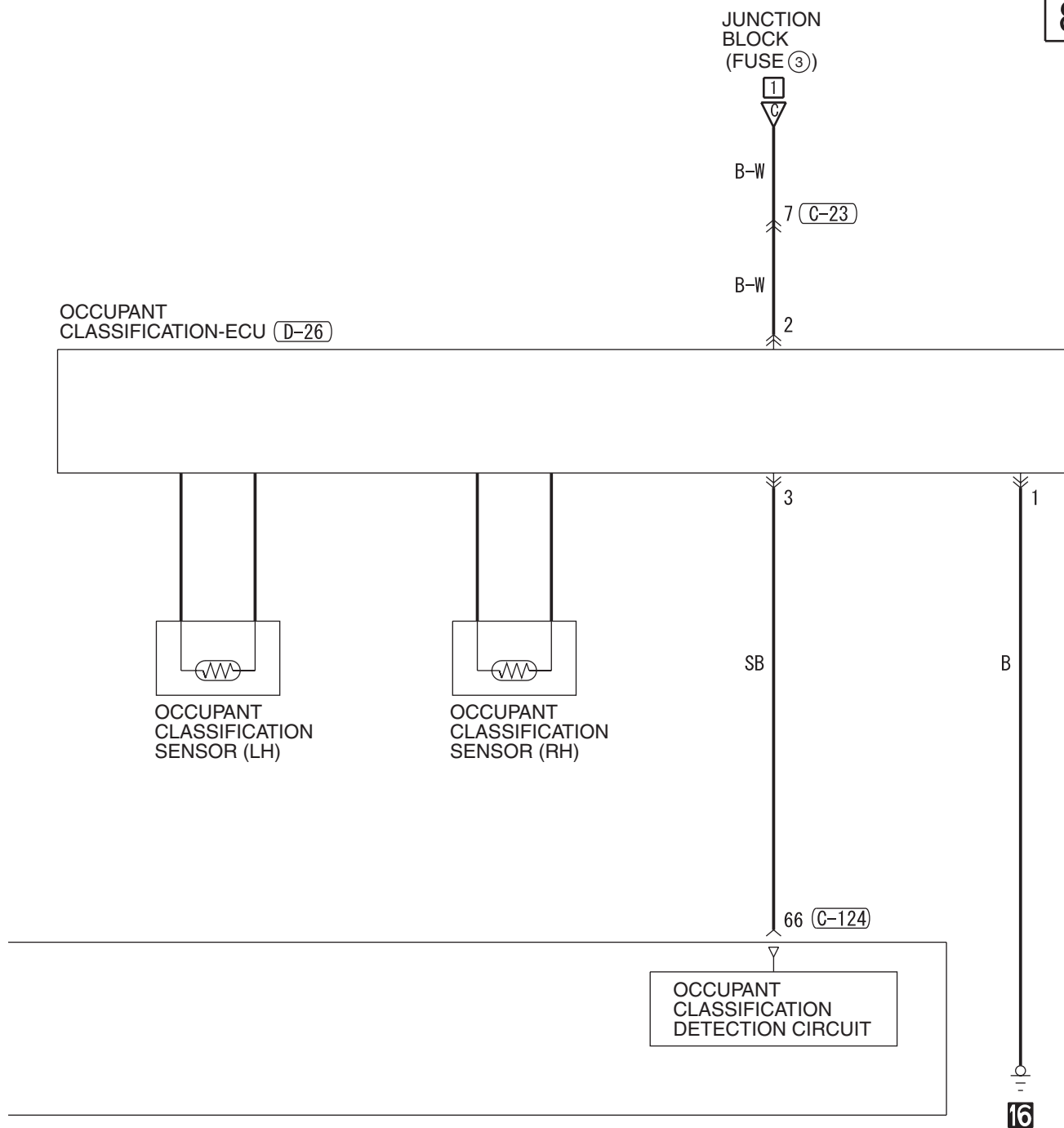

WIRE COLOR CODE
 B: BLACK LG: LIGHT GREEN G: GREEN L: BLUE W: WHITE Y: YELLOW SB: SKY BLUE
 BR: BROWN O: ORANGE GR: GRAY R: RED P: PINK V: VIOLET PU: PURPLE

SUPPLEMENTAL RESTRAINT SYSTEM (SRS) (CONTINUED)

9

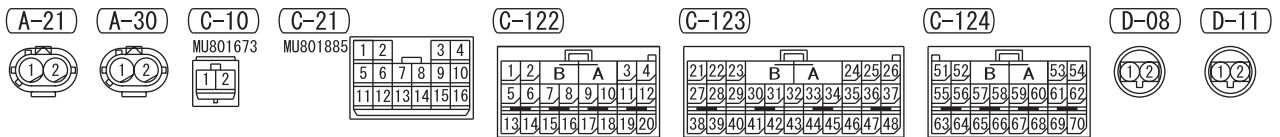
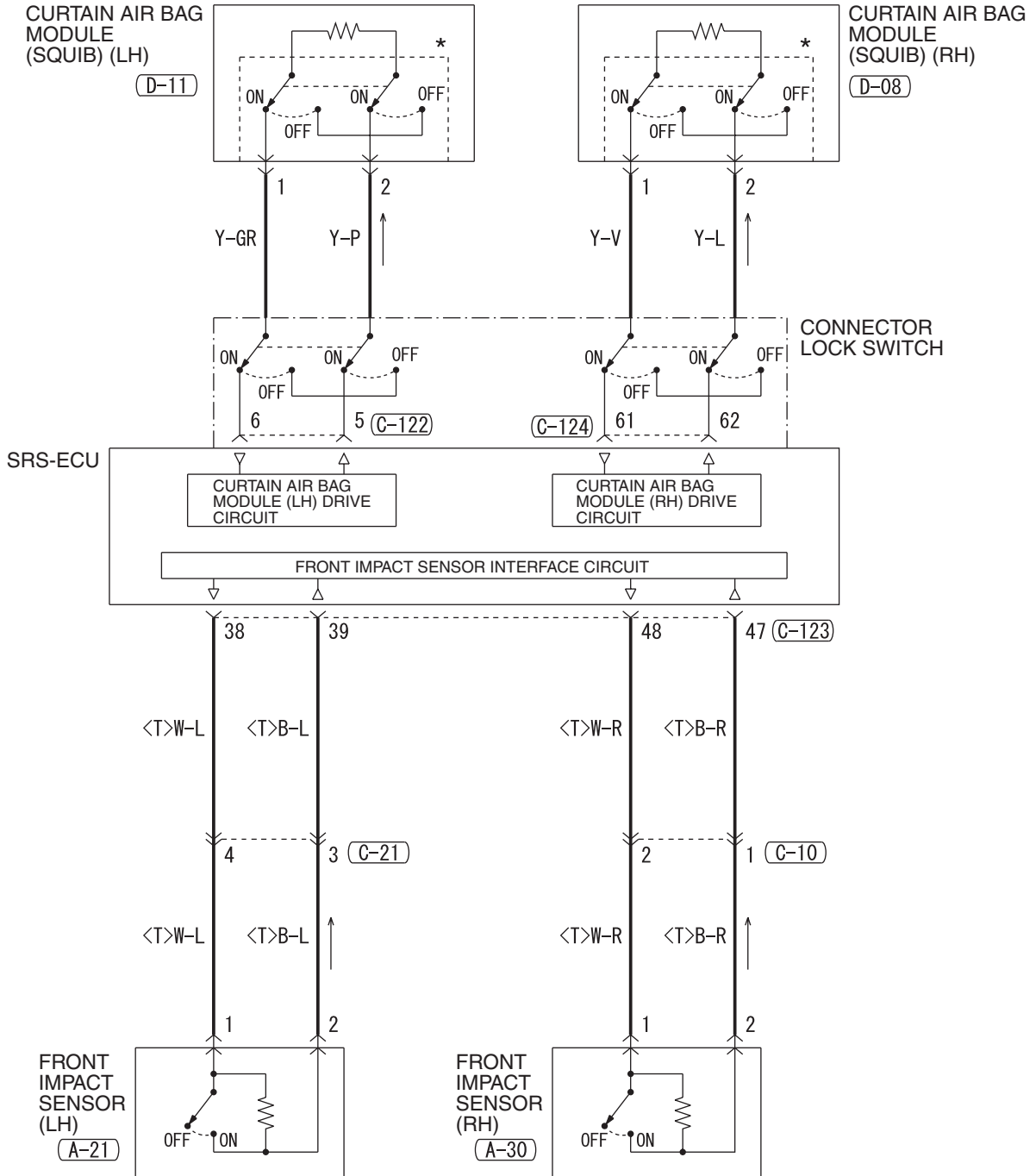

10

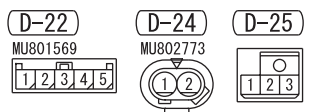
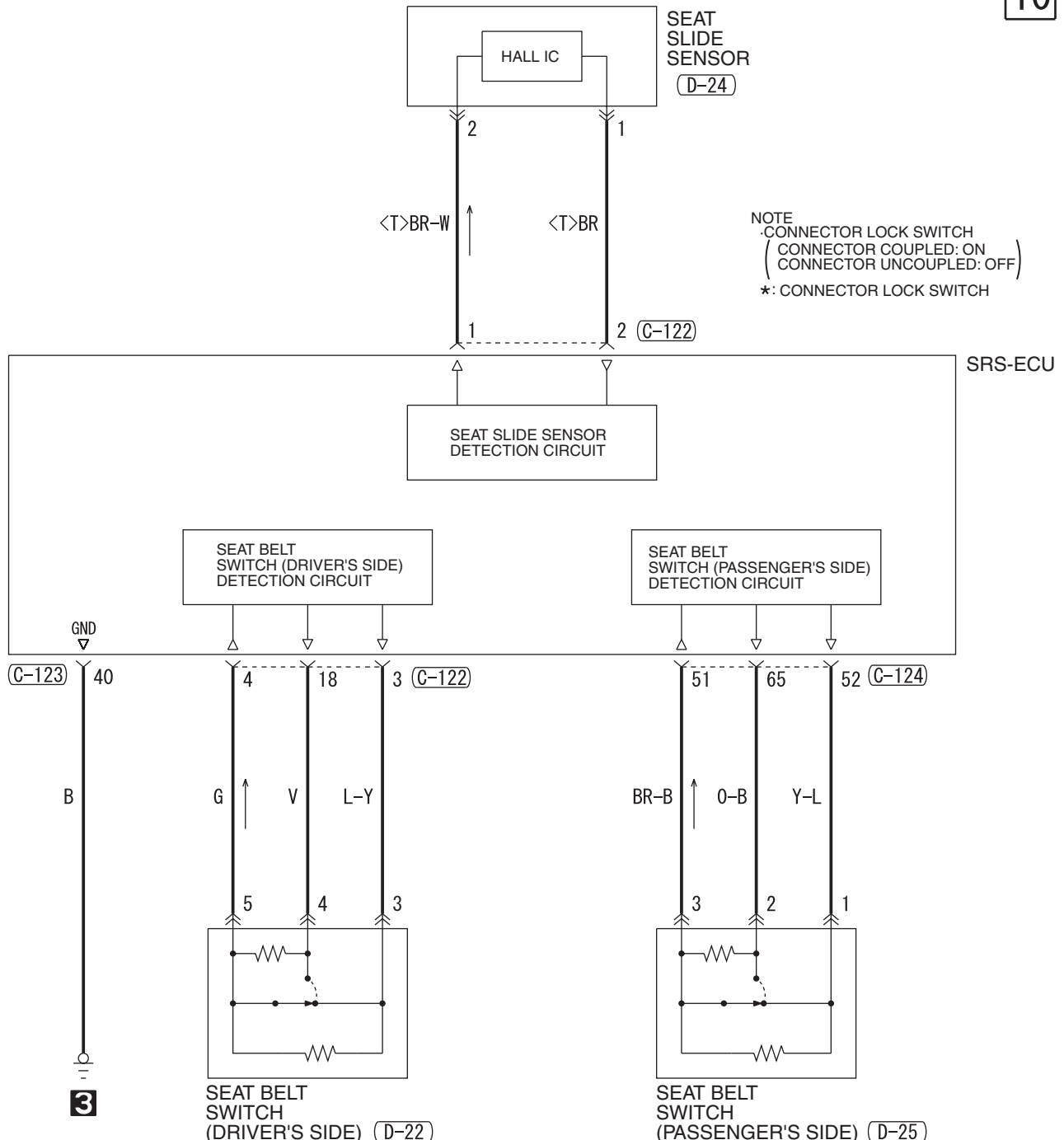

WIRE COLOR CODE
 B: BLACK LG: LIGHT GREEN G: GREEN L: BLUE W: WHITE Y: YELLOW SB: SKY BLUE
 BR: BROWN O: ORANGE GR: GRAY R: RED P: PINK V: VIOLET PU: PURPLE

POWER SEAT

M1901010400494

1

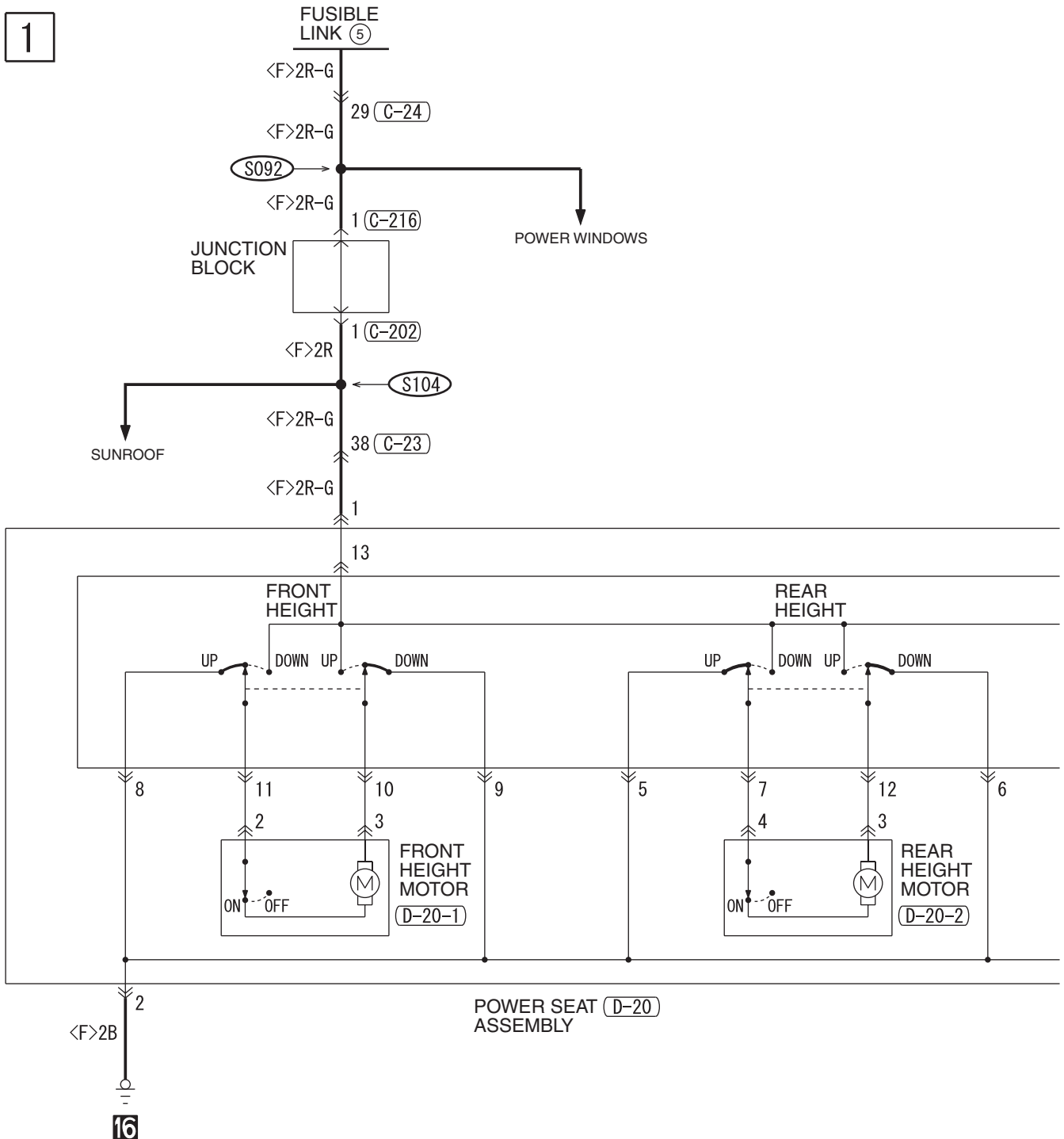

C-23

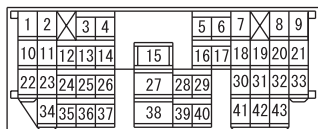

C-24

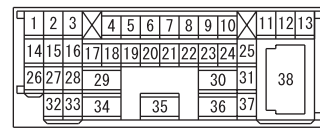

C-202



C-216



(D-20)



D-20-1

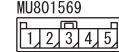

D-20-2

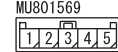

D-20-3



H6P15M14AA

2

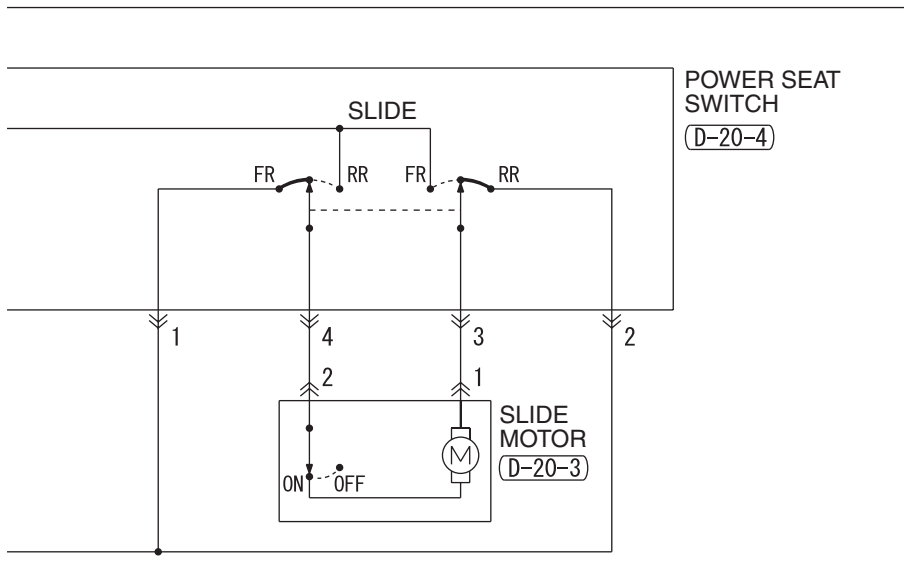

(D-20-4)

1	2	3	4	5	6	7
8	9	10	11	12	13	14

WIRE COLOR CODE
 B: BLACK LG: LIGHT GREEN G: GREEN L: BLUE W: WHITE Y: YELLOW SB: SKY BLUE
 BR: BROWN O: ORANGE GR: GRAY R: RED P: PINK V: VIOLET PU: PURPLE

H6P15M14AB

TSB Revision

HEATED SEAT

1

- .AUDIO SYSTEM
- .AUTOMATIC AIR CONDITIONING SYSTEM
- .ELECTRONIC BRAKE-FORCE DISTRIBUTION (EBD) AND ANTI-LOCK BRAKING SYSTEM (ABS)
- <VEHICLES WITH TRACTION CONTROL SYSTEM (TCL)>
- .FOG LIGHT
- .GLOVE BOX LIGHT
- .INVECS-II 4A/T
- .INVECS-II 5A/T
- .MANUAL AIR CONDITIONING SYSTEM
- .METER AND GAUGE
- .MULTI-CENTER DISPLAY
- .REAR WINDOW DEFOGGER AND DOOR MIRROR HEATER
- .SUPPLEMENTAL RESTRAINT SYSTEM (SRS)
- .TURN-SIGNAL LIGHT AND HAZARD WARNING LIGHT

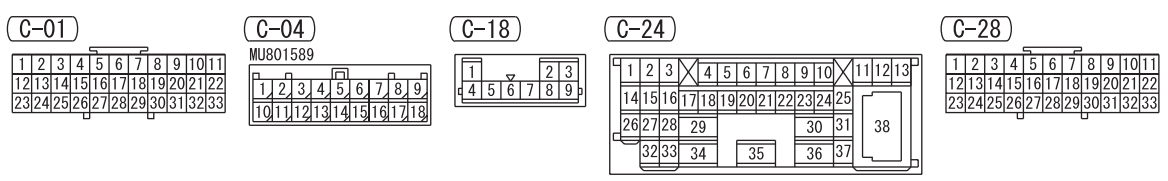
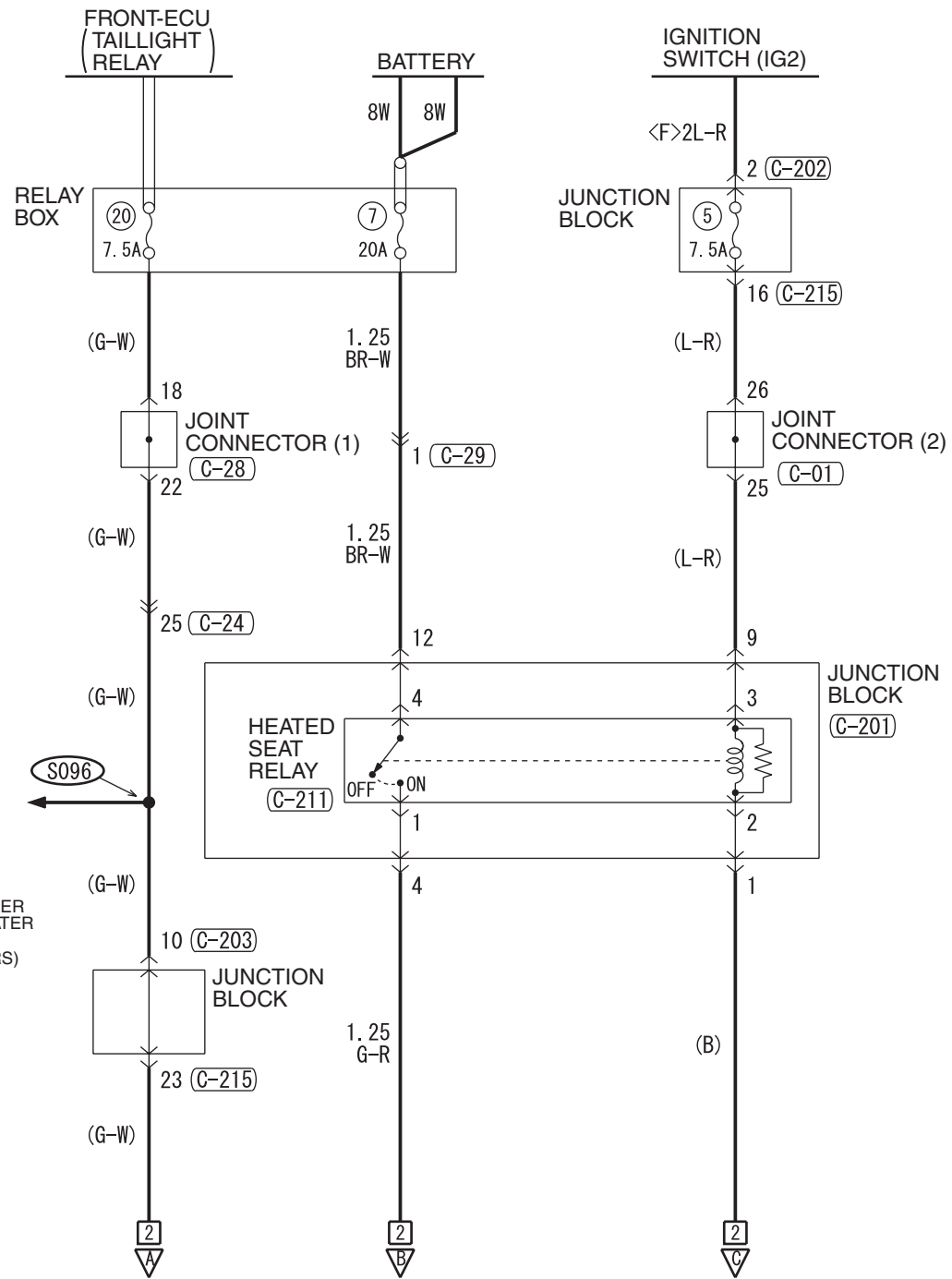

2

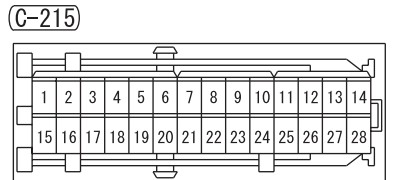
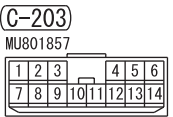
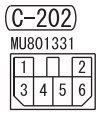
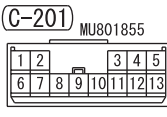
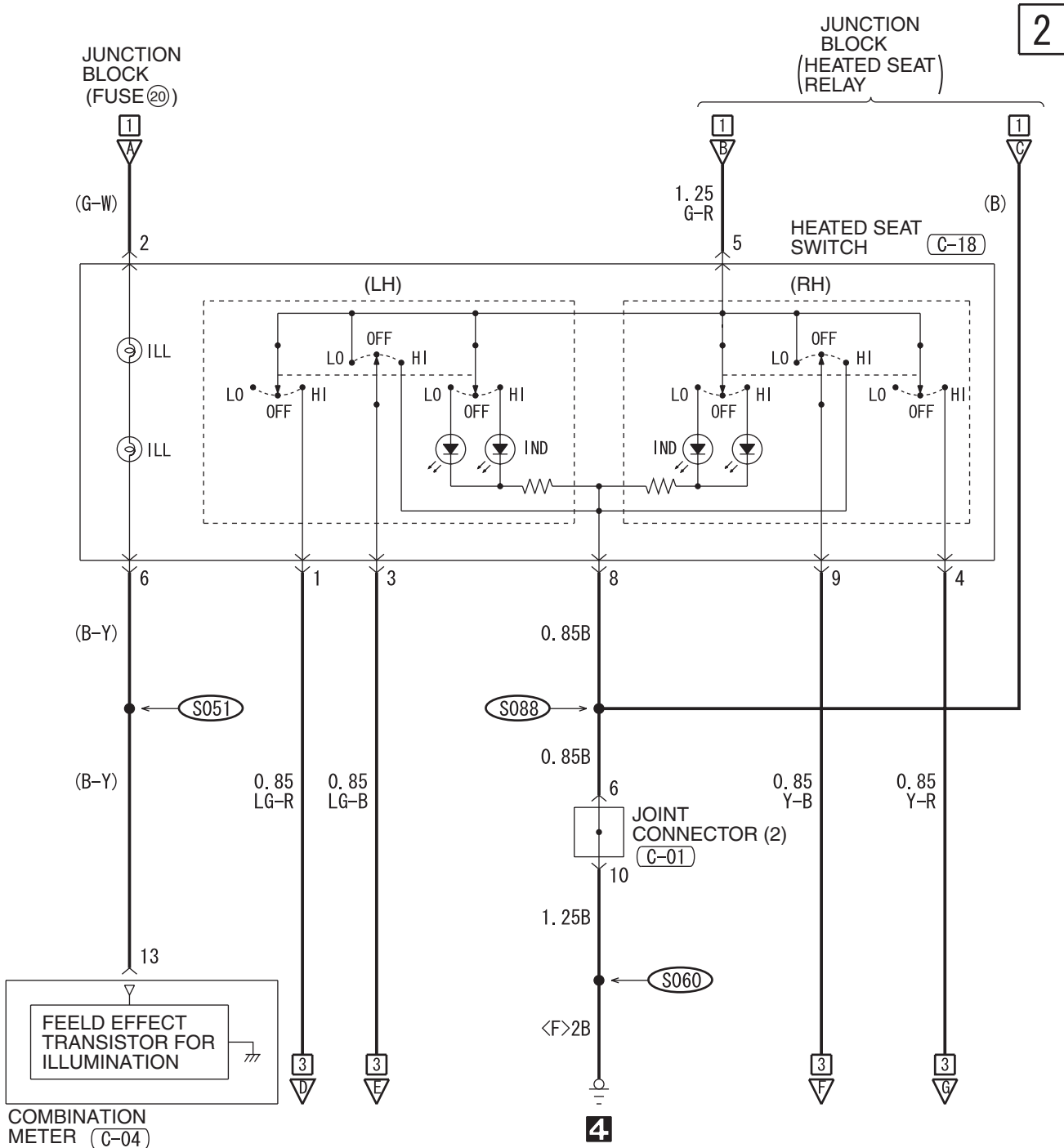

WIRE COLOR CODE
 B : BLACK LG : LIGHT GREEN G : GREEN L : BLUE W : WHITE Y : YELLOW SB : SKY BLUE
 BR : BROWN O : ORANGE GR : GRAY R : RED P : PINK V : VIOLET PU : PURPLE

H6P15M15AB

HEATED SEAT (CONTINUED)

3

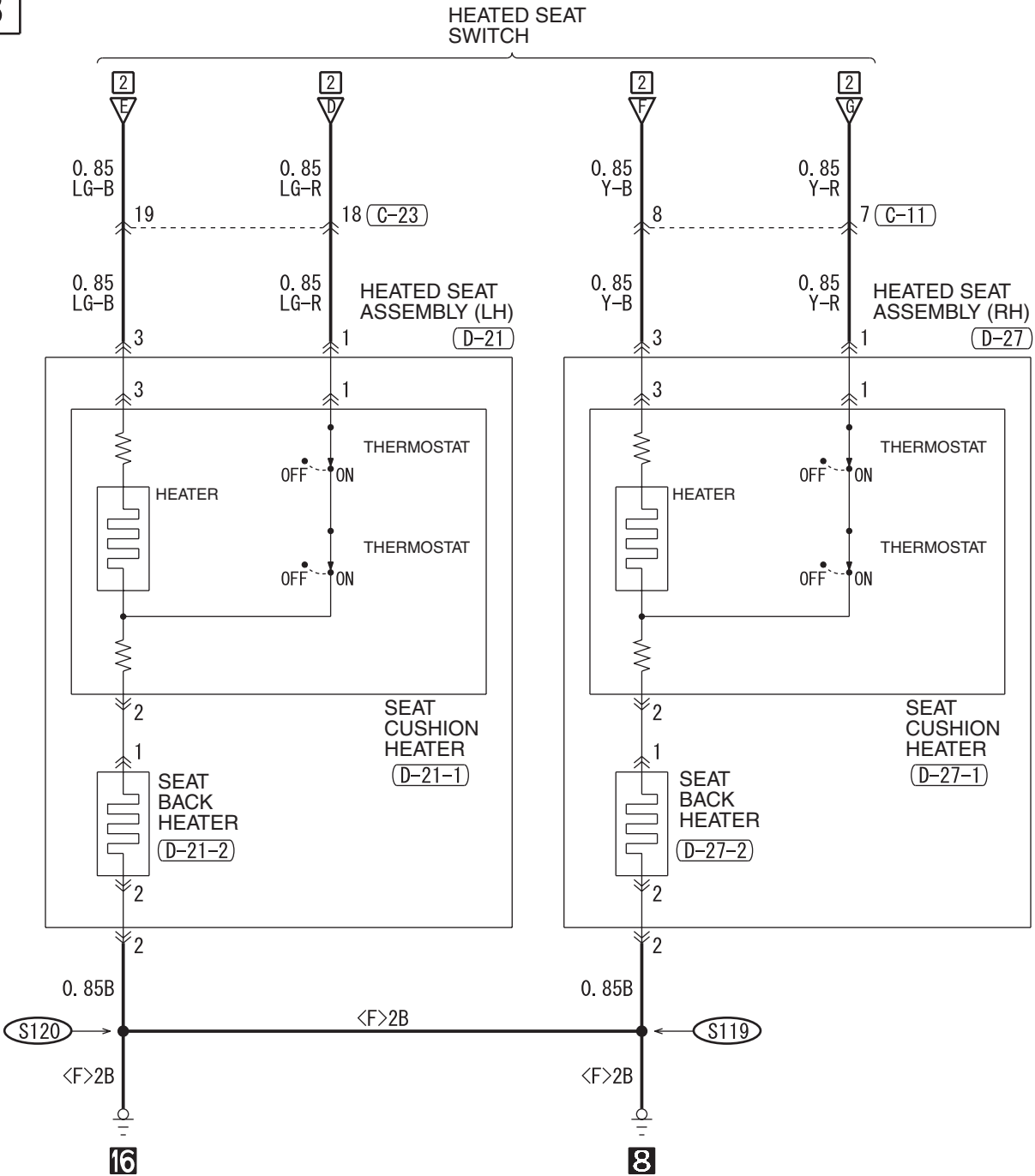

(C-11)

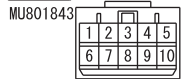

(C-23)

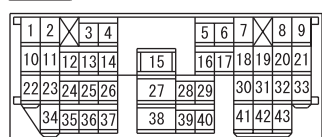

(D-21)



(D-21-1)



(D-21-2)



(D-27)



(D-27-1)



(D-27-2)



WIRE COLOR CODE

B: BLACK LG: LIGHT GREEN G: GREEN L: BLUE
BR: BROWN O: ORANGE GR: GRAY R: RED W: WHITE
SB: SKY BLUE P: PINK Y: YELLOW V: VIOLET P: PURPLE
H6P15M15BA

NOTES

FORGOTTEN KEY PREVENTION FUNCTION

M1901016100402

1

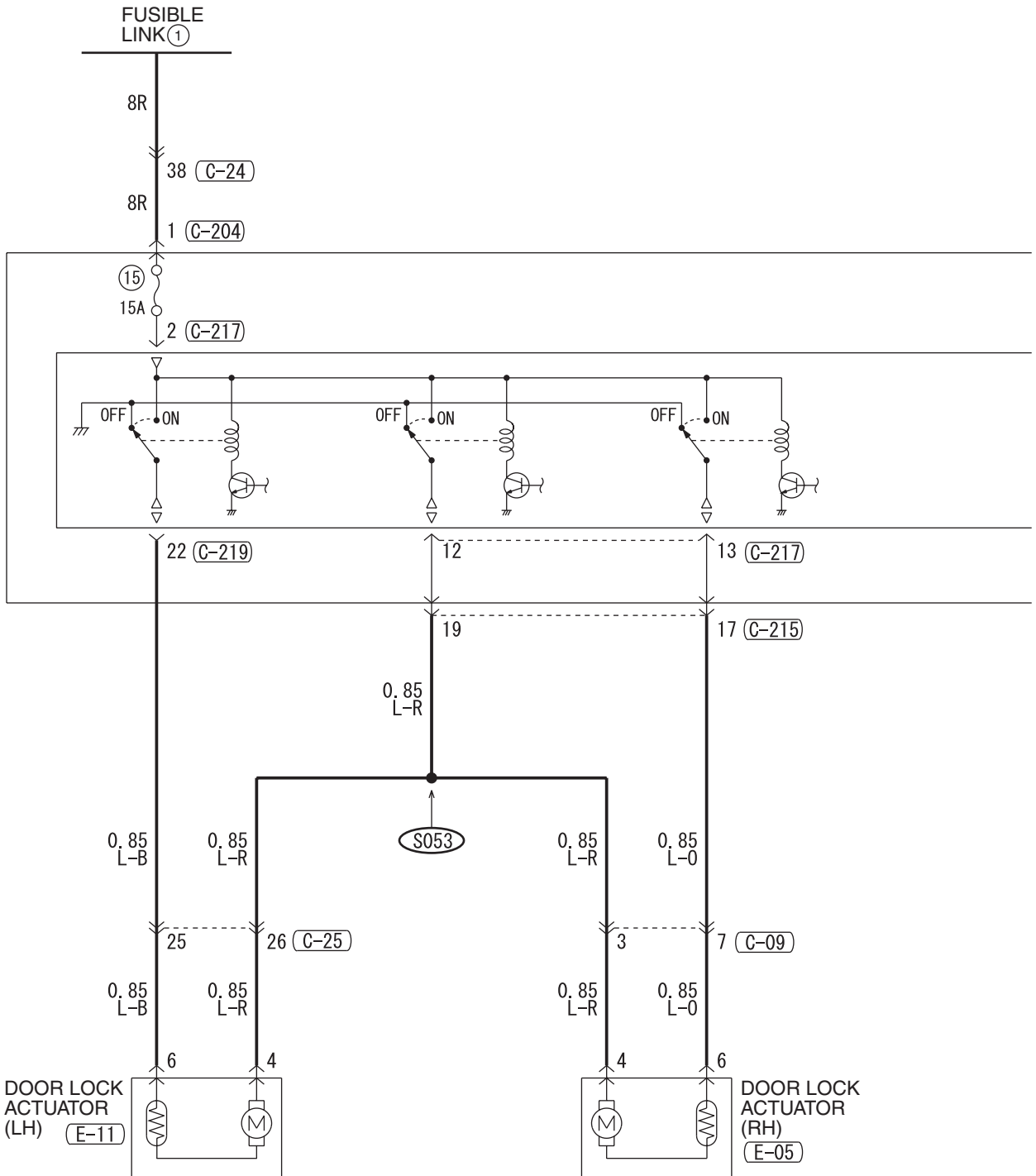

(C-09)
MU801890

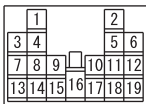

(C-24)

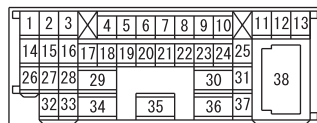

(C-25)

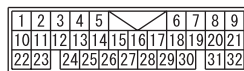

(C-204)
MU801403



(C-215)

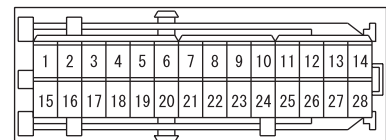

H6P15M16AA

2

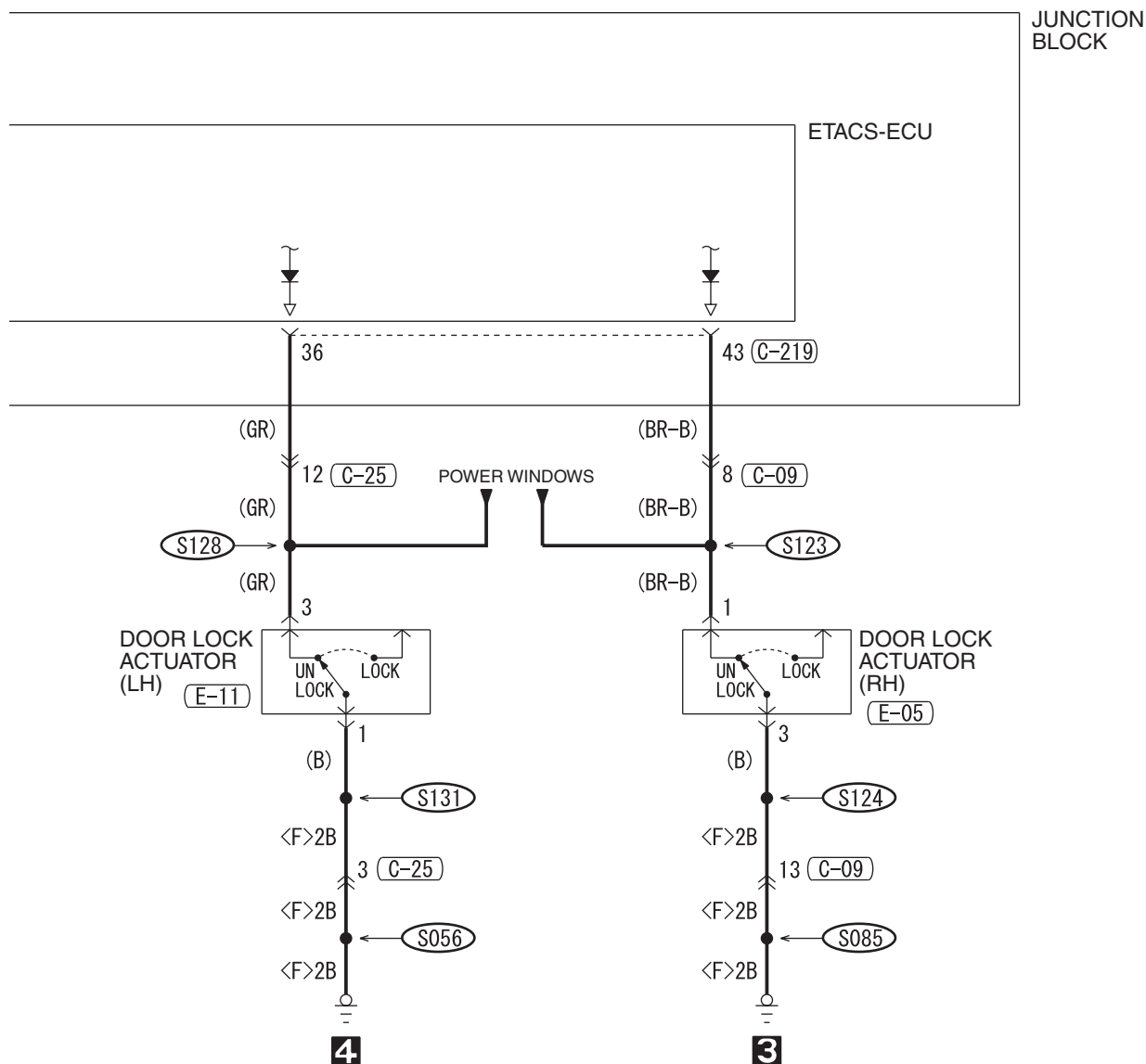

(C-217) JUNCTION BLOCK SIDE

20	19	18	17	16	15	14	13	12	11	10	9	8	7	6	5	4	3	2	1
----	----	----	----	----	----	----	----	----	----	----	---	---	---	---	---	---	---	---	---

(C-219) (MU803765)

21	22	23	24	25	26	27	28	29
30	31	32	33	34	35	36	37	38
39	40	41	42	43	44			

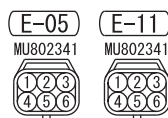

WIRE COLOR CODE
 B : BLACK LG : LIGHT GREEN G : GREEN L : BLUE W : WHITE Y : YELLOW SB : SKY BLUE
 BR : BROWN O : ORANGE GR : GRAY R : RED P : PINK V : VIOLET PU : PURPLE

FORGOTTEN KEY PREVENTION FUNCTION (CONTINUED)

3

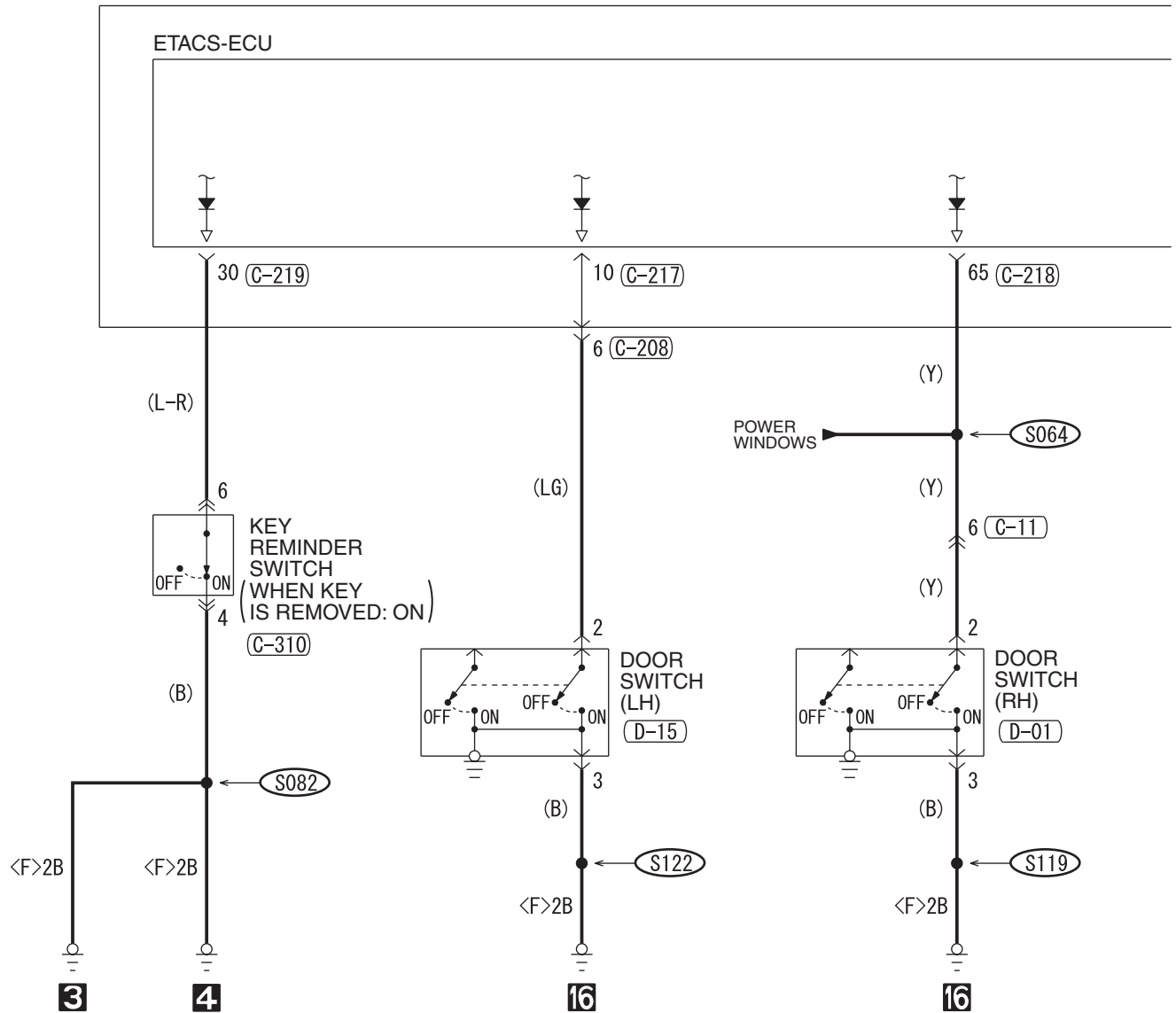

C-11

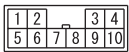

C-24

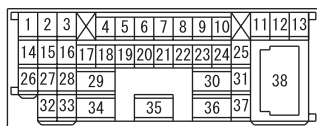

C-125 FRONT SIDE

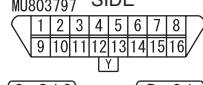

C-204



C-208



C-219



C-310

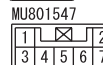

D-01



D-15



4

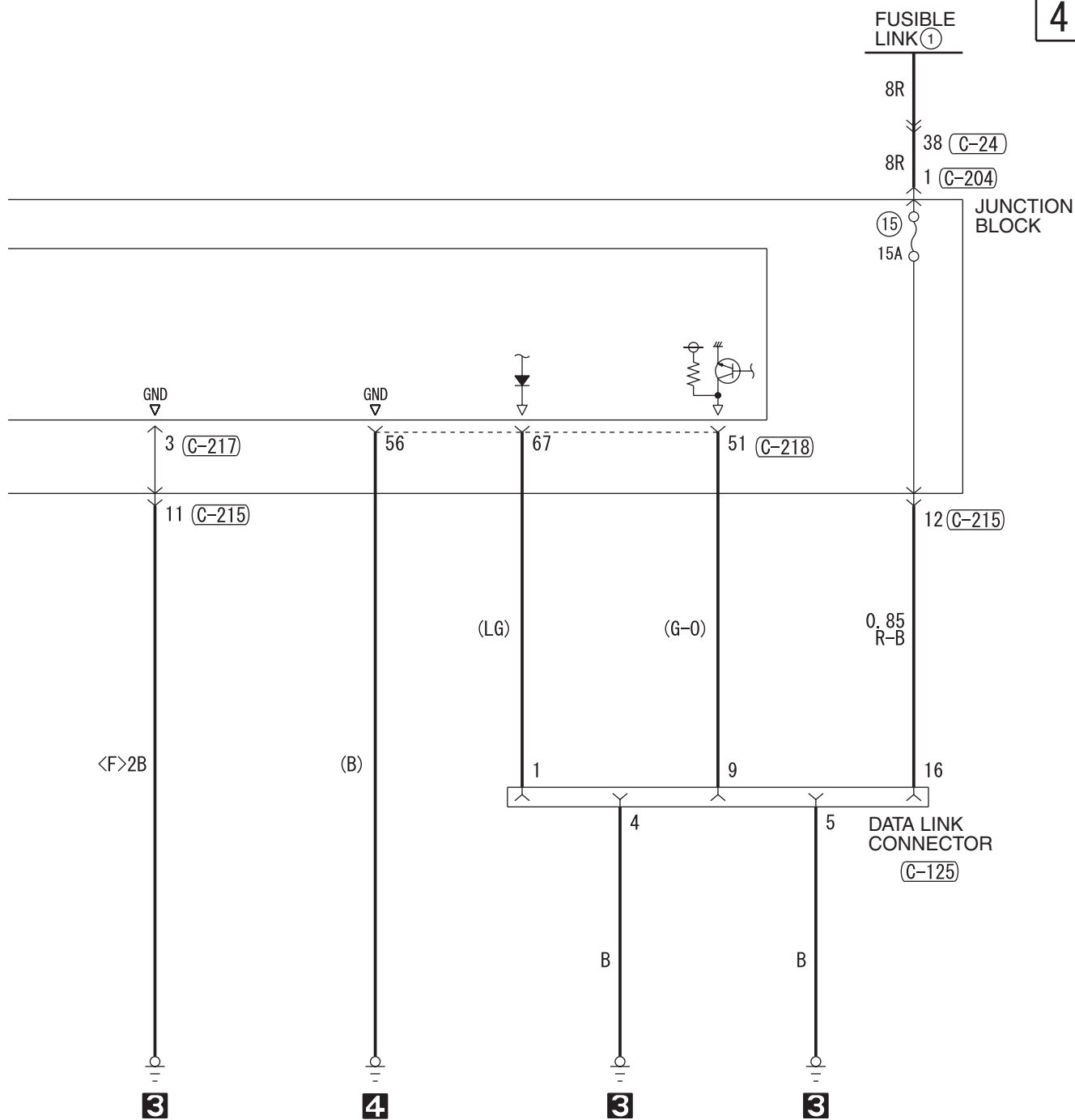

(C-215)

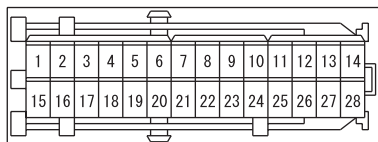

(C-217) JUNCTION BLOCK SIDE

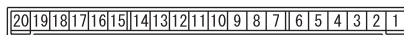

(C-218)

(MU803766)

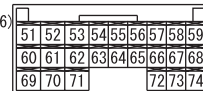

WIRE COLOR CODE

B : BLACK LG : LIGHT GREEN G : GREEN L : BLUE
BR : BROWN O : ORANGE GR : GRAY R : RED W : WHITE
SB : SKY BLUE P : PINK Y : YELLOW V : VIOLET P : PURPLE

H6P15M16BB

LIGHTING MONITOR TONE ALARM

M1901011400709

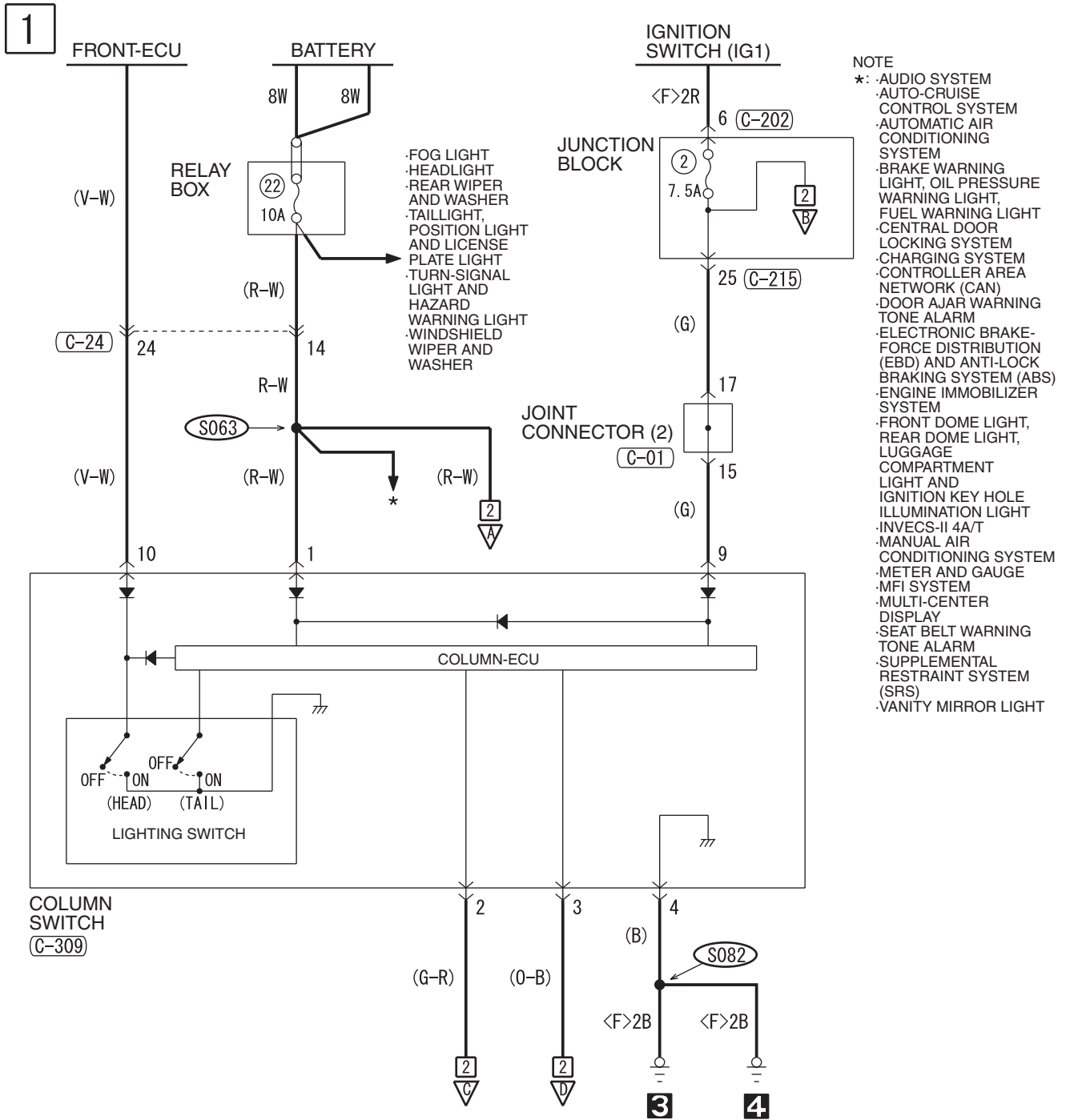

C-01

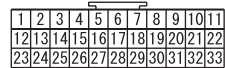

C-309

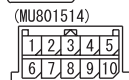

D-15



C-24

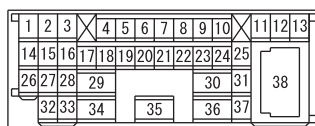

C-125 FRONT SIDE

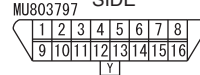

C-202



C-203

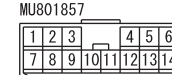

C-204



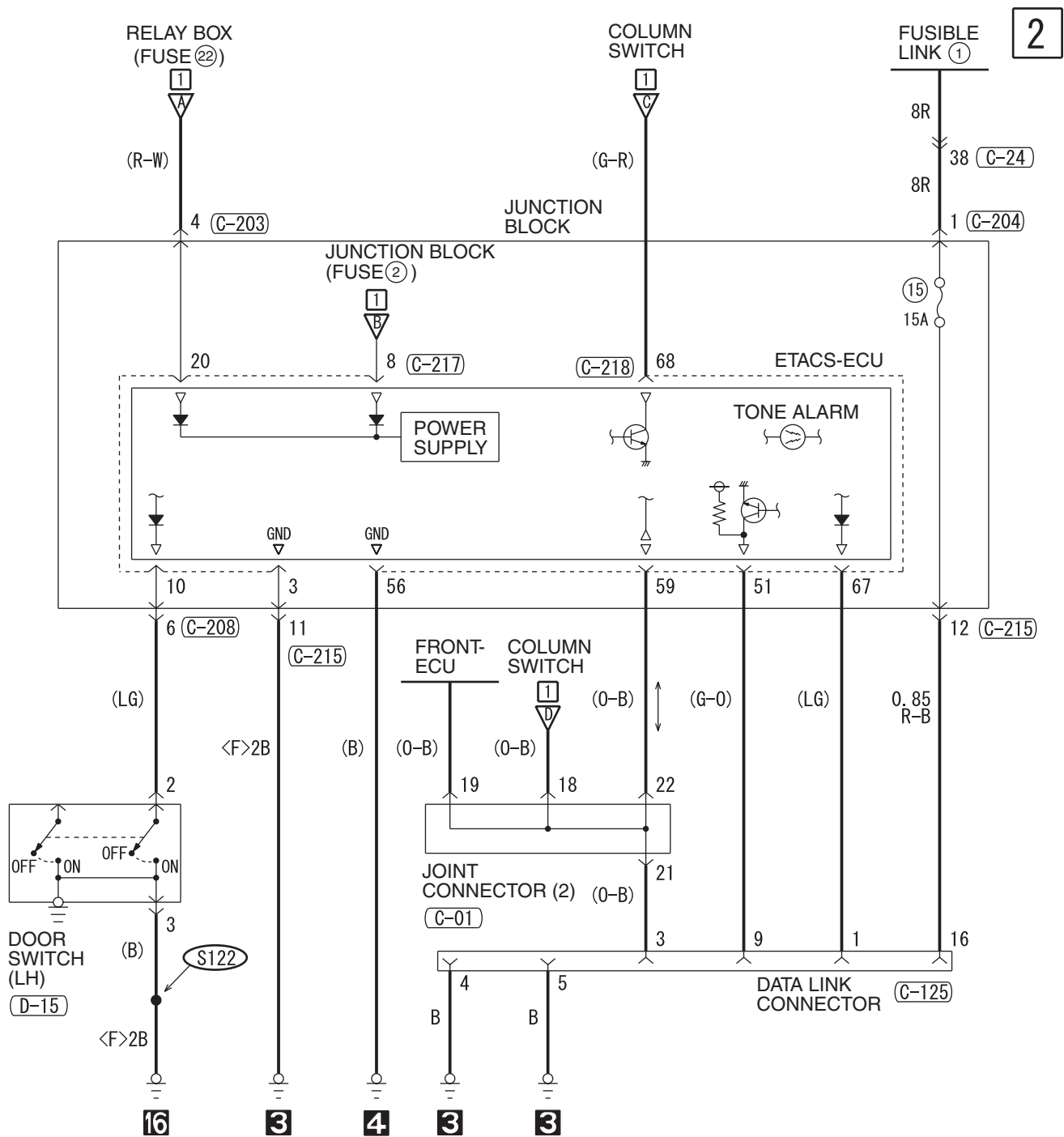

(C-208)

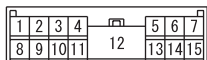

(C-215)

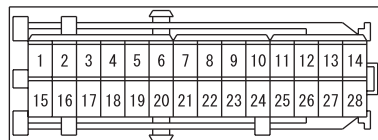

(C-217) JUNCTION BLOCK SIDE

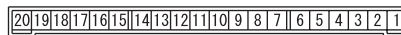

(C-218)

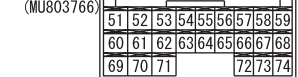

IGNITION KEY REMINDER TONE ALARM

1

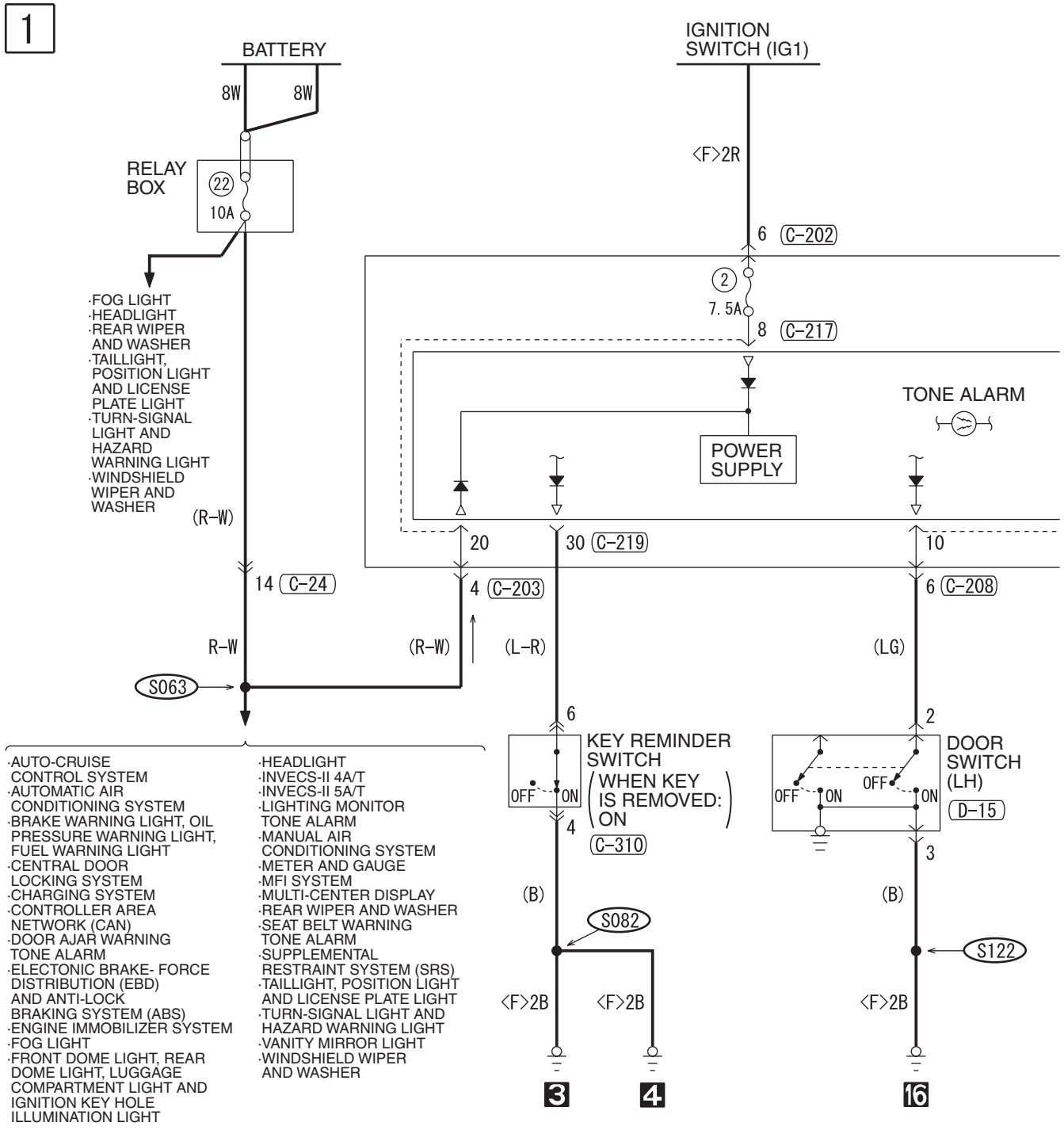

- FOG LIGHT
- HEADLIGHT
- REAR WIPER AND WASHER
- TAILLIGHT, POSITION LIGHT AND LICENSE PLATE LIGHT
- TURN-SIGNAL LIGHT AND HAZARD WARNING LIGHT
- WINDSHIELD WIPER AND WASHER

- AUTO-CRUISE CONTROL SYSTEM
- AUTOMATIC AIR CONDITIONING SYSTEM
- BRAKE WARNING LIGHT, OIL PRESSURE WARNING LIGHT, FUEL WARNING LIGHT
- CENTRAL DOOR LOCKING SYSTEM
- CHARGING SYSTEM
- CONTROLLER AREA NETWORK (CAN)
- DOOR AJAR WARNING TONE ALARM
- ELECTRONIC BRAKE FORCE DISTRIBUTION (EBD) AND ANTI-LOCK BRAKING SYSTEM (ABS)
- ENGINE IMMOBILIZER SYSTEM
- FOG LIGHT
- FRONT DOME LIGHT, REAR DOME LIGHT, LUGGAGE COMPARTMENT LIGHT AND IGNITION KEY HOLE ILLUMINATION LIGHT

- HEADLIGHT
- INVECS-II 4A/T
- INVECS-II 5A/T
- LIGHTING MONITOR TONE ALARM
- MANUAL AIR CONDITIONING SYSTEM
- METER AND GAUGE
- MFI SYSTEM
- MULTI-CENTER DISPLAY
- REAR WIPER AND WASHER
- SEAT BELT WARNING TONE ALARM
- SUPPLEMENTAL RESTRAINT SYSTEM (SRS)
- TAILLIGHT, POSITION LIGHT AND LICENSE PLATE LIGHT
- TURN-SIGNAL LIGHT AND HAZARD WARNING LIGHT
- VANITY MIRROR LIGHT
- WINDSHIELD WIPER AND WASHER

C-24

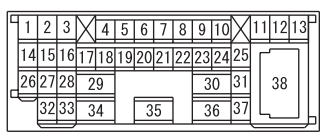

C-125 FRONT SIDE

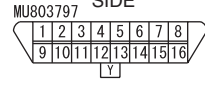

C-202



C-203



C-204



C-208

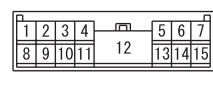

C-219

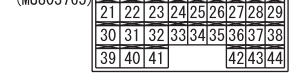

C-310



D-15



2

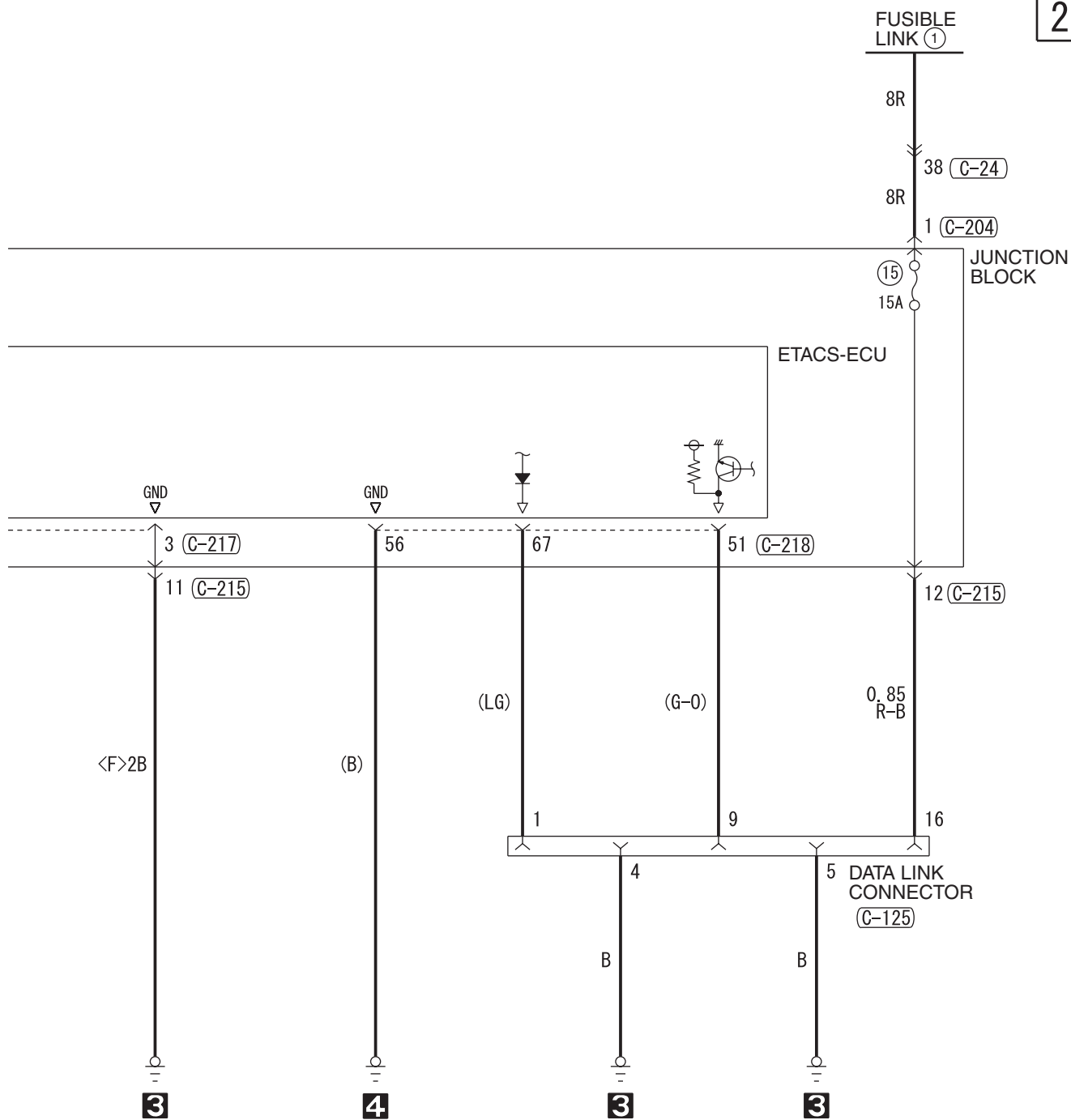

(C-215)

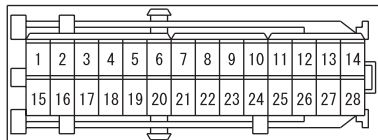

(C-217) JUNCTION BLOCK SIDE

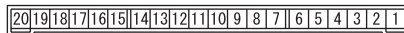

(C-218)

(MU803766)



WIRE COLOR CODE

B: BLACK LG: LIGHT GREEN G: GREEN L: BLUE
BR: BROWN O: ORANGE GR: GRAY R: RED W: WHITE
SB: SKY BLUE P: PINK Y: YELLOW V: VIOLET PU: PURPLE

H6P15M18AB

SEAT BELT WARNING TONE ALARM

M1901011200943

1

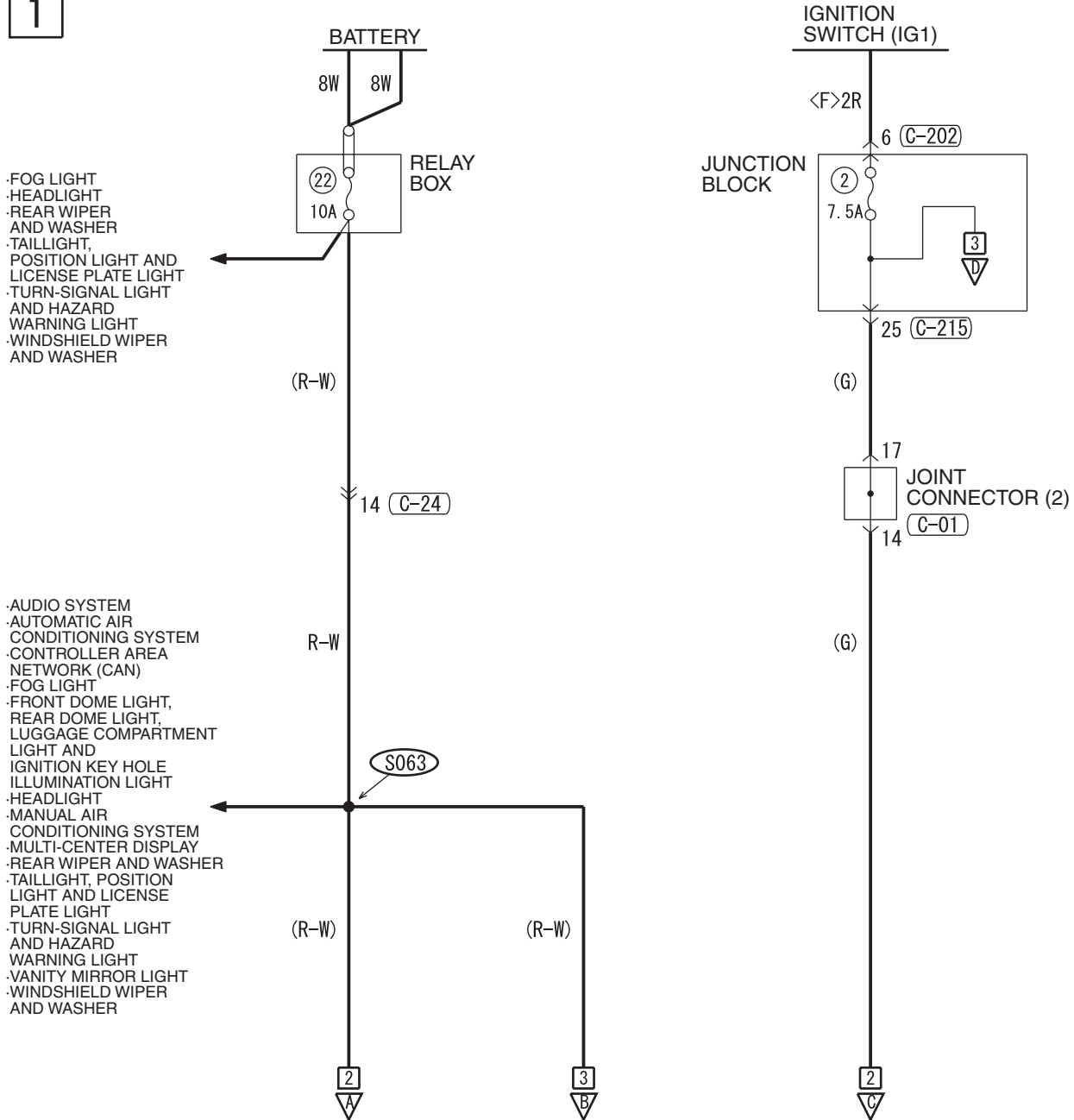

(C-01)



(C-04)

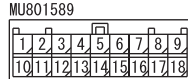

(C-23)

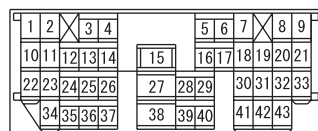

(C-24)

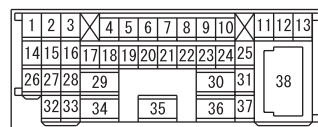

(C-202)



H6P15M19AA

2

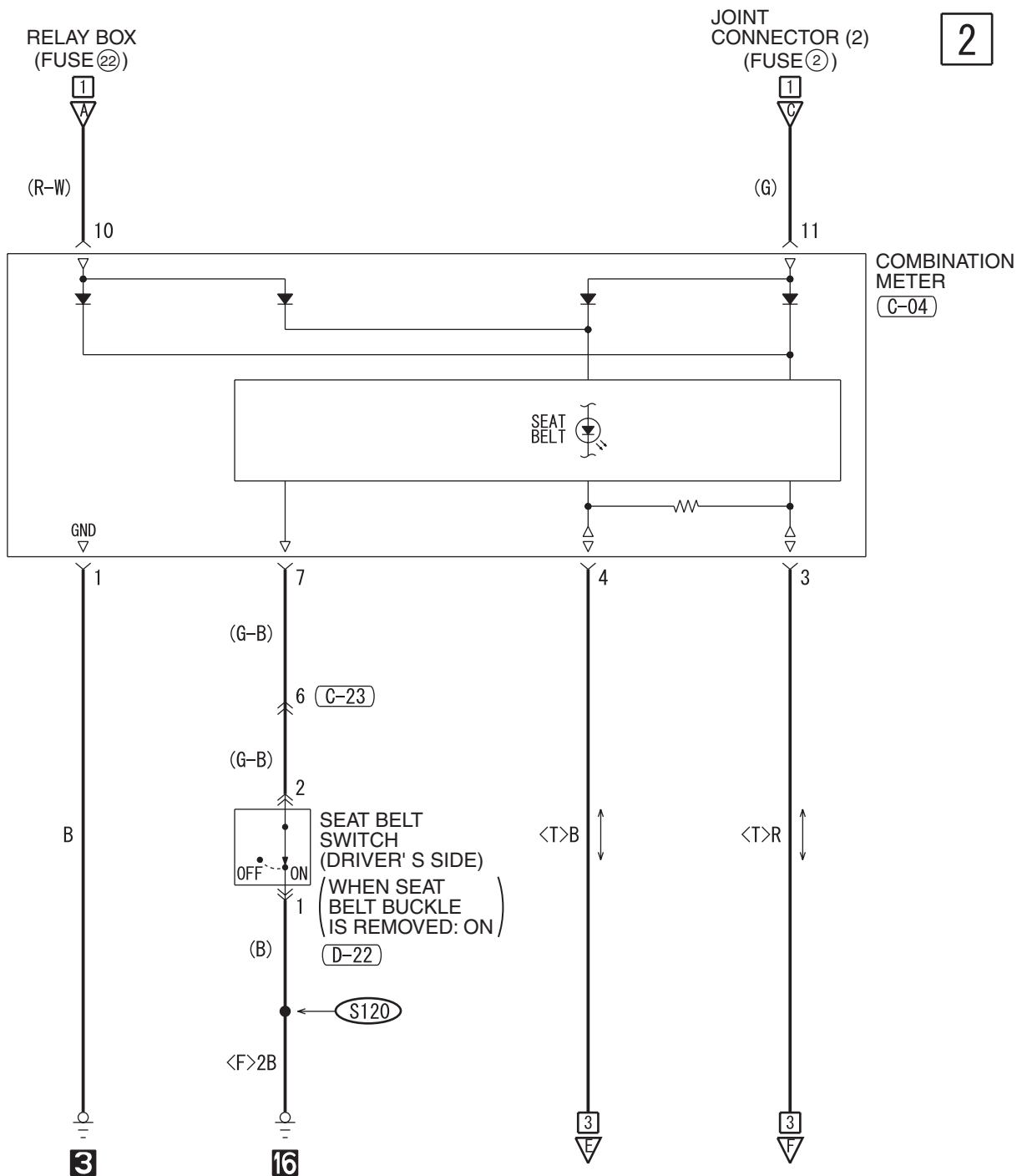

(C-215)

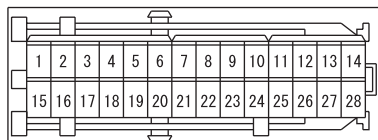

(D-22)

MU801569

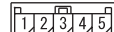

WIRE COLOR CODE

B : BLACK LG : LIGHT GREEN G : GREEN L : BLUE
BR : BROWN O : ORANGE GR : GRAY R : RED W : WHITE
SB : SKY BLUE P : PINK Y : YELLOW V : VIOLET PU : PURPLE

H6P15M19AB

TSB Revision

SEAT BELT WARNING TONE ALARM (CONTINUED)

3

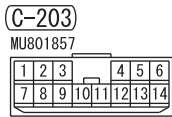
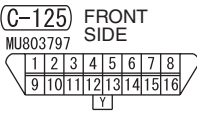
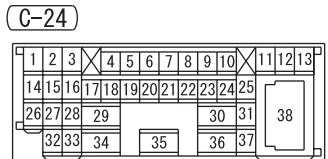
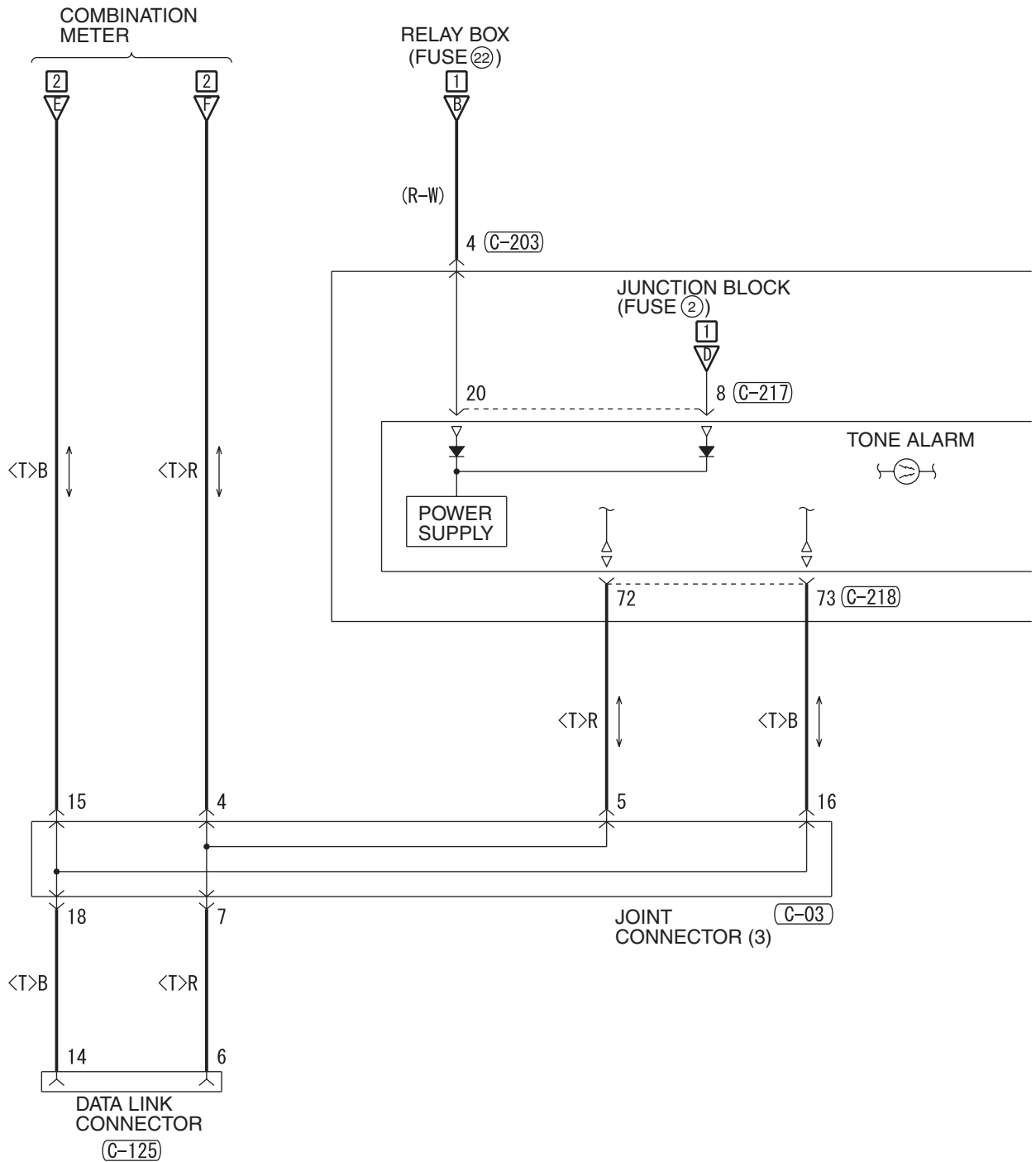

4

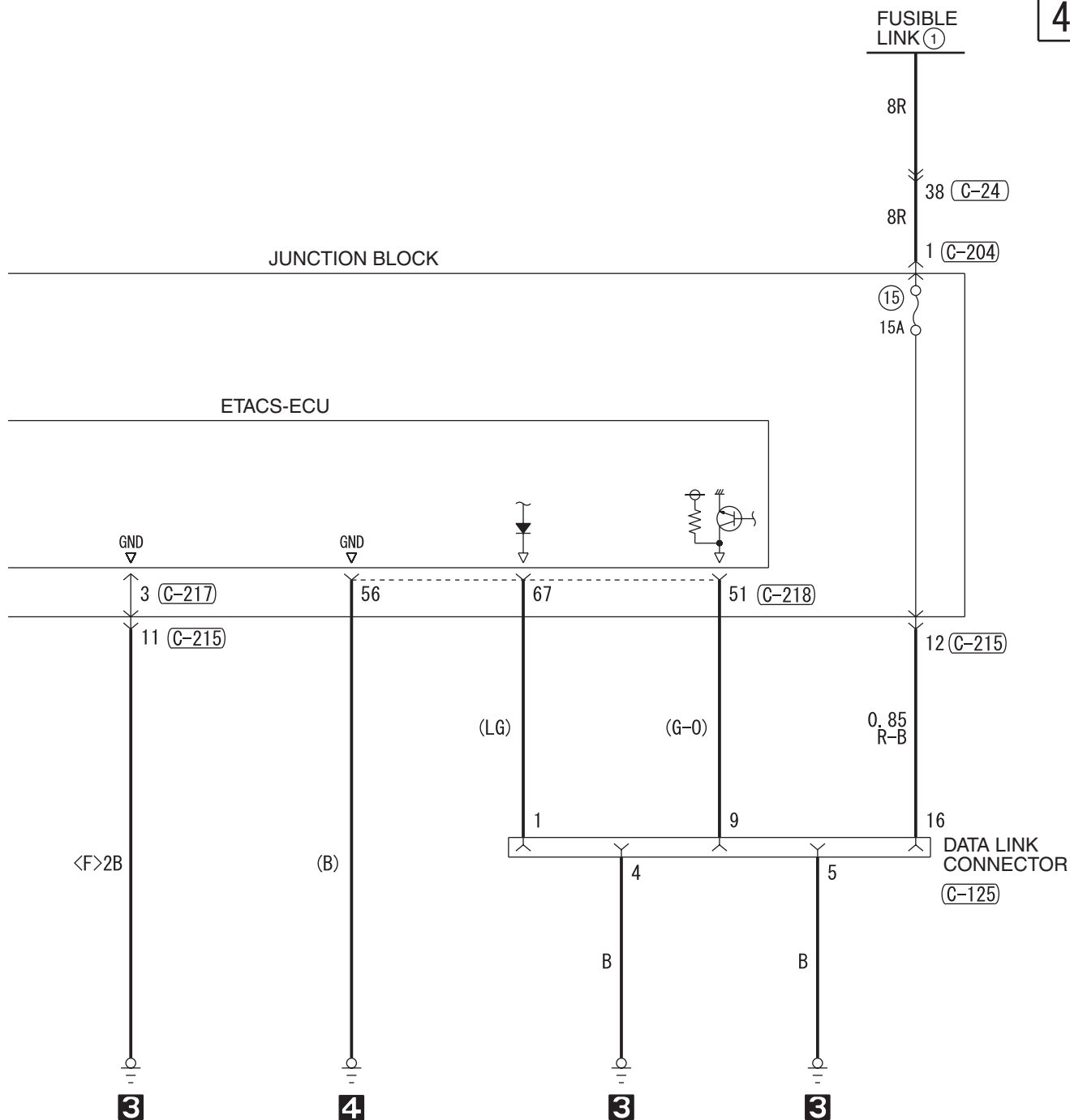

(C-215)

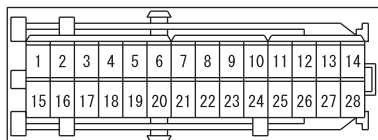

(C-217) JUNCTION BLOCK SIDE

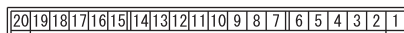

(C-218)

(MU803766)

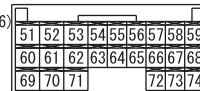

WIRE COLOR CODE
 B : BLACK LG : LIGHT GREEN G : GREEN L : BLUE
 BR : BROWN O : ORANGE GR : GRAY R : RED W : WHITE
 SB : SKY BLUE P : PINK Y : YELLOW V : VIOLET PU : PURPLE

H6P15M19BB

DOOR AJAR WARNING TONE ALARM <M/T>

M1901016600515

1

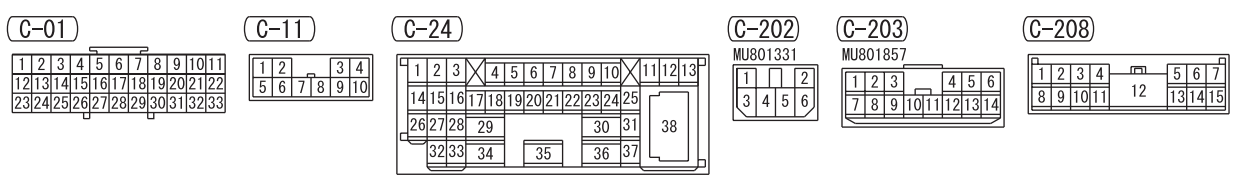
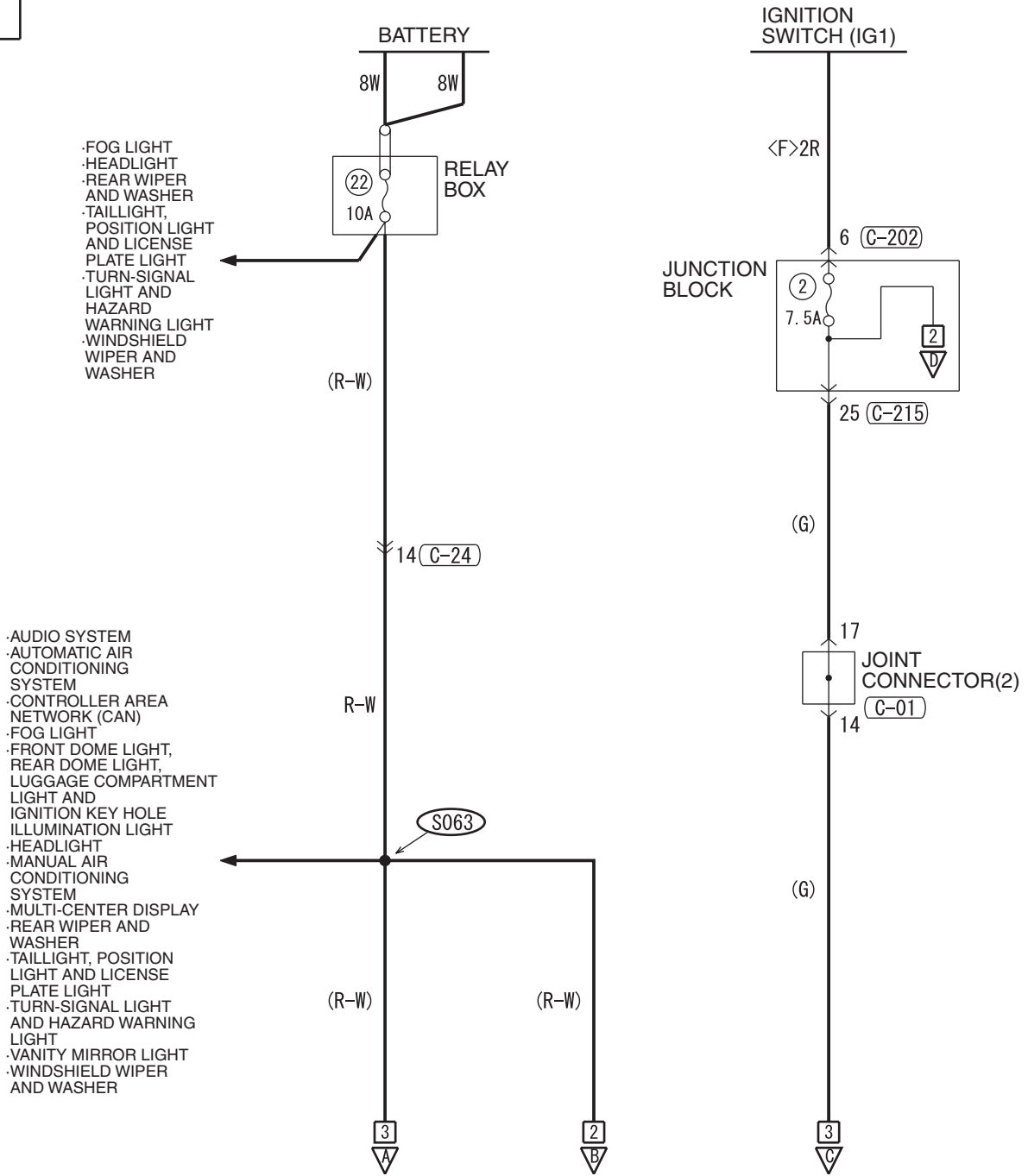

2

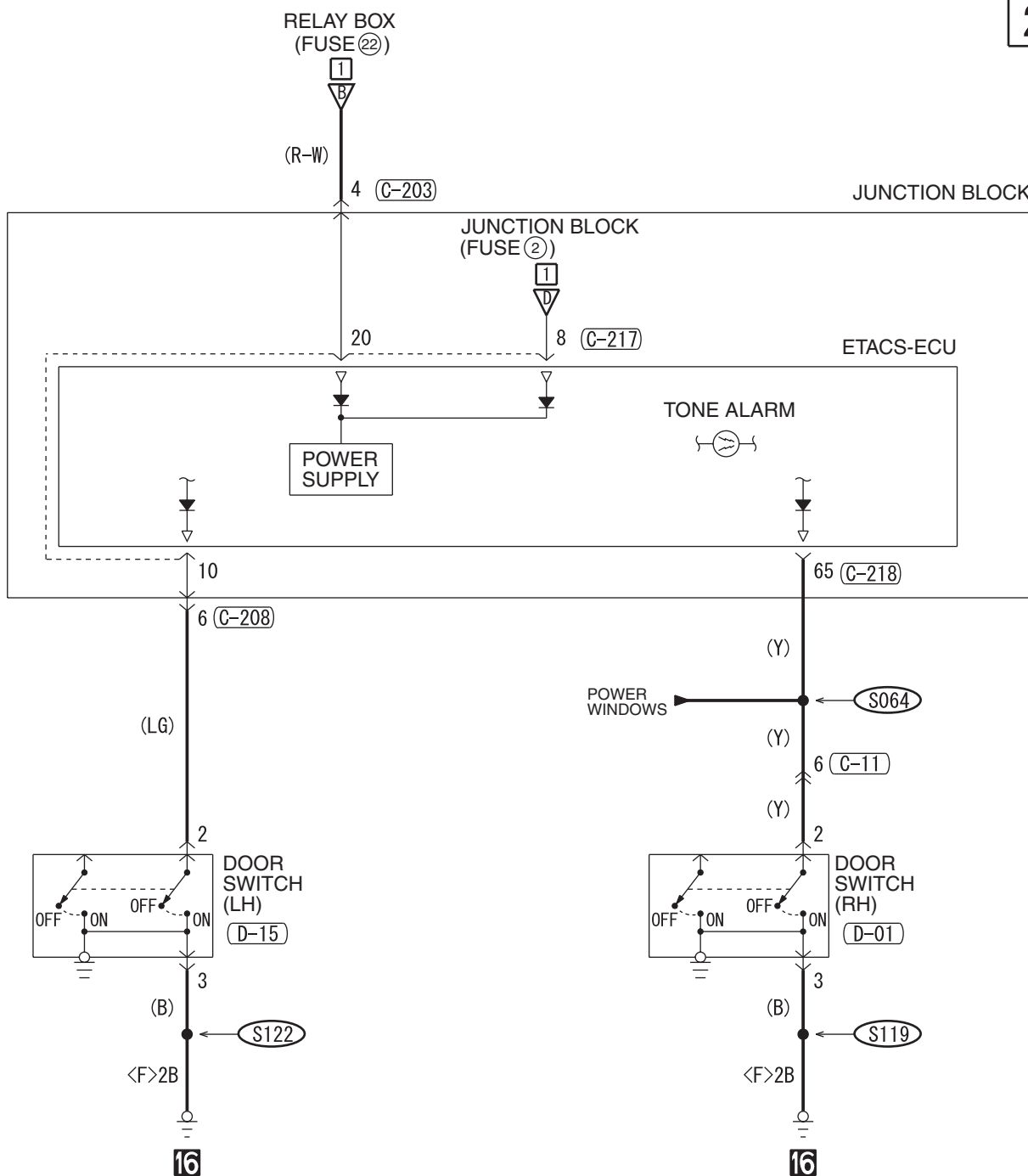

(C-215)

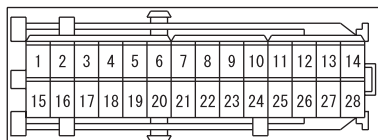

(C-217) JUNCTION BLOCK SIDE

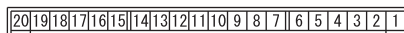

(C-218)

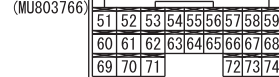

(D-01)



(D-15)



WIRE COLOR CODE
 B : BLACK LG : LIGHT GREEN G : GREEN L : BLUE
 BR : BROWN O : ORANGE GR : GRAY R : RED W : WHITE
 SB : SKY BLUE P : PINK Y : YELLOW V : VIOLET PU : PURPLE

H6P15M20AB

DOOR AJAR WARNING TONE ALARM <M/T> (CONTINUED)

3

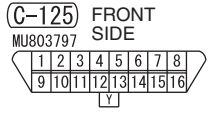
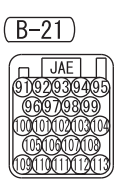
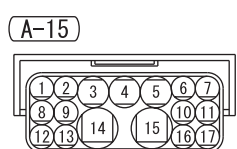
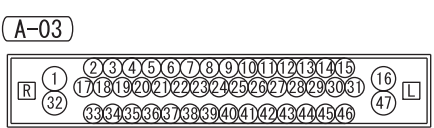
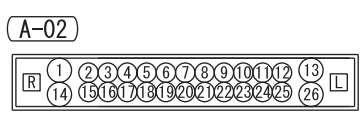
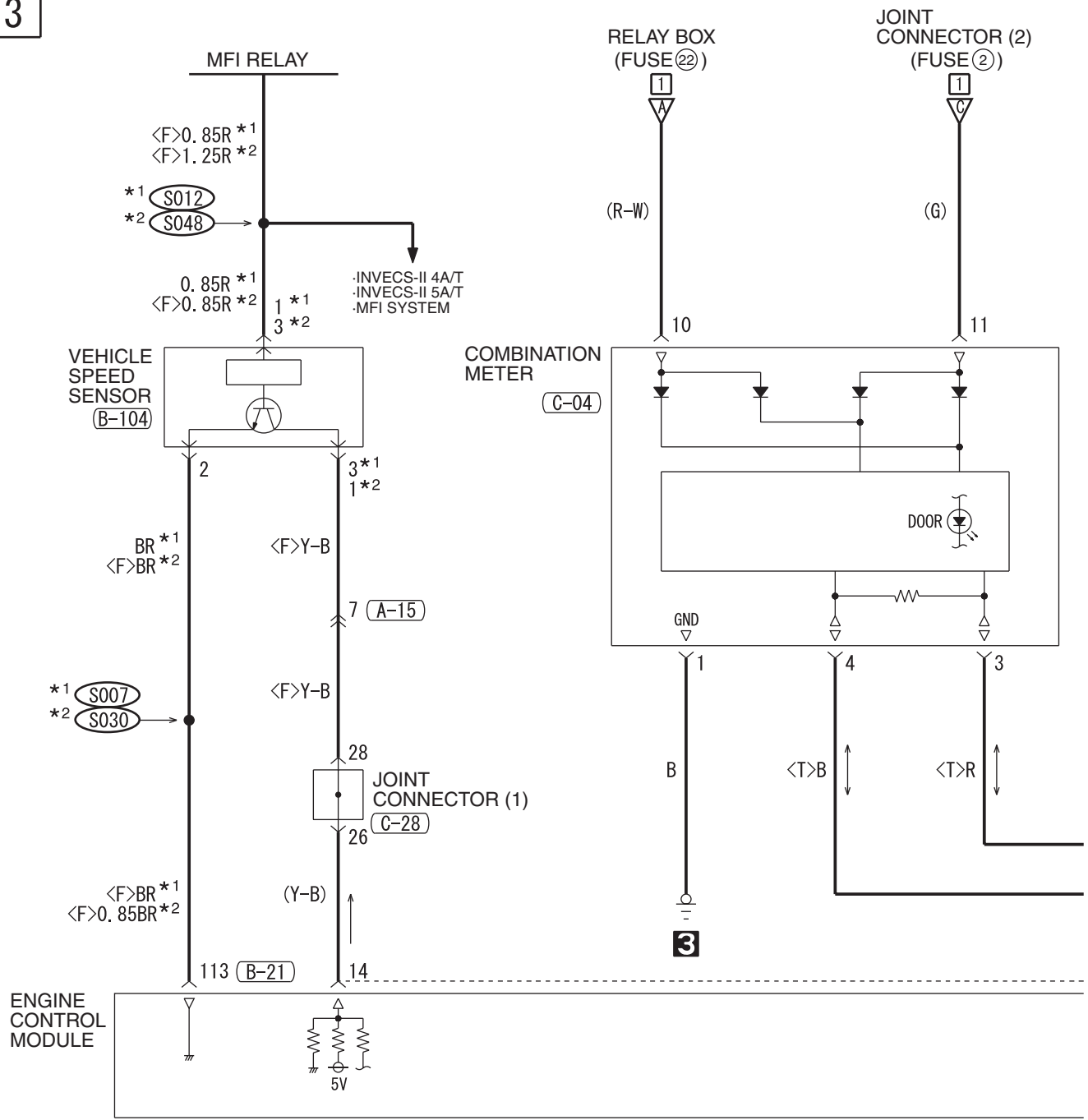

4

NOTE

- *1 : 2.4L ENGINE
- *2 : 3.8L ENGINE
- *3 : WITHOUT TRACTION CONTROL SYSTEM (TCL)
- *4 : WITH TRACTION CONTROL SYSTEM (TCL)

JOINT
CONNECTOR (3) (C-03)

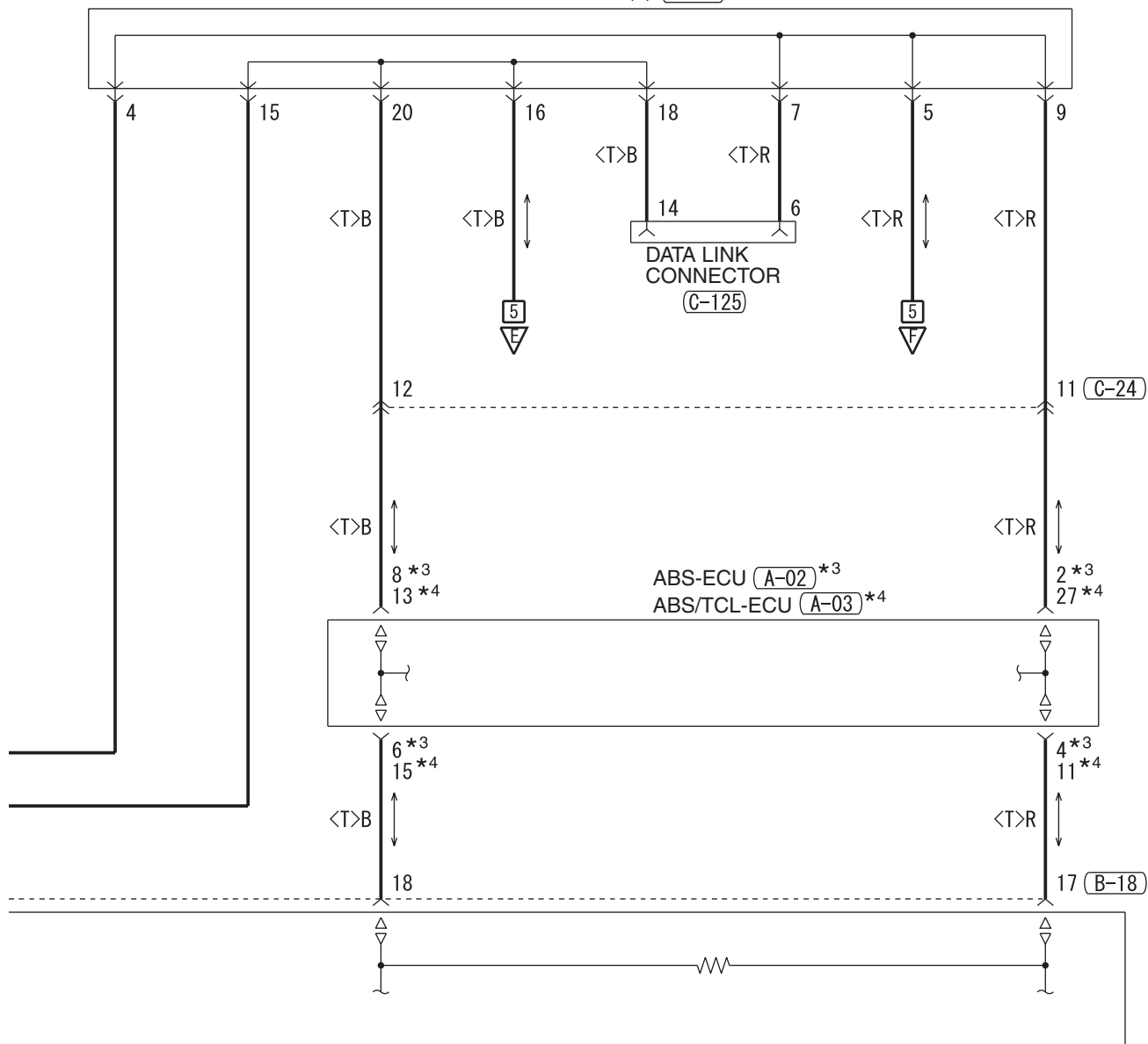

(B-104)



(C-03)

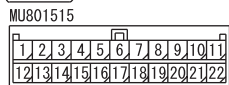

(C-04)

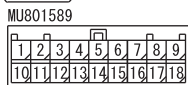

(C-24)

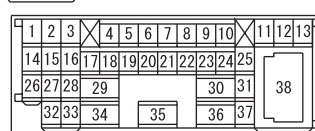

(C-28)

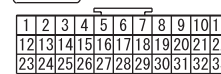

WIRE COLOR CODE

B : BLACK LG : LIGHT GREEN G : GREEN L : BLUE W : WHITE Y : YELLOW SB : SKY BLUE
BR : BROWN O : ORANGE GR : GRAY R : RED P : PINK V : VIOLET PU : PURPLE

H6P15M20BB

DOOR AJAR WARNING TONE ALARM <M/T> (CONTINUED)

5

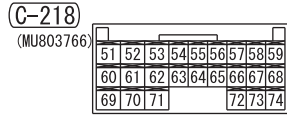
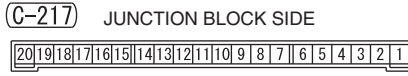
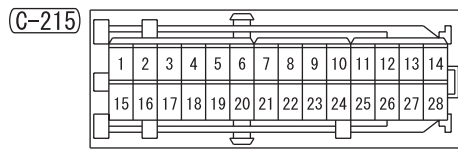
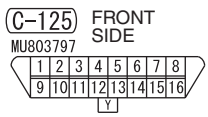
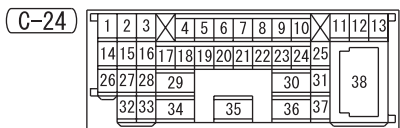
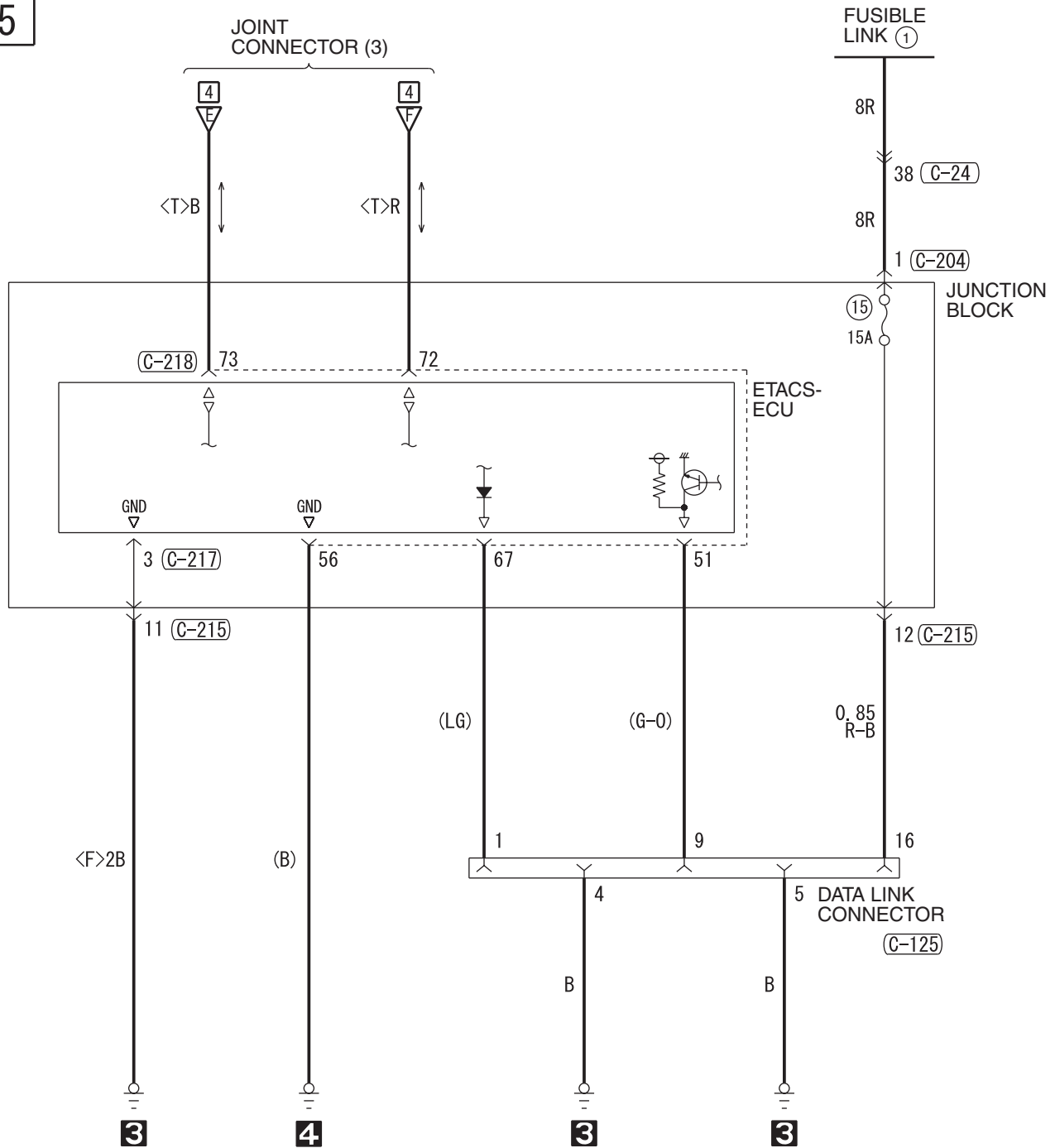

NOTES

DOOR AJAR WARNING TONE ALARM <A/T>

M1901016600526

1

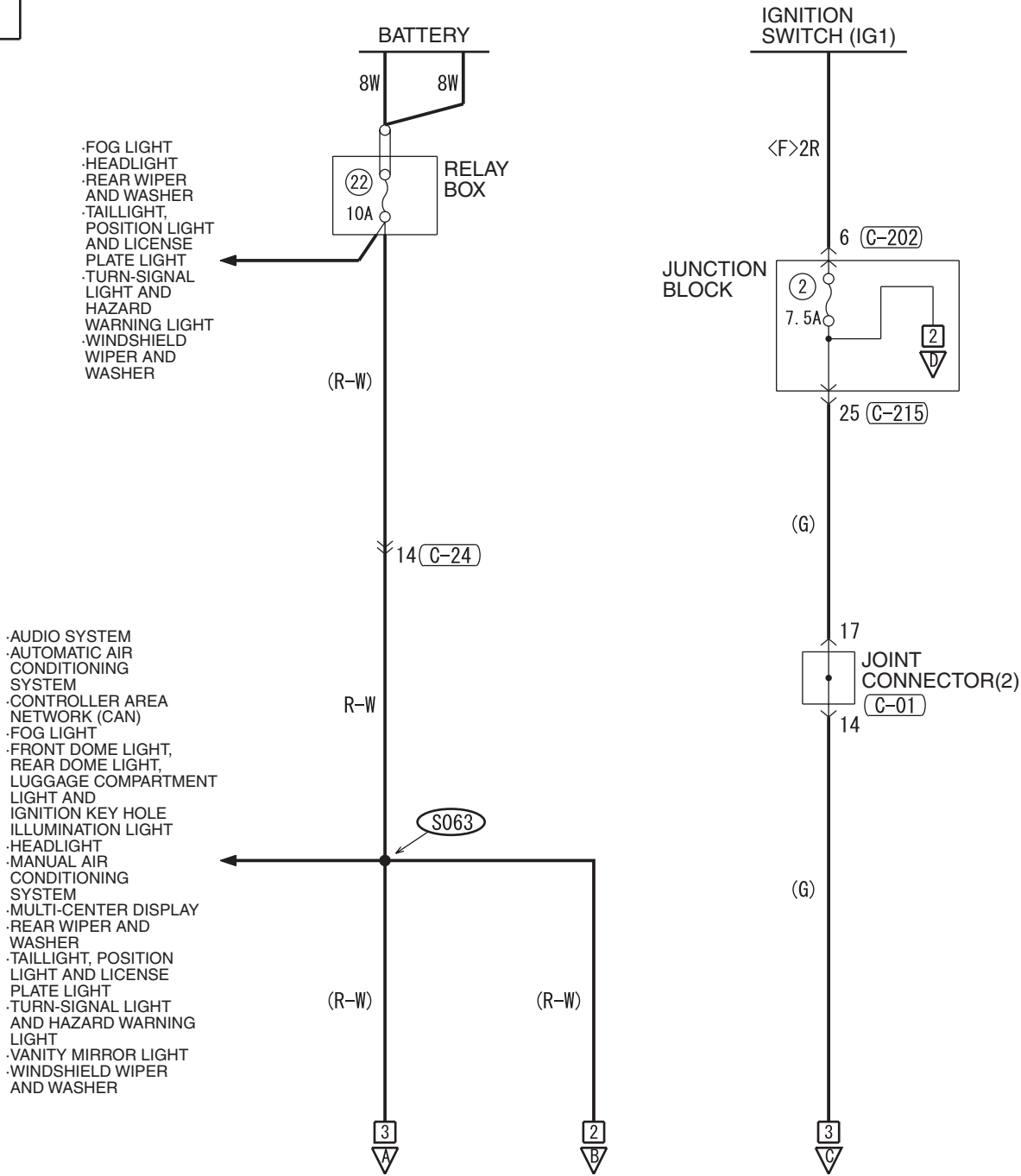

- .AUDIO SYSTEM
- .AUTOMATIC AIR CONDITIONING SYSTEM
- .CONTROLLER AREA NETWORK (CAN)
- .FOG LIGHT
- .FRONT DOME LIGHT, REAR DOME LIGHT, LUGGAGE COMPARTMENT LIGHT AND IGNITION KEY HOLE ILLUMINATION LIGHT
- .HEADLIGHT
- .MANUAL AIR CONDITIONING SYSTEM
- .MULTI-CENTER DISPLAY
- .REAR WIPER AND WASHER
- .TAILLIGHT, POSITION LIGHT AND LICENSE PLATE LIGHT
- .TURN-SIGNAL LIGHT AND HAZARD WARNING LIGHT
- .VANITY MIRROR LIGHT
- .WINDSHIELD WIPER AND WASHER

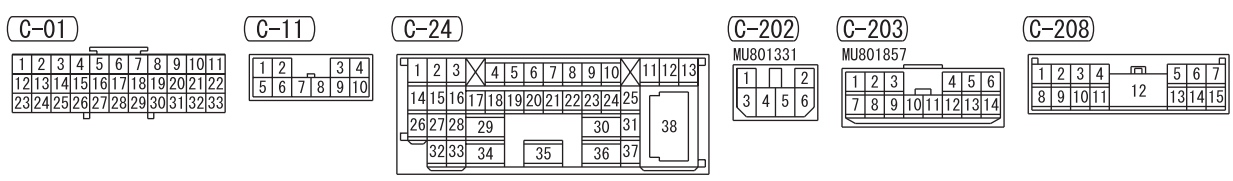

H6P15M21AA

2

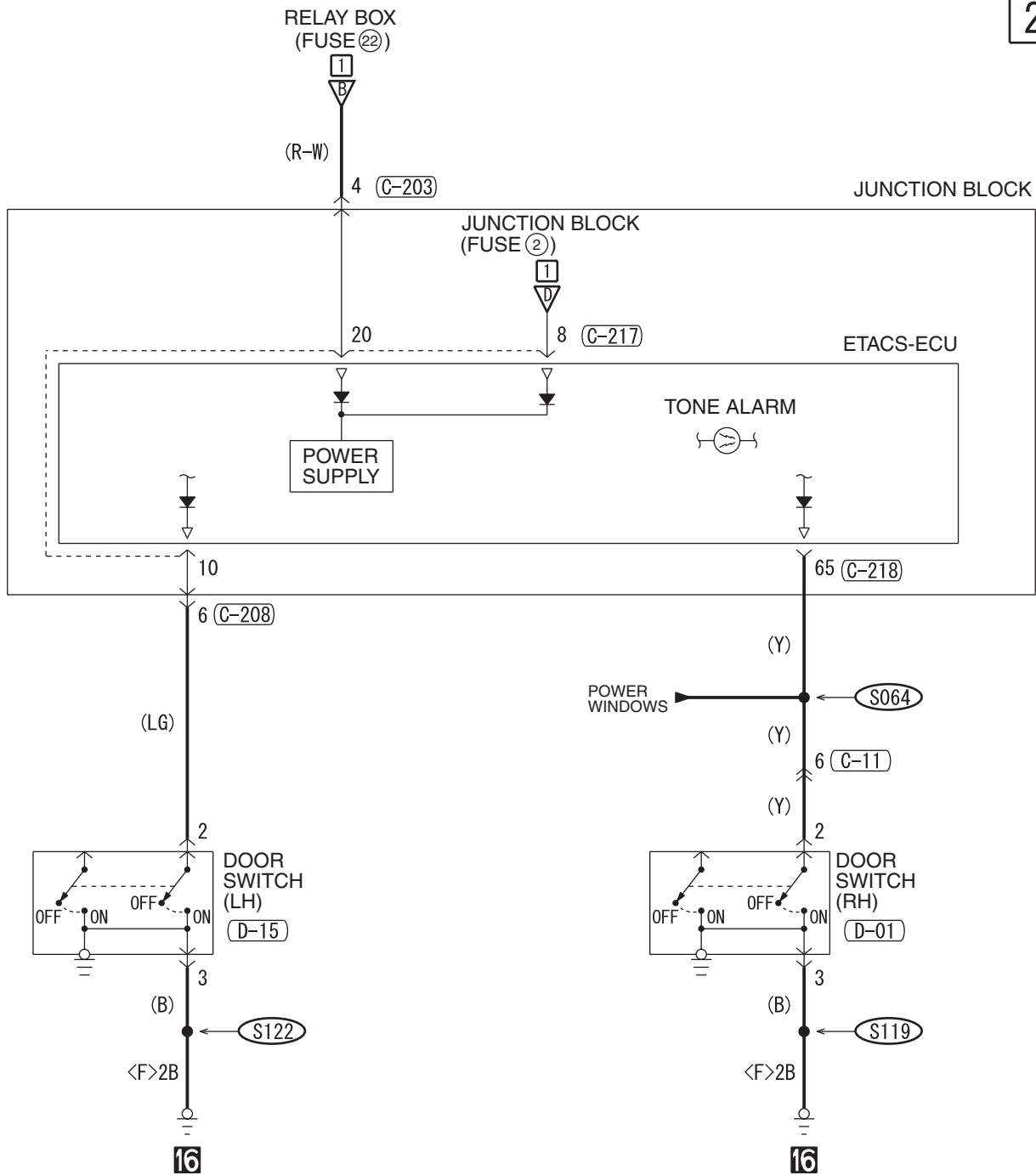

(C-215)

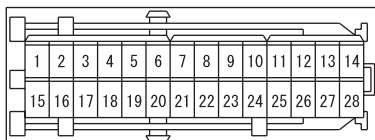

(C-217) JUNCTION BLOCK SIDE

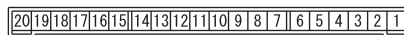

(C-218)



(D-01)



(D-15)



WIRE COLOR CODE
 B : BLACK LG : LIGHT GREEN G : GREEN L : BLUE
 BR : BROWN O : ORANGE GR : GRAY R : RED W : WHITE
 SB : SKY BLUE P : PINK Y : YELLOW V : VIOLET PU : PURPLE

H6P15M21AB

DOOR AJAR WARNING TONE ALARM <A/T> (CONTINUED)

3

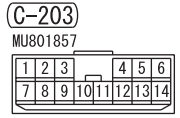
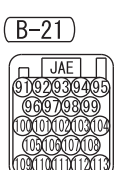
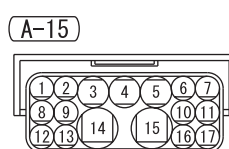
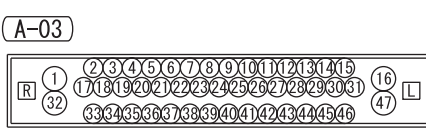
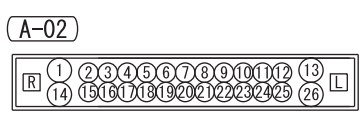
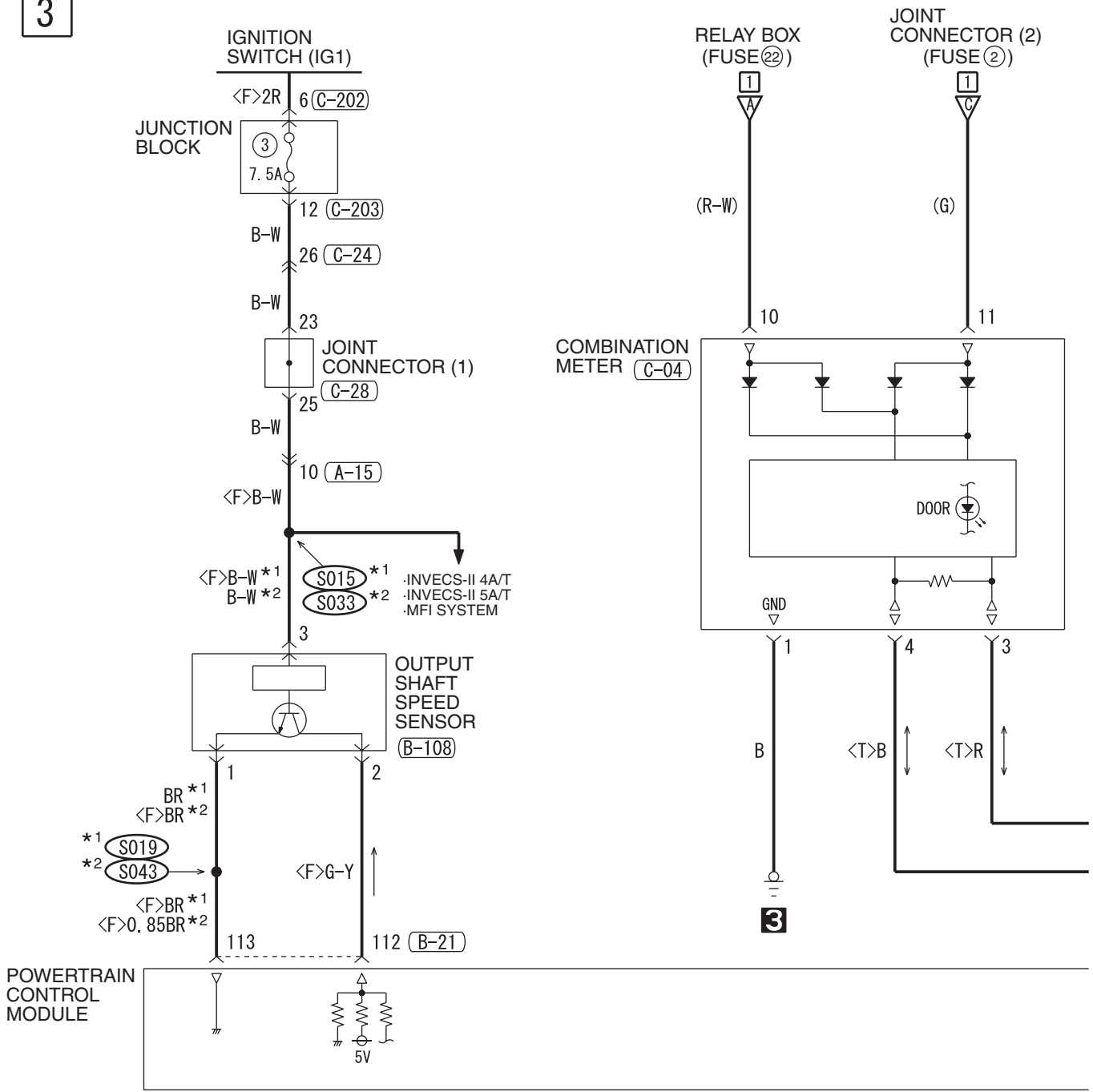

4

NOTE

- *1 : 2.4L ENGINE
- *2 : 3.8L ENGINE
- *3 : WITHOUT TRACTION CONTROL SYSTEM (TCL)
- *4 : WITH TRACTION CONTROL SYSTEM (TCL)

JOINT
CONNECTOR (3) (C-03)

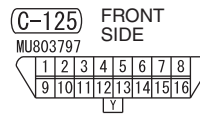
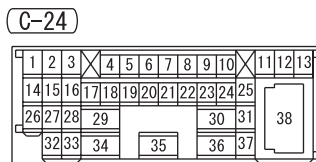
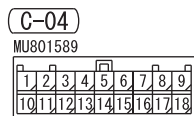
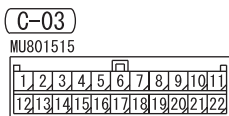
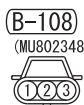
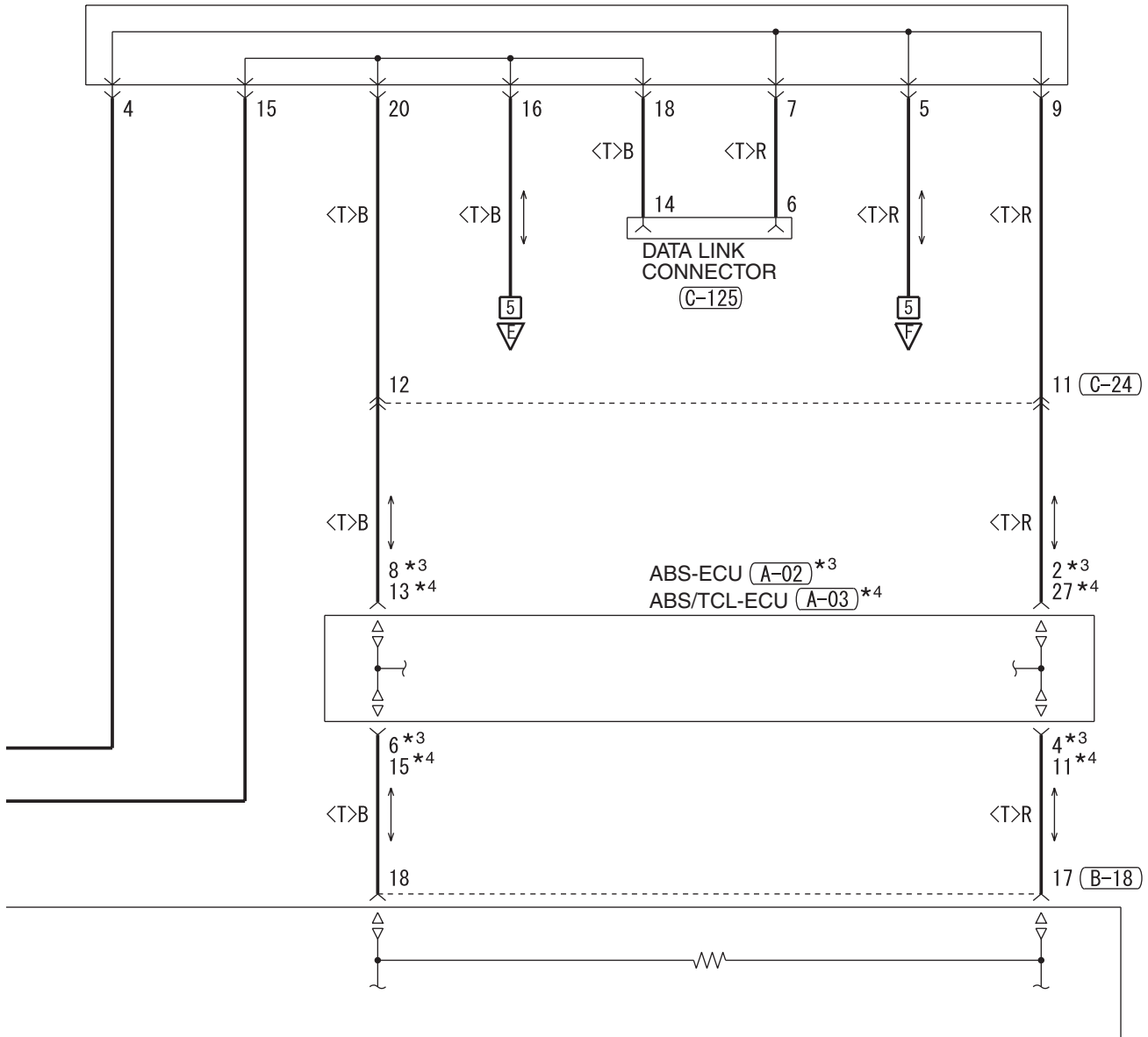

WIRE COLOR CODE

B : BLACK LG : LIGHT GREEN G : GREEN L : BLUE W : WHITE Y : YELLOW SB : SKY BLUE
BR : BROWN O : ORANGE GR : GRAY R : RED P : PINK V : VIOLET PU : PURPLE

H6P15M21BB

DOOR AJAR WARNING TONE ALARM <A/T> (CONTINUED)

5

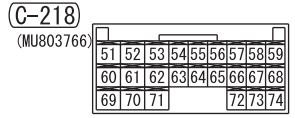
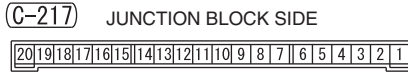
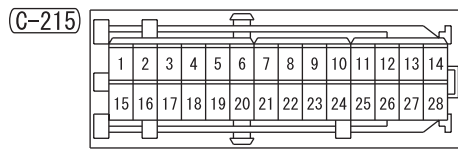
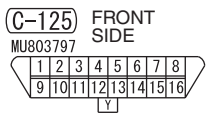
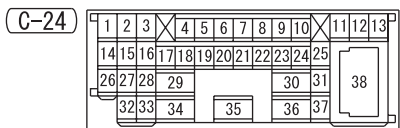
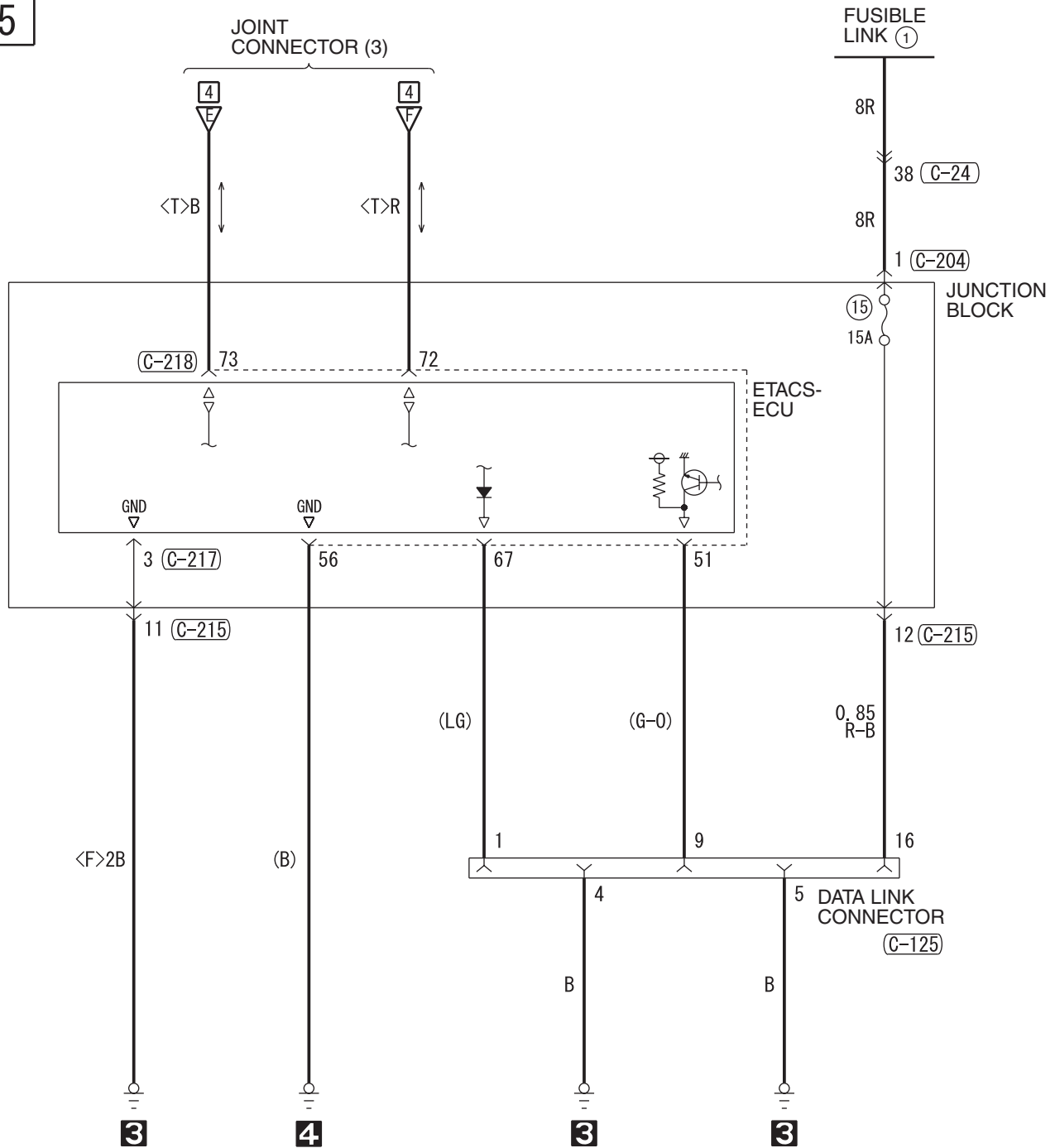

NOTES

CONTROLLER AREA NETWORK (CAN) <2.4L ENGINE-M/T>

M1901004000141

1

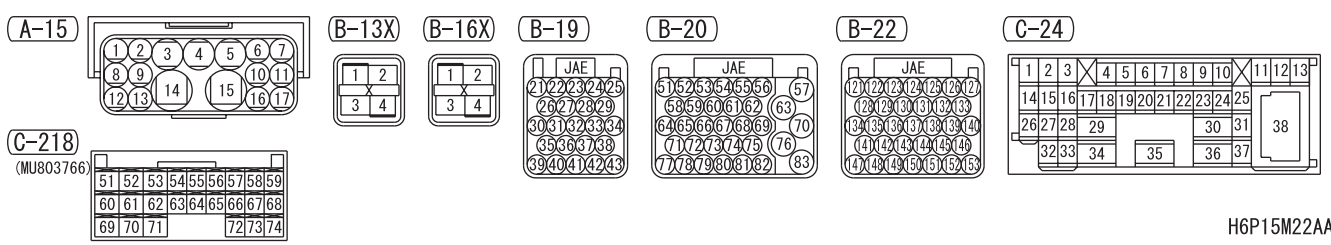
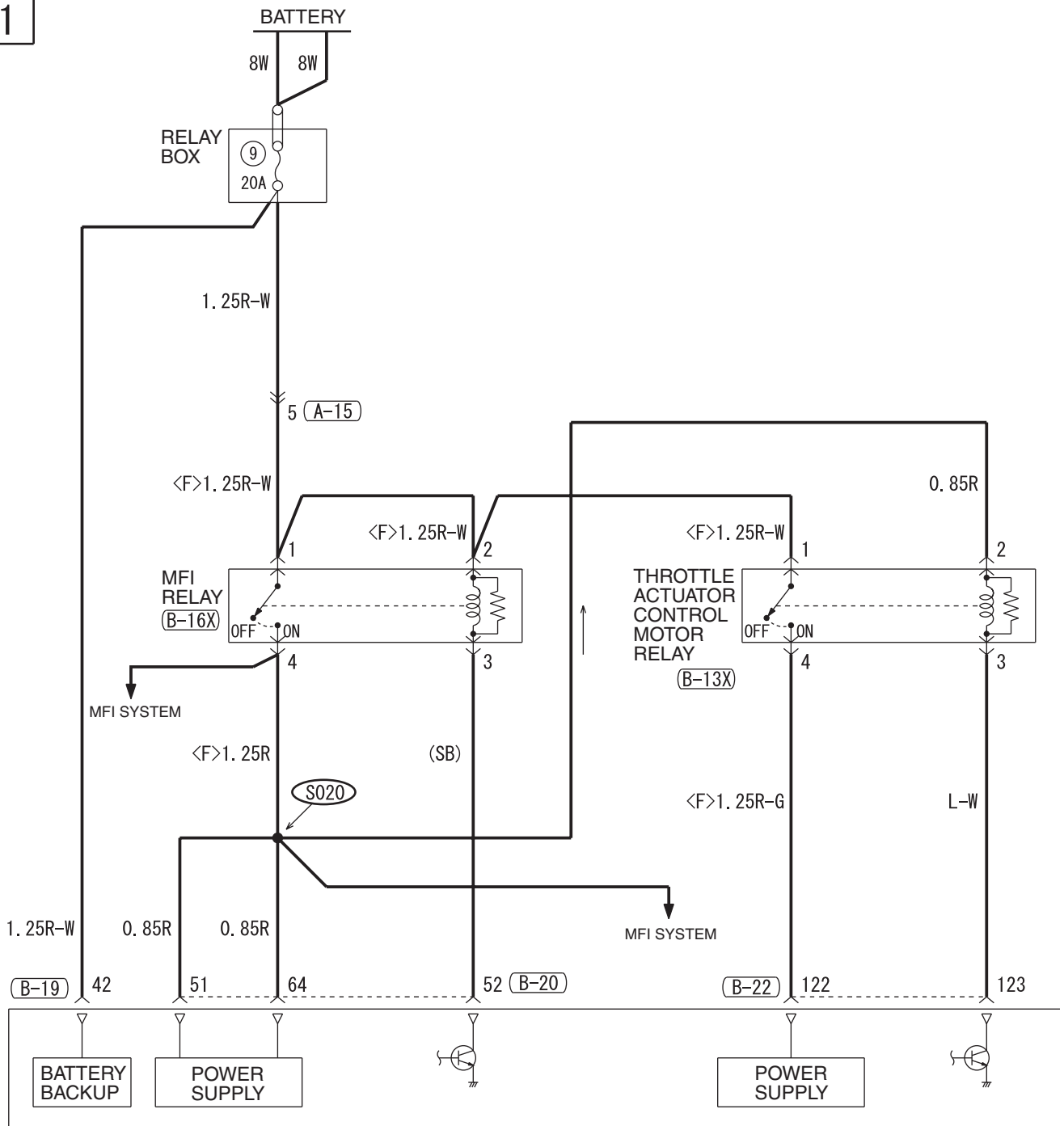

H6P15M22AA

TSB Revision

2

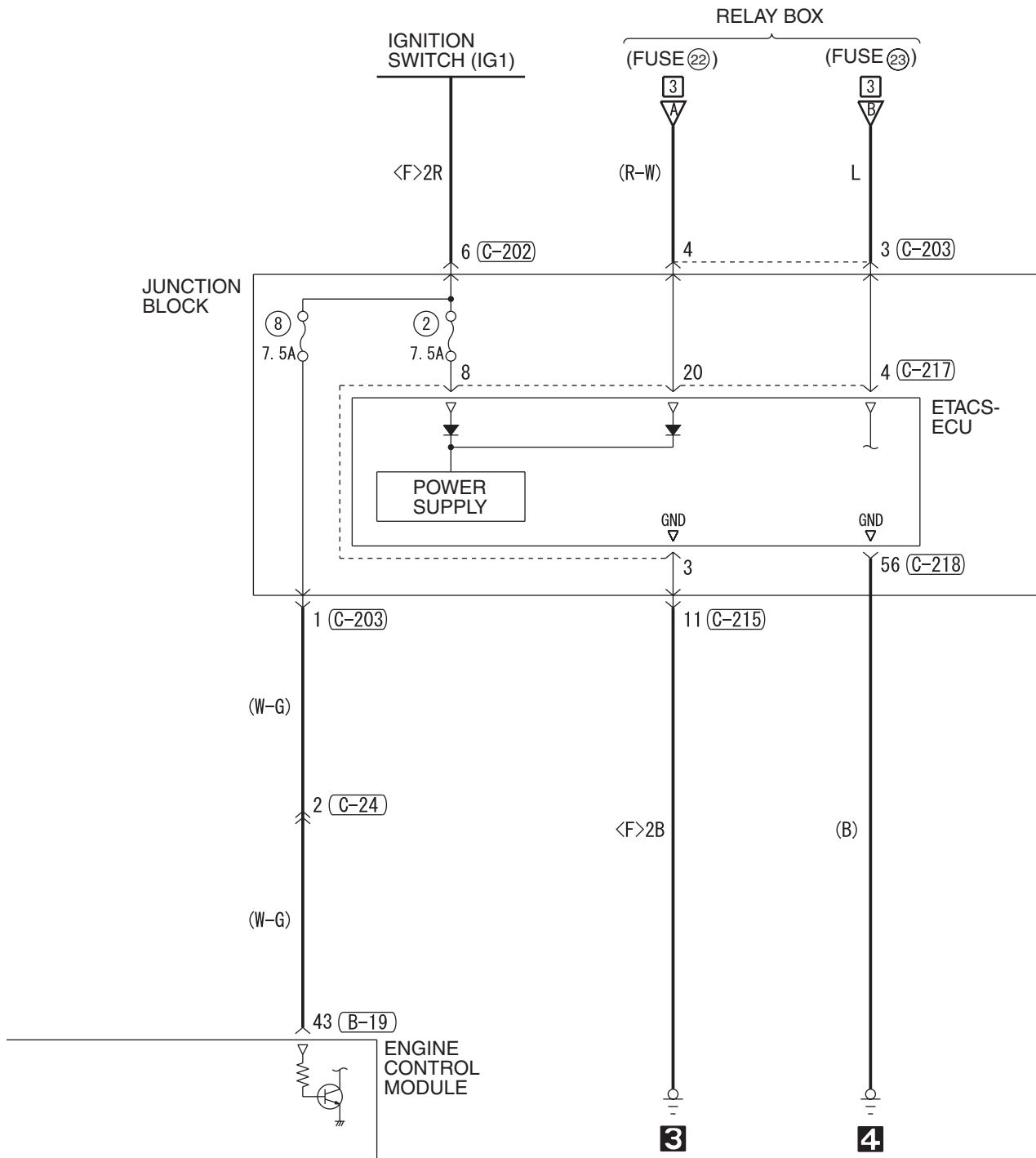

(C-202)



(C-203)

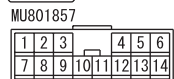

(C-215)

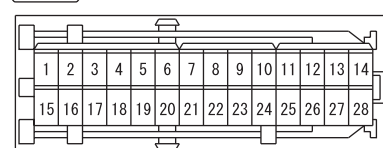

(C-217)

JUNCTION BLOCK SIDE

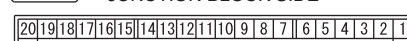

WIRE COLOR CODE

B: BLACK LG: LIGHT GREEN G: GREEN L: BLUE W: WHITE Y: YELLOW SB: SKY BLUE
BR: BROWN O: ORANGE GR: GRAY R: RED P: PINK V: VIOLET PU: PURPLE

H6P15M22AB

TSB Revision

CONTROLLER AREA NETWORK (CAN) <2.4L ENGINE-M/T> (CONTINUED)

3

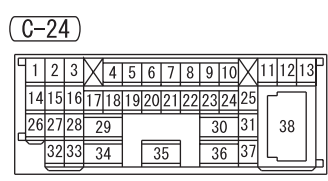
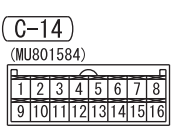
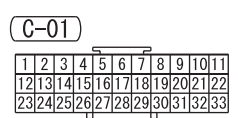
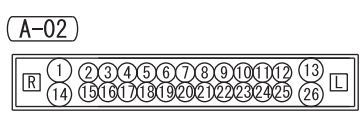
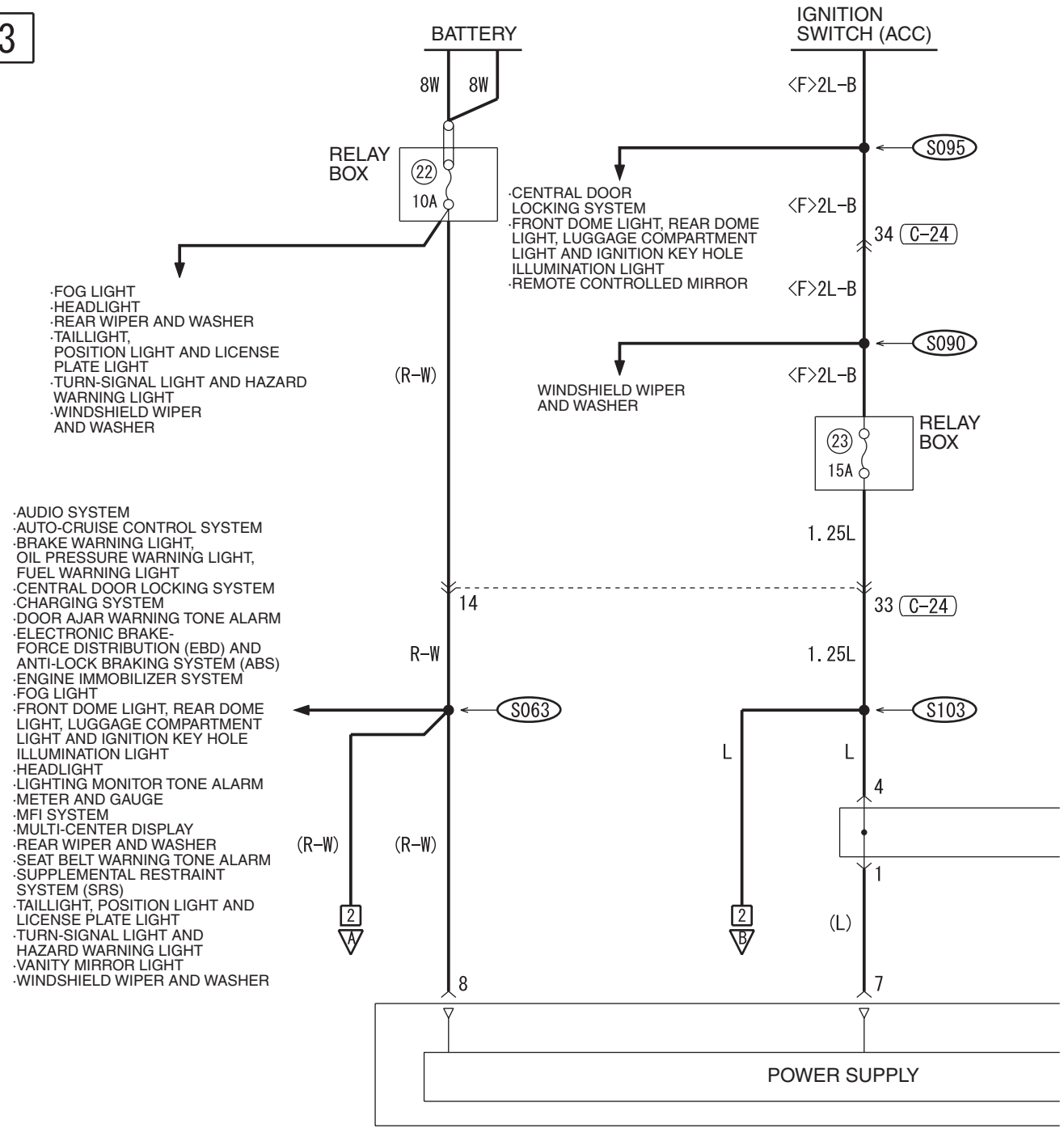

4

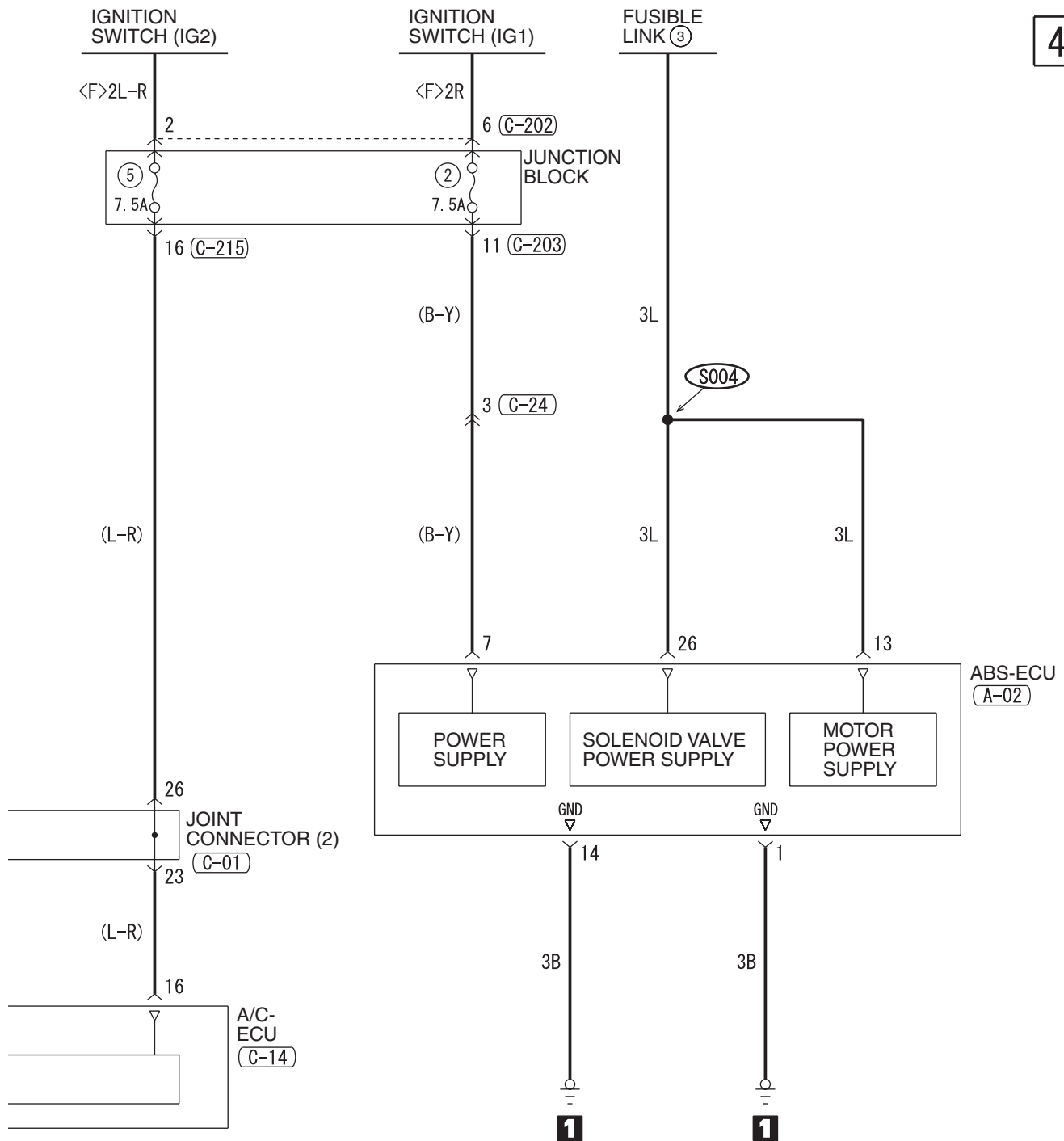

(C-202)



(C-203)

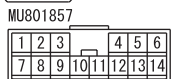

(C-215)

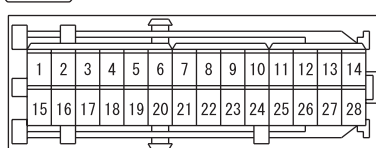

WIRE COLOR CODE
 B : BLACK SB : SKY BLUE
 BR : BROWN LG : LIGHT GREEN
 G : GREEN P : PINK GR : GRAY
 R : RED L : BLUE Y : YELLOW
 V : VIOLET W : WHITE O : ORANGE
 PU : PURPLE

H6P15M22BB

CONTROLLER AREA NETWORK (CAN) <2.4L ENGINE-M/T> (CONTINUED)

5

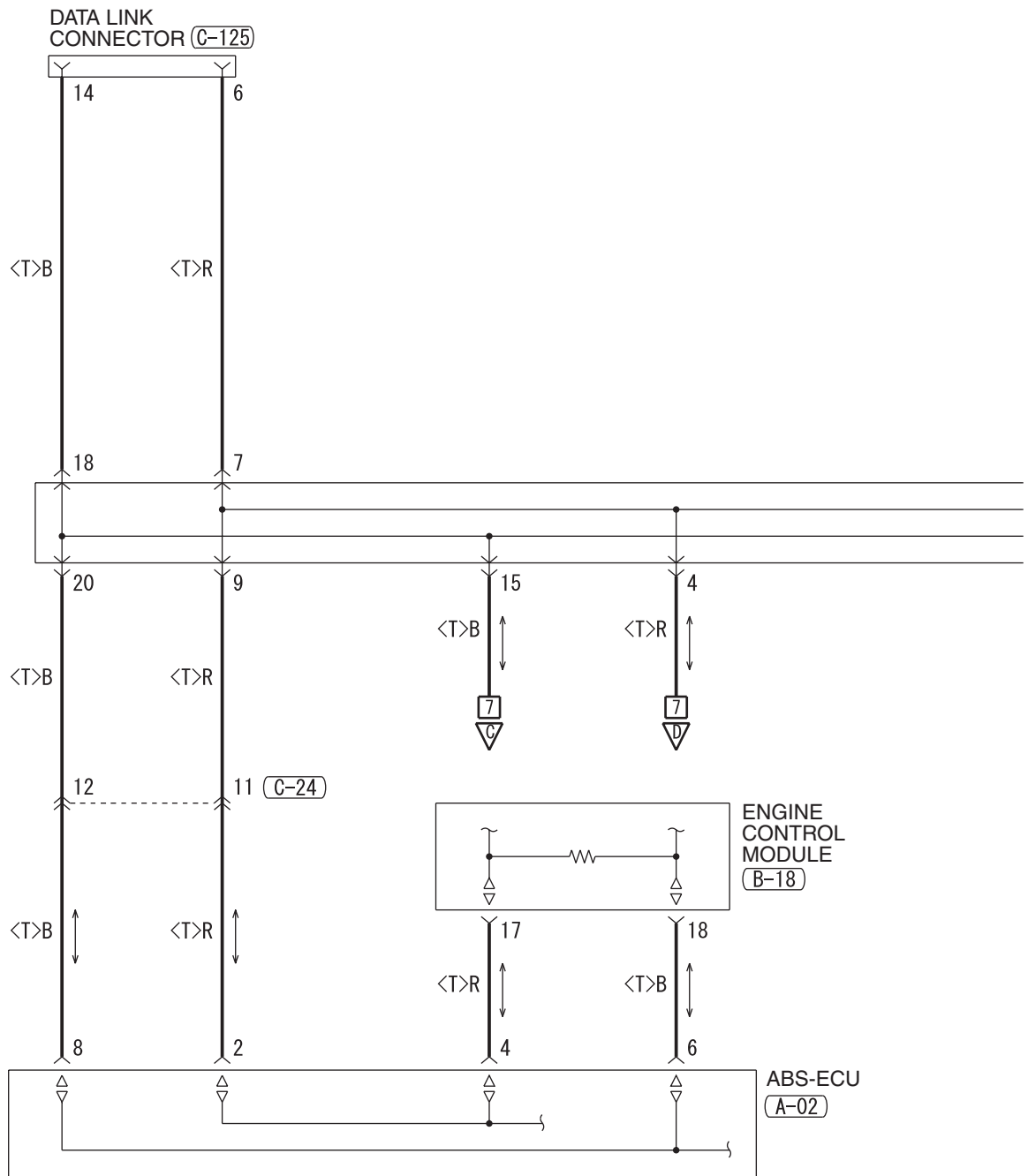

(A-02)

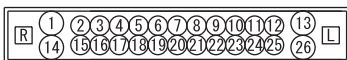

(B-18)



(C-03)

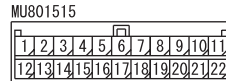

(C-14)

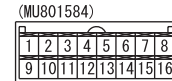

(C-24)

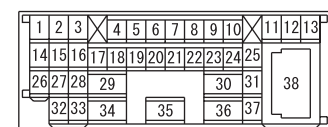

6

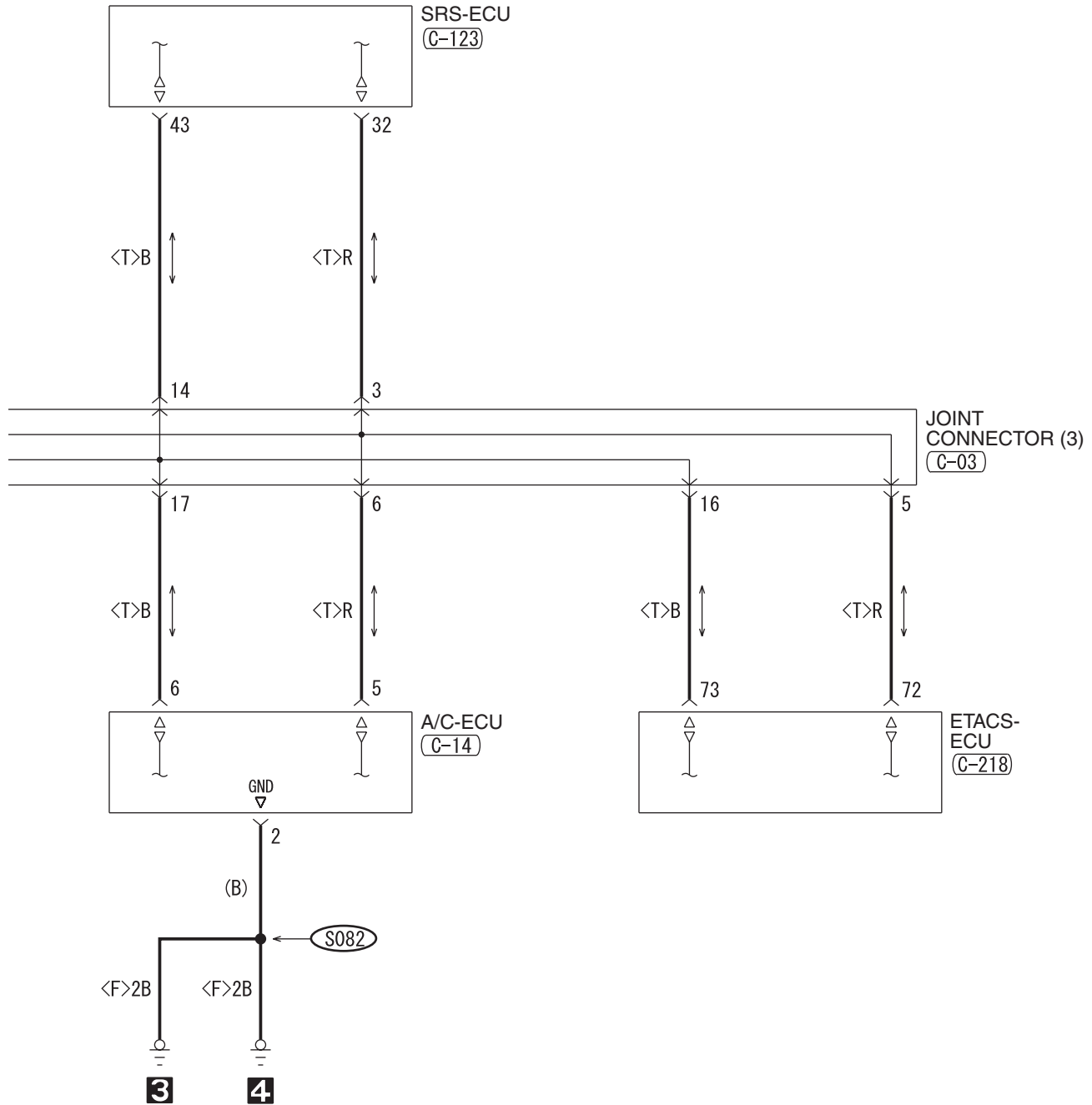

(C-123)

21	22	23	B	A	24	25	26
27	28	29	30	31	32	33	34
35	36	37					
38	39	40	41	42	43	44	45
46	47	48					

(C-125) FRONT SIDE

1	2	3	4	5	6	7	8
9	10	11	12	13	14	15	16

(C-218)

51	52	53	54	55	56	57	58	59
60	61	62	63	64	65	66	67	68
69	70	71				72	73	74

WIRE COLOR CODE

B: BLACK LG: LIGHT GREEN G: GREEN L: BLUE W: WHITE Y: YELLOW SB: SKY BLUE
 BR: BROWN O: ORANGE GR: GRAY R: RED P: PINK V: VIOLET PU: PURPLE

H6P15M22CB

TSB Revision

CONTROLLER AREA NETWORK (CAN) <2.4L ENGINE-M/T> (CONTINUED)

7

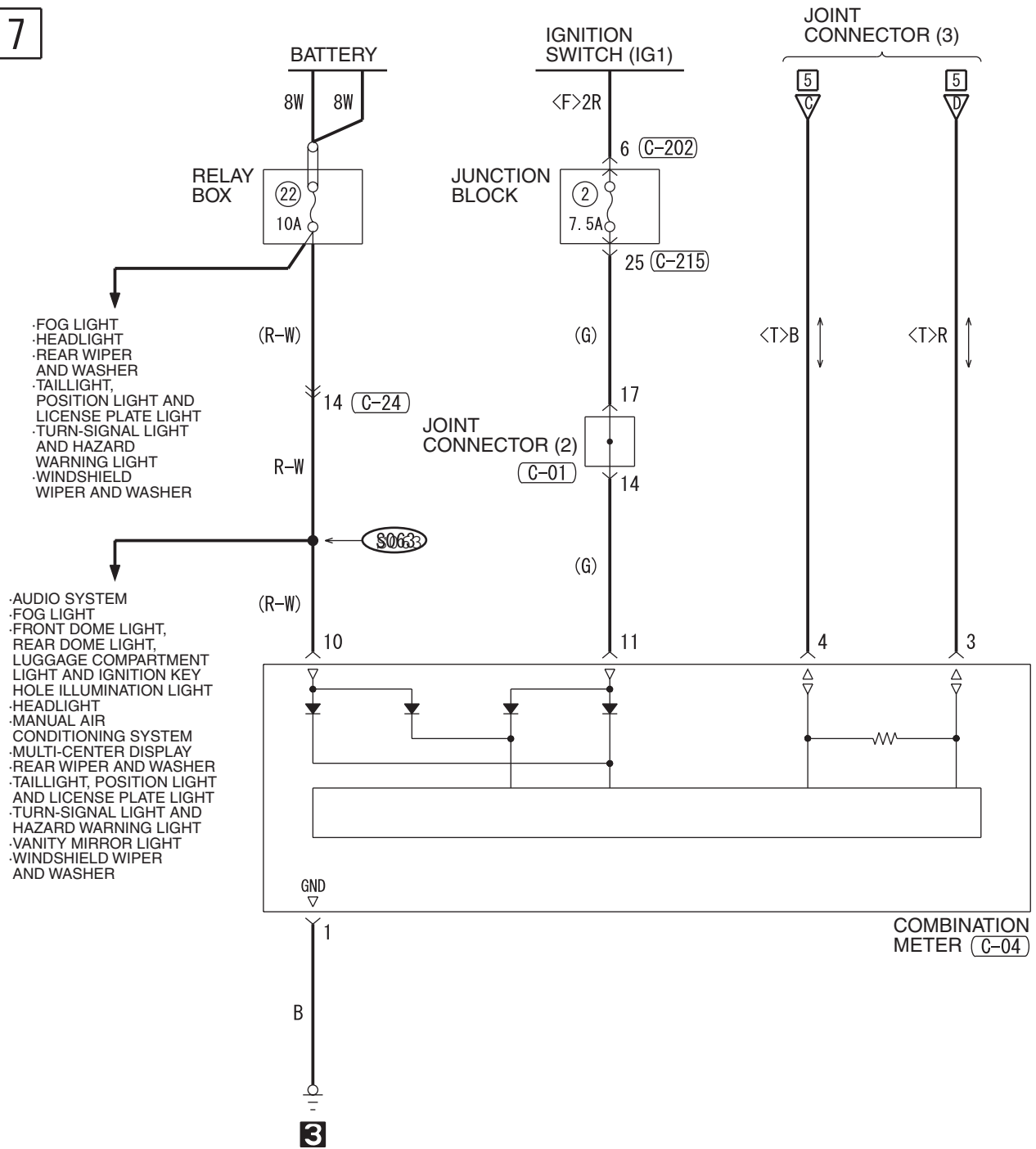

B-19



C-01

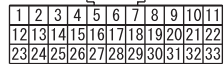

C-04

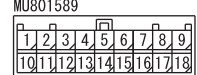

C-24

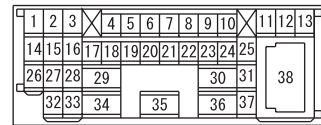

C-202



8

ENGINE
 CONTROL MODULE
 (B-19)

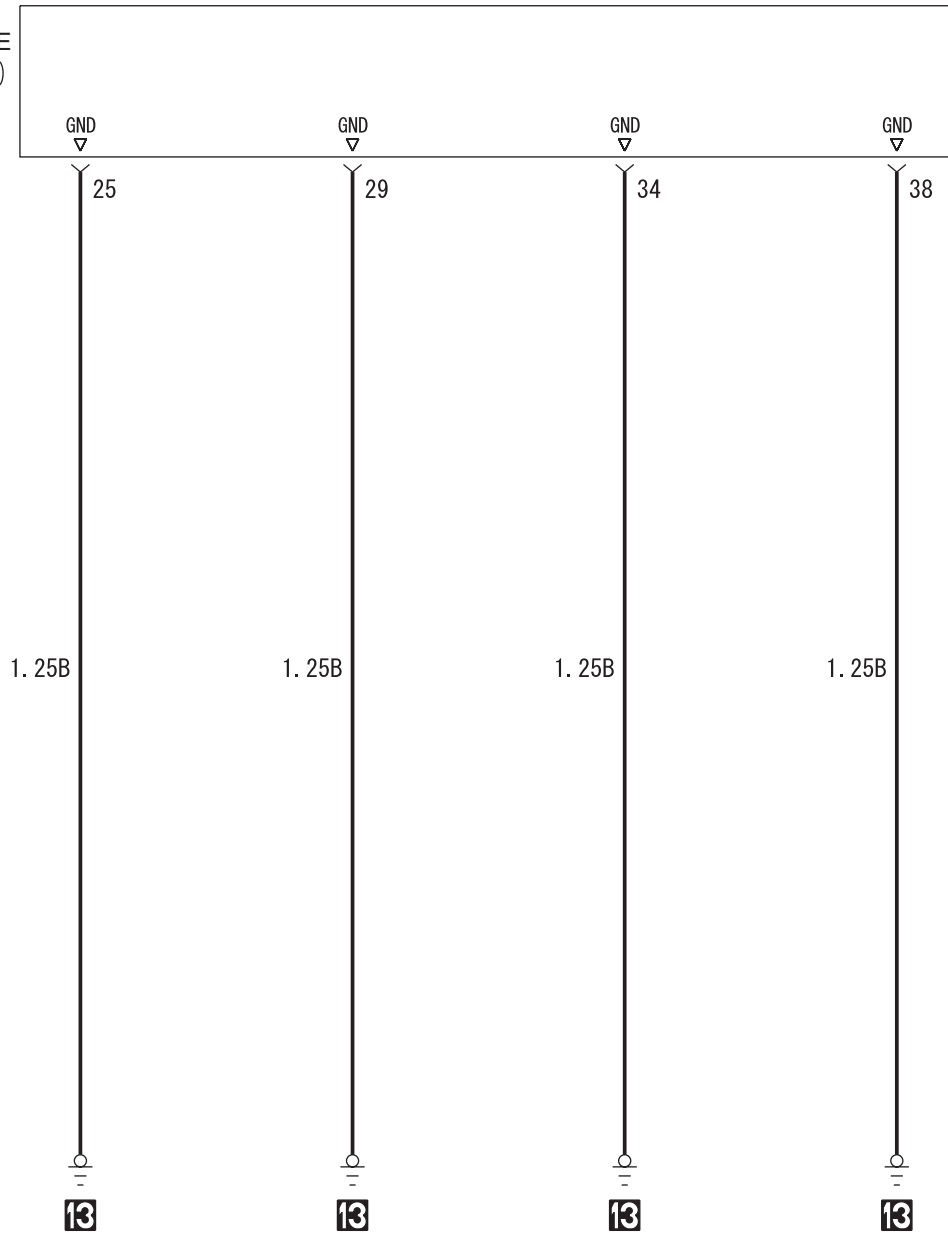

(C-215)

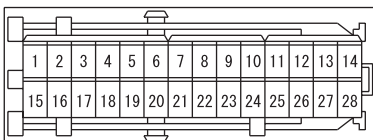

WIRE COLOR CODE
 B : BLACK LG : LIGHT GREEN G : GREEN L : BLUE
 BR : BROWN O : ORANGE GR : GRAY R : RED W : WHITE
 SB : SKY BLUE P : PINK Y : YELLOW V : VIOLET PU : PURPLE

H6P15M22DB

TSB Revision

CONTROLLER AREA NETWORK (CAN) <2.4L ENGINE-A/T>

M1901004000152

1

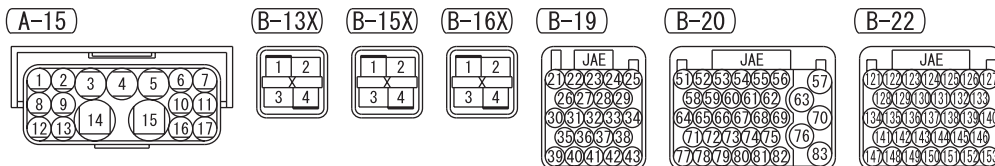
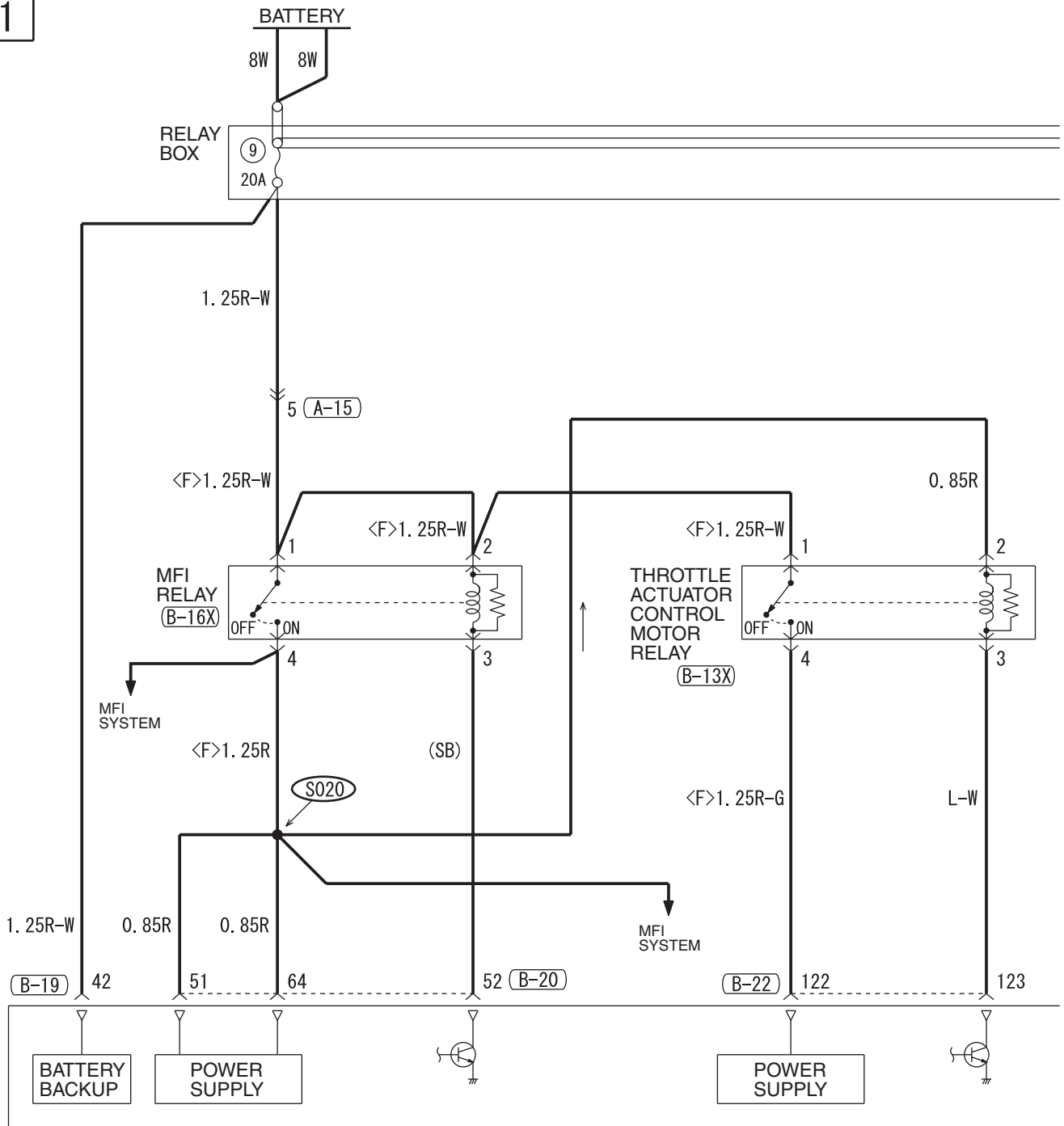

H6P15M23AA

TSB Revision

2

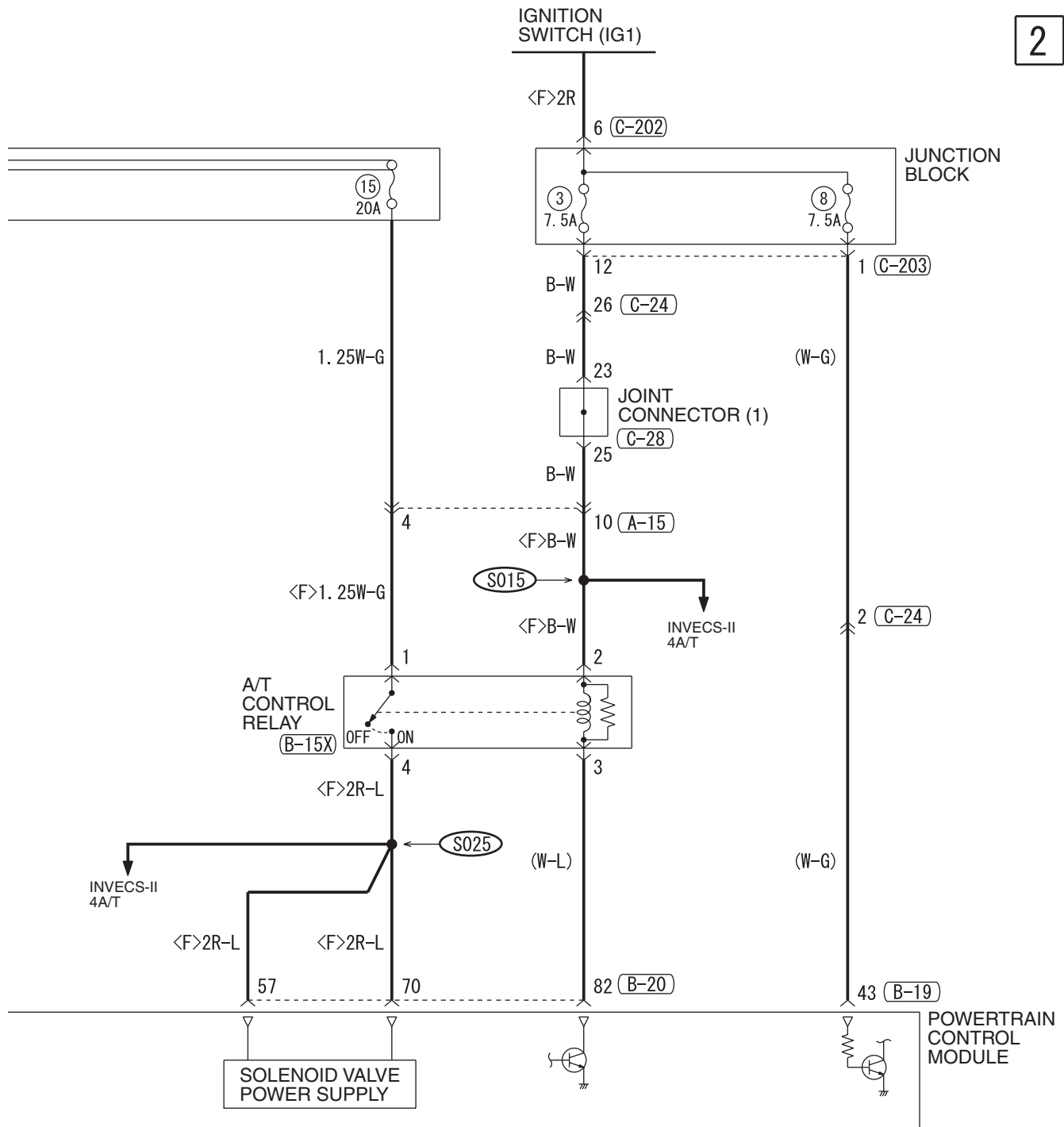

(C-24)

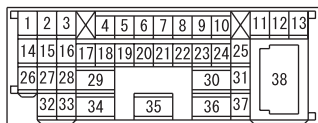

(C-28)



(C-202)



(C-203)

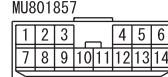

WIRE COLOR CODE

B : BLACK LG : LIGHT GREEN G : GREEN L : BLUE
 BR : BROWN O : ORANGE GR : GRAY R : RED W : WHITE
 SB : SKY BLUE P : PINK Y : YELLOW V : VIOLET PU : PURPLE

H6P15M23AB

TSB Revision

CONTROLLER AREA NETWORK (CAN) <2.4L ENGINE-A/T> (CONTINUED)

3

POWERTRAIN CONTROL MODULE

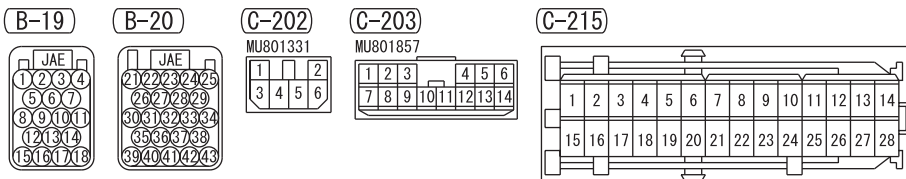
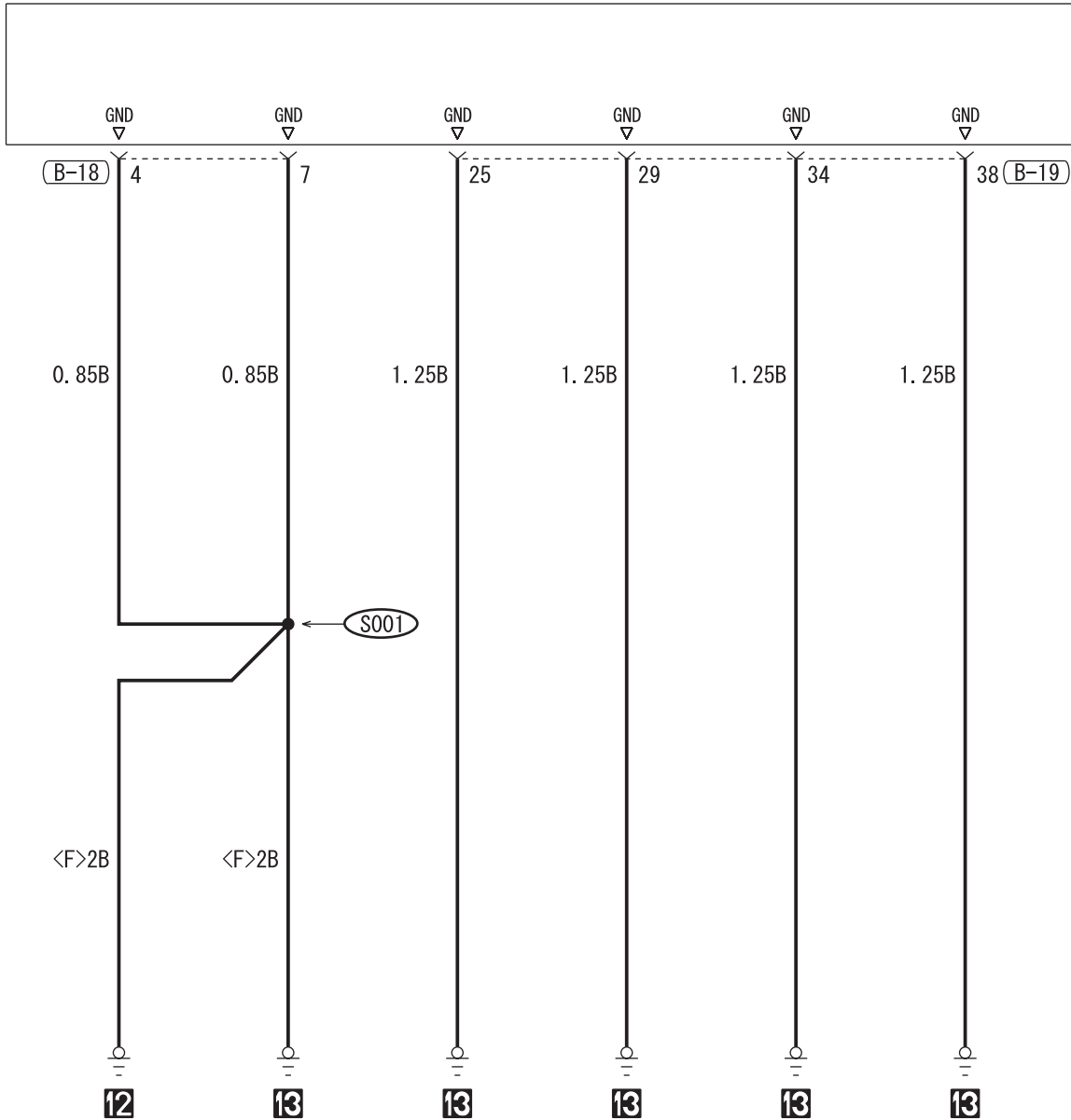

4

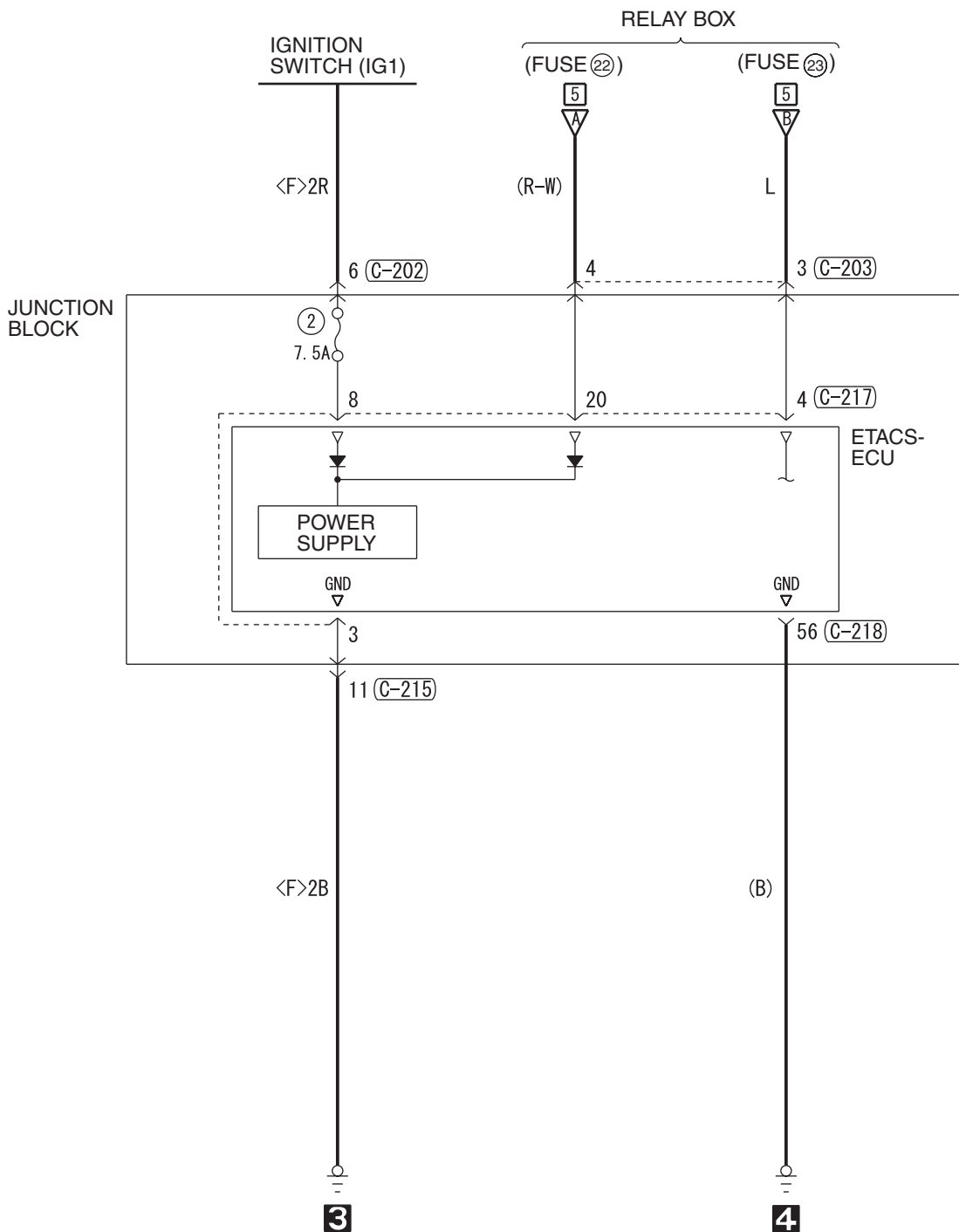

(C-217) JUNCTION BLOCK SIDE

20	19	18	17	16	15	14	13	12	11	10	9	8	7	6	5	4	3	2	1
----	----	----	----	----	----	----	----	----	----	----	---	---	---	---	---	---	---	---	---

(C-218) (MU803766)

51	52	53	54	55	56	57	58	59
60	61	62	63	64	65	66	67	68
69	70	71	72	73	74			

WIRE COLOR CODE
 B: BLACK LG: LIGHT GREEN G: GREEN L: BLUE W: WHITE Y: YELLOW SB: SKY BLUE
 BR: BROWN O: ORANGE GR: GRAY R: RED P: PINK V: VIOLET PU: PURPLE

CONTROLLER AREA NETWORK (CAN) <2.4L ENGINE-A/T> (CONTINUED)

5

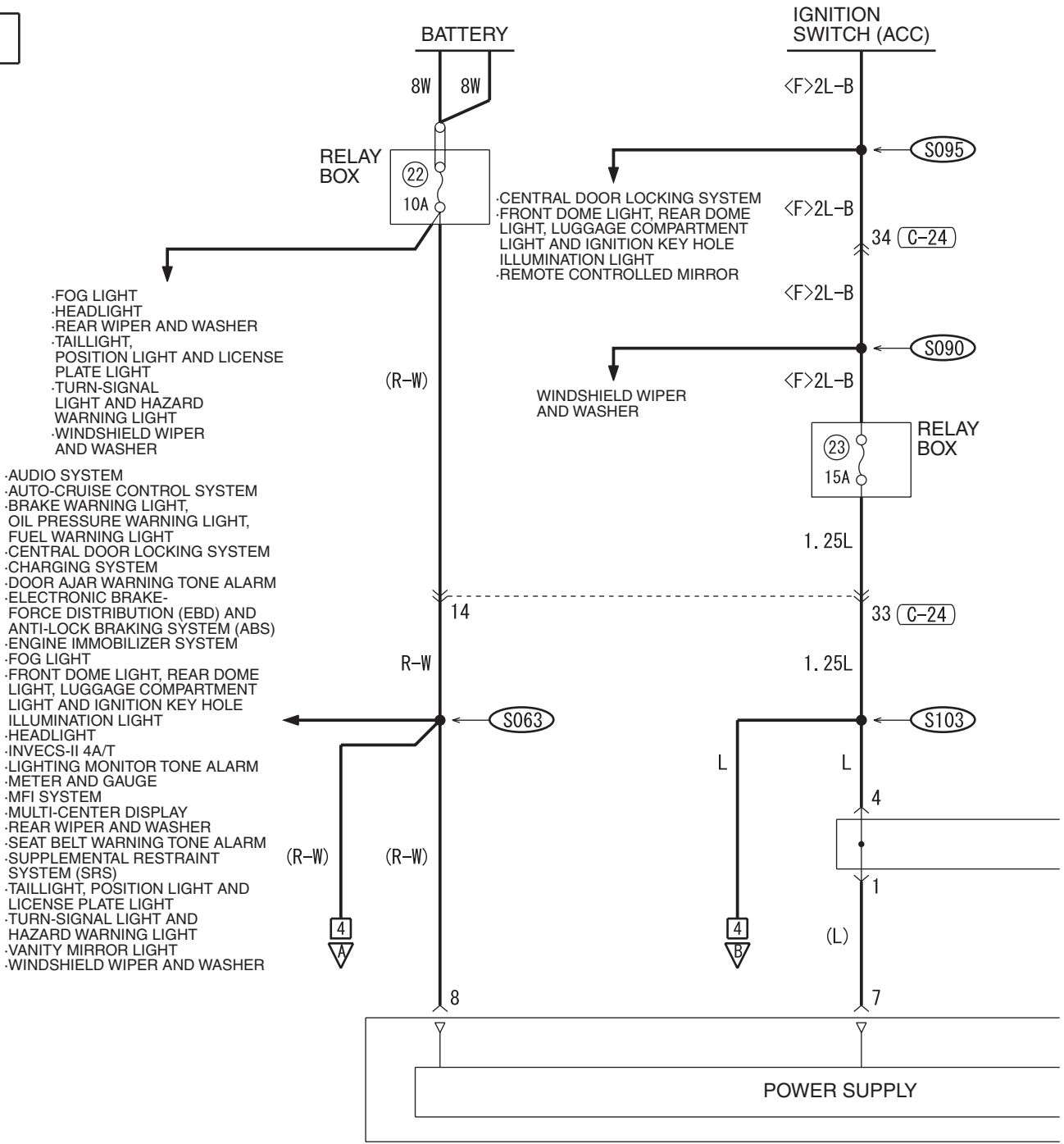

- .FOG LIGHT
- .HEADLIGHT
- .REAR WIPER AND WASHER
- .TAILLIGHT, POSITION LIGHT AND LICENSE PLATE LIGHT
- .TURN-SIGNAL LIGHT AND HAZARD WARNING LIGHT
- .WINDSHIELD WIPER AND WASHER
- .AUDIO SYSTEM
- .AUTO-CRUISE CONTROL SYSTEM
- .BRAKE WARNING LIGHT, OIL PRESSURE WARNING LIGHT, FUEL WARNING LIGHT
- .CENTRAL DOOR LOCKING SYSTEM
- .CHARGING SYSTEM
- .DOOR AJAR WARNING TONE ALARM
- .ELECTRONIC BRAKE-FORCE DISTRIBUTION (EBD) AND ANTI-LOCK BRAKING SYSTEM (ABS)
- .ENGINE IMMOBILIZER SYSTEM
- .FOG LIGHT
- .FRONT DOME LIGHT, REAR DOME LIGHT, LUGGAGE COMPARTMENT LIGHT AND IGNITION KEY HOLE ILLUMINATION LIGHT
- .HEADLIGHT
- .INVECS-II 4A/T
- .LIGHTING MONITOR TONE ALARM
- .METER AND GAUGE
- .MFI SYSTEM
- .MULTI-CENTER DISPLAY
- .REAR WIPER AND WASHER
- .SEAT BELT WARNING TONE ALARM
- .SUPPLEMENTAL RESTRAINT SYSTEM (SRS)
- .TAILLIGHT, POSITION LIGHT AND LICENSE PLATE LIGHT
- .TURN-SIGNAL LIGHT AND HAZARD WARNING LIGHT
- .VANITY MIRROR LIGHT
- .WINDSHIELD WIPER AND WASHER

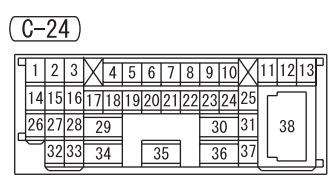
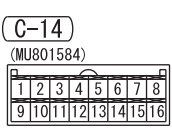
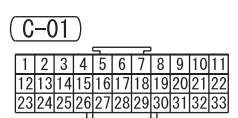
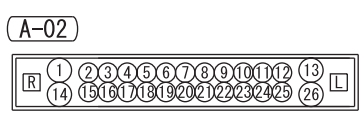

6

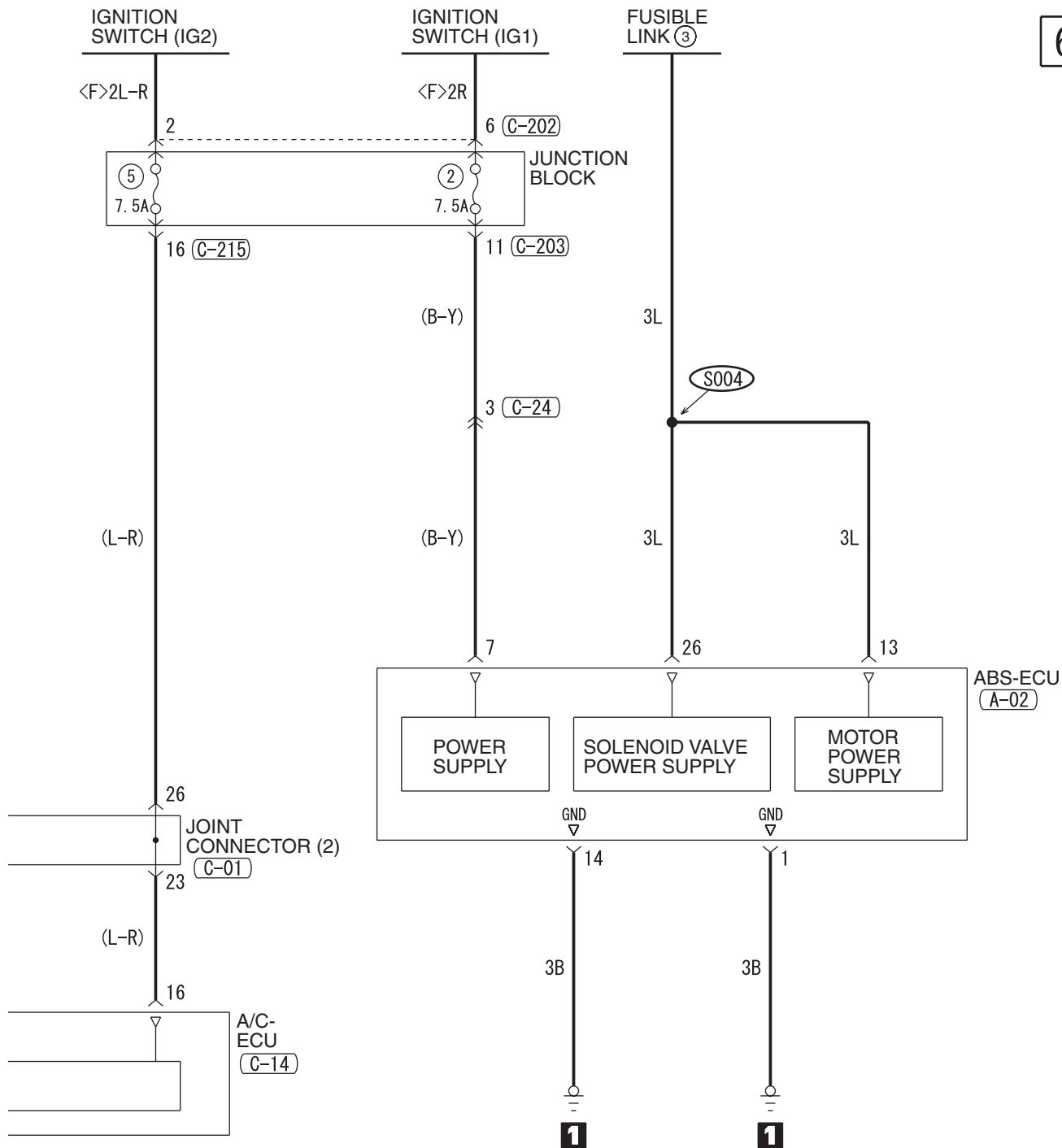

(C-202)



(C-203)

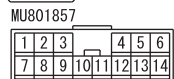

(C-215)

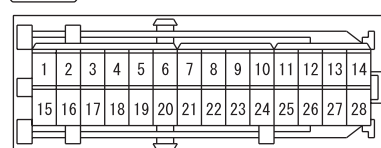

WIRE COLOR CODE

B : BLACK LG : LIGHT GREEN G : GREEN L : BLUE W : WHITE Y : YELLOW SB : SKY BLUE
BR : BROWN O : ORANGE GR : GRAY R : RED P : PINK V : VIOLET PU : PURPLE

H6P15M23CB

CONTROLLER AREA NETWORK (CAN) <2.4L ENGINE-A/T> (CONTINUED)

7

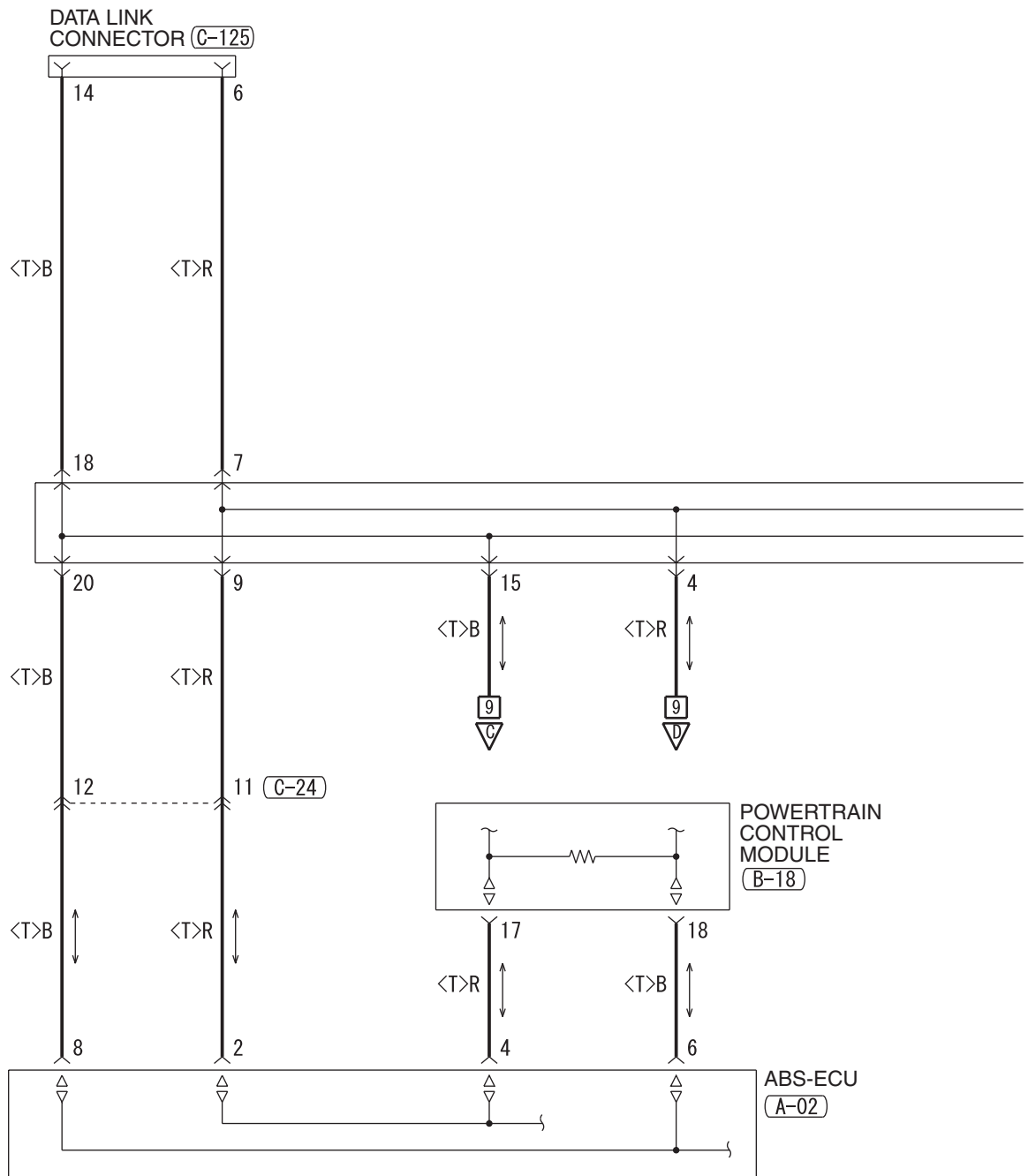

(A-02)

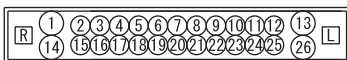

(B-18)



(C-03)

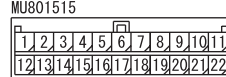

(C-14)

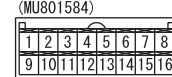

(C-24)

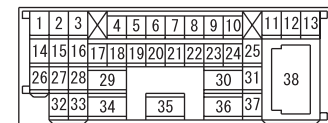

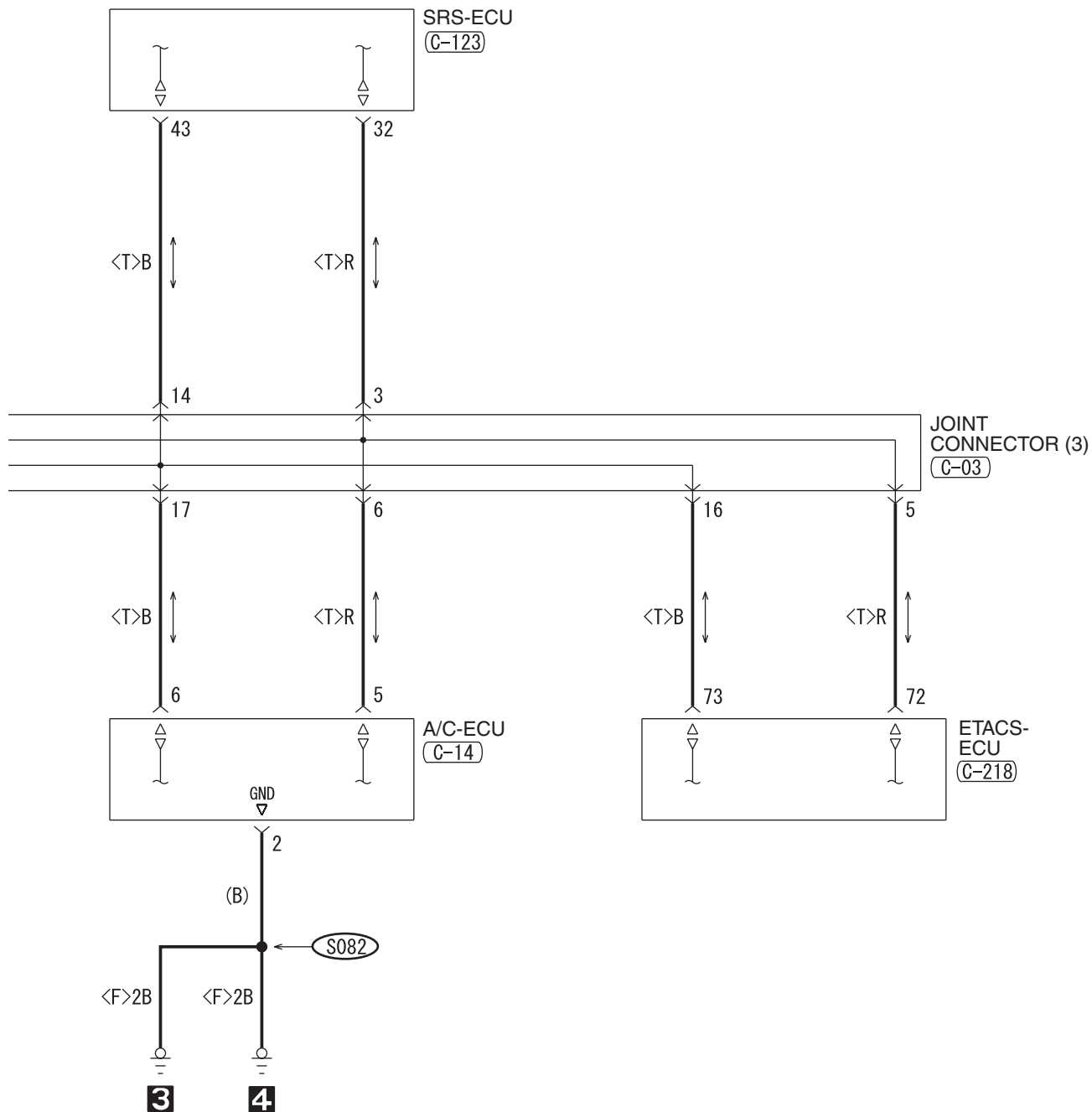

(C-123)

21	22	23	B	A	24	25	26
27	28	29	30	31	32	33	34
35	36	37					
38	39	40	41	42	43	44	45
46	47	48					

(C-125) FRONT SIDE

1	2	3	4	5	6	7	8
9	10	11	12	13	14	15	16

(C-218)

51	52	53	54	55	56	57	58	59
60	61	62	63	64	65	66	67	68
69	70	71				72	73	74

WIRE COLOR CODE

B: BLACK LG: LIGHT GREEN G: GREEN L: BLUE W: WHITE Y: YELLOW SB: SKY BLUE
 BR: BROWN O: ORANGE GR: GRAY R: RED P: PINK V: VIOLET PU: PURPLE

H6P15M23DB

CONTROLLER AREA NETWORK (CAN) <2.4L ENGINE-A/T> (CONTINUED)

9

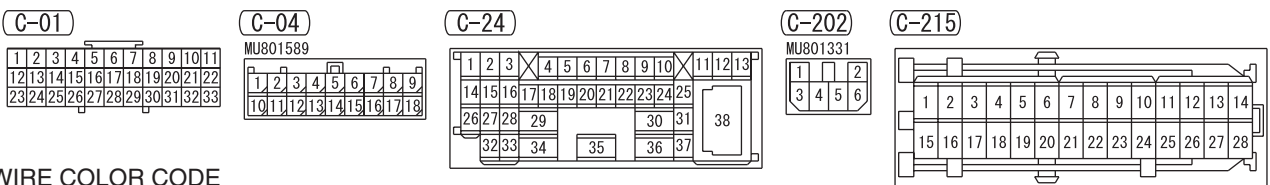
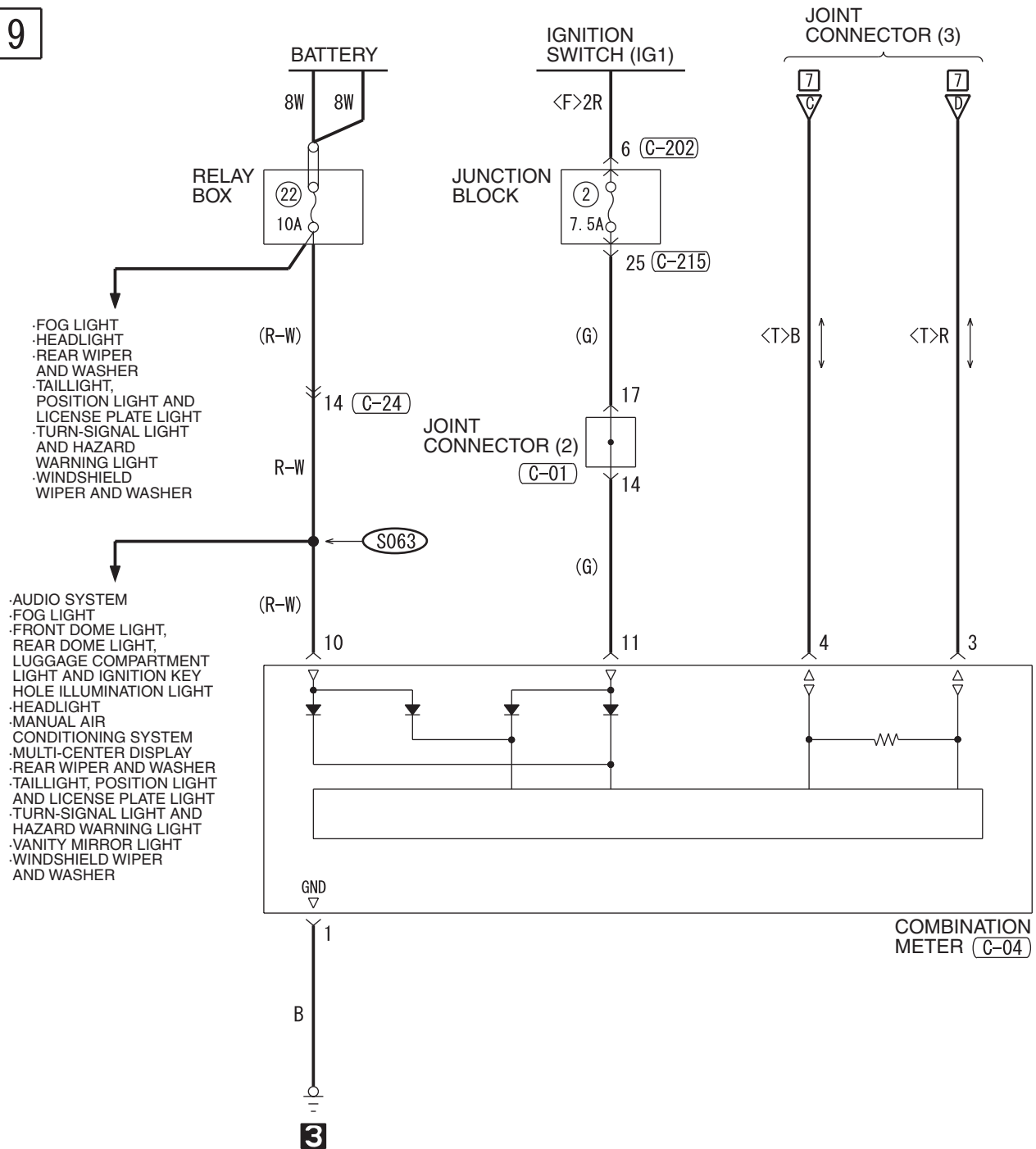

WIRE COLOR CODE

B : BLACK LG : LIGHT GREEN G : GREEN L : BLUE W : WHITE Y : YELLOW SB : SKY BLUE
BR : BROWN O : ORANGE GR : GRAY R : RED P : PINK V : VIOLET PU : PURPLE

H6P15M23EA

NOTES

CONTROLLER AREA NETWORK (CAN) <3.8L ENGINE-M/T>

M1901004000163

1

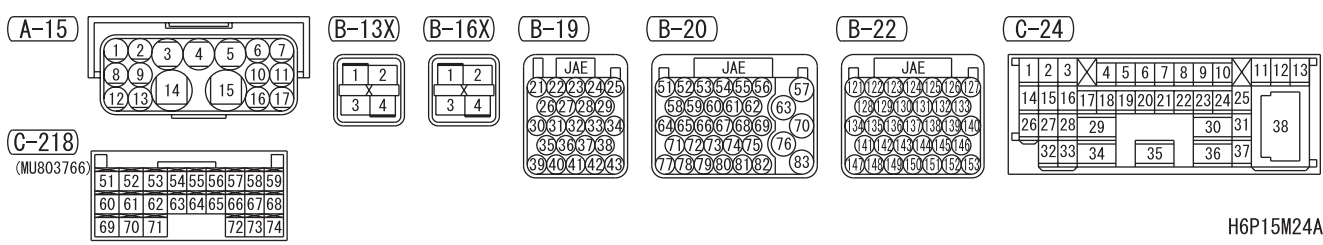
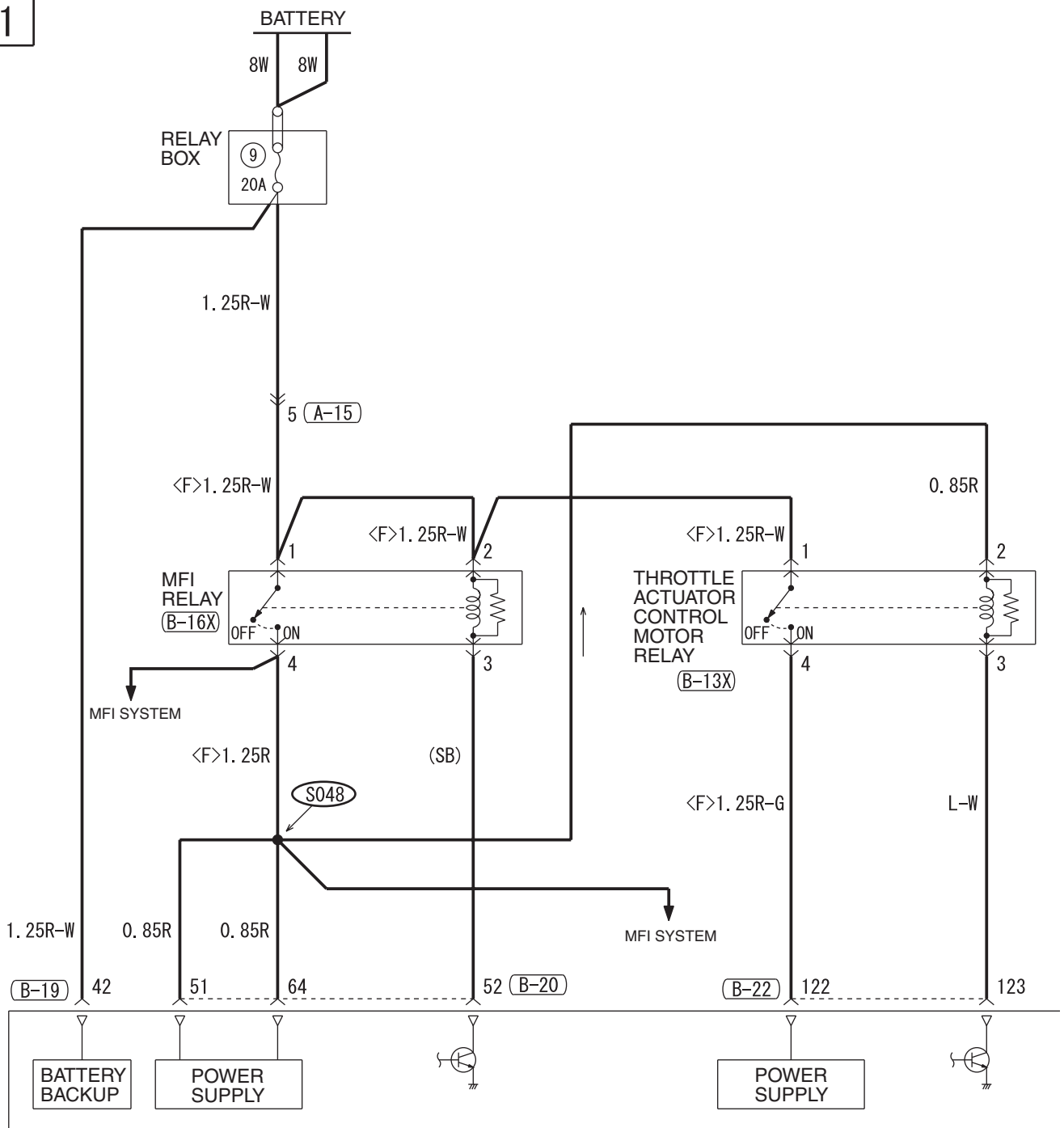

H6P15M24AA

TSB Revision

2

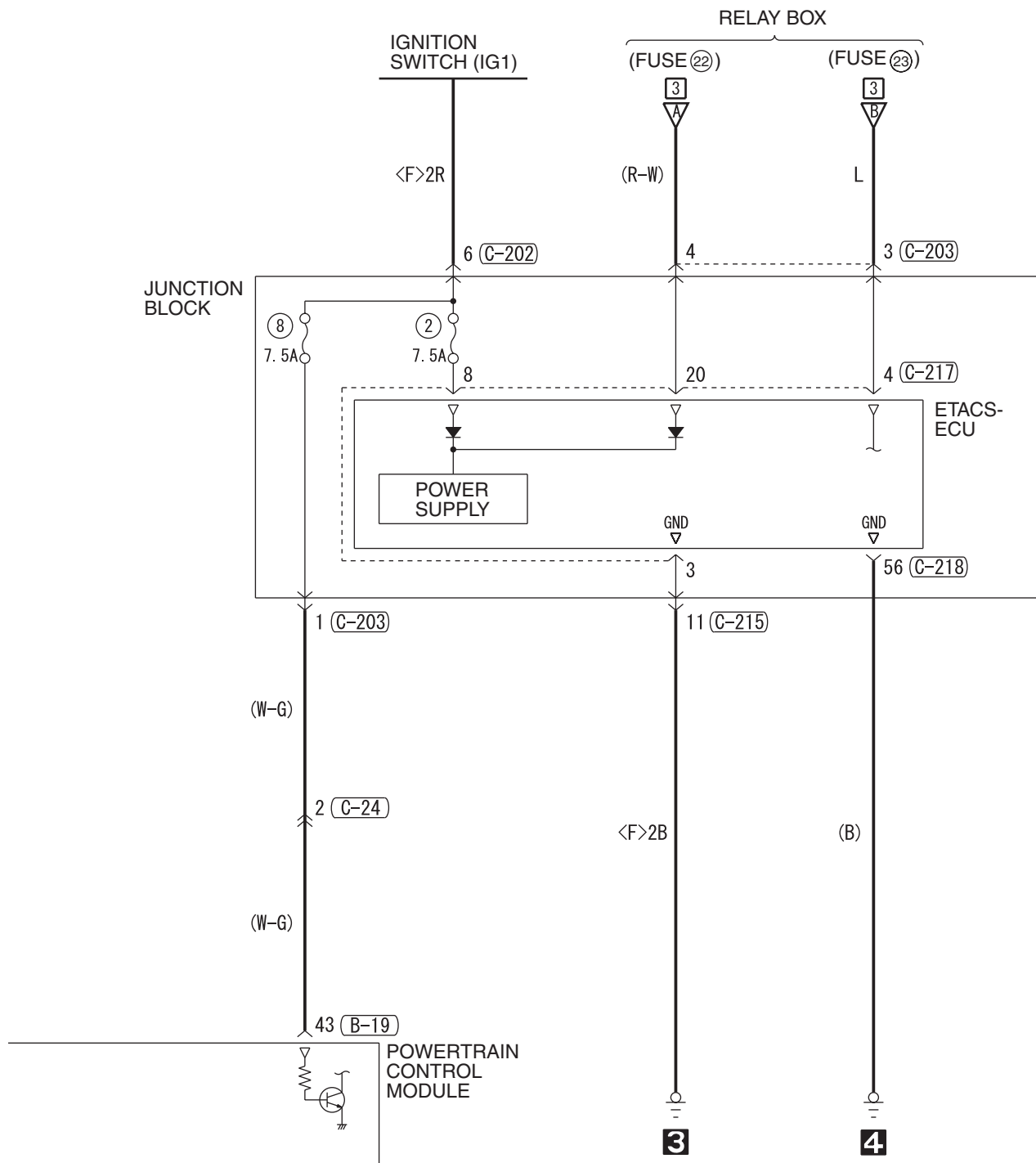

(C-202)



(C-203)

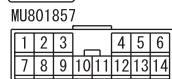

(C-215)

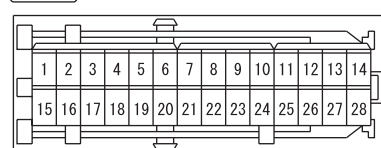

(C-217)

JUNCTION BLOCK SIDE

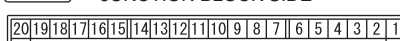

WIRE COLOR CODE

B: BLACK LG: LIGHT GREEN G: GREEN L: BLUE W: WHITE Y: YELLOW SB: SKY BLUE
 BR: BROWN O: ORANGE GR: GRAY R: RED P: PINK V: VIOLET PU: PURPLE

H6P15M24AB

CONTROLLER AREA NETWORK (CAN) <3.8L ENGINE-M/T> (CONTINUED)

3

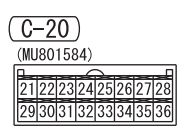
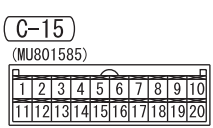
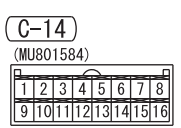
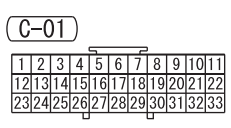
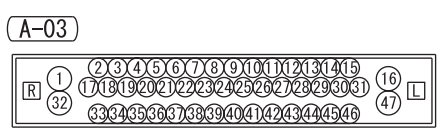
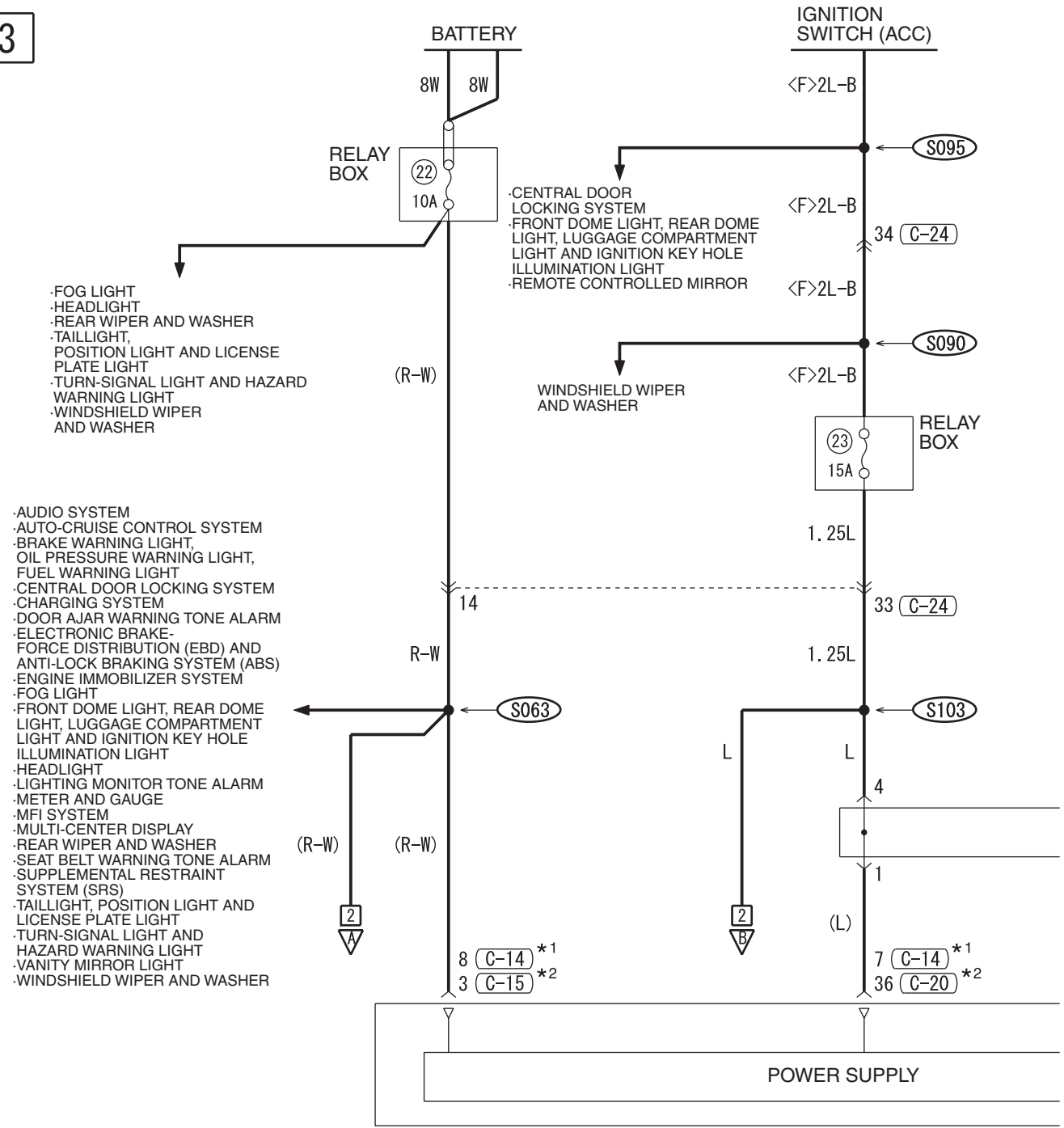

4

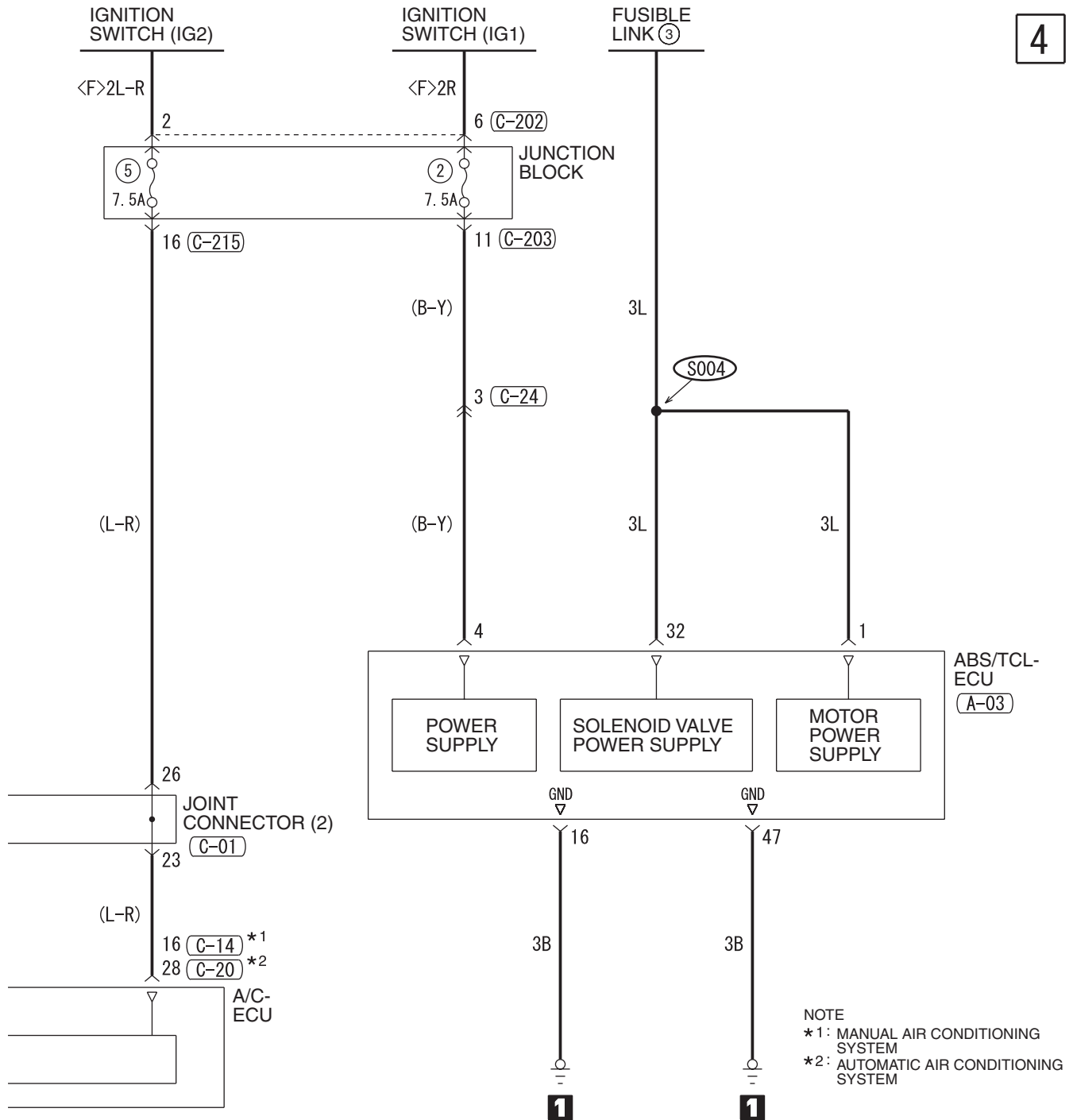

(C-24)

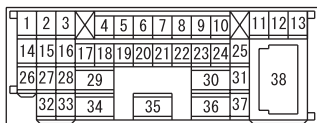

(C-202)



(C-203)

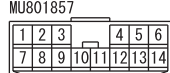

(C-215)

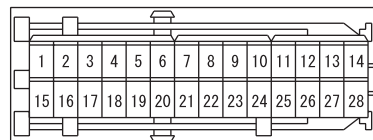

CONTROLLER AREA NETWORK (CAN) <3.8L ENGINE-M/T> (CONTINUED)

5

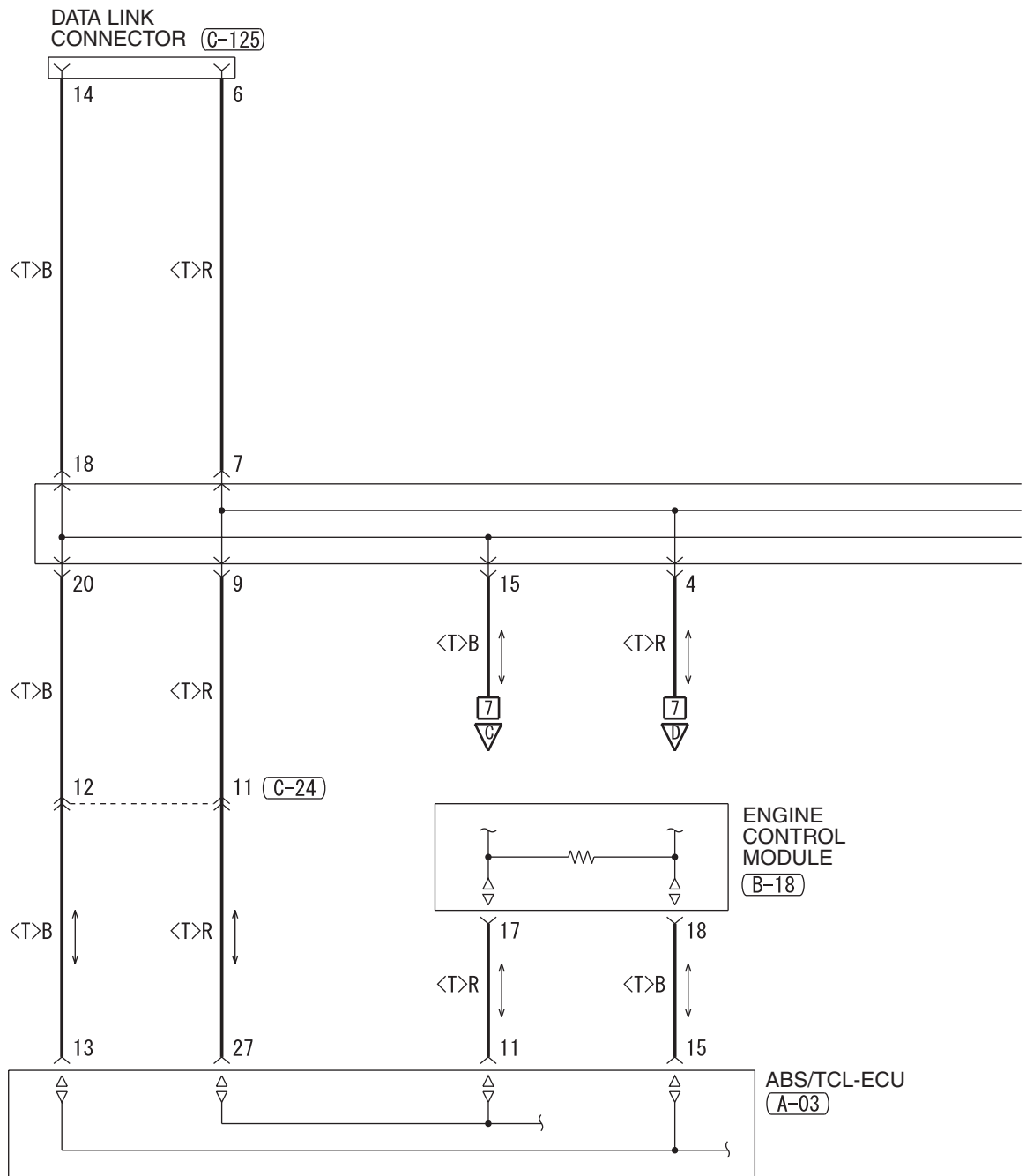

(A-03)

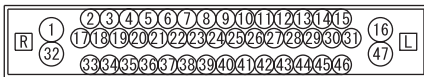

(B-18)

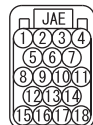

(C-03)

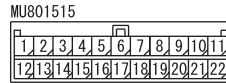

(C-14)

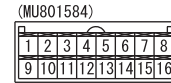

(C-15)

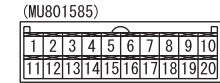

6

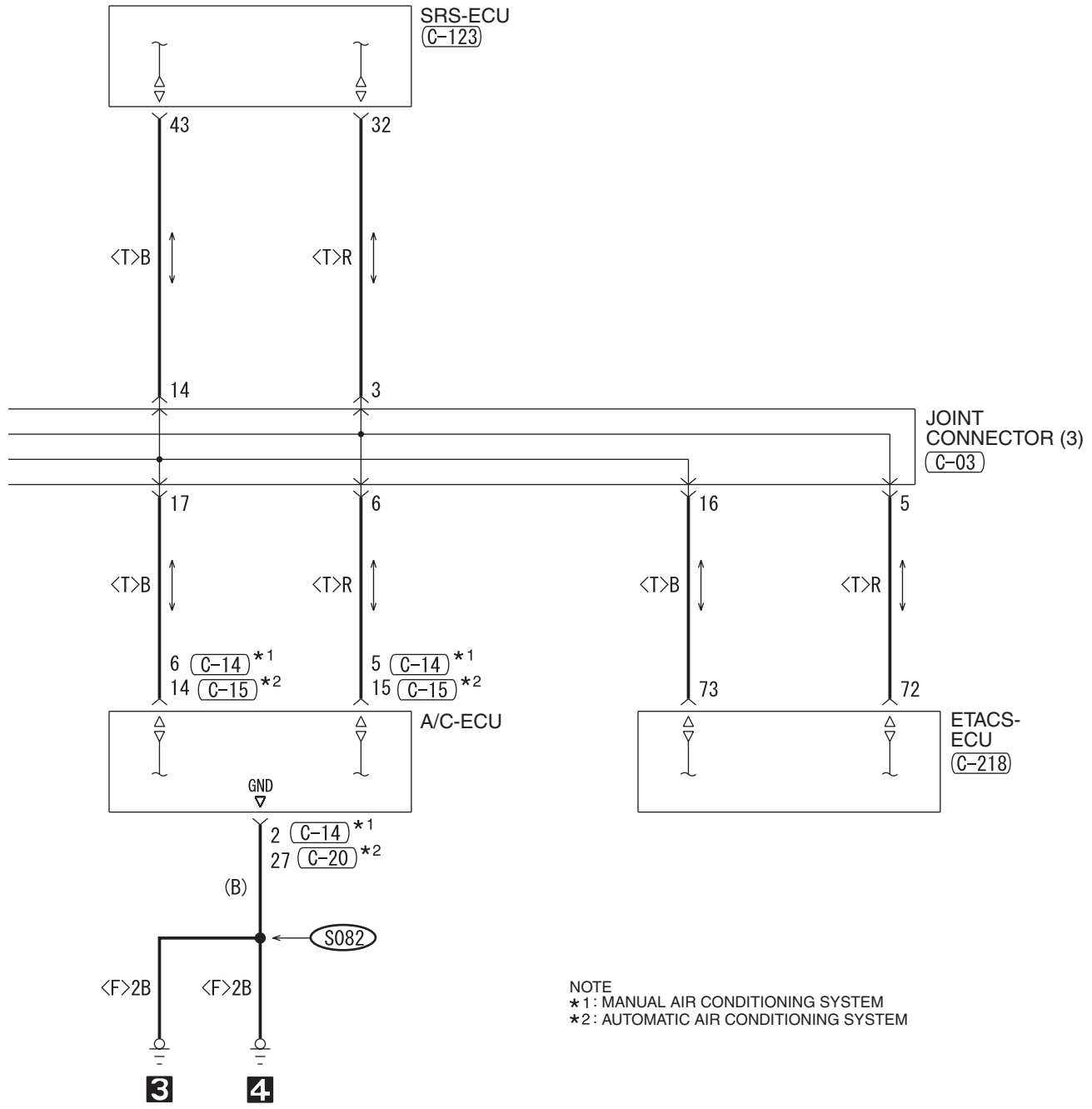

NOTE
 * 1 : MANUAL AIR CONDITIONING SYSTEM
 * 2 : AUTOMATIC AIR CONDITIONING SYSTEM

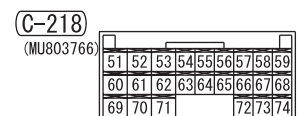
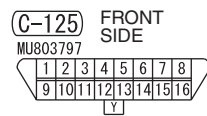
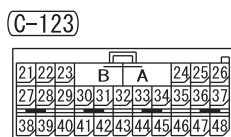
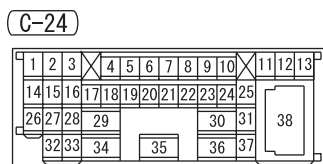

CONTROLLER AREA NETWORK (CAN) <3.8L ENGINE-M/T> (CONTINUED)

7

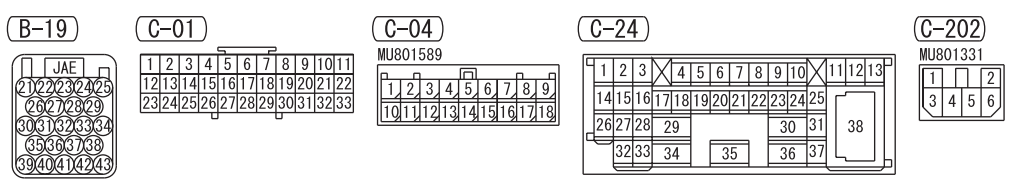
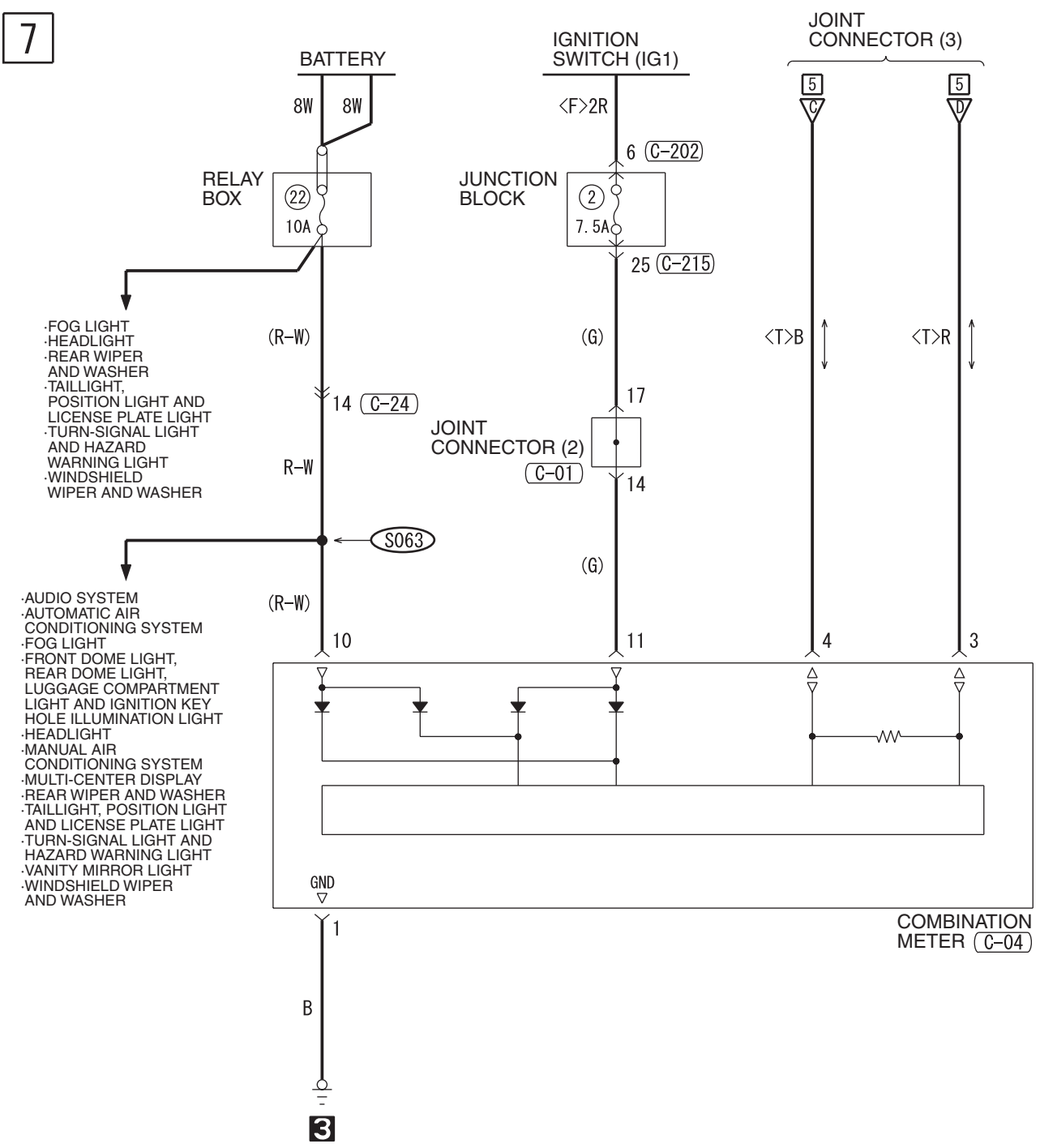

8

ENGINE
 CONTROL MODULE
 (B-19)

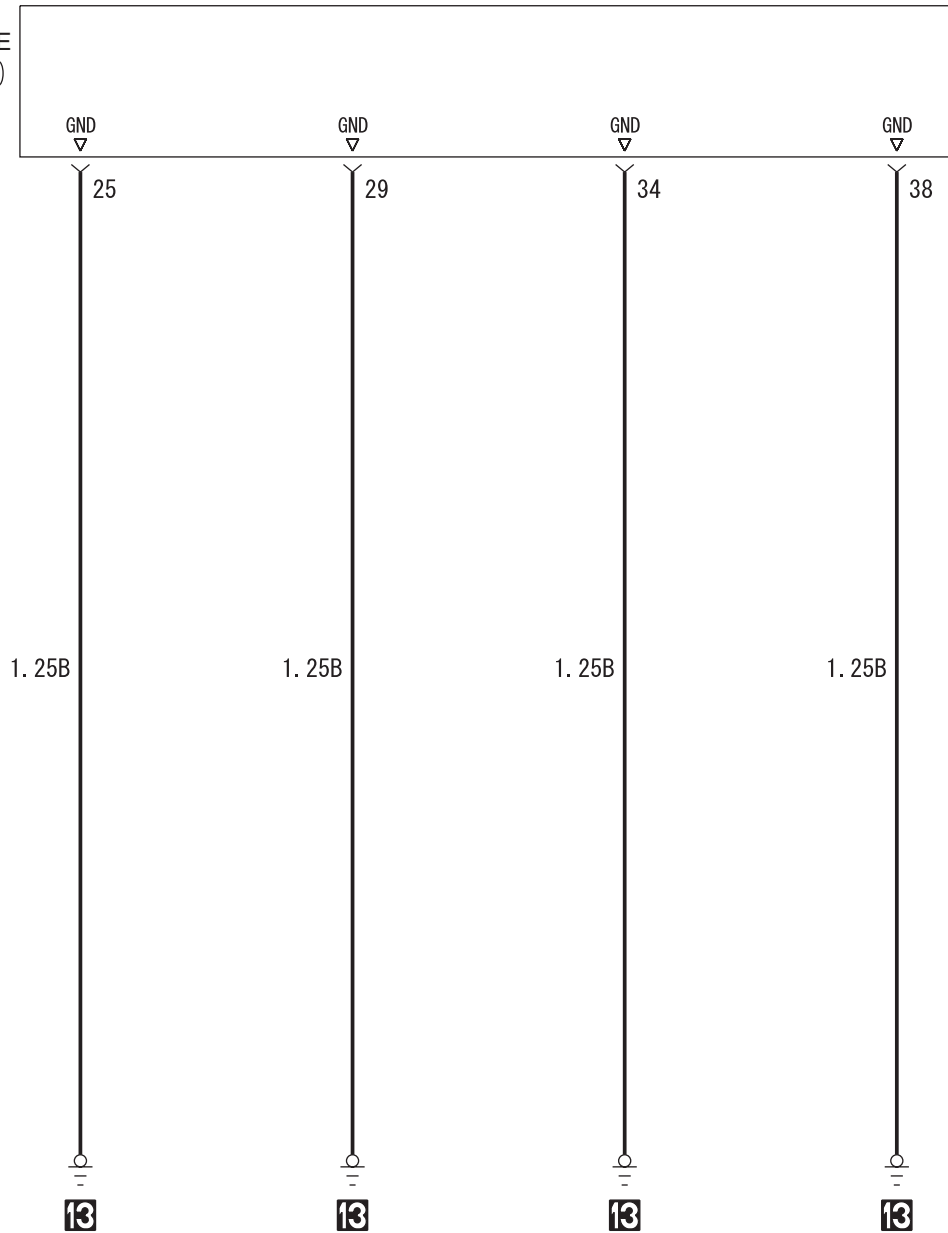

(C-215)

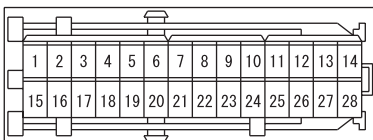

WIRE COLOR CODE
 B : BLACK LG : LIGHT GREEN G : GREEN L : BLUE
 BR : BROWN O : ORANGE GR : GRAY R : RED W : WHITE
 SB : SKY BLUE P : PINK Y : YELLOW V : VIOLET PU : PURPLE

H6P15M24DB

TSB Revision

CONTROLLER AREA NETWORK (CAN) <3.8L ENGINE-A/T>

M1901004000174

1

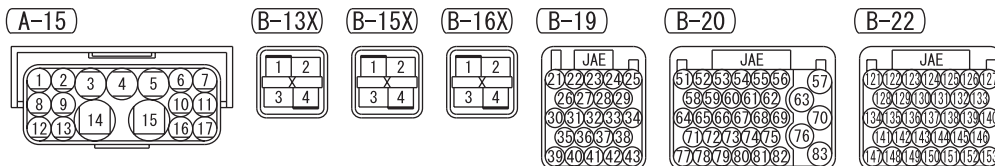
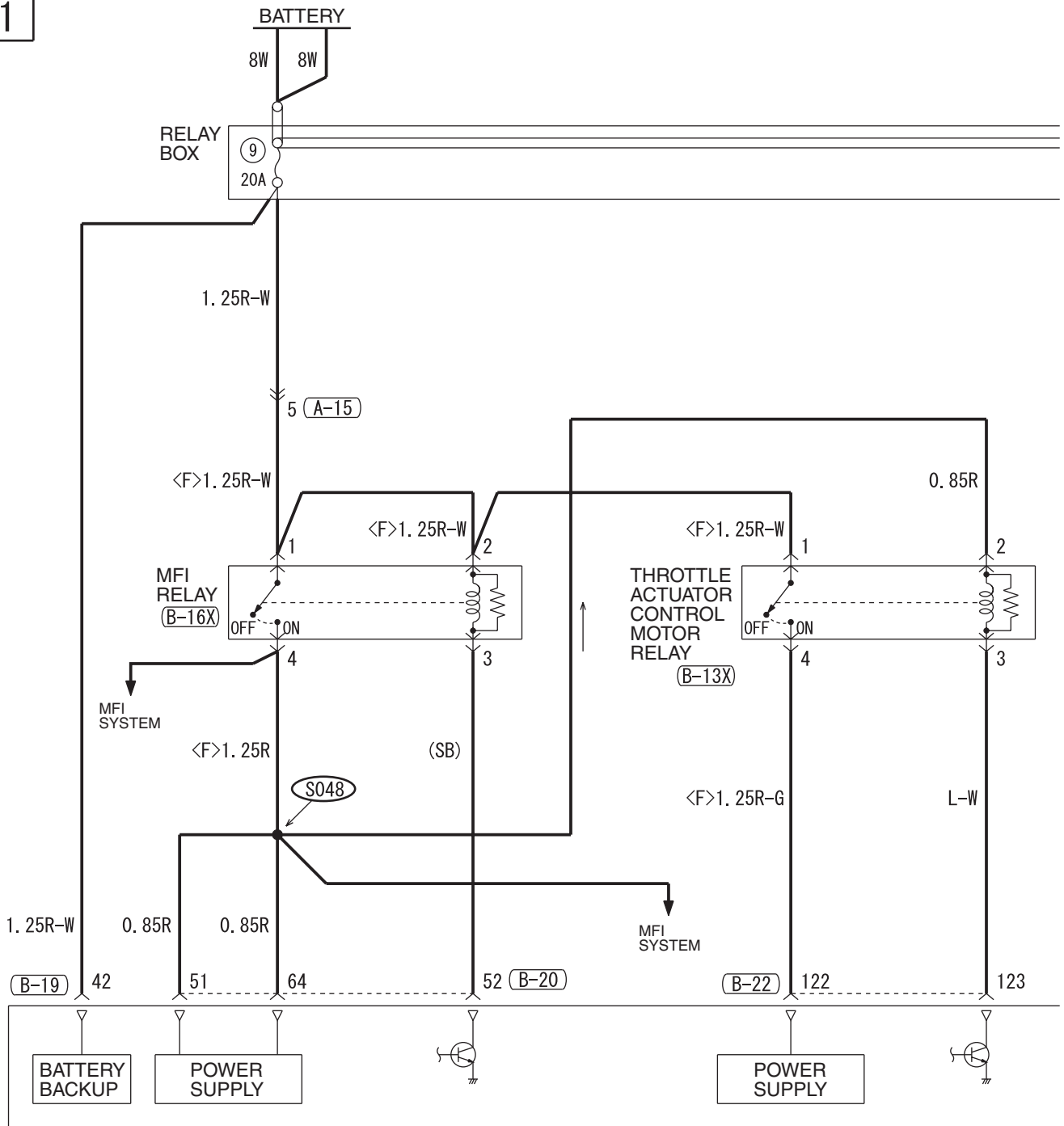

H6P15M25AA

TSB Revision

2

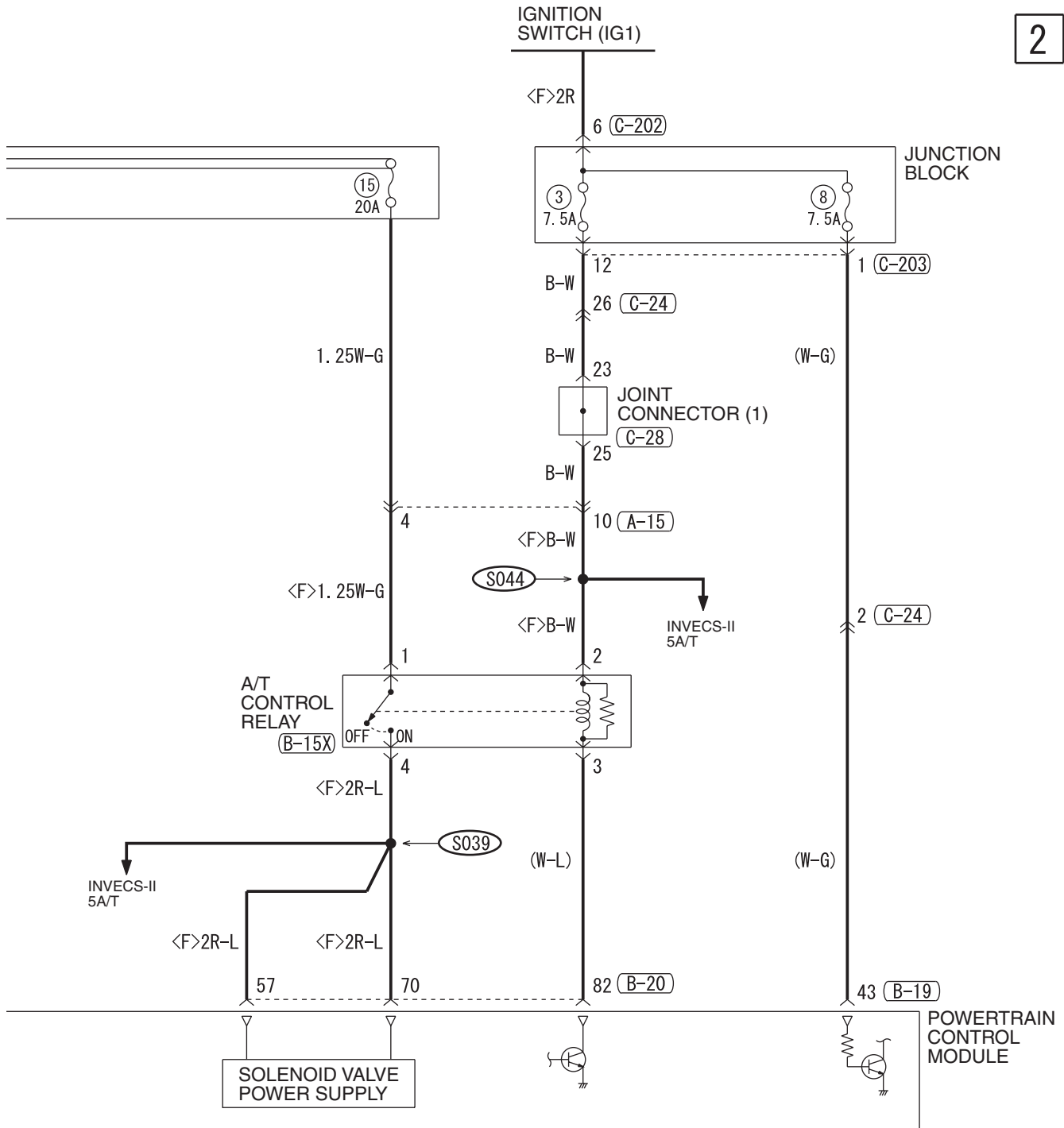

(C-24)

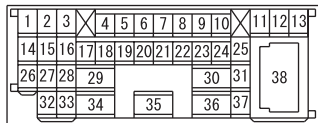

(C-28)

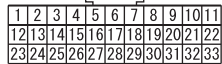

(C-202)



(C-203)

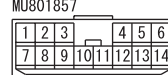

WIRE COLOR CODE

B : BLACK LG : LIGHT GREEN G : GREEN L : BLUE

BR : BROWN O : ORANGE GR : GRAY R : RED W : WHITE

SB : SKY BLUE P : PINK Y : YELLOW V : VIOLET PU : PURPLE

H6P15M25AB

CONTROLLER AREA NETWORK (CAN) <3.8L ENGINE-A/T> (CONTINUED)

3

POWERTRAIN CONTROL MODULE

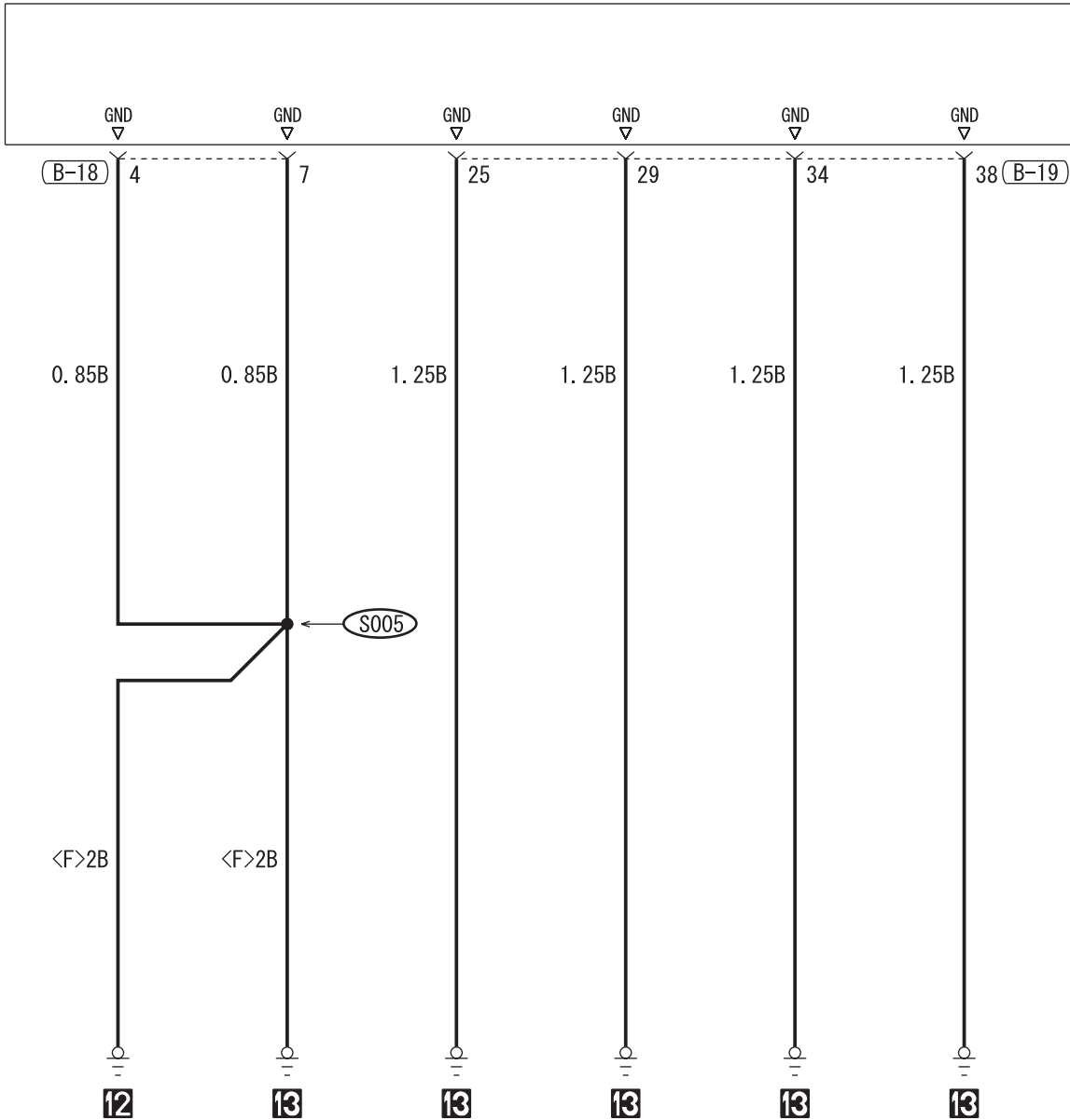

(B-19)

(B-20)

(C-202)

(C-203)

(C-215)

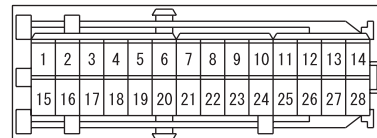
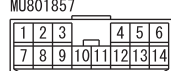
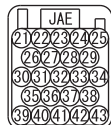
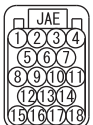

4

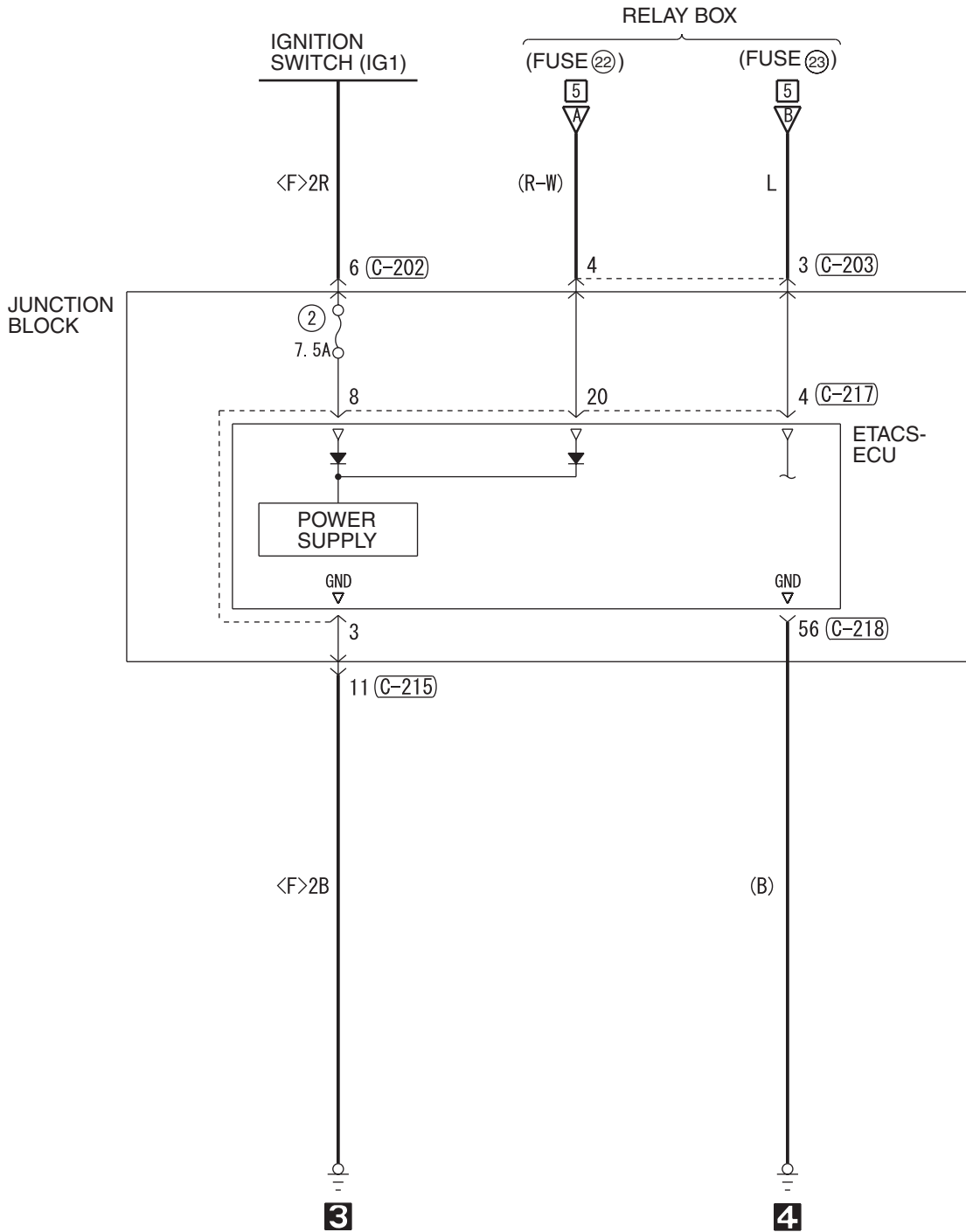

(C-217) JUNCTION BLOCK SIDE

20	19	18	17	16	15	14	13	12	11	10	9	8	7	6	5	4	3	2	1
----	----	----	----	----	----	----	----	----	----	----	---	---	---	---	---	---	---	---	---

(C-218) (MU803766)

51	52	53	54	55	56	57	58	59
60	61	62	63	64	65	66	67	68
69	70	71	72	73	74			

WIRE COLOR CODE
 B: BLACK LG: LIGHT GREEN G: GREEN L: BLUE W: WHITE Y: YELLOW SB: SKY BLUE
 BR: BROWN O: ORANGE GR: GRAY R: RED P: PINK V: VIOLET PU: PURPLE

CONTROLLER AREA NETWORK (CAN) <3.8L ENGINE-A/T> (CONTINUED)

5

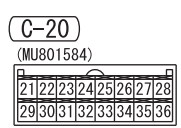
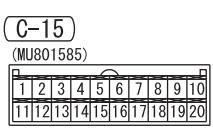
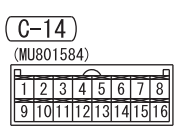
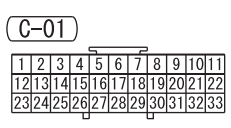
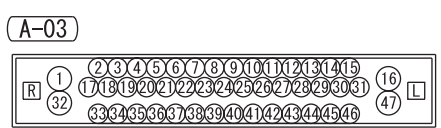
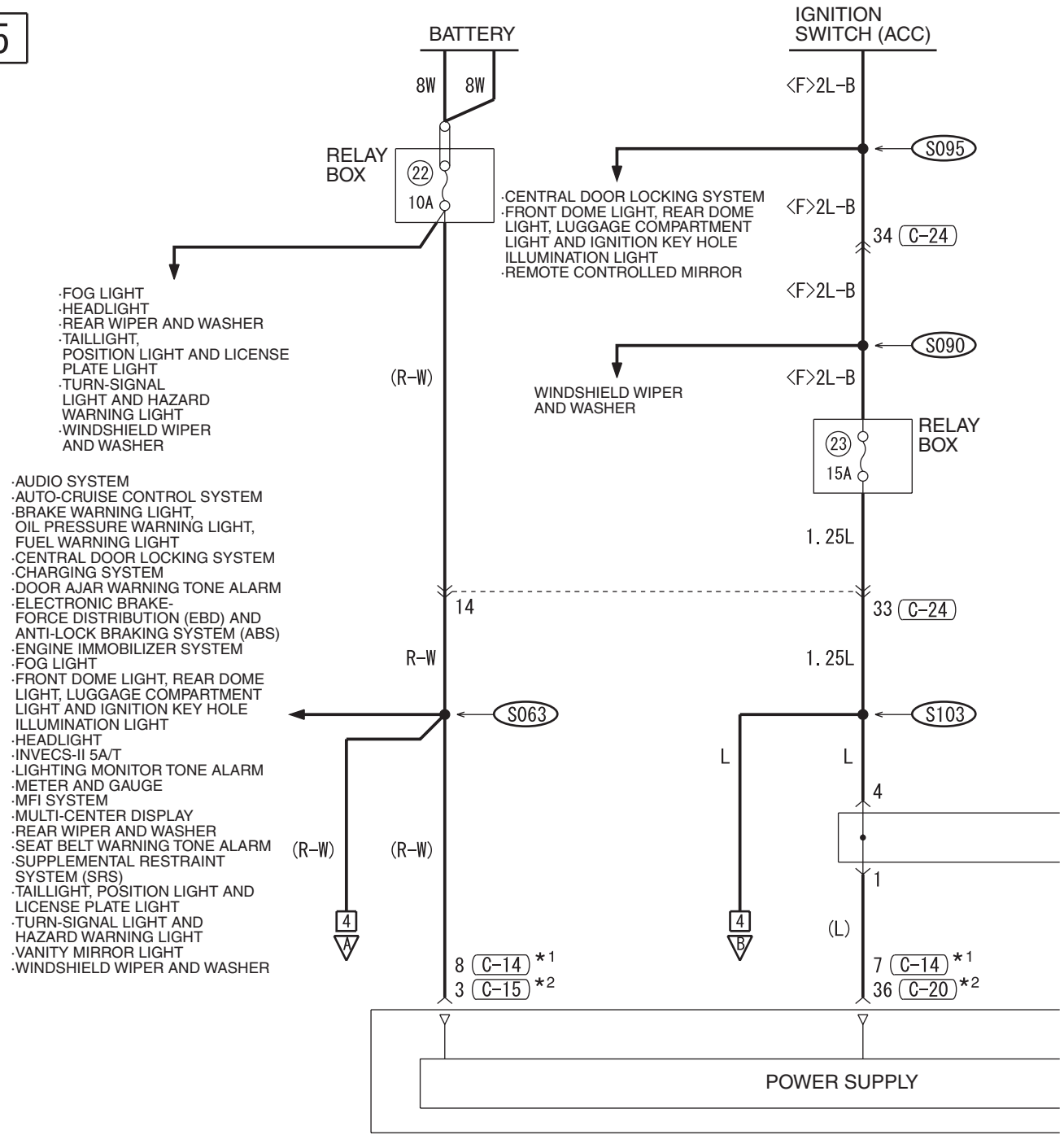

6

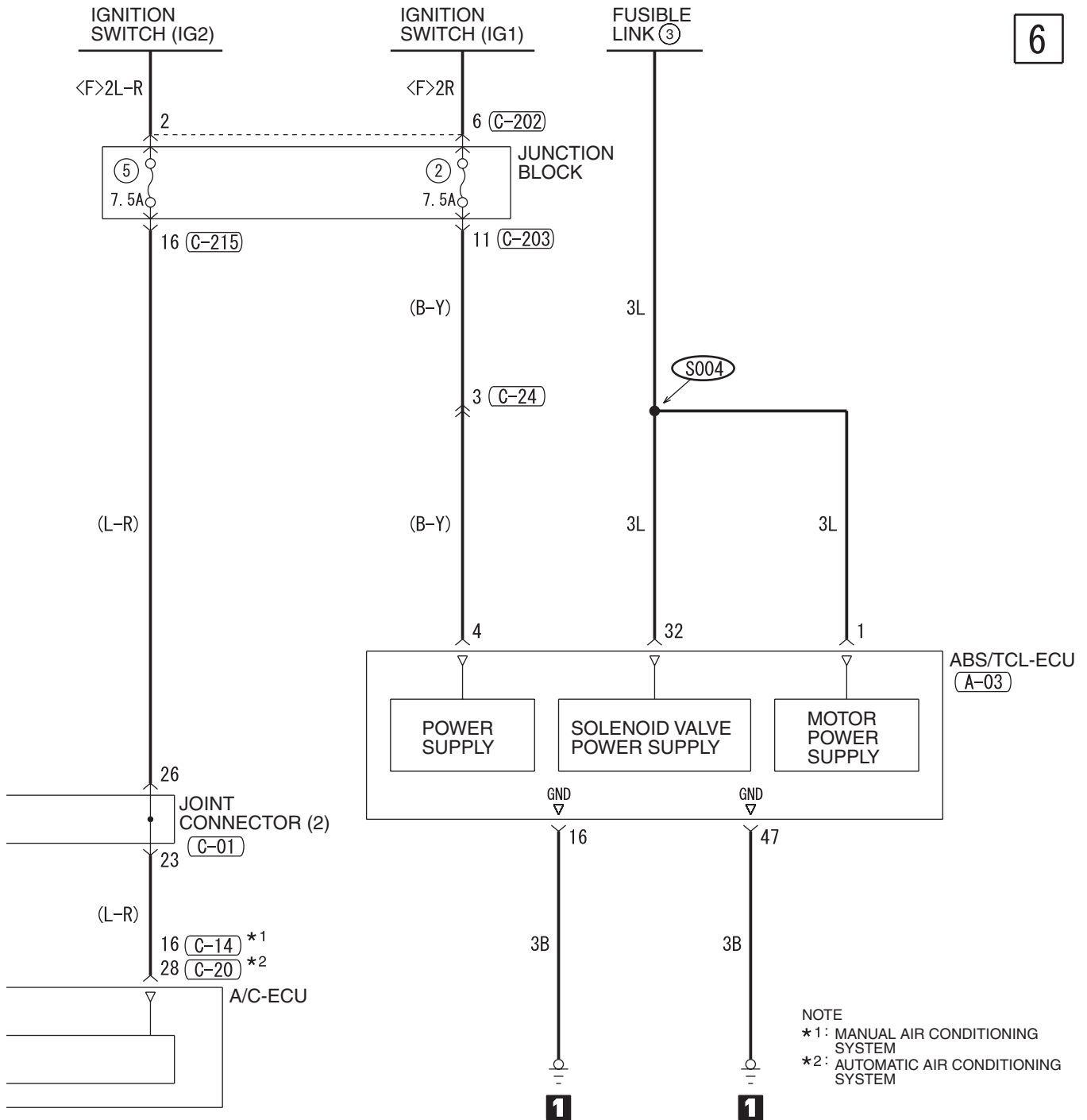

C-24

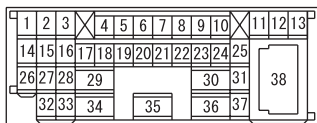

C-202



C-203

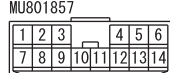

C-215

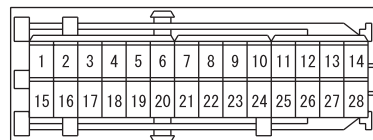

NOTE
*1: MANUAL AIR CONDITIONING SYSTEM
*2: AUTOMATIC AIR CONDITIONING SYSTEM

CONTROLLER AREA NETWORK (CAN) <3.8L ENGINE-A/T> (CONTINUED)

7

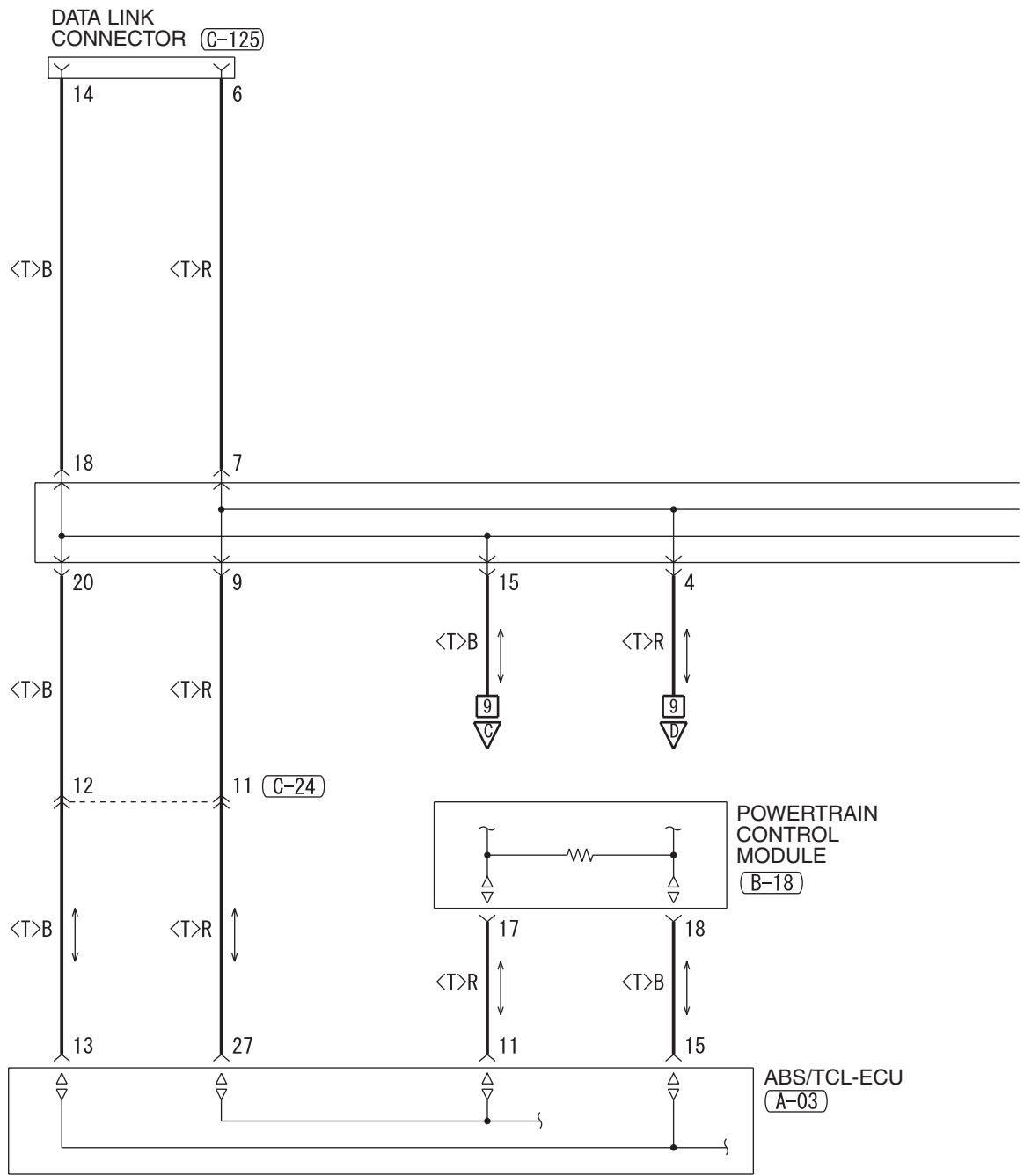

(A-03)

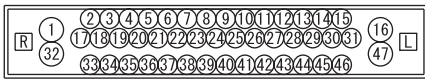

(B-18)



(C-03)

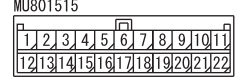

(C-14)

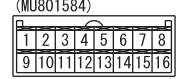

(C-15)

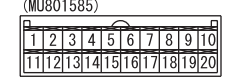

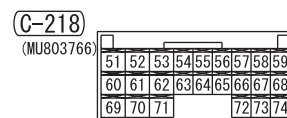
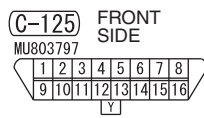
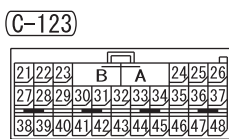
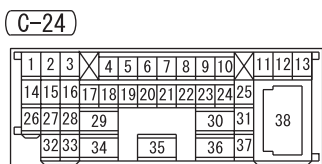
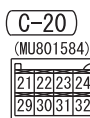
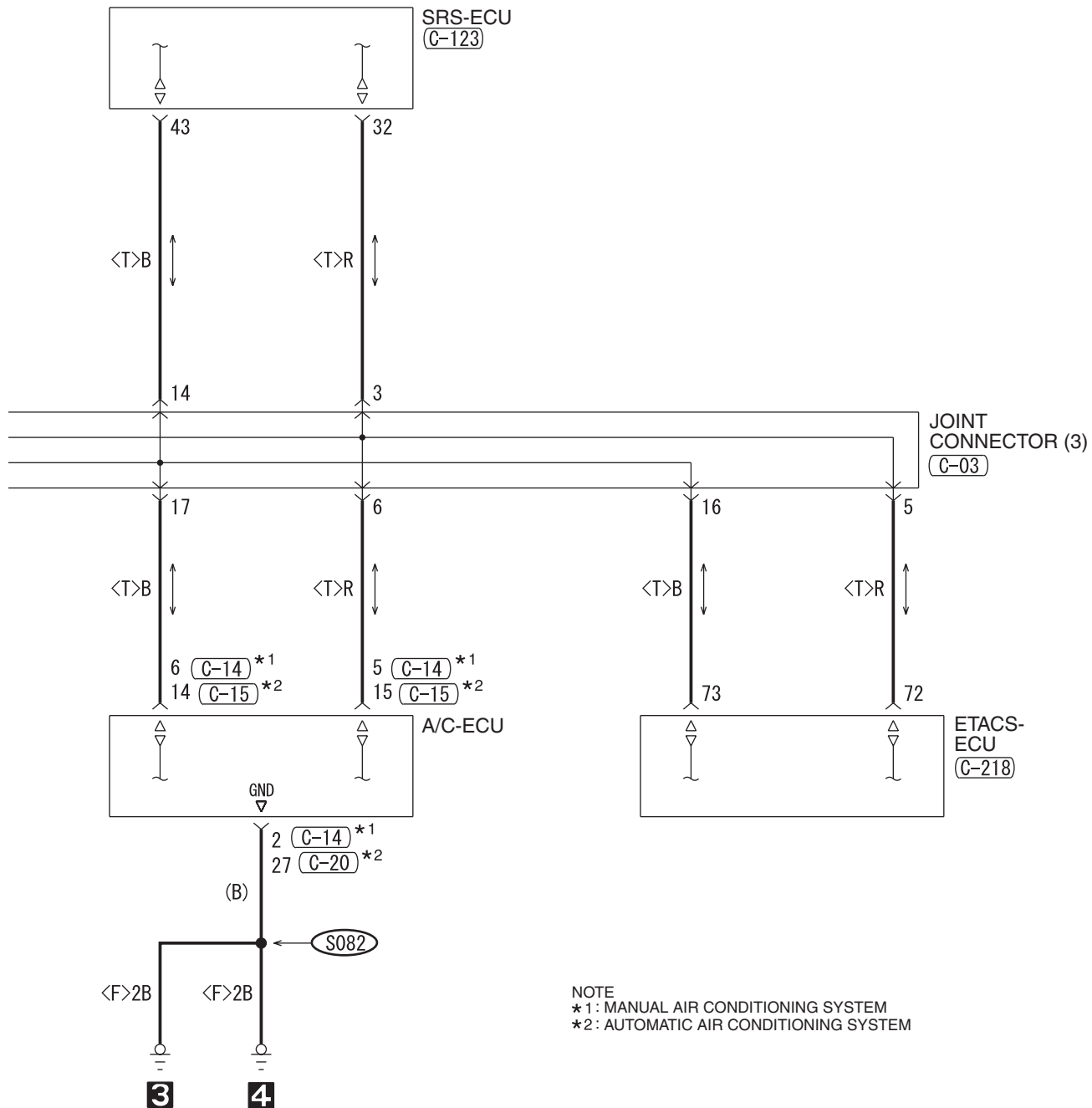

CONTROLLER AREA NETWORK (CAN) <3.8L ENGINE-A/T> (CONTINUED)

9

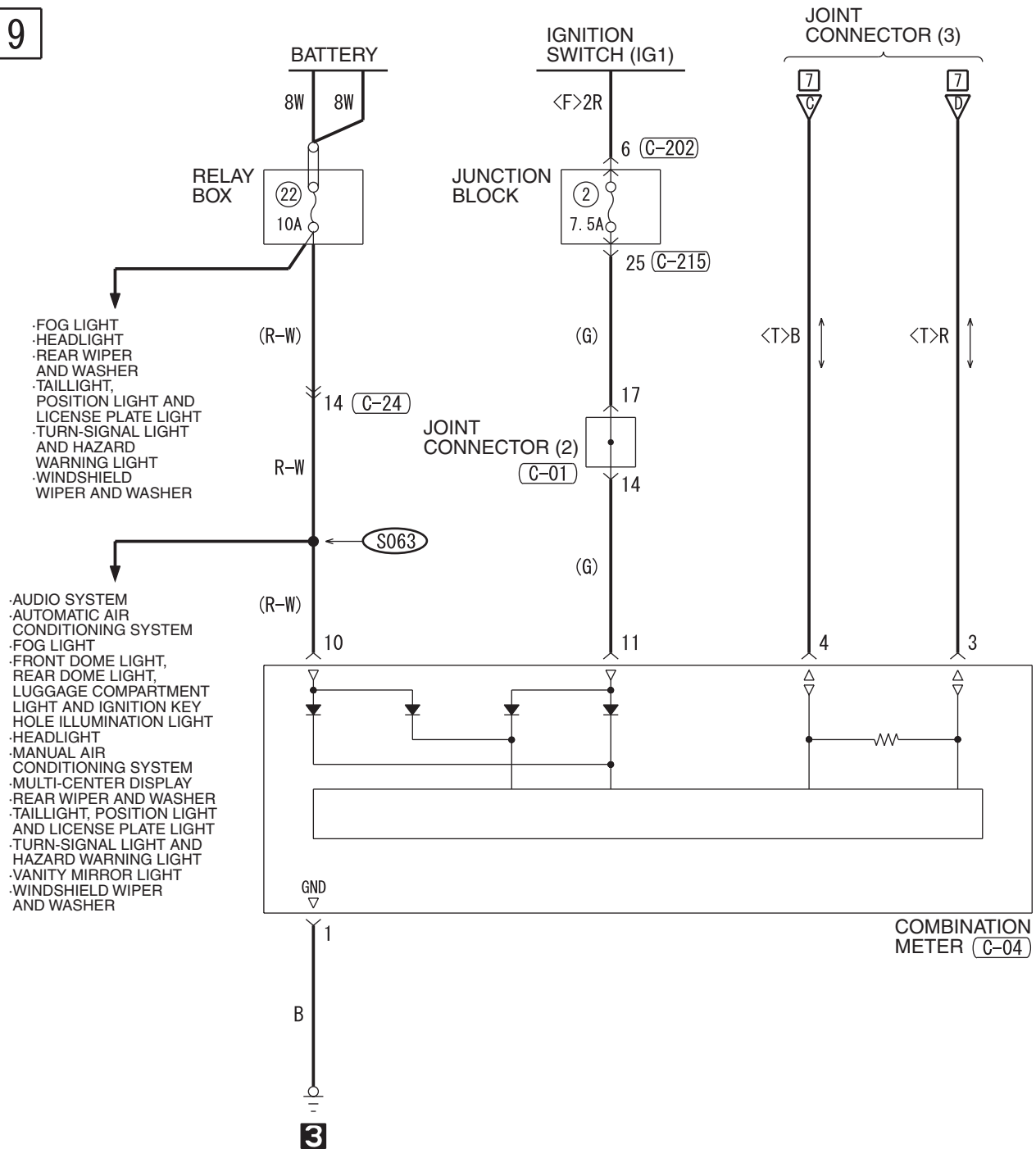

(C-01)



(C-04)

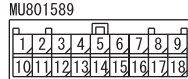

(C-24)

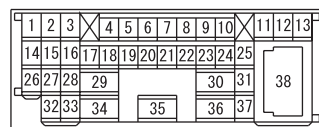

(C-202)



(C-215)

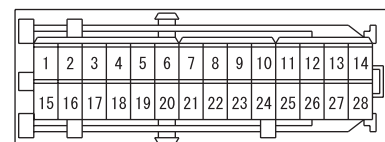

WIRE COLOR CODE

B : BLACK LG : LIGHT GREEN G : GREEN L : BLUE W : WHITE Y : YELLOW SB : SKY BLUE
BR : BROWN O : ORANGE GR : GRAY R : RED P : PINK V : VIOLET PU : PURPLE

H6P15M25EA