

GROUP 90

CIRCUIT DIAGRAMS

CONTENTS

HOW TO READ CIRCUIT DIAGRAMS	90-4	HEADLIGHT LEVELING SYSTEM...	90-102
ETACS-ECU.....	90-10	DAYTIME RUNNING LIGHT (DRL) <HALOGEN TYPE>	90-106
JOINT CONNECTOR.....	90-14	DAYTIME RUNNING LIGHT (DRL) <DISCHARGE TYPE>	90-110
CENTRALIZED JUNCTION.....	90-20	FOG LIGHT.....	90-114
POWER DISTRIBUTION SYSTEM ..	90-28	TAILLIGHT, POSITION LIGHT, LICENSE PLATE LIGHT AND LIGHTING MONITOR TONE ALARM.....	90-116
STARTING SYSTEM <M/T>	90-36	DOME LIGHT, LUGGAGE COMPARTMENT LIGHT AND IGNITION KEY HOLE ILLUMINATION LIGHT ..	90-122
STARTING SYSTEM <TC-SST>....	90-38	TURN-SIGNAL LIGHT AND HAZARD WARNING LIGHT.....	90-130
IGNITION SYSTEM	90-40	BACKUP LIGHT <M/T>	90-134
CHARGING SYSTEM <M/T>.....	90-44	BACKUP LIGHT <TC-SST>.....	90-136
CHARGING SYSTEM <TC-SST> ...	90-48	STOPLIGHT	90-138
MFI SYSTEM <M/T>	90-52	HORN	90-139
MFI SYSTEM <TC-SST>.....	90-64	METER AND GAUGE <M/T>	90-140
COOLING SYSTEM.....	90-76	METER AND GAUGE <TC-SST>....	90-144
SHIFT LOCK MECHANISM.....	90-80		
TWIN CLUTCH SPORT SHIFT TRANSAXLE (TC-SST)	90-82		
HEADLIGHT <HALOGEN TYPE> ...	90-90		
HEADLIGHT <DISCHARGE TYPE> .	90-96		

Continued on next page

BRAKE WARNING LIGHT, FUEL WARNING LIGHT AND OIL PRESSURE WARNING LIGHT <M/T>	90-148	SUPPLEMENTAL RESTRAINT SYSTEM (SRS)	90-266
BRAKE WARNING LIGHT, FUEL WARNING LIGHT AND OIL PRESSURE WARNING LIGHT <TC-SST>	90-152	AUTO-CRUISE CONTROL SYSTEM <M/T>	90-276
POWER WINDOWS	90-156	AUTO-CRUISE CONTROL SYSTEM <TC-SST>	90-282
CENTRAL DOOR LOCKING SYSTEM	90-162	TIRE PRESSURE MONITORING SYSTEM (TPMS) <M/T>	90-290
KEYLESS OPERATING SYSTEM (KOS)	90-174	TIRE PRESSURE MONITORING SYSTEM (TPMS) <TC-SST>	90-296
TRUNK LID OPENER	90-184	IMMOBILIZER SYSTEM <M/T>	90-304
AIR CONDITIONING SYSTEM	90-190	IMMOBILIZER SYSTEM <TC-SST> ..	90-308
WINDSHIELD WIPER AND WASHER	90-202	SUNROOF	90-312
REMOTE CONTROLLED MIRROR ..	90-206	HEATED SEAT	90-314
REAR WINDOW DEFOGGER	90-208	HANDS FREE SYSTEM	90-318
AUDIO SYSTEM <VEHICLES WITHOUT AUDIO AMPLIFIER>	90-210	IGNITION KEY REMINDER TONE ALARM <VEHICLES WITHOUT KOS>	90-330
AUDIO SYSTEM <VEHICLES WITH AUDIO AMPLIFIER>	90-216	IGNITION KEY REMINDER TONE ALARM <VEHICLES WITH KOS>	90-332
mitsubishi MULTI-COMMUNICATION SYSTEM (MMCS)	90-228	SEAT BELT WARNING TONE ALARM	90-336
SPARE CONNECTOR (FOR NAVIGATION SYSTEM)	90-240	DOOR AJAR WARNING TONE ALARM	90-340
ACCESSORY SOCKET AND CIGARETTE LIGHTER	90-242	PARKING BRAKE REMINDER TONE ALARM	90-344
ABS, ASC, ACD, AYC AND S-AWC <M/T>	90-244	THEFT-ALARM SYSTEM	90-348
ABS, ASC, ACD, AYC AND S-AWC <TC-SST>	90-254	SPARE CONNECTOR (MULTI-PURPOSE)	90-357
		CONTROLLER AREA NETWORK (CAN) <M/T>	90-358
		CONTROLLER AREA NETWORK (CAN) <TC-SST>	90-362

NOTES

HOW TO READ CIRCUIT DIAGRAMS

The circuit of each system from the fuse (or fusible link) to ground is shown. The power supply is shown at the top and the ground at the bottom to facilitate understanding of how the current flows. Some variations are included in one circuit diagram. Accordingly, some diagrams may not be applicable for individual vehicles. The circuit diagrams show the state when switches are operated.

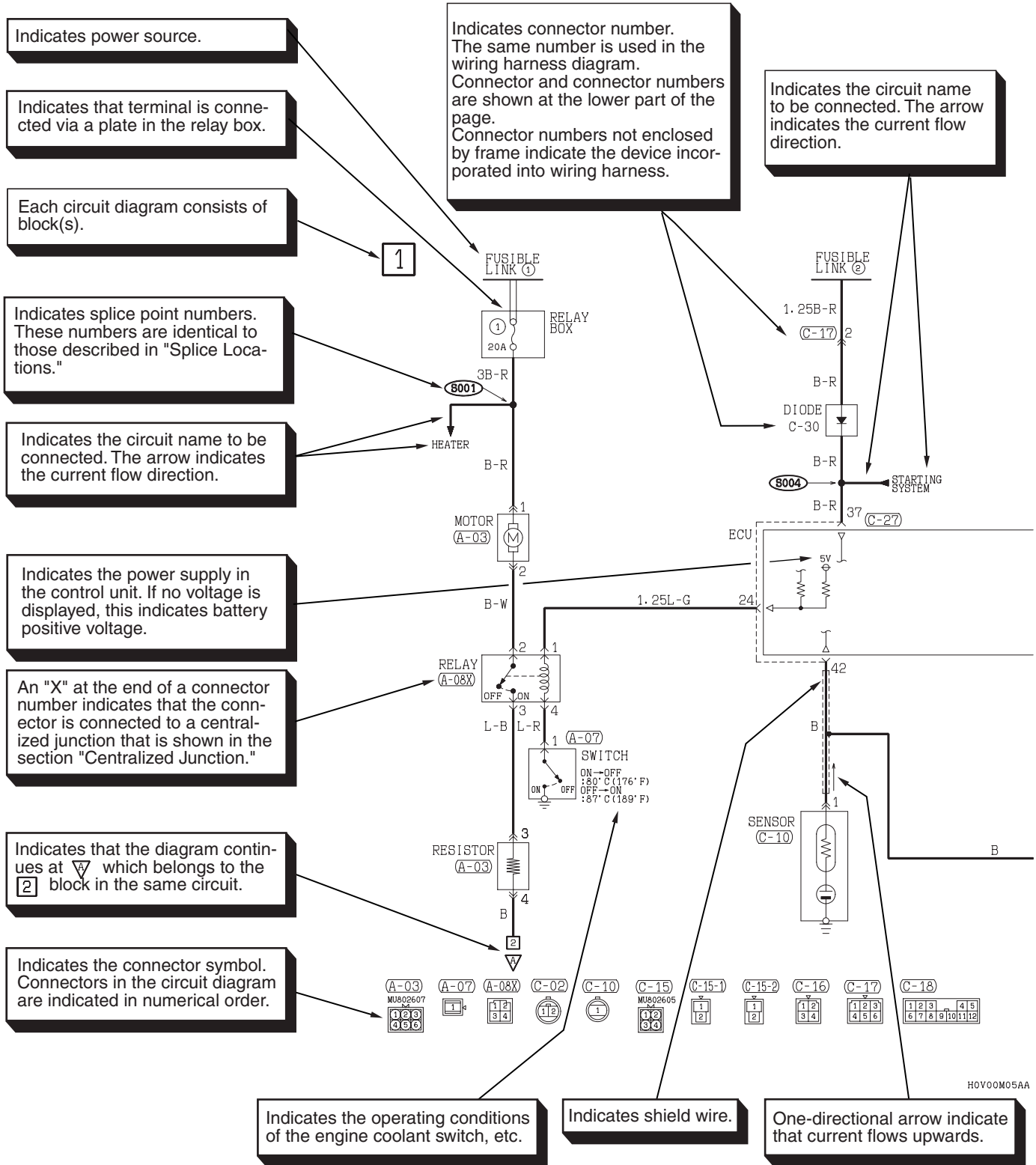

H0V00M05AA

AC106603AG

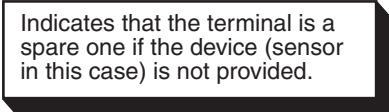
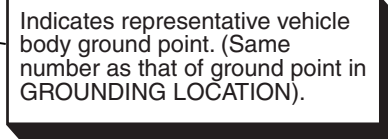
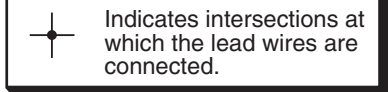
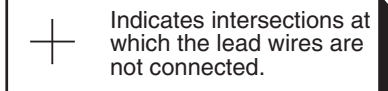
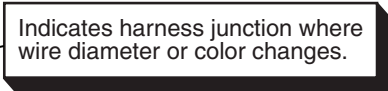
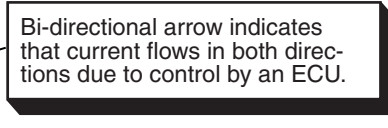
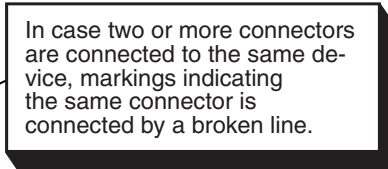
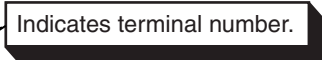
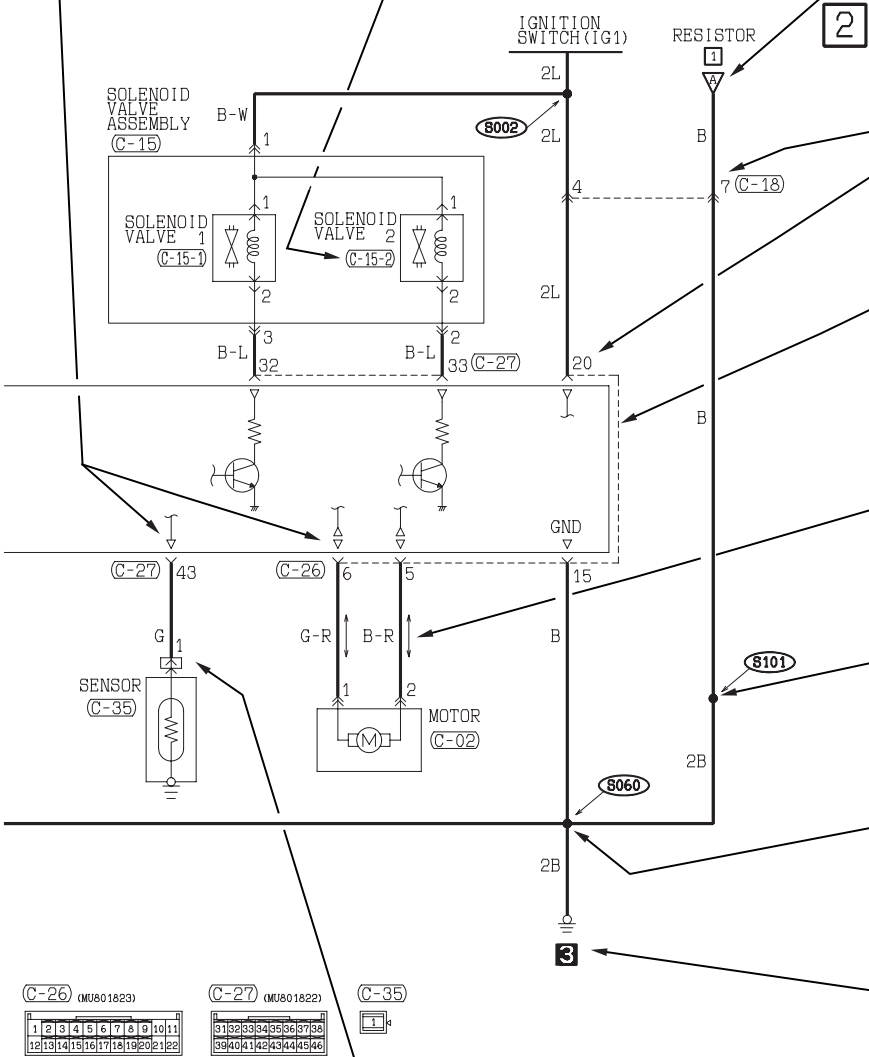
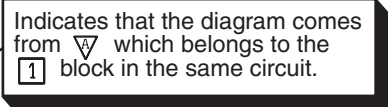
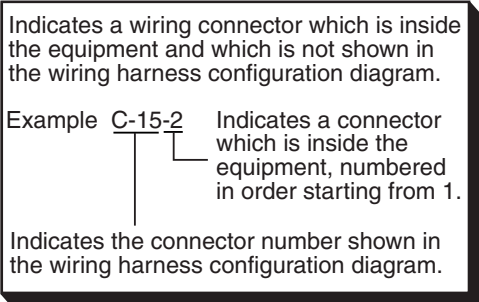
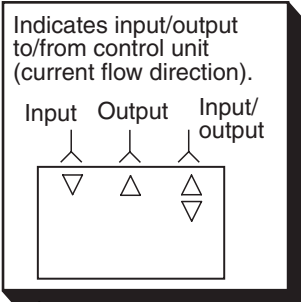





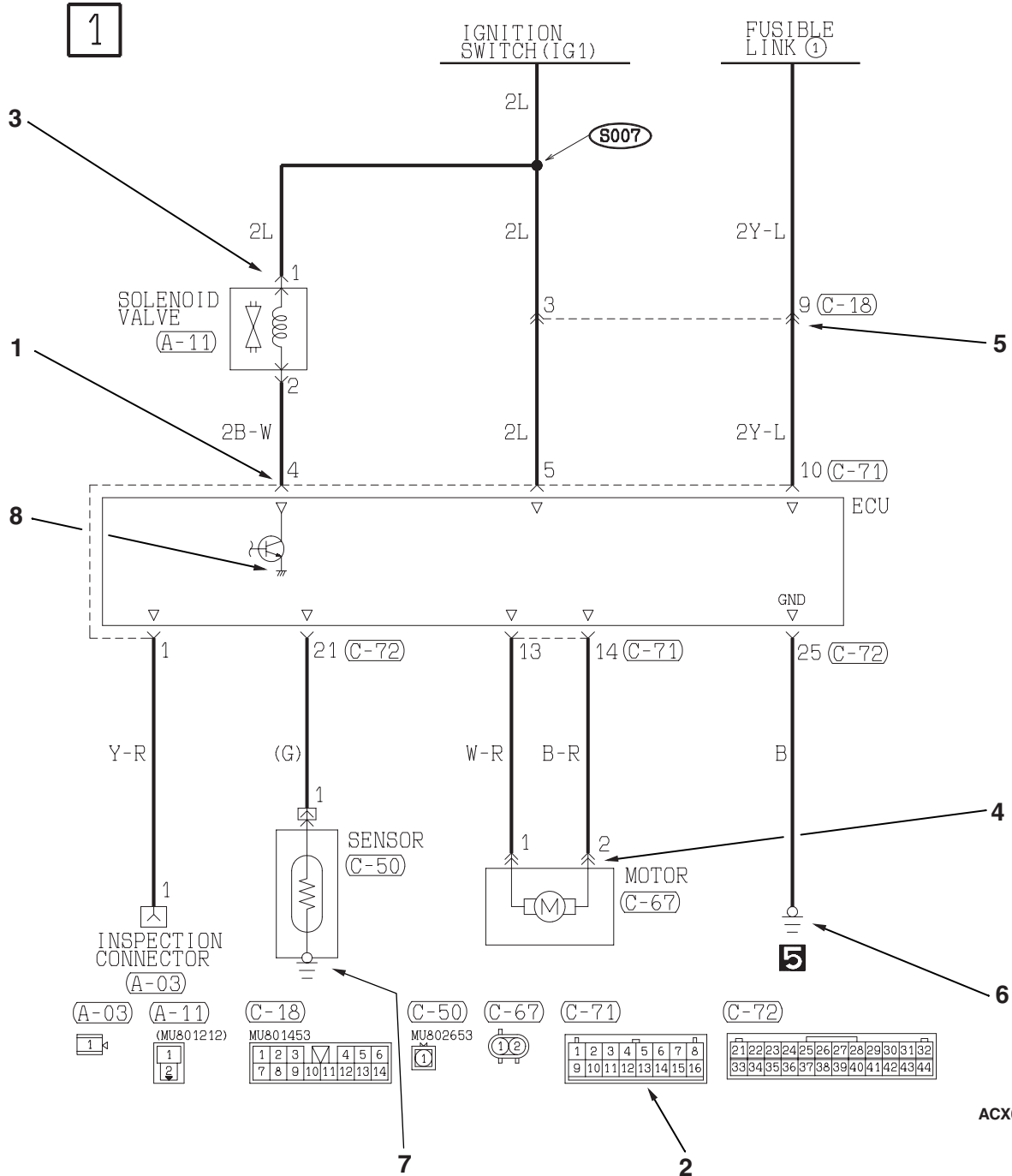



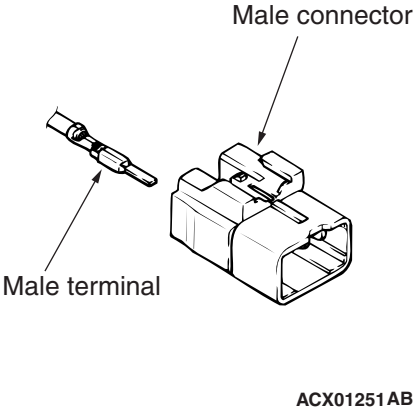

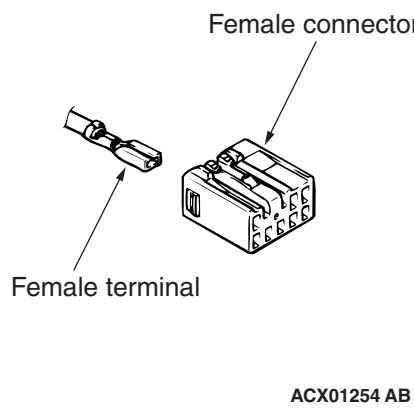
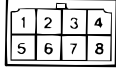

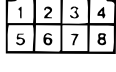
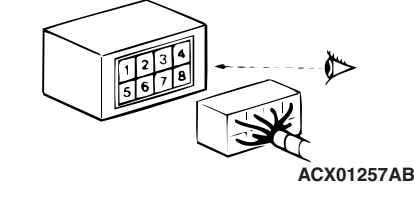
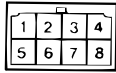
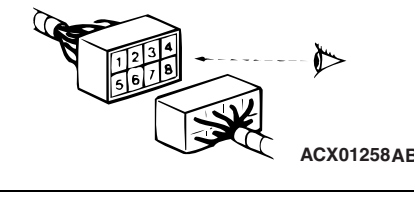

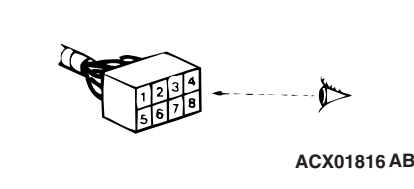
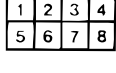

H0V00M05AB

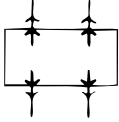
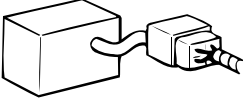
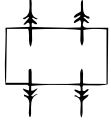
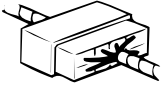
CONNECTOR/GROUNDING INDICATIONS

























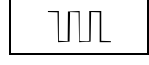

ACX02364 AC

Item	No.	Connector/ Grounding	Symbol	Contents
Connector and terminal marking	1		<p>Male terminal</p>  <p>ACX01252 AB</p>	The male and female terminals are indicated as shown. The connector with male terminal(s) is called as male connector and indicated by two connector contour lines, while the connector with female terminal(s) is called as female connector and indicated by single connector contour line.
			<p>Male connector</p>  <p>ACX01253 AB</p>	
		<p>Female terminal</p>  <p>ACX01255 AB</p>		
		<p>Female connector</p>  <p>ACX01256 AB</p>		
Connector symbol marking	2	<p>Device</p> 	 <p>ACX01253</p>	The symbol indicates the connector is viewed as shown. At a device connection, the connector symbol on the device side is shown. For an intermediate connector, the male connector symbol is shown. For spare connectors and check connectors, no device is connected, and so the harness-side connector symbol is shown for these connectors. However, a data link connector is exceptional.
		<p>Intermediate connector</p> 		
		<p>Spare connector, check connector</p> 	 <p>ACX01256</p>	

Item	No.	Connector/ Grounding	Symbol	Contents
Connector connection marking	3	Direct connection type  ACX01260 AB	 ACX01261	Connection between a device and the harness is either by direct insertion in the device (direct connection type) or by connection with a harness connector furnished on the device side (harness connection type). The two types are indicated as illustrated.
	4	Harness connection type  ACX01262 AB	 ACX01263	
	5	Intermediate connector  ACX01264 AB	 ACX01265	
Ground marking	6	Body ground  ACX01273 AB	 ACX01274	Grounding is either by body ground, device ground or control unit interior ground. These are indicated as illustrated.
	7	Device ground  ACX01275 AB	 ACX01276	
	8	Ground in control unit  ACX01277 AB	 ACX01278	

SYMBOLS (EXCEPT CONNECTOR AND GROUNDING)

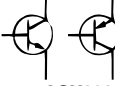
Devices appearing in circuit diagrams are indicated by the following symbols.

<p>Battery</p>  <p>ACX02377 AB</p>	<p>Buzzer</p>  <p>ACX02378 AB</p>	<p>Capacitor</p>  <p>ACX02379 AB</p>	<p>Electrolytic capacitor</p>  <p>ACX02380 AB</p>	<p>Variable capacitor</p>  <p>ACX02381 AB</p>	<p>Coil</p>  <p>ACX02382 AB</p>
<p>Diode</p>  <p>ACX02383 AB</p>	<p>Light emitting diode</p>  <p>ACX02384 AB</p>	<p>Photo diode</p>  <p>ACX02385 AB</p>	<p>Zener diode</p>  <p>ACX02386 AB</p>	<p>Dual filament bulb</p>  <p>ACX02387 AC</p>	<p>Single filament bulb</p>  <p>ACX02388 AC</p>
<p>Fuse</p>  <p>ACX02389 AB</p>	<p>Fusible link</p>  <p>ACX02390 AB</p>	<p>Horn</p>  <p>ACX02391 AB</p>	<p>Motor</p>  <p>ACX02392 AB</p>	<p>Pulse generator</p>  <p>ACX02393 AB</p>	<p>Piezoelectric device</p>  <p>ACX02394 AB</p>
<p>Resistor</p>  <p>ACX02395 AB</p>	<p>Variable resistor</p>  <p>ACX02396 AB</p>	<p>Speaker</p>  <p>ACX02397 AB</p>	<p>Thermistor</p>  <p>ACX02398 AB</p>	<p>Transistor</p>  <p>ACX02399 AB</p>	<p>Photo transistor</p>  <p>ACX02400 AB</p>

WIRE COLOR CODES

Wire colors are identified by the following color codes.

Code	Wire color	Code	Wire color	Code	Wire color	Code	Wire color
B	Black	L	Blue	PU	Purple	V	Violet
BR	Brown	LG	Light green	R	Red	W	White
G	Green	O	Orange	SB	Sky blue	Y	Yellow
GR	Gray	P	Pink	SI	Silver	-	-

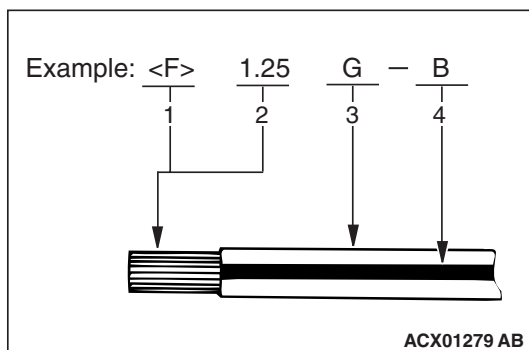

If a cable has two colors, the first of the two color code characters indicates the basic color (color of the cable coating) and the second indicates the marking (tracer) color.

No.	Meaning
1	<F>: Flexible wire <T>: Twisted wire
2	Wire size (mm ²)*
3	Basic color (color of the cable coating)
4	Marking color

NOTE:

*: No code indicates 0.5 mm² (0.0008 in²). Cable color code in parentheses indicates 0.3 mm² (0.0005 in²).

ETACS-ECU

M1901026300270

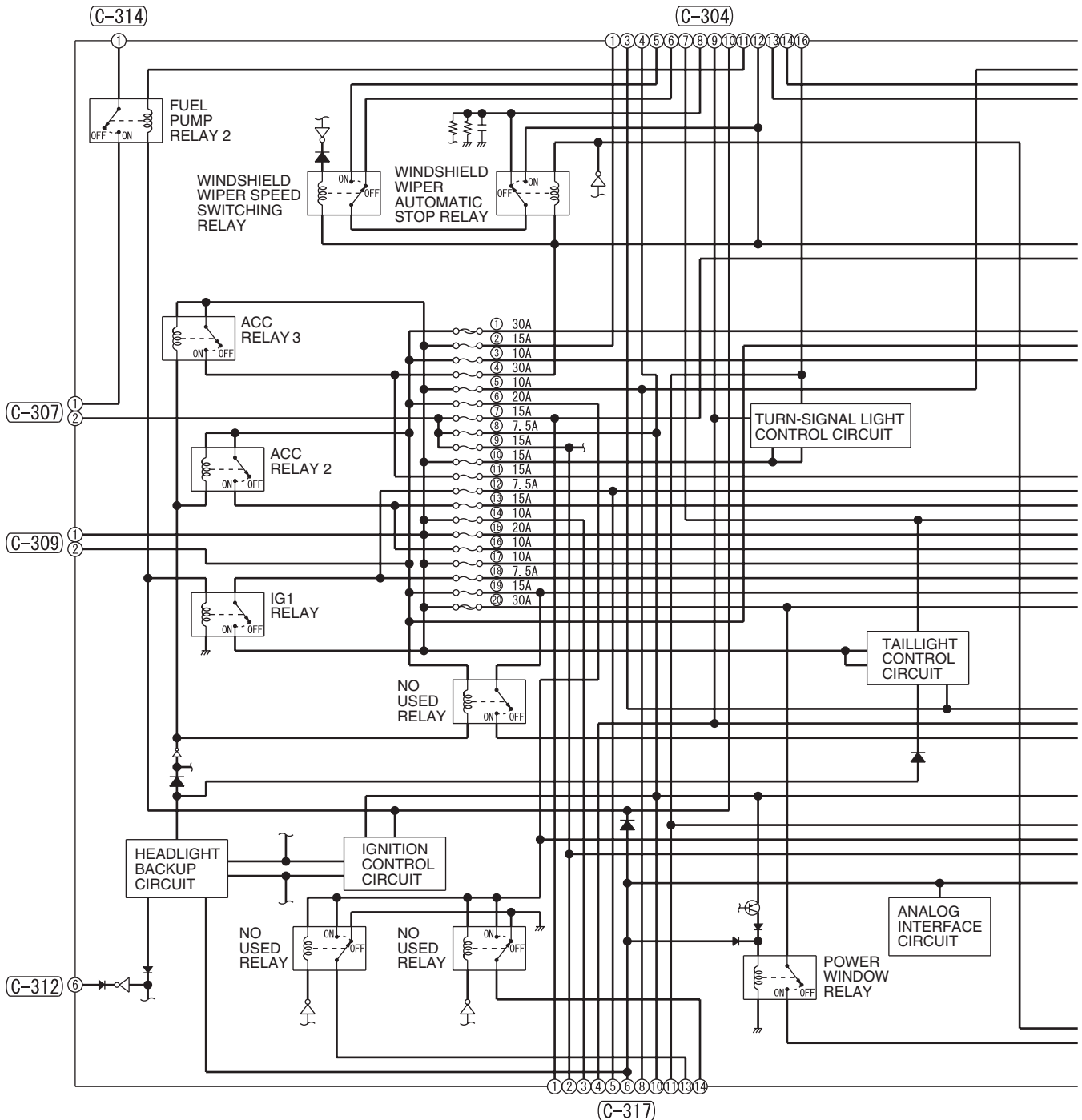

(C-301)

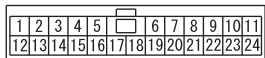

(C-302)



(C-303)



(C-304)

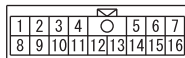

(C-307)



(C-309)



(C-310)



(C-311)

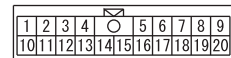

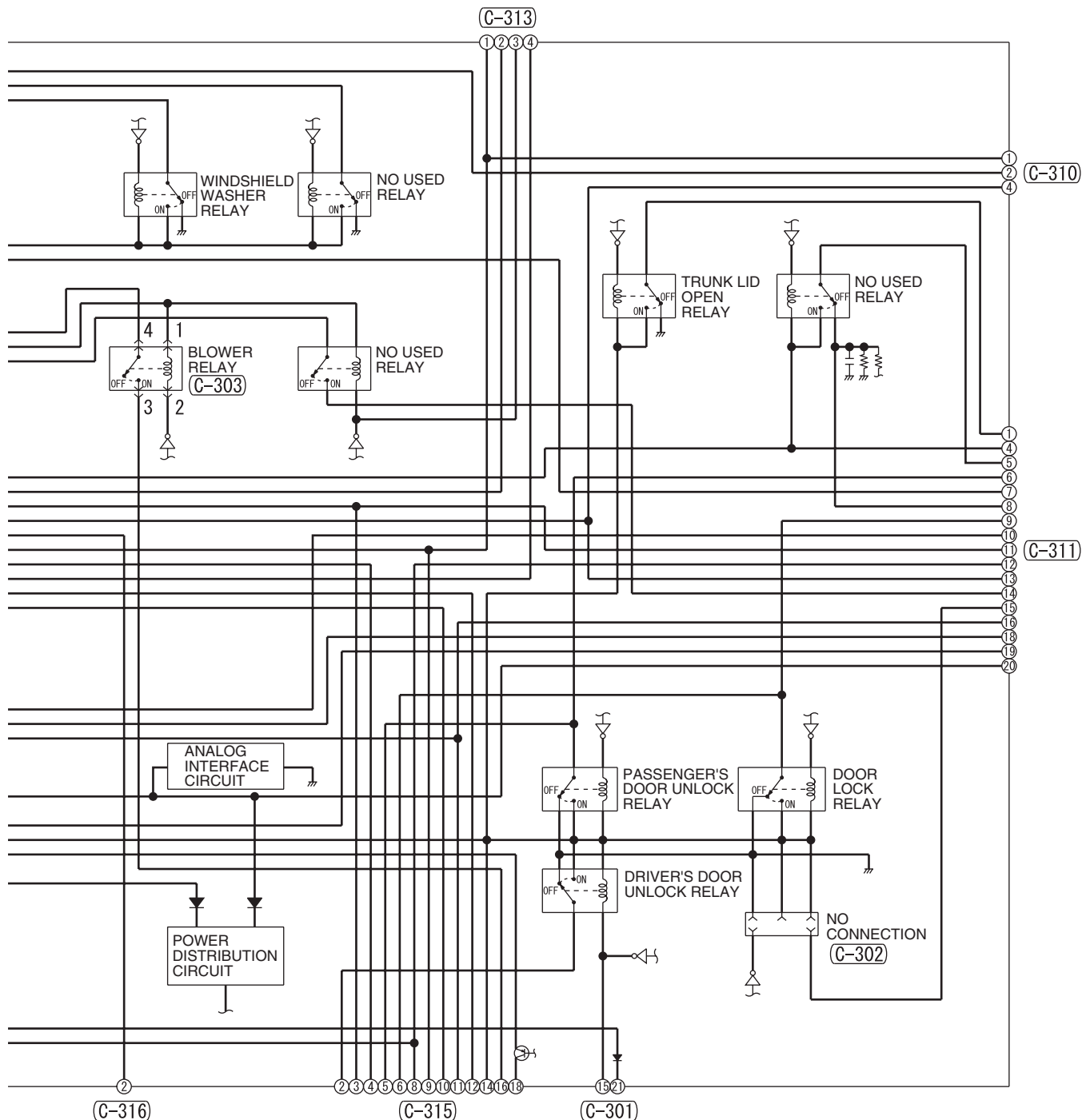

(C-312)

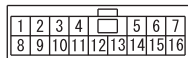

(C-313)

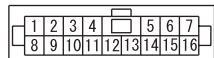

(C-314)



(C-315)

MU801323 MU801890

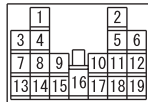

(C-316)



(C-317)

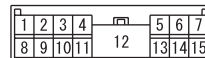

ETACS-ECU (CONTINUED)

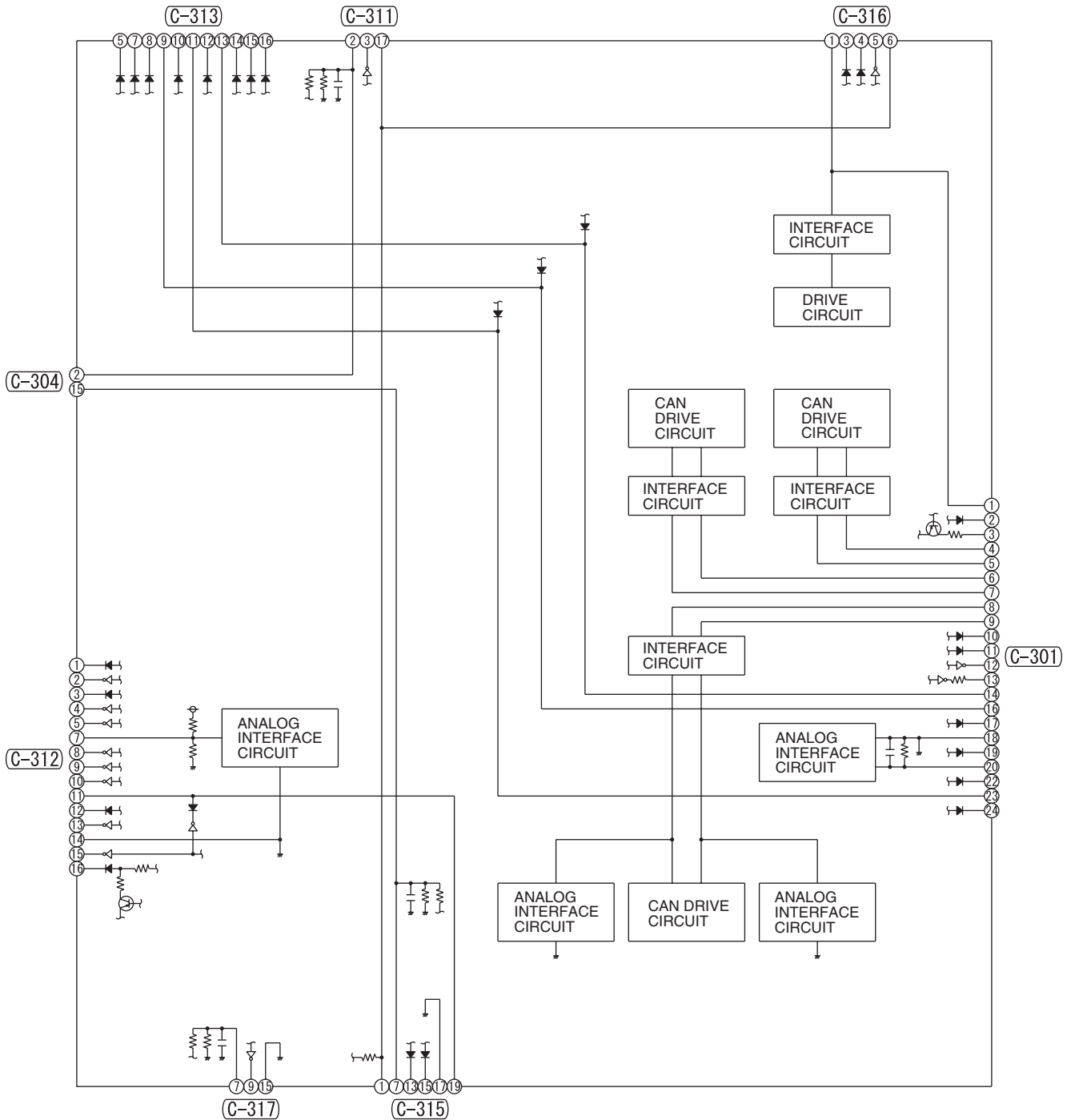

(C-301)

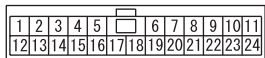

(C-304)

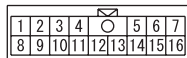

(C-311)

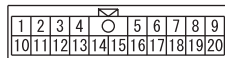

(C-312)

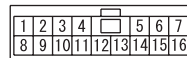

(C-313)

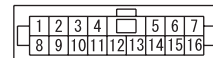

(C-315)



(C-316)



(C-317)



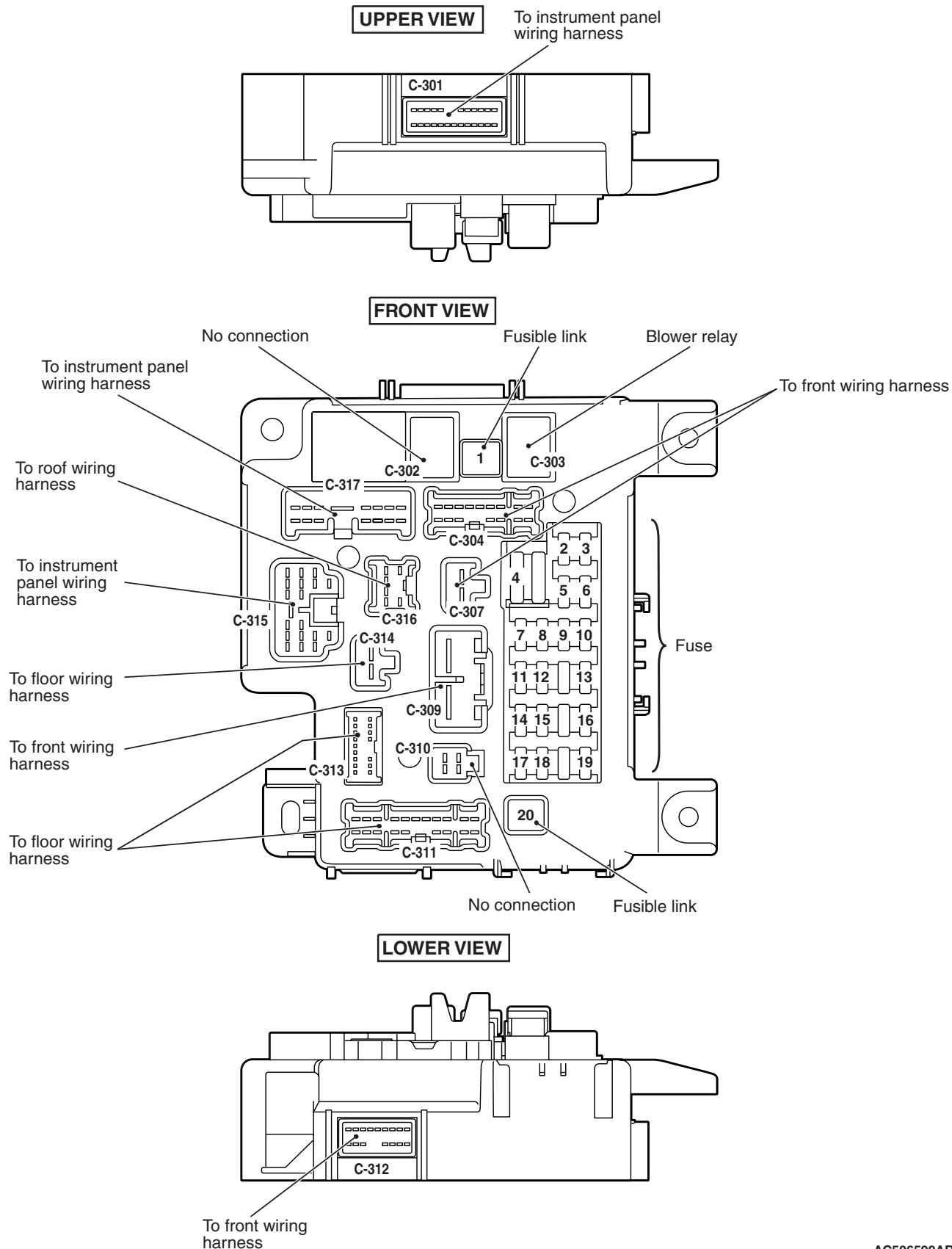

AC506599AR

JOINT CONNECTOR

M1901014203037

NOTE:

IN THE ACTUAL VEHICLES, SOME OF THE JOINT CONNECTOR TERMINALS IN THE SAME BUS ARE USED, SO IN SOME CASES, THE TERMINAL ARRANGEMENT INDICATED ON THE CIRCUIT DIAGRAMS DOES NOT AGREE WITH THE ONES IN THE ACTUAL VEHICLES.

HOWEVER, ON JOINT CONNECTOR (CAN1, 2, 3, 4), THE TERMINAL NUMBERS INDICATED ON THE CIRCUIT DIAGRAMS SHOULD ALWAYS AGREE WITH THE TERMINAL ARRANGEMENT IN THE ACTUAL VEHICLES.

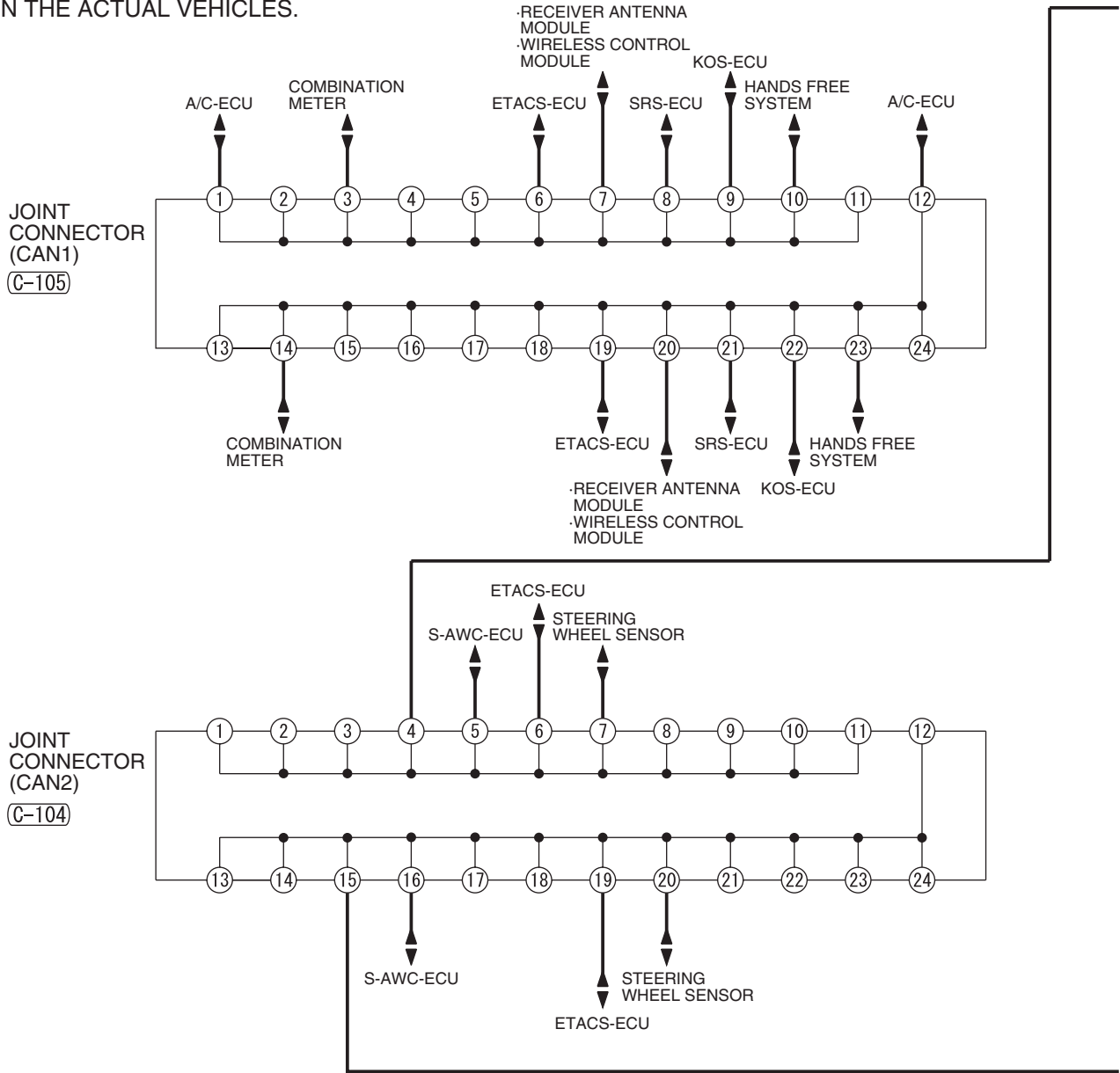

(A-14)

(C-104)

(C-105)

(C-127)

1	2	3	4	5	6	7	8	9	10	11		
12	13	14	15	16	17	18	19	20	21	22	23	24

1	2	3	4	5	6	7	8	9	10	11		
12	13	14	15	16	17	18	19	20	21	22	23	24

1	2	3	4	5	6	7	8	9	10	11		
12	13	14	15	16	17	18	19	20	21	22	23	24

1	2	3	4	5	6	7	8	9	10	11		
12	13	14	15	16	17	18	19	20	21	22	23	24

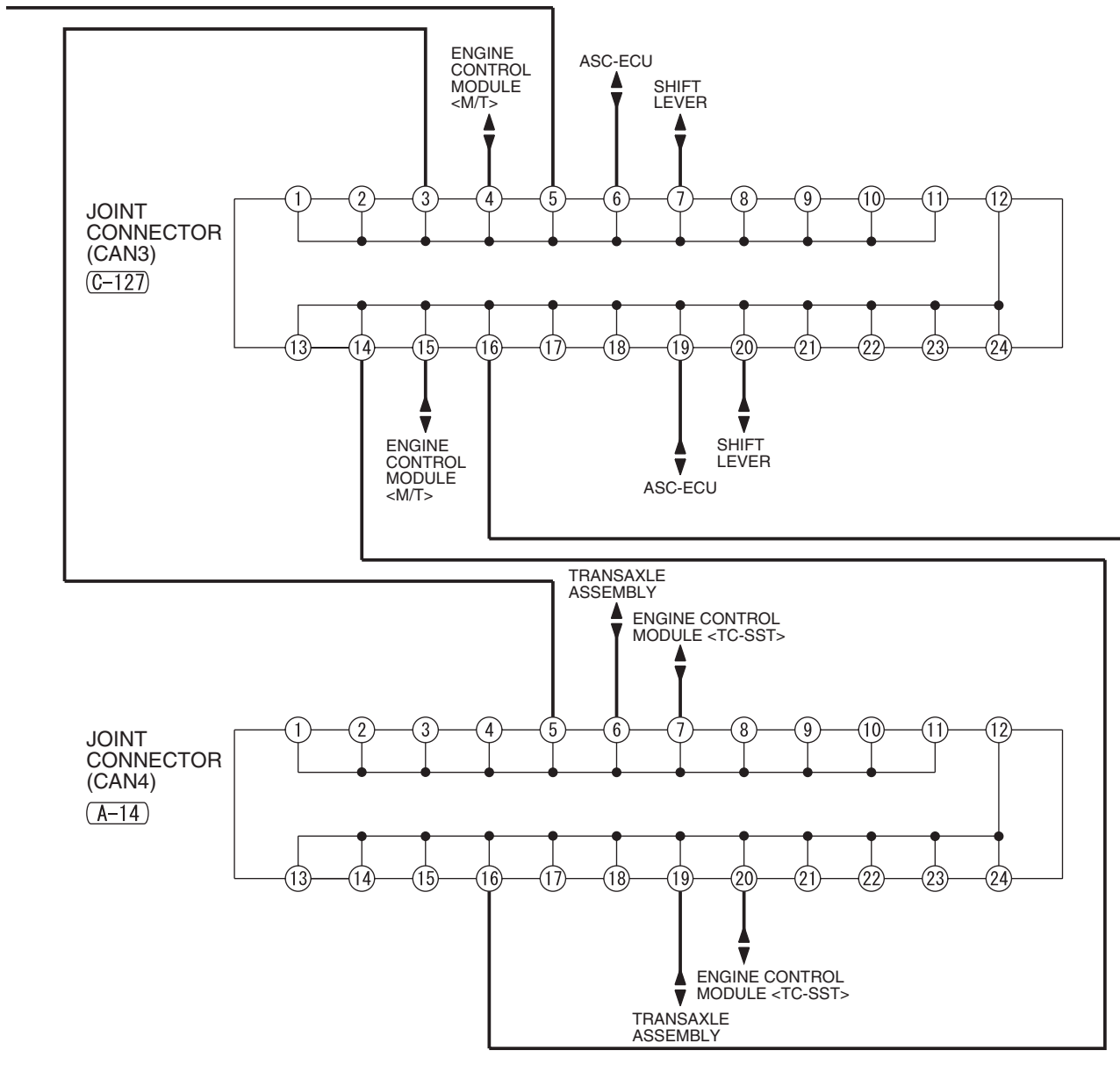

JOINT CONNECTOR (CONTINUED)

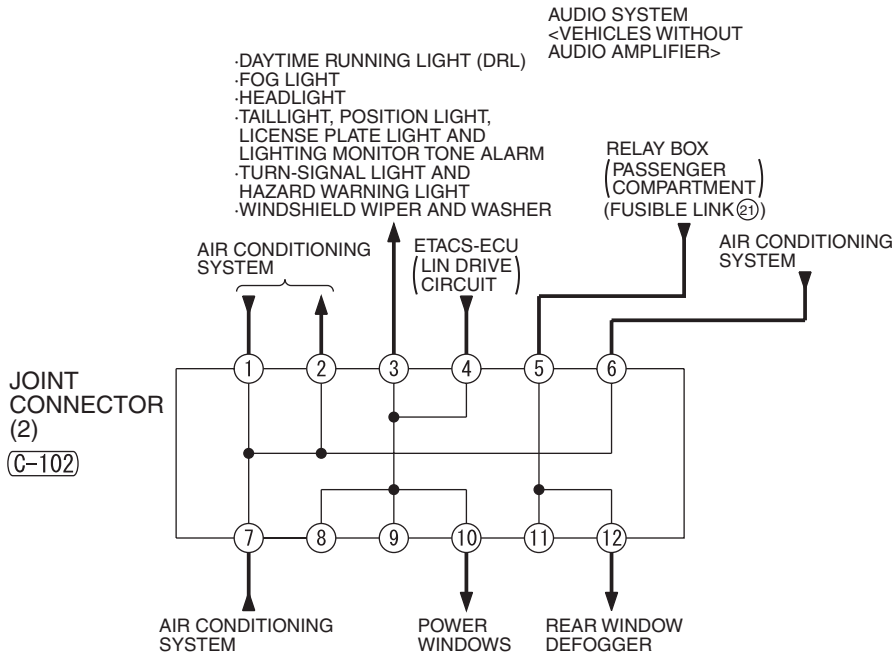
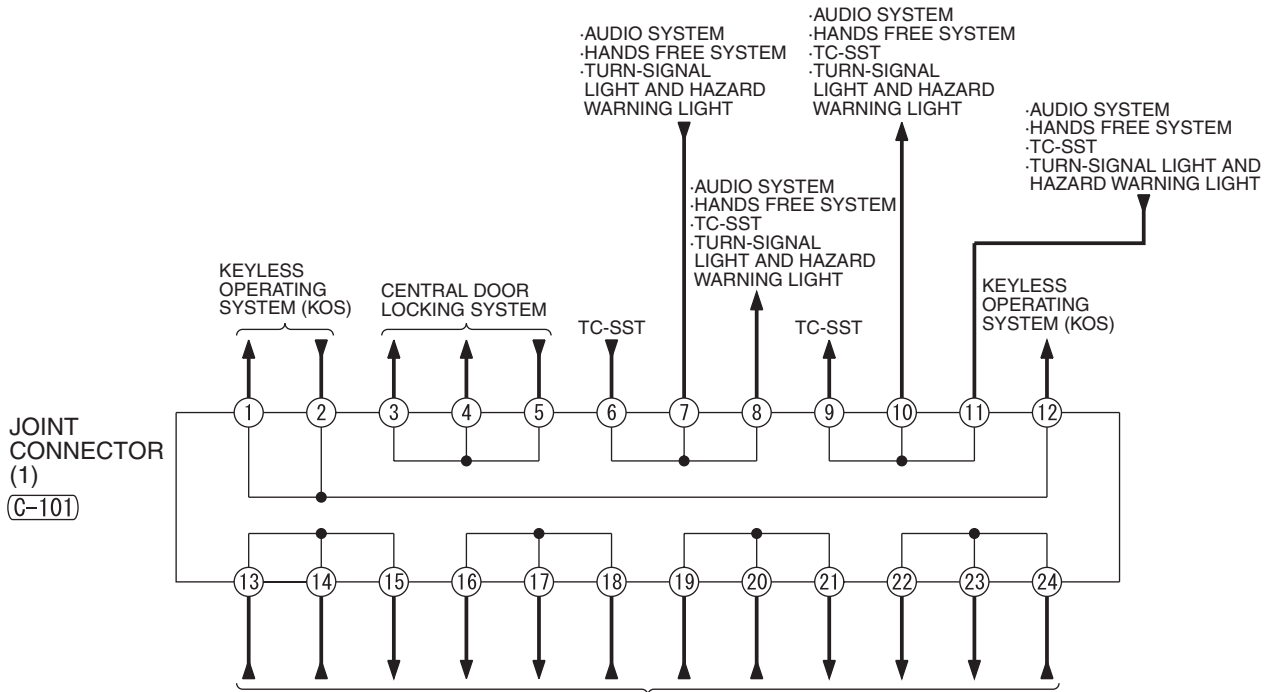

C-43

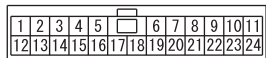

C-101

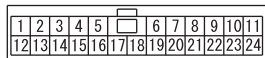

C-102

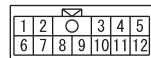

C-103

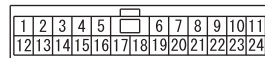

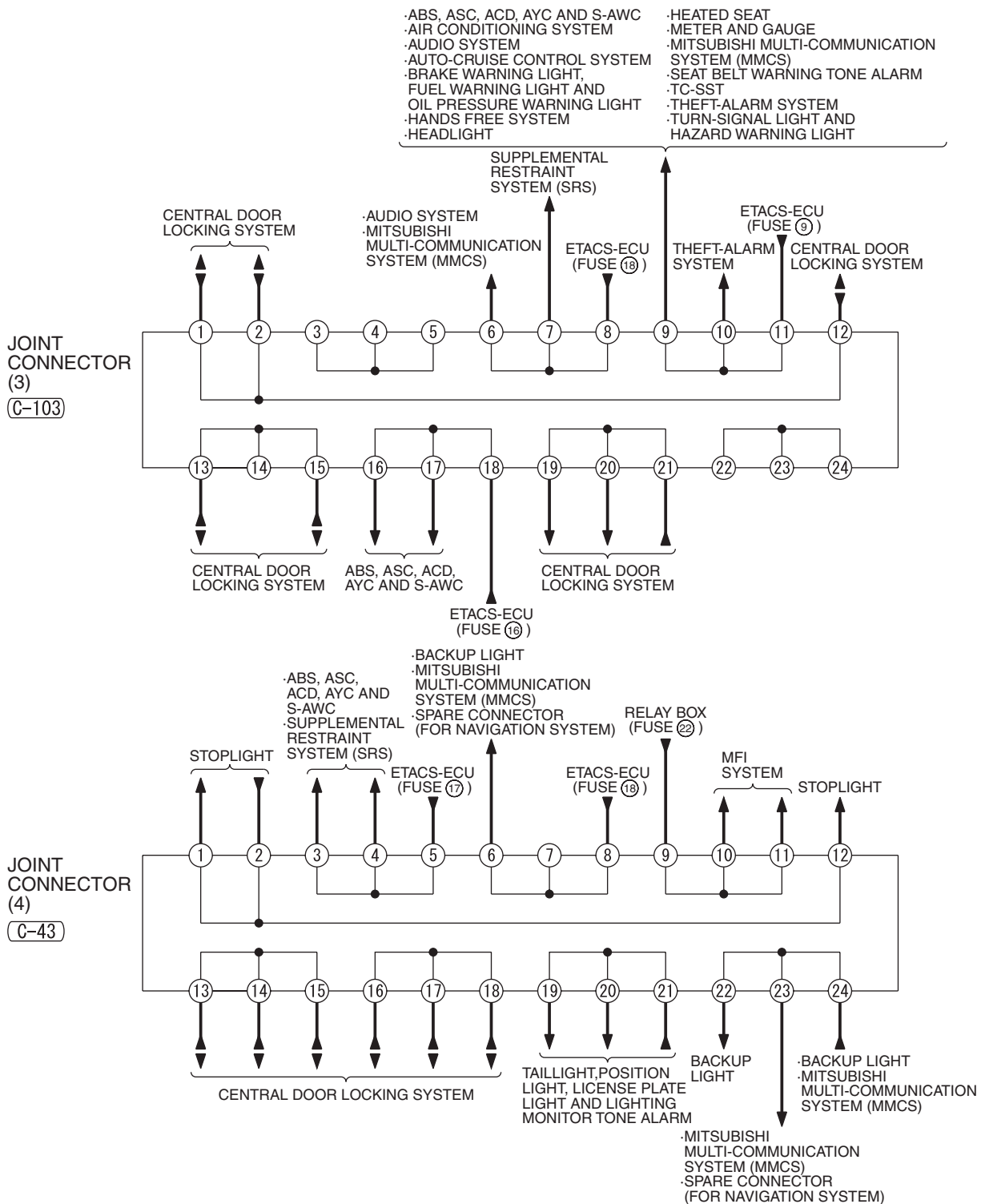

JOINT CONNECTOR (CONTINUED)

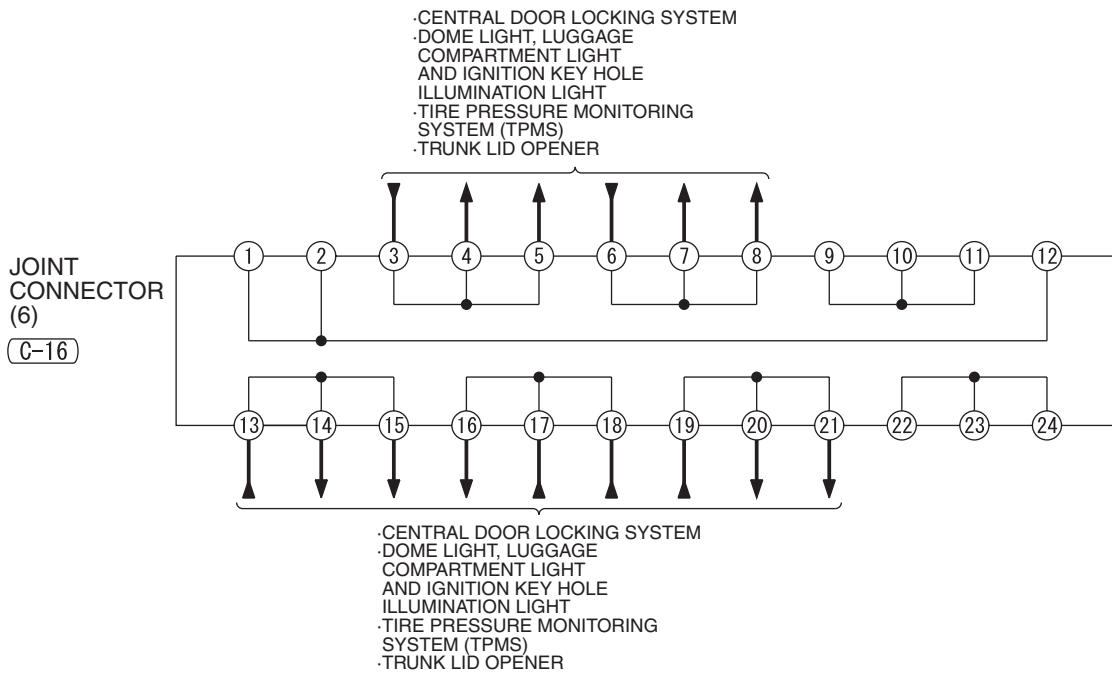
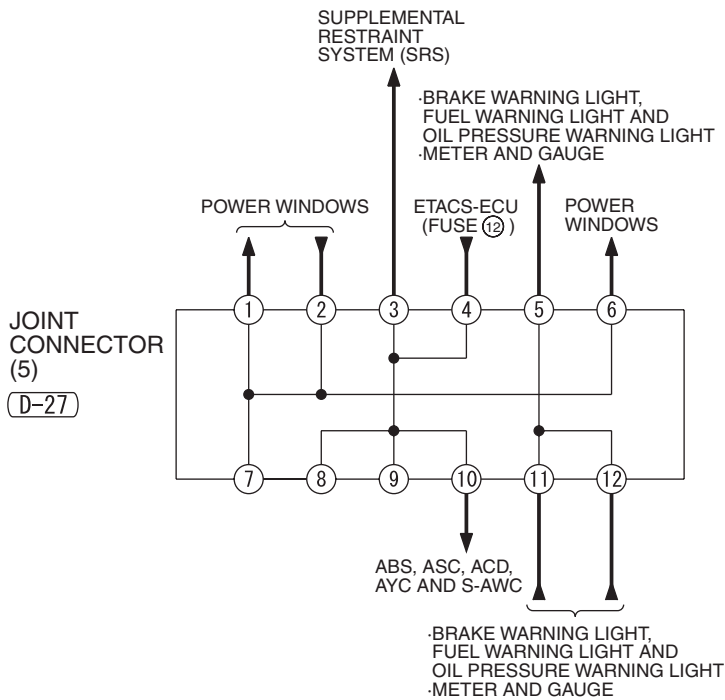

(C-16)

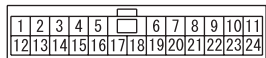

(C-50)

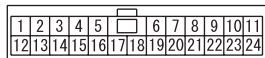

(D-27)

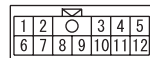

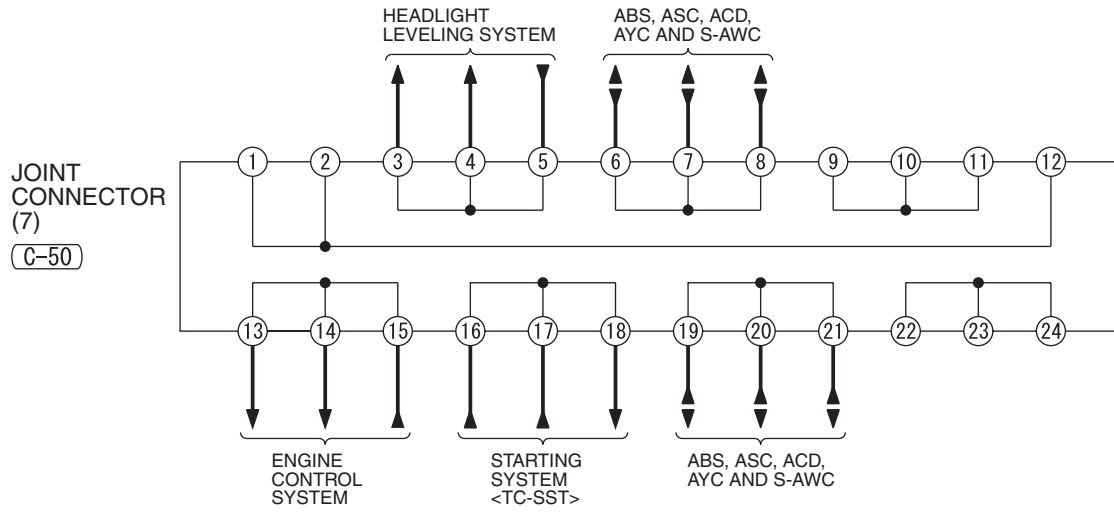

CENTRALIZED JUNCTION

M1901000302351

FUSIBLE LINK AND FUSE

ENGINE COMPARTMENT

No.	Power supply circuit	Name	Rated capacity (A)	Housing color	Load circuit
1	Fusible link No.36	Fuse	15	Blue	Fog light and fog light relay
2			7.5	Brown	Engine control module
3			20	Yellow	Shift lever <TC-SST> and transaxle assembly <TC-SST>
4			10	Red	Horn (Low, High) and horn relay
5			7.5	Brown	Generator
6			–	–	–
7			10	Red	A/C compressor clutch assembly and A/C compressor clutch relay
8			15	Blue	Engine control module
9			20	Yellow	Theft-alarm horn and theft-alarm horn relay
10			–	–	–
11			–	–	–
12			–	–	–
13			10	Red	Daytime running light relay and headlight assembly (LH, RH)
14	Headlight relay (High)		10	Red	Headlight assembly (LH)
15			10	Red	Headlight assembly (RH)
16	Headlight relay (Low)		20	Yellow	Headlight assembly (LH) <Discharge type>
17			20	Yellow	Headlight assembly (RH) <Discharge type>
18			10	Red	Headlight assembly (LH, RH) and headlight leveling switch
19			10	Red	Headlight assembly (RH) <Halogen type>

No.	Power supply circuit	Name	Rated capacity (A)	Housing color	Load circuit
20	MFI relay	Fuse	–	–	–
21			10	Red	Ignition coil Nos.1 to 4
22			20	Yellow	Engine control module, evaporative emission purge solenoid, exhaust oil feeder control valve, heated oxygen sensor (Front, rear), injector Nos.1 to 4, intake oil feeder control valve, mass airflow sensor, throttle actuator control motor relay and turbocharger wastegate solenoid No.1 and 2
23			20	Yellow	Fuel pump module, fuel pump relay 1 and fuel pump circuit resistor
24	Fusible link No.36	Fusible link	30	Pink	Starter
25			–	–	–
26			40	Green	ASC-ECU
27			30	Pink	ASC-ECU
28			30	Pink	Condenser fan motor, condenser fan relay and fan control relay
29			40	Green	Radiator fan motor and radiator fan relay
30		Fuse	30	Green	Fuse Nos.7 to 9 in passenger compartment
31			30	Green	Audio amplifier
32	MFI relay		–	–	–
33	Battery/Generator	Fusible link	140	–	Fusible link No.37/ Fusible link No.34 to 36
34	Battery/Fusible link No.33		80	–	ACC relay 3 in ETACS-ECU, fuse No.2, 4, 5, 10, 11, 12, 14, 15, 17, 18, 25 and fusible link No.20 in passenger compartment and ETACS-ECU
35			80	–	Electric pump
36			120	–	Fuse No.1 to 5, 7 to 9, 13 to 23, 30, 31 and fusible link No.24, 26 to 29 in engine compartment, MFI relay and headlight relay (High, Low)
37	Fusible link No.33/ Generator		80	–	ACC relay 2 in ETACS-ECU, fusible link No.1 and 21, Fuse No. 3, 6, 13, 16 in passenger compartment, ETACS-ECU and blower relay

Relay box in engine compartment

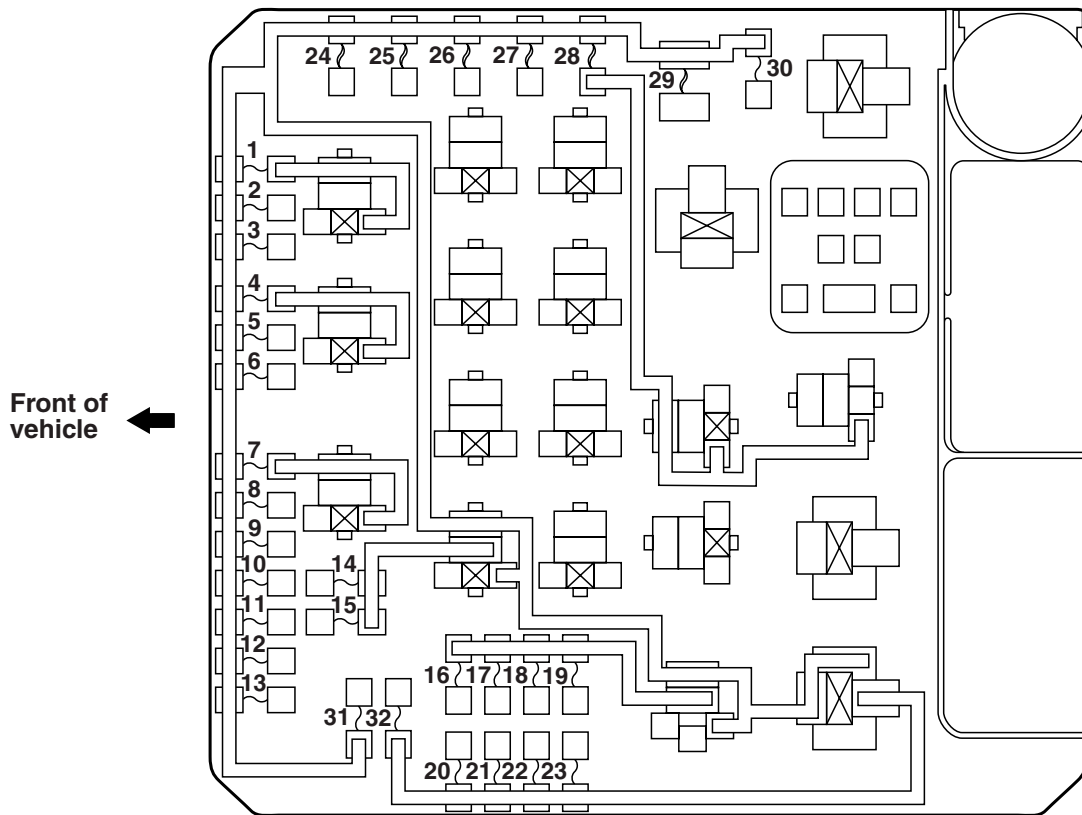

AC609168AT

Fusible link box in engine compartment

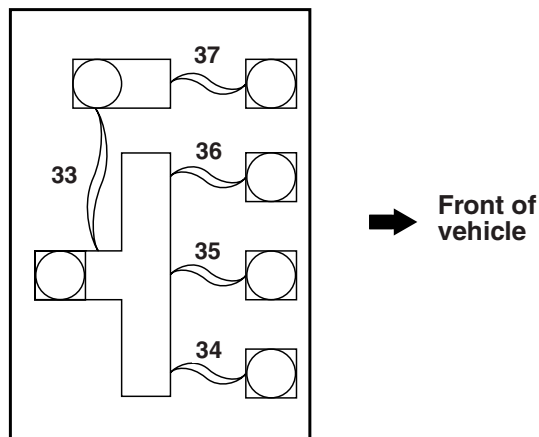

AC506810AJ

PASSENGER COMPARTMENT

No.	Power supply circuit	Name	Rated capacity (A)	Housing color	Load circuit
1	Fusible link No.37	Fusible link	30	Pink	Blower motor
2	Fusible link No.34	Fuse	15	Blue	ETACS-ECU, high-mounted stoplight, rear combination light (LH, RH) and shift lever <TC-SST>
3	Fusible link No.37		10	Red	–
4	ETACS-ECU (ACC relay 3)		30	Green	Windshield wiper automatic stop relay, windshield wiper motor and windshield wiper speed switching relay in ETACS-ECU, washer motor and windshield washer relay
5	Fusible link No.34		10	Red	Data link connector
6	Fusible link No.37		20	Yellow	Door lock relay, driver's door unlock relay, passenger's door unlock relay and trunk lid open relay in ETACS-ECU, front door lock actuator (LH, RH), rear door lock actuator (LH, RH) and trunk lid latch
7	Fusible link No.30		15	Blue	CAN box unit, center panel unit, hands free module, multivision display, radio/CD player, satellite radio tuner and spare connector (for navigation unit)
8			7.5	Brown	Power window relay in ETACS-ECU, A/C-ECU, column switch, combination meter, ETACS-ECU, key reminder switch <Vehicles with KOS>, KOS-ECU, lighting control sensor, S-AWC-ECU and wireless control module
9			15	Blue	Center panel unit, combination meter and key reminder switch <Vehicles without KOS>
10	Fusible link No.34		15	Blue	ETACS-ECU
11	ETACS-ECU (ACC relay 3)		15	Blue	–

No.	Power supply circuit	Name	Rated capacity (A)	Housing color	Load circuit	
12	ETACS-ECU (IG1 relay)		7.5	Brown	A/C-ECU, A/C control panel, center panel unit, column switch, combination meter, heated seat relay, KOS-ECU, rear window defogger relay, receiver antenna module <Vehicles with KOS>, S-AWC-ECU, shift lever <TC-SST>, SRS-ECU, steering wheel sensor, sunroof motor assembly, transaxle assembly <TC-SST> and wireless control module <Vehicles without KOS>	
13	ETACS-ECU (ACC relay 2)		15	Blue	Accessory socket and cigarette lighter	
14	Fusible link No.34		10	Red	Fuel pump relay 2, IG1 relay, power window relay in ETACS-ECU, ETACS-ECU, engine control module and injector relay	
15			20	Yellow	Sunroof motor assembly	
16			ETACS-ECU (ACC relay 2)	10	Red	CAN box unit, multivision display, radio/CD player, door mirror assembly (LH, RH) and shift lever <TC-SST>
17	Fusible link No.34		10	Red	ASC-ECU, front seat assembly (LH) and S-AWC-ECU	
18	ETACS-ECU (IG1 relay)		7.5	Brown	Backup light (LH, RH), ETACS-ECU, multivision display, shift lever <TC-SST>, spare connector (for navigation unit) and SRS-ECU	
19	Fusible link No.37		15	Blue	–	
20	Fusible link No.34		Fusible link	30	Pink	Front power window sub switch, power window main switch and rear power window motor (LH, RH)
21	Fusible link No.37			30	Pink	Rear window defogger
22	–	Fuse	–	–	–	
23	Fusible link No.34		–	–	–	
24			–	–	–	
25			30	Green	Heated seat assembly (LH, RH) and heated seat switch	

Fuse box in ETACS-ECU

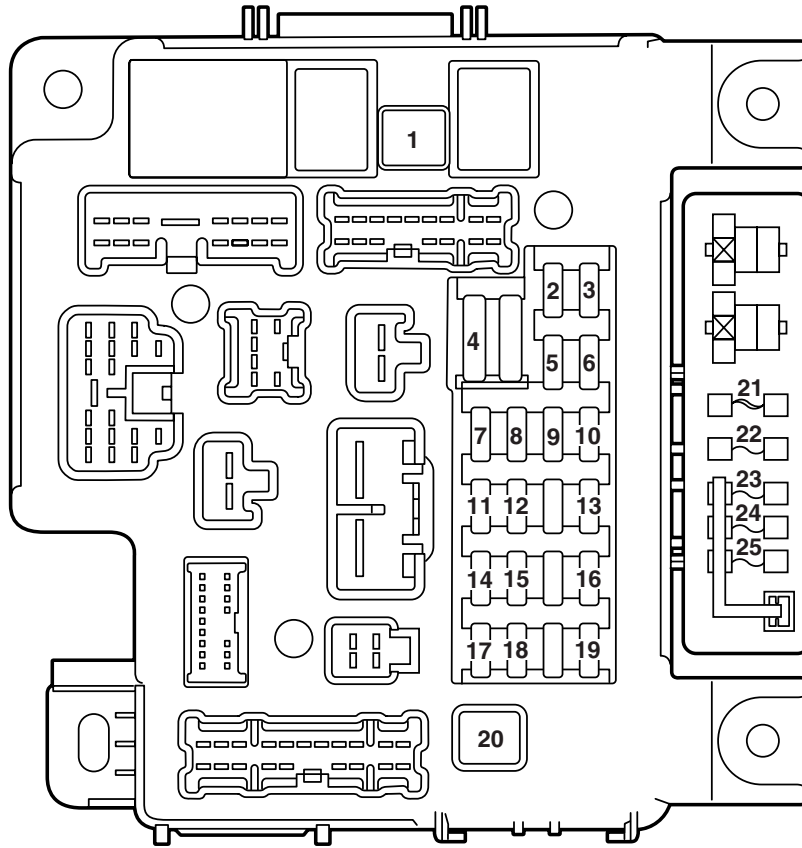

AC607380AC

CENTRALIZED RELAY

Connector No.	Name	Connector No.	Name
A-15X	Fog light relay	A-27X	Fuel pump relay 1
A-16X	Horn relay	A-28X	Starter relay
A-17X	A/C compressor clutch relay	A-29X	Headlight relay (Low)
A-18X	Theft-alarm horn relay	A-30X	–
A-19X	–	A-31X	–
A-20X	No connection	A-32X	–
A-21X	Headlight relay (High)	A-33X	–
A-22X	Throttle actuator control motor relay	A-34X	MFI relay
A-23X	–	A-35X	Radiator fan relay
A-24X	Daytime running light relay	A-36X	Condenser fan relay
A-25X	Injector relay	A-37X	Fan control relay
A-26X	Electric pump relay		

Relay box in engine compartment

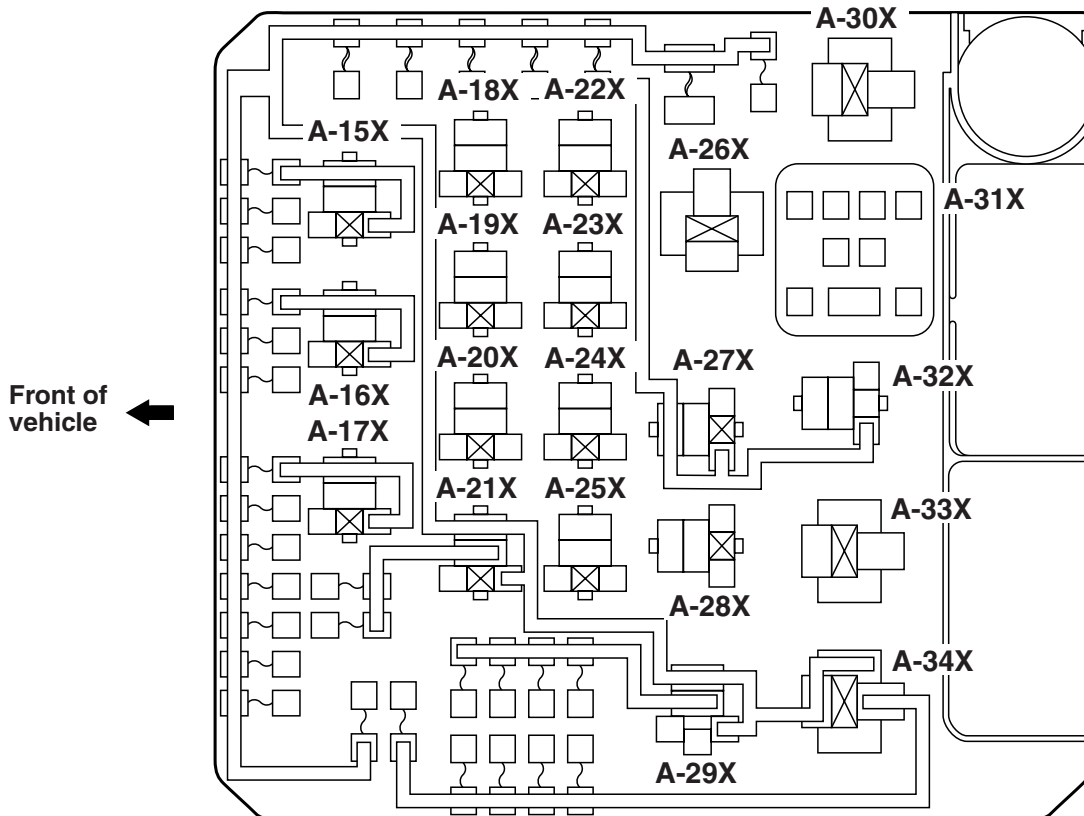

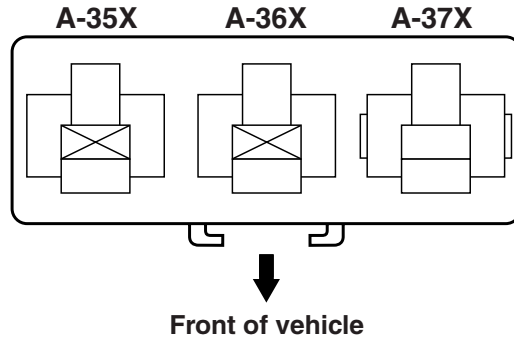

AC706168AC

POWER DISTRIBUTION SYSTEM

M1901000403298

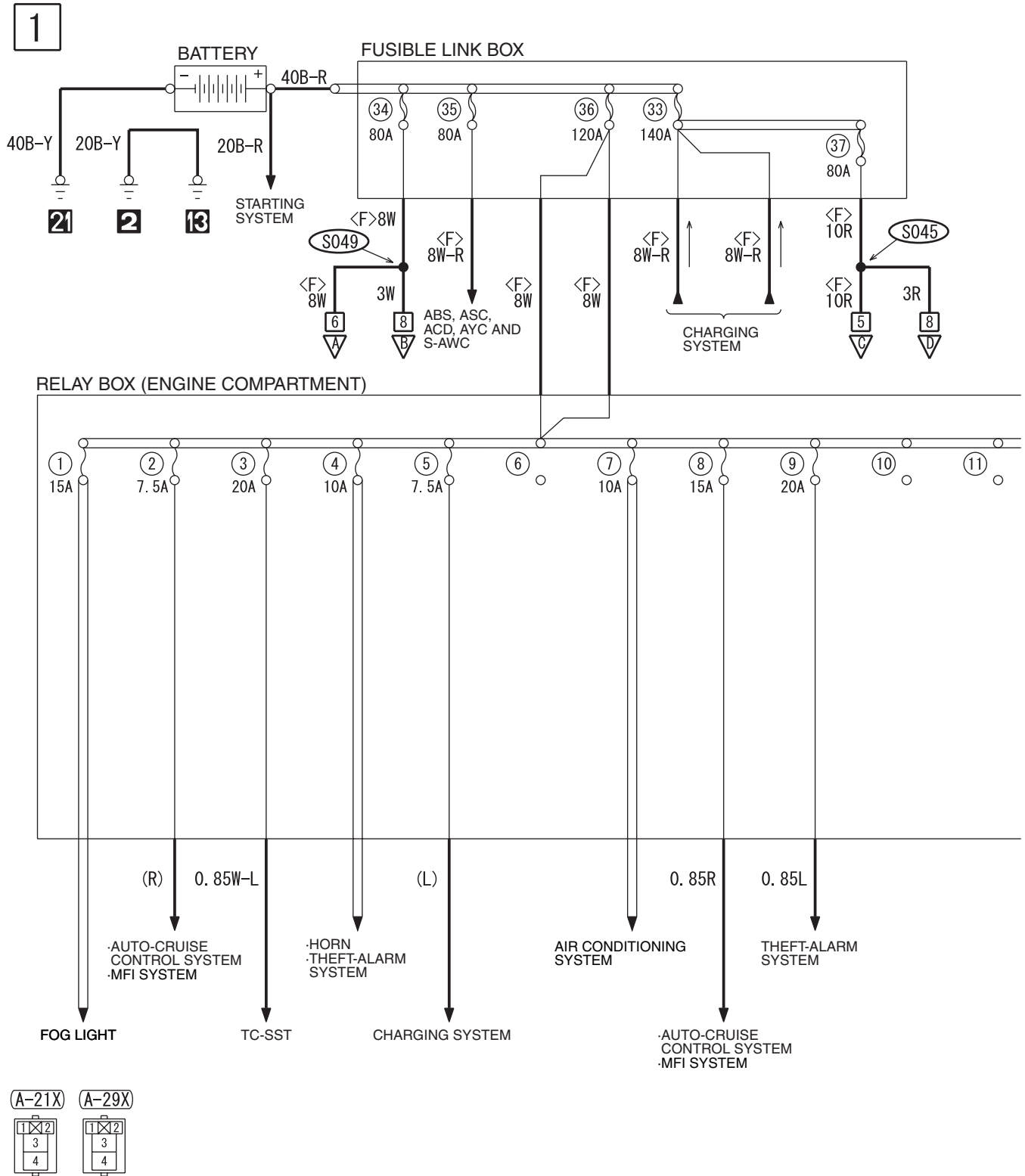

H8G01M02AA

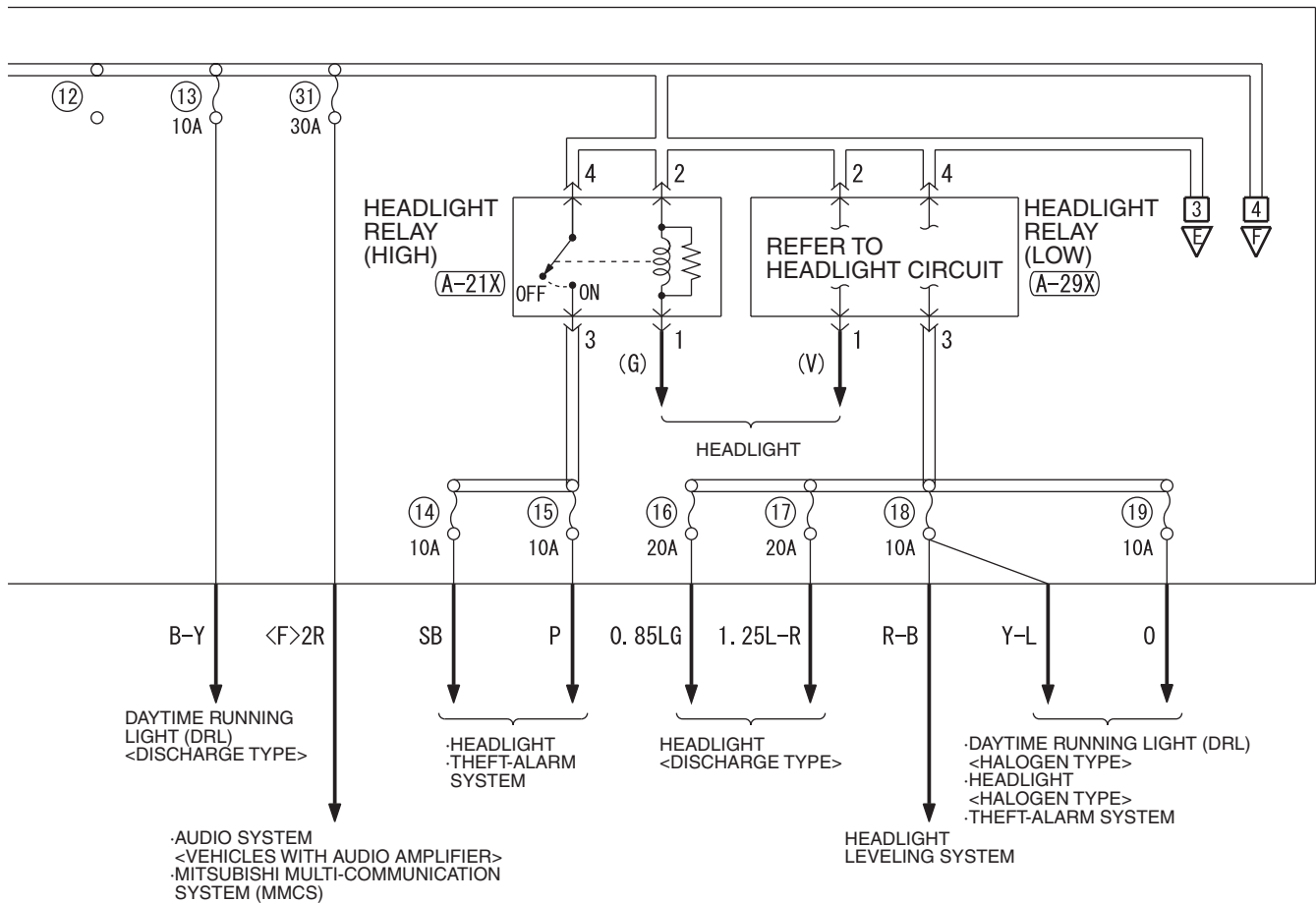

WIRE COLOR CODE

B: BLACK LG: LIGHT GREEN G: GREEN L: BLUE W: WHITE Y: YELLOW SB: SKY BLUE
BR: BROWN O: ORANGE GR: GRAY R: RED P: PINK V: VIOLET PU: PURPLE SI: SILVER

H8G01M02AB

POWER DISTRIBUTION SYSTEM (CONTINUED)

3

RELAY BOX (ENGINE COMPARTMENT)

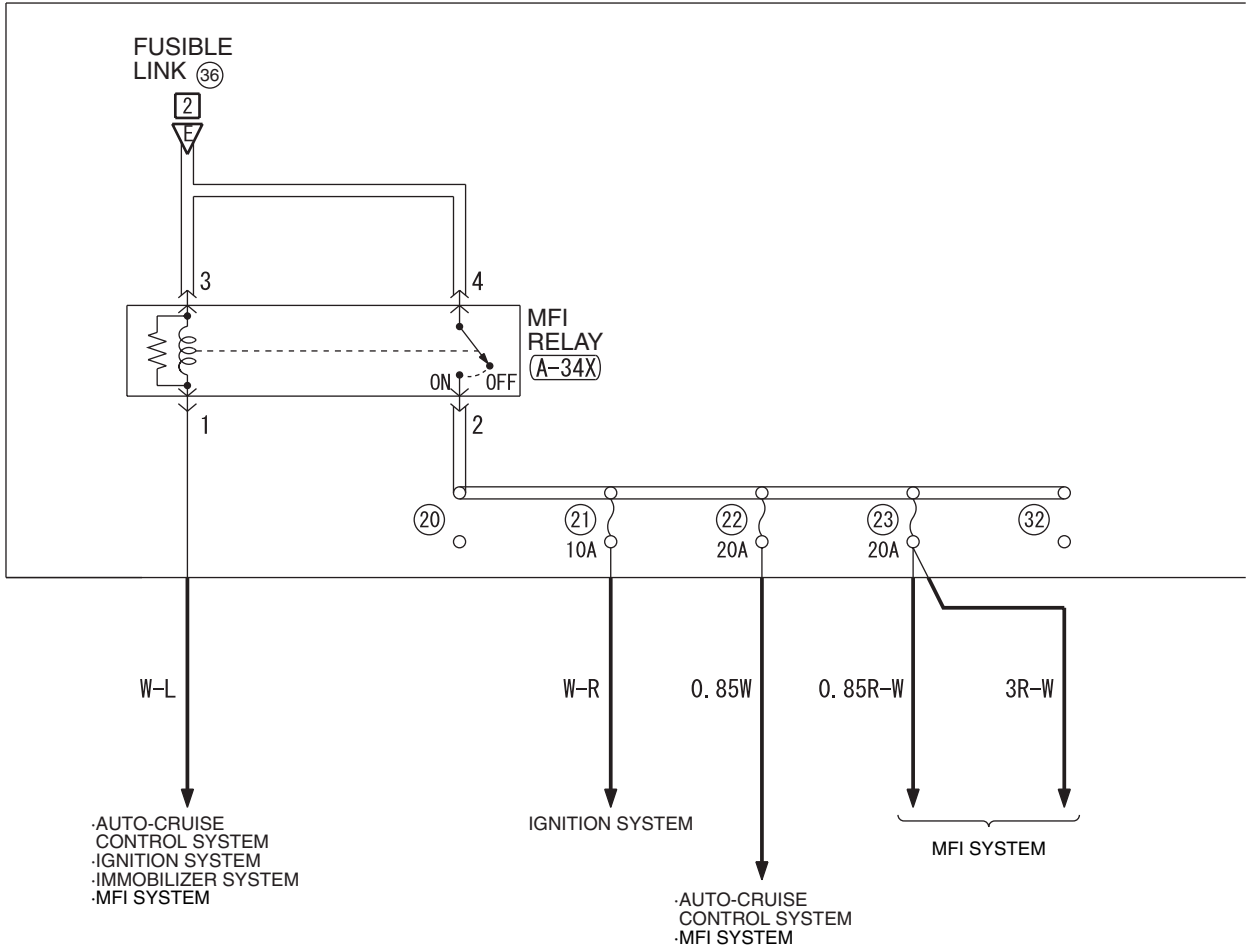

(A-34X)



4

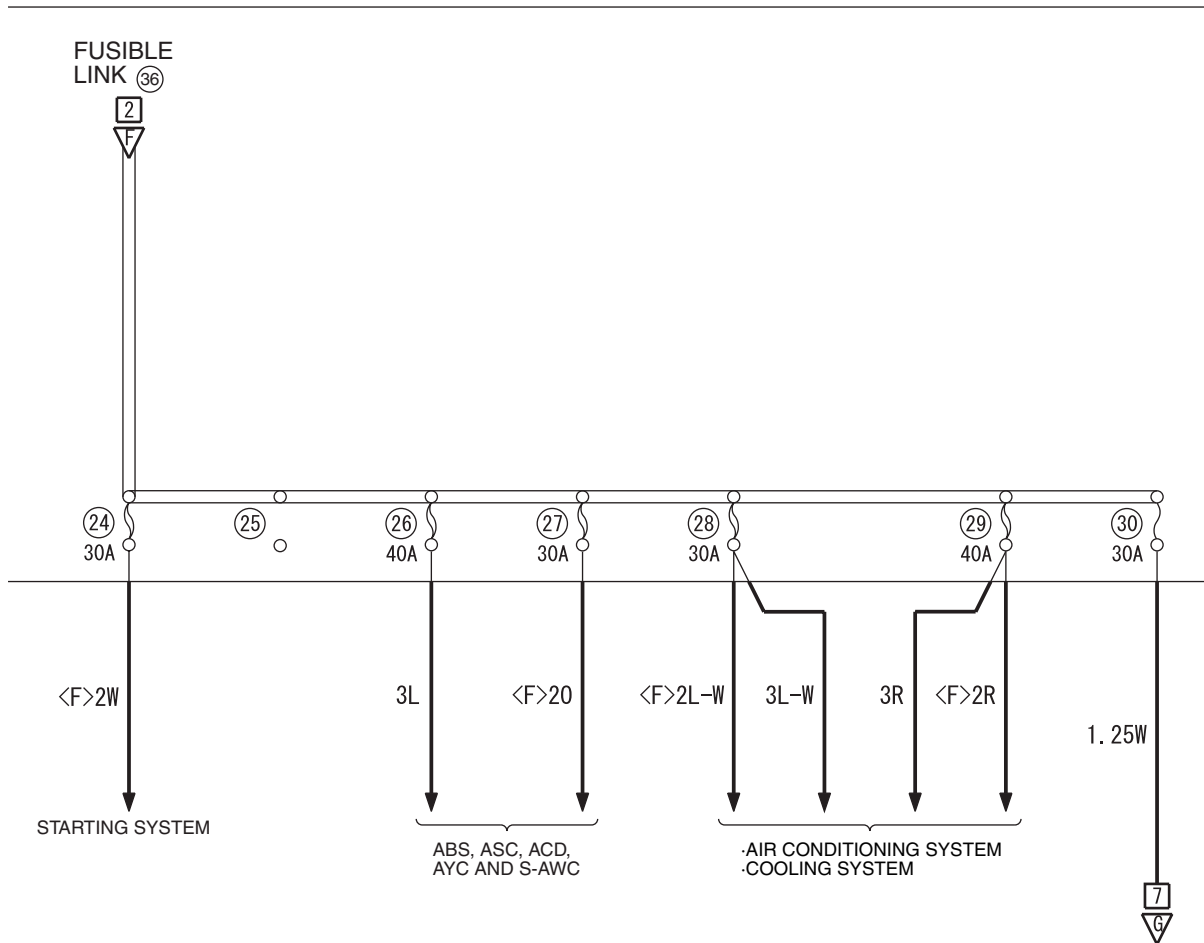

WIRE COLOR CODE

B: BLACK LG: LIGHT GREEN G: GREEN L: BLUE W: WHITE Y: YELLOW SB: SKY BLUE
BR: BROWN O: ORANGE GR: GRAY R: RED P: PINK V: VIOLET PU: PURPLE SI: SILVER

H8G01M02BB

TSB Revision

POWER DISTRIBUTION SYSTEM (CONTINUED)

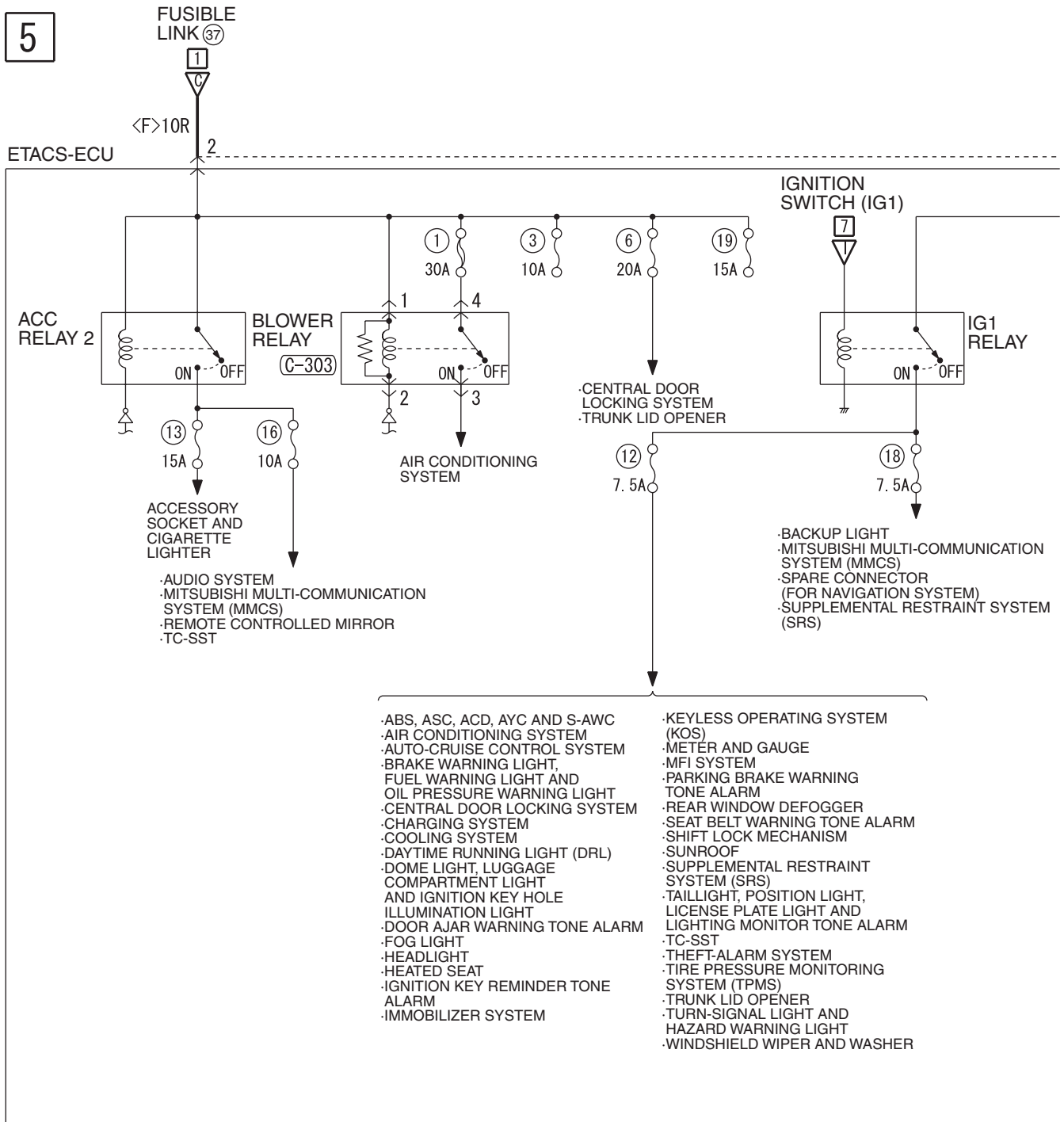

- ABS, ASC, ACD, AYC AND S-AWC
- AIR CONDITIONING SYSTEM
- AUTO-CRUISE CONTROL SYSTEM
- BRAKE WARNING LIGHT, FUEL WARNING LIGHT AND OIL PRESSURE WARNING LIGHT
- CENTRAL DOOR LOCKING SYSTEM
- CHARGING SYSTEM
- COOLING SYSTEM
- DAYTIME RUNNING LIGHT (DRL)
- DOME LIGHT, LUGGAGE COMPARTMENT LIGHT AND IGNITION KEY HOLE ILLUMINATION LIGHT
- DOOR AJAR WARNING TONE ALARM
- FOG LIGHT
- HEADLIGHT
- HEATED SEAT
- IGNITION KEY REMINDER TONE ALARM
- IMMOBILIZER SYSTEM
- KEYLESS OPERATING SYSTEM (KOS)
- METER AND GAUGE
- MFI SYSTEM
- PARKING BRAKE WARNING TONE ALARM
- REAR WINDOW DEFOGGER
- SEAT BELT WARNING TONE ALARM
- SHIFT LOCK MECHANISM
- SUNROOF
- SUPPLEMENTAL RESTRAINT SYSTEM (SRS)
- TAILLIGHT, POSITION LIGHT, LICENSE PLATE LIGHT AND LIGHTING MONITOR TONE ALARM
- TC-SST
- THEFT-ALARM SYSTEM
- TIRE PRESSURE MONITORING SYSTEM (TPMS)
- TRUNK LID OPENER
- TURN-SIGNAL LIGHT AND HAZARD WARNING LIGHT
- WINDSHIELD WIPER AND WASHER

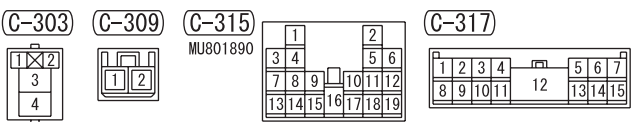

6

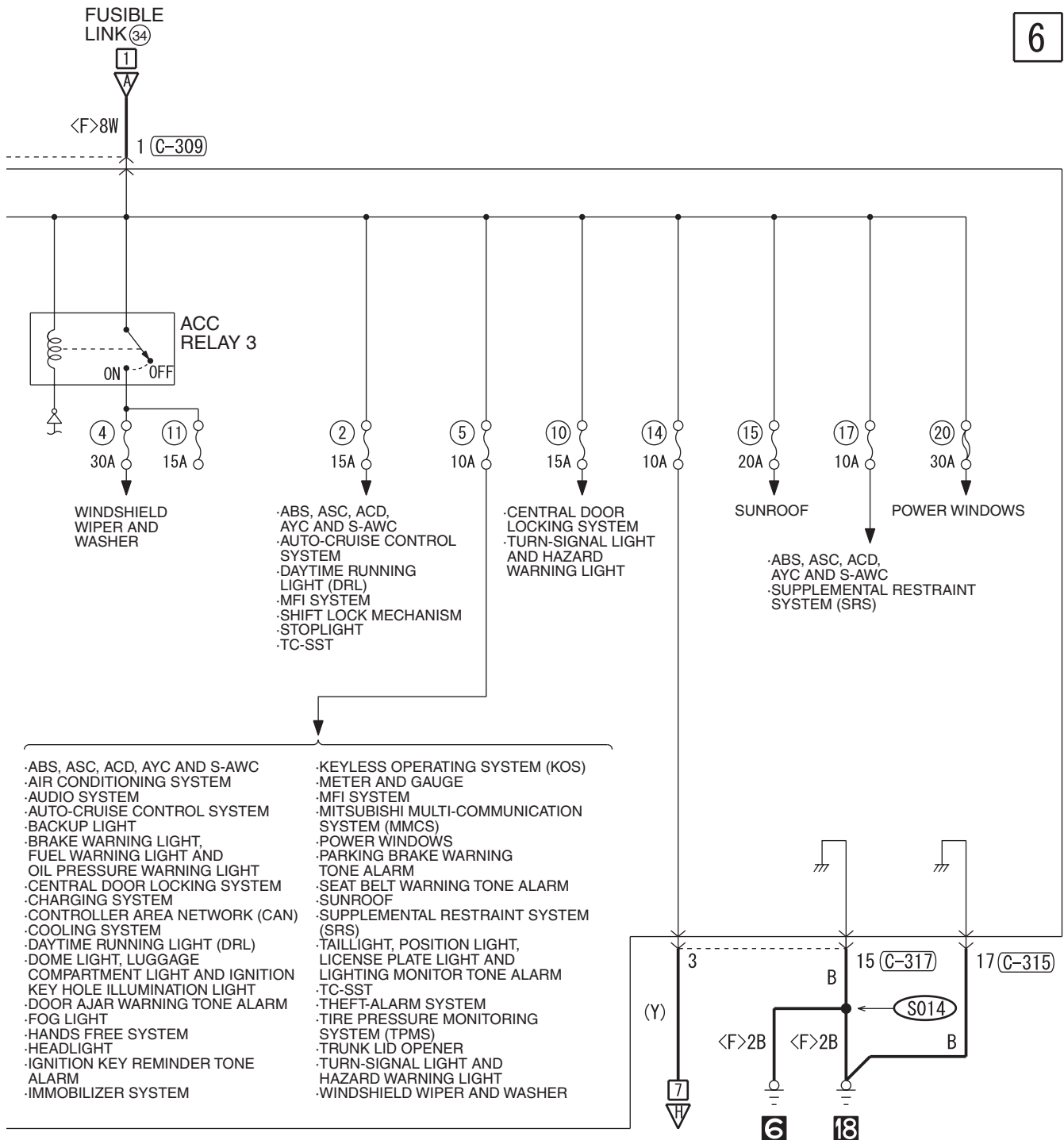

WIRE COLOR CODE

B : BLACK LG : LIGHT GREEN G : GREEN L : BLUE W : WHITE Y : YELLOW SB : SKY BLUE
BR : BROWN O : ORANGE GR : GRAY R : RED P : PINK V : VIOLET PU : PURPLE SI : SILVER

POWER DISTRIBUTION SYSTEM (CONTINUED)

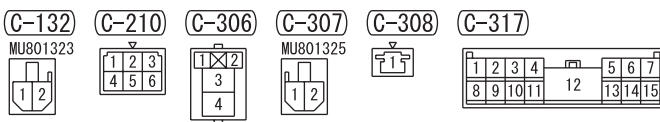
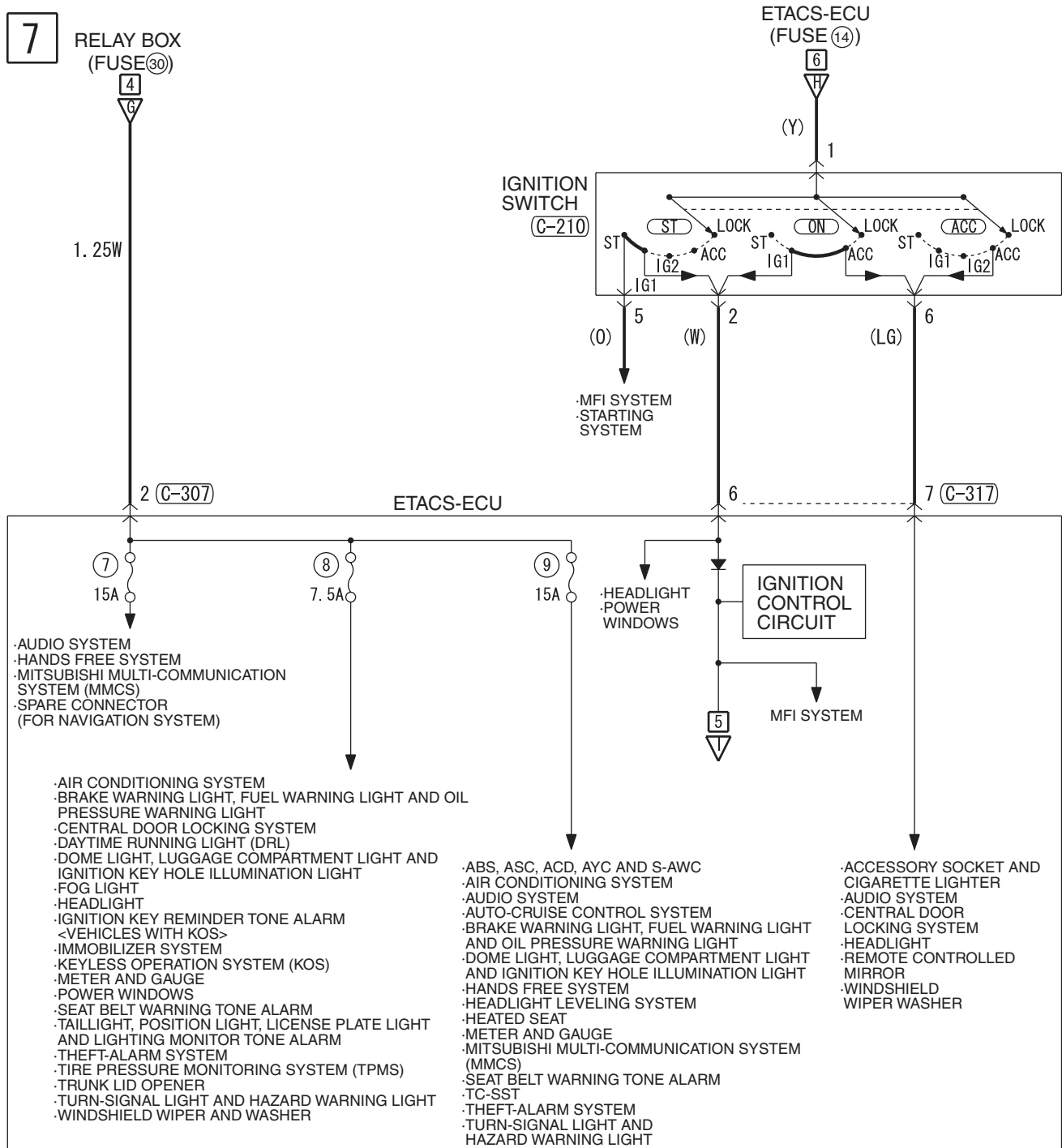

8

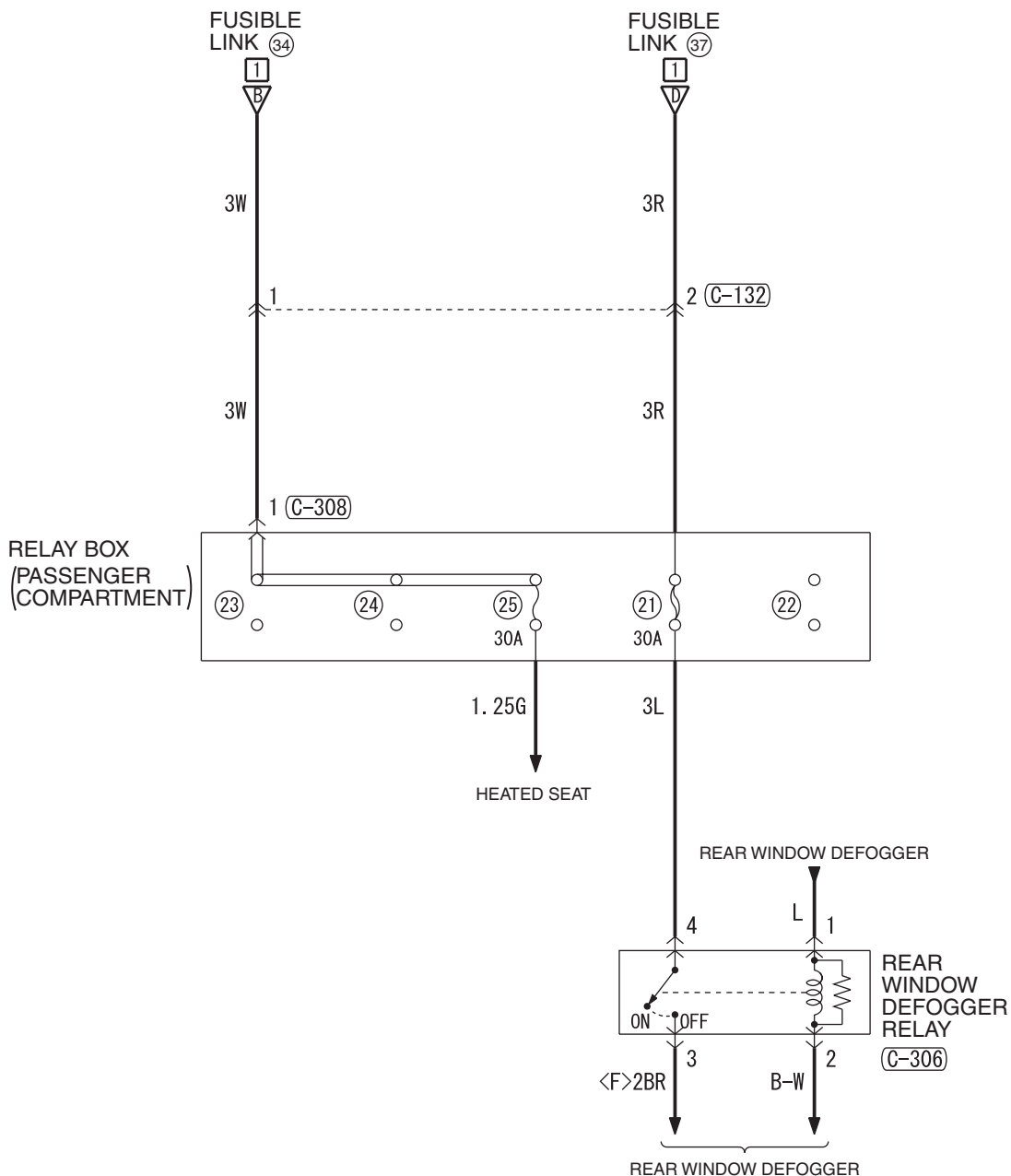

WIRE COLOR CODE

B : BLACK LG : LIGHT GREEN G : GREEN L : BLUE W : WHITE Y : YELLOW SB : SKY BLUE
 BR : BROWN O : ORANGE GR : GRAY R : RED P : PINK V : VIOLET PU : PURPLE SI : SILVER

H8G01M02DB

TSB Revision

STARTING SYSTEM <M/T>

M1901000503671

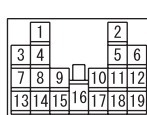
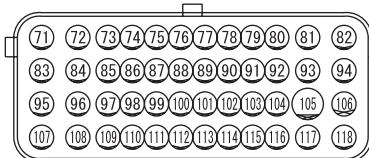
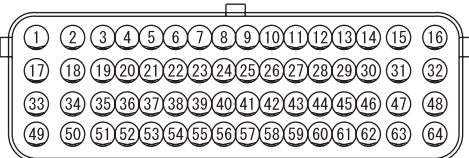
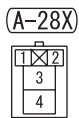
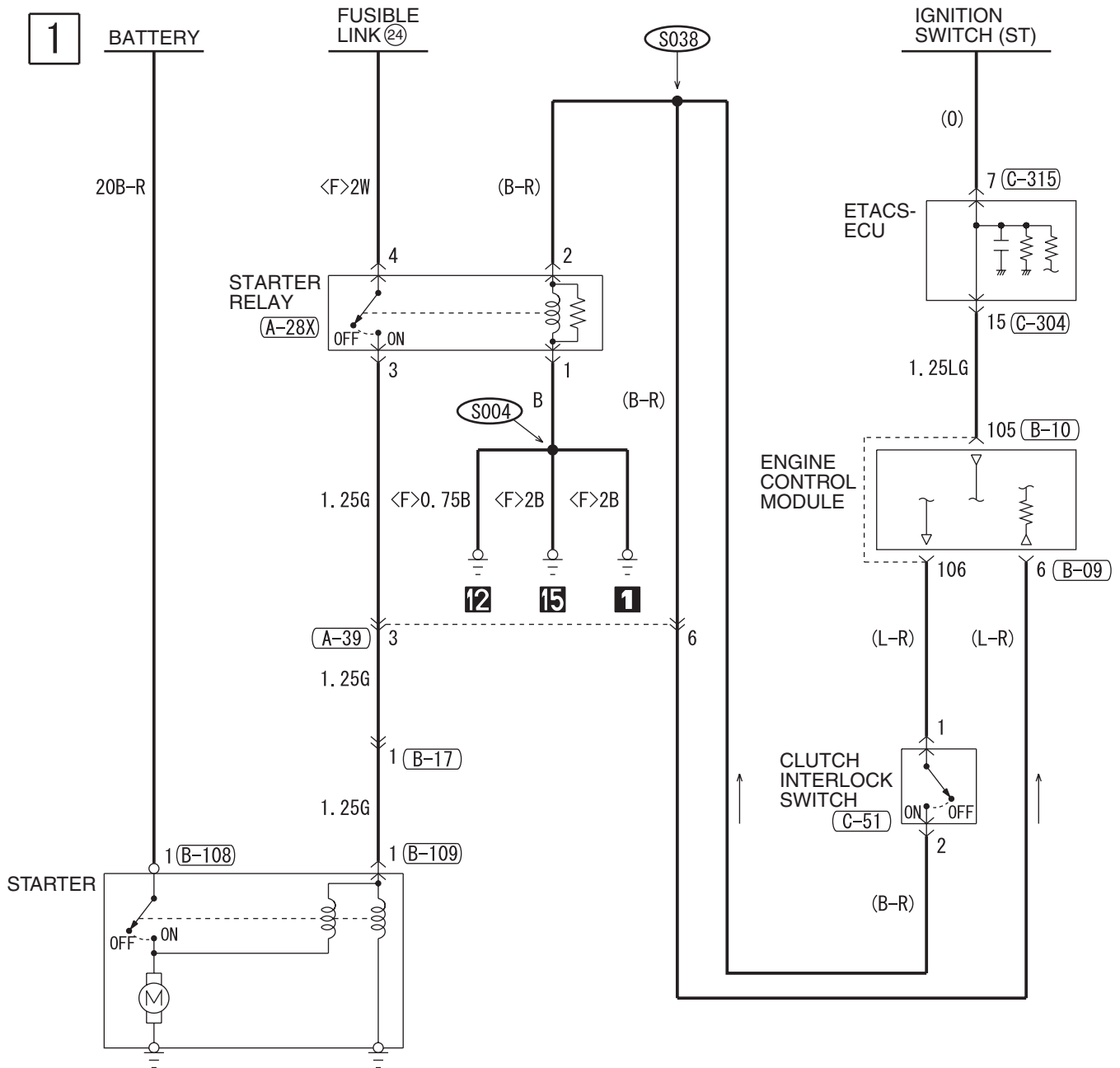

H8G02M03AA

NOTES

STARTING SYSTEM <TC-SST>

M1901000503682

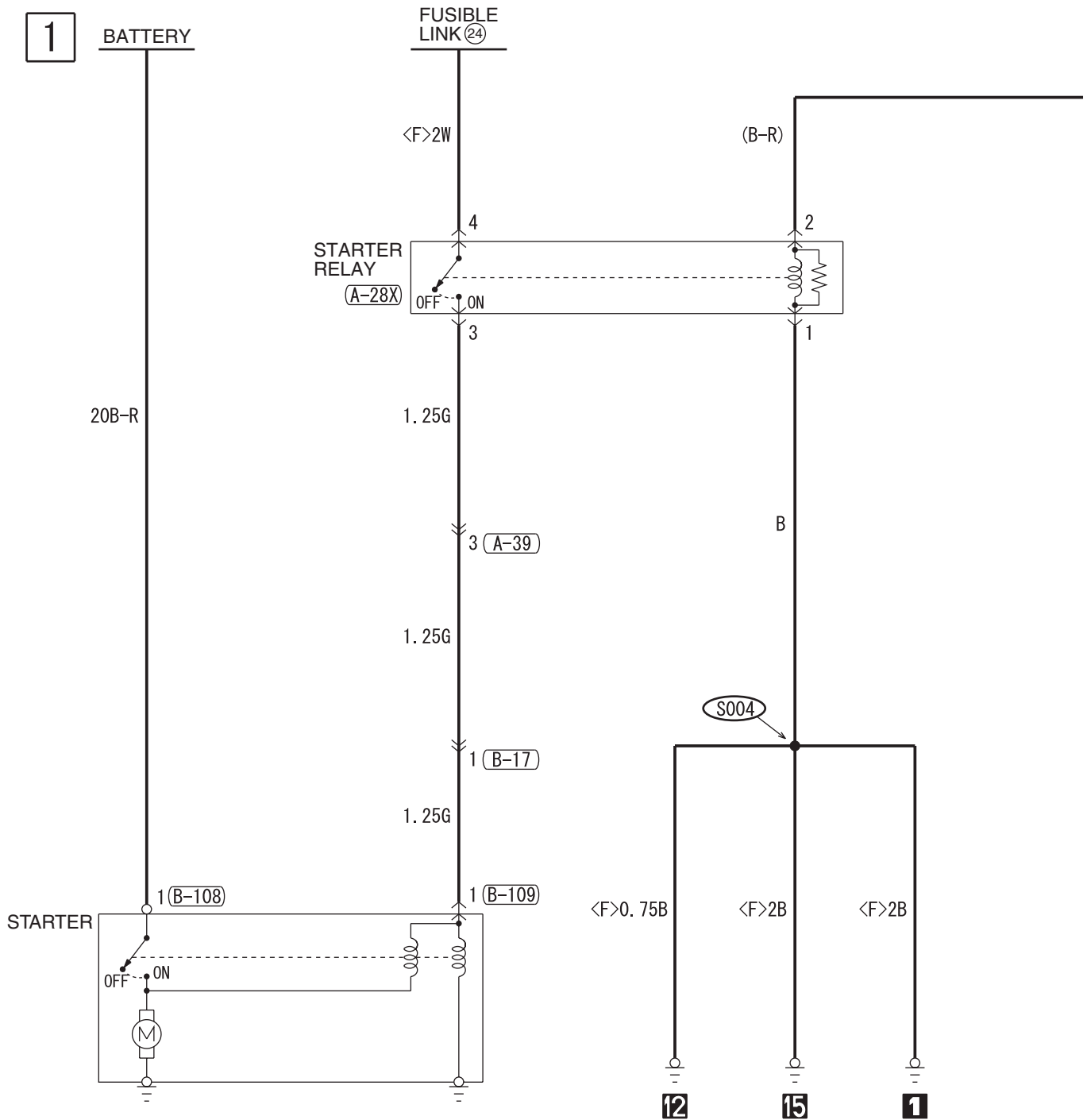

(A-28X)

(A-39)

(B-09)

(B-10)

(B-17)

(B-108)

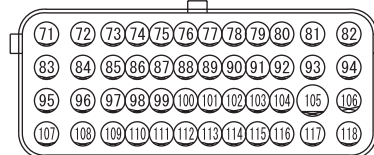
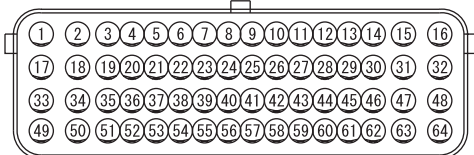

H8G02M04AA

2

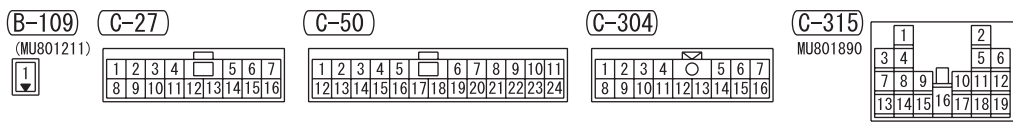
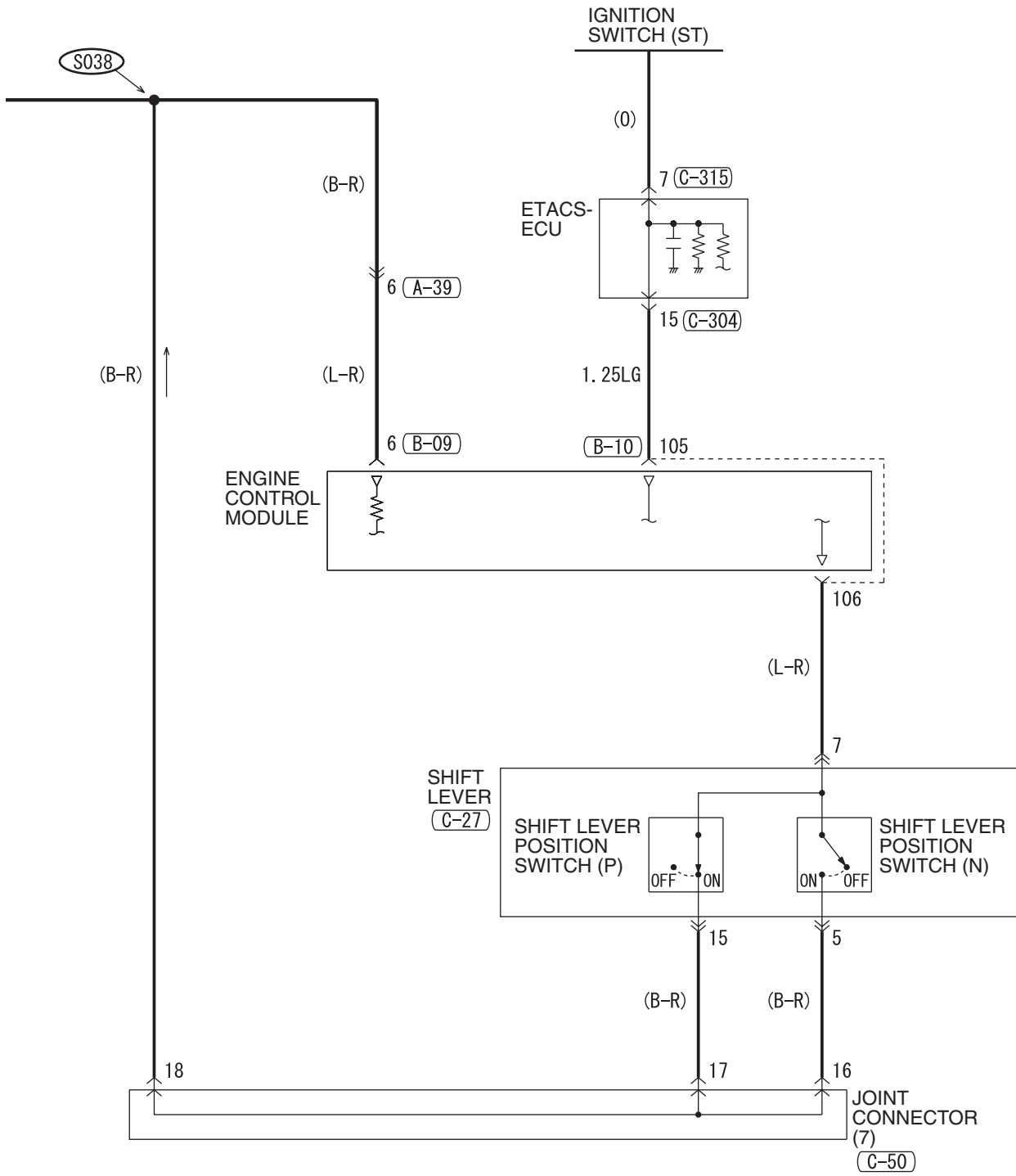

WIRE COLOR CODE
 B : BLACK LG : LIGHT GREEN G : GREEN L : BLUE W : WHITE Y : YELLOW SB : SKY BLUE
 BR : BROWN O : ORANGE GR : GRAY R : RED P : PINK V : VIOLET PU : PURPLE SI : SILVER

H8G02M04AB

TSB Revision

IGNITION SYSTEM

1

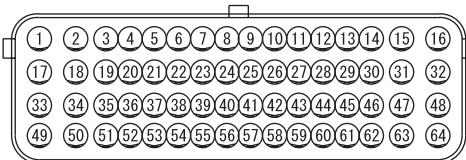
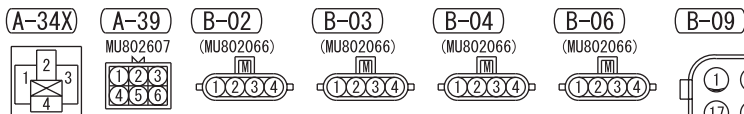
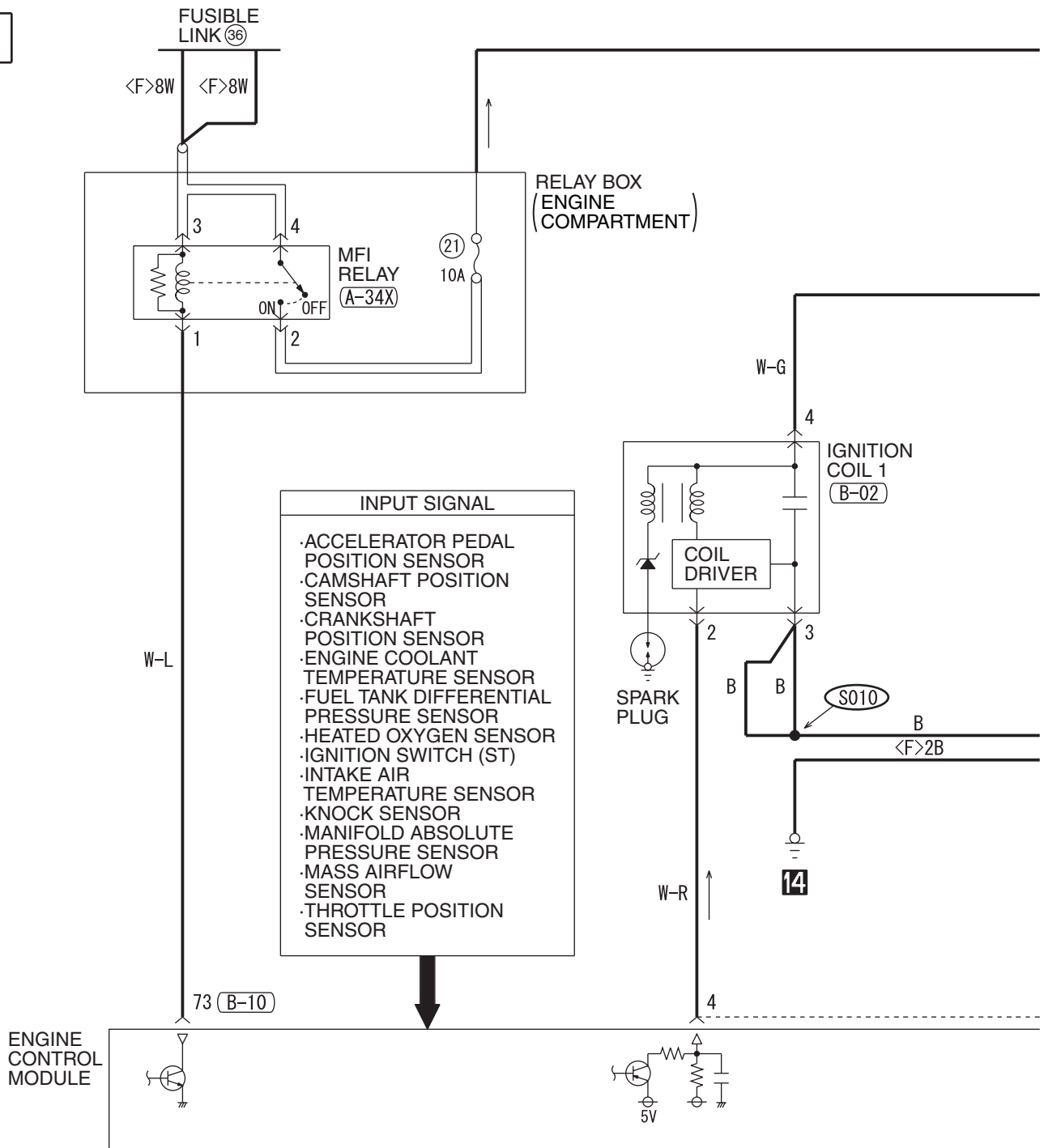

2

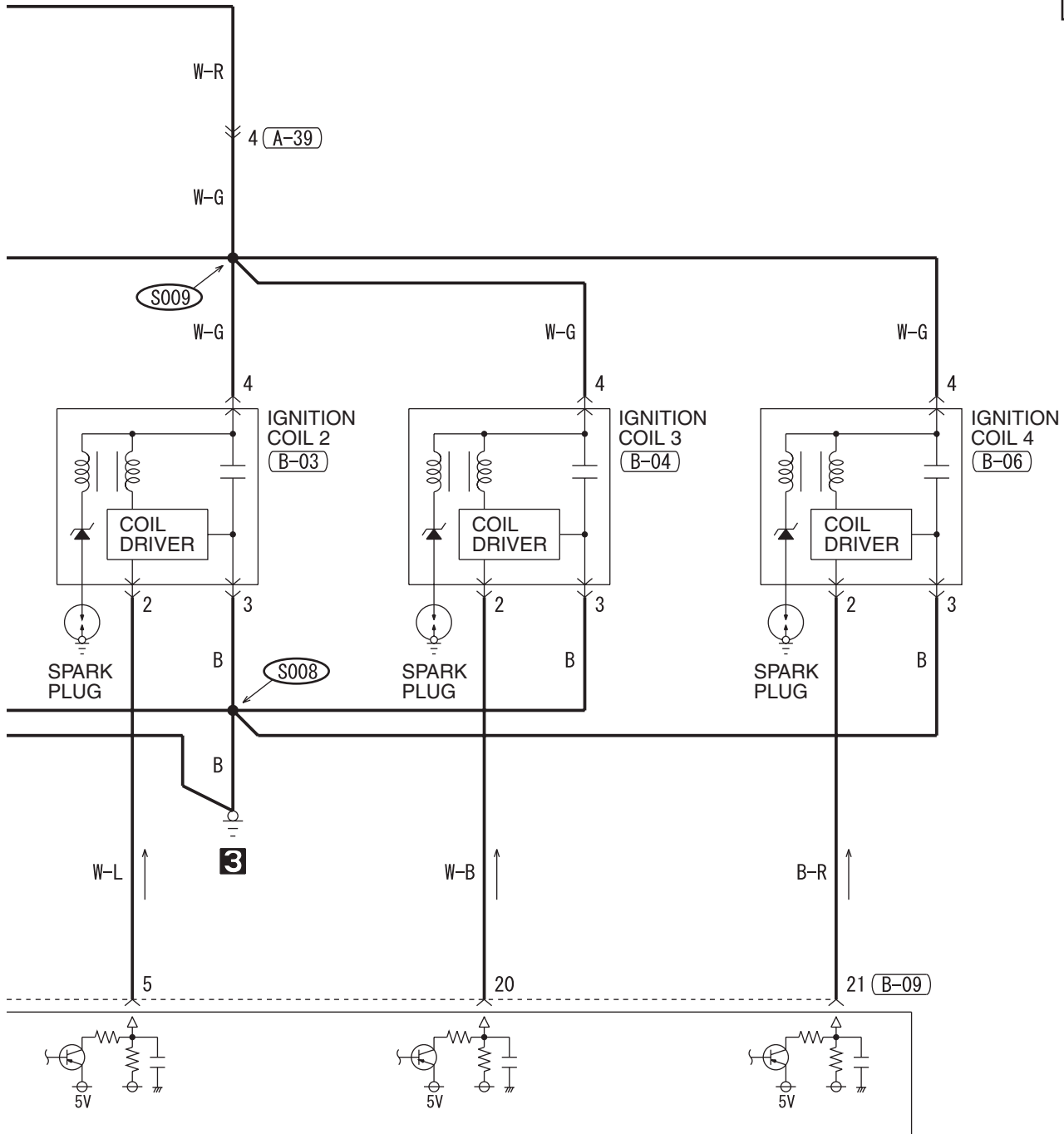

(B-10)

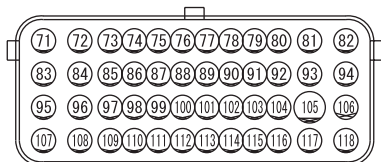

WIRE COLOR CODE
 B: BLACK LG: LIGHT GREEN G: GREEN L: BLUE W: WHITE
 Y: YELLOW SB: SKY BLUE BR: BROWN O: ORANGE GR: GRAY
 R: RED P: PINK V: VIOLET PU: PURPLE SI: SILVER

H8G03M03AB

TSB Revision

IGNITION SYSTEM (CONTINUED)

3

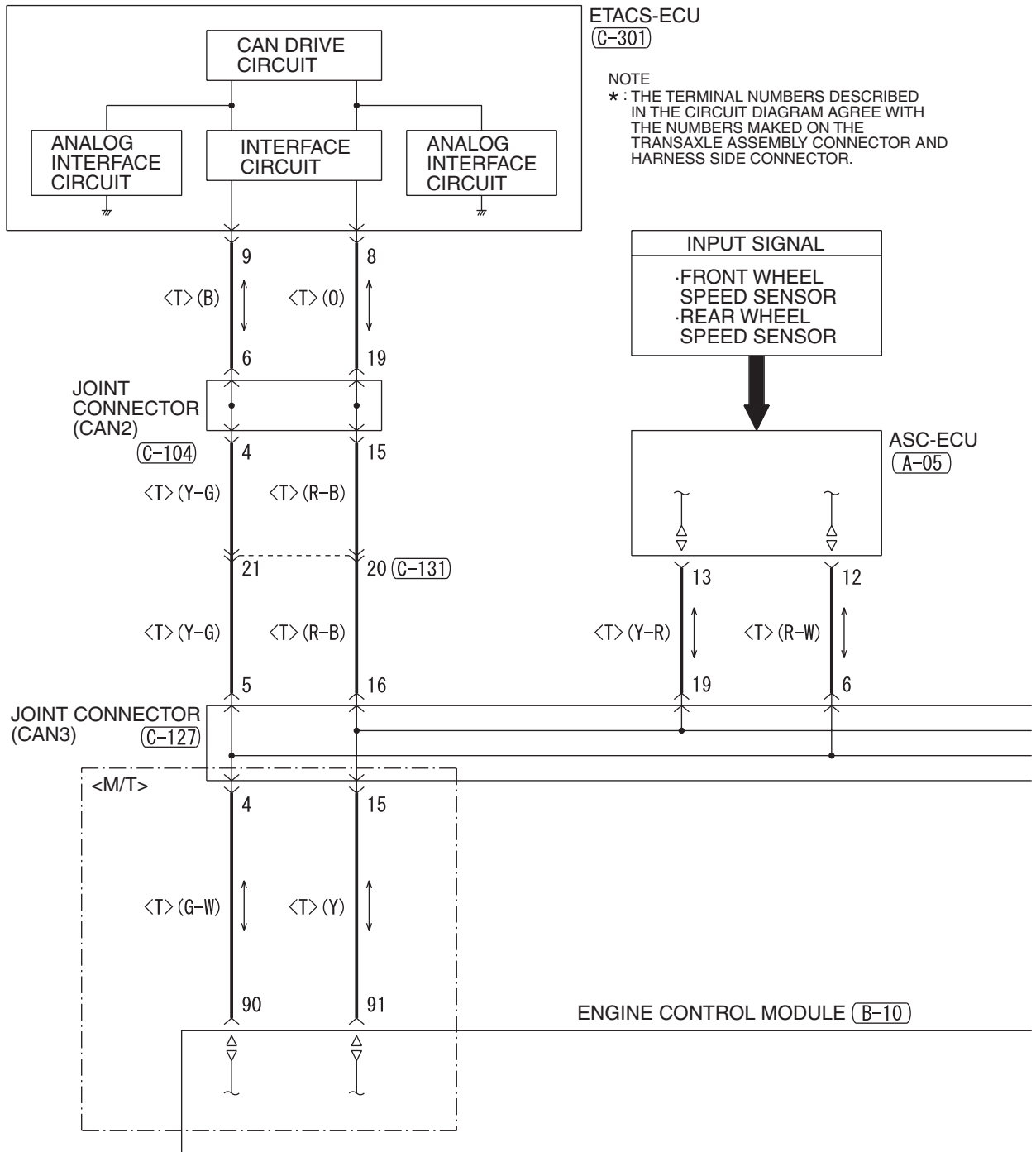

ETACS-ECU
(C-301)

NOTE
* : THE TERMINAL NUMBERS DESCRIBED
IN THE CIRCUIT DIAGRAM AGREE WITH
THE NUMBERS MADE ON THE
TRANSAXLE ASSEMBLY CONNECTOR AND
HARNES SIDE CONNECTOR.

INPUT SIGNAL
·FRONT WHEEL
SPEED SENSOR
·REAR WHEEL
SPEED SENSOR

ASC-ECU
(A-05)

ENGINE CONTROL MODULE (B-10)

(A-05)

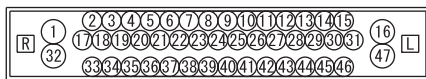

(A-13)

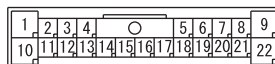

(A-14)

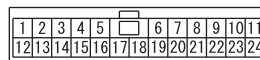

(C-127)

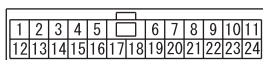

(C-131)

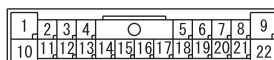

(C-301)



4

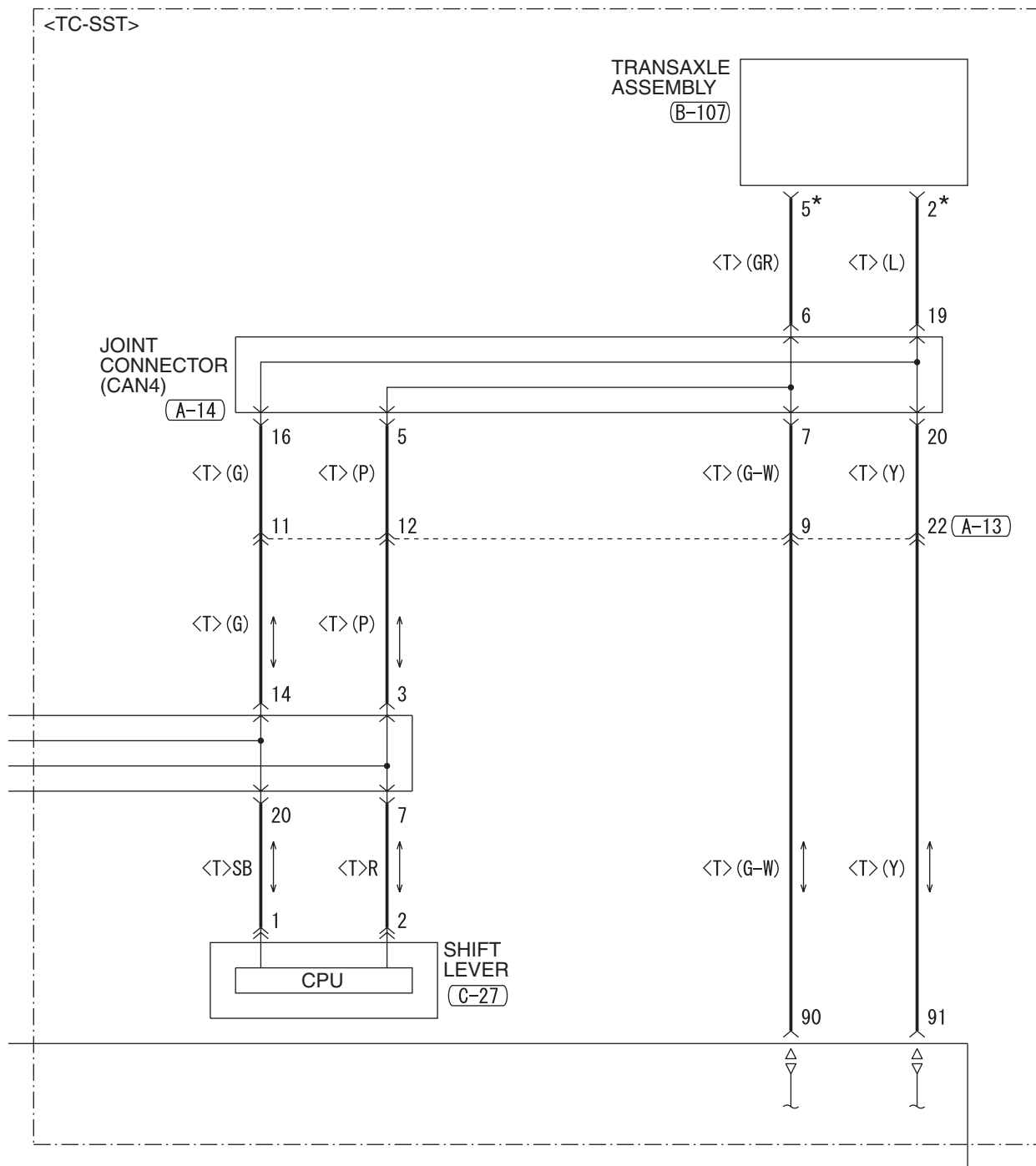

(B-10)

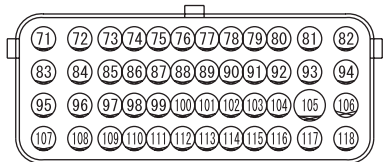

(B-107)*



(C-27)

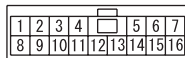

(C-104)

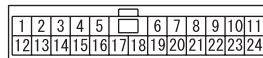

CHARGING SYSTEM <M/T>

M1901000703493

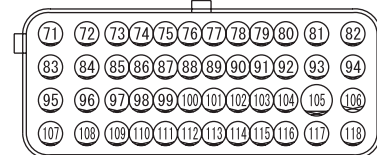
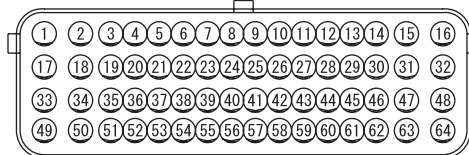
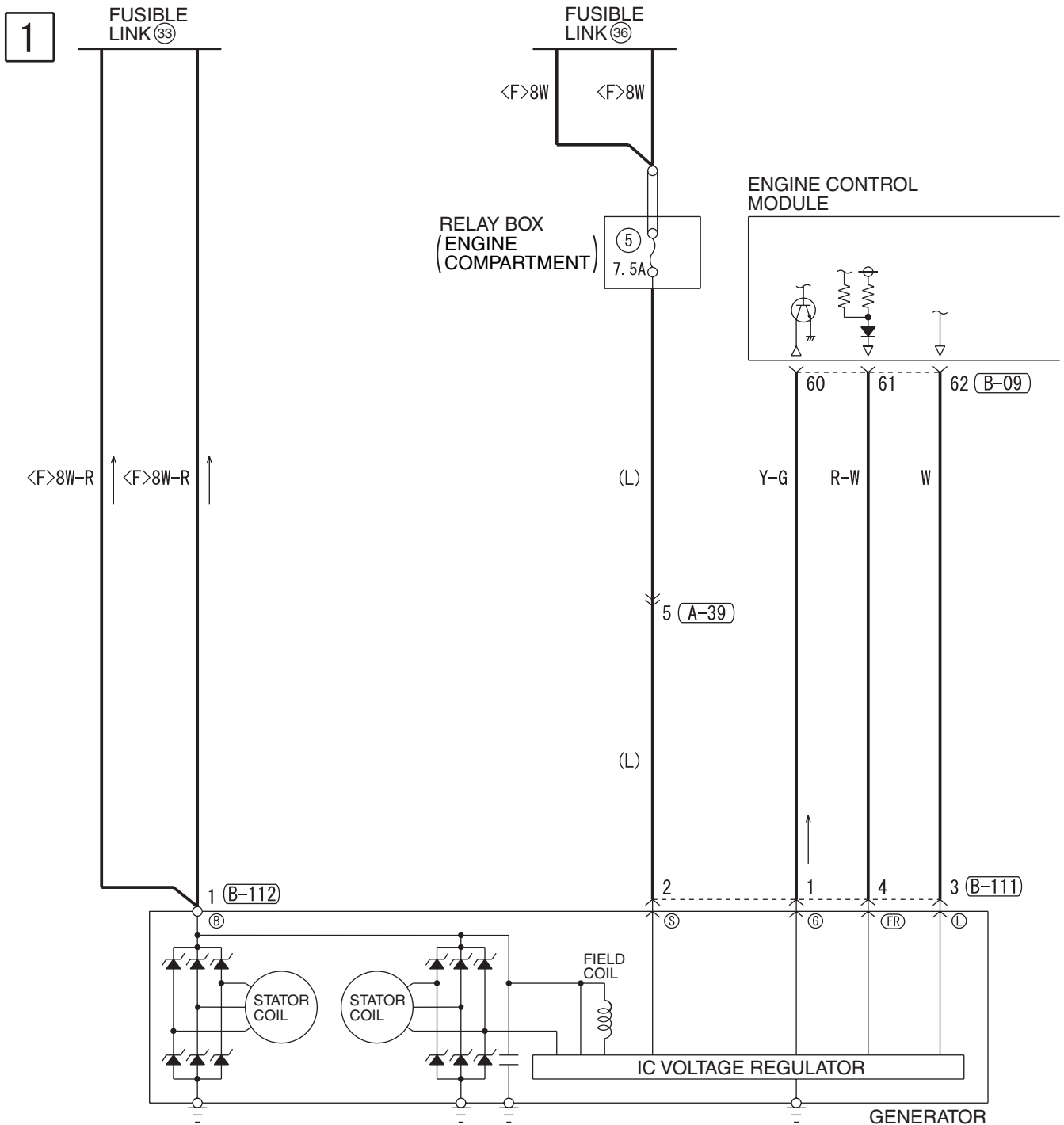

H8G04M02AA

2

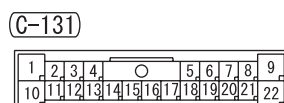
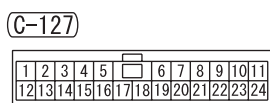
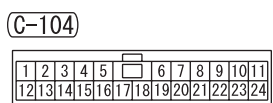
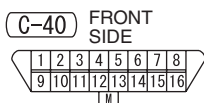
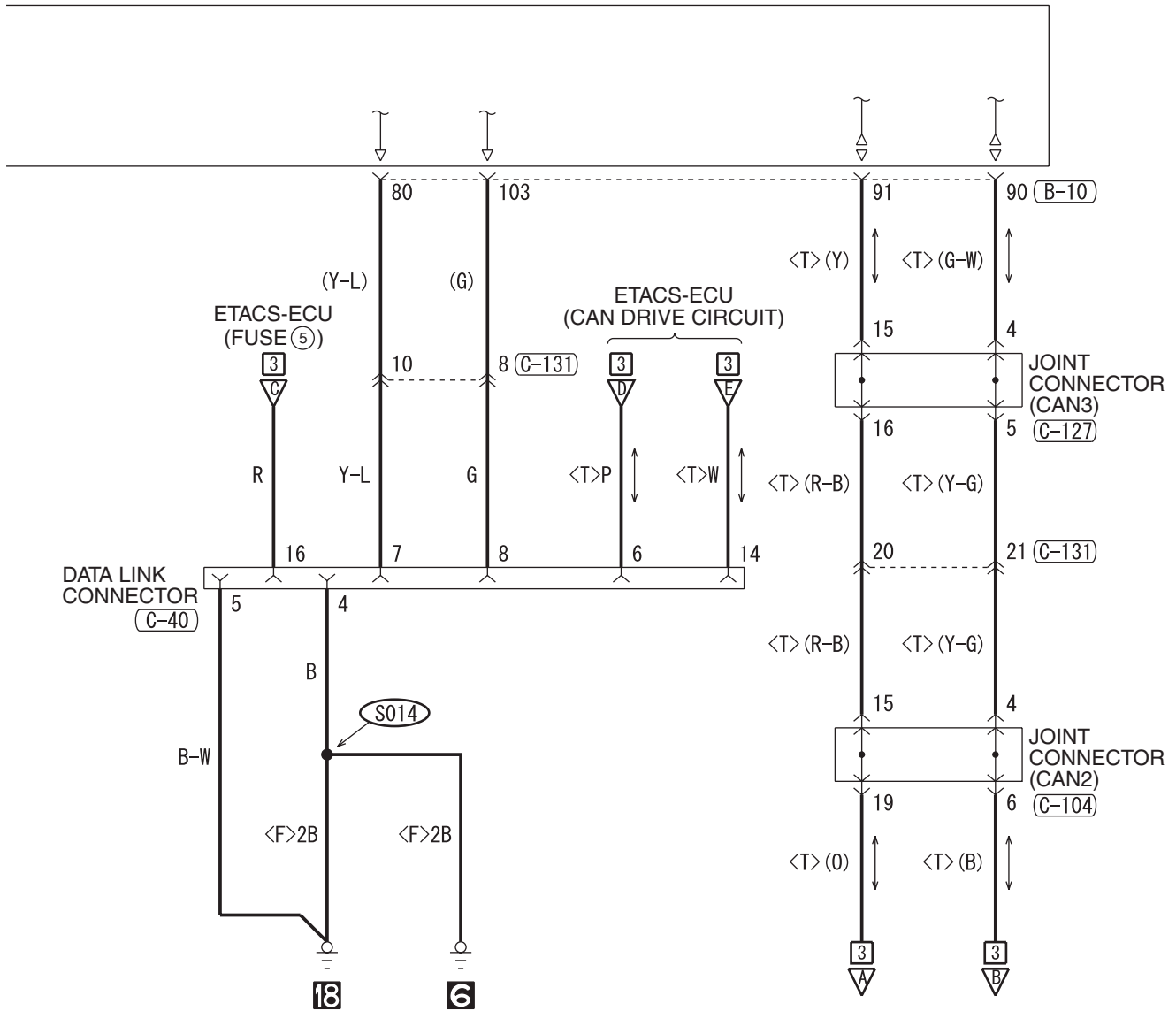

WIRE COLOR CODE
 B: BLACK LG: LIGHT GREEN G: GREEN L: BLUE W: WHITE Y: YELLOW SB: SKY BLUE
 BR: BROWN O: ORANGE GR: GRAY R: RED P: PINK V: VIOLET PU: PURPLE SI: SILVER

H8G04M02AB

TSB Revision

CHARGING SYSTEM <M/T> (CONTINUED)

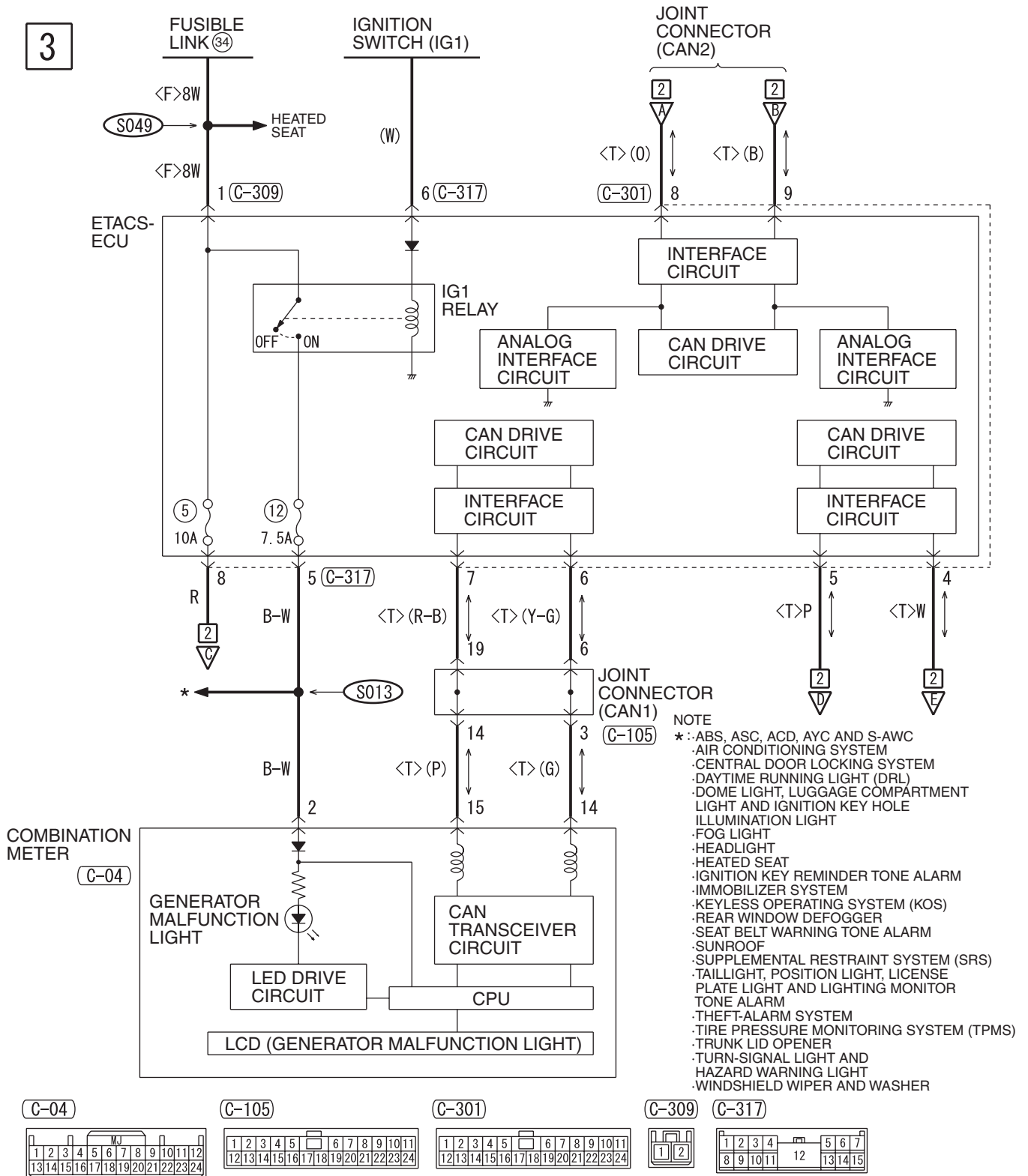

WIRE COLOR CODE
 B: BLACK LG: LIGHT GREEN G: GREEN L: BLUE W: WHITE Y: YELLOW SB: SKY BLUE
 BR: BROWN O: ORANGE GR: GRAY R: RED P: PINK V: VIOLET PU: PURPLE SI: SILVER

NOTES

CHARGING SYSTEM <TC-SST>

M1901000703501

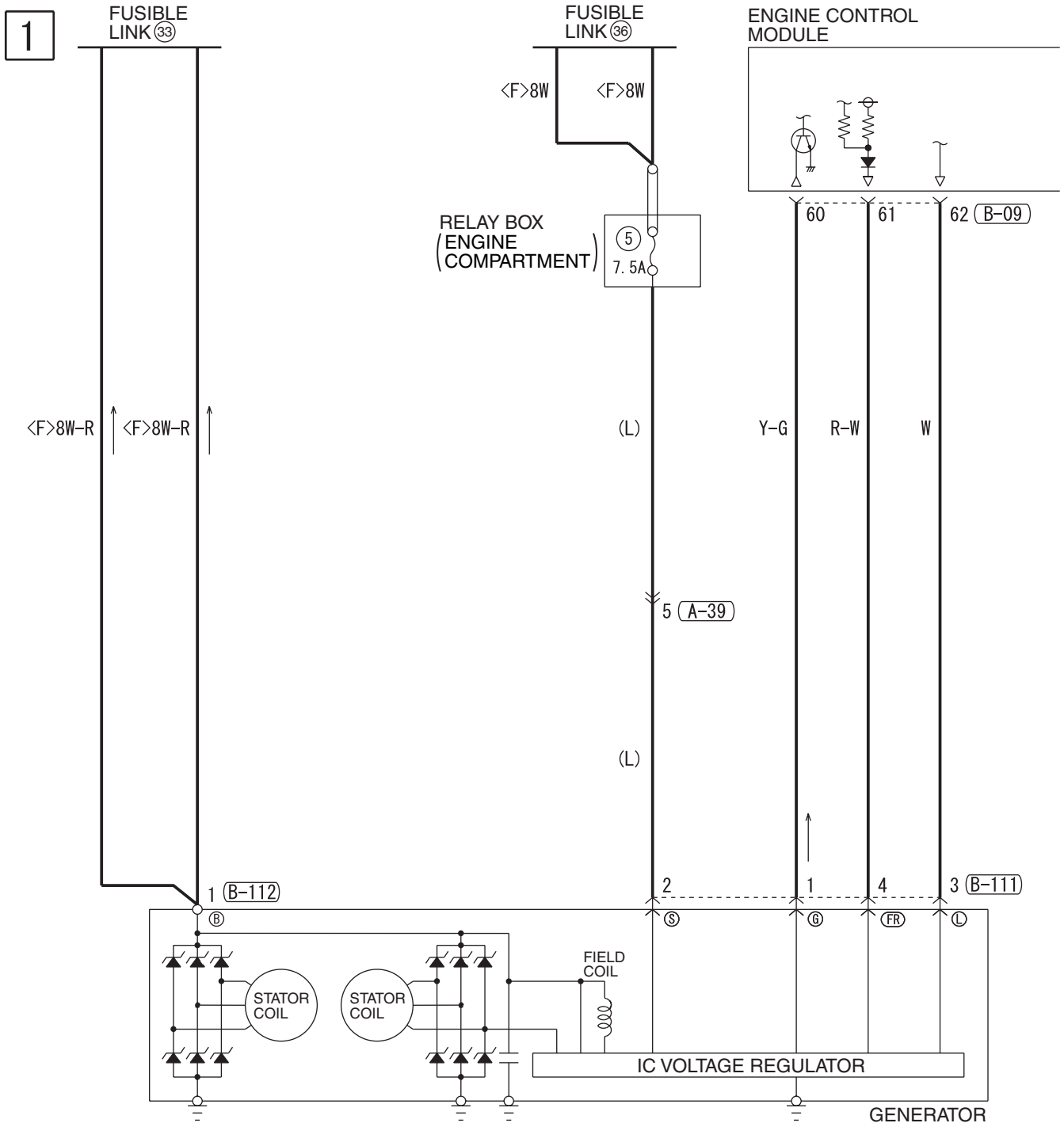

(A-13)

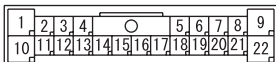

(A-14)

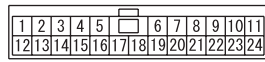

(A-39)



(B-09)

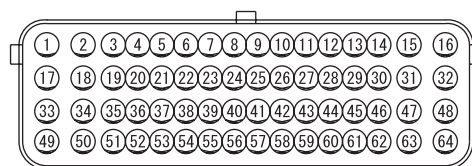

(C-127)

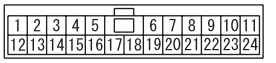

(C-131)

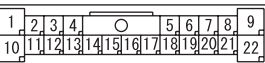

H8G04M03AA

2

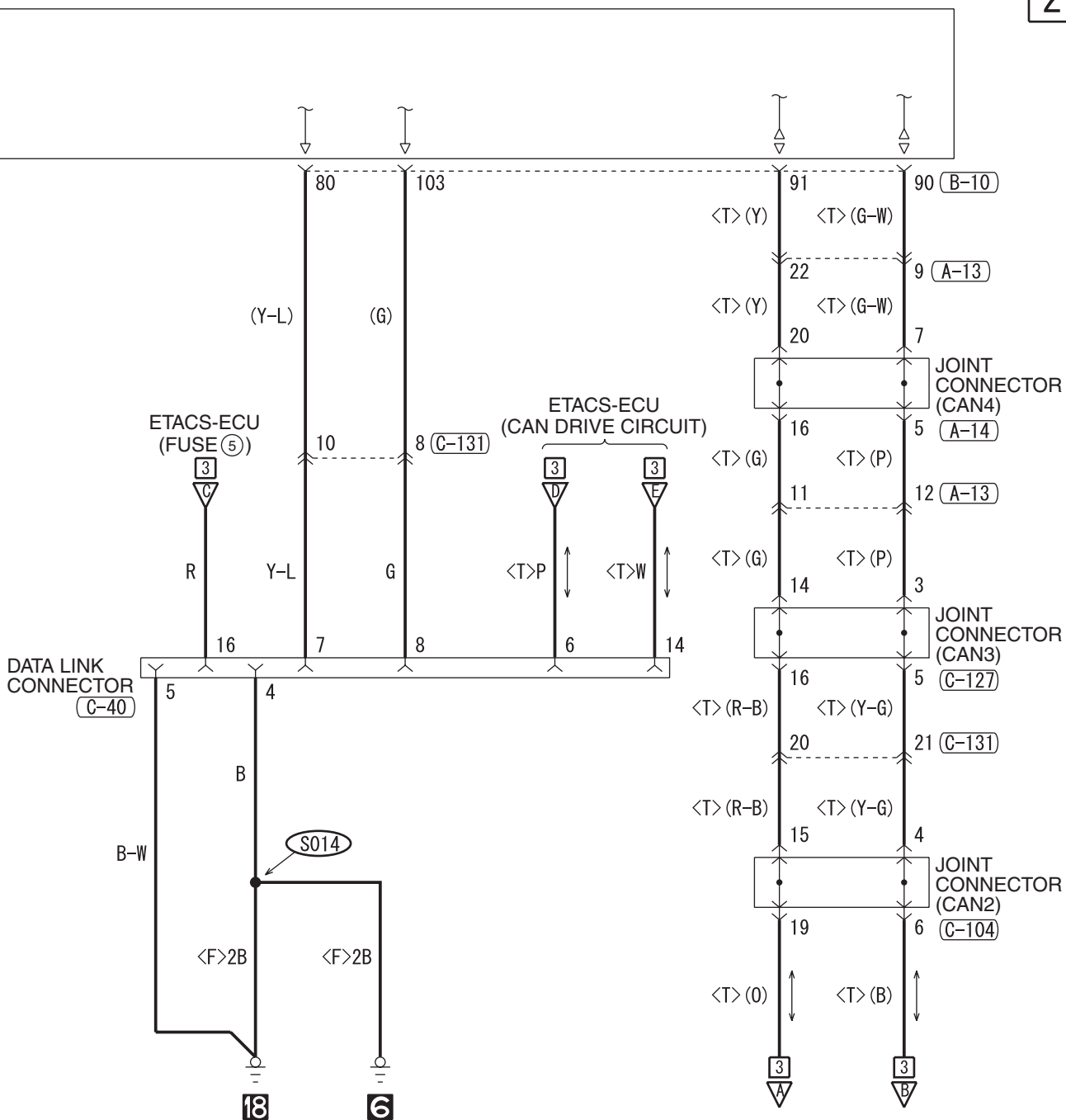

(B-10)

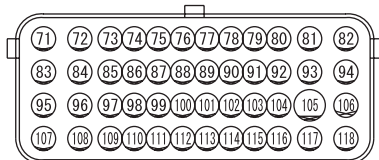

(B-111)
(MU802066)



(B-112)



(C-40) FRONT SIDE

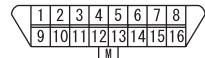

(C-104)

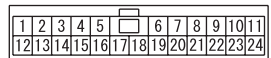

WIRE COLOR CODE
 B : BLACK LG : LIGHT GREEN G : GREEN L : BLUE W : WHITE
 Y : YELLOW SB : SKY BLUE BR : BROWN O : ORANGE GR : GRAY
 R : RED P : PINK V : VIOLET PU : PURPLE SI : SILVER

H8G04M03AB

TSB Revision

CHARGING SYSTEM <TC-SST> (CONTINUED)

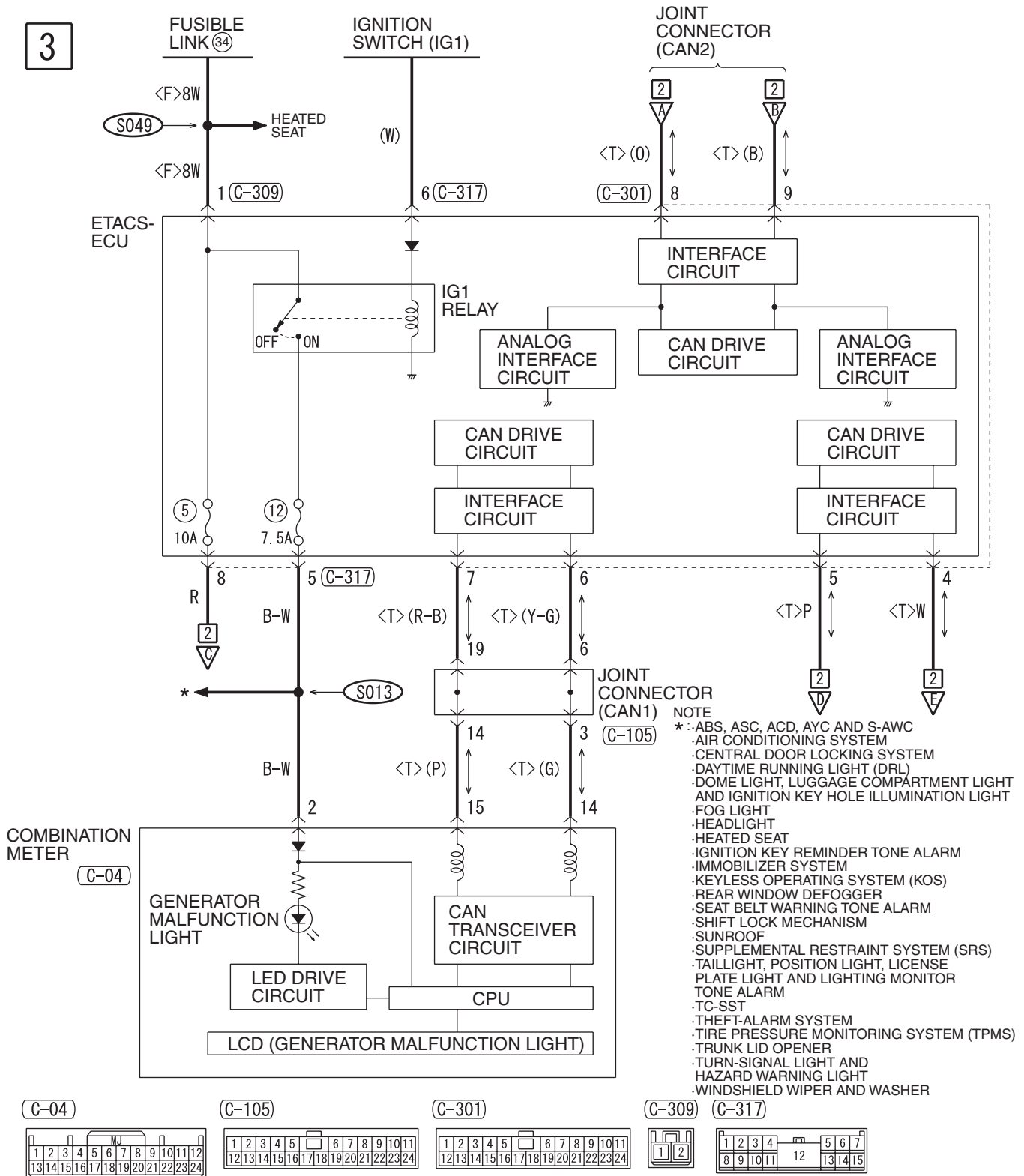

WIRE COLOR CODE
 B: BLACK LG: LIGHT GREEN G: GREEN L: BLUE W: WHITE Y: YELLOW SB: SKY BLUE
 BR: BROWN O: ORANGE GR: GRAY R: RED P: PINK V: VIOLET PU: PURPLE SI: SILVER

NOTES

MFI SYSTEM <M/T>

M1901000806615

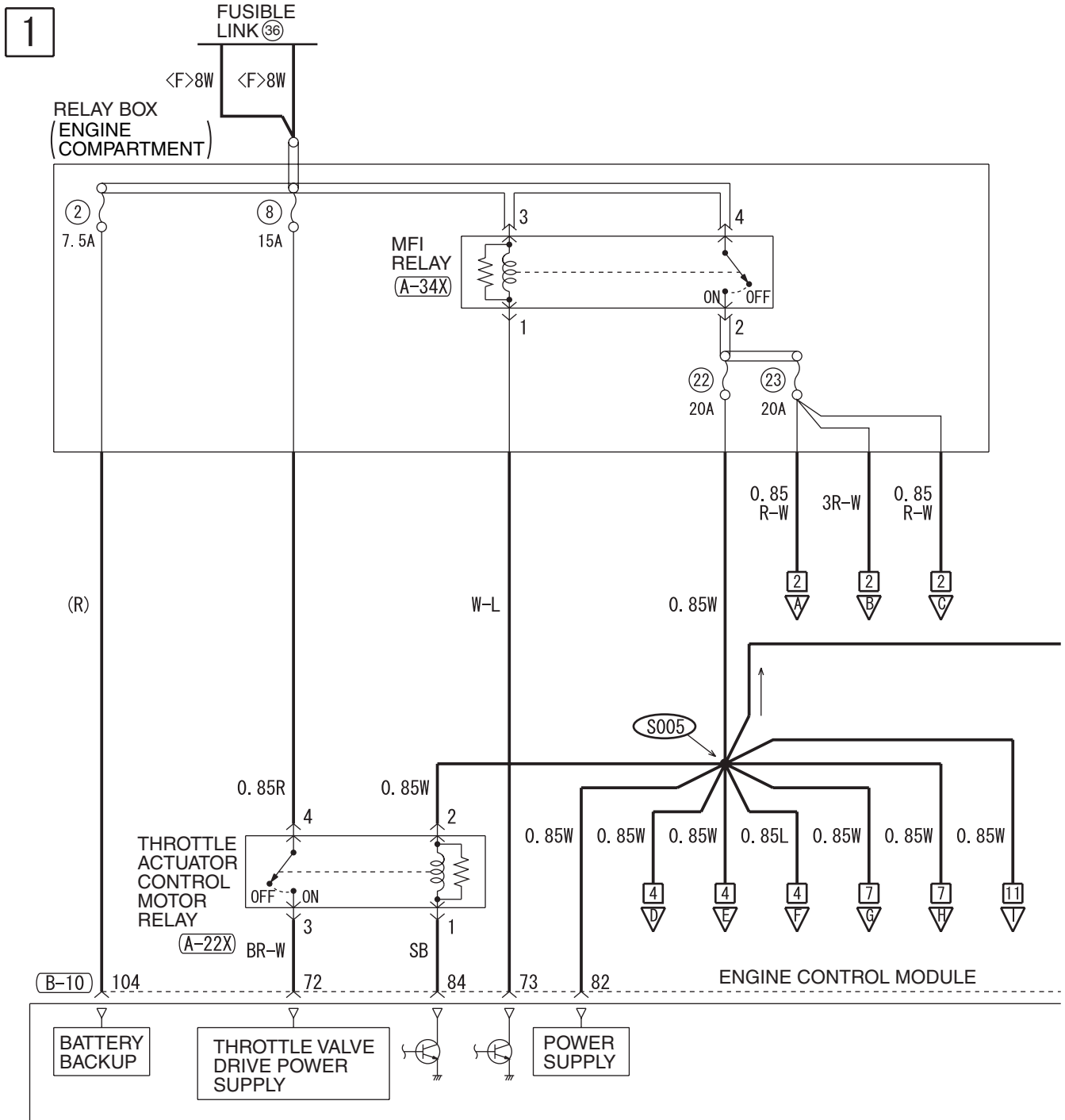

(A-13)

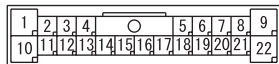

(A-22X)



(A-25X)



(A-27X)



(A-34X)



(A-58)



(B-09)

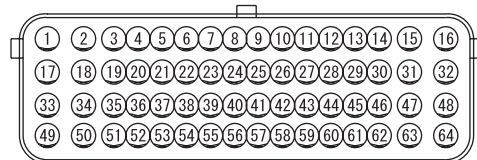

(C-317)

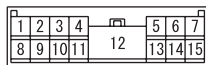

(D-22)

(MU802058)



H8G05M04AA

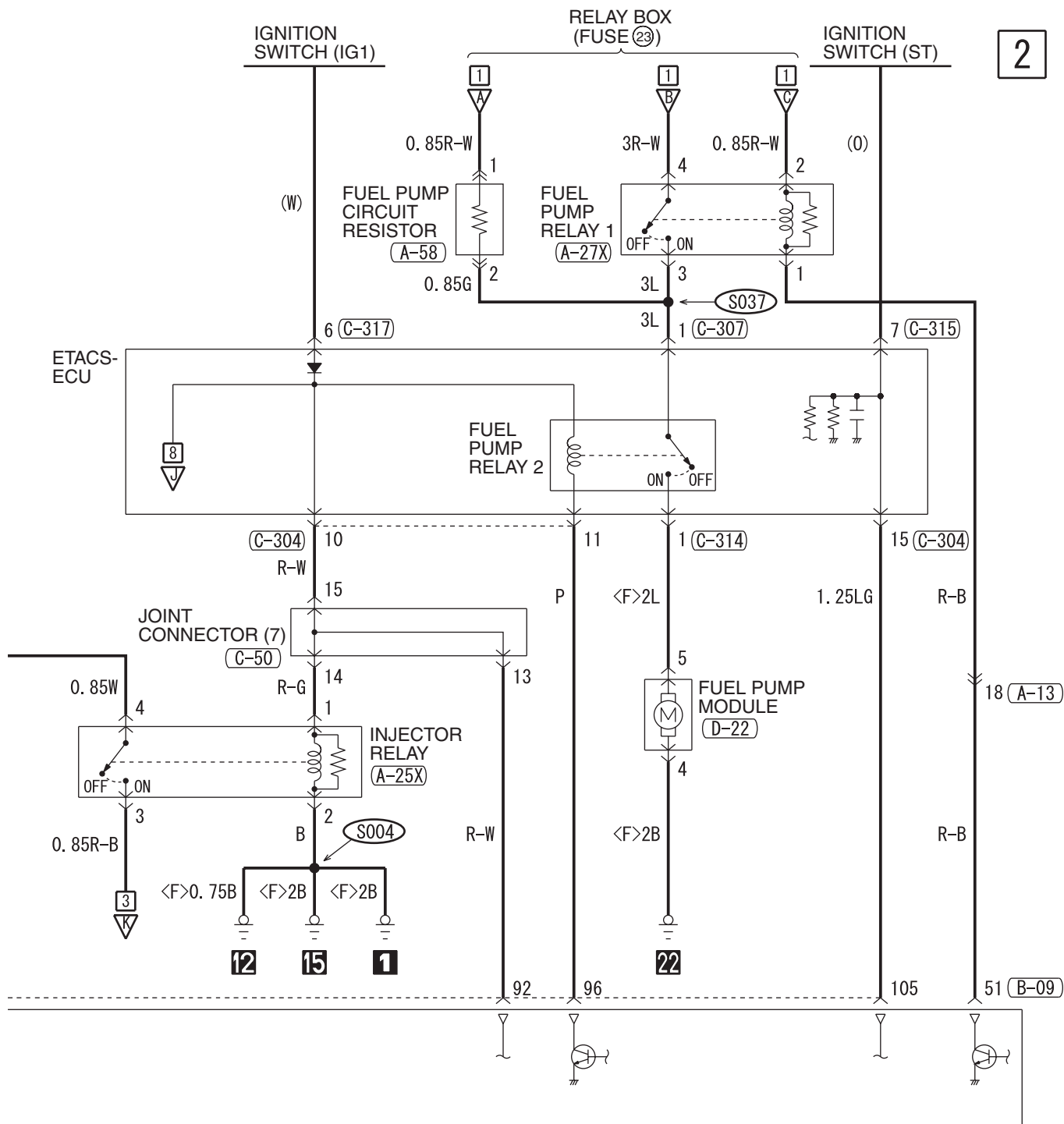

(B-10)

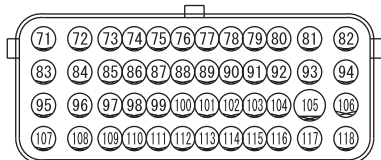

(C-50)



(C-304)



(C-307)



(C-314)



(C-315)



WIRE COLOR CODE

B: BLACK LG: LIGHT GREEN G: GREEN L: BLUE W: WHITE
Y: YELLOW SB: SKY BLUE BR: BROWN O: ORANGE GR: GRAY
R: RED P: PINK V: VIOLET PU: PURPLE SI: SILVER

H8G05M04AB

MFI SYSTEM <M/T> (CONTINUED)

3

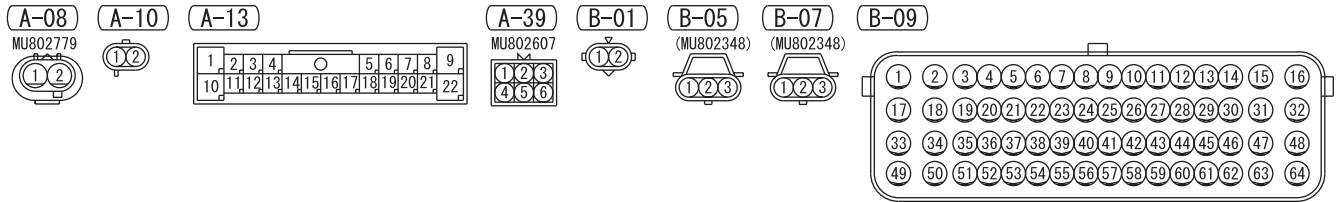
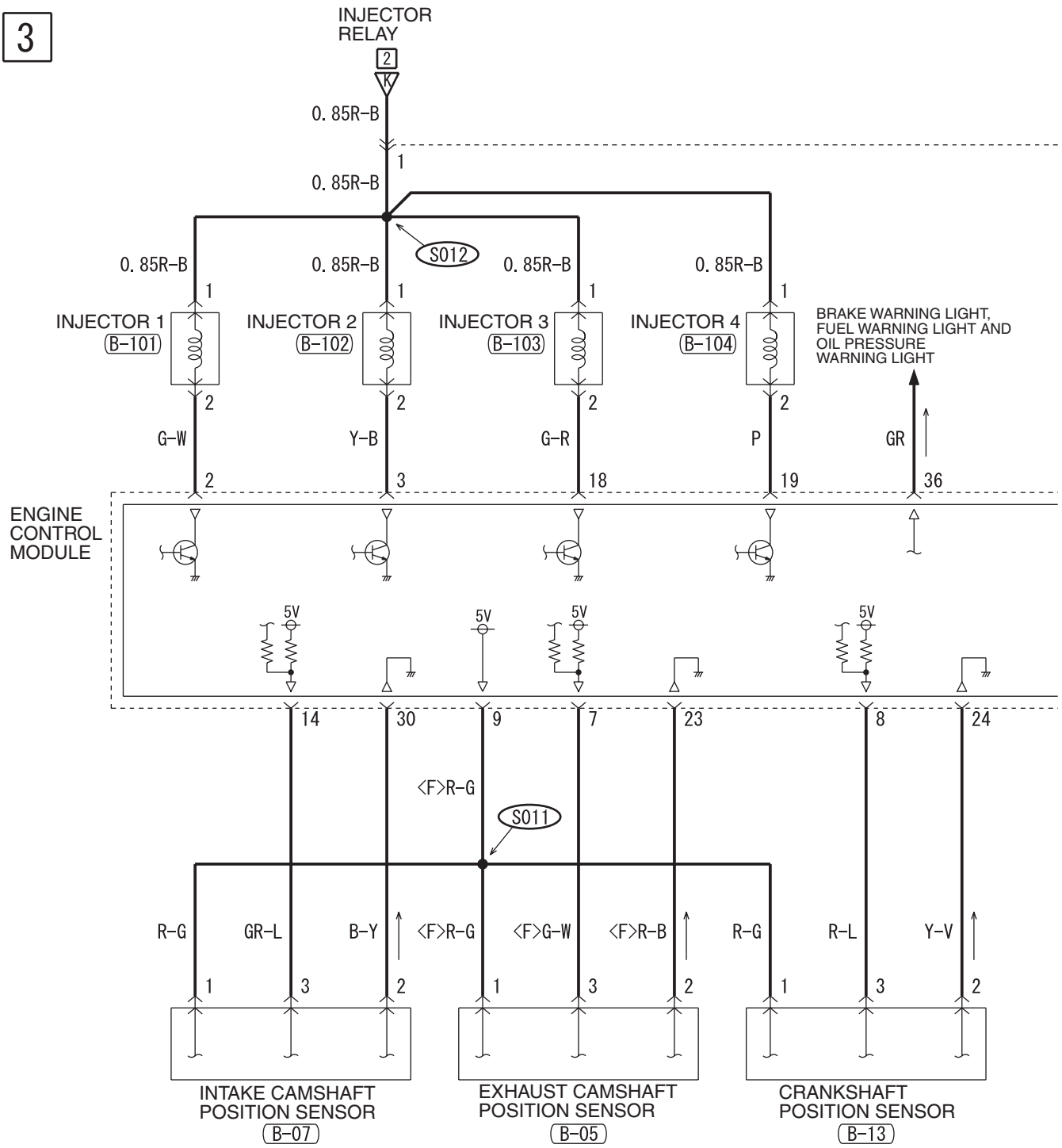

H8G05M04BA

4

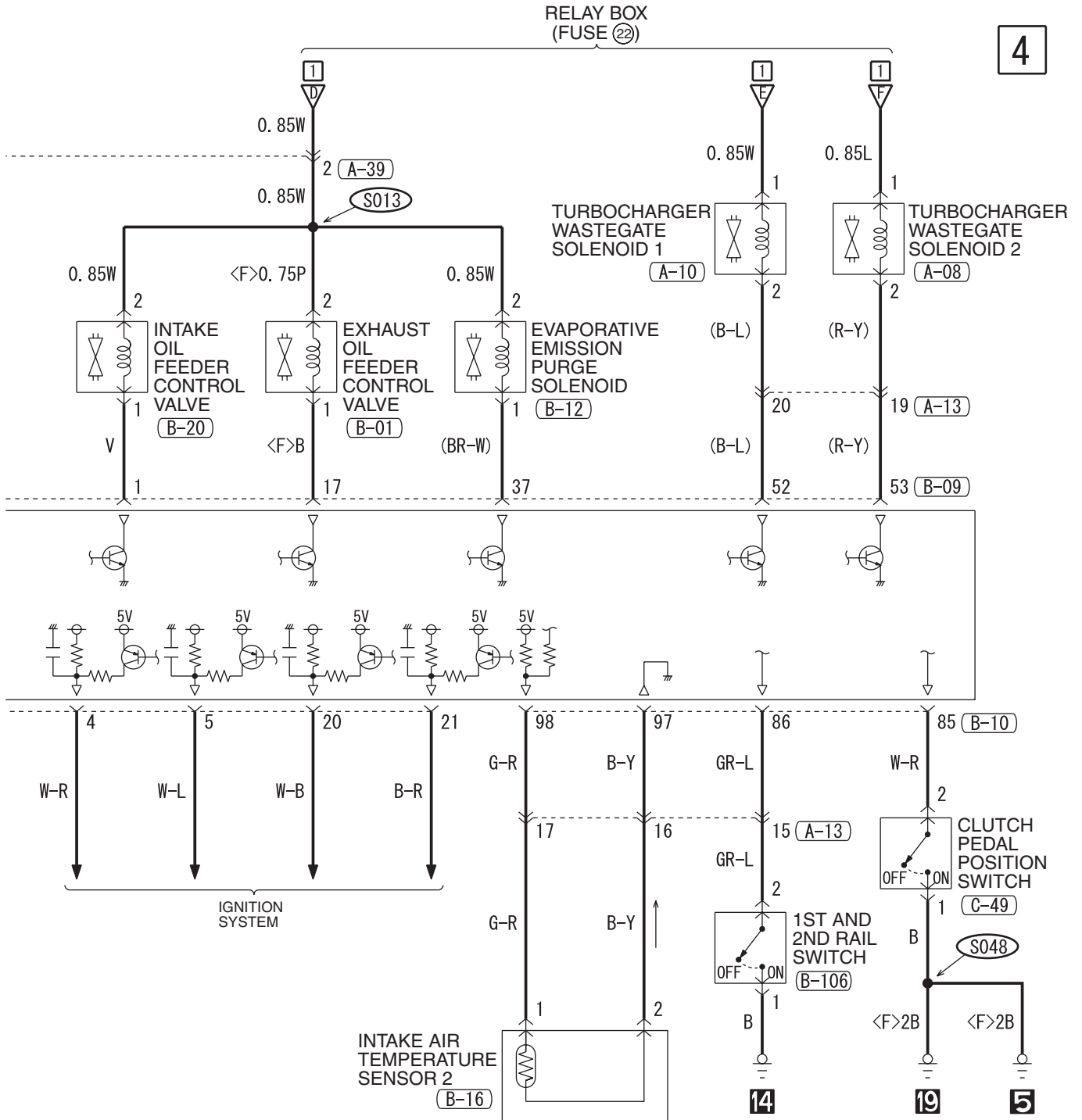

(B-10)

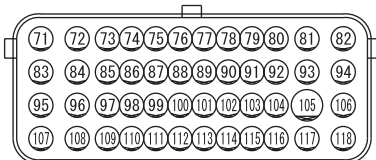

(B-12)



(B-13)



(B-16)



(B-20)



(B-101)



(B-102)



(B-103)



(B-104)



(B-106)



(C-49)



WIRE COLOR CODE

B : BLACK LG : LIGHT GREEN G : GREEN L : BLUE W : WHITE
Y : YELLOW SB : SKY BLUE BR : BROWN O : ORANGE GR : GRAY
R : RED P : PINK V : VIOLET PU : PURPLE SI : SILVER

H8G05M04BB

MFI SYSTEM <M/T> (CONTINUED)

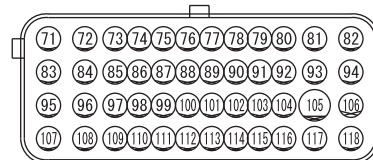
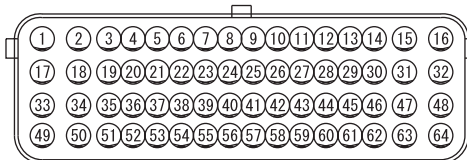
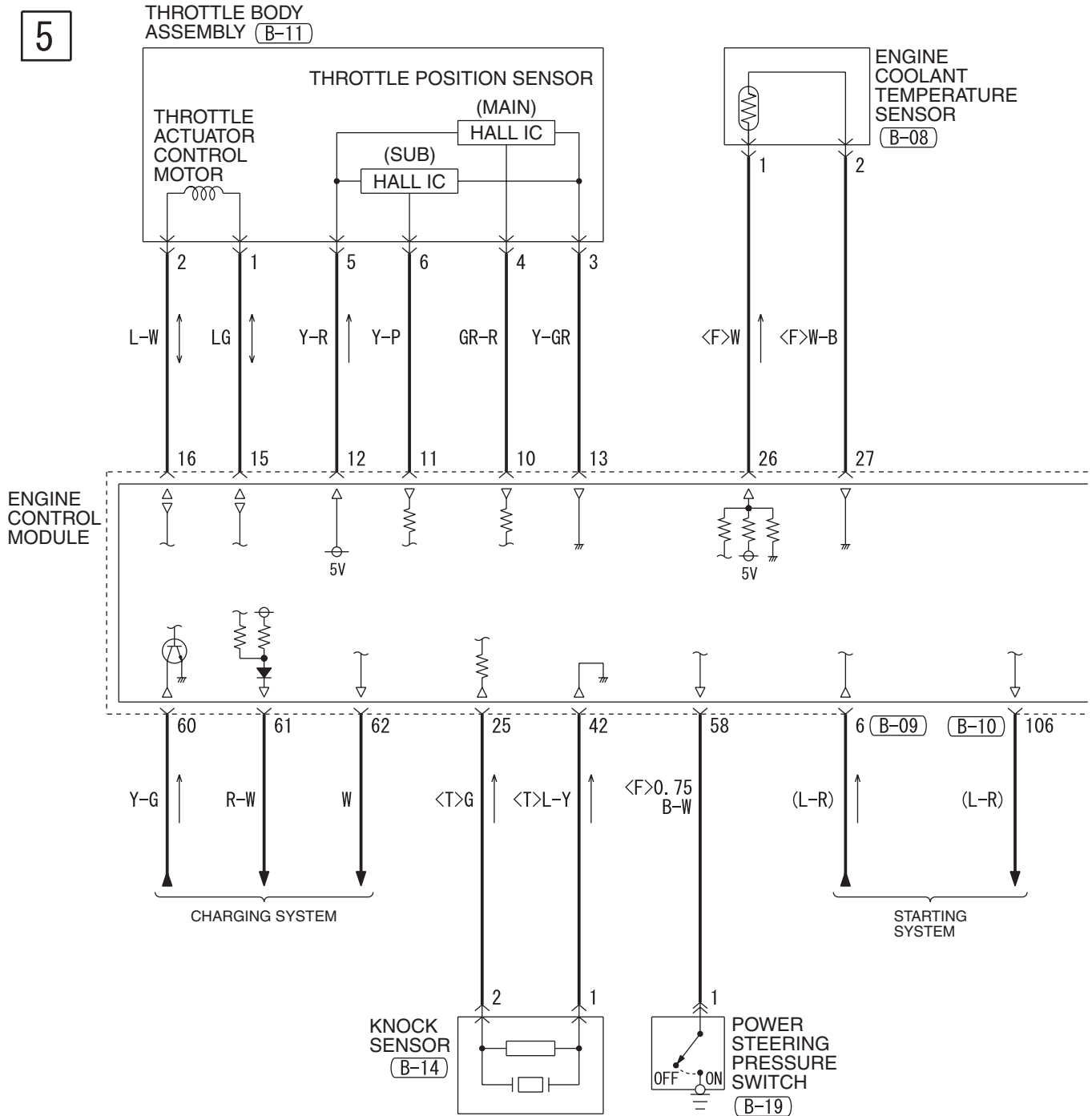

6

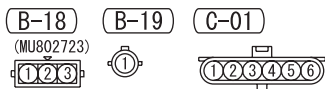
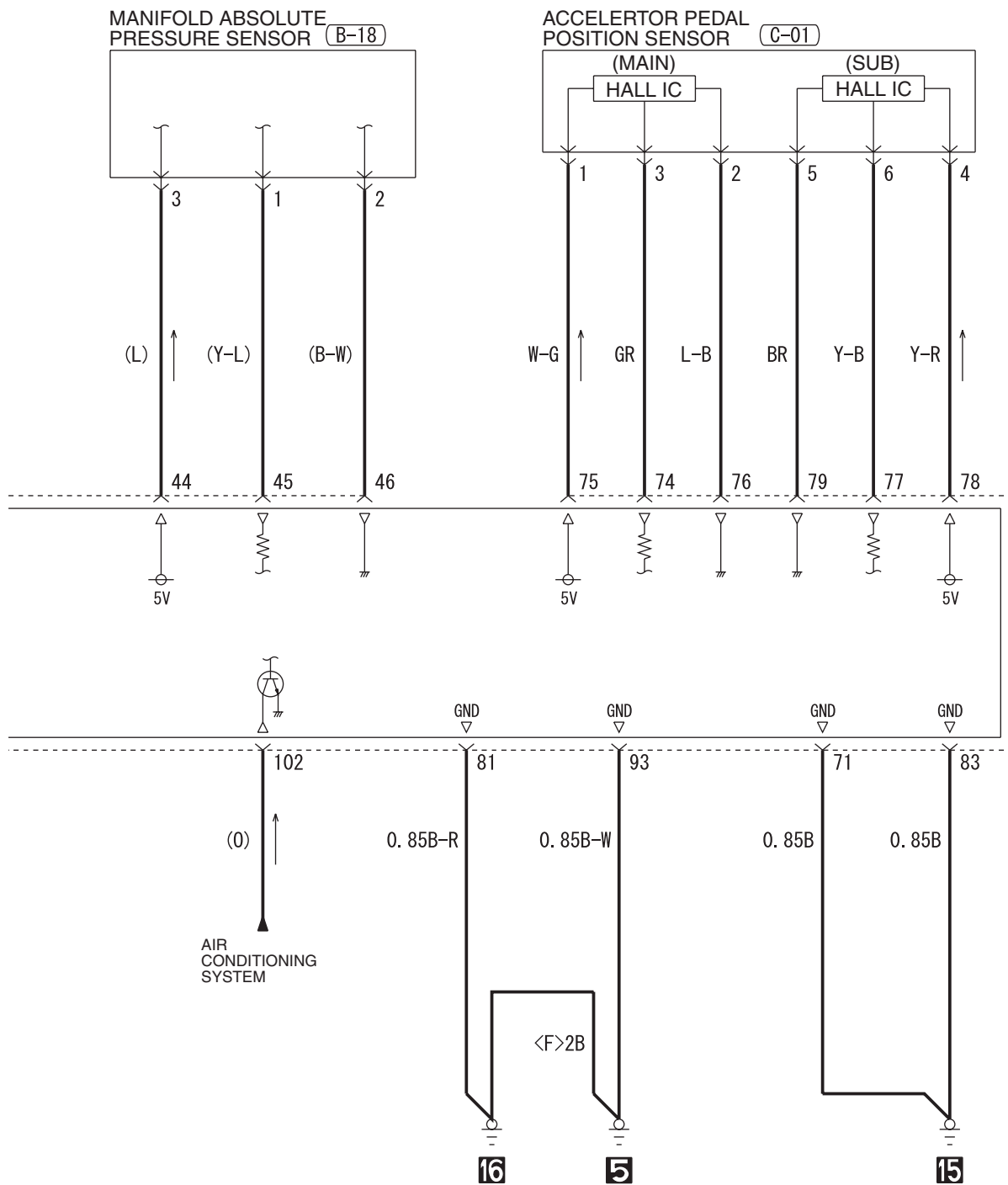

WIRE COLOR CODE
 B: BLACK LG: LIGHT GREEN G: GREEN L: BLUE W: WHITE Y: YELLOW SB: SKY BLUE
 BR: BROWN O: ORANGE GR: GRAY R: RED P: PINK V: VIOLET PU: PURPLE SI: SILVER

H8G05M04CB

TSB Revision

MFI SYSTEM <M/T> (CONTINUED)

7

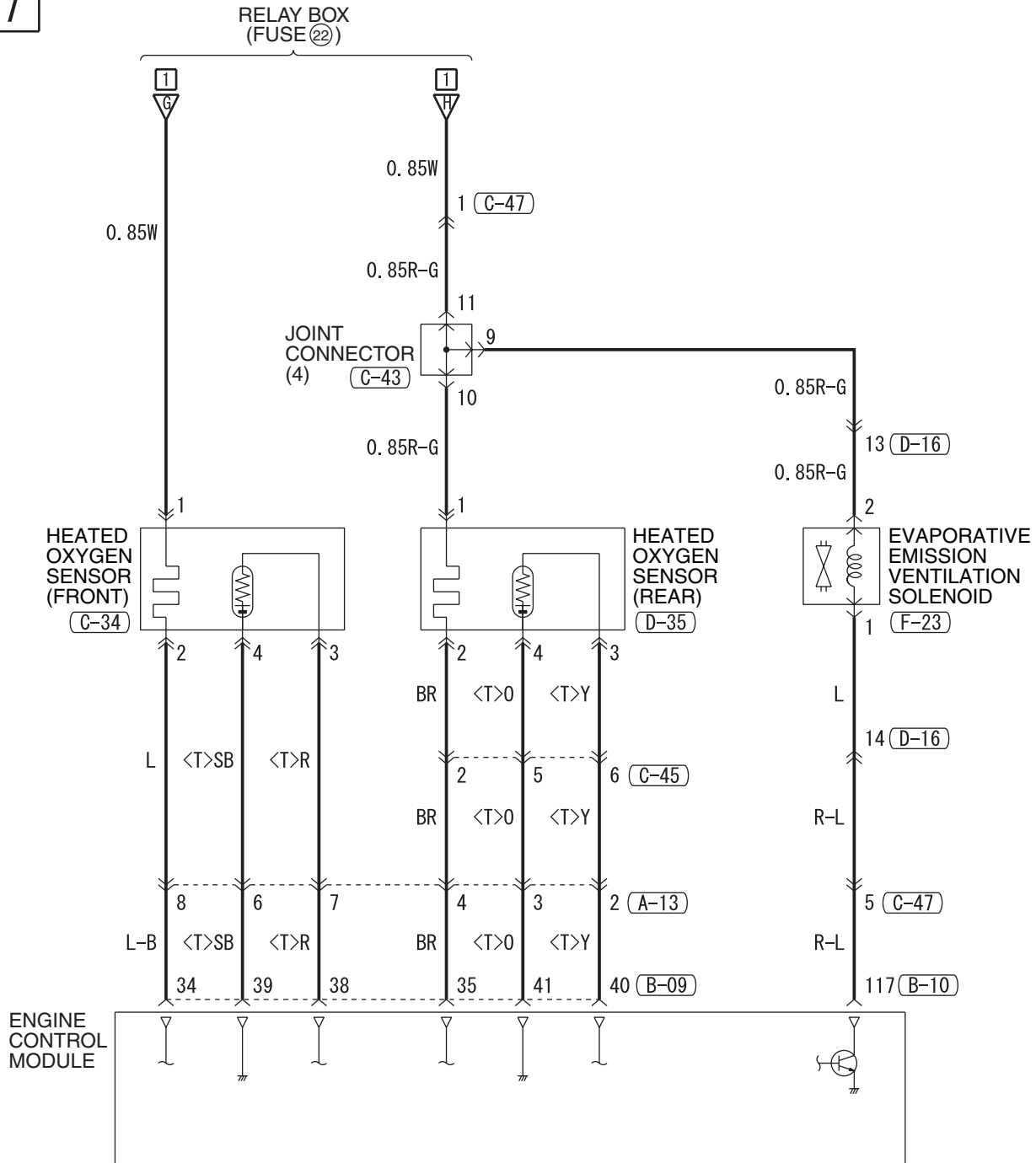

(A-13)

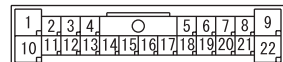

(C-312)

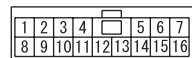

(B-09)

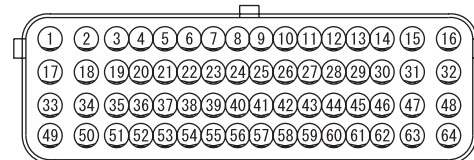

(B-10)

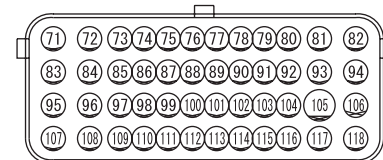

8

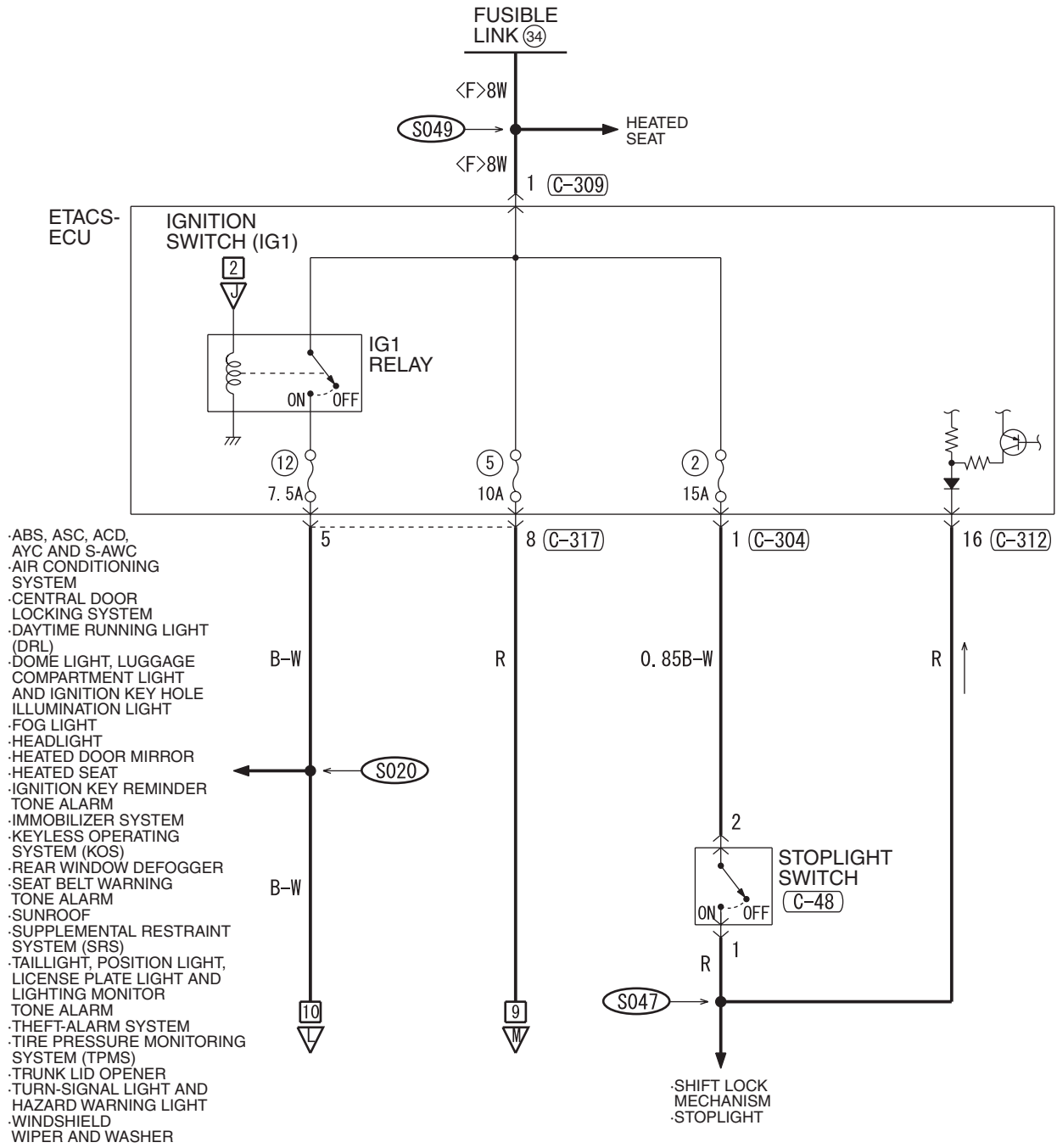

- ABS, ASC, ACD, AYC AND S-AWC
- AIR CONDITIONING SYSTEM
- CENTRAL DOOR LOCKING SYSTEM
- DAYTIME RUNNING LIGHT (DRL)
- DOME LIGHT, LUGGAGE COMPARTMENT LIGHT AND IGNITION KEY HOLE ILLUMINATION LIGHT
- FOG LIGHT
- HEADLIGHT
- HEATED DOOR MIRROR
- HEATED SEAT
- IGNITION KEY REMINDER TONE ALARM
- IMMOBILIZER SYSTEM
- KEYLESS OPERATING SYSTEM (KOS)
- REAR WINDOW DEFOGGER
- SEAT BELT WARNING TONE ALARM
- SUNROOF
- SUPPLEMENTAL RESTRAINT SYSTEM (SRS)
- TAILLIGHT, POSITION LIGHT, LICENSE PLATE LIGHT AND LIGHTING MONITOR TONE ALARM
- THEFT-ALARM SYSTEM
- TIRE PRESSURE MONITORING SYSTEM (TPMS)
- TRUNK LID OPENER
- TURN-SIGNAL LIGHT AND HAZARD WARNING LIGHT
- WINDSHIELD WIPER AND WASHER

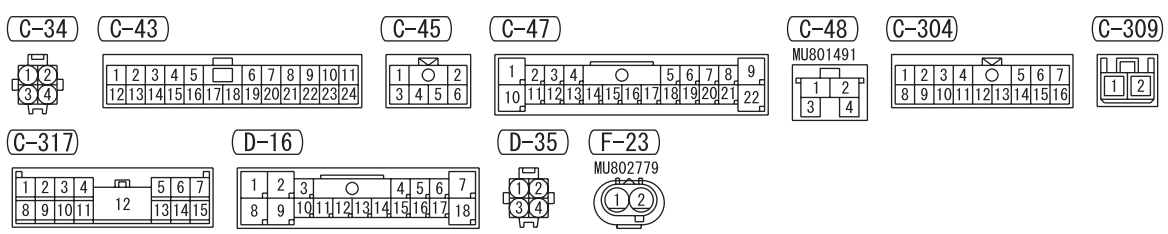

MFI SYSTEM <M/T> (CONTINUED)

9

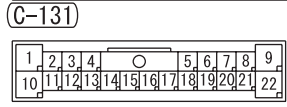
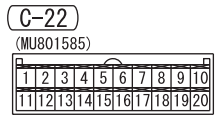
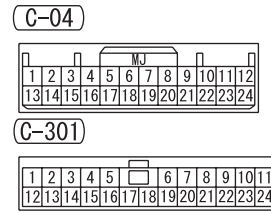
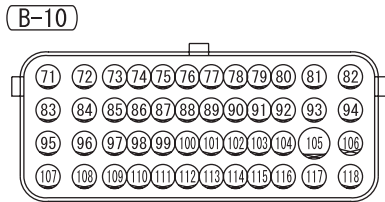
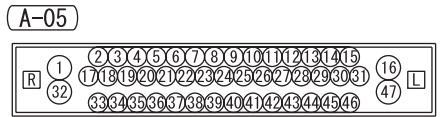
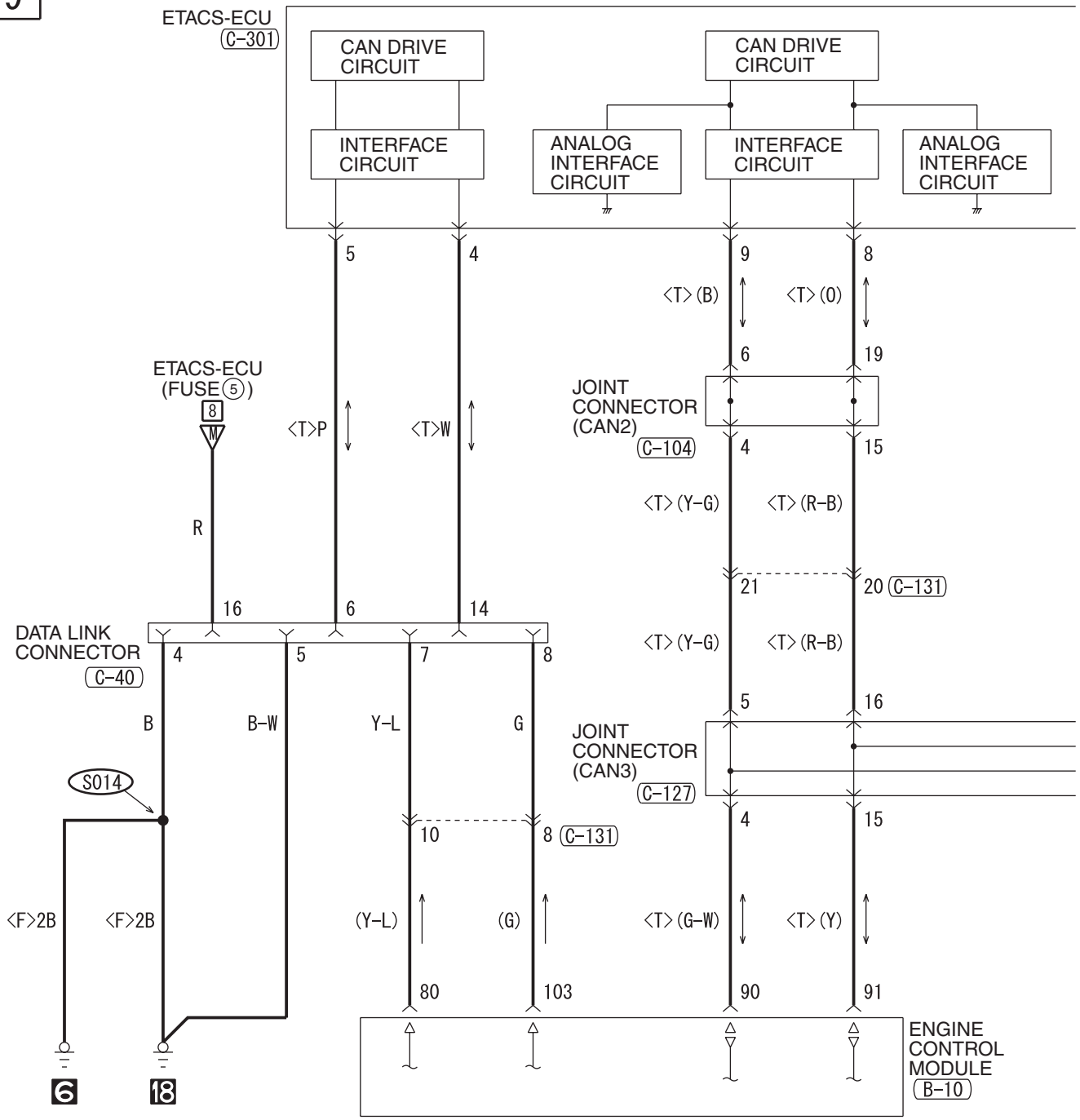

10

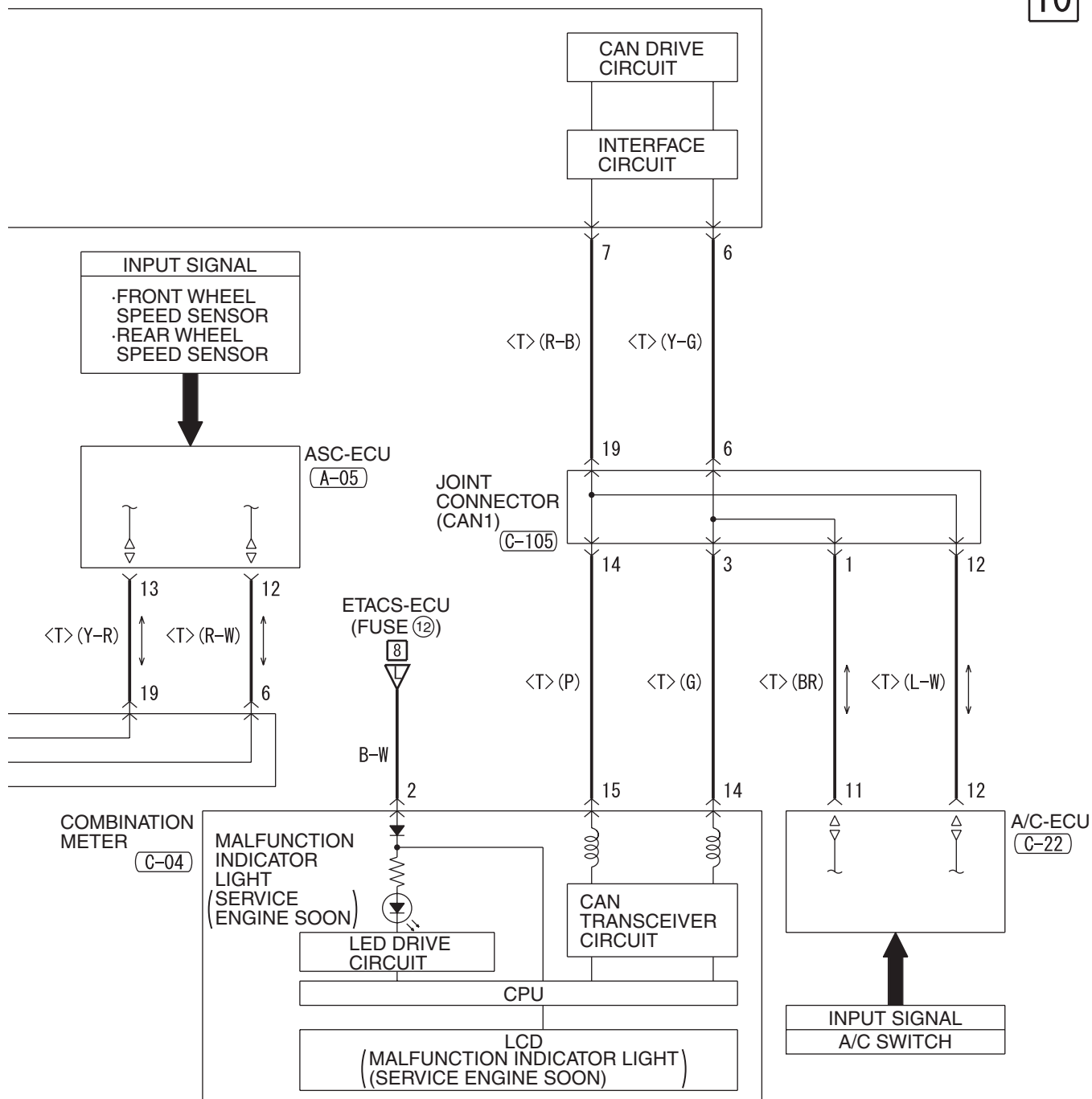

(C-40) FRONT SIDE



(C-104)

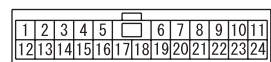

(C-105)

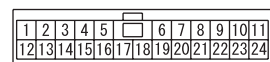

(C-127)

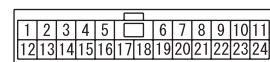

WIRE COLOR CODE

B: BLACK LG: LIGHT GREEN G: GREEN L: BLUE W: WHITE Y: YELLOW SB: SKY BLUE
BR: BROWN O: ORANGE GR: GRAY R: RED P: PINK V: VIOLET PU: PURPLE SI: SILVER

H8G05M04EB

MFI SYSTEM <M/T> (CONTINUED)

11

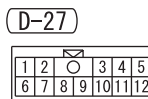
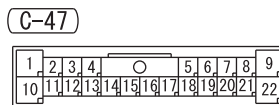
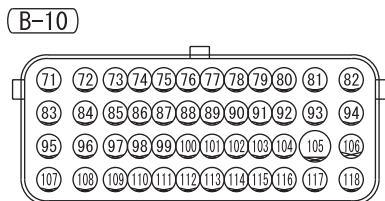
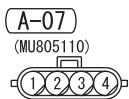
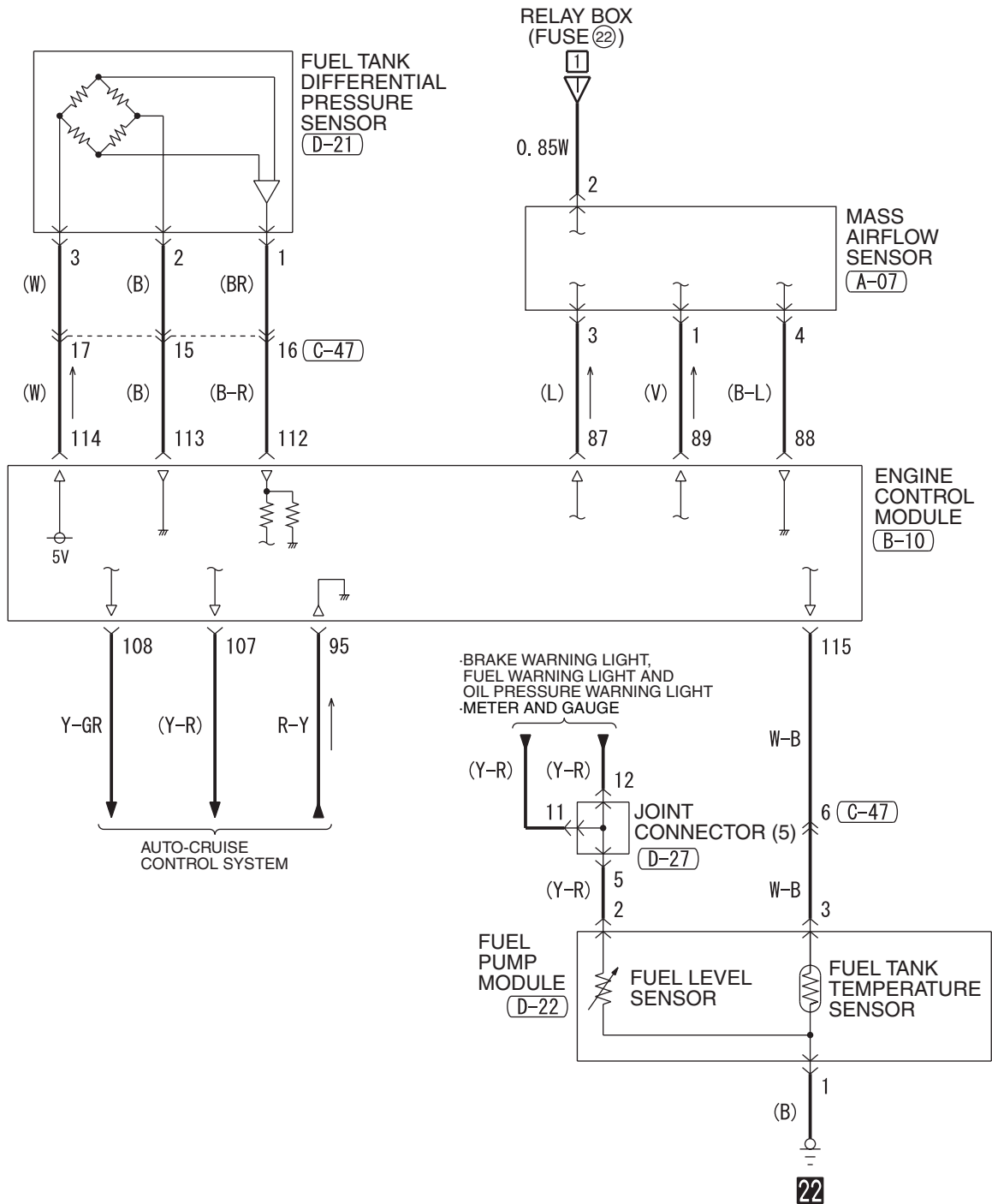

NOTES

MFI SYSTEM <TC-SST>

M1901000806626

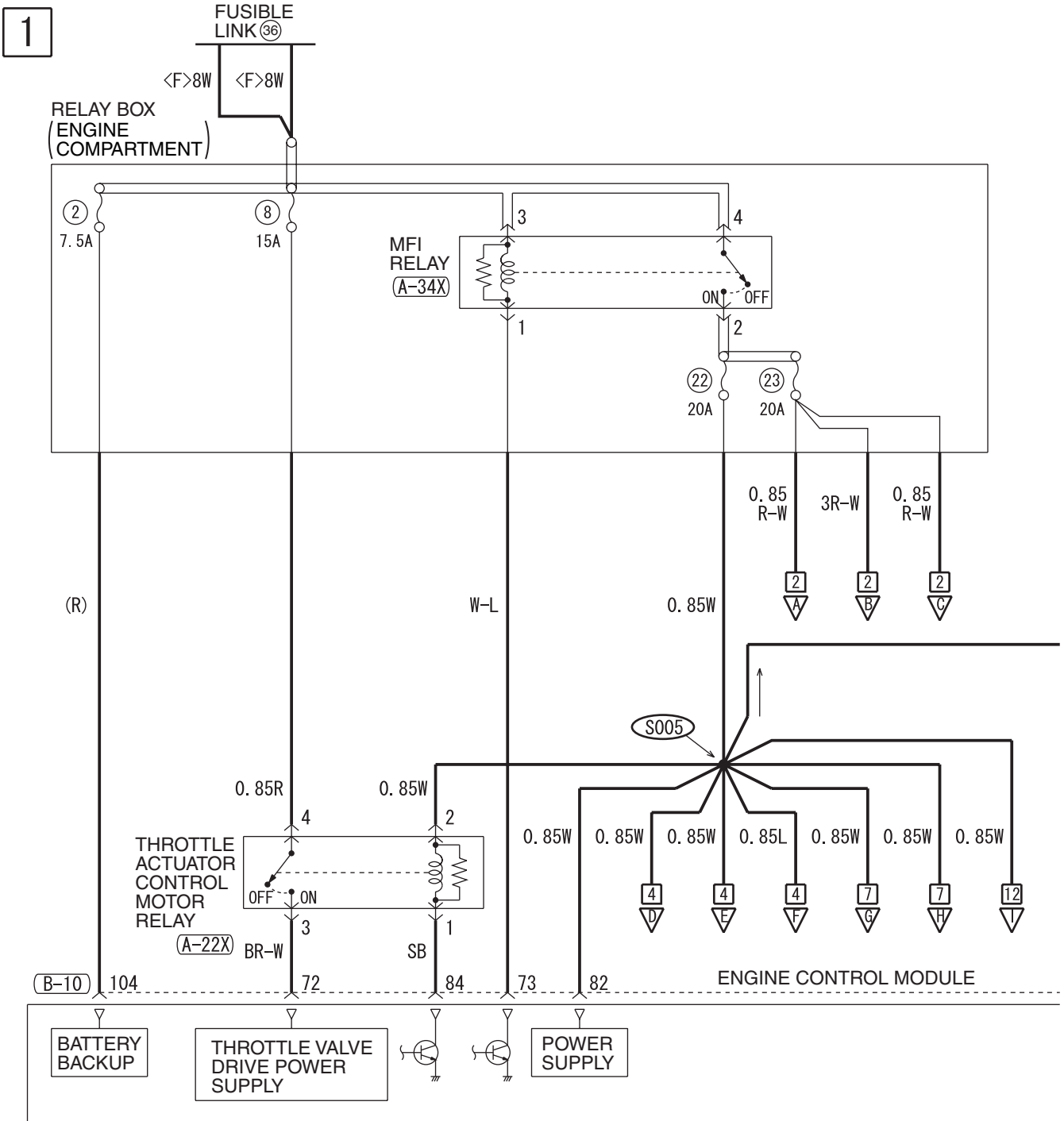

(A-13)

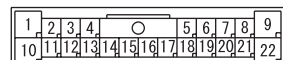

(A-22X)



(A-25X)



(A-27X)



(A-34X)



(A-58)



(B-09)

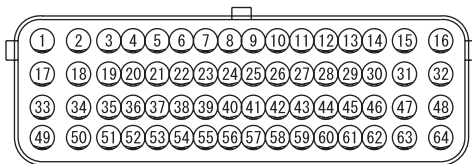

(C-317)

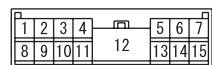

(D-22)



H8G05M05AA

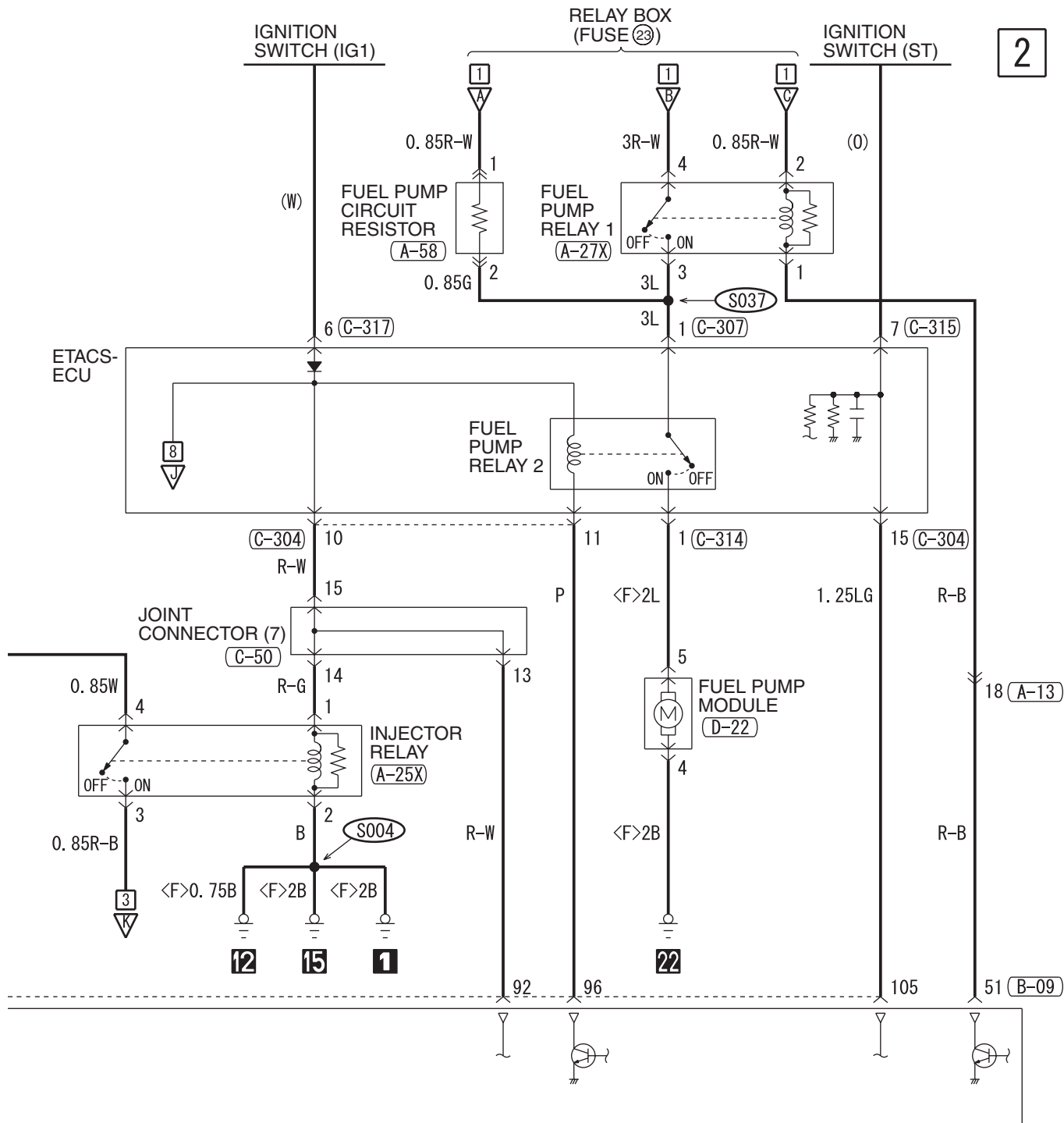

(B-10)

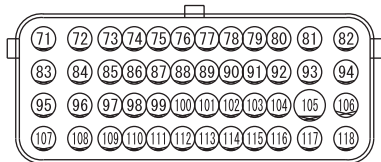

(C-50)

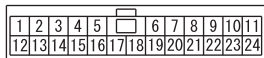

(C-304)

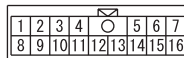

(C-307)



(C-314)



(C-315)

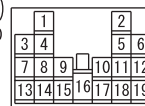

WIRE COLOR CODE

B: BLACK LG: LIGHT GREEN G: GREEN L: BLUE W: WHITE
Y: YELLOW SB: SKY BLUE BR: BROWN O: ORANGE GR: GRAY
R: RED P: PINK V: VIOLET PU: PURPLE SI: SILVER

H8G05M05AB

MFI SYSTEM <TC-SST> (CONTINUED)

3

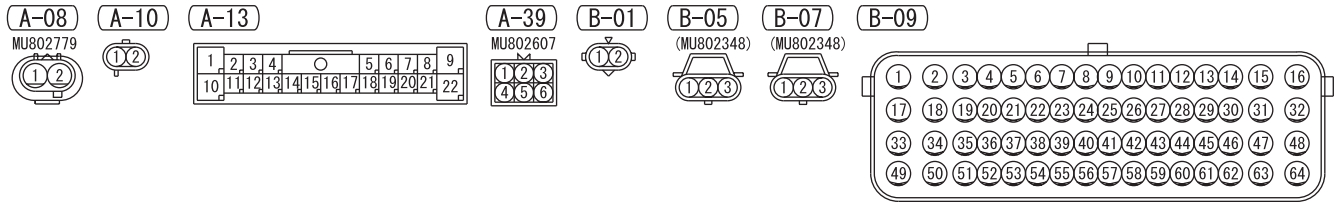
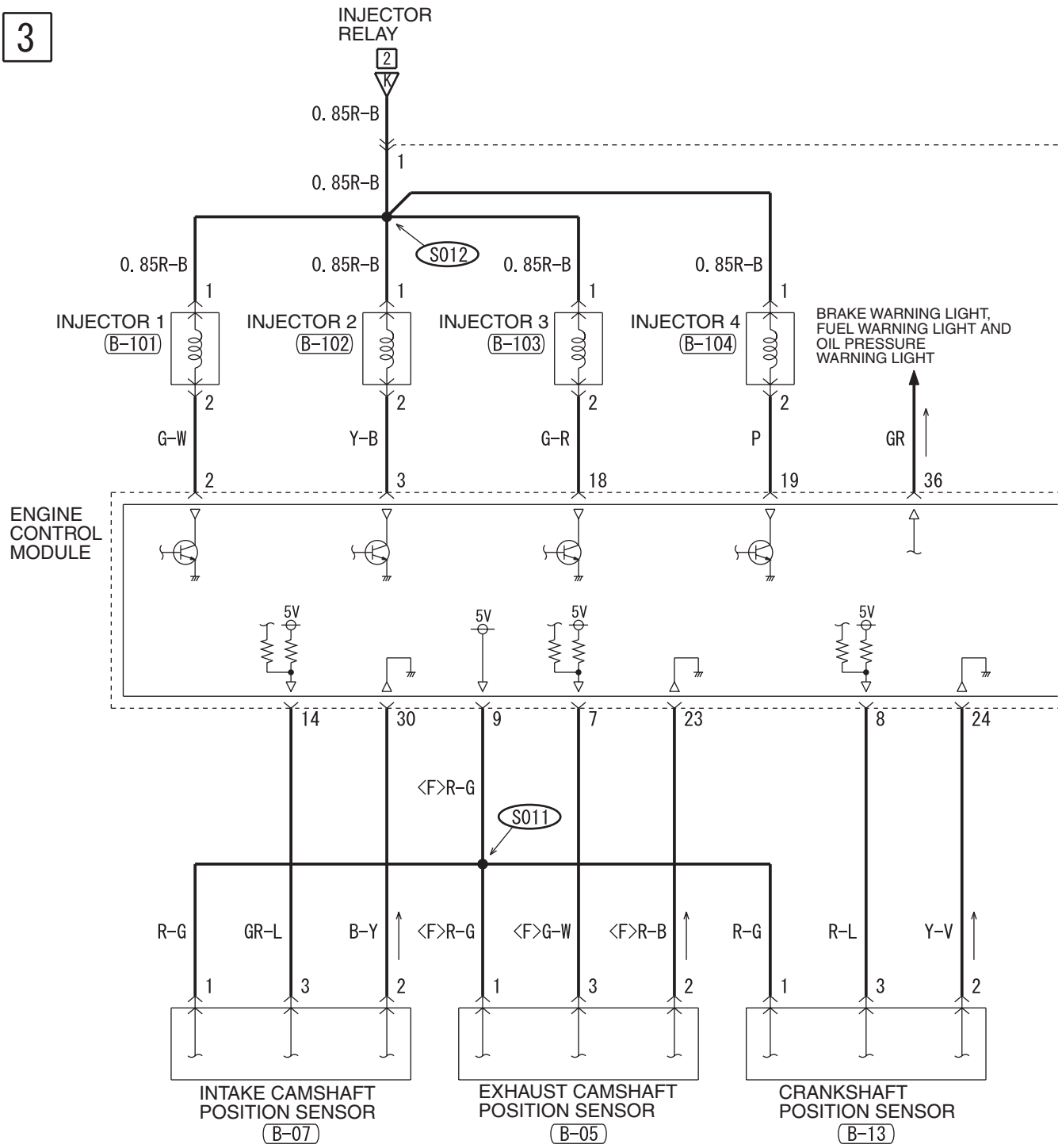

H8G05M05BA

4

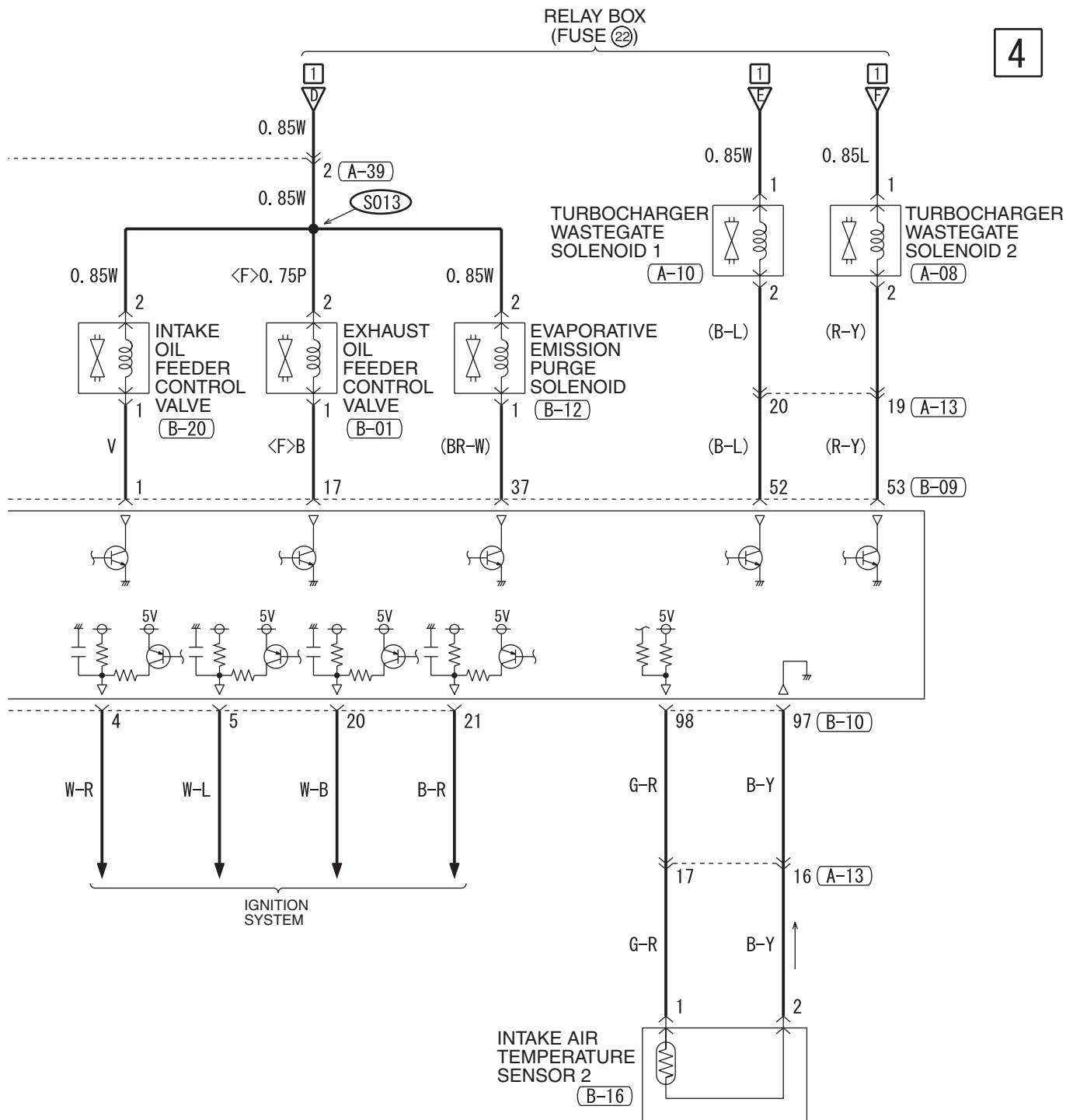

(B-10)

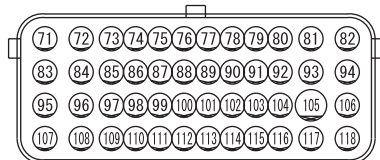

(B-12)



(B-13)



(B-16)



(B-20)



(B-101)



(B-102)



(B-103)



(B-104)



WIRE COLOR CODE

B : BLACK LG : LIGHT GREEN G : GREEN L : BLUE W : WHITE
Y : YELLOW SB : SKY BLUE BR : BROWN O : ORANGE GR : GRAY
R : RED P : PINK V : VIOLET PU : PURPLE SI : SILVER

H8G05M05BB

MFI SYSTEM <TC-SST> (CONTINUED)

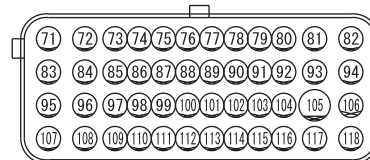
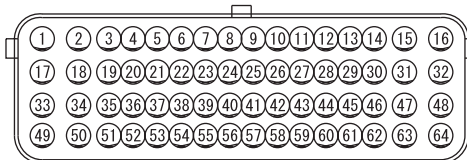
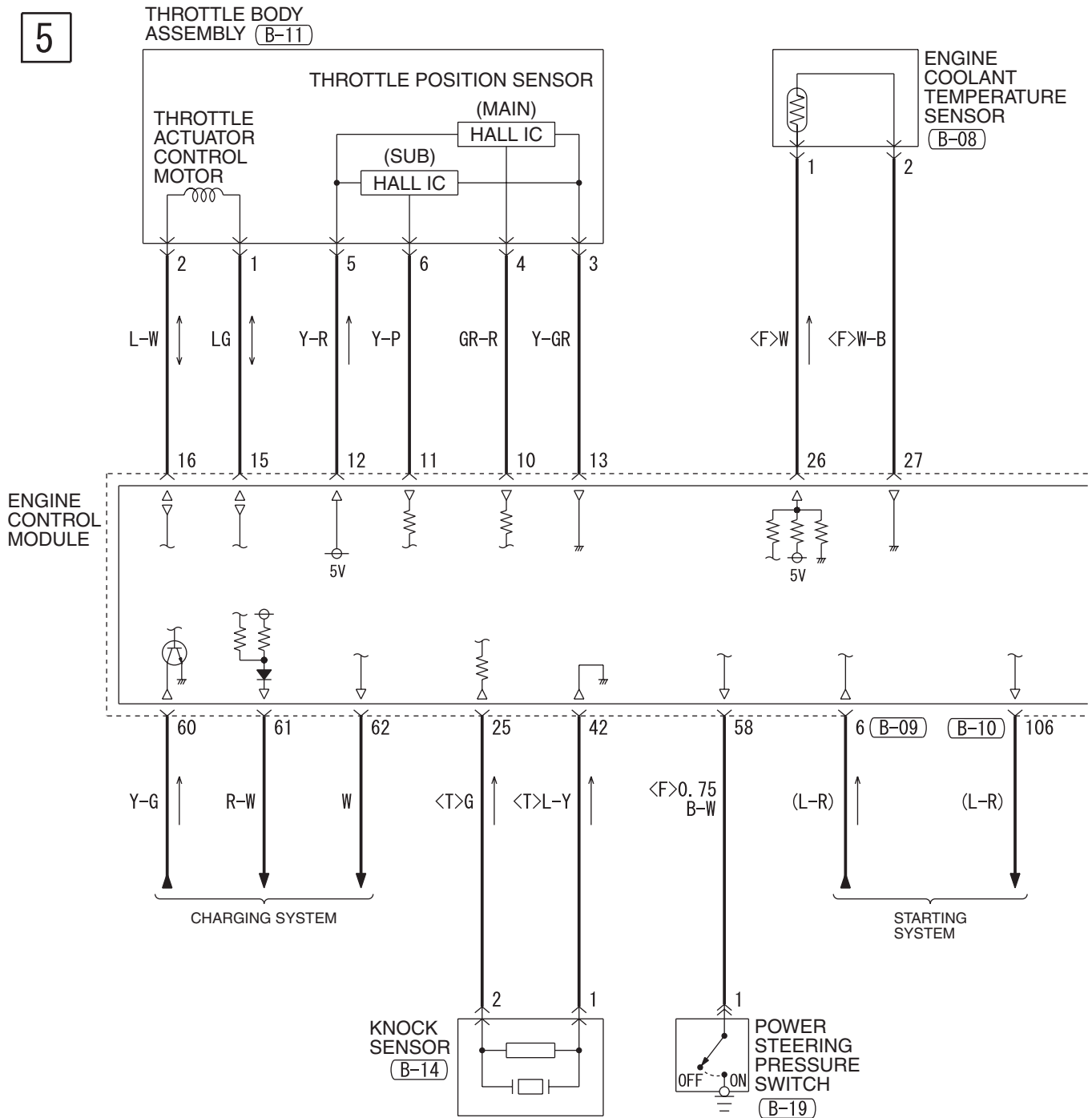

6

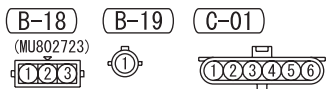
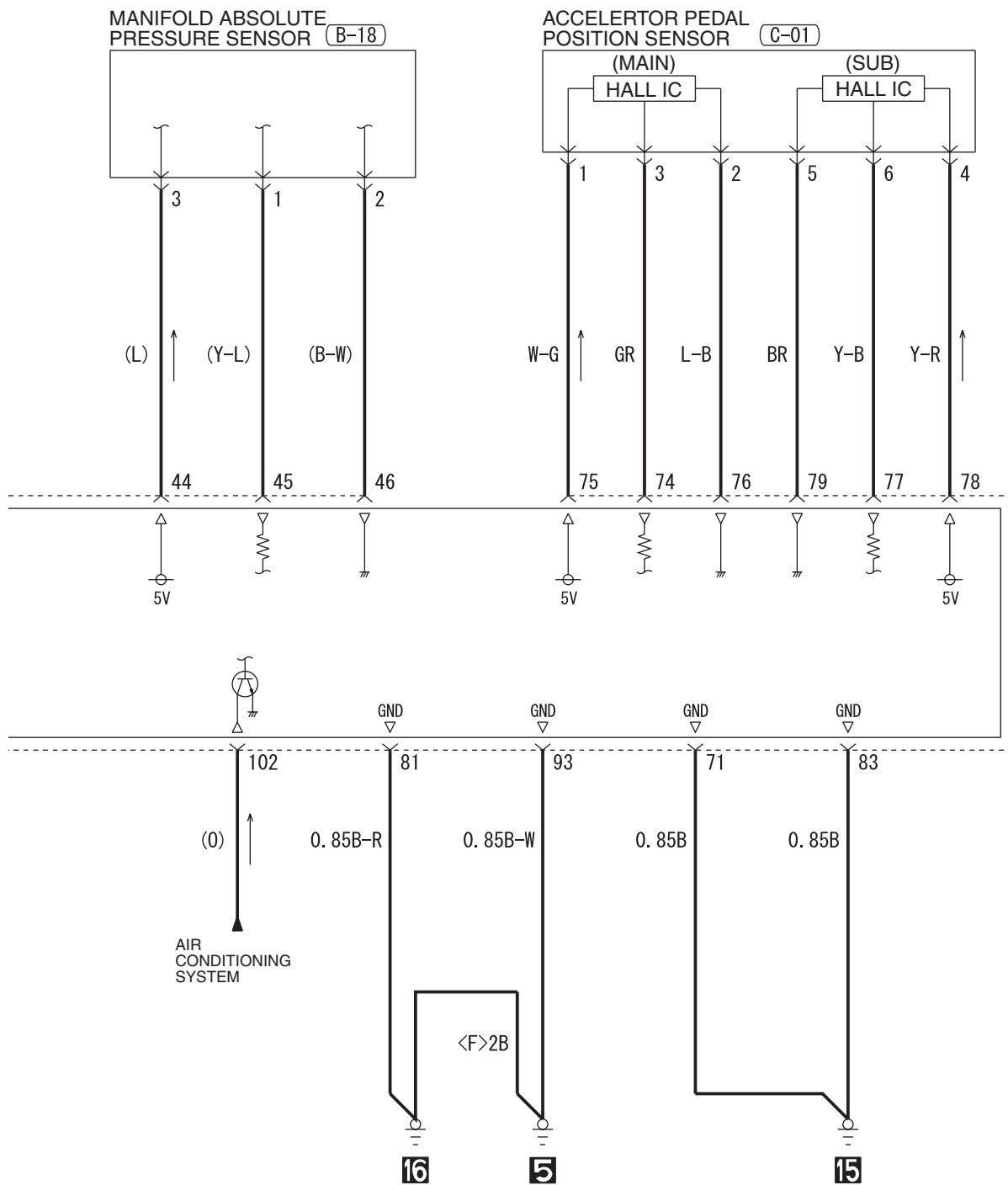

WIRE COLOR CODE
 B: BLACK LG: LIGHT GREEN G: GREEN L: BLUE W: WHITE Y: YELLOW SB: SKY BLUE
 BR: BROWN O: ORANGE GR: GRAY R: RED P: PINK V: VIOLET PU: PURPLE SI: SILVER

H8G05M05CB

MFI SYSTEM <TC-SST> (CONTINUED)

7

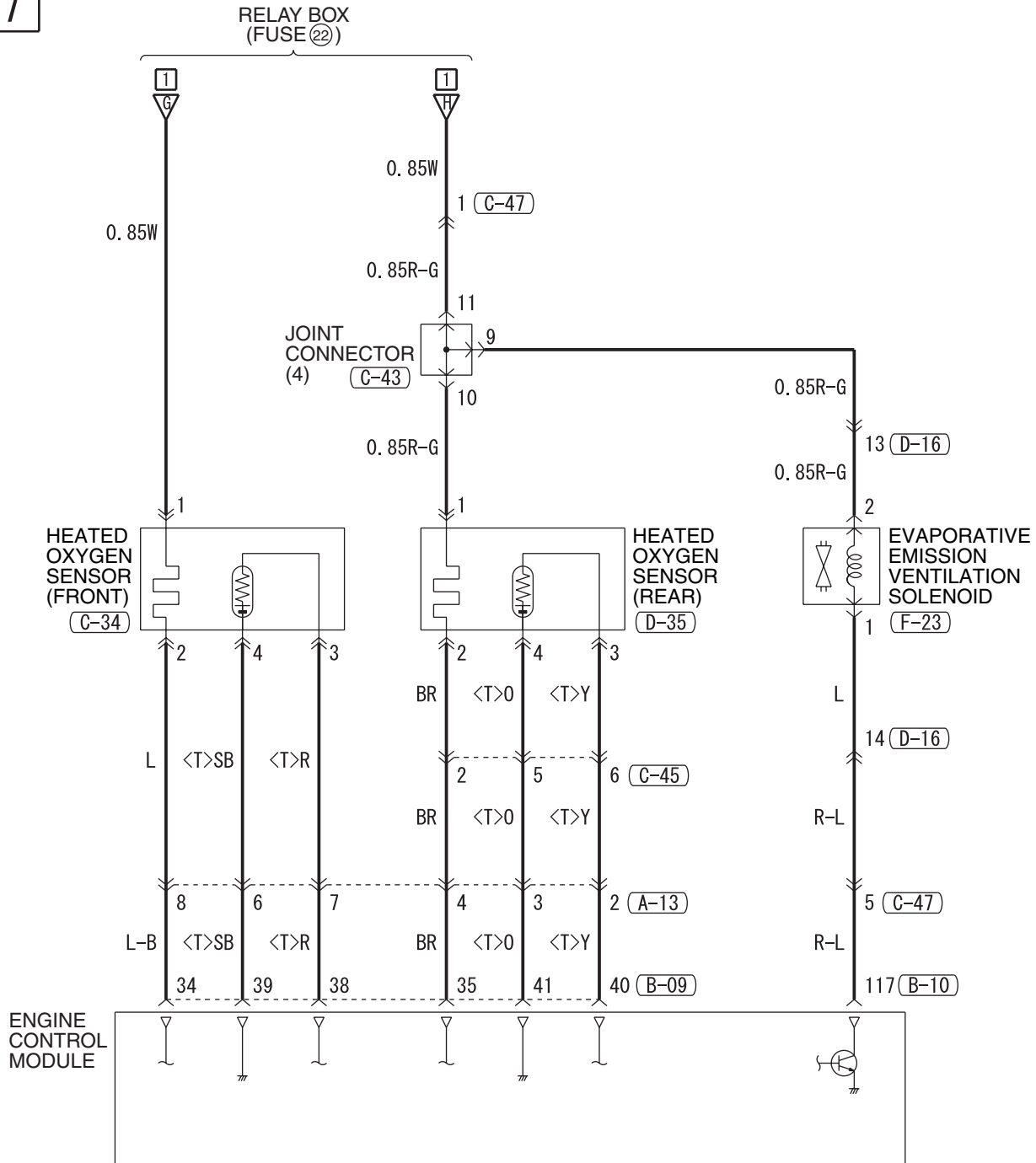

(A-13)

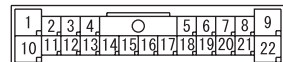

(C-312)

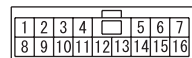

(B-09)

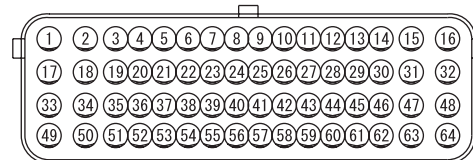

(B-10)

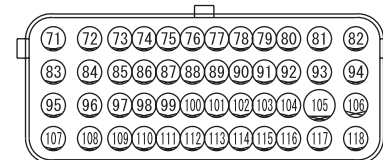

8

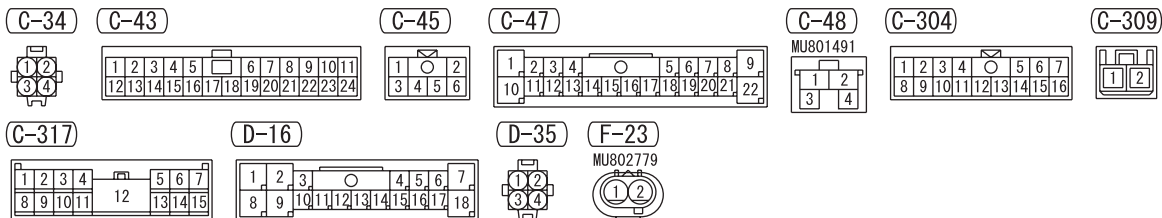
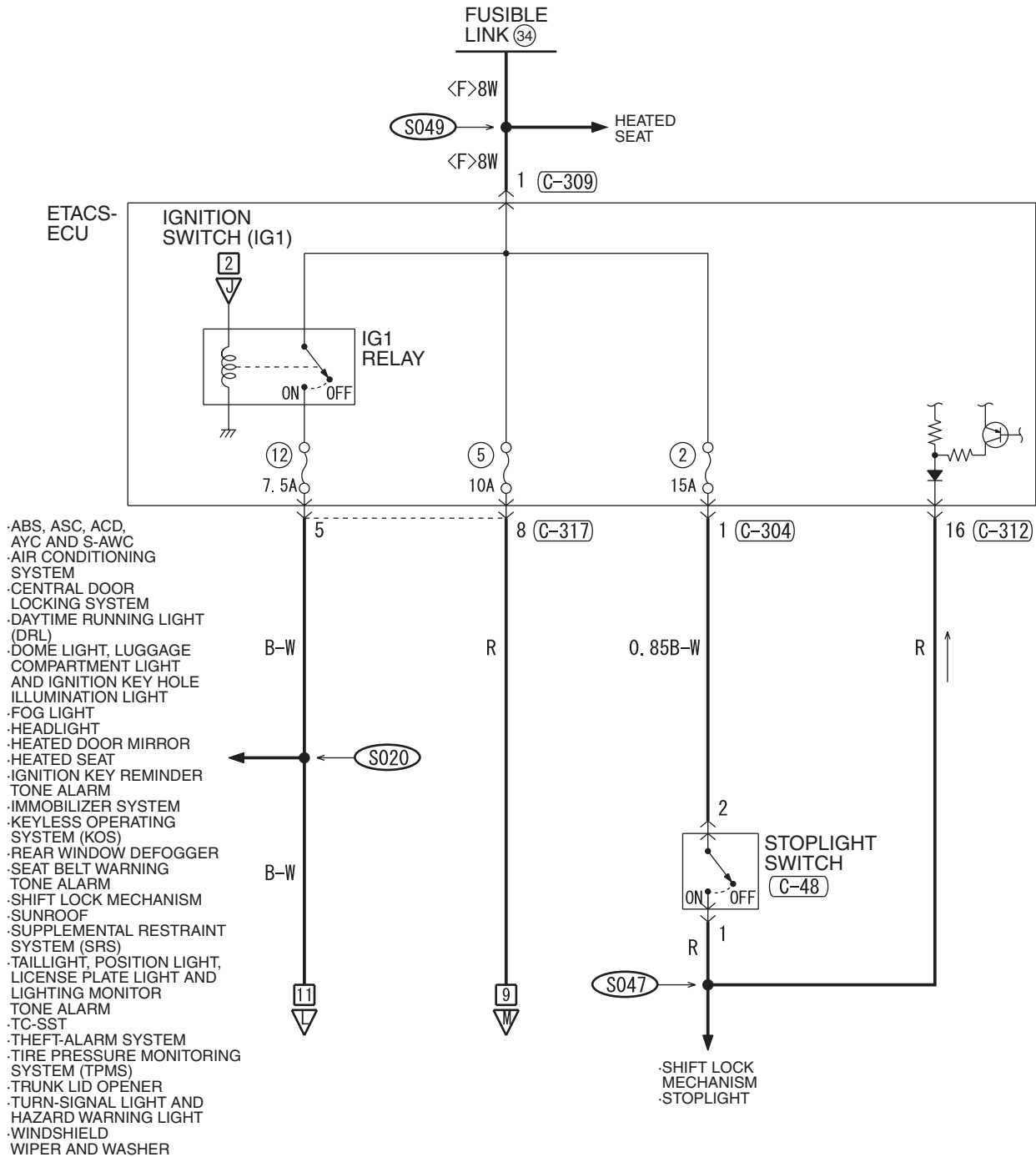

MFI SYSTEM <TC-SST> (CONTINUED)

9

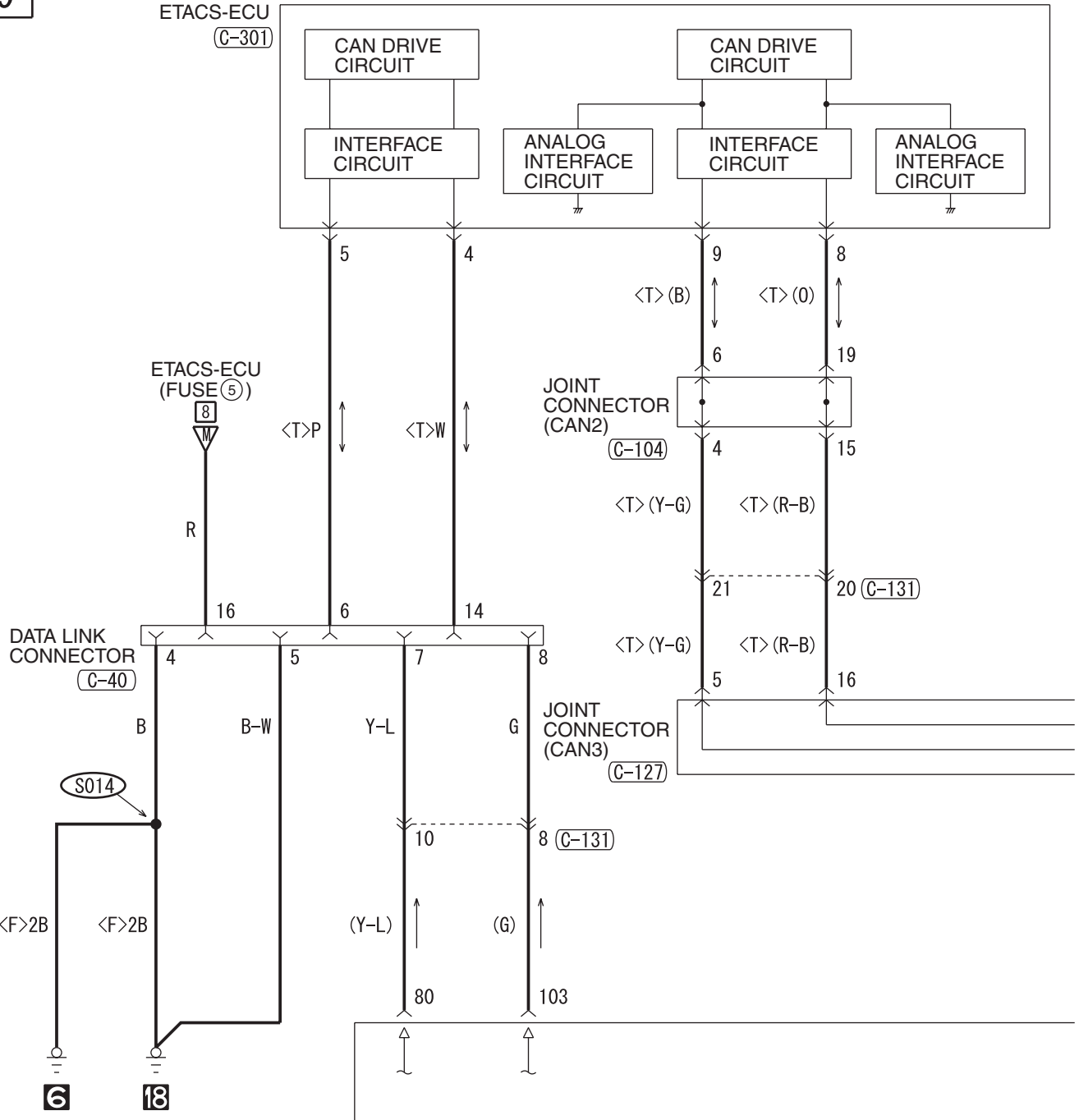

(A-05)

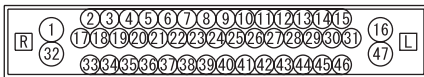

(A-13)

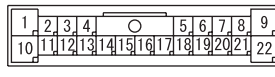

(A-14)

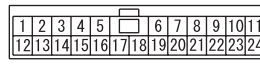

(C-127)

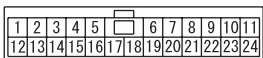

(C-131)

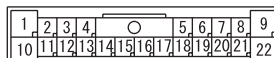

(C-301)

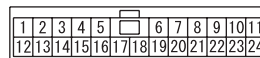

10

NOTE
* : THE TERMINAL NUMBERS DESCRIBED
IN THE CIRCUIT DIAGRAM AGREE WITH
THE NUMBERS MADE ON THE
TRANSAXLE ASSEMBLY CONNECTOR AND
HARNES SIDE CONNECTOR.

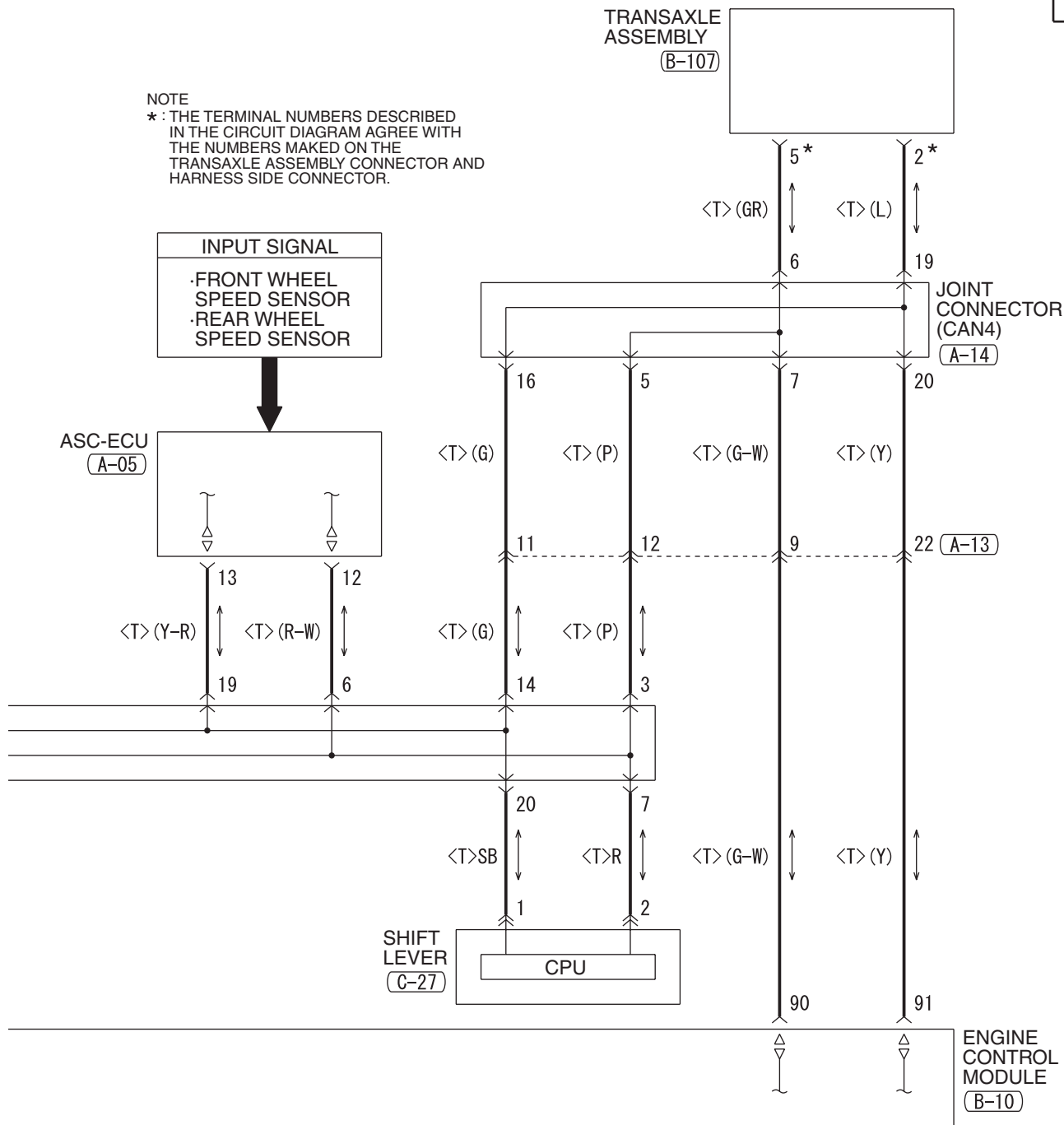

(B-10)

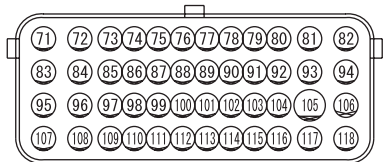

(B-107)*



(C-27)

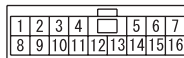

(C-40) FRONT SIDE



(C-104)

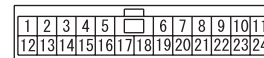

MFI SYSTEM <TC-SST> (CONTINUED)

11

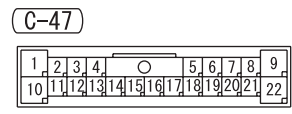
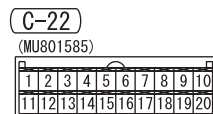
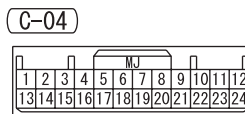
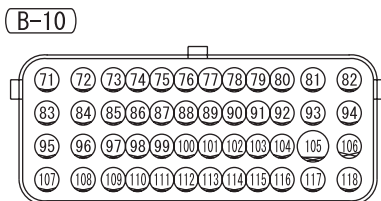
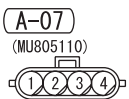
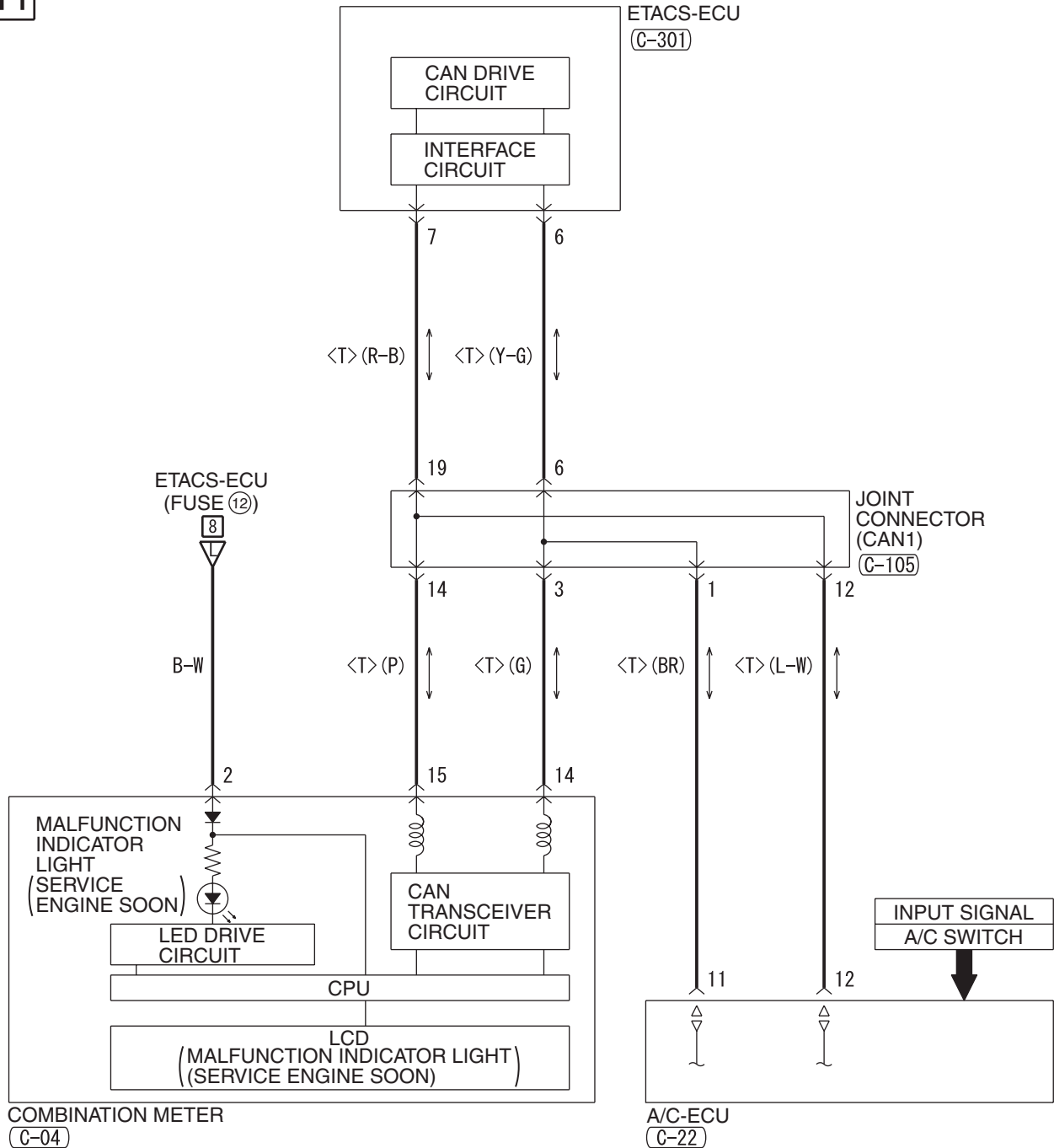

12

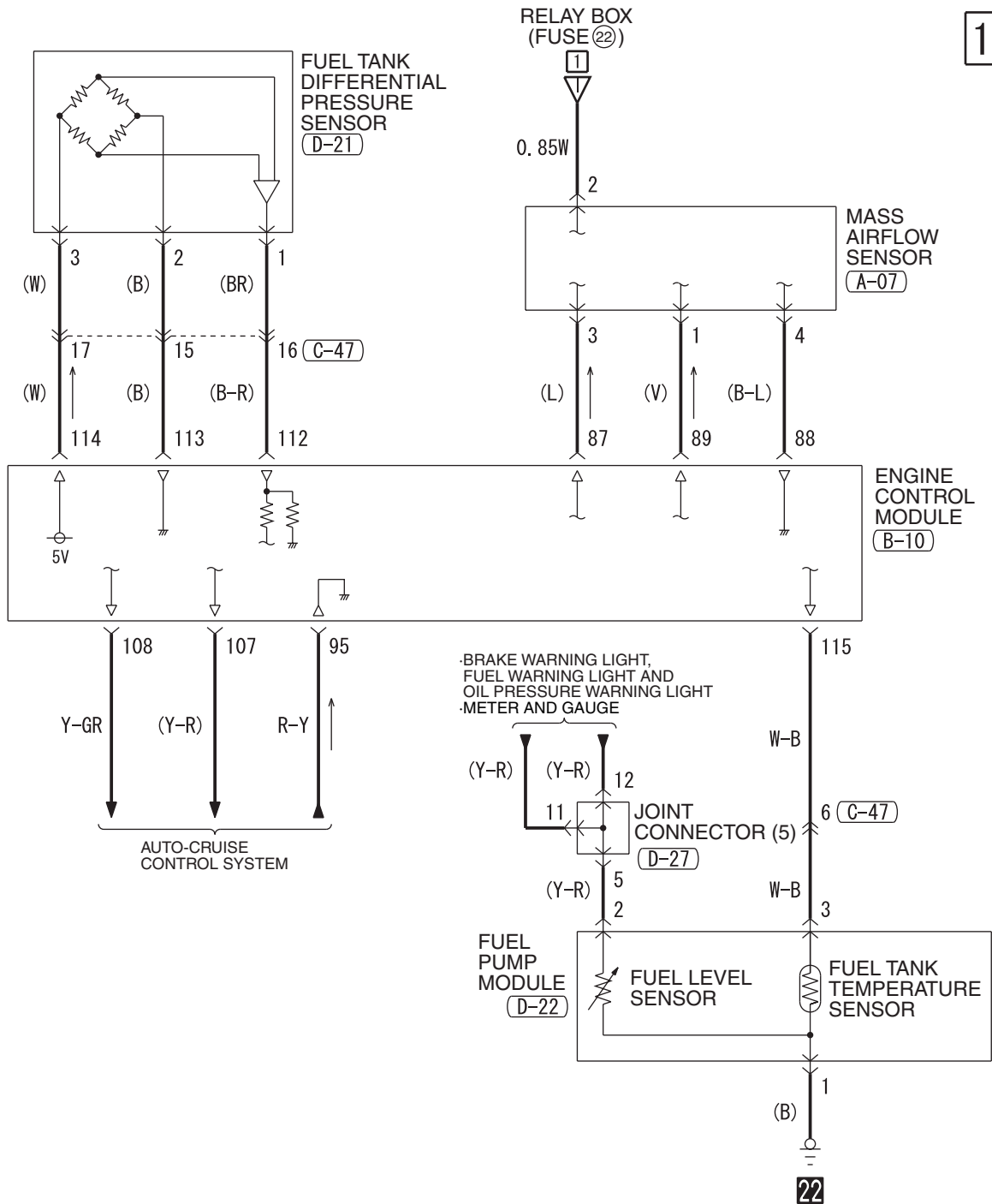

(C-105)

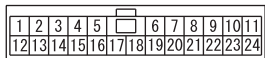

(C-301)

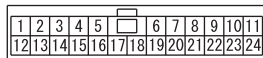

(D-21)



(D-22)



(D-27)

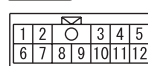

WIRE COLOR CODE

B : BLACK LG : LIGHT GREEN G : GREEN L : BLUE W : WHITE Y : YELLOW SB : SKY BLUE
BR : BROWN O : ORANGE GR : GRAY R : RED P : PINK V : VIOLET PU : PURPLE SI : SILVER

COOLING SYSTEM

M1901001002795

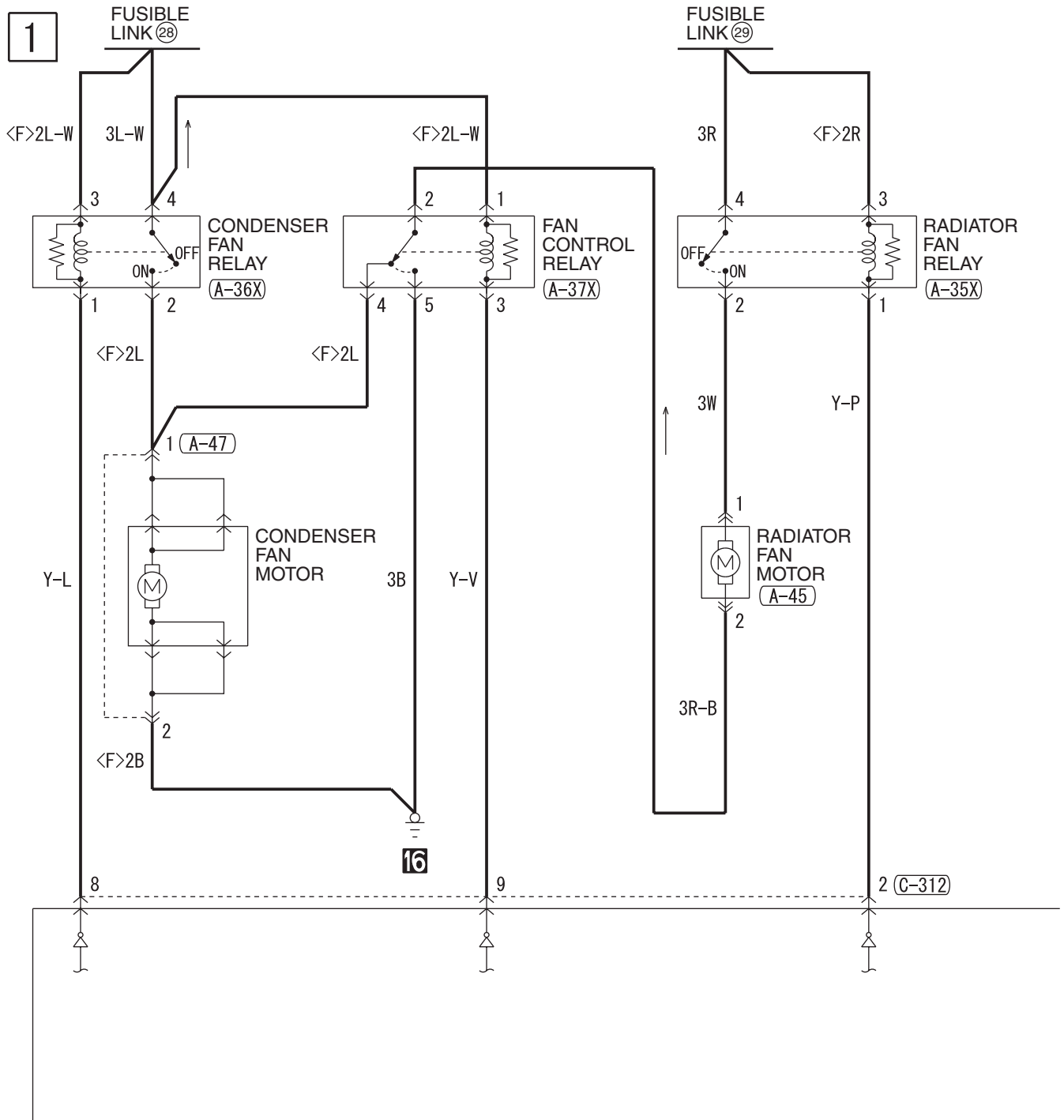

(A-05)

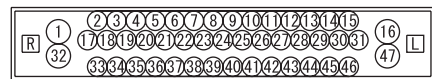

(A-13)

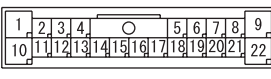

(A-14)

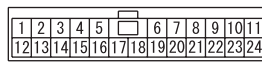

(A-35X)



(A-36X)



(A-37X)



(C-131)

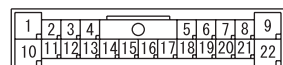

(C-301)

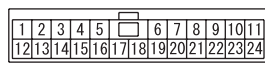

(C-312)

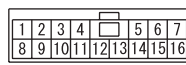

H8G06M03AA

2

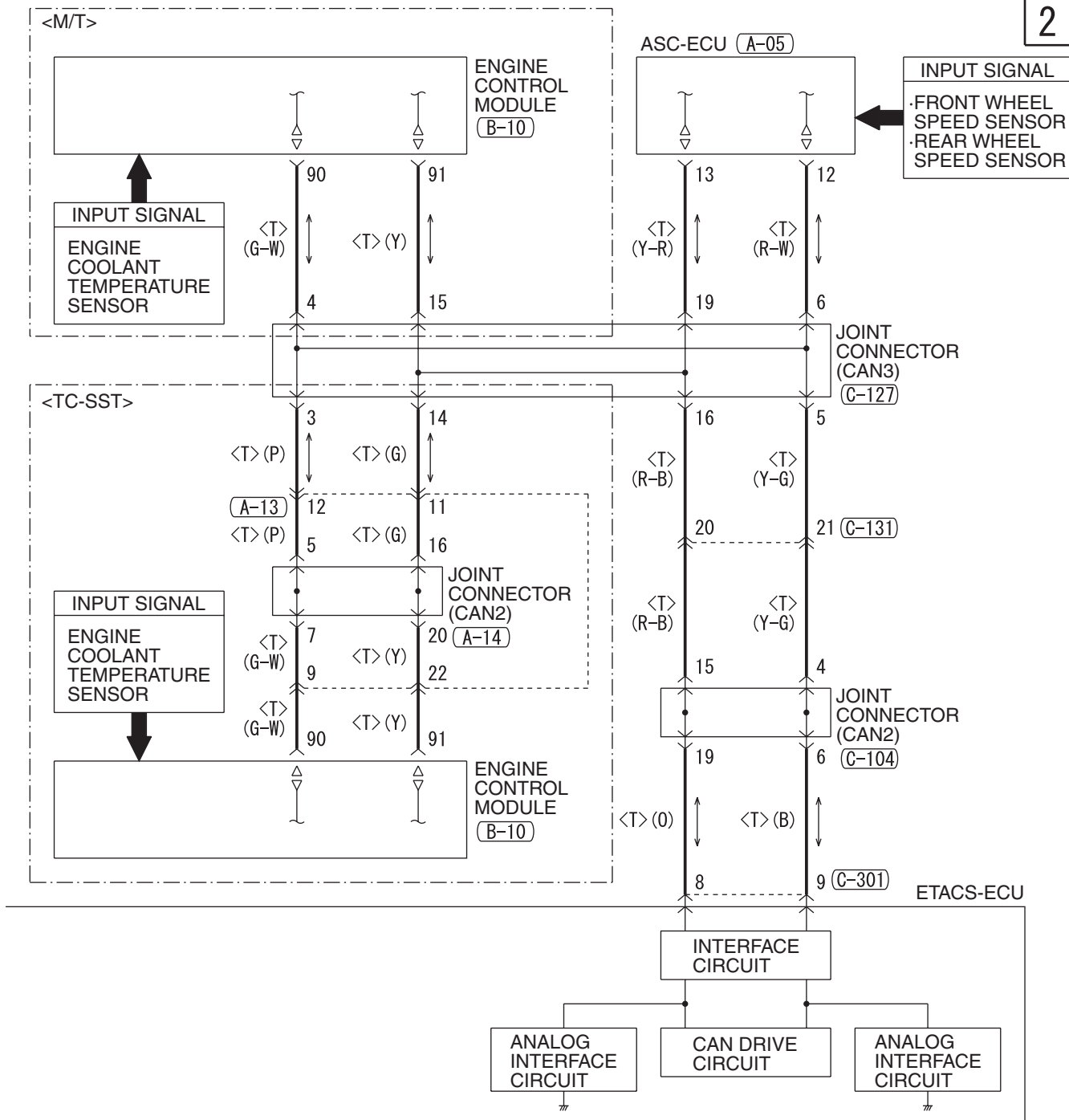

(A-45) (A-47) (B-10)

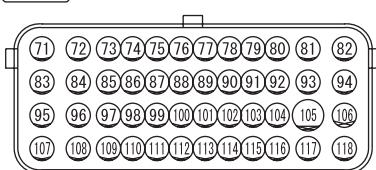

(C-104)

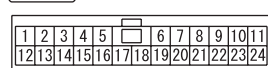

(C-127)

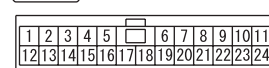

COOLING SYSTEM (CONTINUED)

3

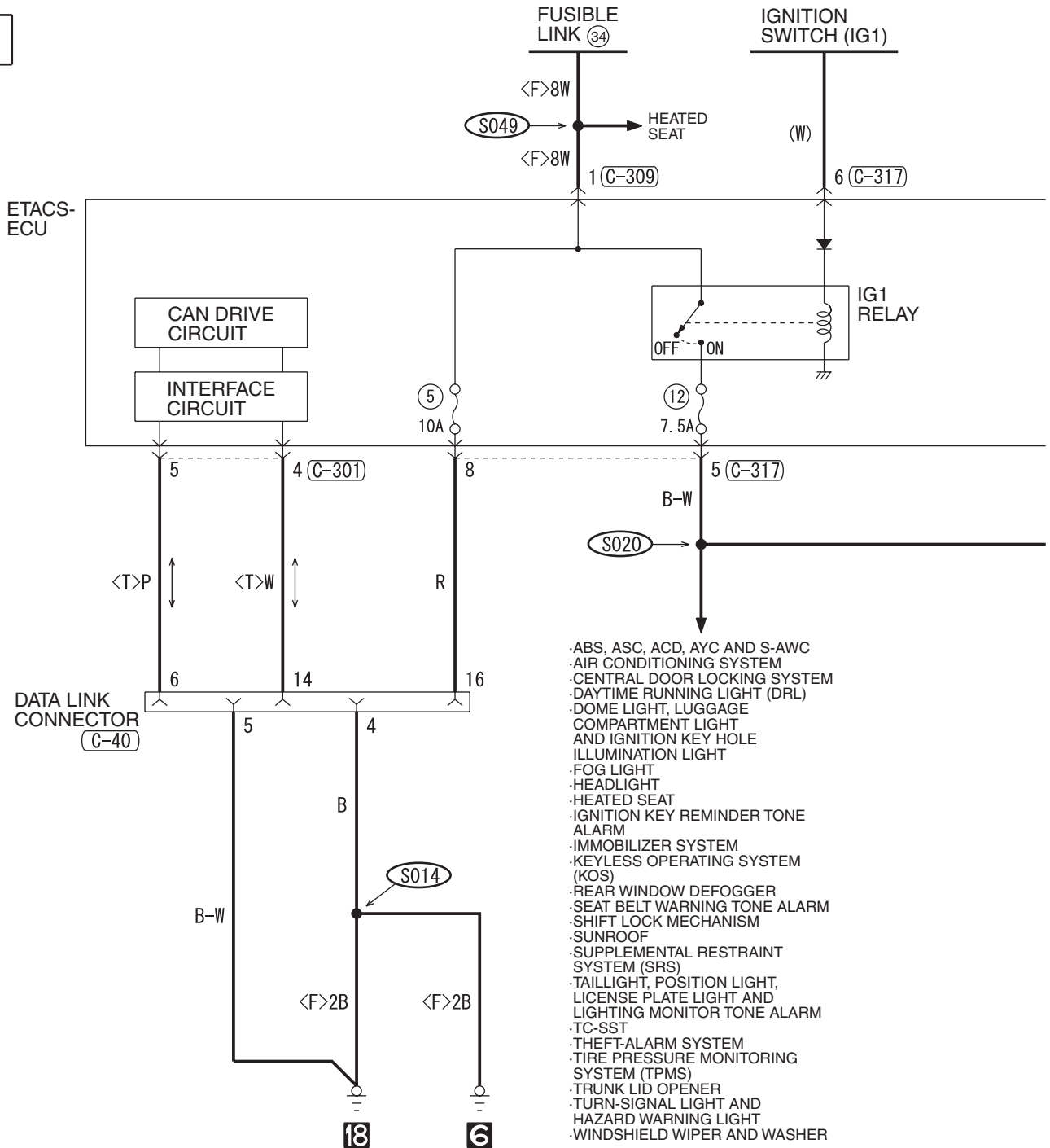

- ABS, ASC, ACD, AYC AND S-AWC
- AIR CONDITIONING SYSTEM
- CENTRAL DOOR LOCKING SYSTEM
- DAYTIME RUNNING LIGHT (DRL)
- DOME LIGHT, LUGGAGE COMPARTMENT LIGHT AND IGNITION KEY HOLE ILLUMINATION LIGHT
- FOG LIGHT
- HEADLIGHT
- HEATED SEAT
- IGNITION KEY REMINDER TONE ALARM
- IMMOBILIZER SYSTEM
- KEYLESS OPERATING SYSTEM (KOS)
- REAR WINDOW DEFOGGER
- SEAT BELT WARNING TONE ALARM
- SHIFT LOCK MECHANISM
- SUNROOF
- SUPPLEMENTAL RESTRAINT SYSTEM (SRS)
- TAILLIGHT, POSITION LIGHT, LICENSE PLATE LIGHT AND LIGHTING MONITOR TONE ALARM
- TC-SST
- THEFT-ALARM SYSTEM
- TIRE PRESSURE MONITORING SYSTEM (TPMS)
- TRUNK LID OPENER
- TURN-SIGNAL LIGHT AND HAZARD WARNING LIGHT
- WINDSHIELD WIPER AND WASHER

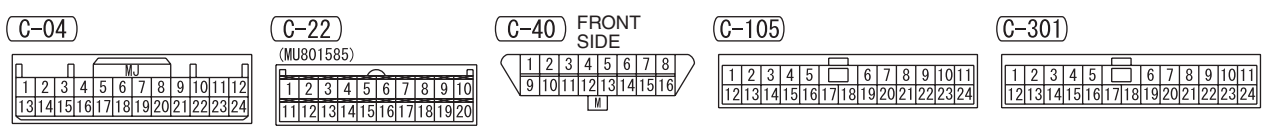

4

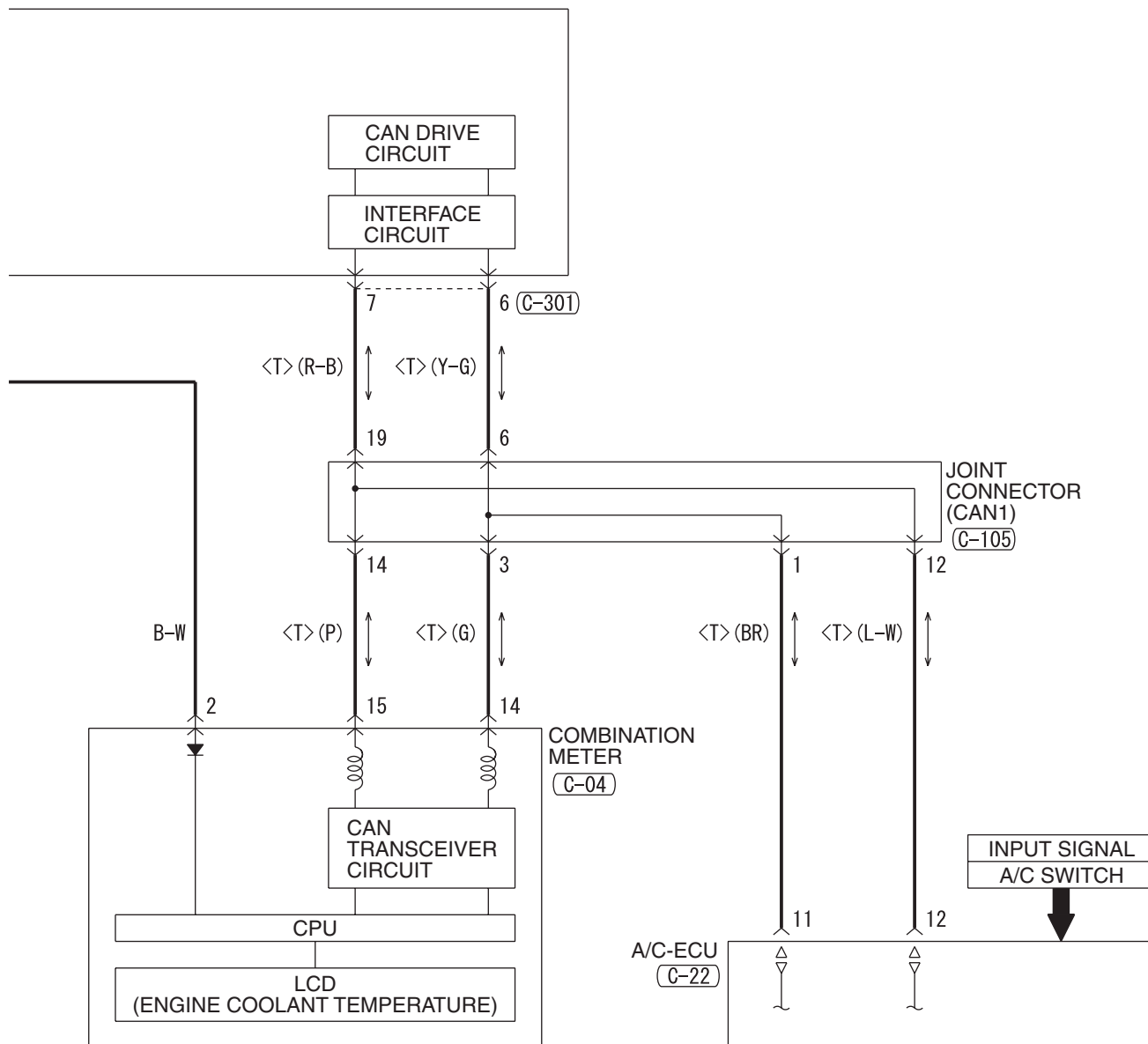

(C-309) (C-317)

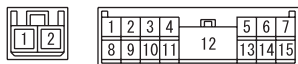

WIRE COLOR CODE
 B: BLACK LG: LIGHT GREEN G: GREEN L: BLUE W: WHITE Y: YELLOW SB: SKY BLUE
 BR: BROWN O: ORANGE GR: GRAY R: RED P: PINK V: VIOLET PU: PURPLE SI: SILVER

H8G06M03BB

TSB Revision

SHIFT LOCK MECHANISM

1

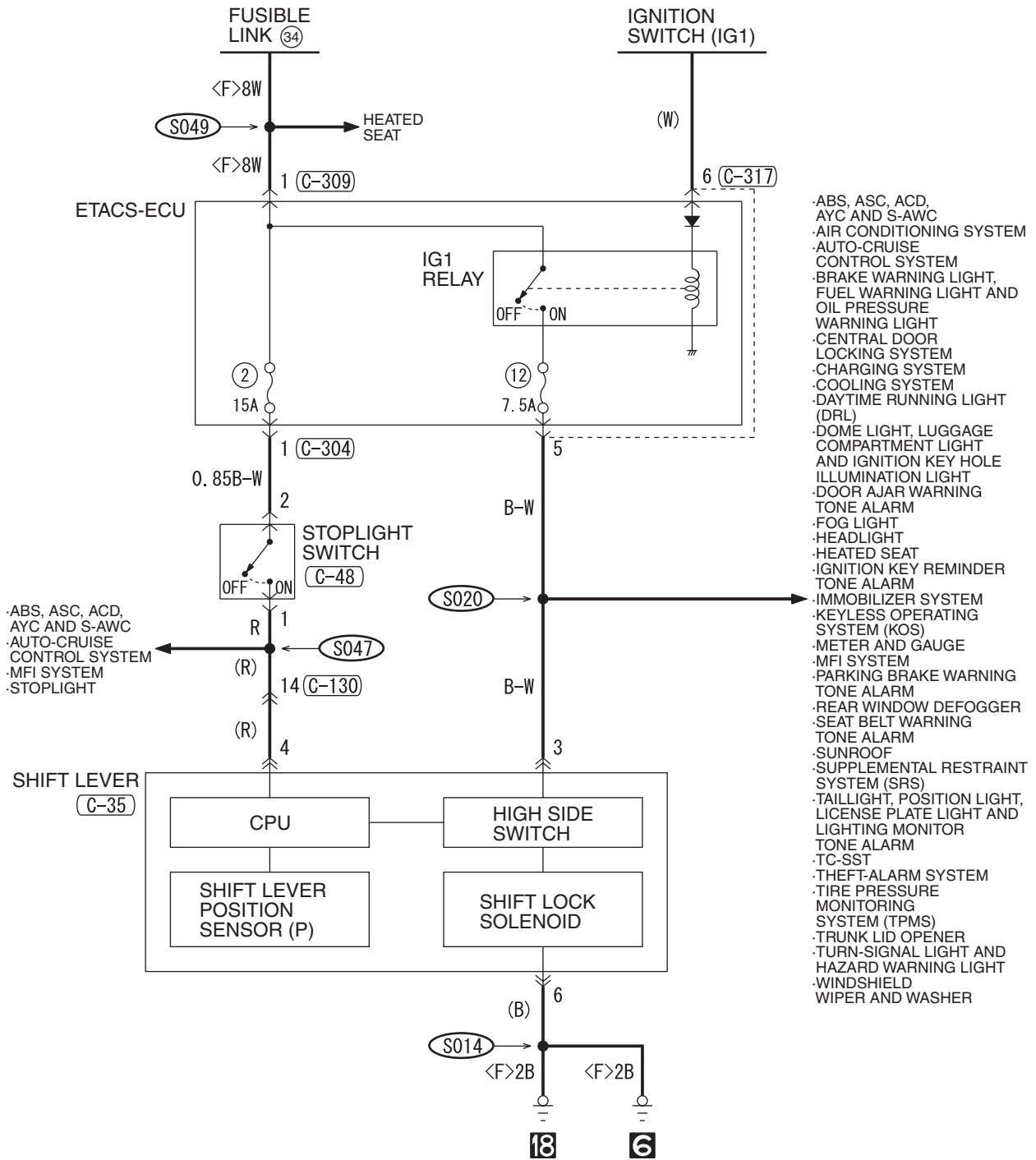

(C-35)

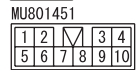

(C-48)



(C-130)

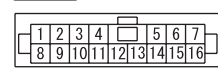

(C-304)

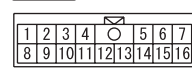

(C-309)



(C-317)

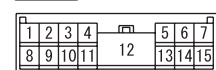

WIRE COLOR CODE

B: BLACK LG: LIGHT GREEN G: GREEN L: BLUE W: WHITE Y: YELLOW SB: SKY BLUE
BR: BROWN O: ORANGE GR: GRAY R: RED P: PINK V: VIOLET PU: PURPLE SI: SILVER

NOTES

TWIN CLUTCH SPORT SHIFT TRANSAXLE (TC-SST)

M1901032300031

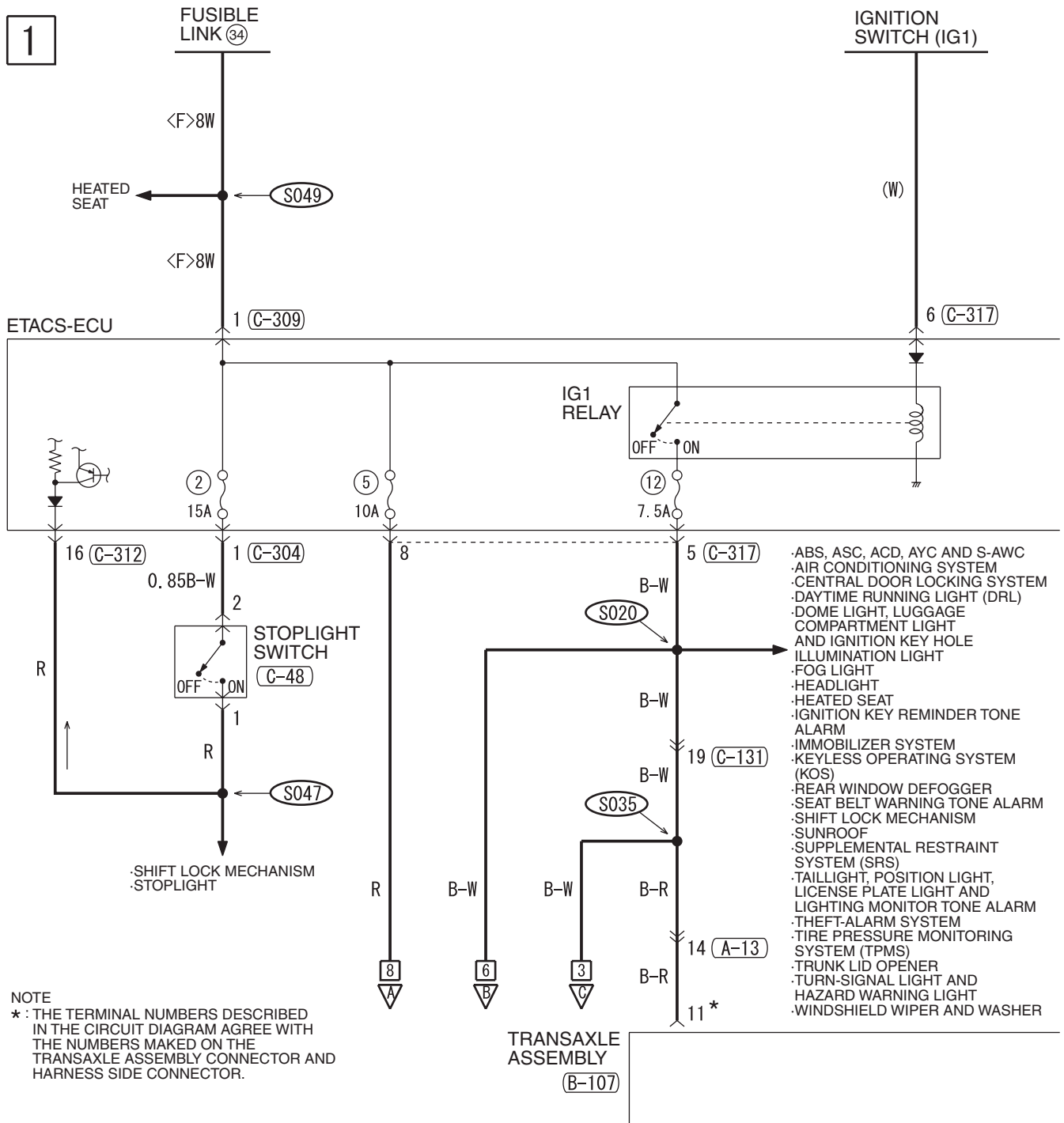

(A-13)

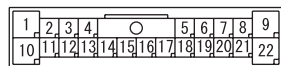

(B-107)*



(C-48)



(C-131)

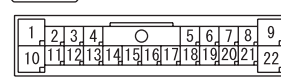

(C-304)

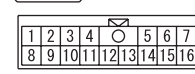

(C-307)



(C-309)



2

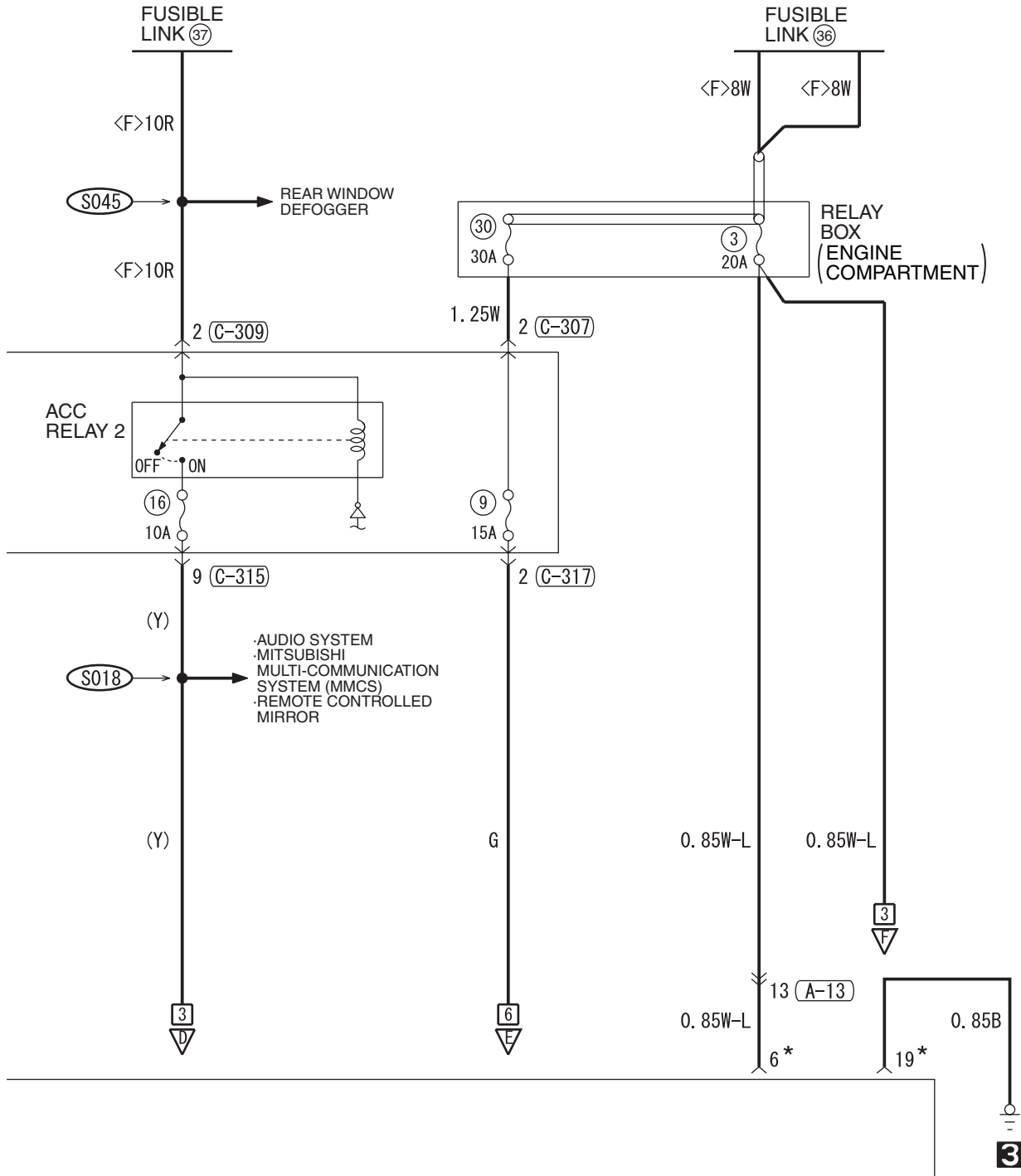

(C-312)

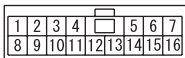

(C-315)

MU801890

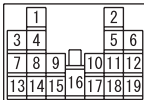

(C-317)

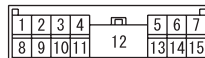

WIRE COLOR CODE

B: BLACK LG: LIGHT GREEN G: GREEN L: BLUE W: WHITE Y: YELLOW SB: SKY BLUE
BR: BROWN O: ORANGE GR: GRAY R: RED P: PINK V: VIOLET PU: PURPLE SI: SILVER

H8G07M06AB

TWIN CLUTCH SPORT SHIFT TRANSAXLE (TC-SST) (CONTINUED)

3

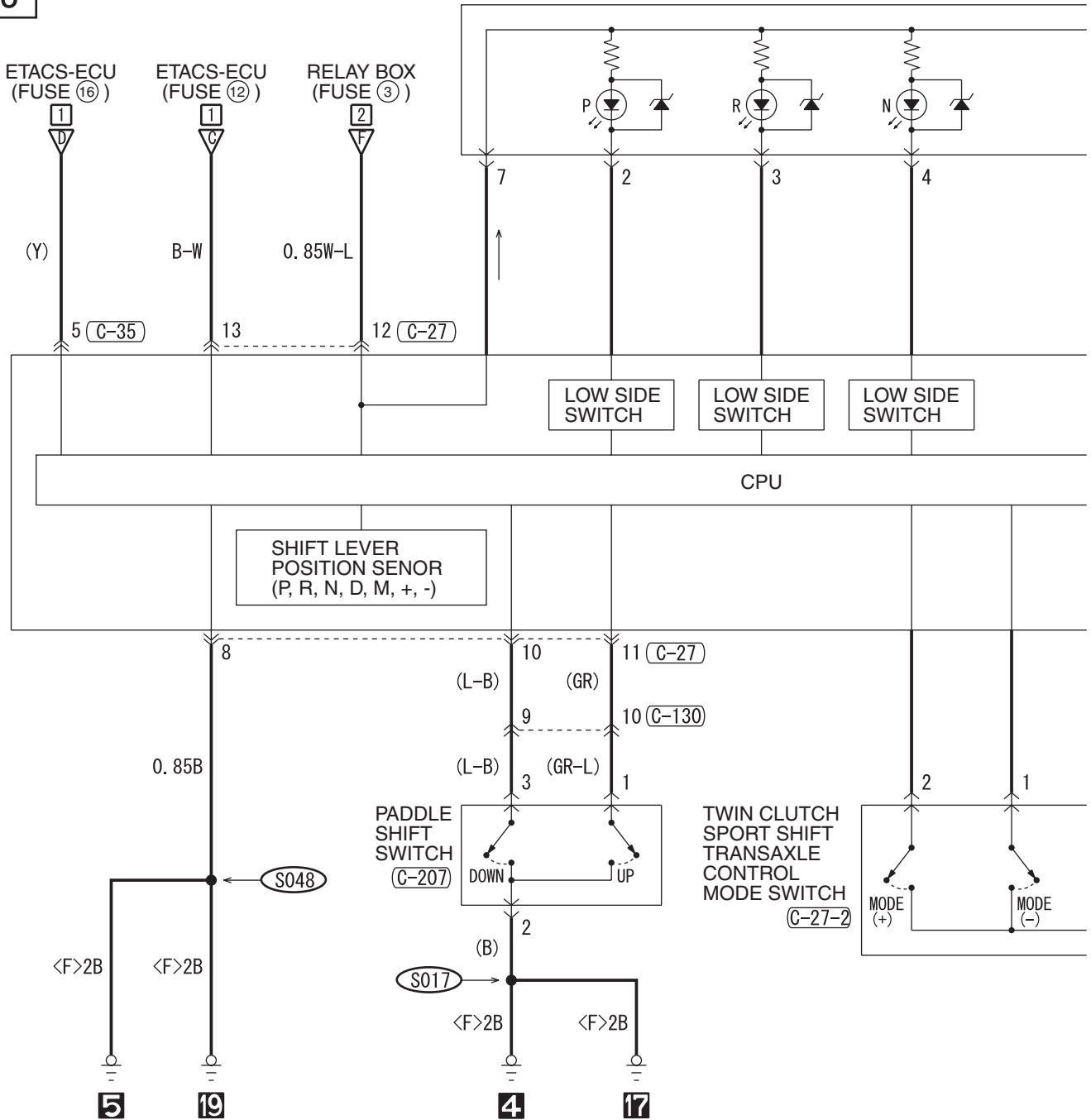

(C-27)

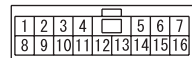

(C-27-1)

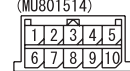

(C-27-2)

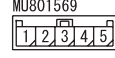

(C-35)



(C-101)

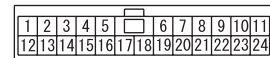

(C-130)

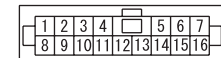

(C-207)



4

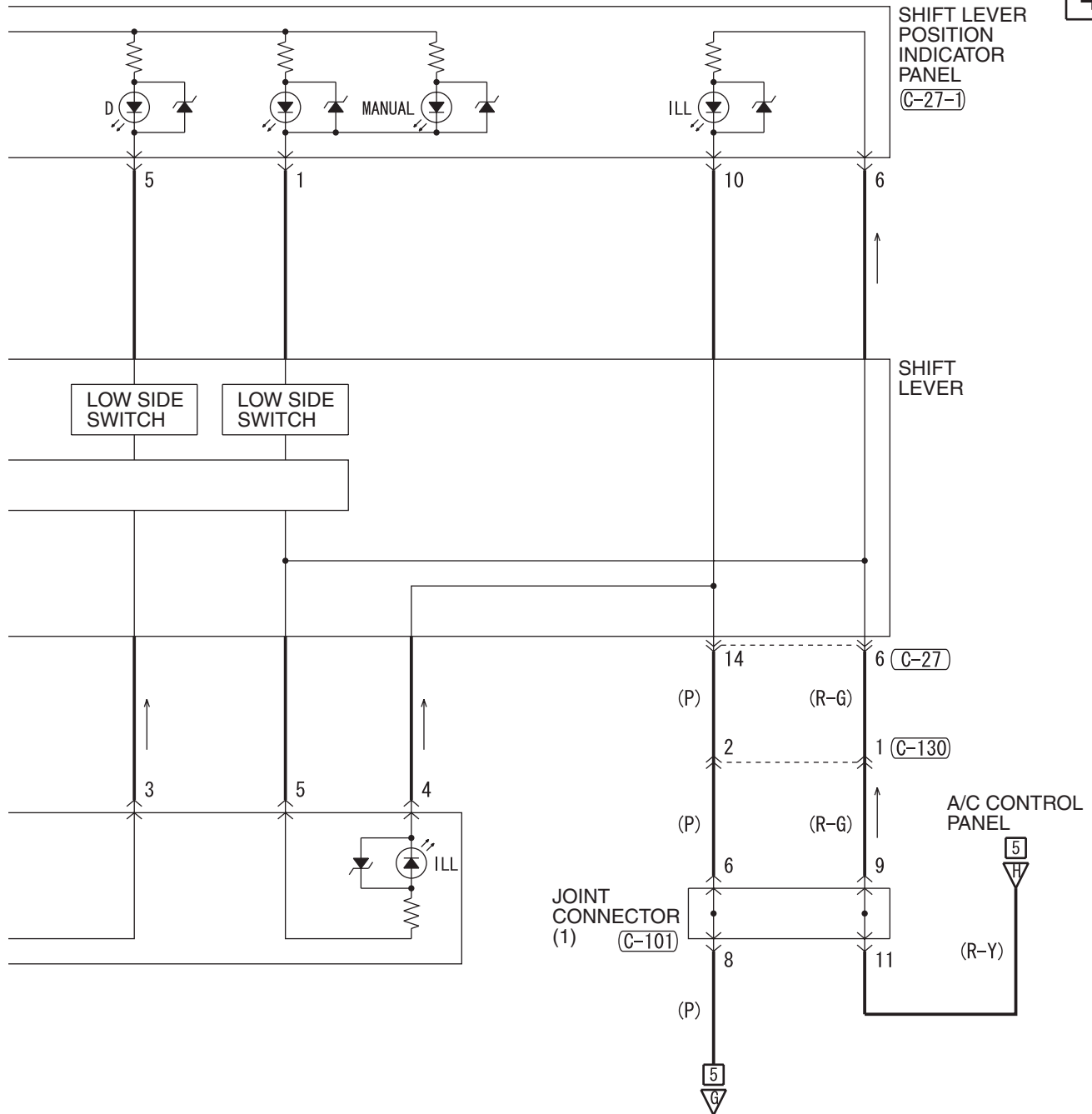

WIRE COLOR CODE
 B: BLACK LG: LIGHT GREEN G: GREEN L: BLUE W: WHITE Y: YELLOW SB: SKY BLUE
 BR: BROWN O: ORANGE GR: GRAY R: RED P: PINK V: VIOLET PU: PURPLE SI: SILVER

H8G07M06BB

TSB Revision

TWIN CLUTCH SPORT SHIFT TRANSAXLE (TC-SST) (CONTINUED)

5

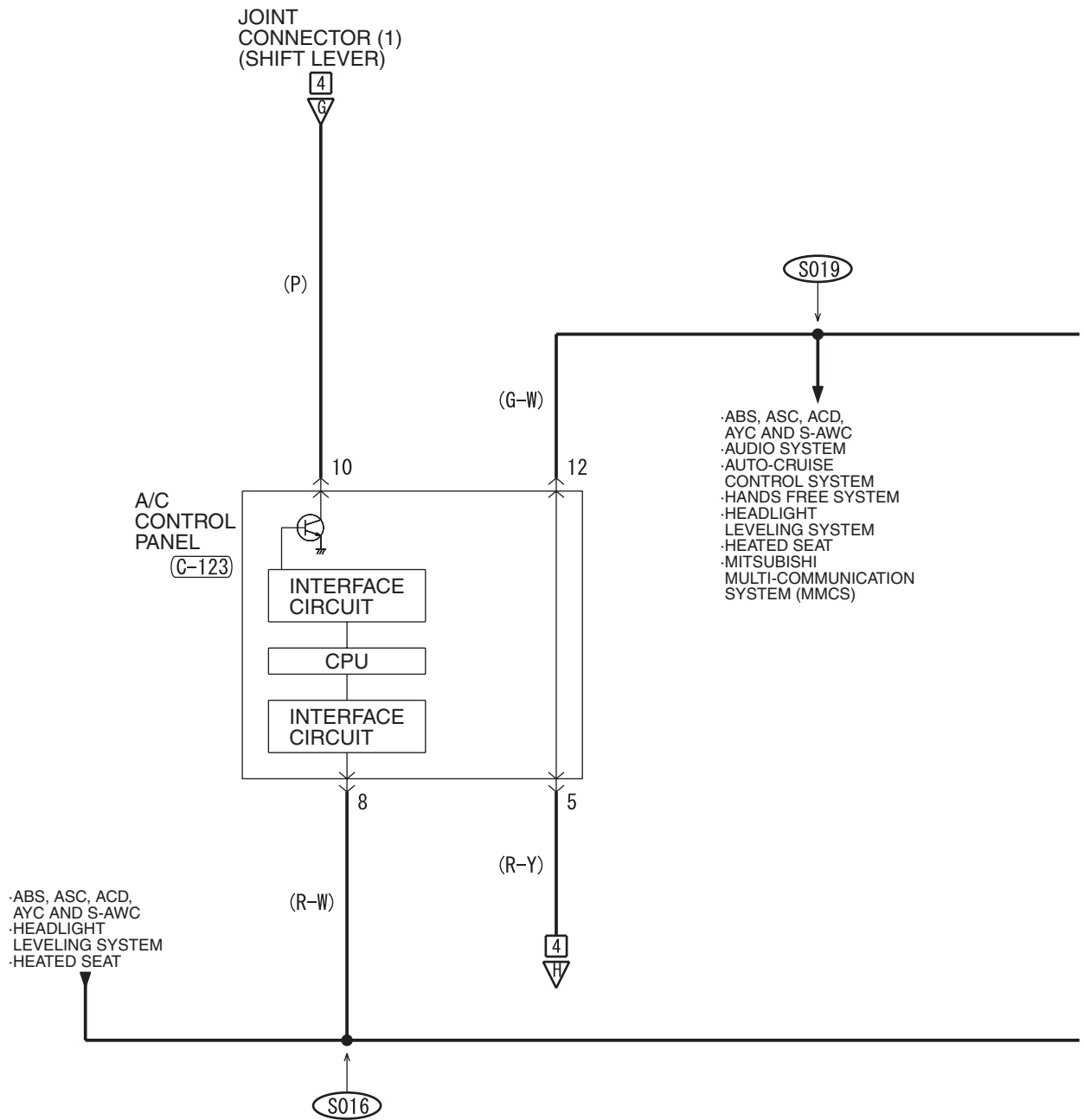

(C-04)

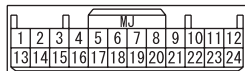

(C-103)

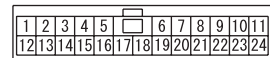

(C-105)

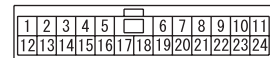

(C-123)

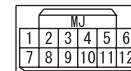

6

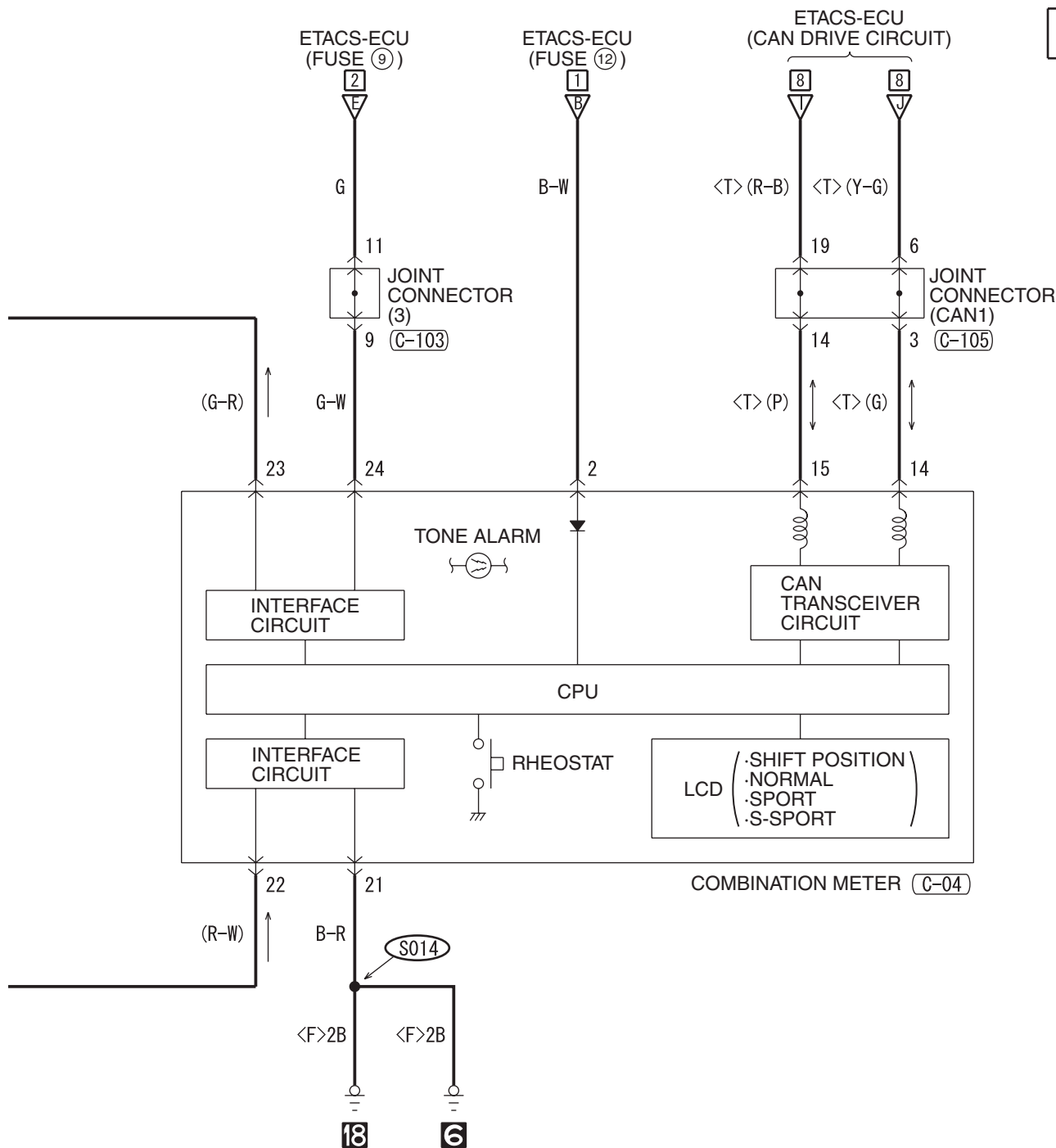

WIRE COLOR CODE

B : BLACK LG : LIGHT GREEN G : GREEN L : BLUE W : WHITE Y : YELLOW SB : SKY BLUE
BR : BROWN O : ORANGE GR : GRAY R : RED P : PINK V : VIOLET PU : PURPLE SI : SILVER

H8G07M06CB

TSB Revision

TWIN CLUTCH SPORT SHIFT TRANSAXLE (TC-SST) (CONTINUED)

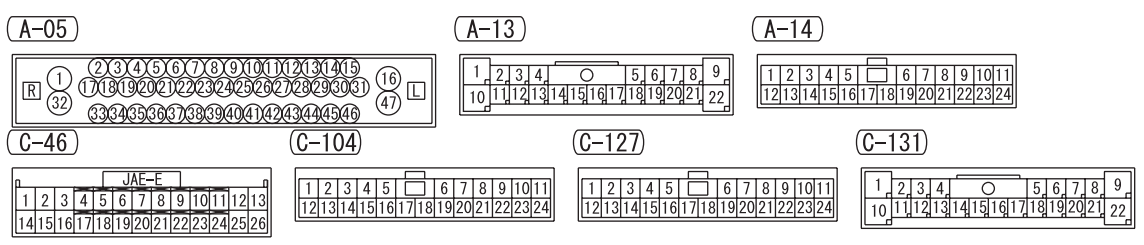
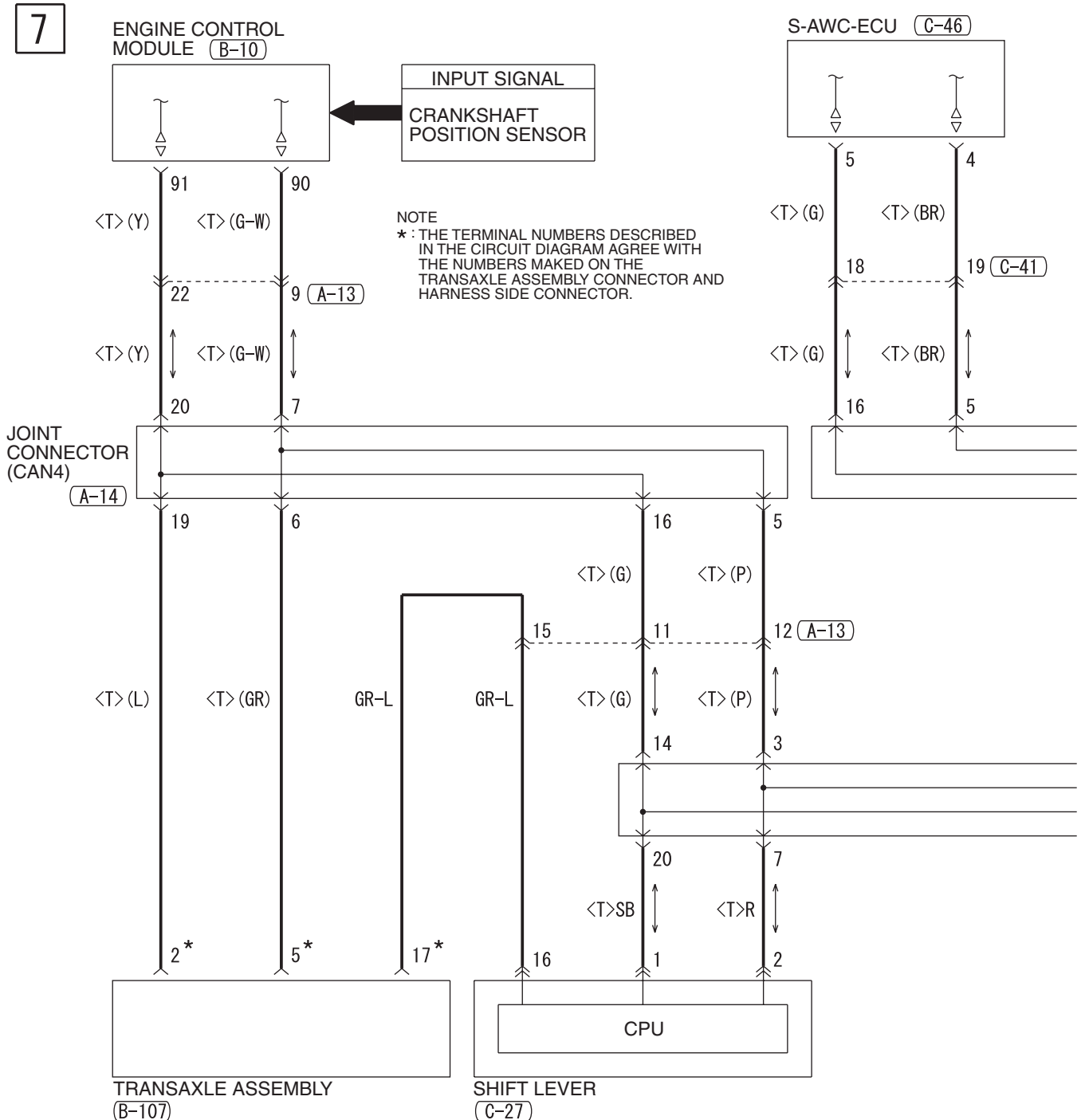

H8G07M06DA

8

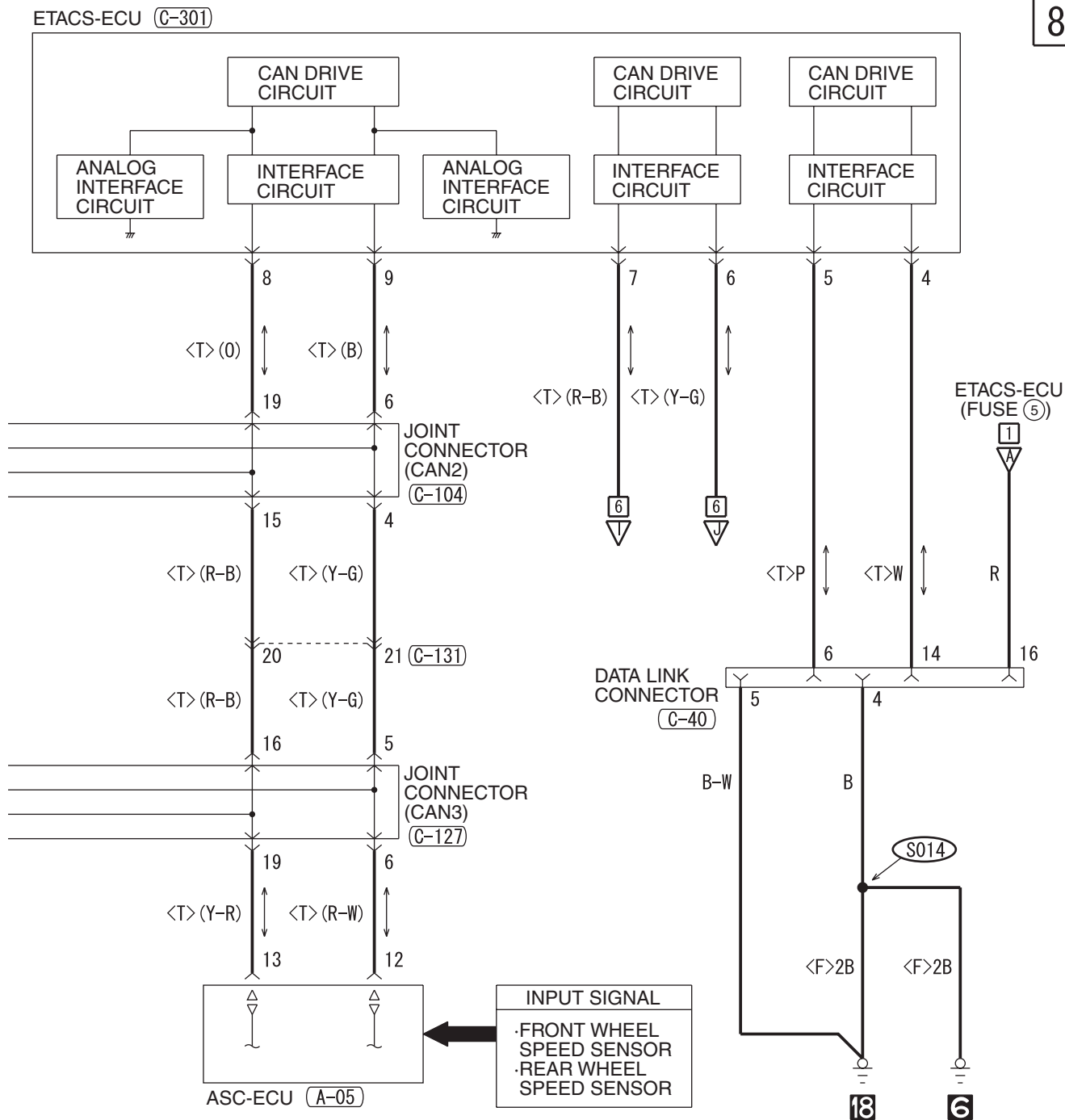

(B-10)

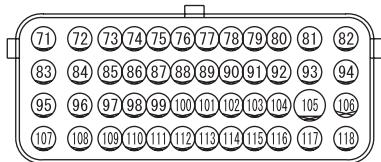

(B-107)*



(C-27)

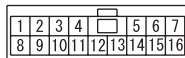

(C-40) FRONT SIDE

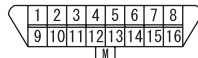

(C-41)

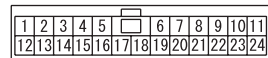

(C-301)

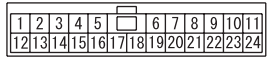

HEADLIGHT <HALOGEN TYPE>

1

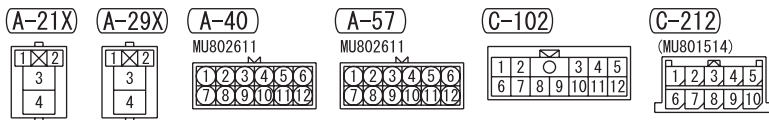
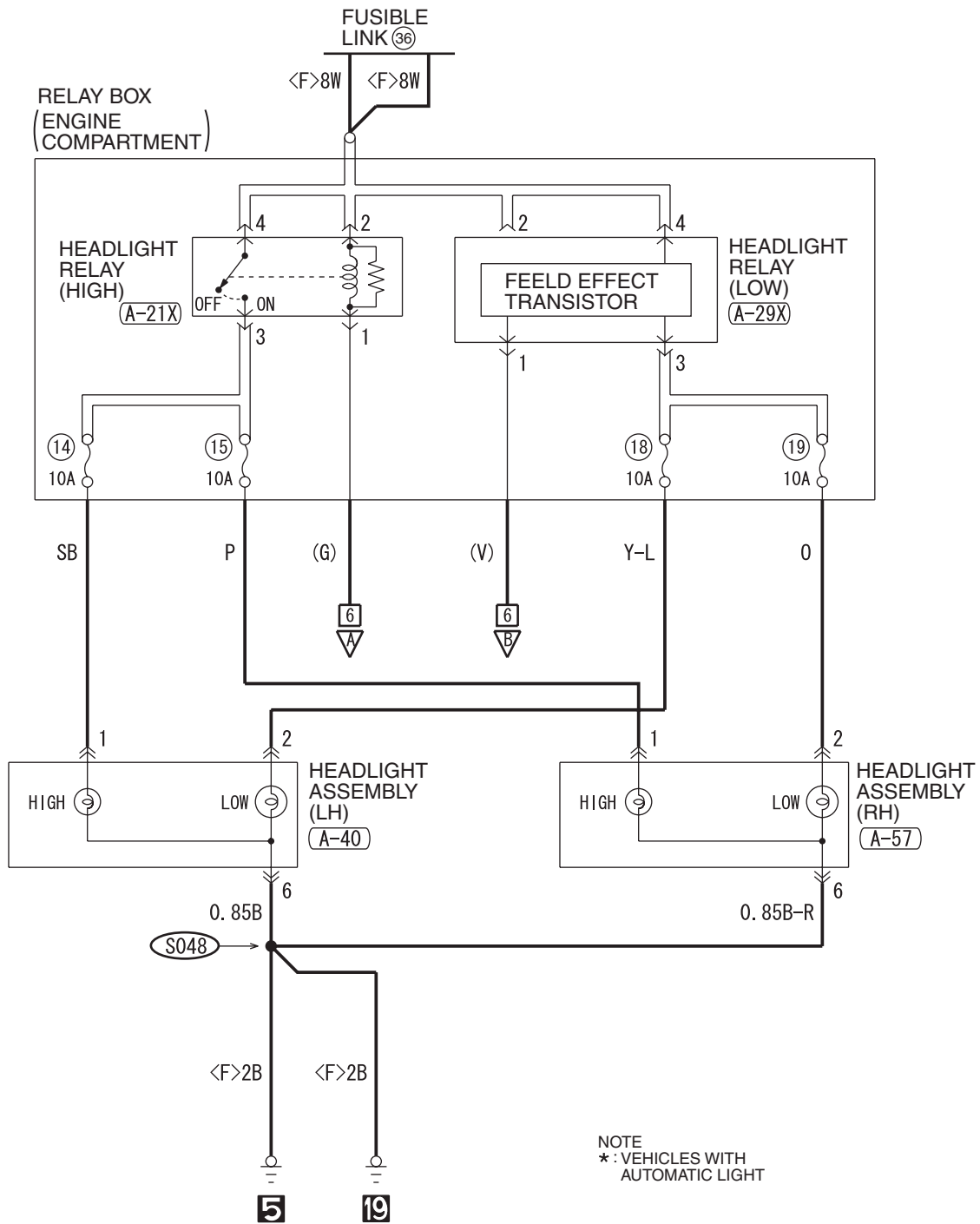

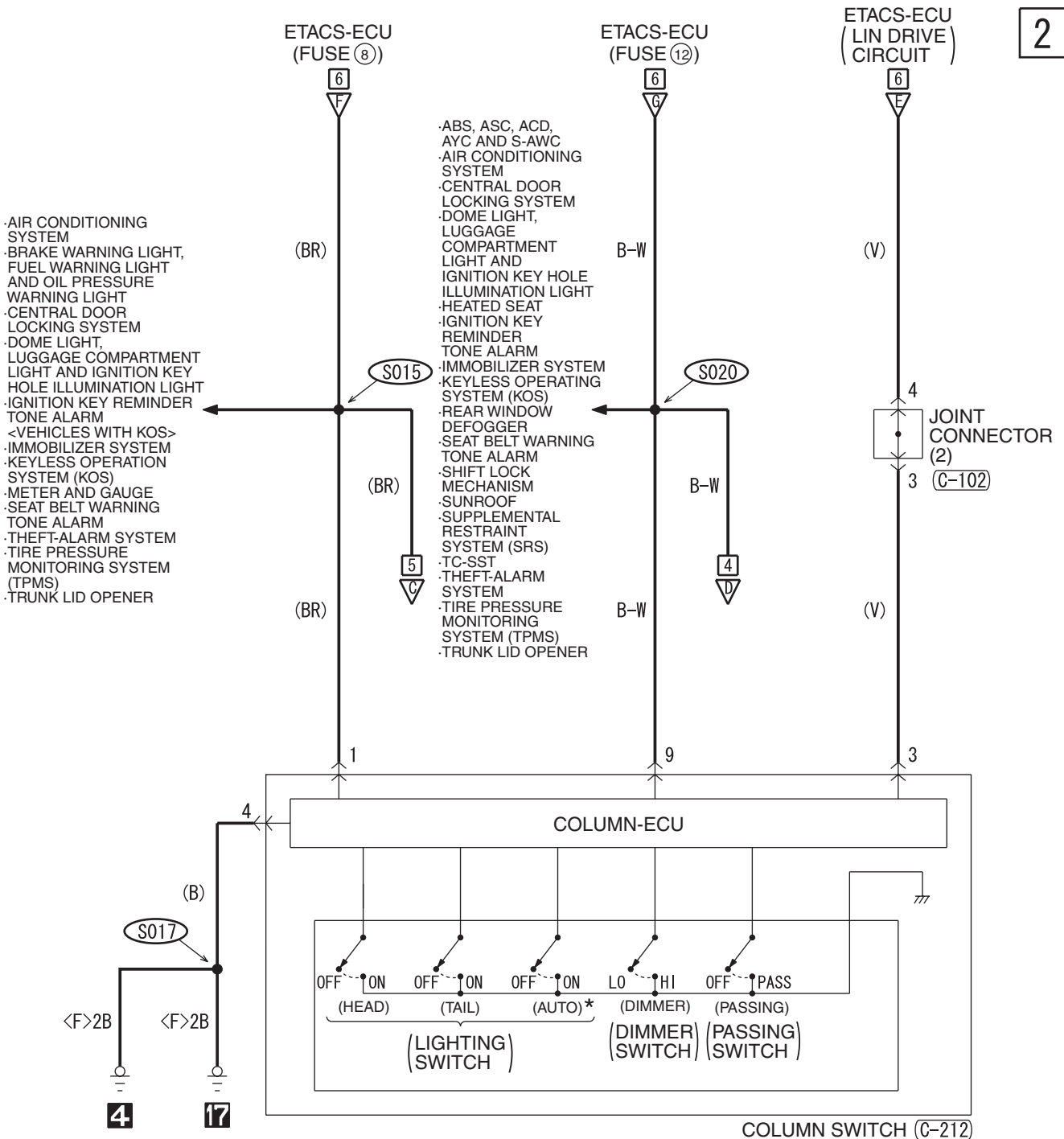

WIRE COLOR CODE
 B : BLACK LG : LIGHT GREEN G : GREEN L : BLUE W : WHITE Y : YELLOW SB : SKY BLUE
 BR : BROWN O : ORANGE GR : GRAY R : RED P : PINK V : VIOLET PU : PURPLE SI : SILVER

H8G08M20AB

HEADLIGHT <HALOGEN TYPE> (CONTINUED)

3

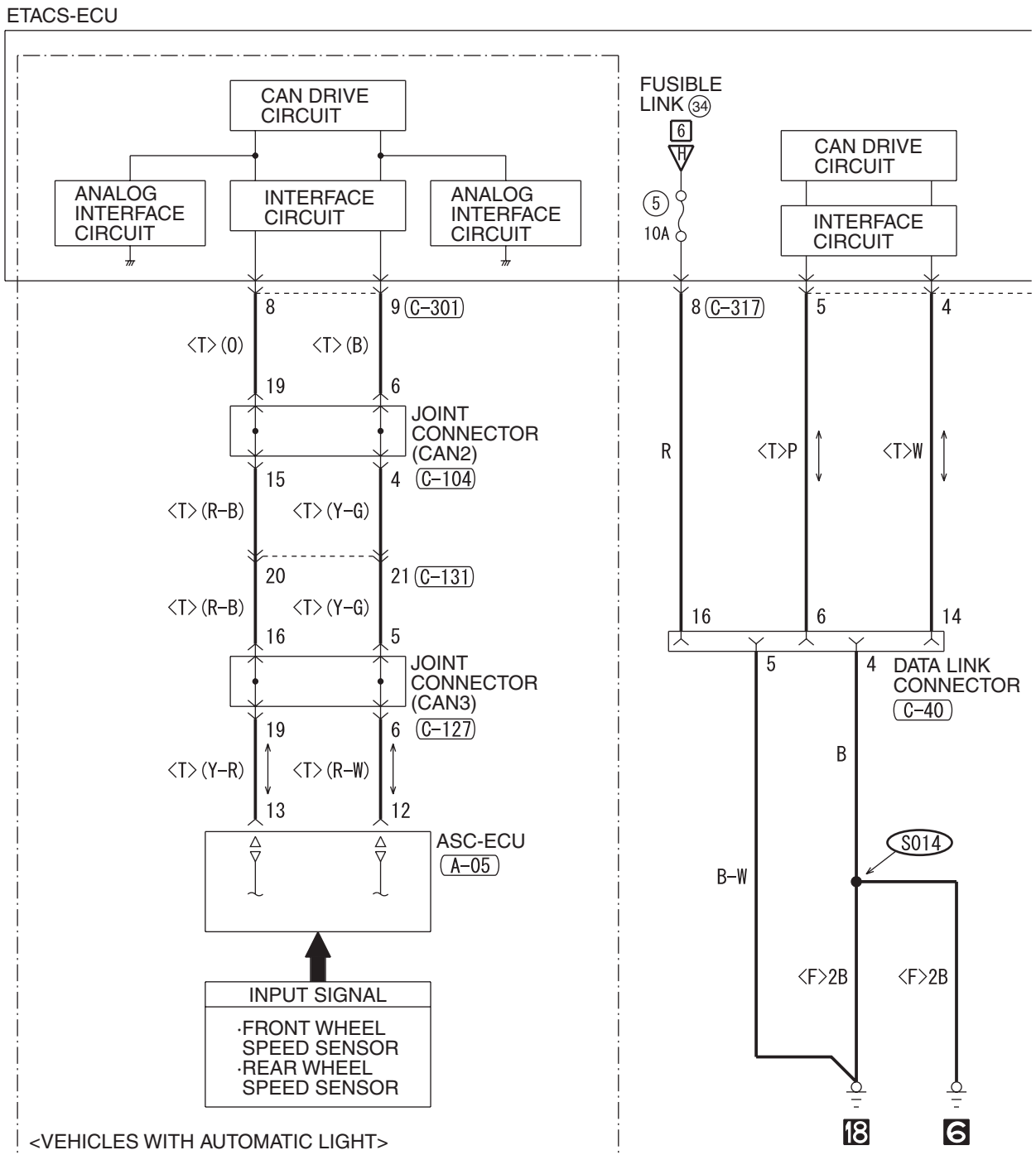

(A-05)

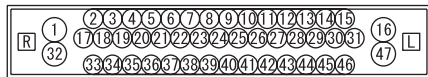

(C-04)

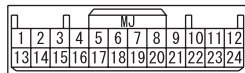

(C-40) FRONT SIDE



(C-104)

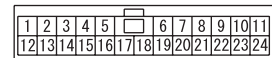

(C-317)

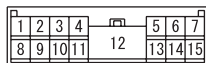

4

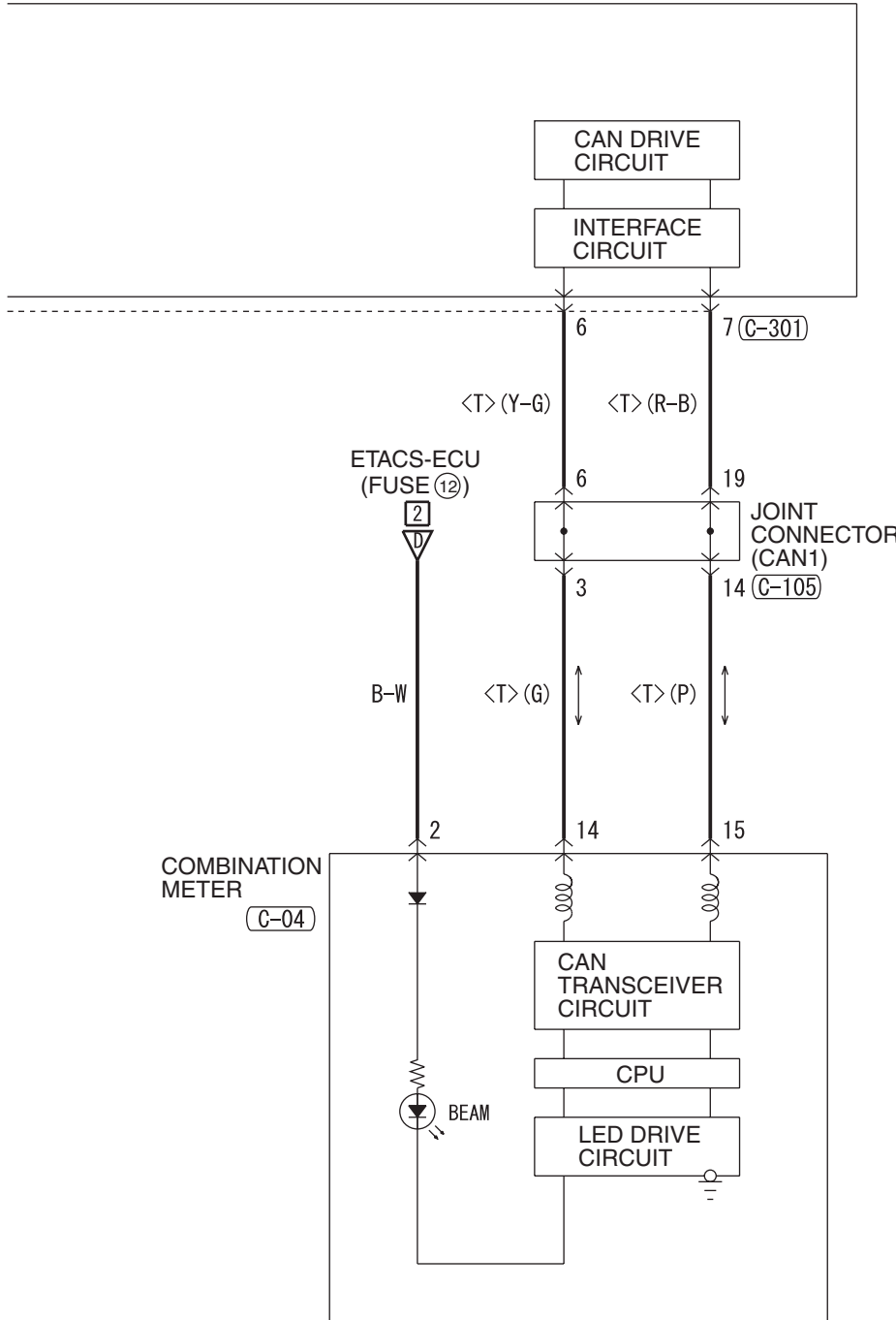

(C-105)

(C-127)

(C-131)

(C-301)

1	2	3	4	5	6	7	8	9	10	11		
12	13	14	15	16	17	18	19	20	21	22	23	24

1	2	3	4	5	6	7	8	9	10	11		
12	13	14	15	16	17	18	19	20	21	22	23	24

1	2	3	4	5	6	7	8	9				
10	11	12	13	14	15	16	17	18	19	20	21	22

1	2	3	4	5	6	7	8	9	10	11		
12	13	14	15	16	17	18	19	20	21	22	23	24

WIRE COLOR CODE

B : BLACK LG : LIGHT GREEN G : GREEN L : BLUE W : WHITE Y : YELLOW SB : SKY BLUE
BR : BROWN O : ORANGE GR : GRAY R : RED P : PINK V : VIOLET PU : PURPLE SI : SILVER

H8G08M20BB

TSB Revision

HEADLIGHT <HALOGEN TYPE> (CONTINUED)

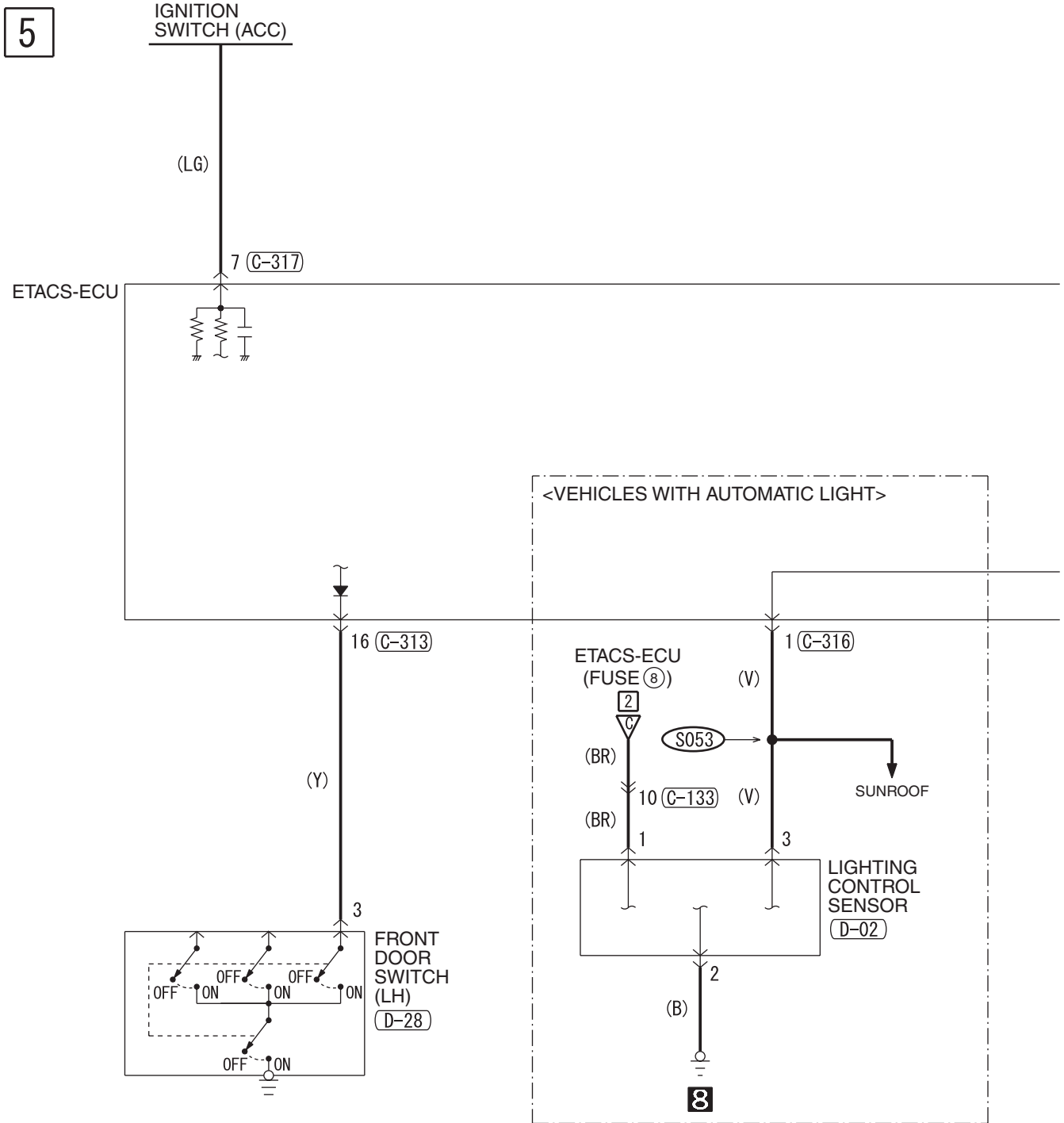

(C-133)

(C-301)

(C-307)

(C-309)

(C-312)

(C-313)

(C-316)

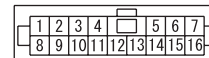
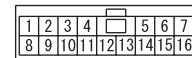
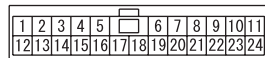
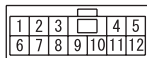

6

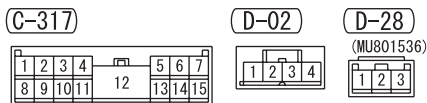
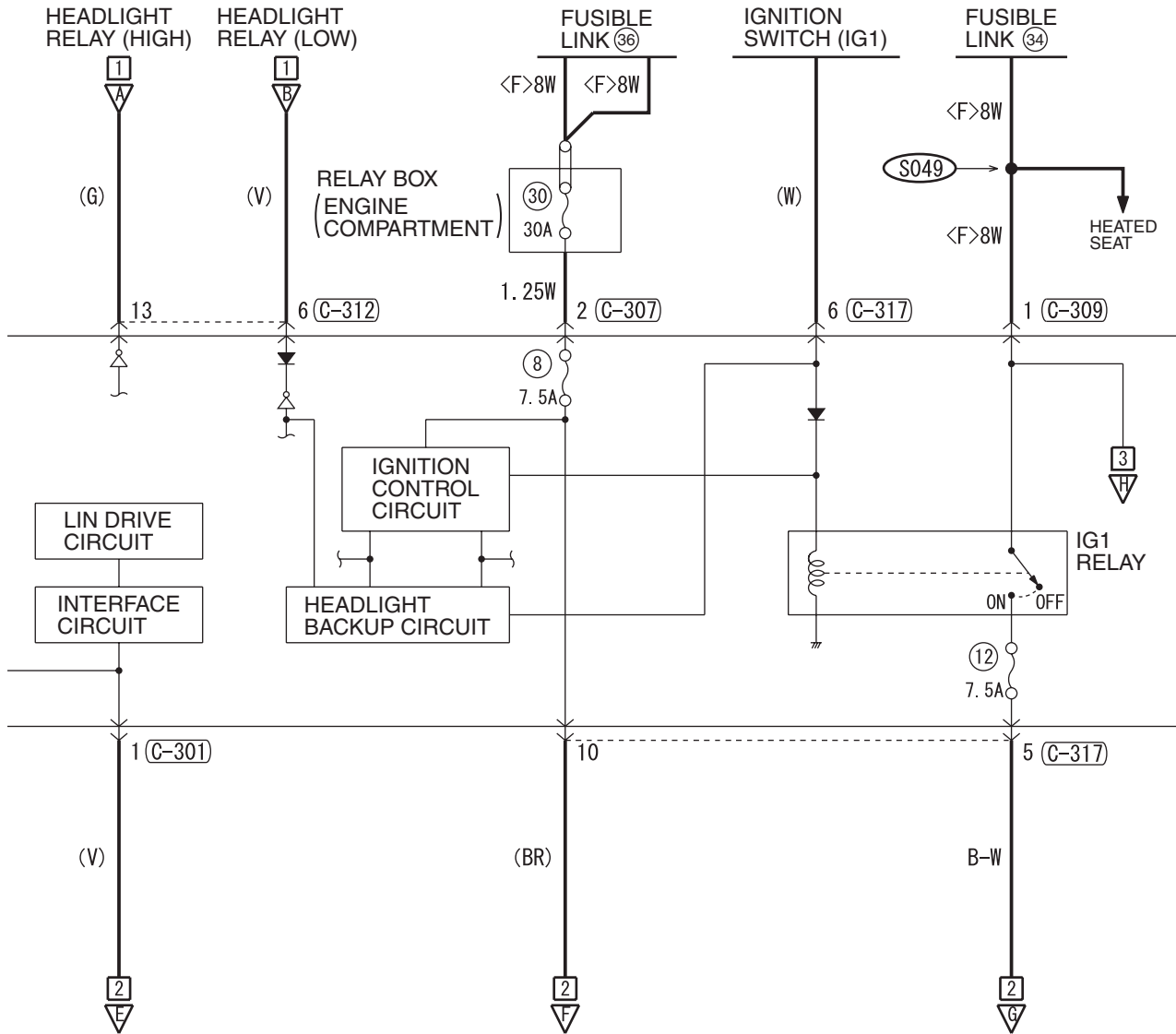

WIRE COLOR CODE
 B: BLACK LG: LIGHT GREEN G: GREEN L: BLUE W: WHITE Y: YELLOW SB: SKY BLUE
 BR: BROWN O: ORANGE GR: GRAY R: RED P: PINK V: VIOLET PU: PURPLE SI: SILVER

H8G08M20CB

TSB Revision

HEADLIGHT <DISCHARGE TYPE>

1

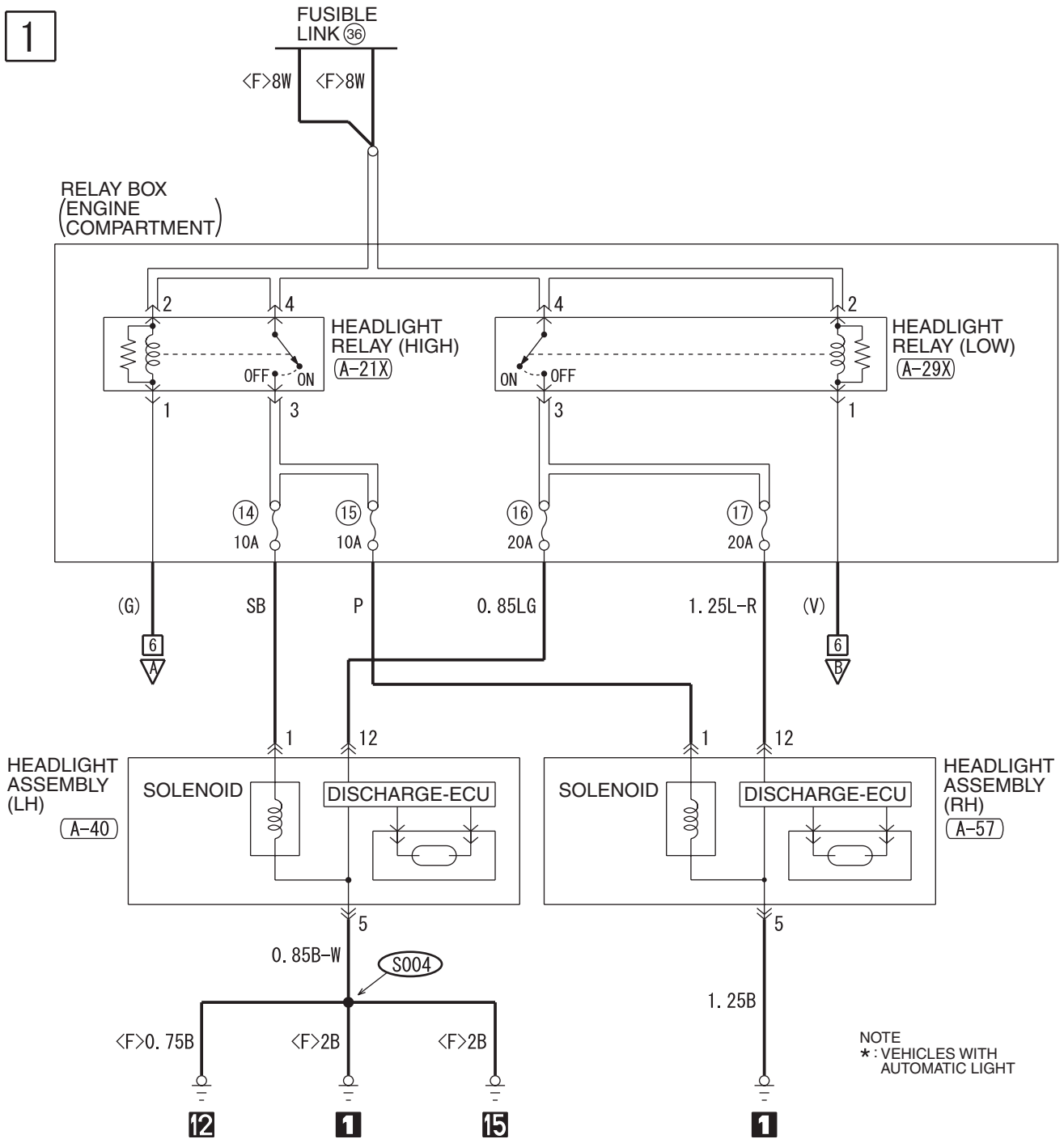

NOTE
* : VEHICLES WITH
AUTOMATIC LIGHT

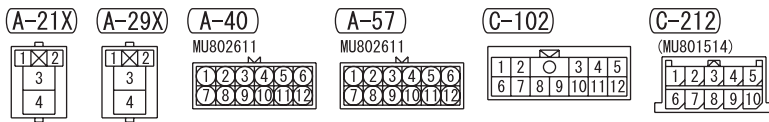

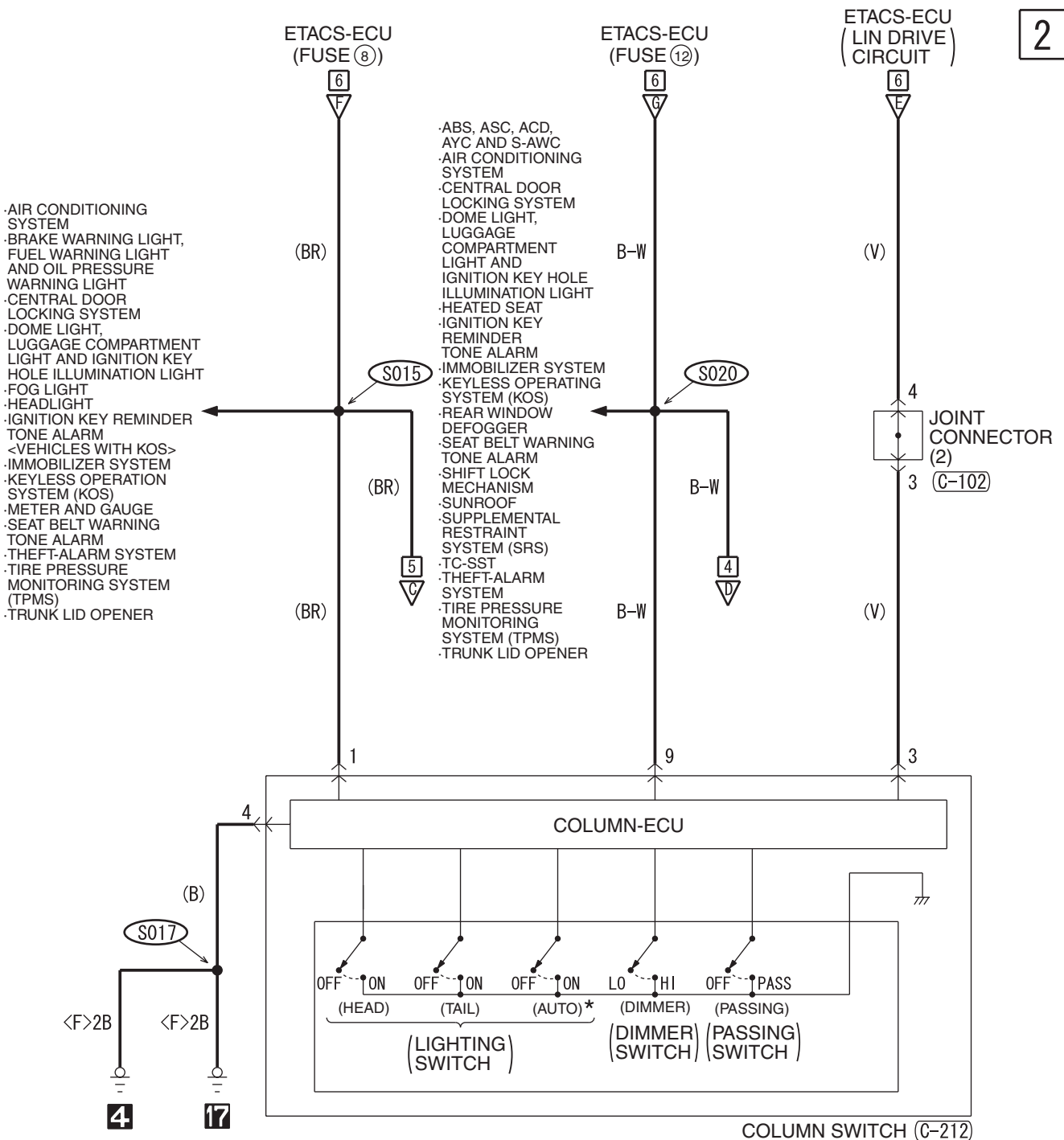

WIRE COLOR CODE
 B: BLACK LG: LIGHT GREEN G: GREEN L: BLUE W: WHITE Y: YELLOW SB: SKY BLUE
 BR: BROWN O: ORANGE GR: GRAY R: RED P: PINK V: VIOLET PU: PURPLE SI: SILVER

H8G08M21AB

HEADLIGHT <DISCHARGE TYPE> (CONTINUED)

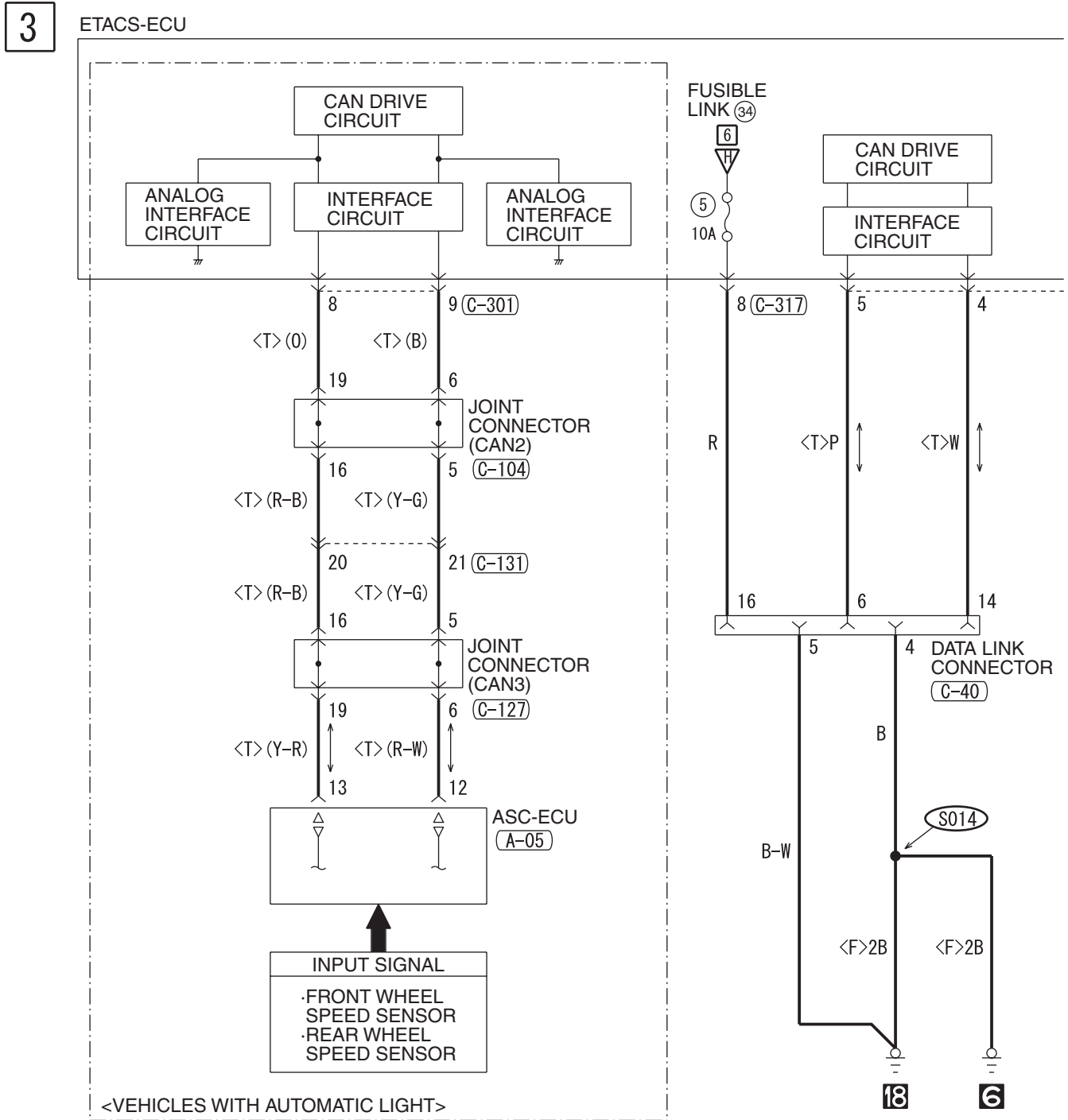

(A-05)

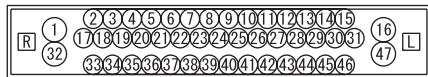

(C-04)

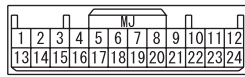

(C-40) FRONT SIDE



(C-104)

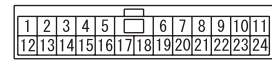

(C-317)

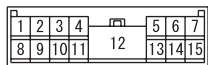

4

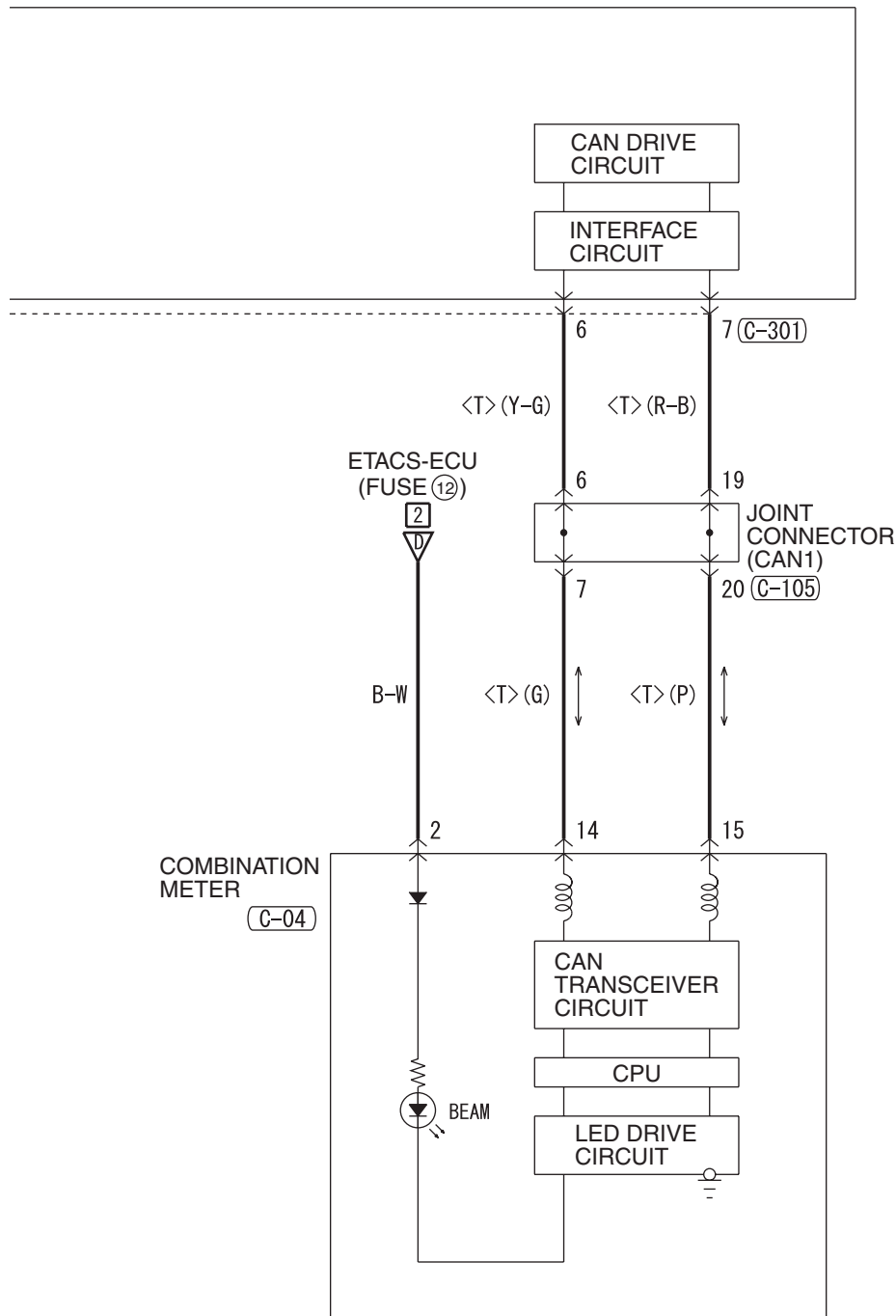

(C-105)

1	2	3	4	5	6	7	8	9	10	11		
12	13	14	15	16	17	18	19	20	21	22	23	24

(C-127)

1	2	3	4	5	6	7	8	9	10	11		
12	13	14	15	16	17	18	19	20	21	22	23	24

(C-131)

1	2	3	4	5	6	7	8	9				
10	11	12	13	14	15	16	17	18	19	20	21	22

(C-301)

1	2	3	4	5	6	7	8	9	10	11		
12	13	14	15	16	17	18	19	20	21	22	23	24

WIRE COLOR CODE

B: BLACK LG: LIGHT GREEN G: GREEN L: BLUE W: WHITE Y: YELLOW SB: SKY BLUE
BR: BROWN O: ORANGE GR: GRAY R: RED P: PINK V: VIOLET PU: PURPLE SI: SILVER

H8G08M21BB

HEADLIGHT <DISCHARGE TYPE> (CONTINUED)

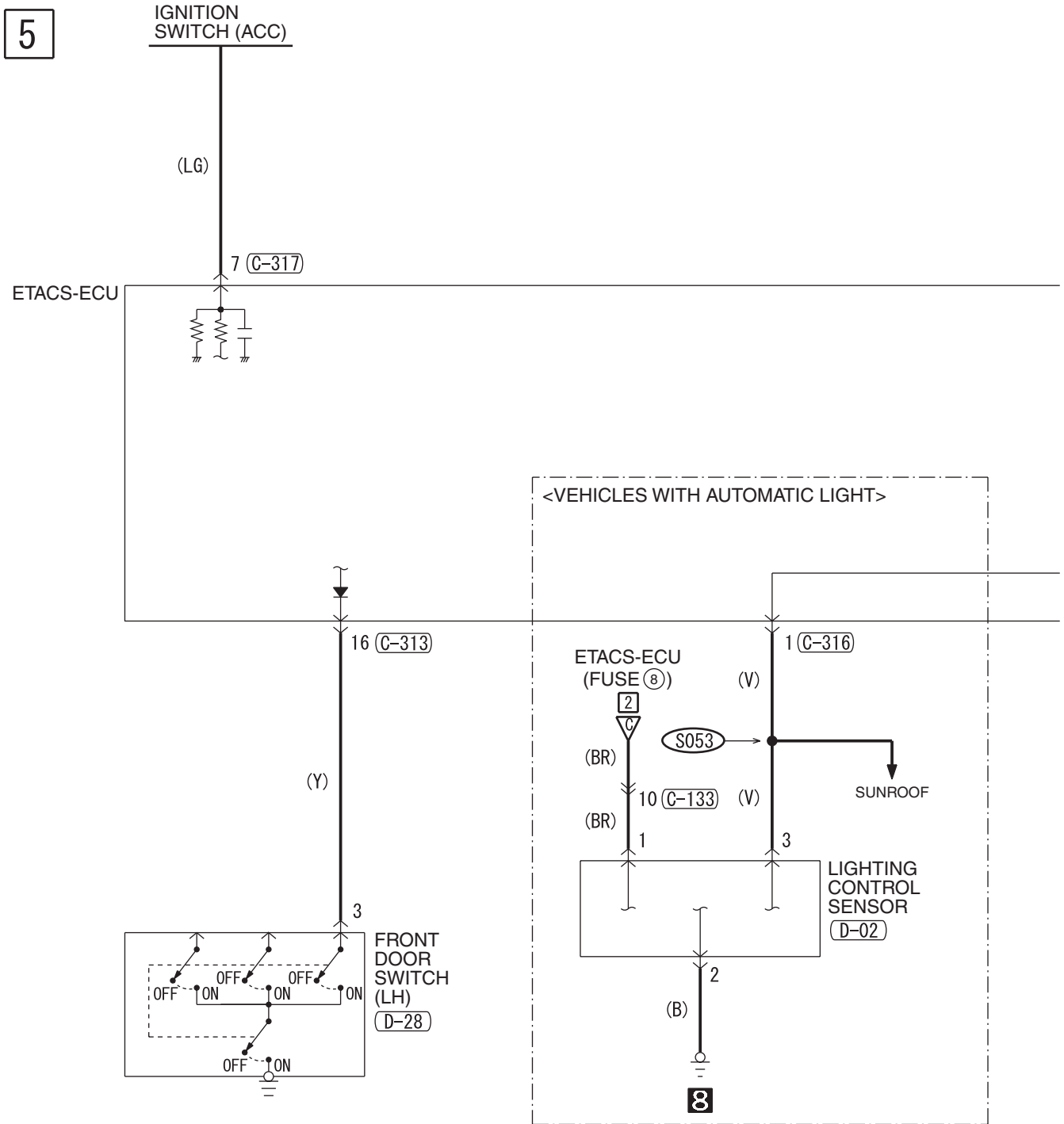

(C-133)

(C-301)

(C-307)

(C-309)

(C-312)

(C-313)

(C-316)

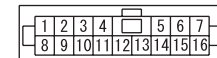
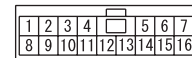
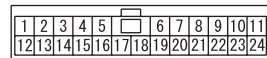
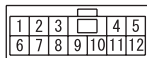

6

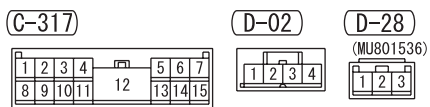
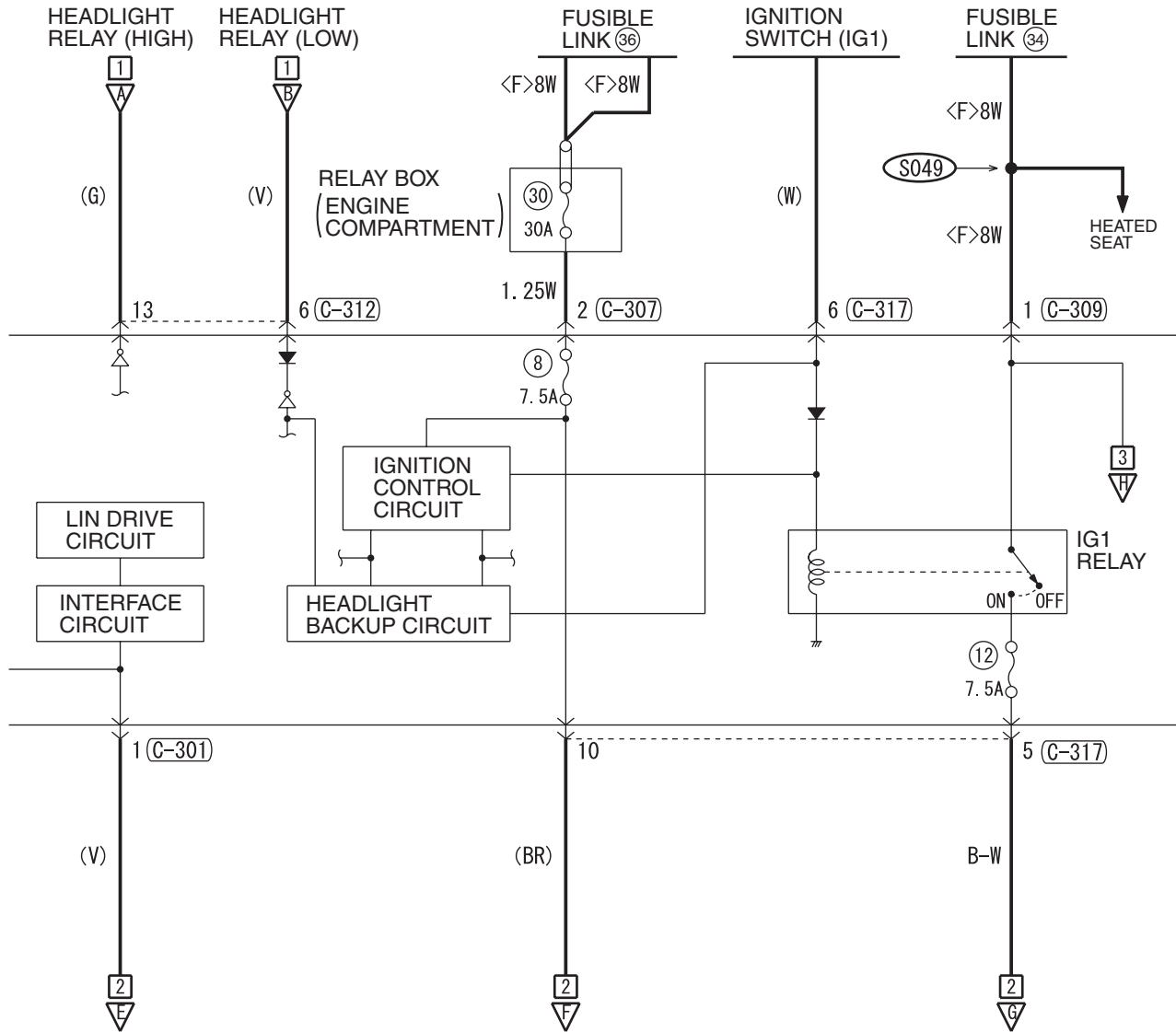

WIRE COLOR CODE
 B: BLACK LG: LIGHT GREEN G: GREEN L: BLUE W: WHITE Y: YELLOW SB: SKY BLUE
 BR: BROWN O: ORANGE GR: GRAY R: RED P: PINK V: VIOLET PU: PURPLE SI: SILVER

H8G08M21CB

TSB Revision

HEADLIGHT LEVELING SYSTEM

M1901012501014

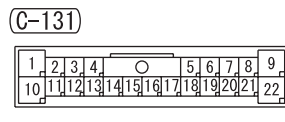
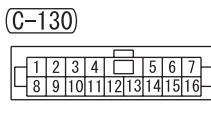
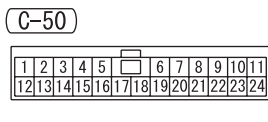
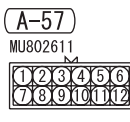
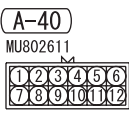
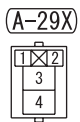
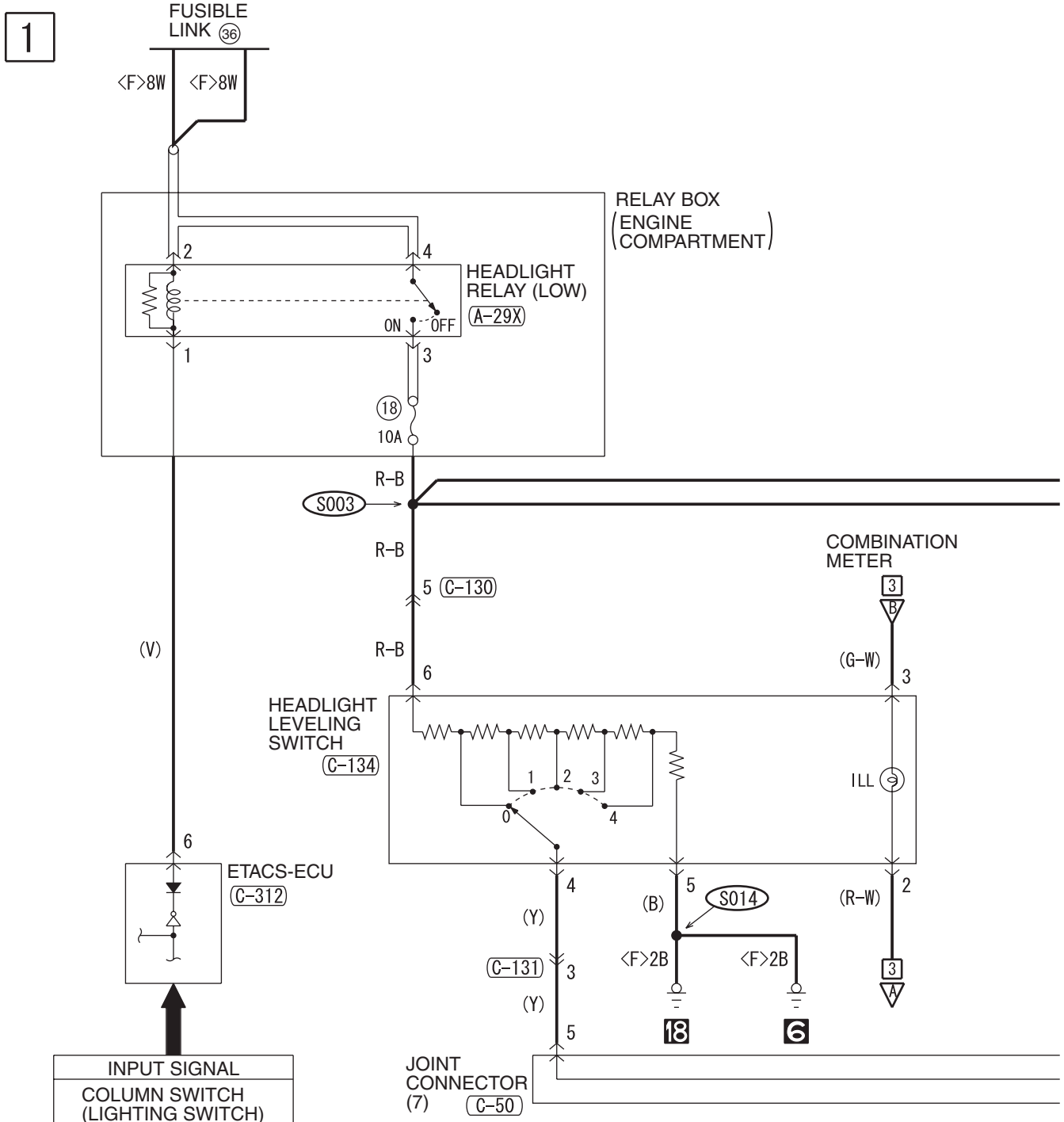

2

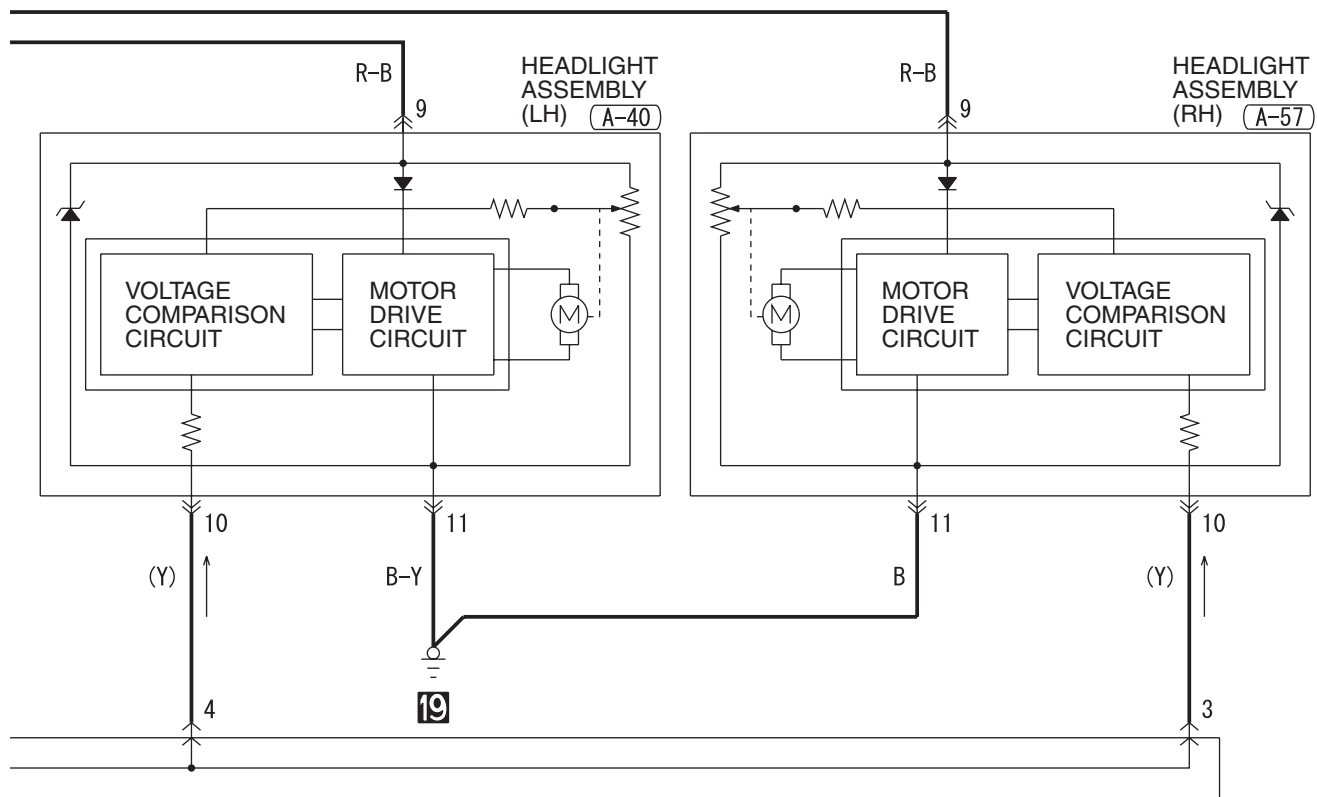

(C-134)

(C-312)

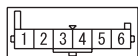

WIRE COLOR CODE

B: BLACK LG: LIGHT GREEN G: GREEN L: BLUE W: WHITE Y: YELLOW SB: SKY BLUE
BR: BROWN O: ORANGE GR: GRAY R: RED P: PINK V: VIOLET PU: PURPLE SI: SILVER

H8G08M22AB

TSB Revision

HEADLIGHT LEVELING SYSTEM (CONTINUED)

3

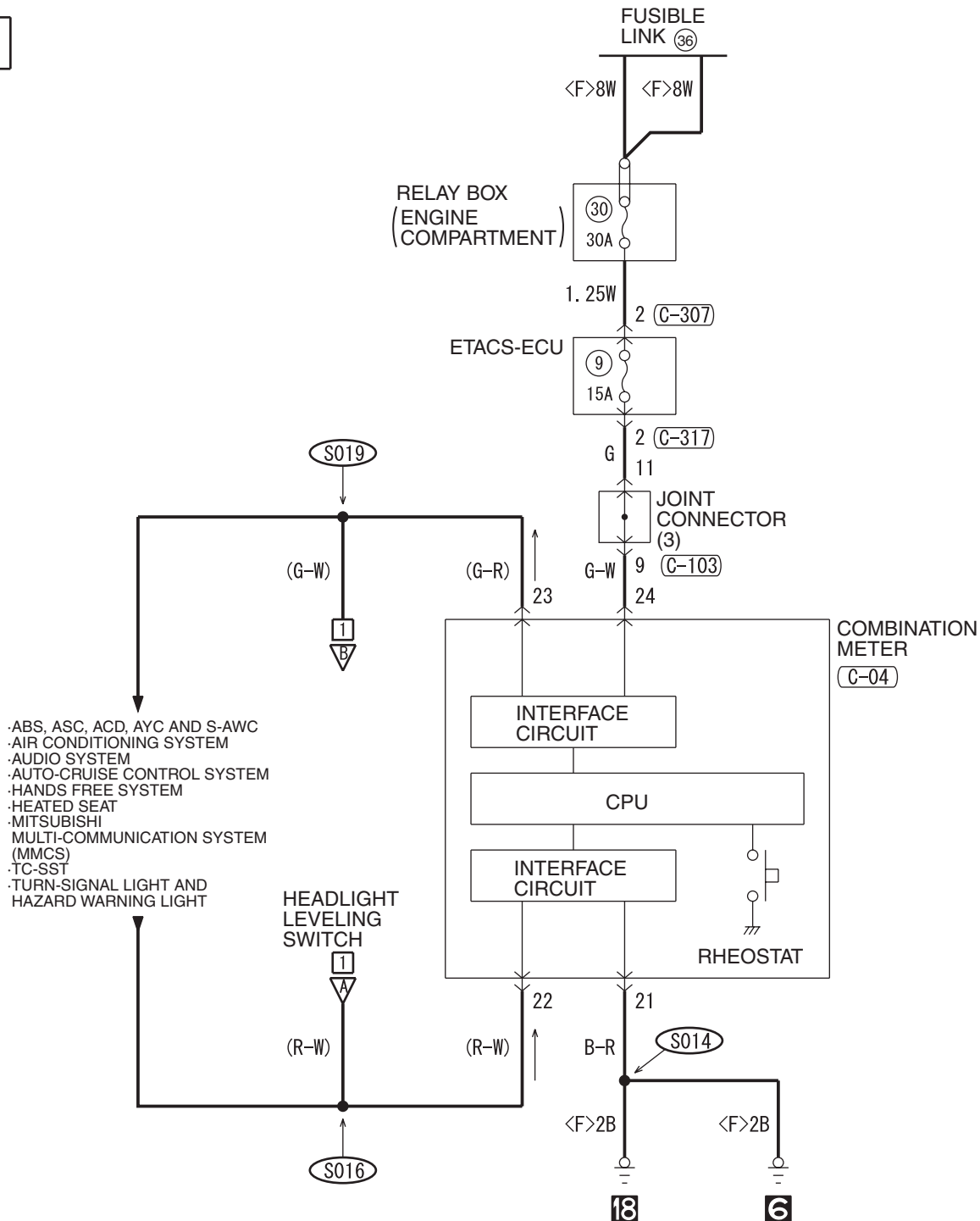

- ABS, ASC, ACD, AYC AND S-AWC
- AIR CONDITIONING SYSTEM
- AUDIO SYSTEM
- AUTO-CRUISE CONTROL SYSTEM
- HANDS FREE SYSTEM
- HEATED SEAT
- MITSUBISHI MULTI-COMMUNICATION SYSTEM (MMCS)
- TC-SST
- TURN-SIGNAL LIGHT AND HAZARD WARNING LIGHT

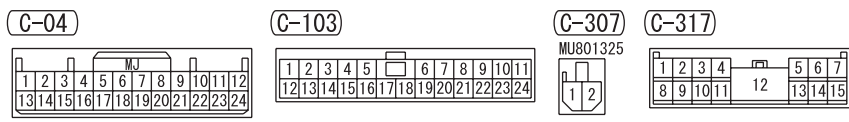

WIRE COLOR CODE
 B: BLACK LG: LIGHT GREEN G: GREEN L: BLUE W: WHITE Y: YELLOW SB: SKY BLUE
 BR: BROWN O: ORANGE GR: GRAY R: RED P: PINK V: VIOLET PU: PURPLE SI: SILVER

H8G08M22BA

NOTES

DAYTIME RUNNING LIGHT (DRL) <HALOGEN TYPE>

M1901030700107

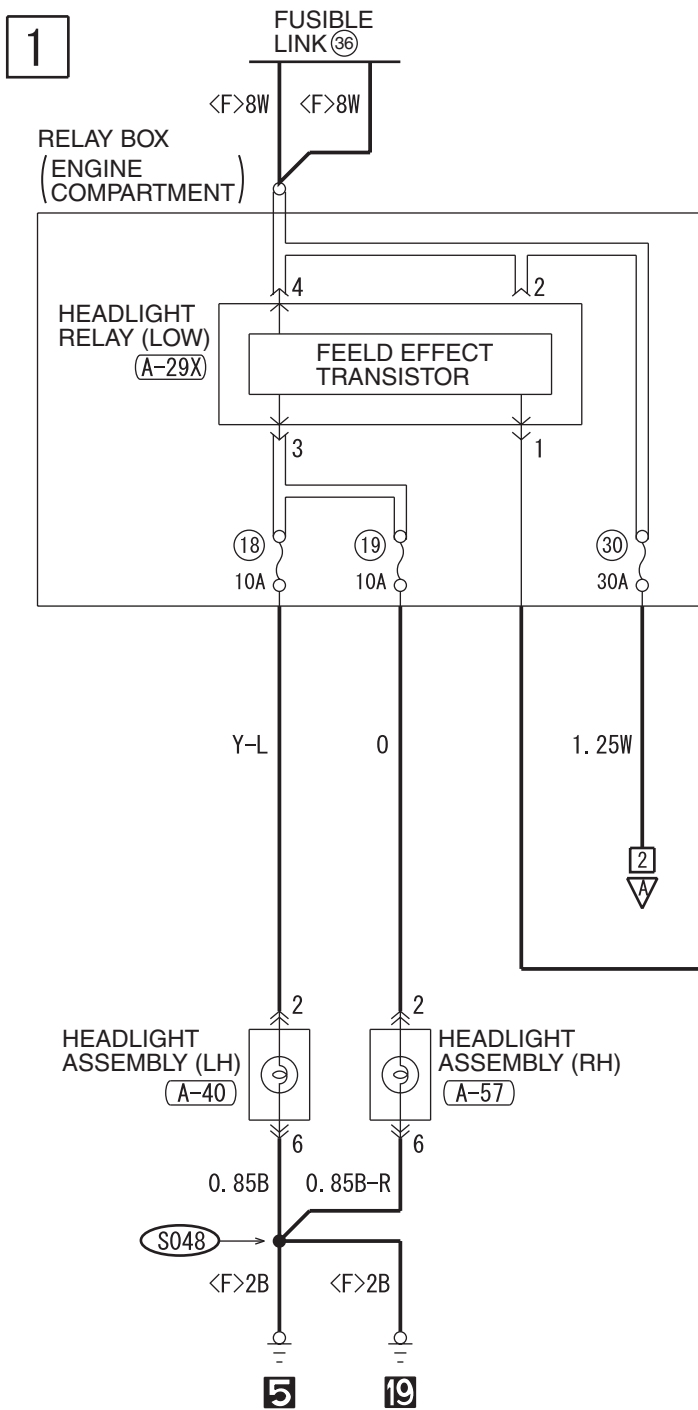

NOTE

- * 1 : VEHICLES WITH AUTOMATIC LIGHT
- * 2 : ·AIR CONDITIONING SYSTEM
·BRAKE WARNING LIGHT,
·FUEL WARNING LIGHT
·AND OIL PRESSURE WARNING LIGHT
·CENTRAL DOOR LOCKING SYSTEM
·DOME LIGHT,
·LUGGAGE COMPARTMENT
·LIGHT AND IGNITION KEY
·HOLE ILLUMINATION LIGHT
·HEADLIGHT
·IGNITION KEY REMINDER TONE ALARM
·<VEHICLES WITH KOS>
·IMMOBILIZER SYSTEM
·KEYLESS OPERATION SYSTEM (KOS)
·METER AND GAUGE
·SEAT BELT WARNING TONE ALARM
·TAILLIGHT, POSITION LIGHT,
·LICENSE PLATE LIGHT
·AND LIGHTING MONITOR TONE ALARM
·THEFT-ALARM SYSTEM
·TIRE PRESSURE
·MONITORING SYSTEM (TPMS)
·TRUNK LID OPENER
·WINDSHIELD WIPER AND WASHER
- * 3 : ·ABS, ASC, ACD, AYC AND S-AWC
·AIR CONDITIONING SYSTEM
·CENTRAL DOOR LOCKING SYSTEM
·DOME LIGHT, LUGGAGE
·COMPARTMENT LIGHT
·AND IGNITION KEY HOLE
·ILLUMINATION LIGHT
·HEATED SEAT
·IGNITION KEY REMINDER TONE
·ALARM
·IMMOBILIZER SYSTEM
·KEYLESS OPERATING SYSTEM
·(KOS)
·REAR WINDOW DEFOGGER
·SEAT BELT WARNING TONE ALARM
·SHIFT LOCK MECHANISM
·SUNROOF
·SUPPLEMENTAL RESTRAINT
·SYSTEM (SRS)
·TC-SST
·THEFT-ALARM SYSTEM
·TIRE PRESSURE MONITORING
·SYSTEM (TPMS)
·TRUNK LID OPENER

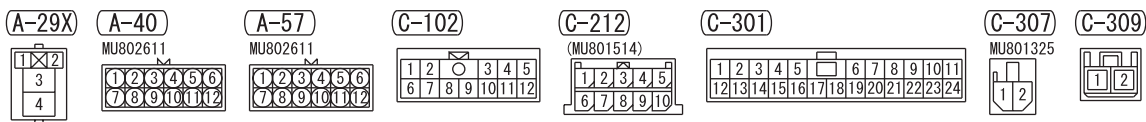

2

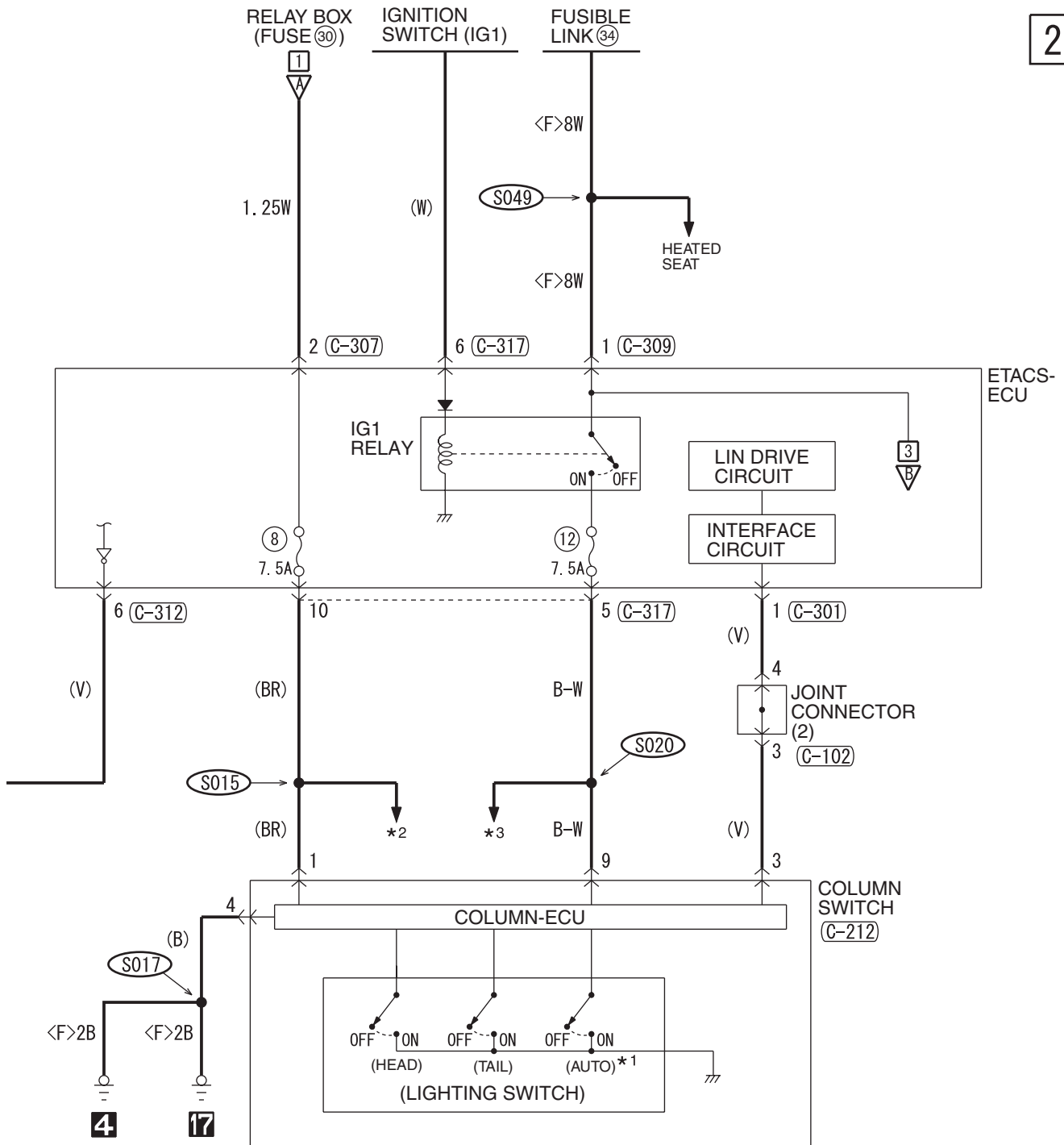

(C-312)

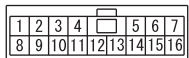

(C-317)

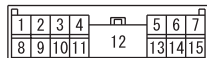

WIRE COLOR CODE

B: BLACK LG: LIGHT GREEN G: GREEN L: BLUE W: WHITE Y: YELLOW SB: SKY BLUE
BR: BROWN O: ORANGE GR: GRAY R: RED P: PINK V: VIOLET PU: PURPLE SI: SILVER

H8G08M27AB

TSB Revision

DAYTIME RUNNING LIGHT (DRL) <HALOGEN TYPE> (CONTINUED)

3

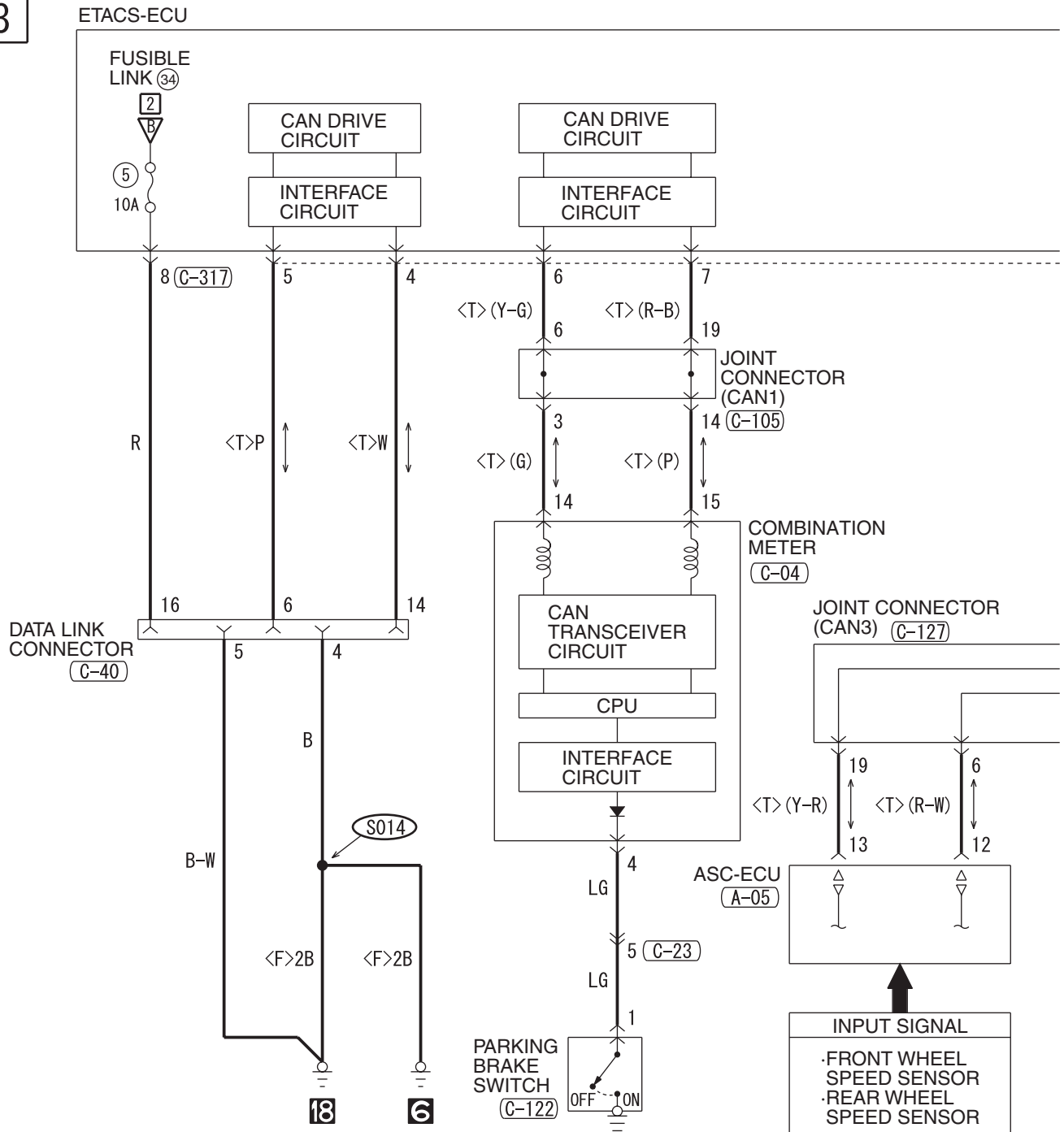

(A-05)

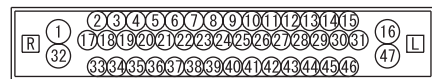

(A-13)

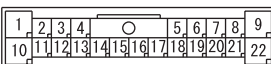

(A-14)

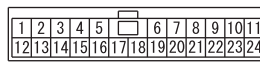

(C-104)

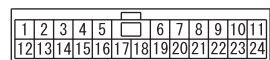

(C-105)

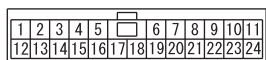

(C-122)



(C-127)

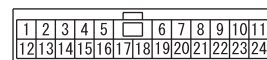

(C-131)

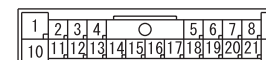

4

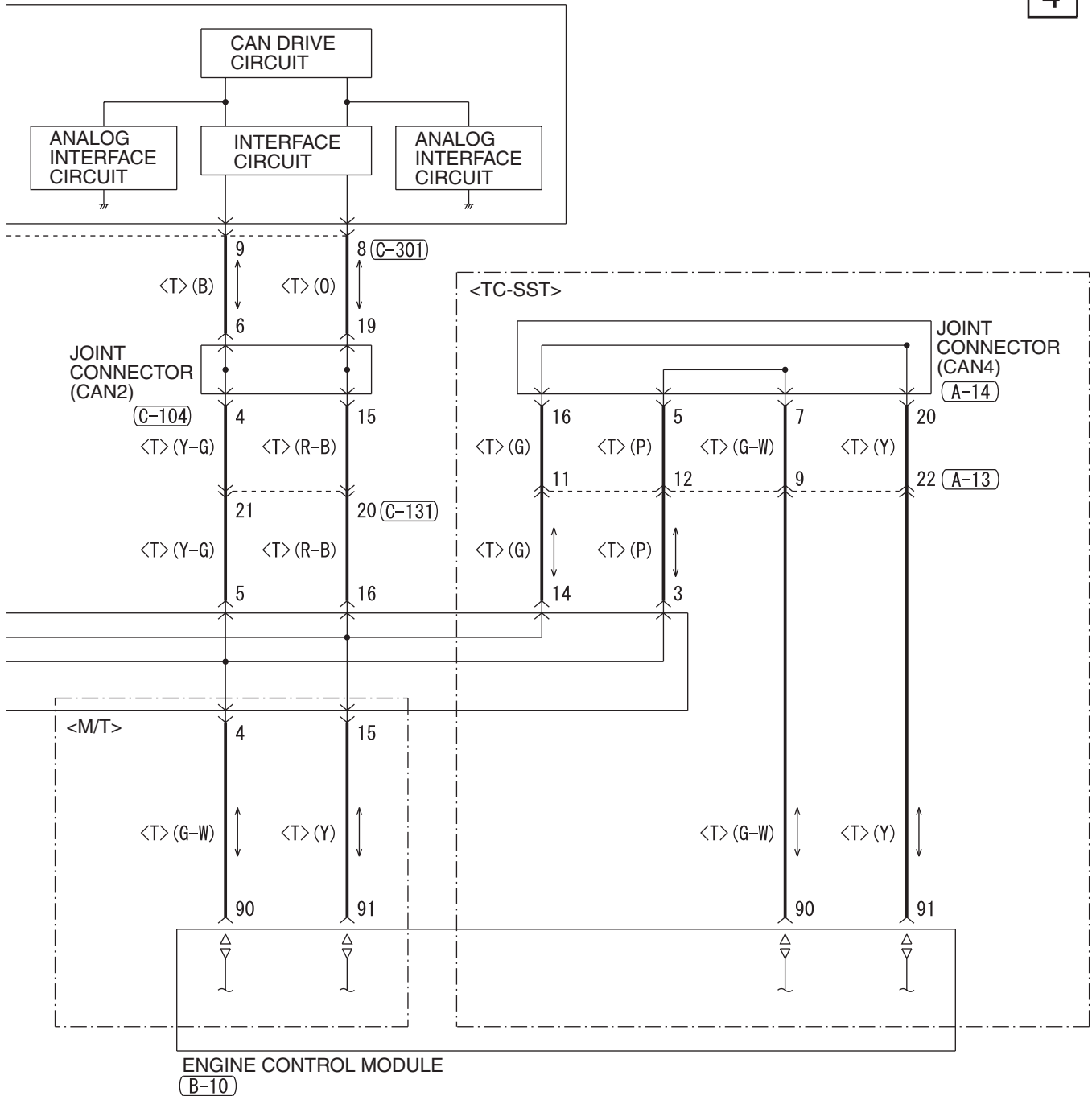

(B-10)

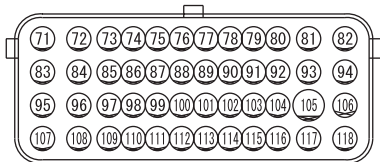

(C-04)

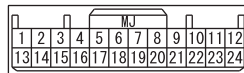

(C-23)

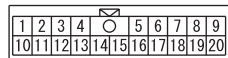

(C-40) FRONT SIDE



(C-301)

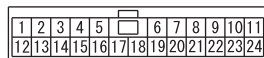

(C-317)

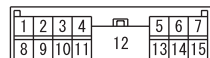

DAYTIME RUNNING LIGHT (DRL) <DISCHARGE TYPE>

M1901030700088

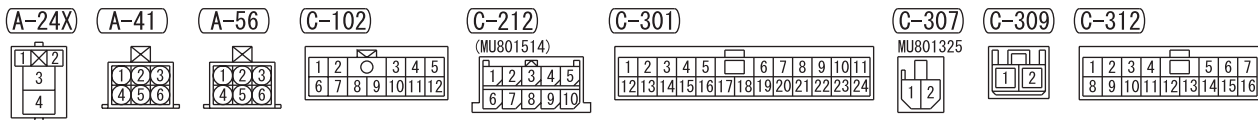
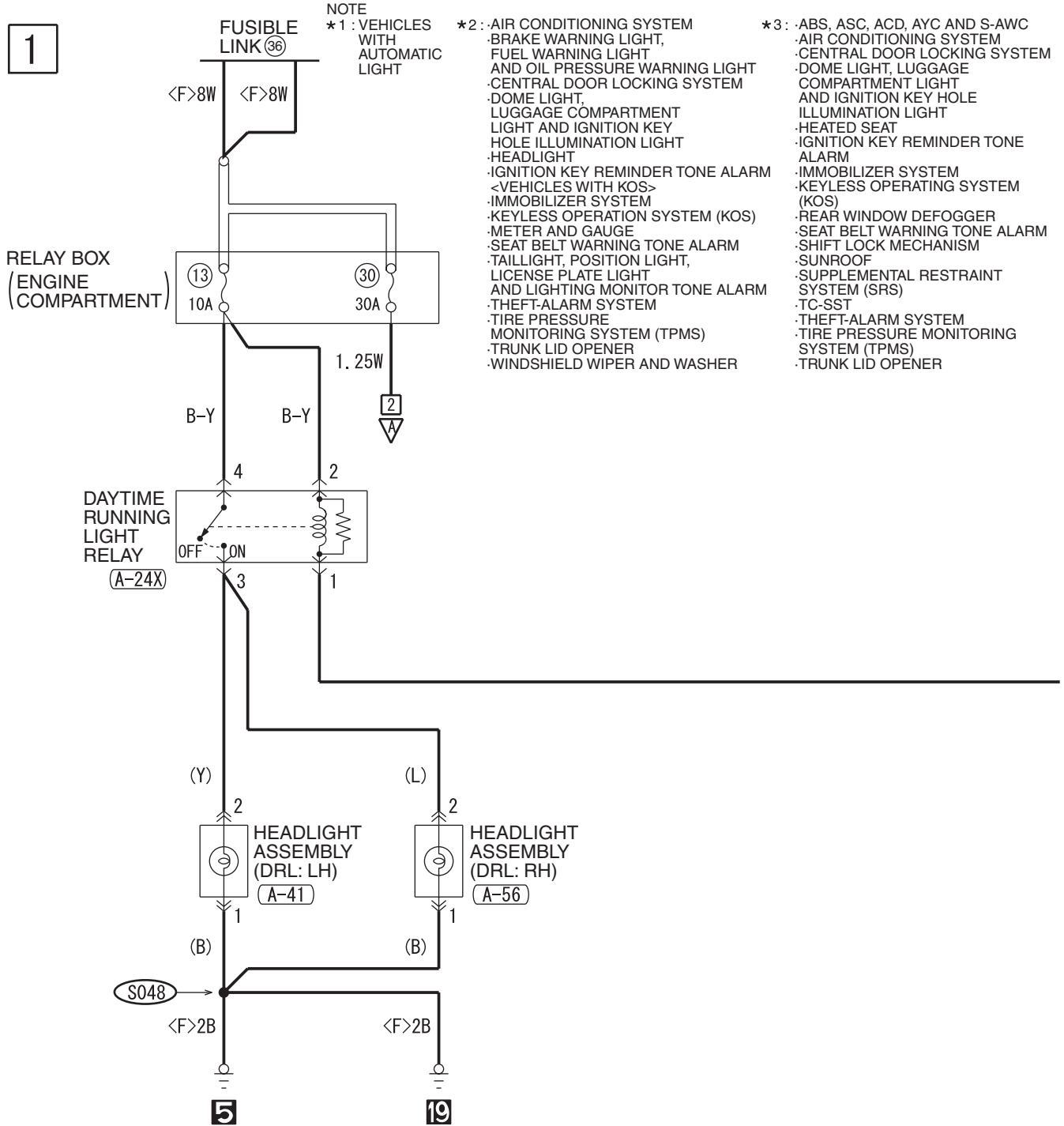

2

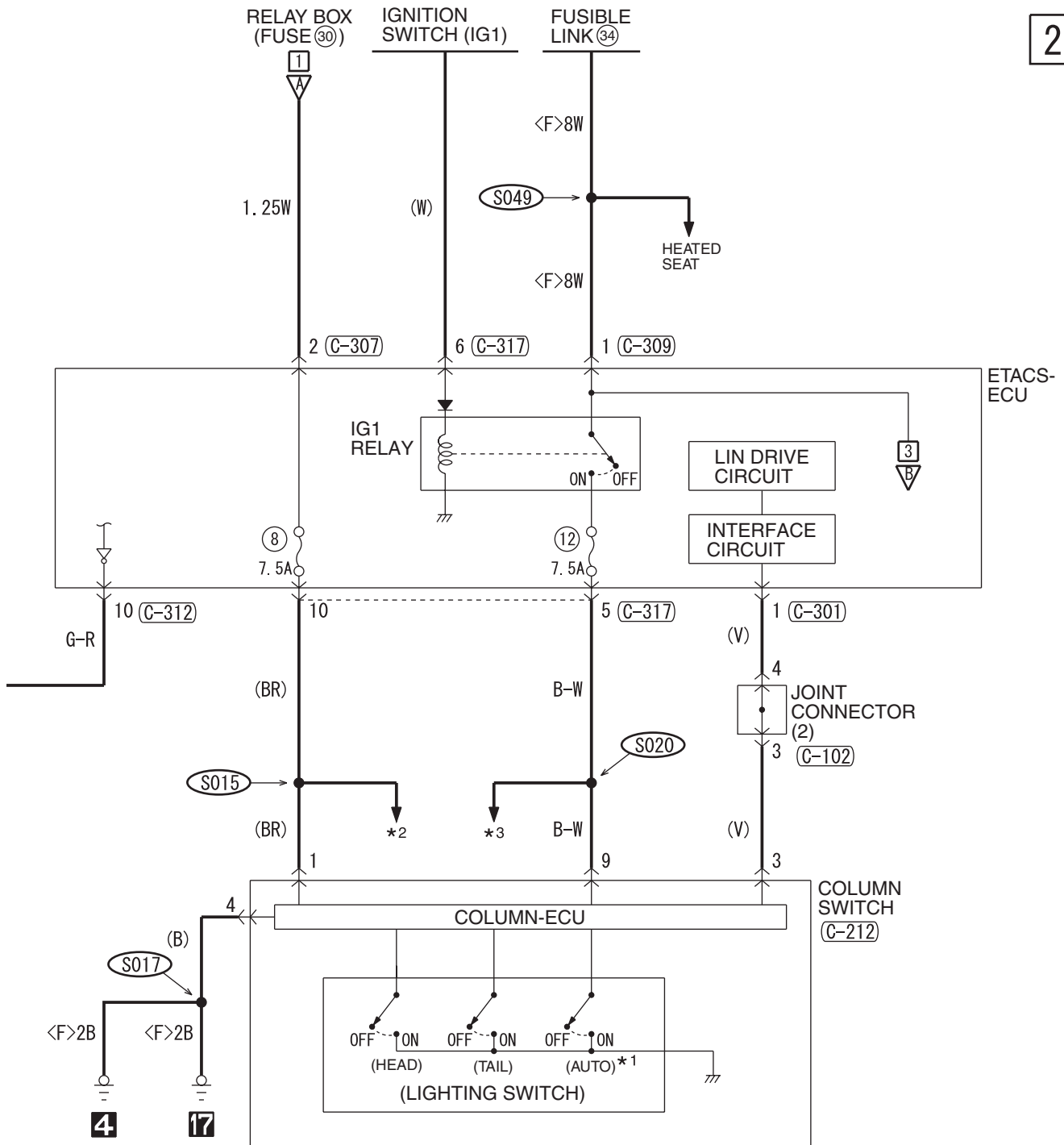

(C-317)

1	2	3	4	5	6	7	
8	9	10	11	12	13	14	15

WIRE COLOR CODE
 B: BLACK LG: LIGHT GREEN G: GREEN L: BLUE W: WHITE Y: YELLOW SB: SKY BLUE
 BR: BROWN O: ORANGE GR: GRAY R: RED P: PINK V: VIOLET PU: PURPLE SI: SILVER

H8G08M23AB

TSB Revision

DAYTIME RUNNING LIGHT (DRL) <DISCHARGE TYPE> (CONTINUED)

3

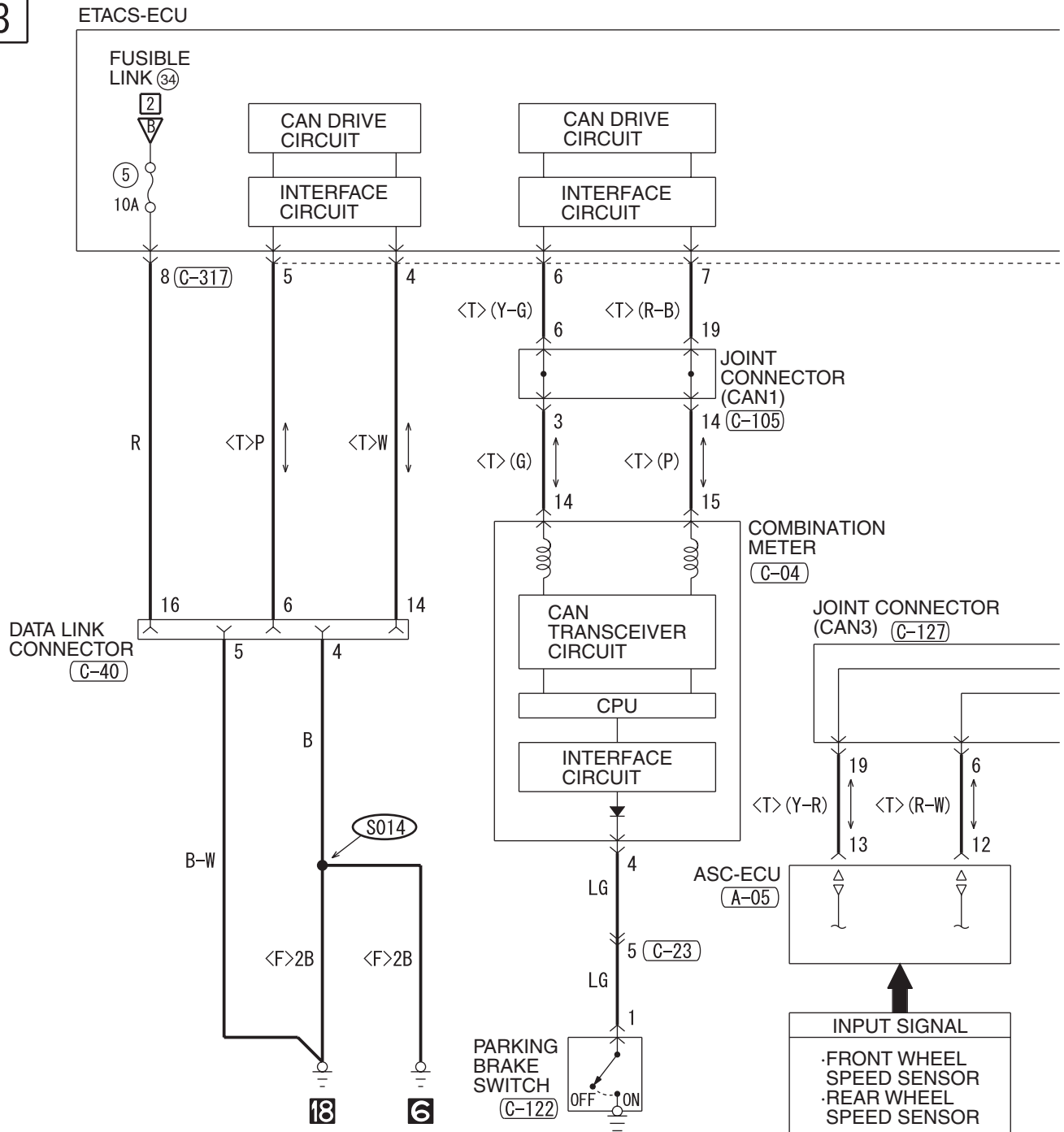

(A-05)

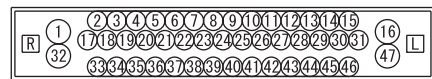

(A-13)

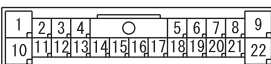

(A-14)

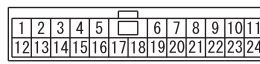

(C-104)

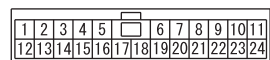

(C-105)

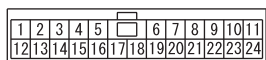

(C-122)



(C-127)

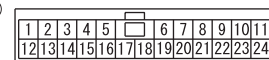

(C-131)

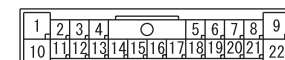

H8G08M23BA

4

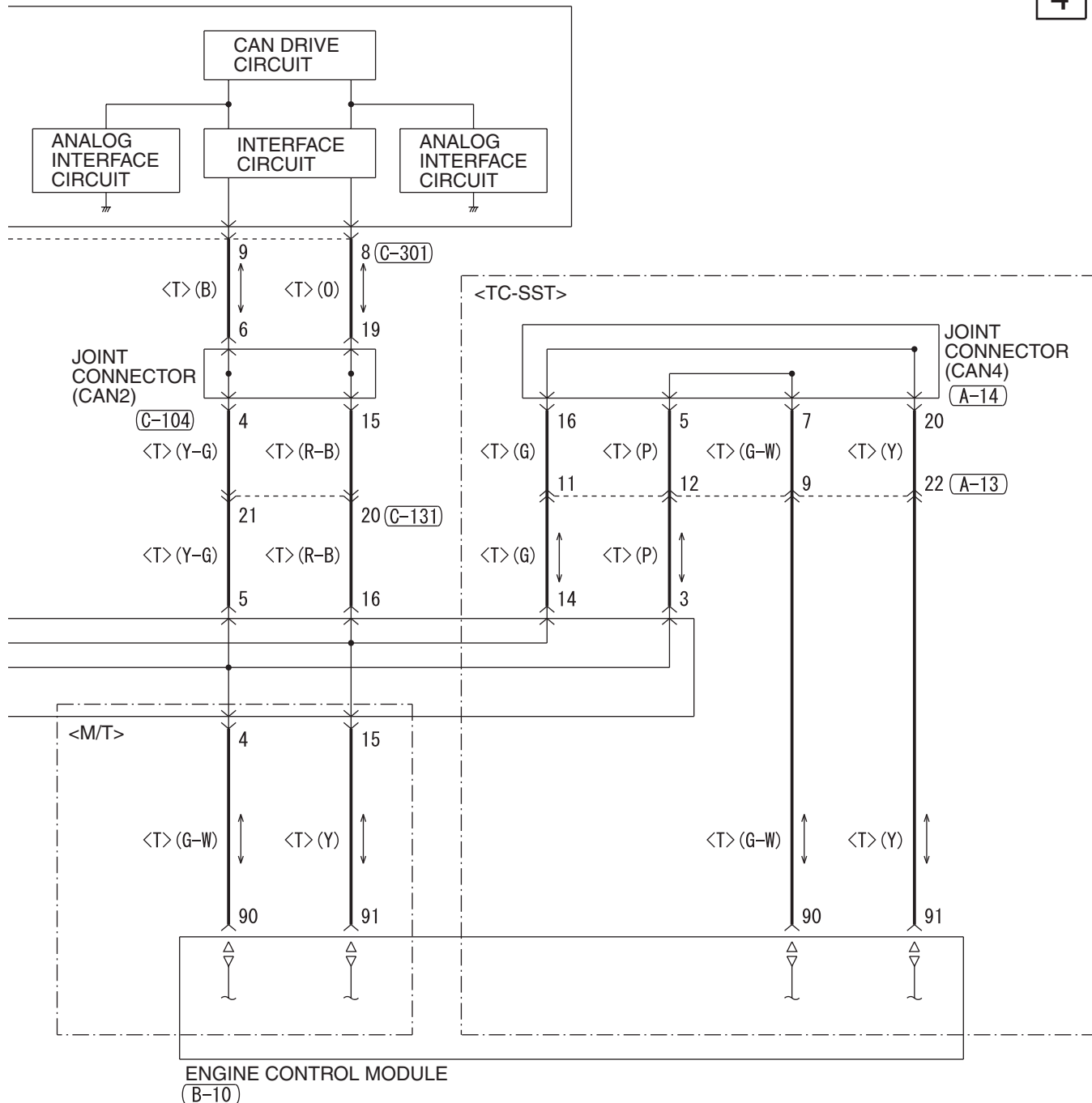

(B-10)

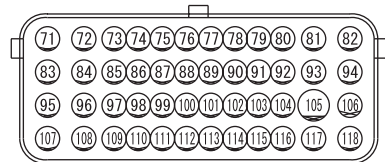

(C-04)

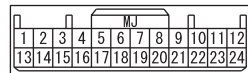

(C-23)

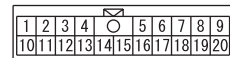

(C-40) FRONT SIDE

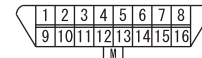

(C-301)

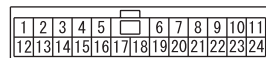

(C-317)

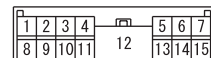

FOG LIGHT

1

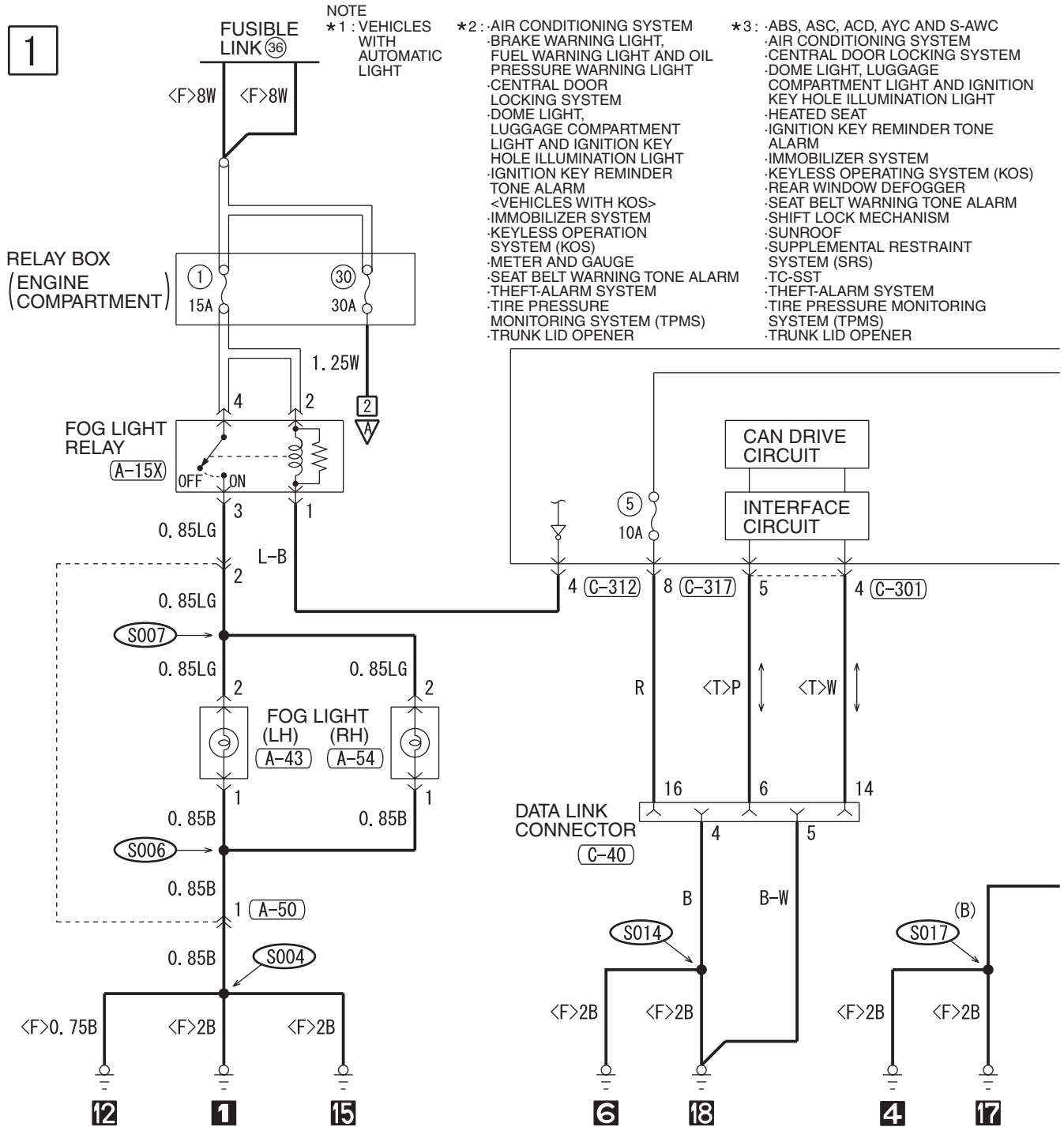

NOTE

*1: VEHICLES WITH AUTOMATIC LIGHT

*2: AIR CONDITIONING SYSTEM
 ·BRAKE WARNING LIGHT,
 ·FUEL WARNING LIGHT AND OIL PRESSURE WARNING LIGHT
 ·CENTRAL DOOR LOCKING SYSTEM
 ·DOME LIGHT,
 ·LUGGAGE COMPARTMENT LIGHT AND IGNITION KEY HOLE ILLUMINATION LIGHT
 ·IGNITION KEY REMINDER TONE ALARM
 ·VEHICLES WITH KOS>
 ·IMMOBILIZER SYSTEM
 ·KEYLESS OPERATION SYSTEM (KOS)
 ·METER AND GAUGE
 ·SEAT BELT WARNING TONE ALARM
 ·THEFT-ALARM SYSTEM
 ·TIRE PRESSURE MONITORING SYSTEM (TPMS)
 ·TRUNK LID OPENER

*3: ABS, ASC, ACD, AYC AND S-AWC
 ·AIR CONDITIONING SYSTEM
 ·CENTRAL DOOR LOCKING SYSTEM
 ·DOME LIGHT, LUGGAGE COMPARTMENT LIGHT AND IGNITION KEY HOLE ILLUMINATION LIGHT
 ·HEATED SEAT
 ·IGNITION KEY REMINDER TONE ALARM
 ·IMMOBILIZER SYSTEM
 ·KEYLESS OPERATING SYSTEM (KOS)
 ·REAR WINDOW DEFOGGER
 ·SEAT BELT WARNING TONE ALARM
 ·SHIFT LOCK MECHANISM
 ·SUNROOF
 ·SUPPLEMENTAL RESTRAINT SYSTEM (SRS)
 ·TC-SST
 ·THEFT-ALARM SYSTEM
 ·TIRE PRESSURE MONITORING SYSTEM (TPMS)
 ·TRUNK LID OPENER

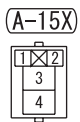

(C-04)

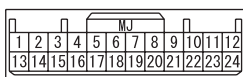

(C-40) FRONT SIDE

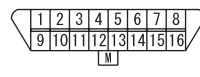

(C-102)

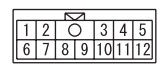

(C-105)

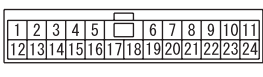

2

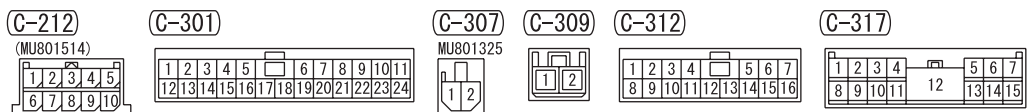
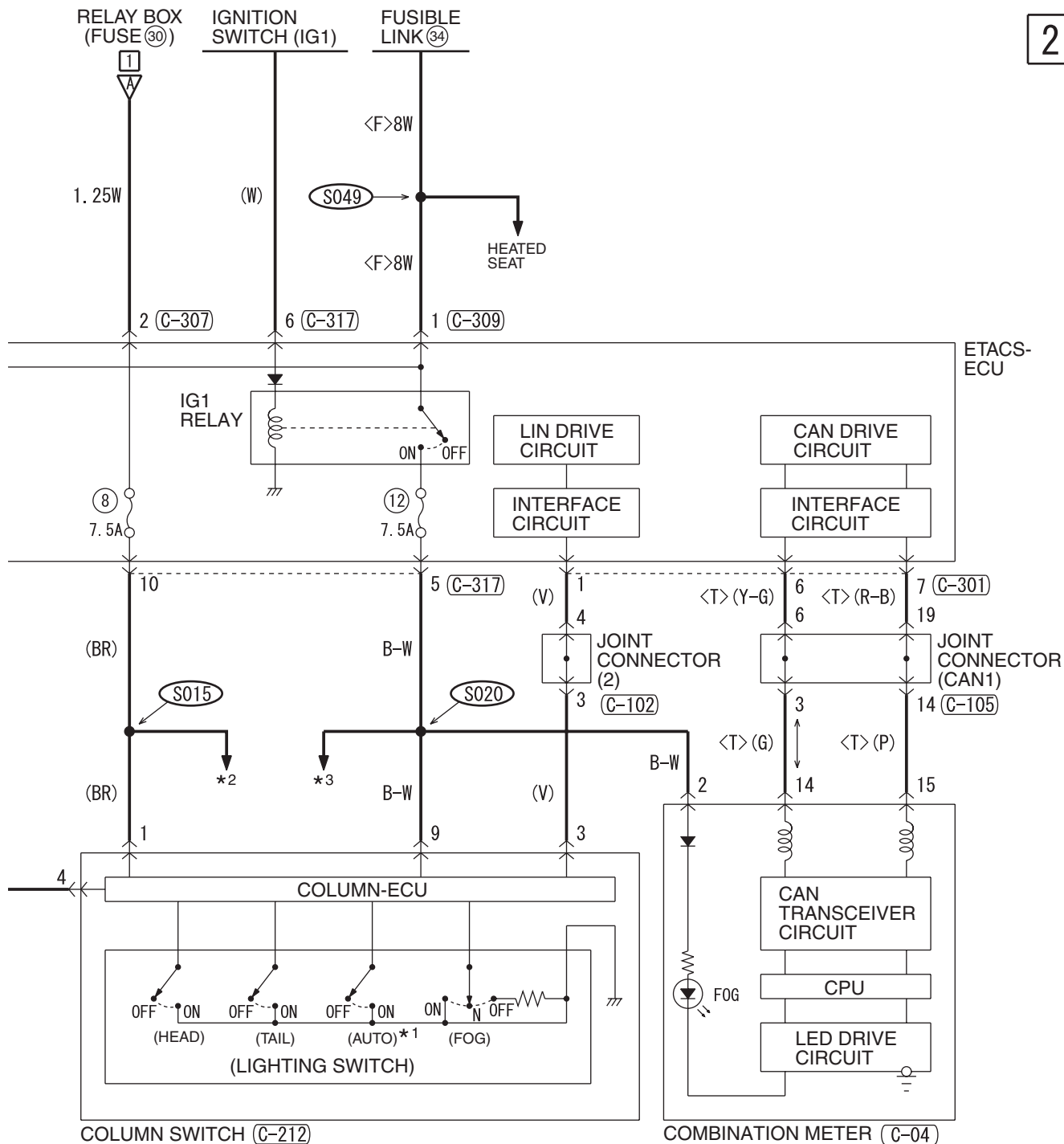

WIRE COLOR CODE
 B: BLACK LG: LIGHT GREEN G: GREEN L: BLUE W: WHITE Y: YELLOW SB: SKY BLUE
 BR: BROWN O: ORANGE GR: GRAY R: RED P: PINK V: VIOLET PU: PURPLE SI: SILVER

TAILLIGHT, POSITION LIGHT, LICENSE PLATE LIGHT AND LIGHTING MONITOR TONE ALARM

M1901001702028

1

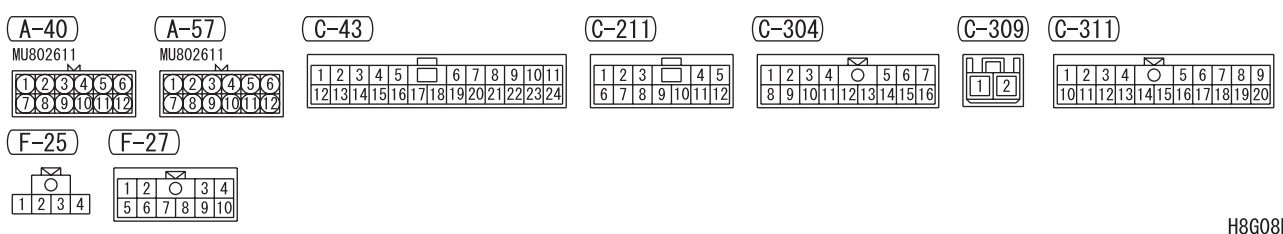
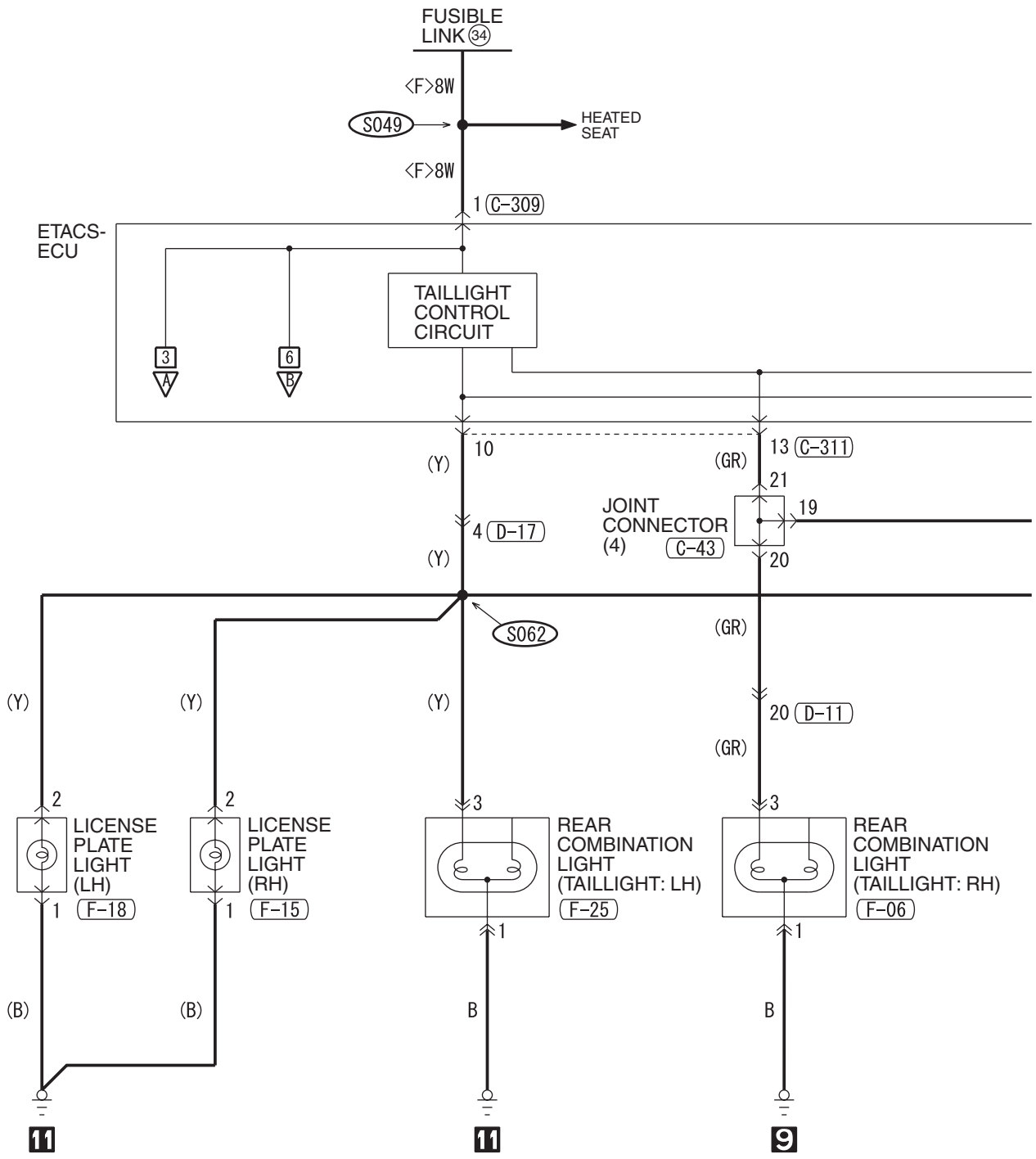

H8G08M25AA

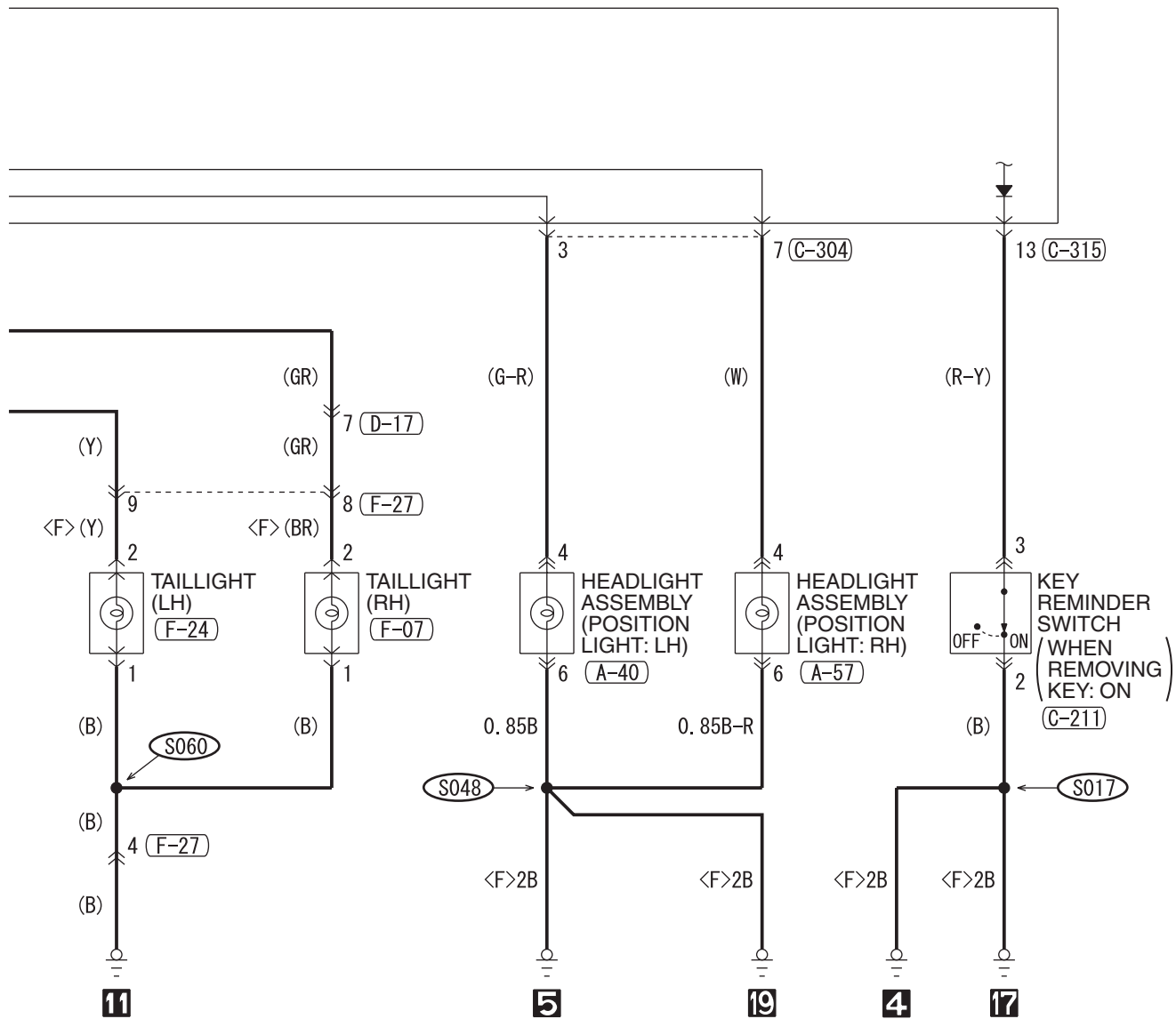

WIRE COLOR CODE
 B: BLACK LG: LIGHT GREEN G: GREEN L: BLUE W: WHITE Y: YELLOW SB: SKY BLUE
 BR: BROWN O: ORANGE GR: GRAY R: RED P: PINK V: VIOLET PU: PURPLE SI: SILVER

H8G08M25AB

TAILLIGHT, POSITION LIGHT, LICENSE PLATE LIGHT AND LIGHTING MONITOR TONE ALARM (CONTINUED)

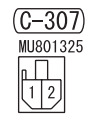
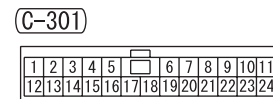
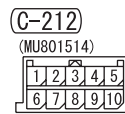
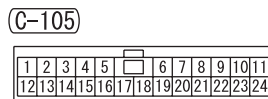
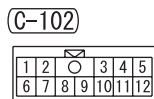
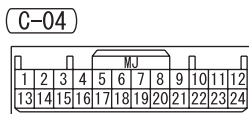
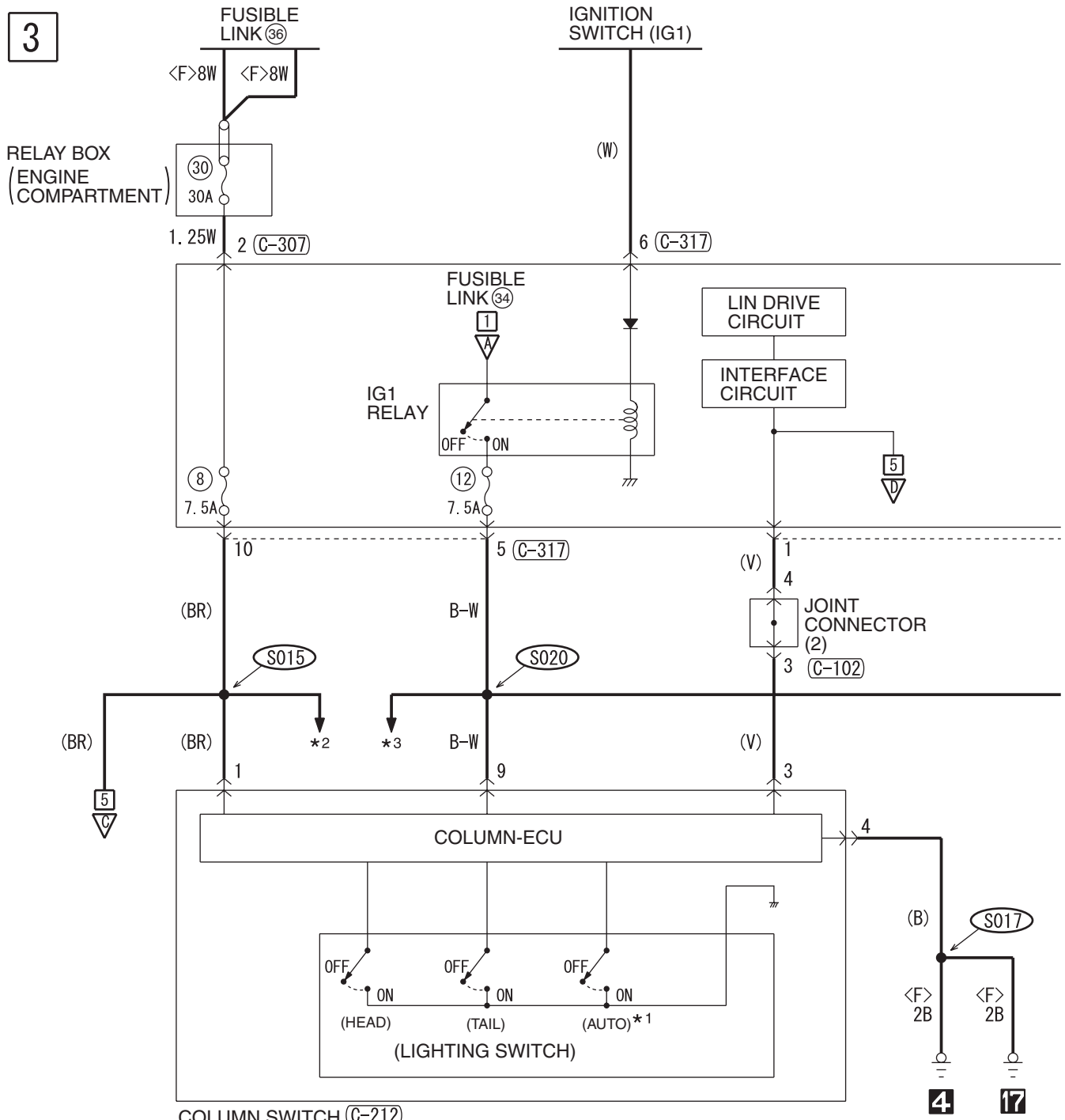

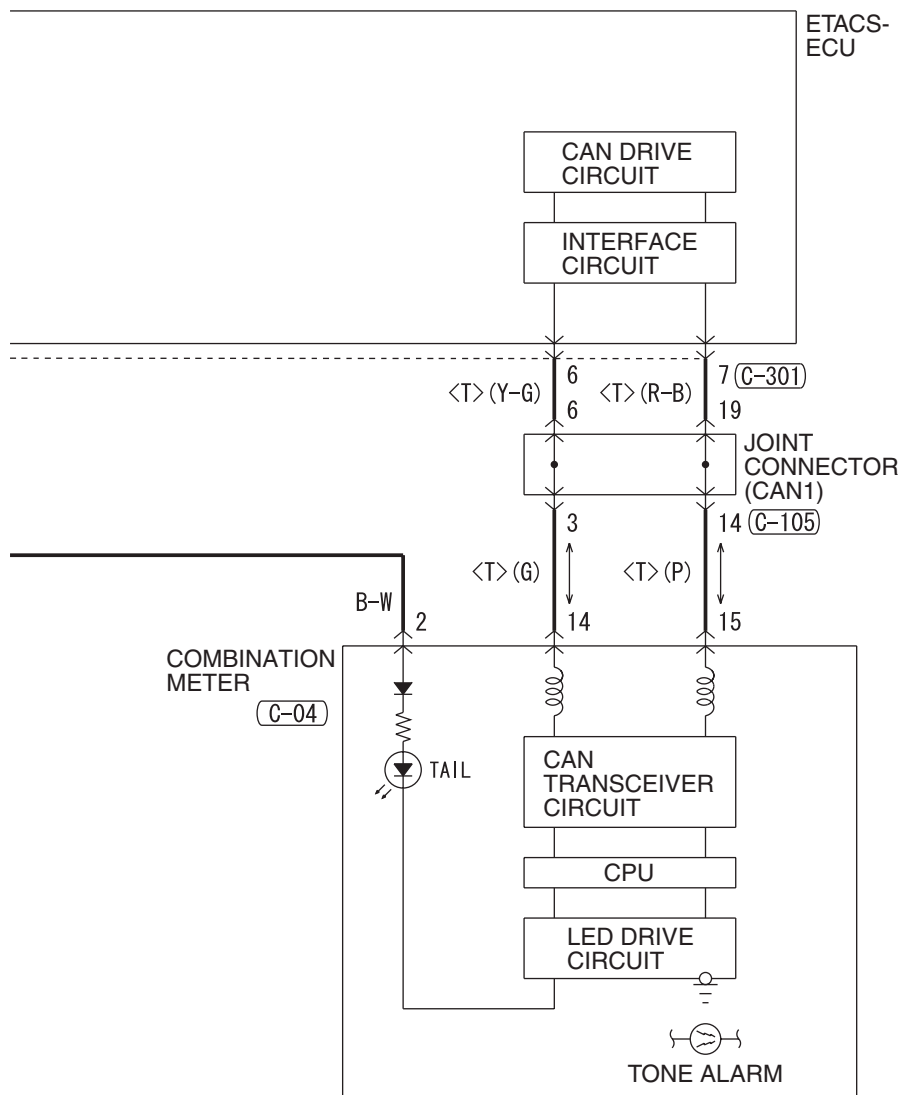

NOTE

- *1 : VEHICLES WITH AUTOMATIC LIGHT
- *2 : .AIR CONDITIONING SYSTEM
.BRAKE WARNING LIGHT,
.FUEL WARNING LIGHT AND OIL PRESSURE WARNING LIGHT
.CENTRAL DOOR LOCKING SYSTEM
.DOME LIGHT, LUGGAGE COMPARTMENT LIGHT AND IGNITION KEY HOLE ILLUMINATION LIGHT
.IGNITION KEY REMINDER TONE ALARM
-<VEHICLES WITH KOS>
.IMMOBILIZER SYSTEM
.KEYLESS OPERATION SYSTEM (KOS)
.METER AND GAUGE
.SEAT BELT WARNING TONE ALARM
.THEFT-ALARM SYSTEM
.TIRE PRESSURE MONITORING SYSTEM (TPMS)
.TRUNK LID OPENER
- *3 : .ABS, ASC, ACD, AYC AND S-AWC
.AIR CONDITIONING SYSTEM
.CENTRAL DOOR LOCKING SYSTEM
.DOME LIGHT, LUGGAGE COMPARTMENT LIGHT AND IGNITION KEY HOLE ILLUMINATION LIGHT
.HEATED SEAT
.IGNITION KEY REMINDER TONE ALARM
.IMMOBILIZER SYSTEM
.KEYLESS OPERATING SYSTEM (KOS)
.REAR WINDOW DEFOGGER
.SEAT BELT WARNING TONE ALARM
.SHIFT LOCK MECHANISM
.SUNROOF
.SUPPLEMENTAL RESTRAINT SYSTEM (SRS)
.TC-SST
.THEFT-ALARM SYSTEM
.TIRE PRESSURE MONITORING SYSTEM (TPMS)
.TRUNK LID OPENER

(C-317)

1	2	3	4	5	6	7	
8	9	10	11	12	13	14	15

WIRE COLOR CODE

B : BLACK LG : LIGHT GREEN G : GREEN L : BLUE W : WHITE Y : YELLOW SB : SKY BLUE
BR : BROWN O : ORANGE GR : GRAY R : RED P : PINK V : VIOLET PU : PURPLE SI : SILVER

TAILLIGHT, POSITION LIGHT, LICENSE PLATE LIGHT AND LIGHTING MONITOR TONE ALARM (CONTINUED)

5

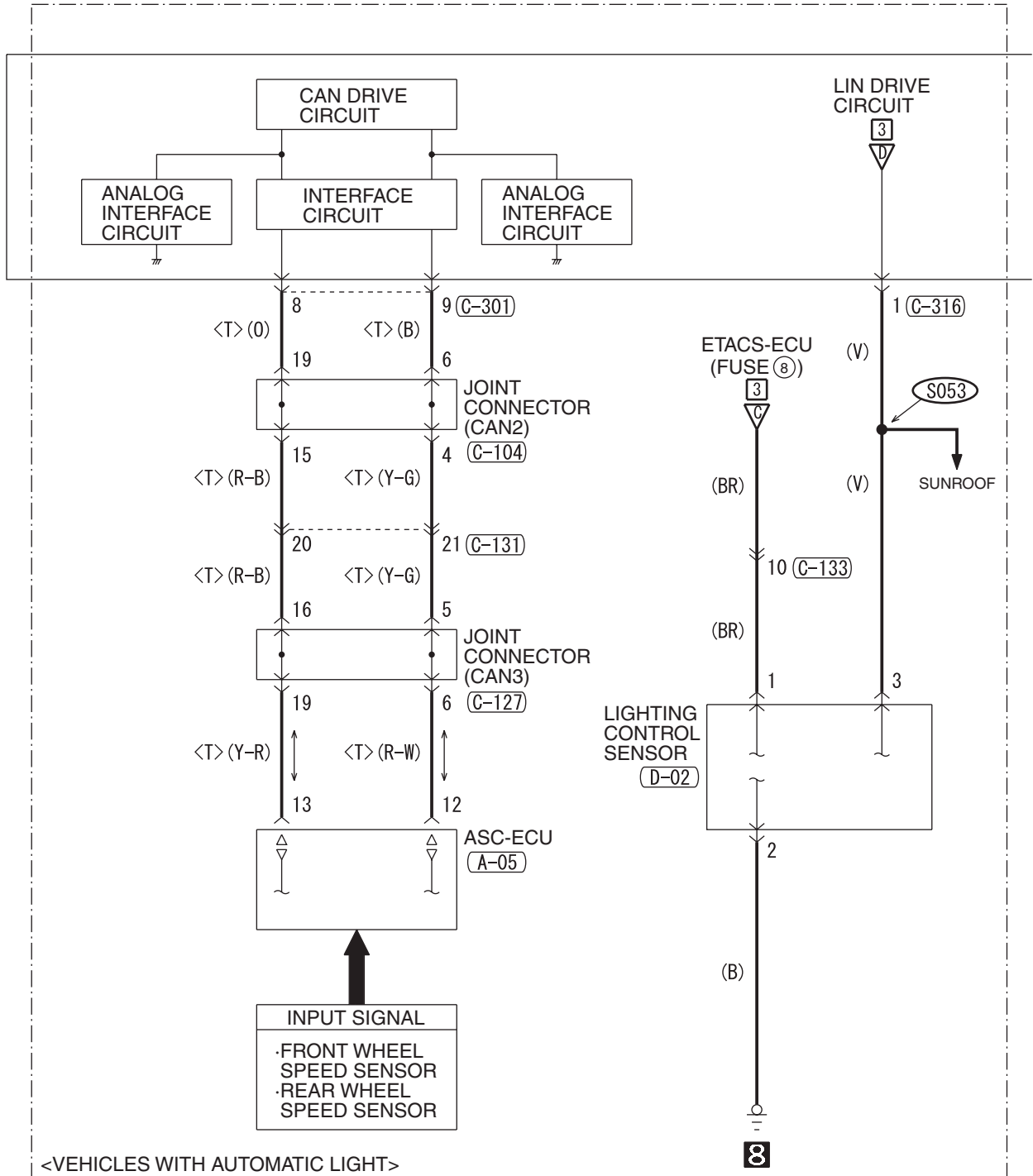

(A-05)

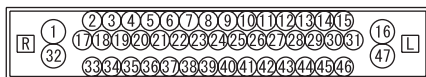

(D-02)



(D-28)



(C-40) FRONT SIDE



(C-104)

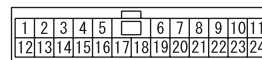

(C-127)

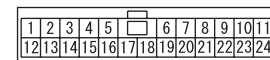

6

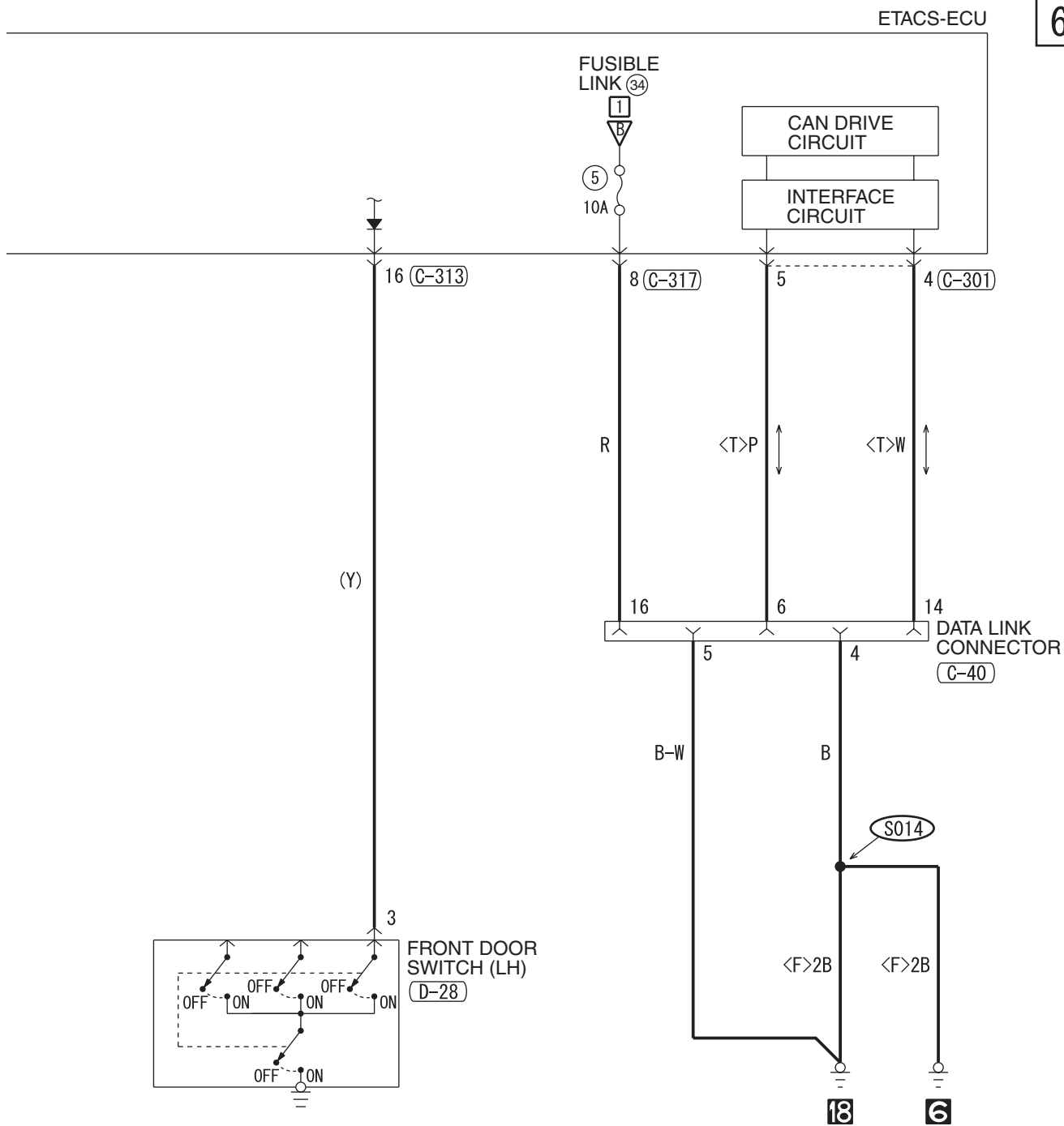

(C-131)

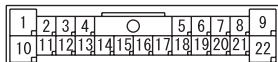

(C-133)

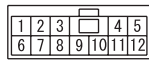

(C-301)

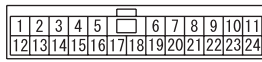

(C-313)

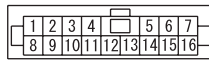

(C-316)



(C-317)



WIRE COLOR CODE

B: BLACK LG: LIGHT GREEN G: GREEN L: BLUE W: WHITE Y: YELLOW SB: SKY BLUE
 BR: BROWN O: ORANGE GR: GRAY R: RED P: PINK V: VIOLET PU: PURPLE SI: SILVER

H8G08M25CB

DOME LIGHT, LUGGAGE COMPARTMENT LIGHT AND IGNITION KEY HOLE ILLUMINATION LIGHT

M1901030800096

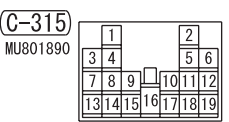
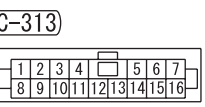
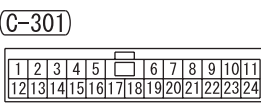
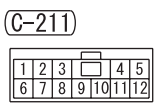
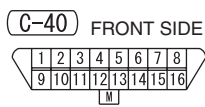
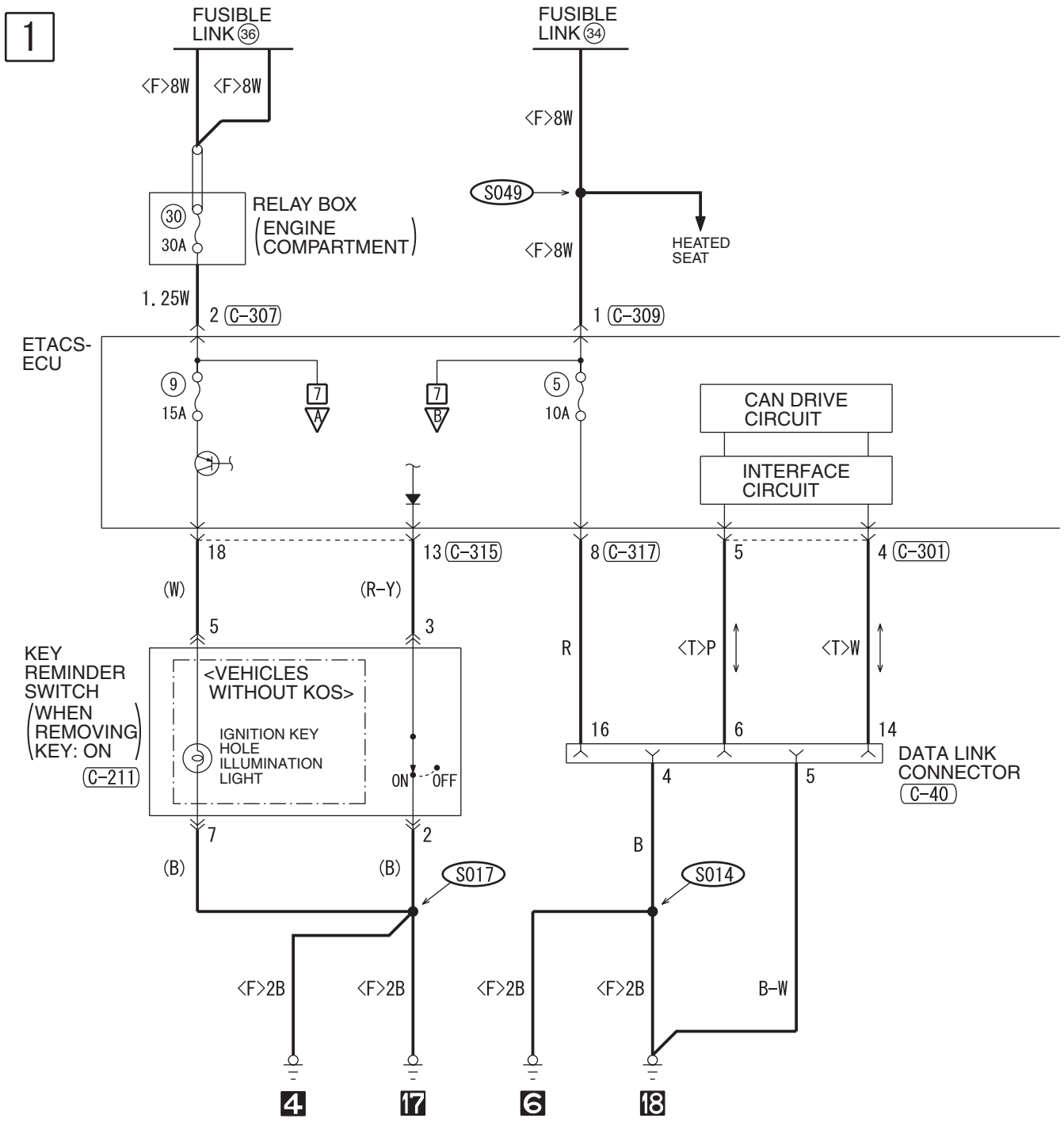

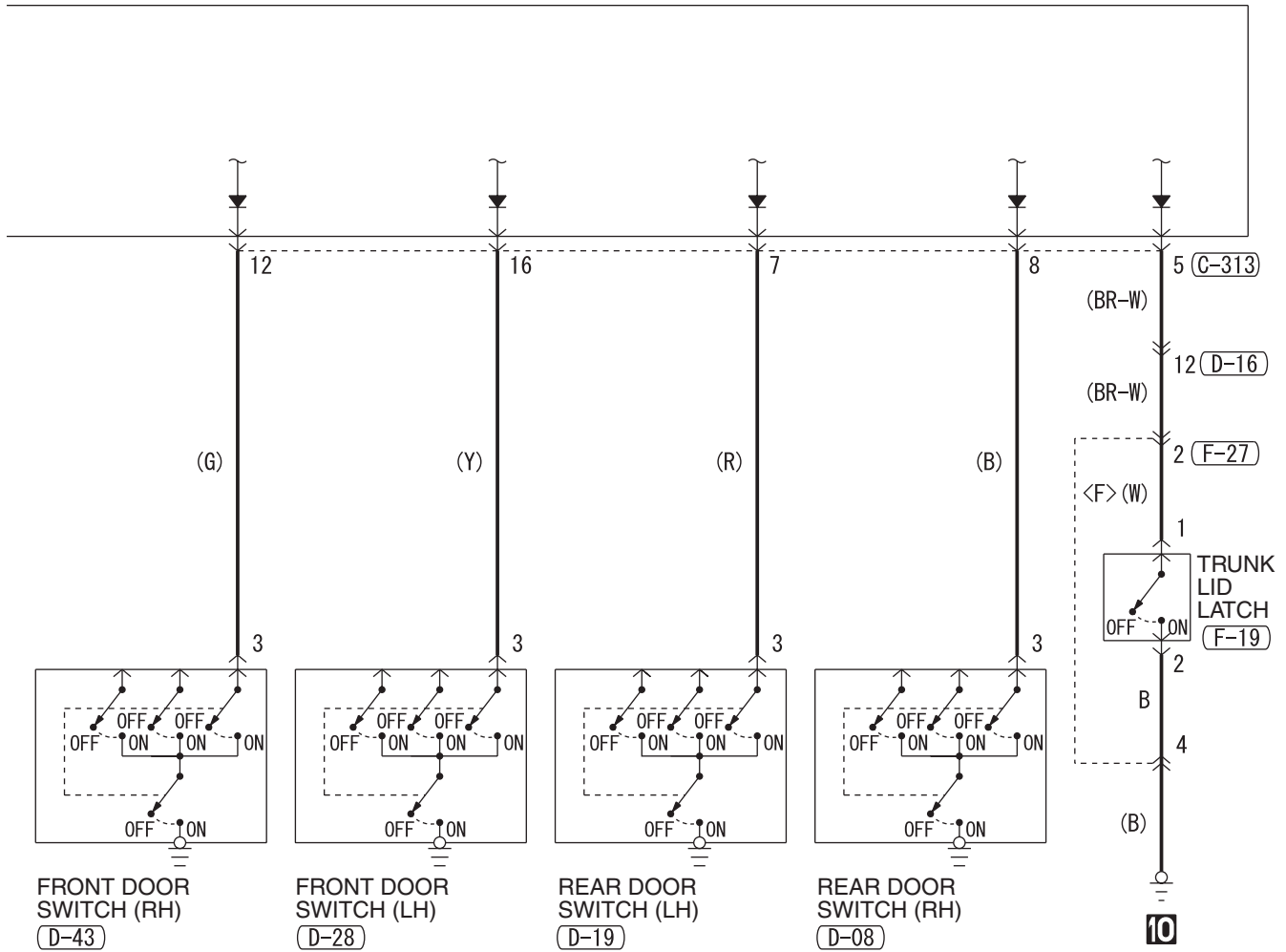

(C-317)



(D-08) (MU801536)



(D-16)

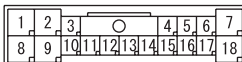

(D-19) (MU801536)



(D-28) (MU801536)



(D-43) (MU801536)



(F-19) MU801685



(F-27)

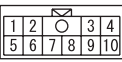

WIRE COLOR CODE

B : BLACK LG : LIGHT GREEN G : GREEN L : BLUE W : WHITE Y : YELLOW SB : SKY BLUE
 BR : BROWN O : ORANGE GR : GRAY R : RED P : PINK V : VIOLET PU : PURPLE SI : SILVER

DOME LIGHT, LUGGAGE COMPARTMENT LIGHT AND IGNITION KEY HOLE ILLUMINATION LIGHT (CONTINUED)

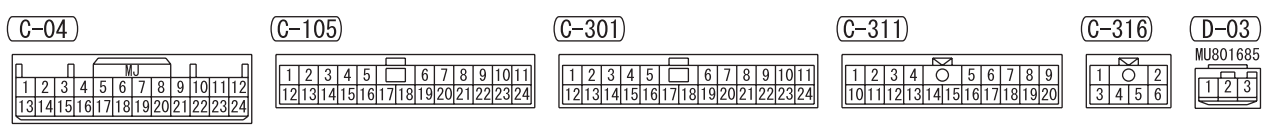
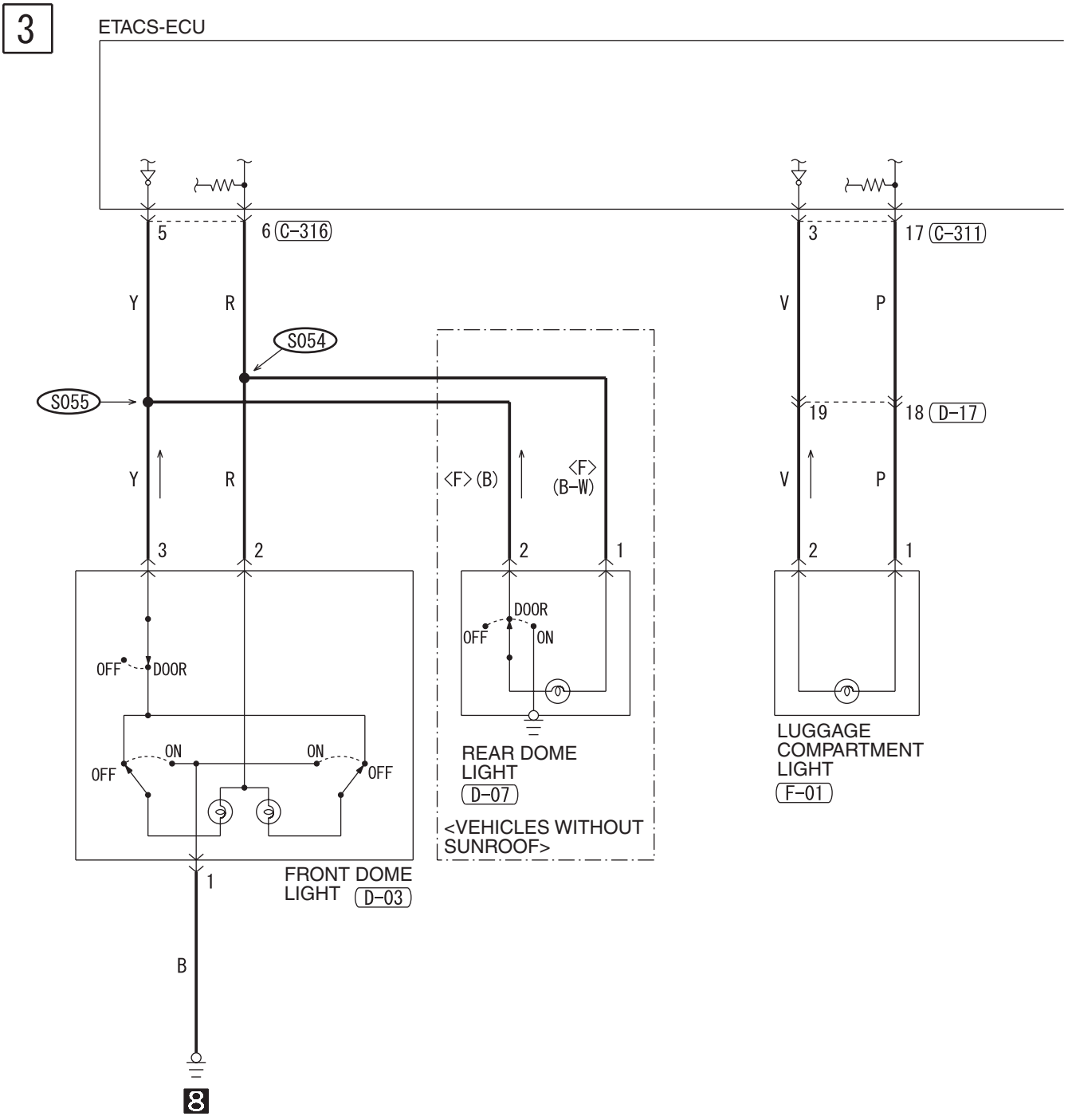

4

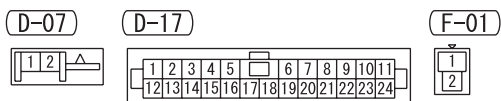
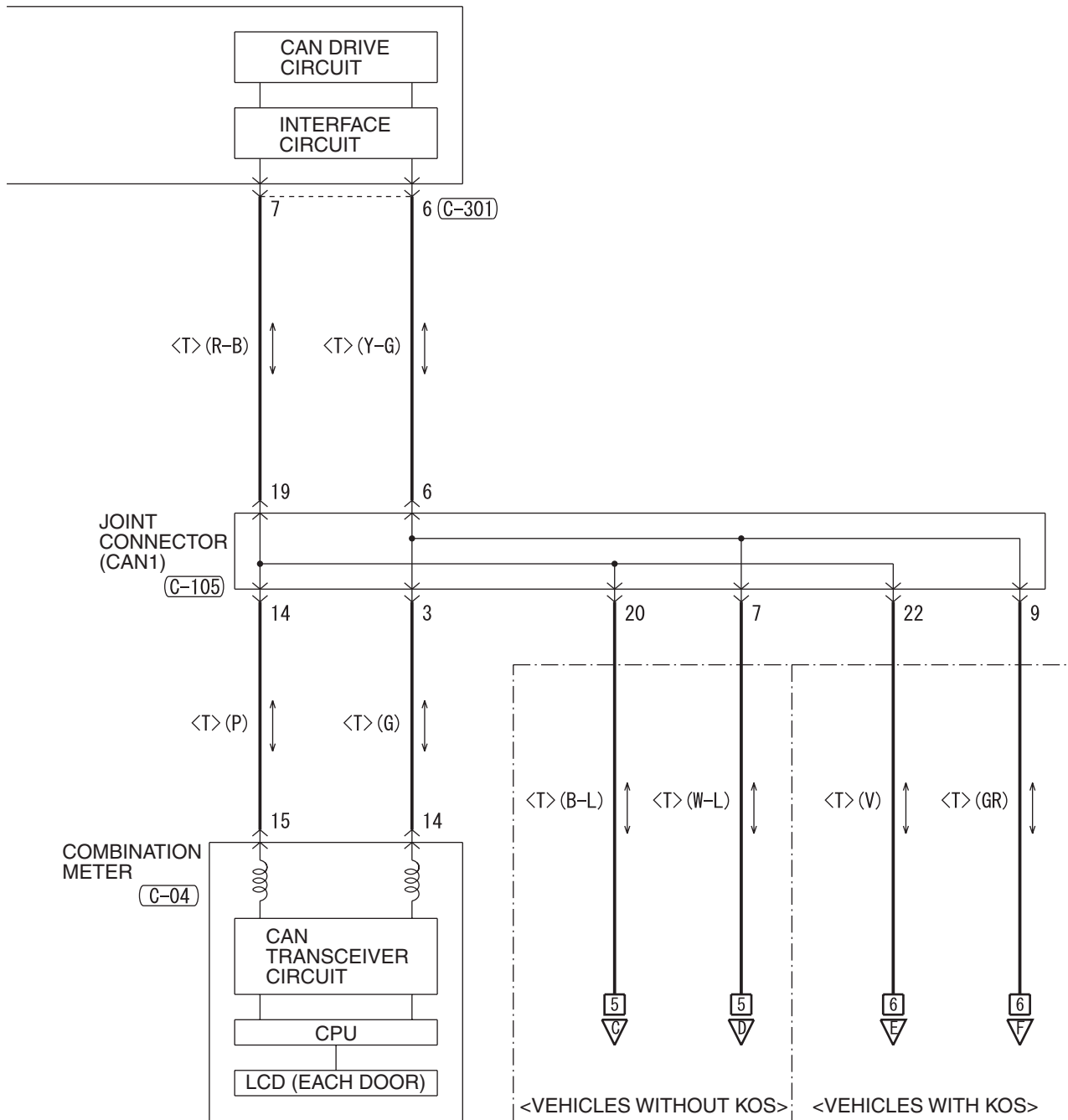

WIRE COLOR CODE
 B: BLACK LG: LIGHT GREEN G: GREEN L: BLUE W: WHITE Y: YELLOW SB: SKY BLUE
 BR: BROWN O: ORANGE GR: GRAY R: RED P: PINK V: VIOLET PU: PURPLE SI: SILVER

H8G08M26BB

TSB Revision

DOME LIGHT, LUGGAGE COMPARTMENT LIGHT AND IGNITION KEY HOLE ILLUMINATION LIGHT (CONTINUED)

5

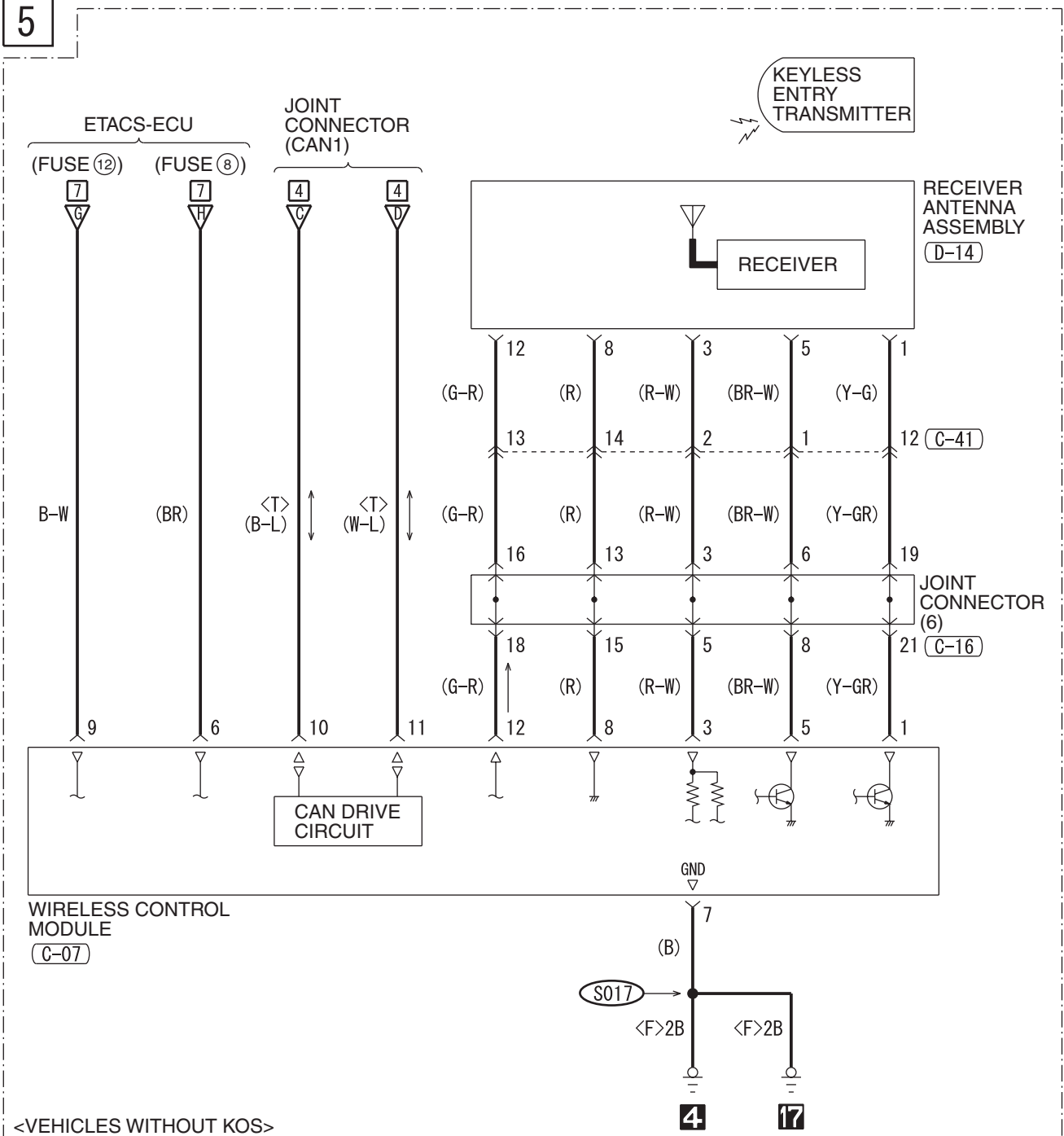

(C-05)

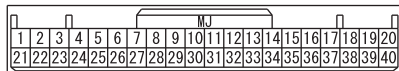

(C-07)

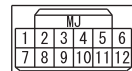

(C-16)



(C-41)

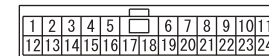

(D-14)

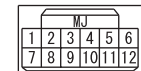

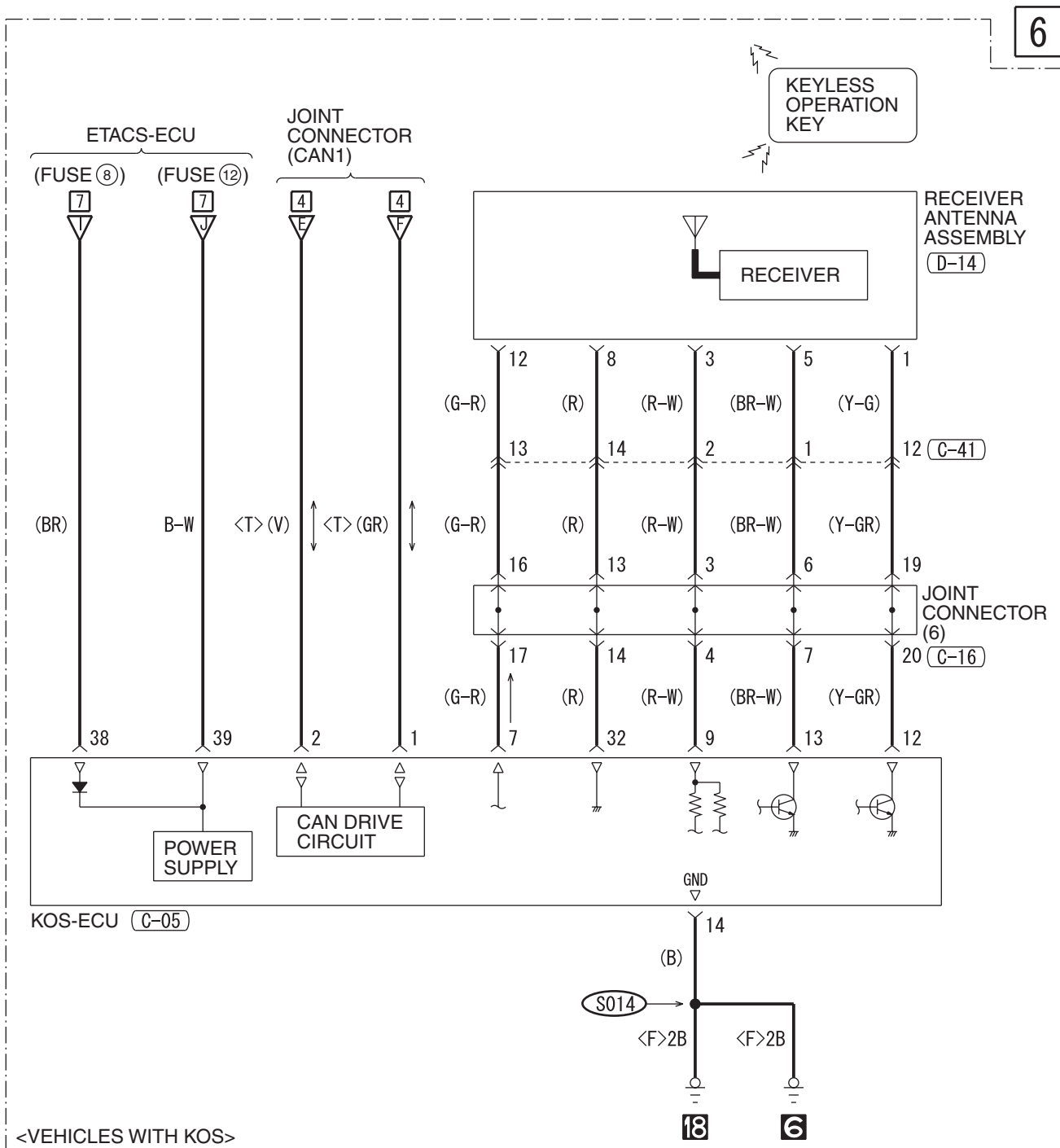

WIRE COLOR CODE

B: BLACK LG: LIGHT GREEN G: GREEN L: BLUE W: WHITE Y: YELLOW SB: SKY BLUE
 BR: BROWN O: ORANGE GR: GRAY R: RED P: PINK V: VIOLET PU: PURPLE SI: SILVER

H8G08M26CB

DOME LIGHT, LUGGAGE COMPARTMENT LIGHT AND IGNITION KEY HOLE ILLUMINATION LIGHT (CONTINUED)

7

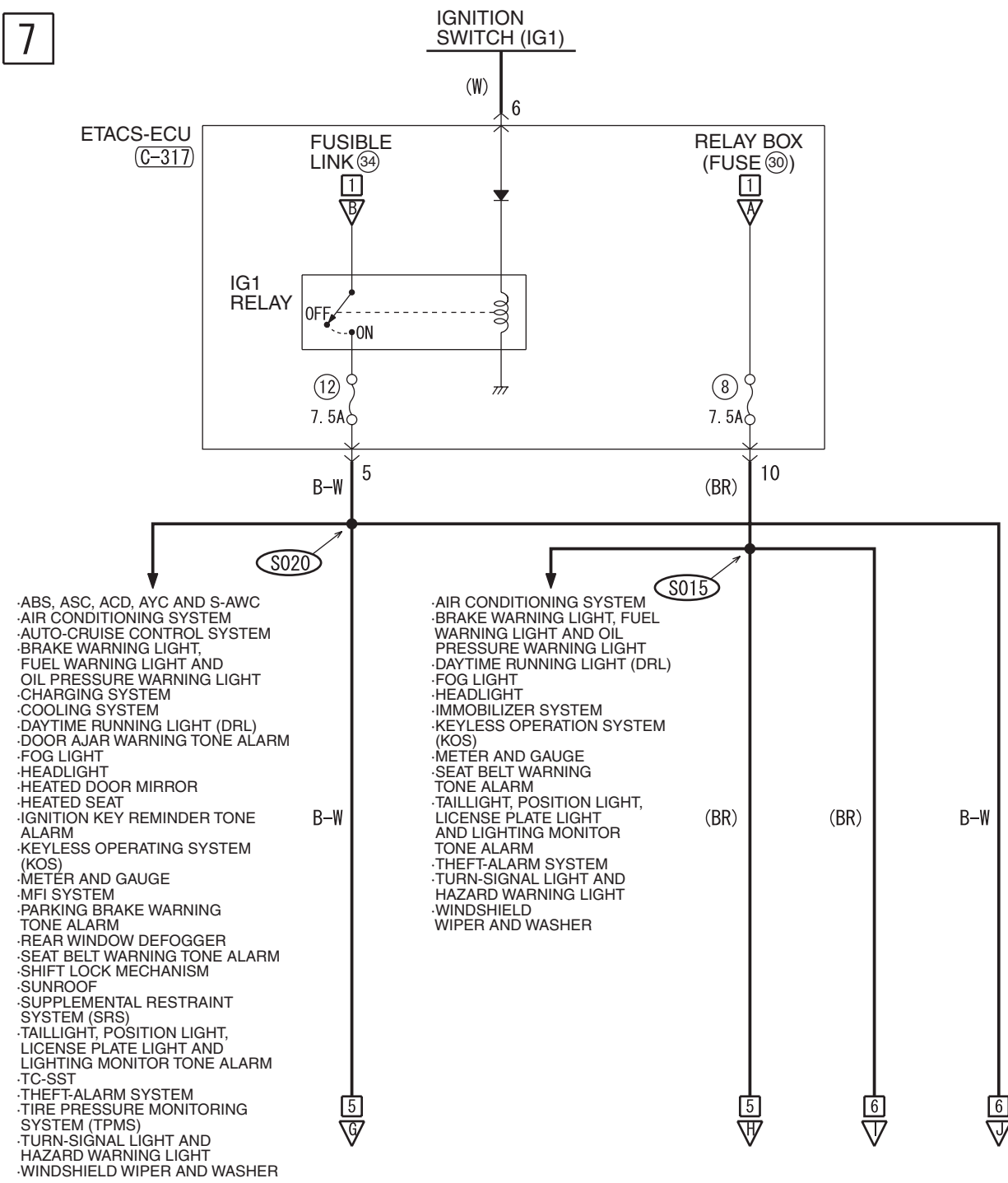

(C-317)

1	2	3	4	5	6	7	
8	9	10	11	12	13	14	15

WIRE COLOR CODE
 B : BLACK LG : LIGHT GREEN G : GREEN L : BLUE W : WHITE Y : YELLOW SB : SKY BLUE
 BR : BROWN O : ORANGE GR : GRAY R : RED P : PINK V : VIOLET PU : PURPLE SI : SILVER

NOTES

TURN-SIGNAL LIGHT AND HAZARD WARNING LIGHT

M1901002902702

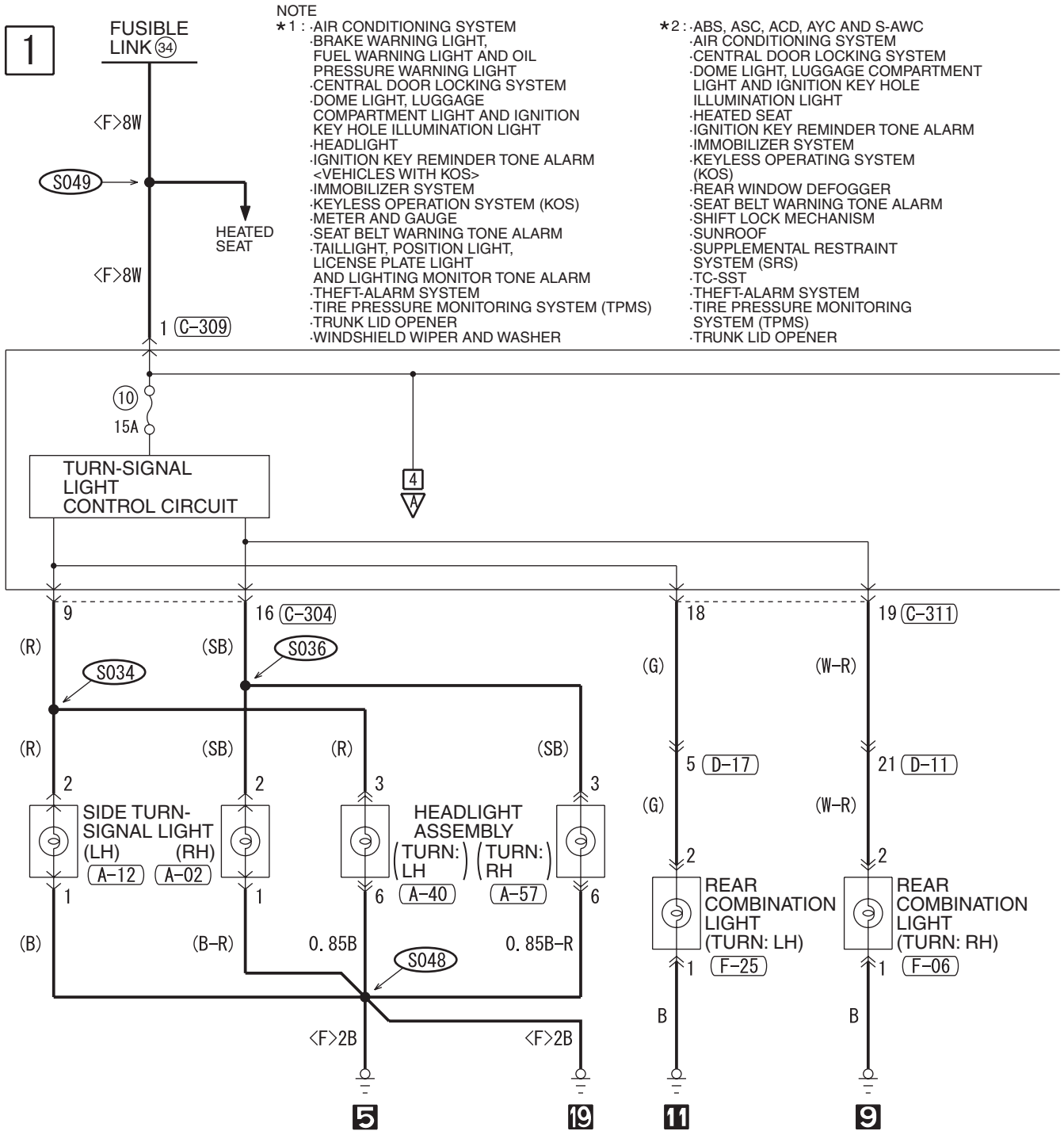

NOTE

- *1 :
 .AIR CONDITIONING SYSTEM
 .BRAKE WARNING LIGHT
 .FUEL WARNING LIGHT AND OIL PRESSURE WARNING LIGHT
 .CENTRAL DOOR LOCKING SYSTEM
 .DOME LIGHT, LUGGAGE COMPARTMENT LIGHT AND IGNITION KEY HOLE ILLUMINATION LIGHT
 .HEADLIGHT
 .IGNITION KEY REMINDER TONE ALARM
 <VEHICLES WITH KOS>
 .IMMOBILIZER SYSTEM
 .KEYLESS OPERATION SYSTEM (KOS)
 .METER AND GAUGE
 .SEAT BELT WARNING TONE ALARM
 .TAILLIGHT, POSITION LIGHT, LICENSE PLATE LIGHT AND LIGHTING MONITOR TONE ALARM
 .THEFT-ALARM SYSTEM
 .TIRE PRESSURE MONITORING SYSTEM (TPMS)
 .TRUNK LID OPENER
 .WINDSHIELD WIPER AND WASHER

- *2 :
 .ABS, ASC, ACD, AYC AND S-AWC
 .AIR CONDITIONING SYSTEM
 .CENTRAL DOOR LOCKING SYSTEM
 .DOME LIGHT, LUGGAGE COMPARTMENT LIGHT AND IGNITION KEY HOLE ILLUMINATION LIGHT
 .HEATED SEAT
 .IGNITION KEY REMINDER TONE ALARM
 .IMMOBILIZER SYSTEM
 .KEYLESS OPERATING SYSTEM (KOS)
 .REAR WINDOW DEFOGGER
 .SEAT BELT WARNING TONE ALARM
 .SHIFT LOCK MECHANISM
 .SUNROOF
 .SUPPLEMENTAL RESTRAINT SYSTEM (SRS)
 .TC-SST
 .THEFT-ALARM SYSTEM
 .TIRE PRESSURE MONITORING SYSTEM (TPMS)
 .TRUNK LID OPENER

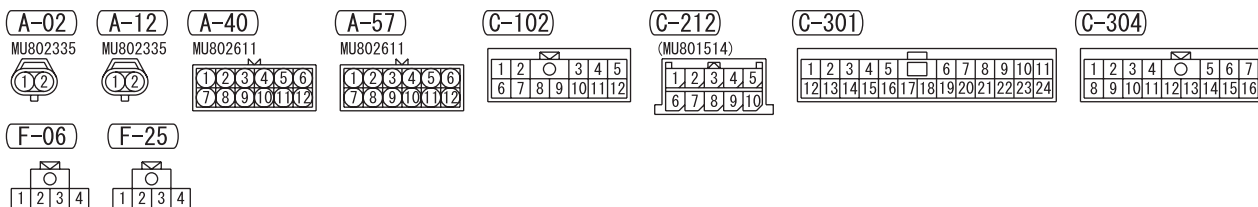

H8G09M08AA

2

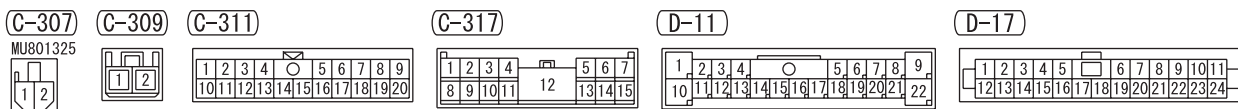
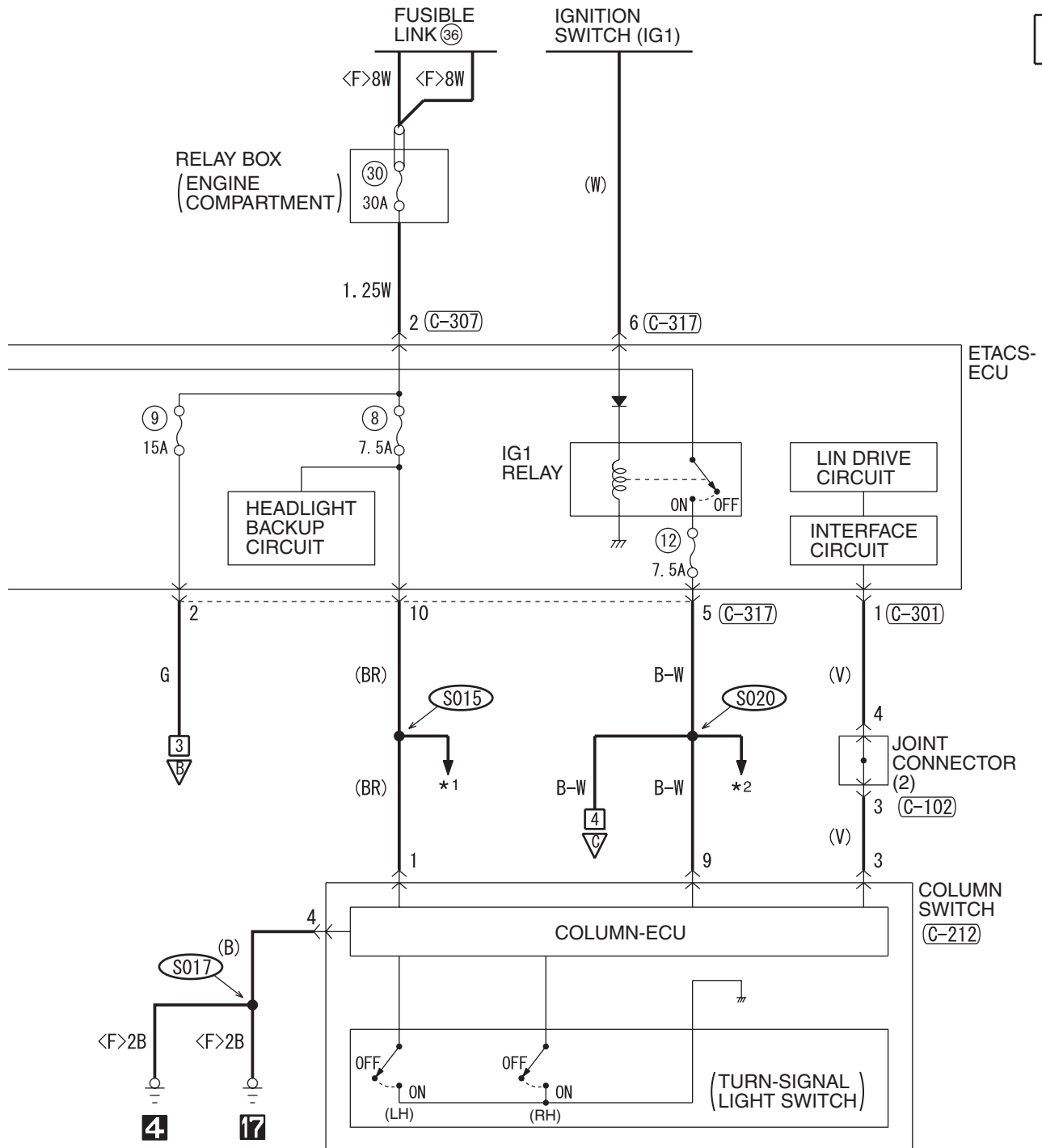

WIRE COLOR CODE
 B: BLACK LG: LIGHT GREEN G: GREEN L: BLUE W: WHITE Y: YELLOW SB: SKY BLUE
 BR: BROWN O: ORANGE GR: GRAY R: RED P: PINK V: VIOLET PU: PURPLE SI: SILVER

H8G09M08AB

TSB Revision

TURN-SIGNAL LIGHT AND HAZARD WARNING LIGHT (CONTINUED)

3

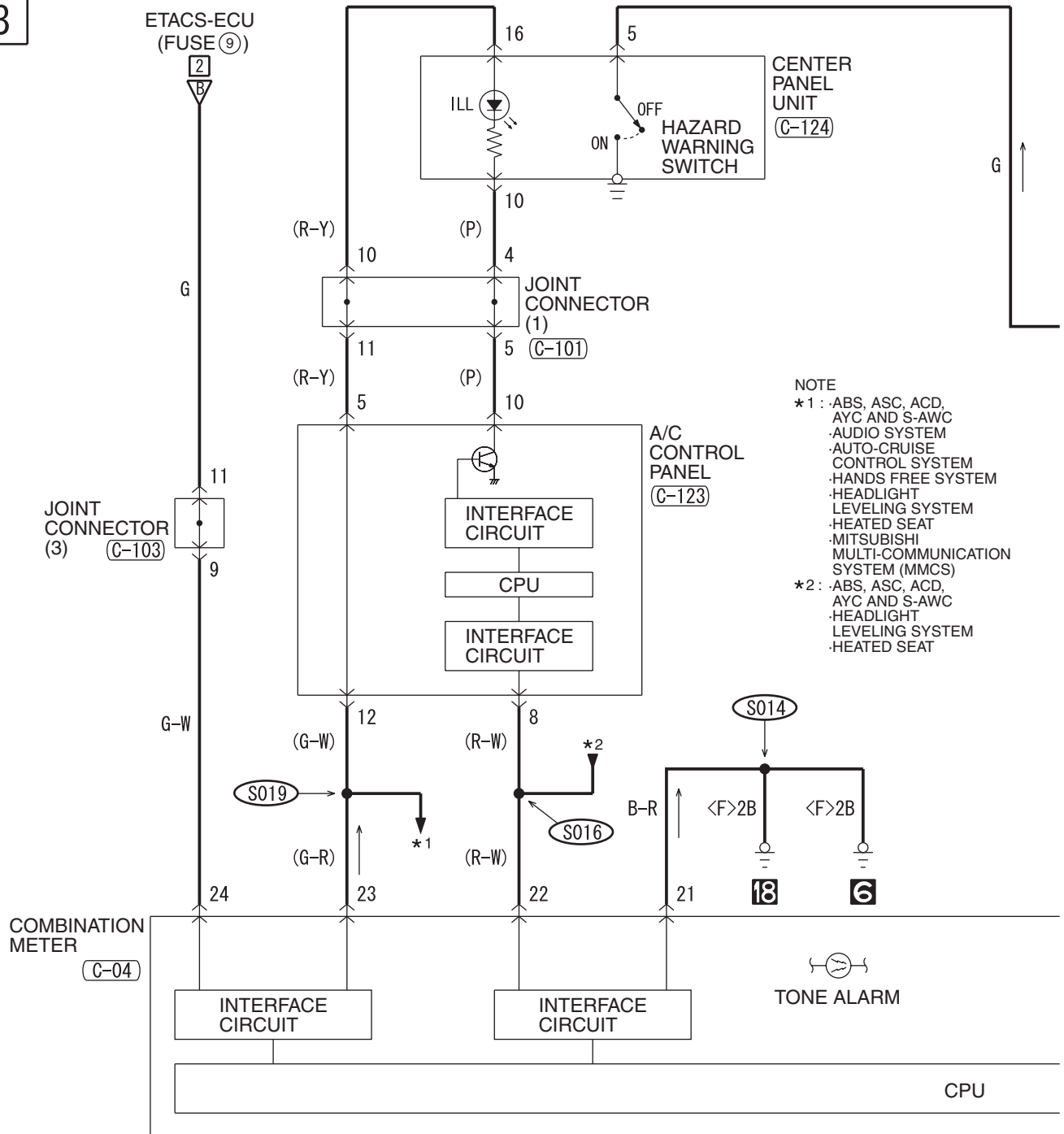

NOTE
 *1 : -ABS, ASC, ACD, AYC AND S-AWC
 -AUDIO SYSTEM
 -AUTO-CRUISE CONTROL SYSTEM
 -HANDS FREE SYSTEM
 -HEADLIGHT LEVELING SYSTEM
 -HEATED SEAT
 -MITSUBISHI MULTI-COMMUNICATION SYSTEM (MMCS)
 *2 : -ABS, ASC, ACD, AYC AND S-AWC
 -HEADLIGHT LEVELING SYSTEM
 -HEATED SEAT

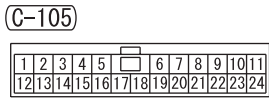
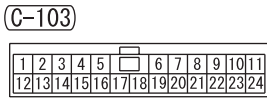
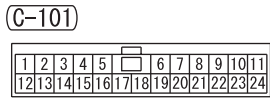
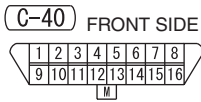
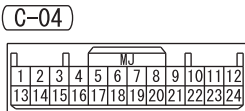

4

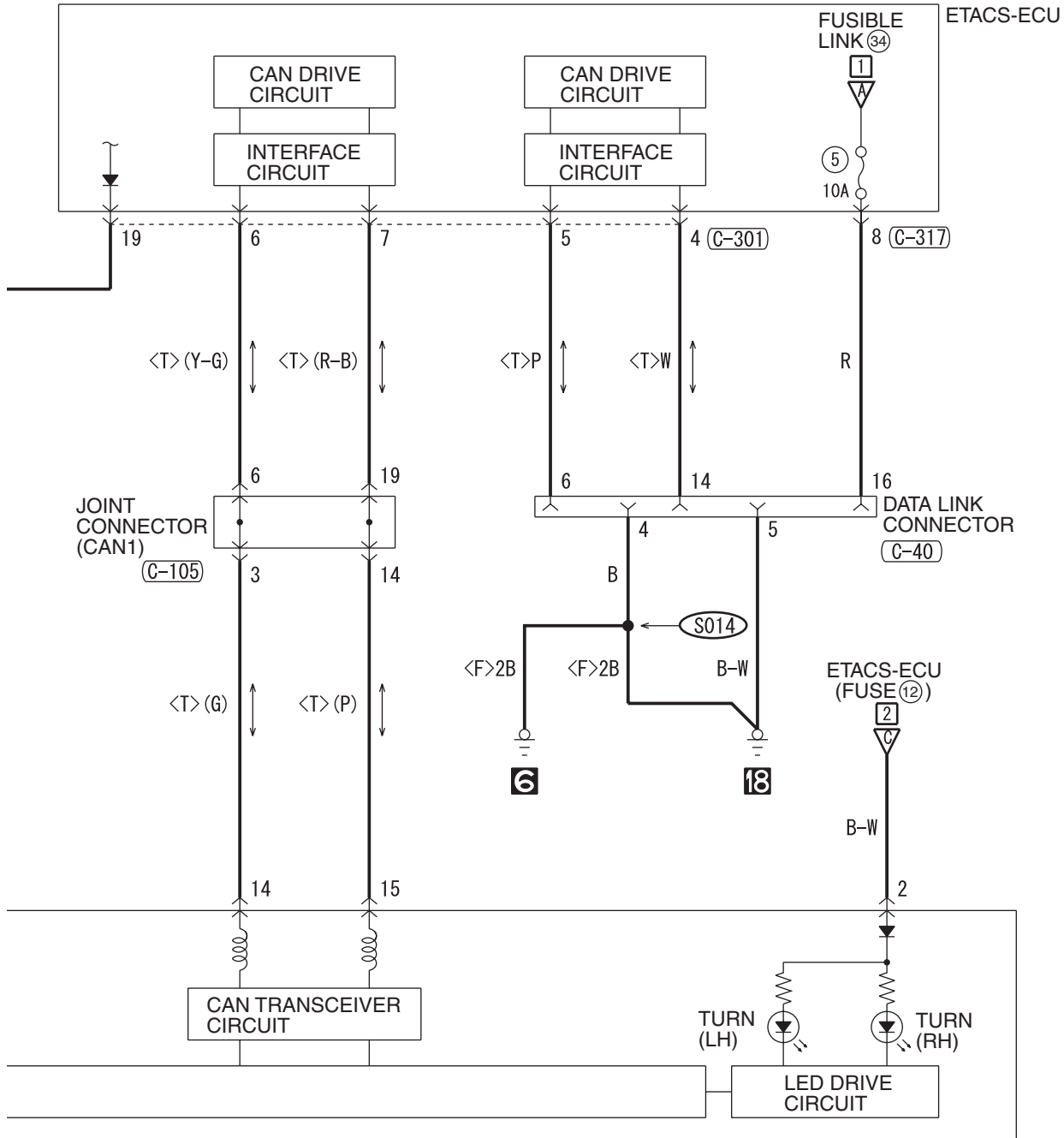

(C-123)

(C-124)

(C-301)

(C-317)

1	2	3	4	5	6
7	8	9	10	11	12

1	2	3	4	5	6	7	8
9	10	11	12	13	14	15	16

1	2	3	4	5	6	7	8	9	10	11		
12	13	14	15	16	17	18	19	20	21	22	23	24

1	2	3	4	5	6	7	
8	9	10	11	12	13	14	15

WIRE COLOR CODE

B: BLACK LG: LIGHT GREEN G: GREEN L: BLUE W: WHITE Y: YELLOW SB: SKY BLUE
BR: BROWN O: ORANGE GR: GRAY R: RED P: PINK V: VIOLET PU: PURPLE SI: SILVER

H8G09M08BB

TSB Revision

BACKUP LIGHT <M/T>

1

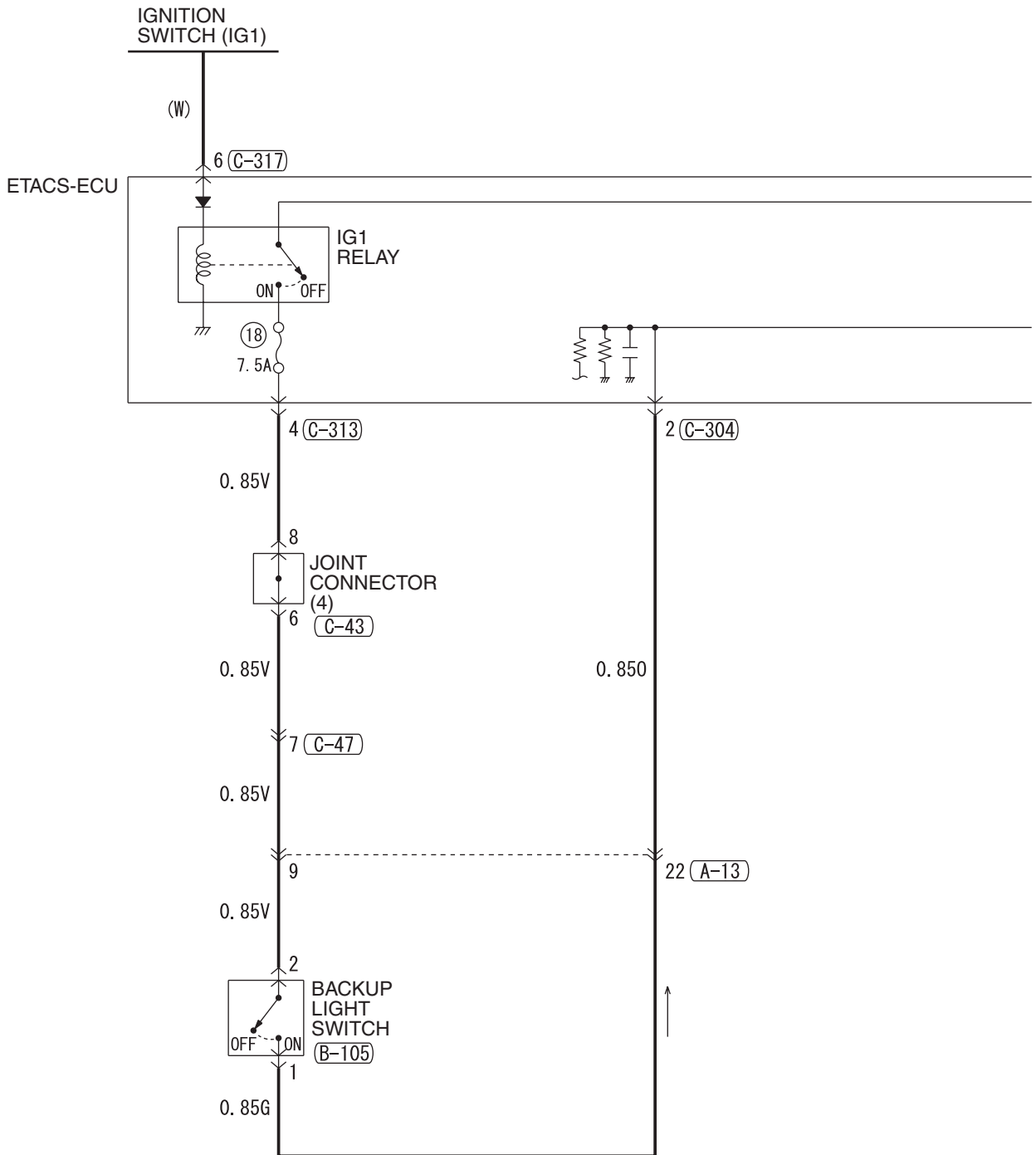

(A-13)

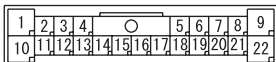

(B-105)



(C-40) FRONT SIDE

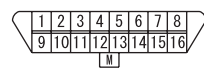

(C-43)

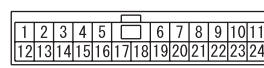

(C-47)

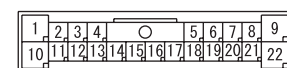

(D-17)

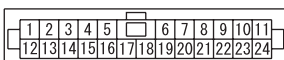

(F-08)



(F-22)



(F-27)

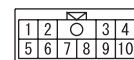

2

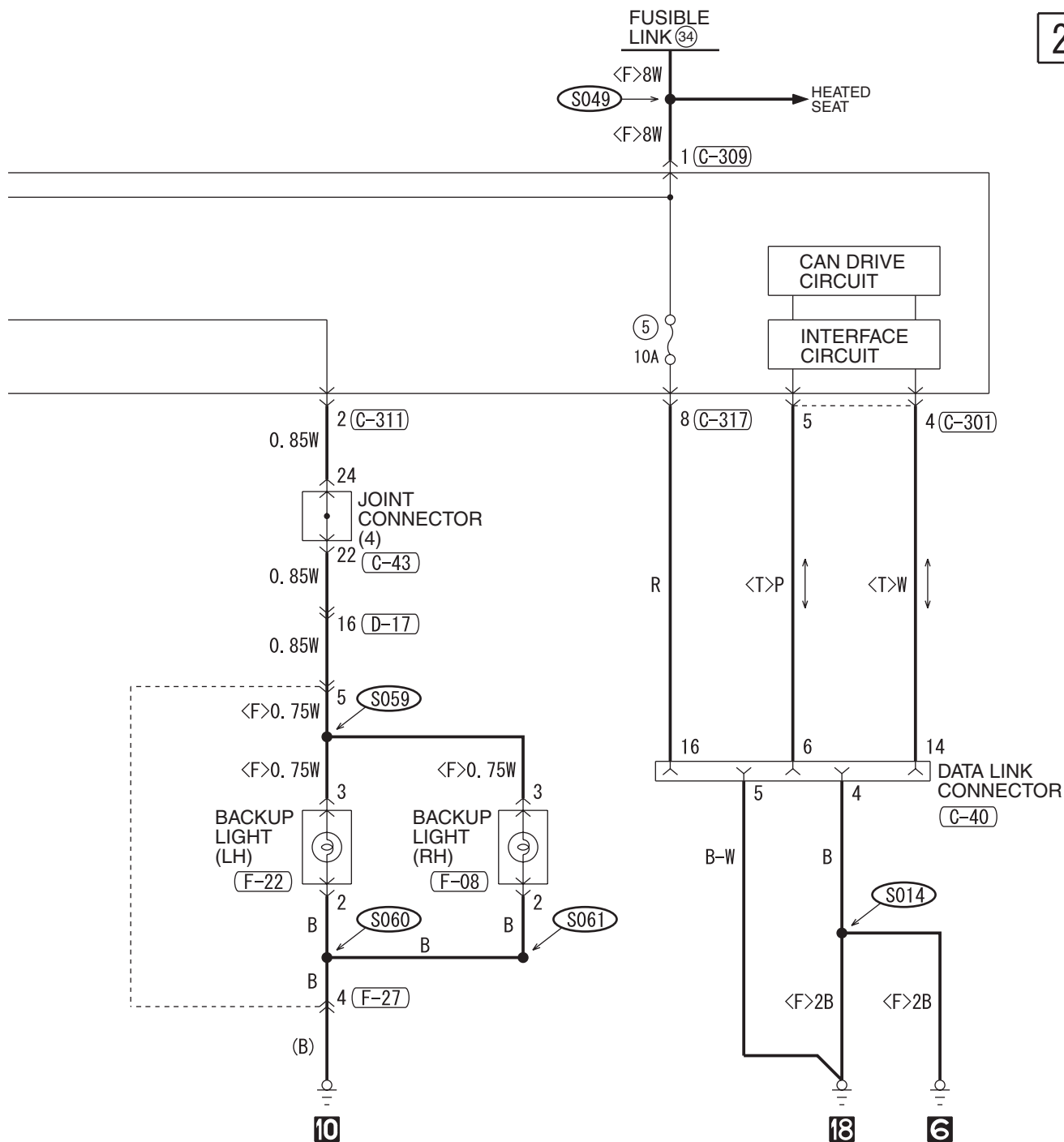

(C-301)

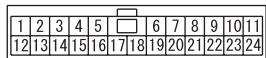

(C-304)

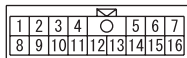

(C-309)



(C-311)

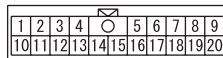

(C-313)

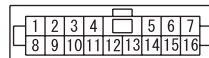

(C-317)

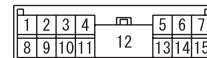

WIRE COLOR CODE

B : BLACK LG : LIGHT GREEN G : GREEN L : BLUE W : WHITE Y : YELLOW SB : SKY BLUE
BR : BROWN O : ORANGE GR : GRAY R : RED P : PINK V : VIOLET PU : PURPLE SI : SILVER

H8G09M09AB

BACKUP LIGHT <TC-SST>

M1901003103241

1

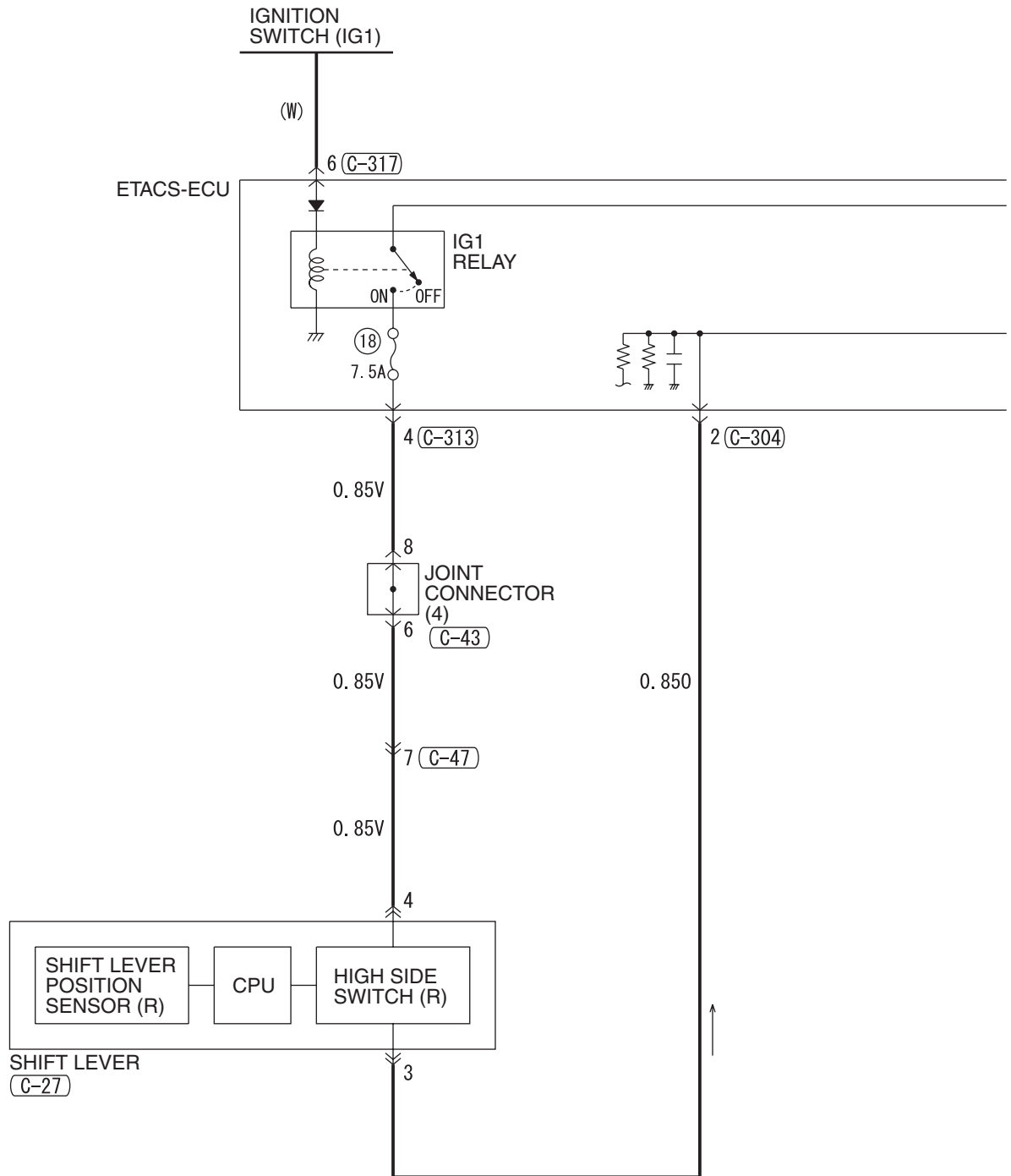

(C-27)

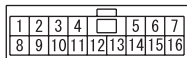

(C-40) FRONT SIDE

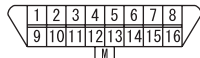

(C-43)

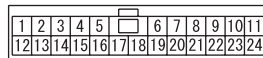

(C-47)

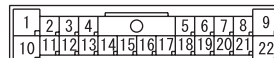

(C-301)

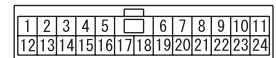

(F-08)



(F-22)



(F-27)

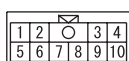

H8G09M10AA

2

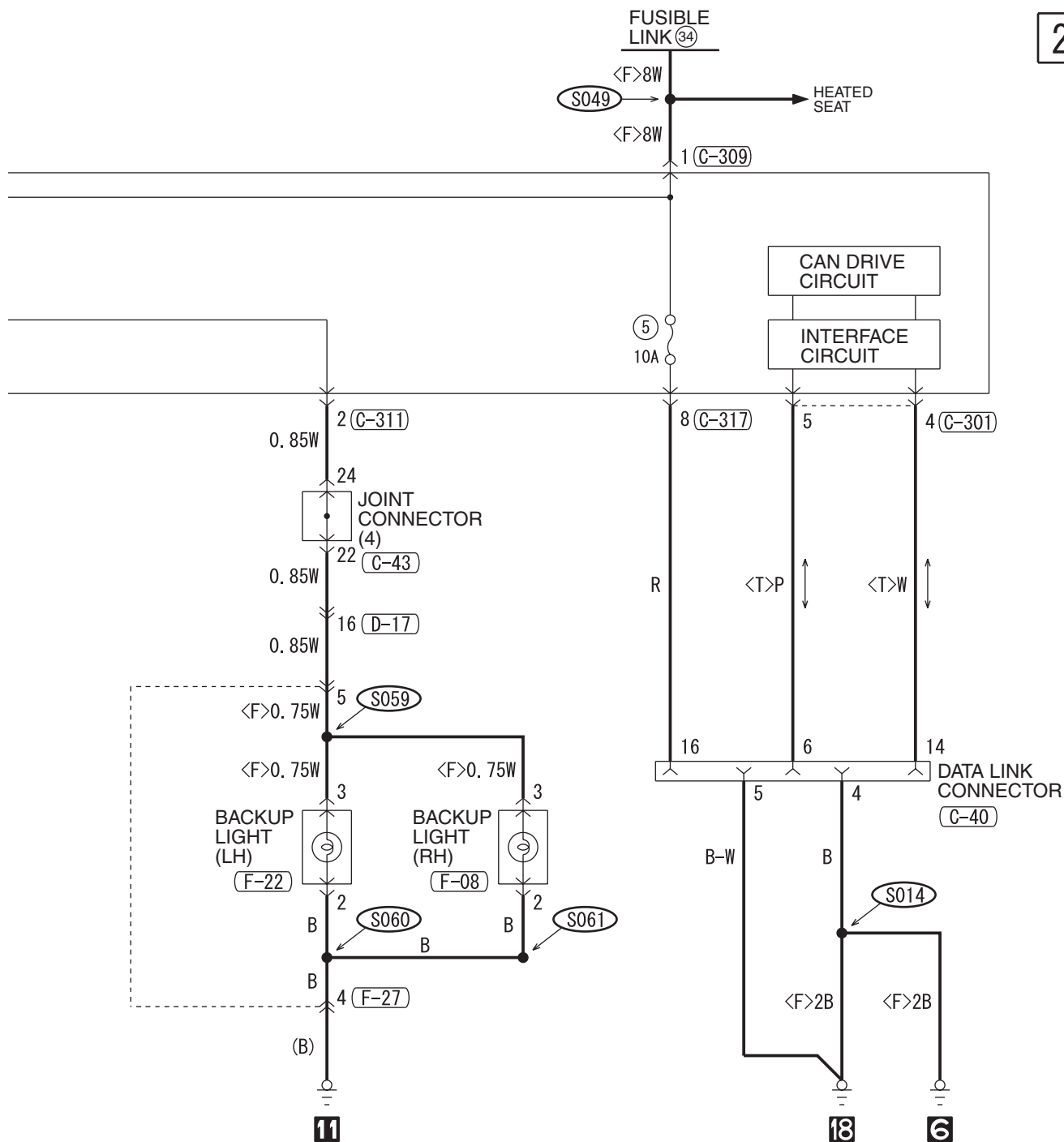

(C-304)

(C-309)

(C-311)

(C-313)

(C-317)

(D-17)

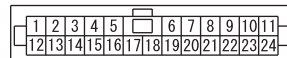
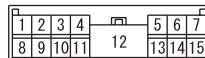
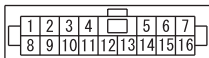
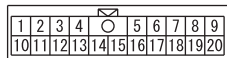
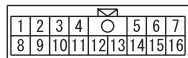

WIRE COLOR CODE

B : BLACK LG : LIGHT GREEN G : GREEN L : BLUE W : WHITE Y : YELLOW SB : SKY BLUE
BR : BROWN O : ORANGE GR : GRAY R : RED P : PINK V : VIOLET PU : PURPLE SI : SILVER

H8G09M10AB

STOPLIGHT

1

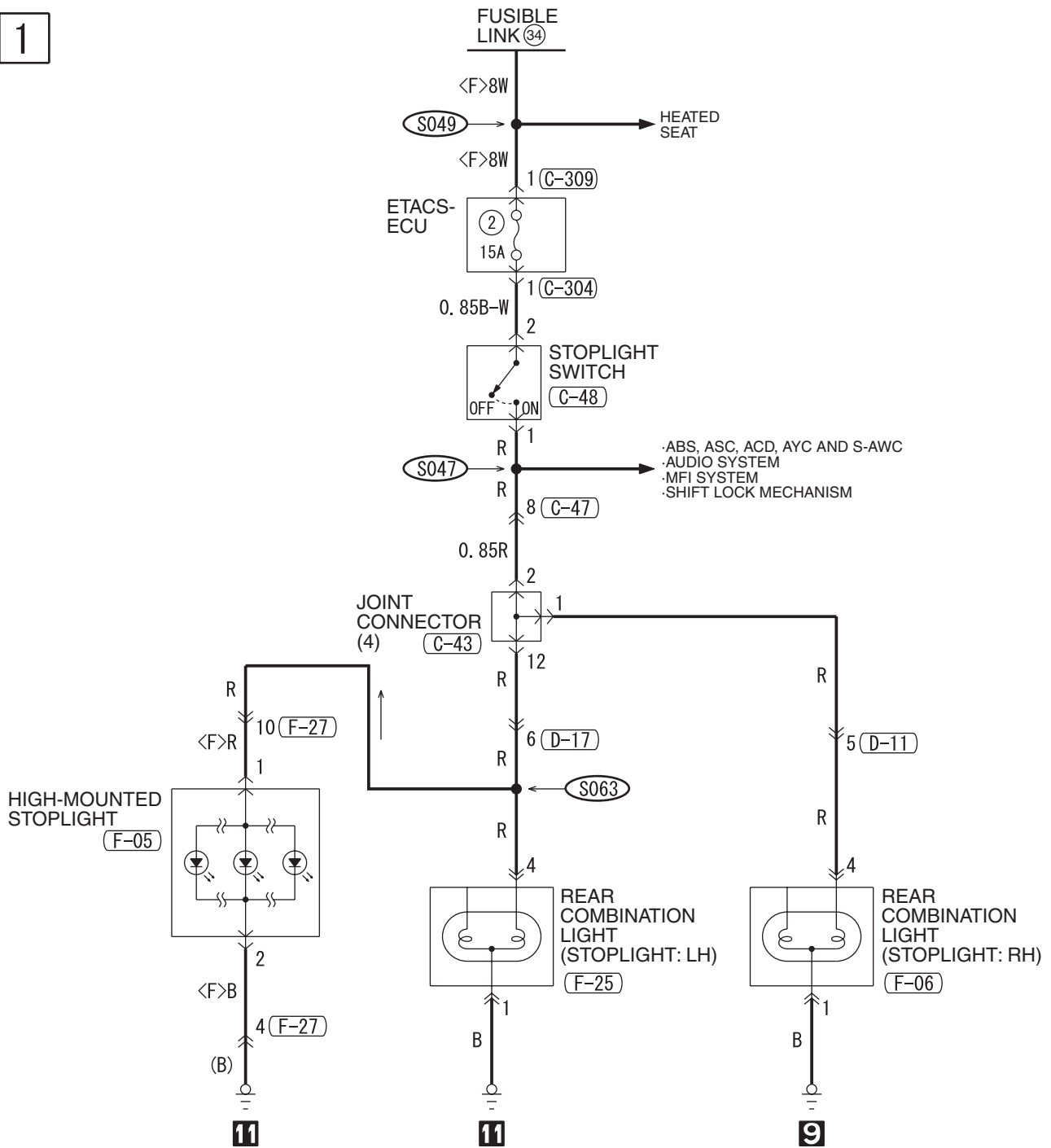

C-43

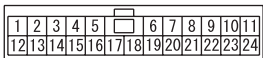

C-47

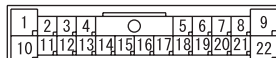

C-48



C-304

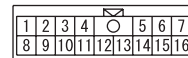

C-309



D-11

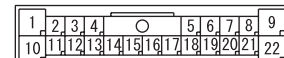

D-17

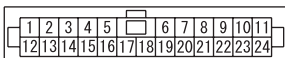

F-05



F-06



F-25



F-27

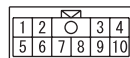

HORN

1

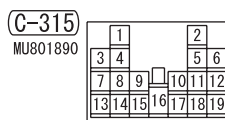
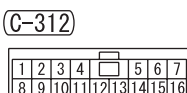
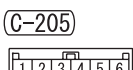
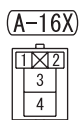
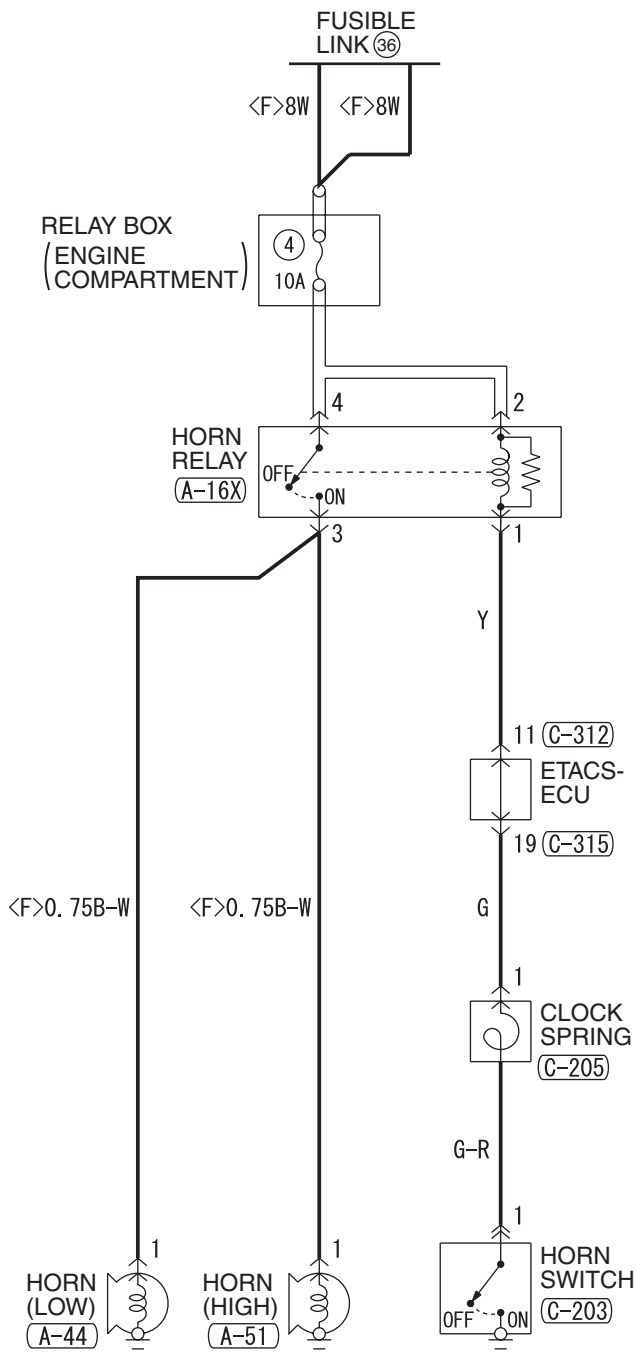

WIRE COLOR CODE

B: BLACK LG: LIGHT GREEN G: GREEN L: BLUE W: WHITE Y: YELLOW SB: SKY BLUE
BR: BROWN O: ORANGE GR: GRAY R: RED P: PINK V: VIOLET PU: PURPLE SI: SILVER

METER AND GAUGE <M/T>

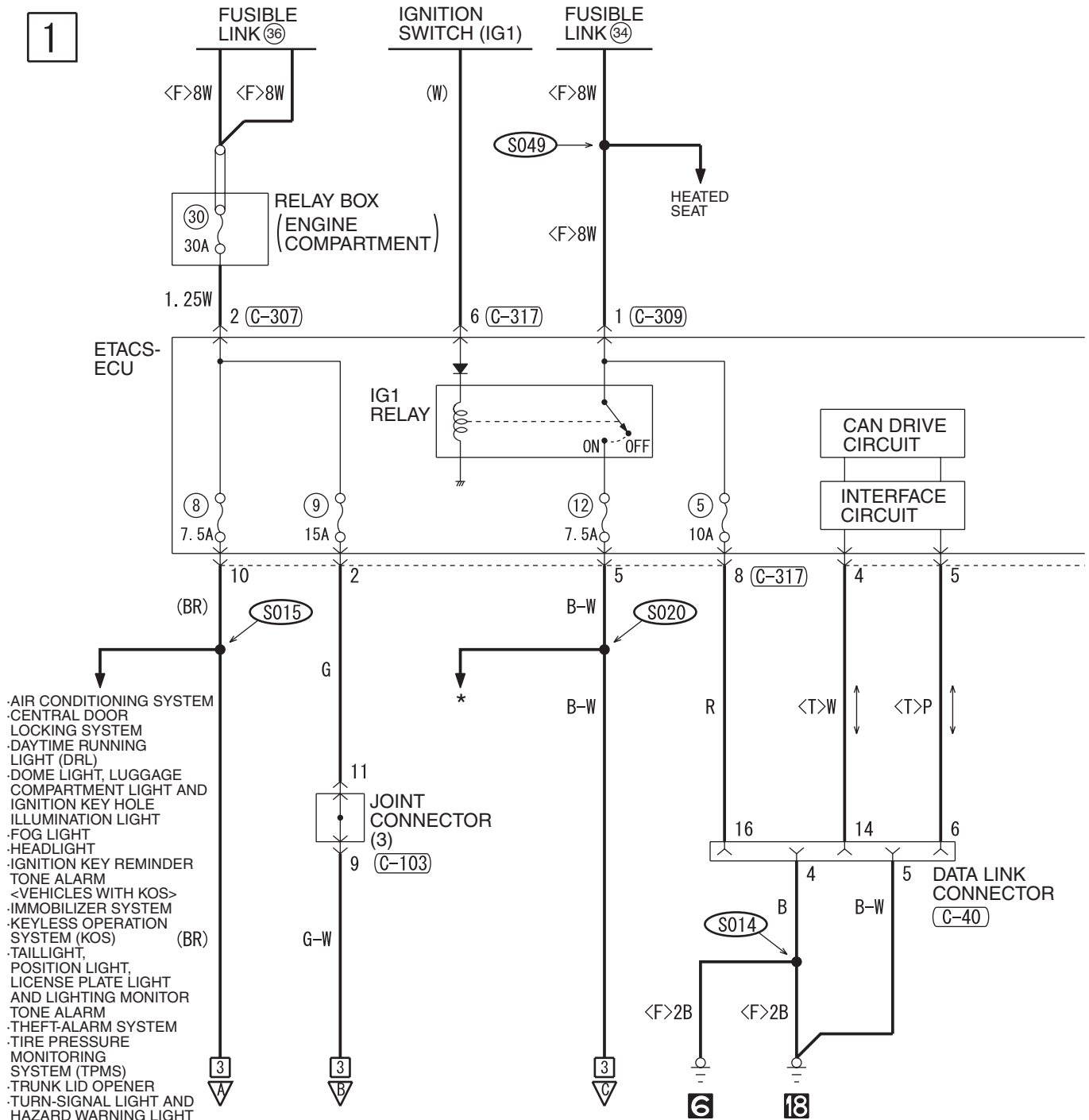

(A-05)

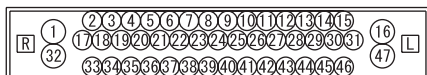

(A-49)



(B-10)

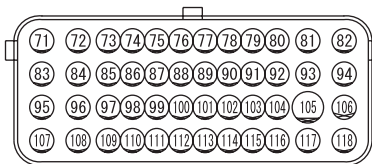

(C-40)



(C-301)

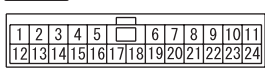

(C-307)



(C-309)



(C-312)

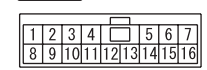

2

NOTE

- * : .ABS, ASC, ACD,
- .AYC AND S-AWC
- .AIR CONDITIONING SYSTEM
- .CENTRAL DOOR LOCKING SYSTEM
- .DAYTIME RUNNING LIGHT (DRL)
- .DOME LIGHT, LUGGAGE COMPARTMENT LIGHT AND IGNITION KEY HOLE ILLUMINATION LIGHT
- .FOG LIGHT
- .HEADLIGHT
- .HEATED SEAT
- .IGNITION KEY REMINDER TONE ALARM
- .IMMOBILIZER SYSTEM
- .KEYLESS OPERATING SYSTEM (KOS)
- .REAR WINDOW DEFOGGER
- .SEAT BELT WARNING TONE ALARM
- .SUNROOF
- .SUPPLEMENTAL RESTRAINT SYSTEM (SRS)
- .TAILLIGHT, POSITION LIGHT, LICENSE PLATE LIGHT AND LIGHTING MONITOR TONE ALARM
- .THEFT-ALARM SYSTEM
- .TIRE PRESSURE MONITORING SYSTEM (TPMS)
- .TRUNK LID OPENER
- .TURN-SIGNAL LIGHT AND HAZARD WARNING LIGHT
- .WINDSHIELD WIPER AND WASHER

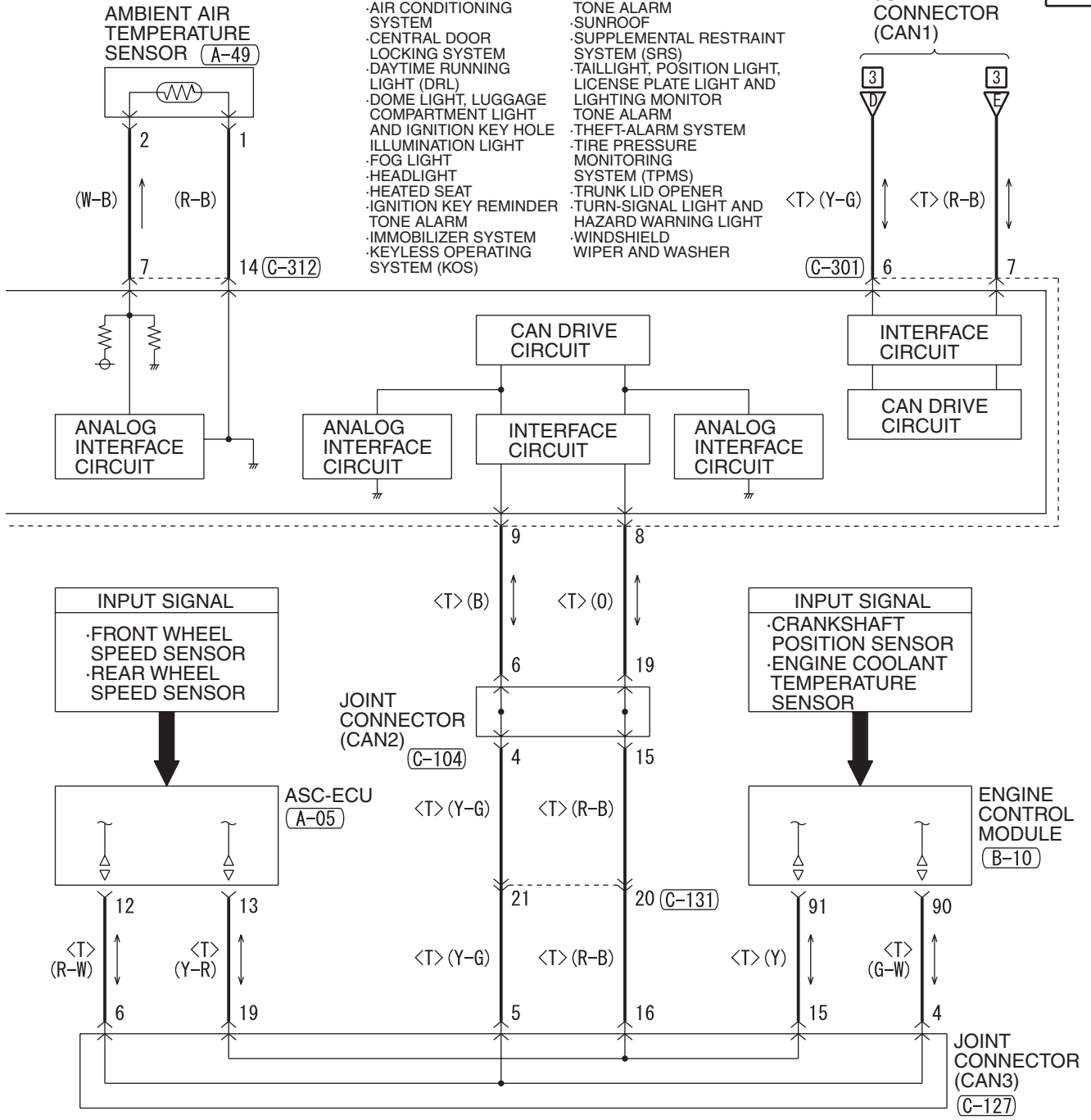

(C-103)

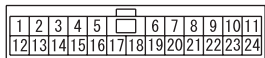

(C-104)

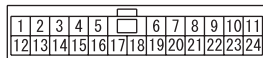

(C-127)

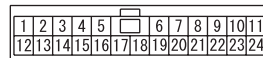

(C-131)

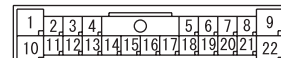

(C-317)

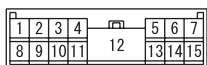

WIRE COLOR CODE

- B : BLACK LG : LIGHT GREEN G : GREEN L : BLUE W : WHITE
- Y : YELLOW SB : SKY BLUE BR : BROWN O : ORANGE GR : GRAY
- R : RED P : PINK V : VIOLET PU : PURPLE SI : SILVER

METER AND GAUGE <M/T> (CONTINUED)

3

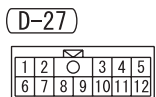
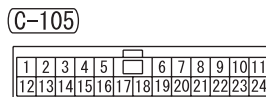
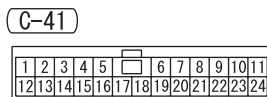
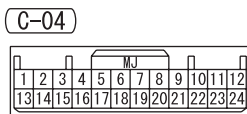
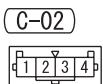
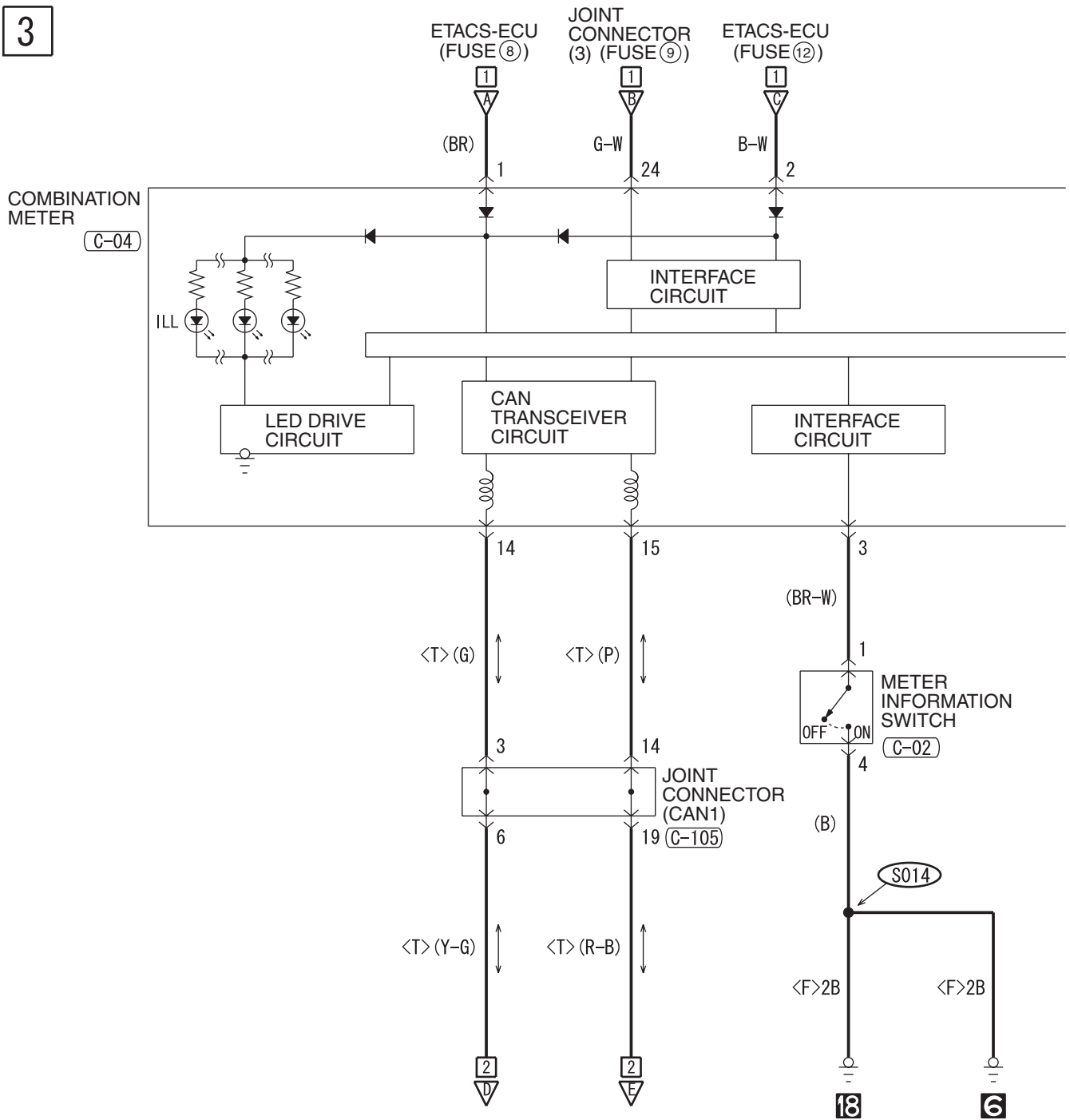

4

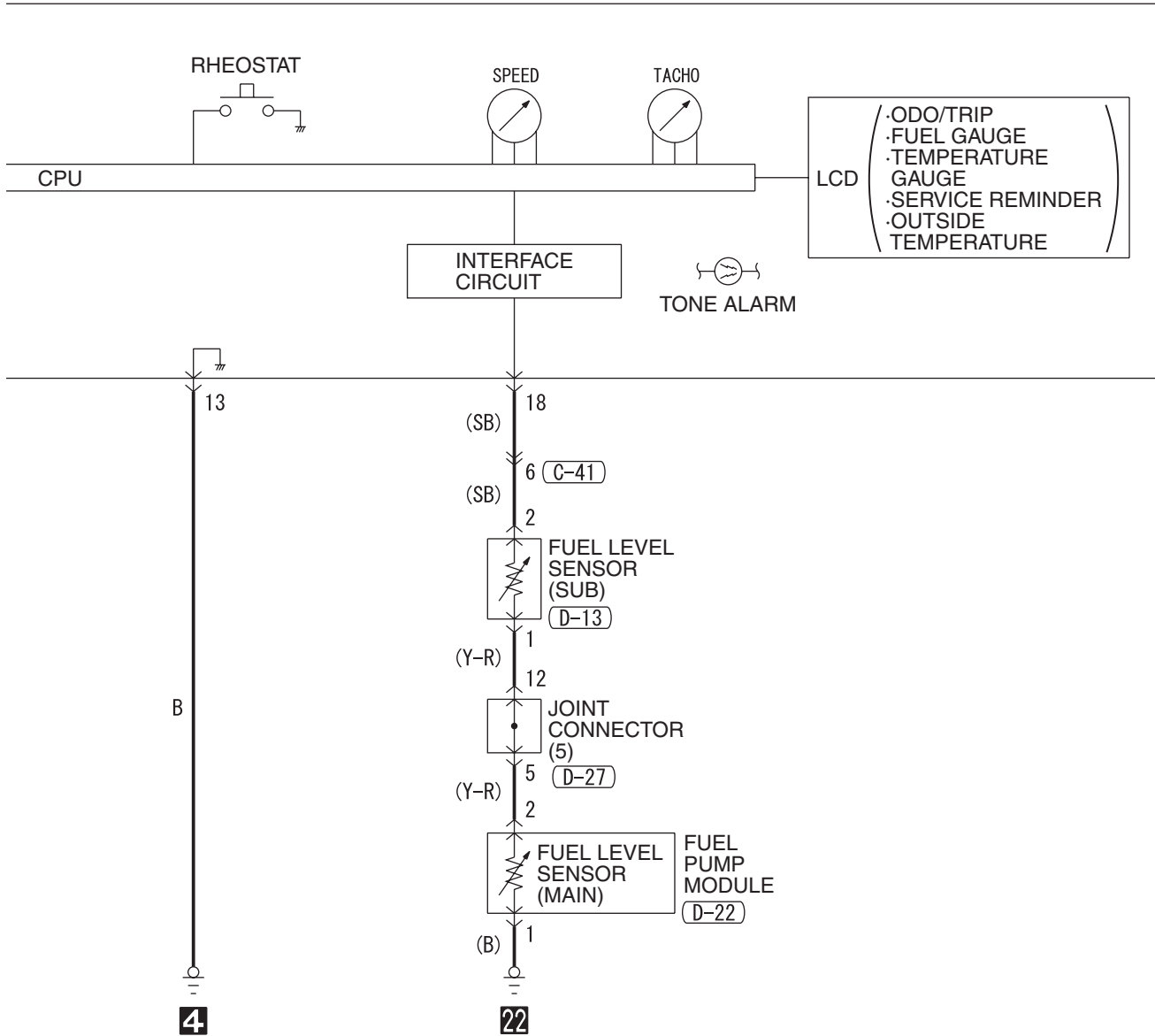

WIRE COLOR CODE

B: BLACK LG: LIGHT GREEN G: GREEN L: BLUE W: WHITE Y: YELLOW SB: SKY BLUE
BR: BROWN O: ORANGE GR: GRAY R: RED P: PINK V: VIOLET PU: PURPLE SI: SILVER

H8G10M04BB

TSB Revision

METER AND GAUGE <TC-SST>

M1901003503733

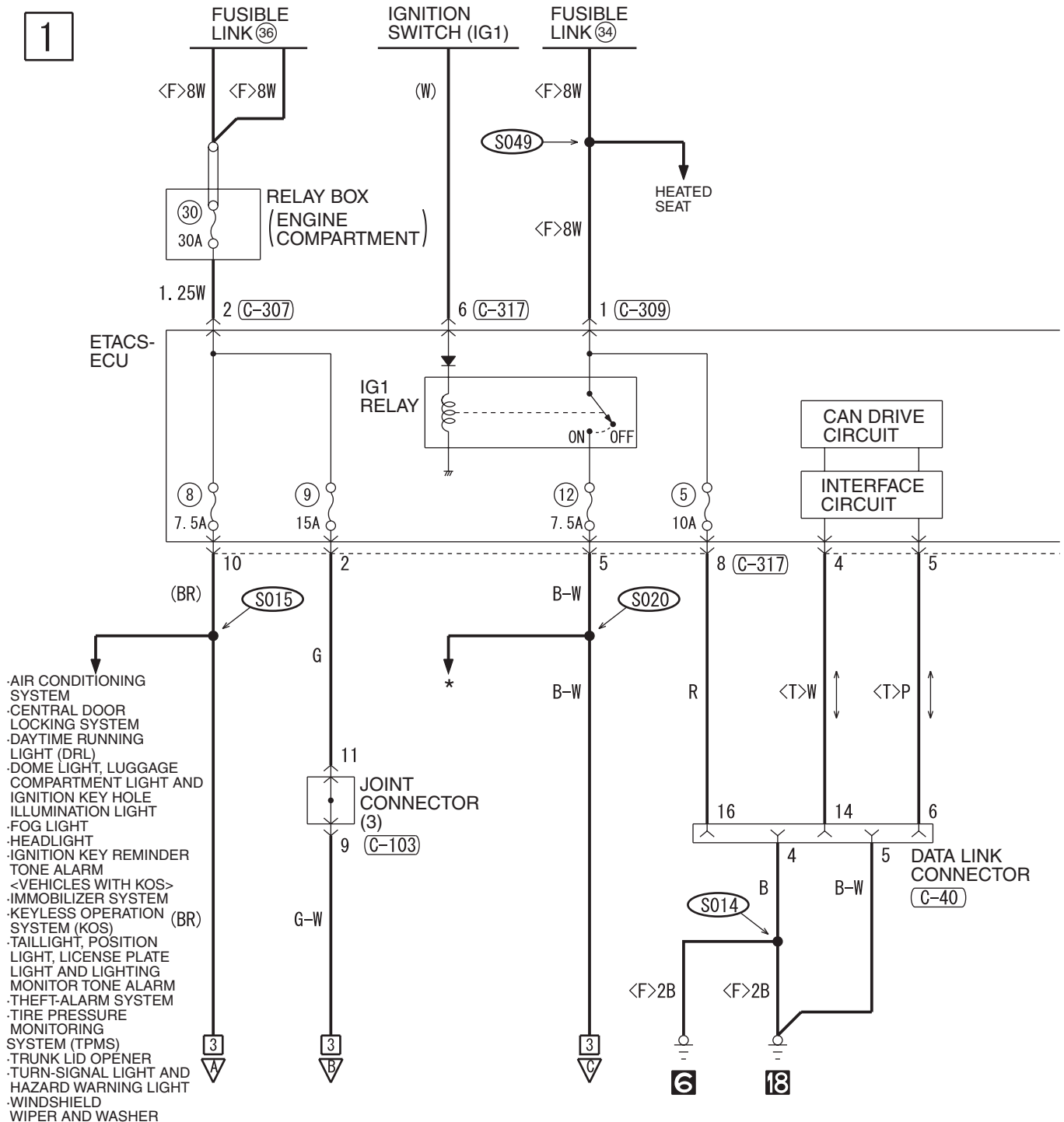

- AIR CONDITIONING SYSTEM
- CENTRAL DOOR LOCKING SYSTEM
- DAYTIME RUNNING LIGHT (DRL)
- DOME LIGHT, LUGGAGE COMPARTMENT LIGHT AND IGNITION KEY HOLE ILLUMINATION LIGHT
- FOG LIGHT
- HEADLIGHT
- IGNITION KEY REMINDER TONE ALARM
- <VEHICLES WITH KOS> IMMOBILIZER SYSTEM
- KEYLESS OPERATION SYSTEM (KOS)
- TAILLIGHT, POSITION LIGHT, LICENSE PLATE LIGHT AND LIGHTING MONITOR TONE ALARM
- THEFT-ALARM SYSTEM
- TIRE PRESSURE MONITORING SYSTEM (TPMS)
- TRUNK LID OPENER
- TURN-SIGNAL LIGHT AND HAZARD WARNING LIGHT
- WINDSHIELD WIPER AND WASHER

(A-05)

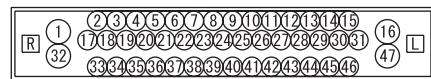

(A-13)

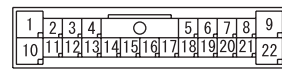

(A-14)

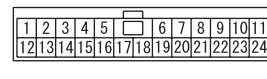

(A-49)



(C-127)

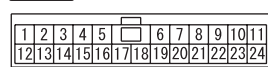

(C-131)

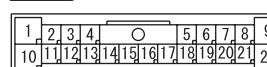

(C-301)

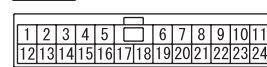

(C-307)



(C-309)



H8G10M05AA

2

NOTE

- * : ·ABS, ASC, ACD, AYC AND S-AWC
- AIR CONDITIONING SYSTEM
- CENTRAL DOOR LOCKING SYSTEM
- DAYTIME RUNNING LIGHT (DRL)
- DOME LIGHT, LUGGAGE COMPARTMENT LIGHT AND IGNITION KEY HOLE ILLUMINATION LIGHT
- FOG LIGHT
- HEADLIGHT
- HEATED SEAT
- IGNITION KEY REMINDER TONE ALARM
- IMMOBILIZER SYSTEM
- KEYLESS OPERATING SYSTEM (KOS)
- REAR WINDOW DEFOGGER
- SEAT BELT WARNING TONE ALARM
- SHIFT LOCK MECHANISM
- SUNROOF
- SUPPLEMENTAL RESTRAINT SYSTEM (SRS)
- TAILLIGHT, POSITION LIGHT, LICENSE PLATE LIGHT AND LIGHTING MONITOR TONE ALARM
- TC-SST
- THEFT-ALARM SYSTEM
- TIRE PRESSURE MONITORING SYSTEM (TPMS)
- TRUNK LID OPENER
- TURN-SIGNAL LIGHT AND HAZARD WARNING LIGHT
- WINDSHIELD WIPER AND WASHER

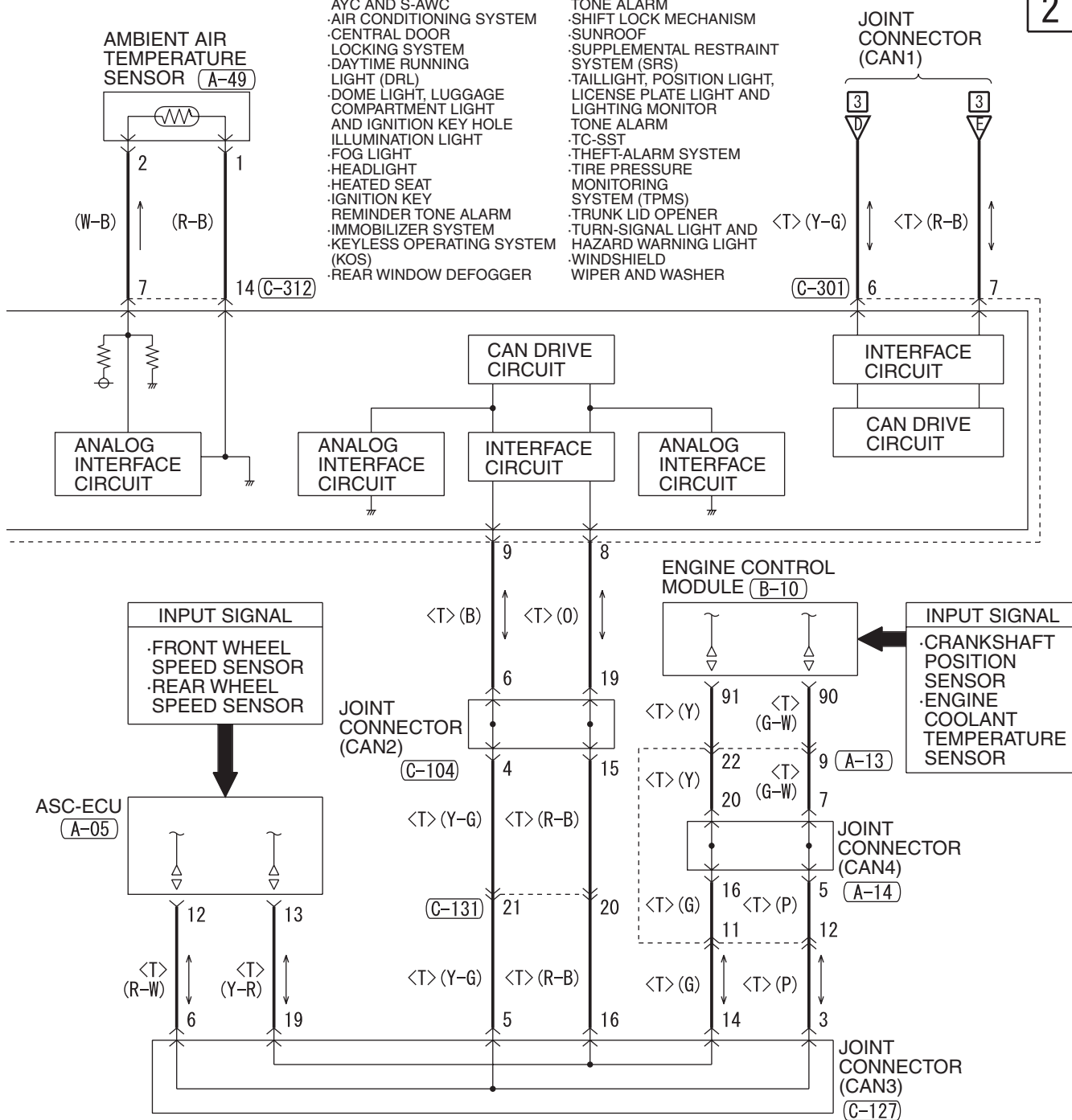

(B-10)

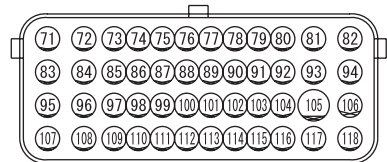

(C-40) FRONT SIDE

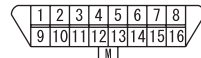

(C-103)

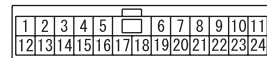

(C-104)

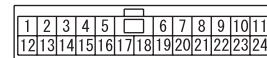

(C-312)

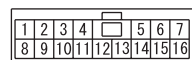

(C-317)

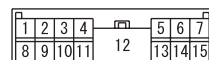

METER AND GAUGE <TC-SST> (CONTINUED)

3

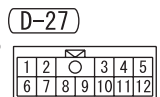
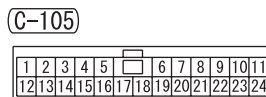
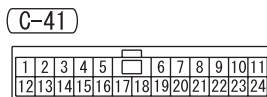
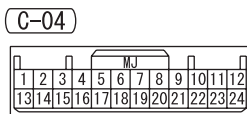
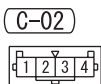
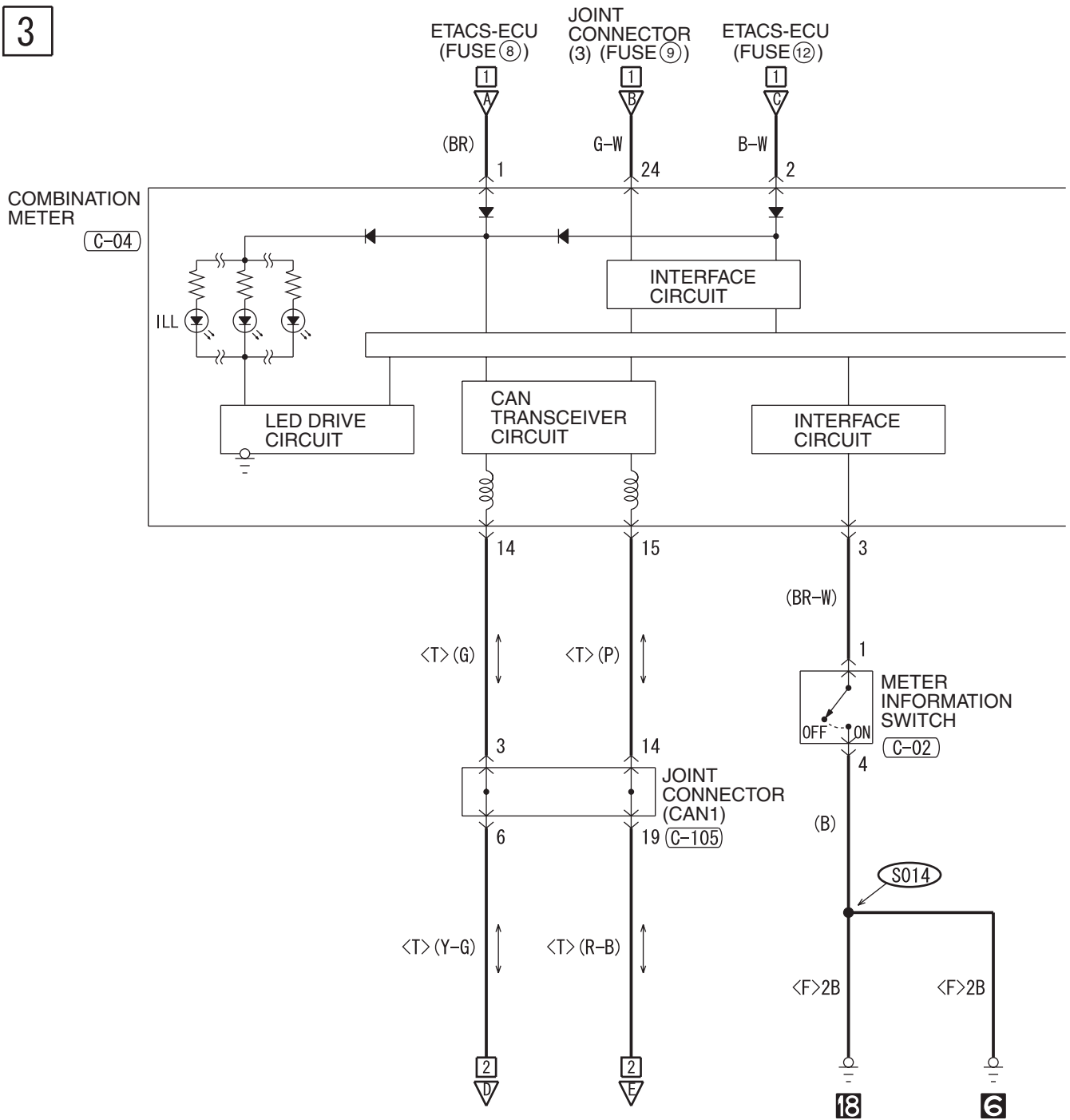

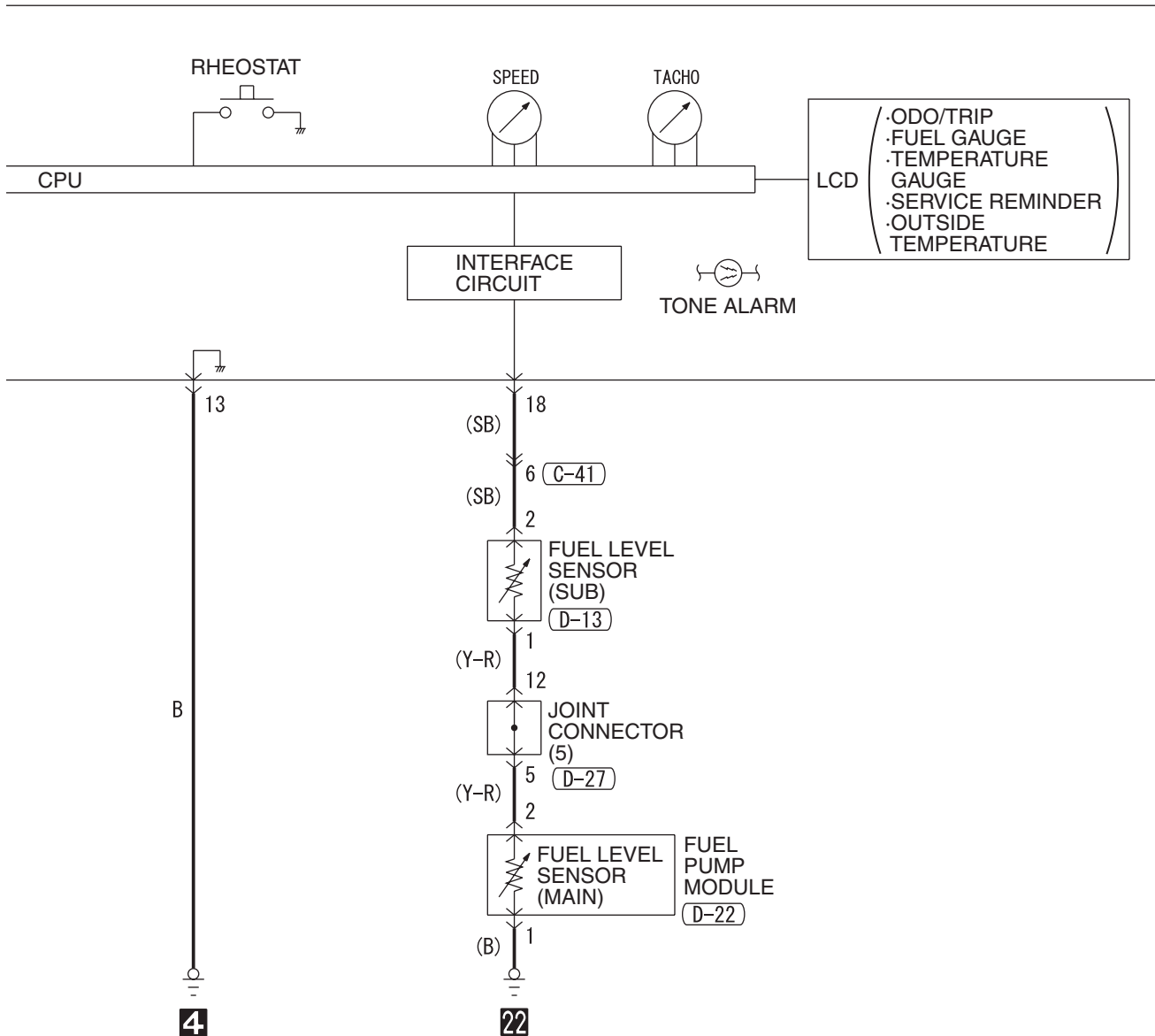

WIRE COLOR CODE

B: BLACK LG: LIGHT GREEN G: GREEN L: BLUE W: WHITE Y: YELLOW SB: SKY BLUE
BR: BROWN O: ORANGE GR: GRAY R: RED P: PINK V: VIOLET PU: PURPLE SI: SILVER

H8G10M05BB

BRAKE WARNING LIGHT, FUEL WARNING LIGHT AND OIL PRESSURE WARNING LIGHT <M/T>

M1901020000130

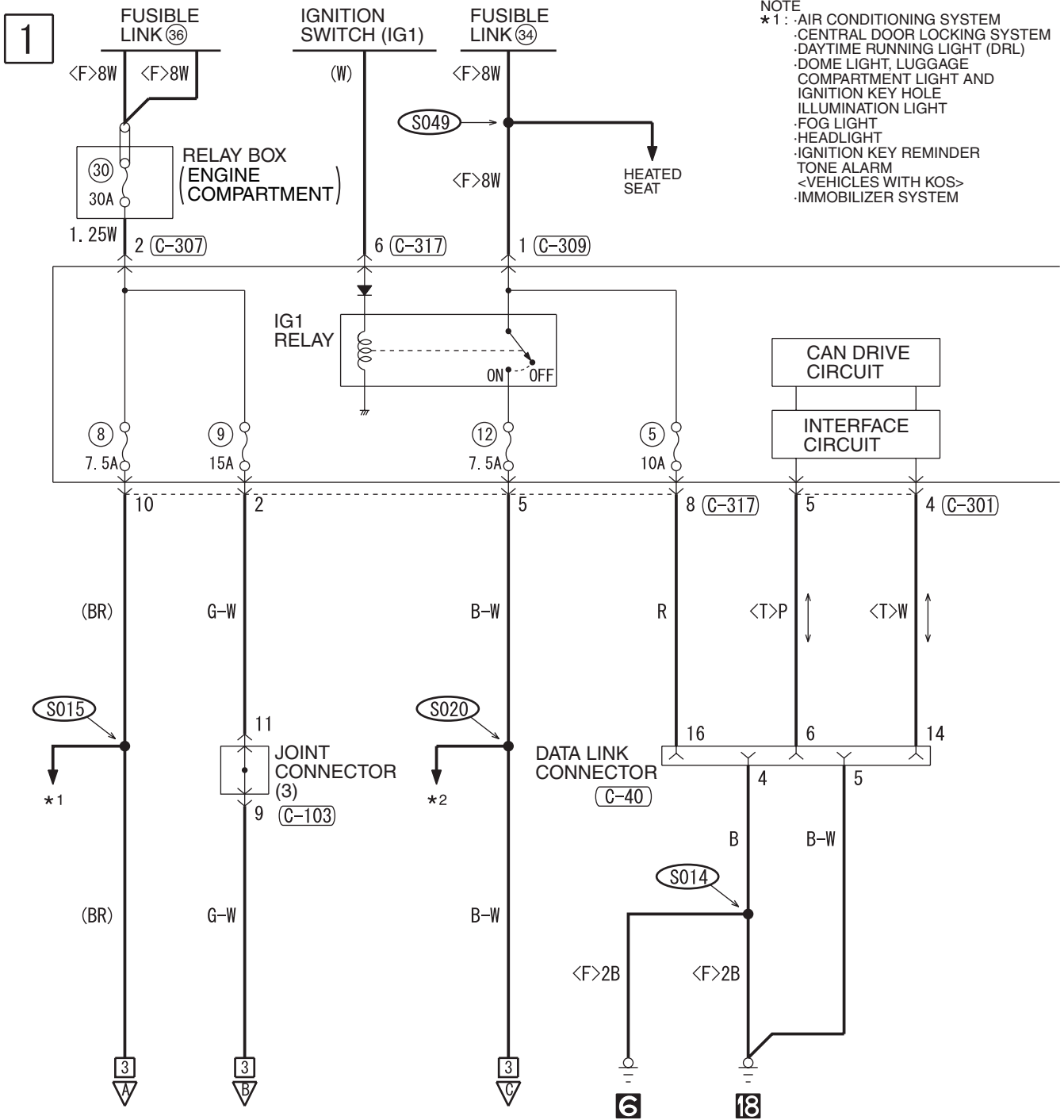

NOTE
*1 : -AIR CONDITIONING SYSTEM
-CENTRAL DOOR LOCKING SYSTEM
-DAYTIME RUNNING LIGHT (DRL)
-DOVE LIGHT, LUGGAGE COMPARTMENT LIGHT AND IGNITION KEY HOLE ILLUMINATION LIGHT
-FOG LIGHT
-HEADLIGHT
-IGNITION KEY REMINDER TONE ALARM
-<VEHICLES WITH KOS>
-IMMOBILIZER SYSTEM

(A-09)

(B-09)

(B-10)

(B-15)

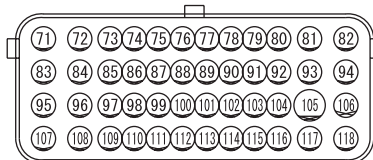
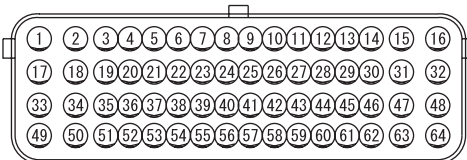

2

- KEYLESS OPERATION SYSTEM (KOS)
- TAILLIGHT, POSITION LIGHT, LICENSE PLATE LIGHT AND LIGHTING MONITOR TONE ALARM
- THEFT-ALARM SYSTEM
- TIRE PRESSURE MONITORING SYSTEM (TPMS)
- TRUNK LID OPENER
- TURN-SIGNAL LIGHT AND HAZARD WARNING LIGHT
- WINDSHIELD WIPER AND WASHER

- *2 : -ABS, ASC, ACD, AYC AND S-AWC
- AIR CONDITIONING SYSTEM
 - CENTRAL DOOR LOCKING SYSTEM
 - DAYTIME RUNNING LIGHT (DRL)
 - DOME LIGHT, LUGGAGE COMPARTMENT LIGHT AND IGNITION KEY HOLE ILLUMINATION LIGHT
 - FOG LIGHT
 - HEADLIGHT
 - HEATED SEAT
 - IGNITION KEY REMINDER TONE ALARM
 - IMMOBILIZER SYSTEM
 - KEYLESS OPERATING SYSTEM (KOS)

- REAR WINDOW DEFOGGER
- SEAT BELT WARNING TONE ALARM
- SUNROOF
- SUPPLEMENTAL RESTRAINT SYSTEM (SRS)
- TAILLIGHT, POSITION LIGHT, LICENSE PLATE LIGHT AND LIGHTING MONITOR TONE ALARM
- THEFT-ALARM SYSTEM
- TIRE PRESSURE MONITORING SYSTEM (TPMS)
- TRUNK LID OPENER
- TURN-SIGNAL LIGHT AND HAZARD WARNING LIGHT
- WINDSHIELD WIPER AND WASHER

ETACS-ECU

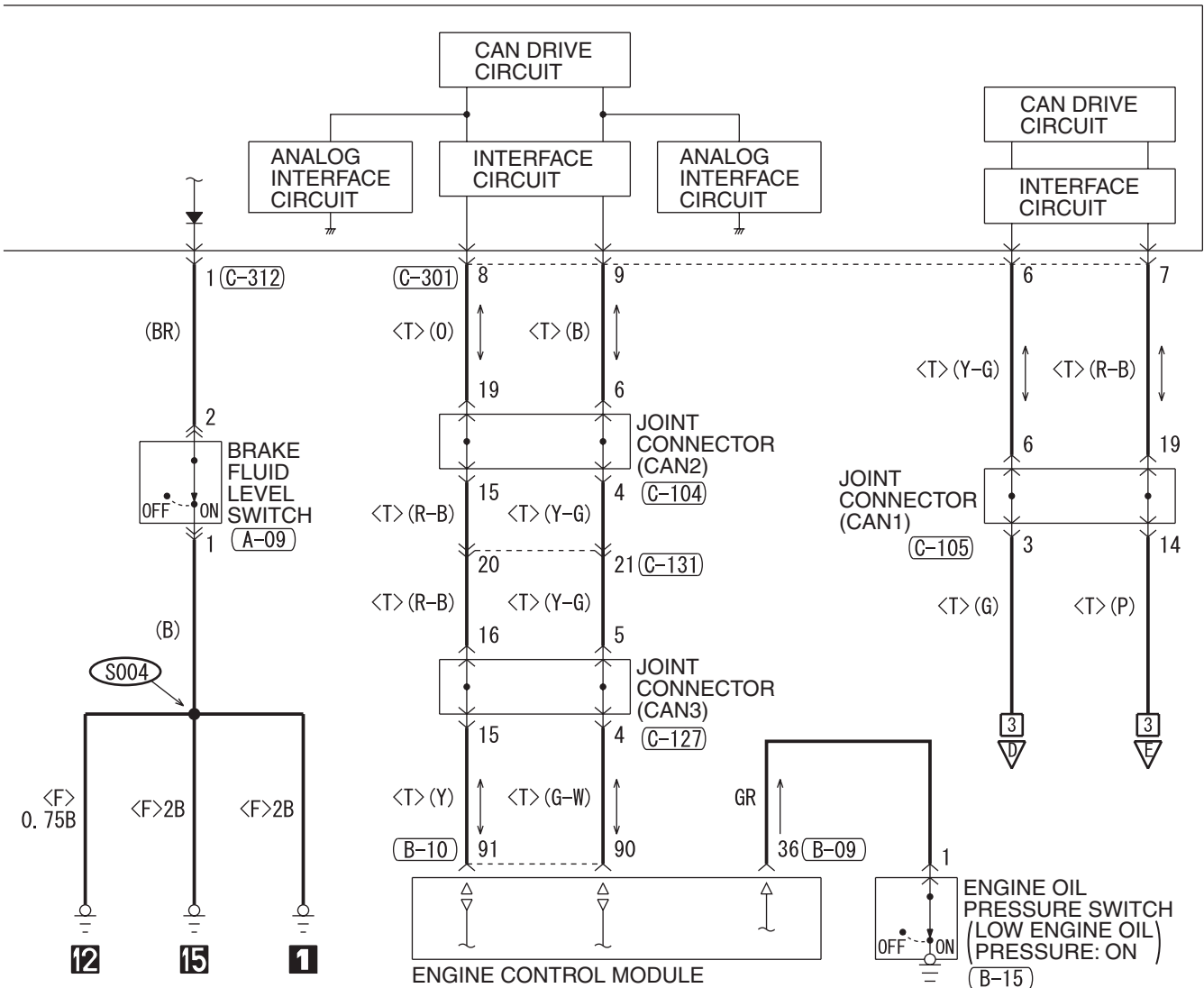

(C-40) FRONT SIDE

(C-103)

(C-104)

(C-105)

(C-127)

(C-131)

(C-301)

(C-307)

(C-309)

(C-312)

(C-317)

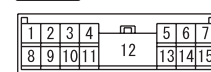
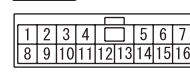
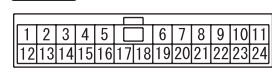
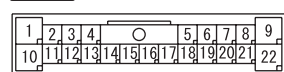

H8G10M06AB

BRAKE WARNING LIGHT, FUEL WARNING LIGHT AND OIL PRESSURE WARNING LIGHT <M/T>
(CONTINUED)

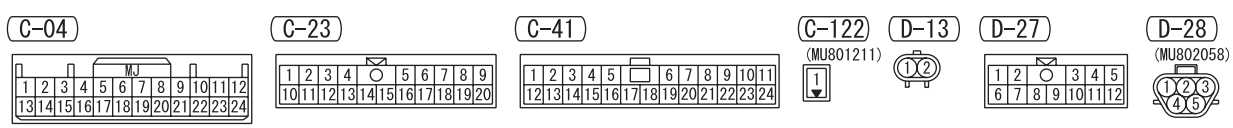
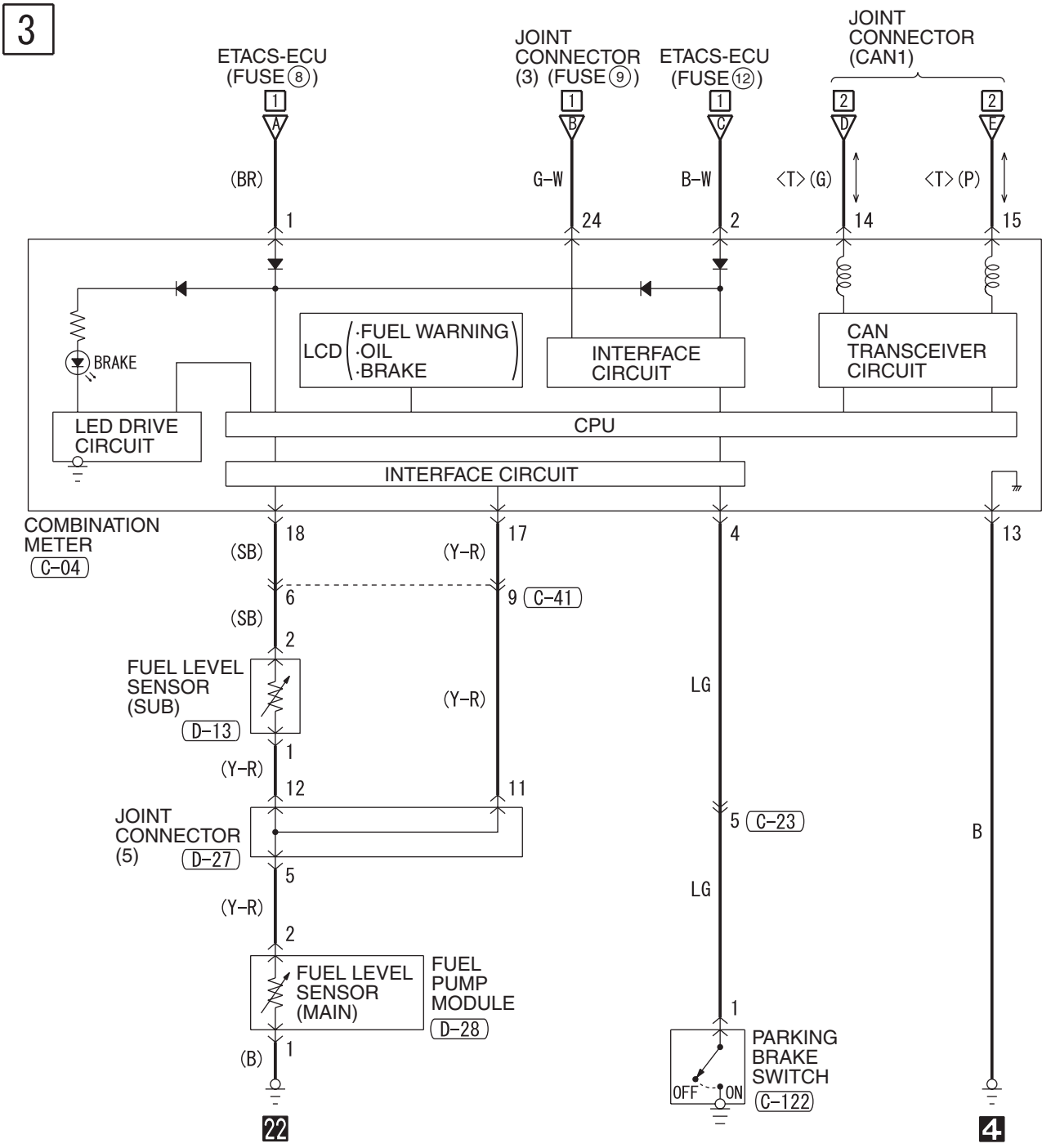

WIRE COLOR CODE
 B: BLACK LG: LIGHT GREEN G: GREEN L: BLUE W: WHITE Y: YELLOW SB: SKY BLUE
 BR: BROWN O: ORANGE GR: GRAY R: RED P: PINK V: VIOLET PU: PURPLE SI: SILVER

NOTES

BRAKE WARNING LIGHT, FUEL WARNING LIGHT AND OIL PRESSURE WARNING LIGHT <TC-SST>

M1901020000141

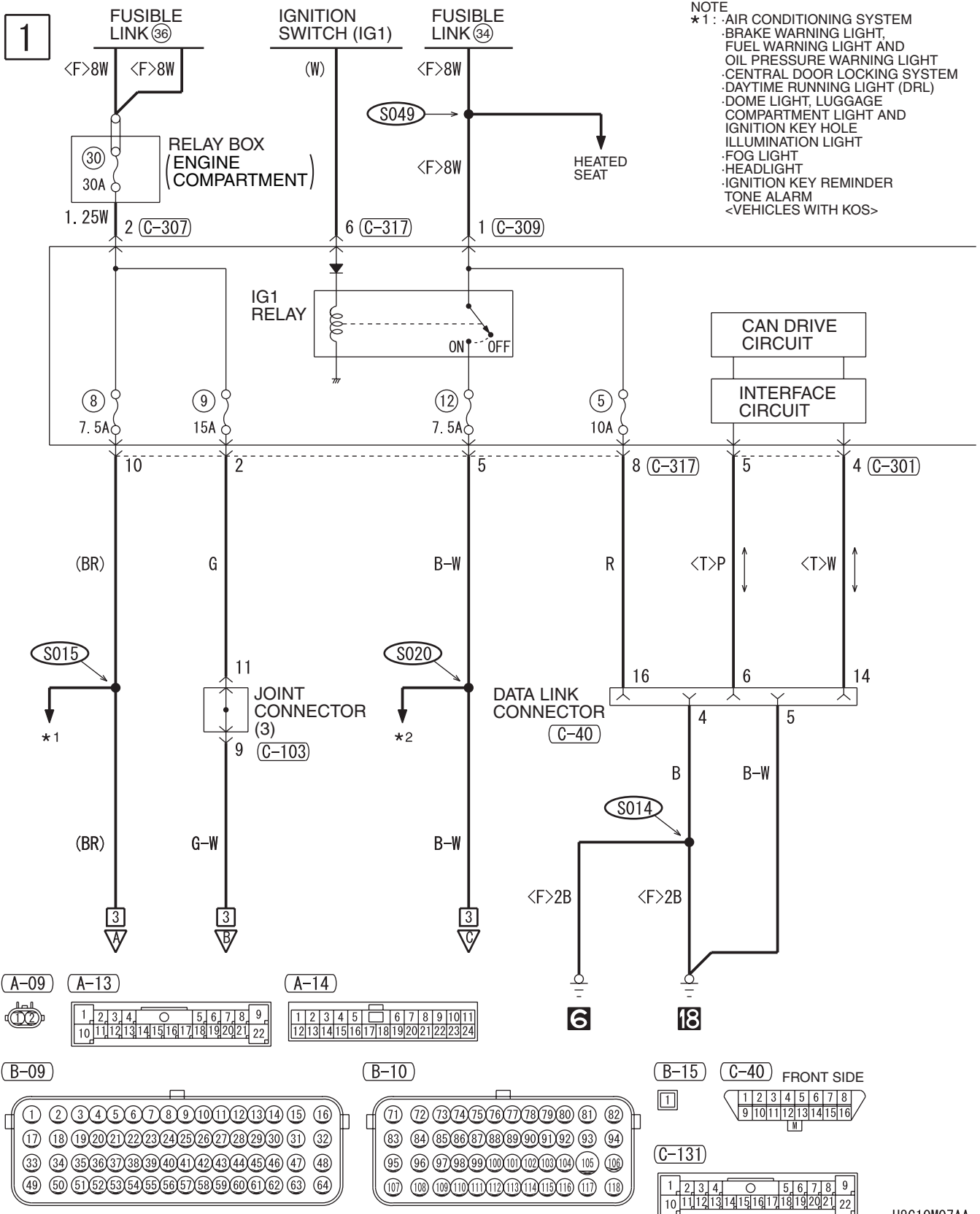

H8G10M07AA

2

- IMMOBILIZER SYSTEM
- KEYLESS OPERATION SYSTEM (KOS)
- TAILLIGHT, POSITION LIGHT, LICENSE PLATE LIGHT AND LIGHTING MONITOR TONE ALARM
- THEFT-ALARM SYSTEM
- TIRE PRESSURE MONITORING SYSTEM (TPMS)
- TRUNK LID OPENER
- TURN-SIGNAL LIGHT AND HAZARD WARNING LIGHT
- WINDSHIELD WIPER AND WASHER

- *2 : ·ABS, ASC, ACD, AYC AND S-AWC
- AIR CONDITIONING SYSTEM
 - CENTRAL DOOR LOCKING SYSTEM
 - DAYTIME RUNNING LIGHT (DRL)
 - DOME LIGHT, LUGGAGE COMPARTMENT LIGHT AND IGNITION KEY HOLE ILLUMINATION LIGHT
 - FOG LIGHT
 - HEADLIGHT
 - HEATED SEAT
 - IGNITION KEY REMINDER TONE ALARM
 - IMMOBILIZER SYSTEM
 - KEYLESS OPERATING SYSTEM (KOS)

- REAR WINDOW DEFOGGER
- SEAT BELT WARNING TONE ALARM
- SHIFT LOCK MECHANISM
- SUNROOF
- SUPPLEMENTAL RESTRAINT SYSTEM (SRS)
- TAILLIGHT, POSITION LIGHT, LICENSE PLATE LIGHT AND LIGHTING MONITOR TONE ALARM
- TC-SST
- THEFT-ALARM SYSTEM
- TIRE PRESSURE MONITORING SYSTEM (TPMS)
- TRUNK LID OPENER
- TURN-SIGNAL LIGHT AND HAZARD WARNING LIGHT
- WINDSHIELD WIPER AND WASHER

ETACS-ECU

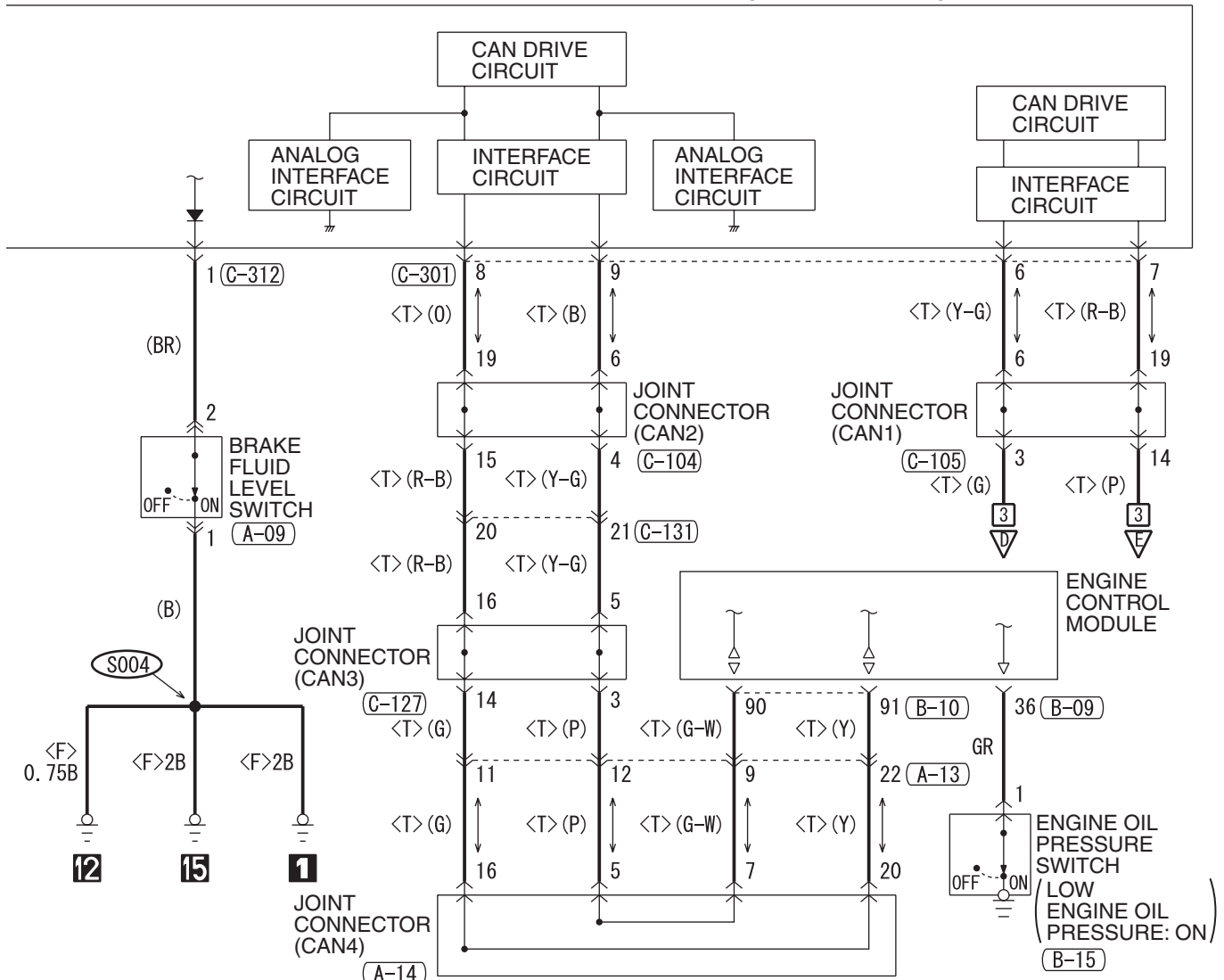

(C-103)

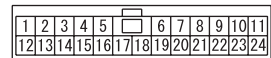

(C-104)

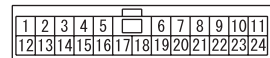

(C-105)

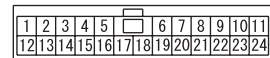

(C-127)

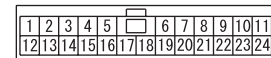

(C-301)

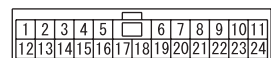

(C-307)



(C-309)



(C-312)

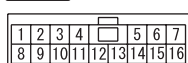

(C-317)

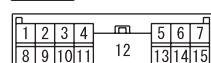

BRAKE WARNING LIGHT, FUEL WARNING LIGHT AND OIL PRESSURE WARNING LIGHT <TC-SST>
(CONTINUED)

3

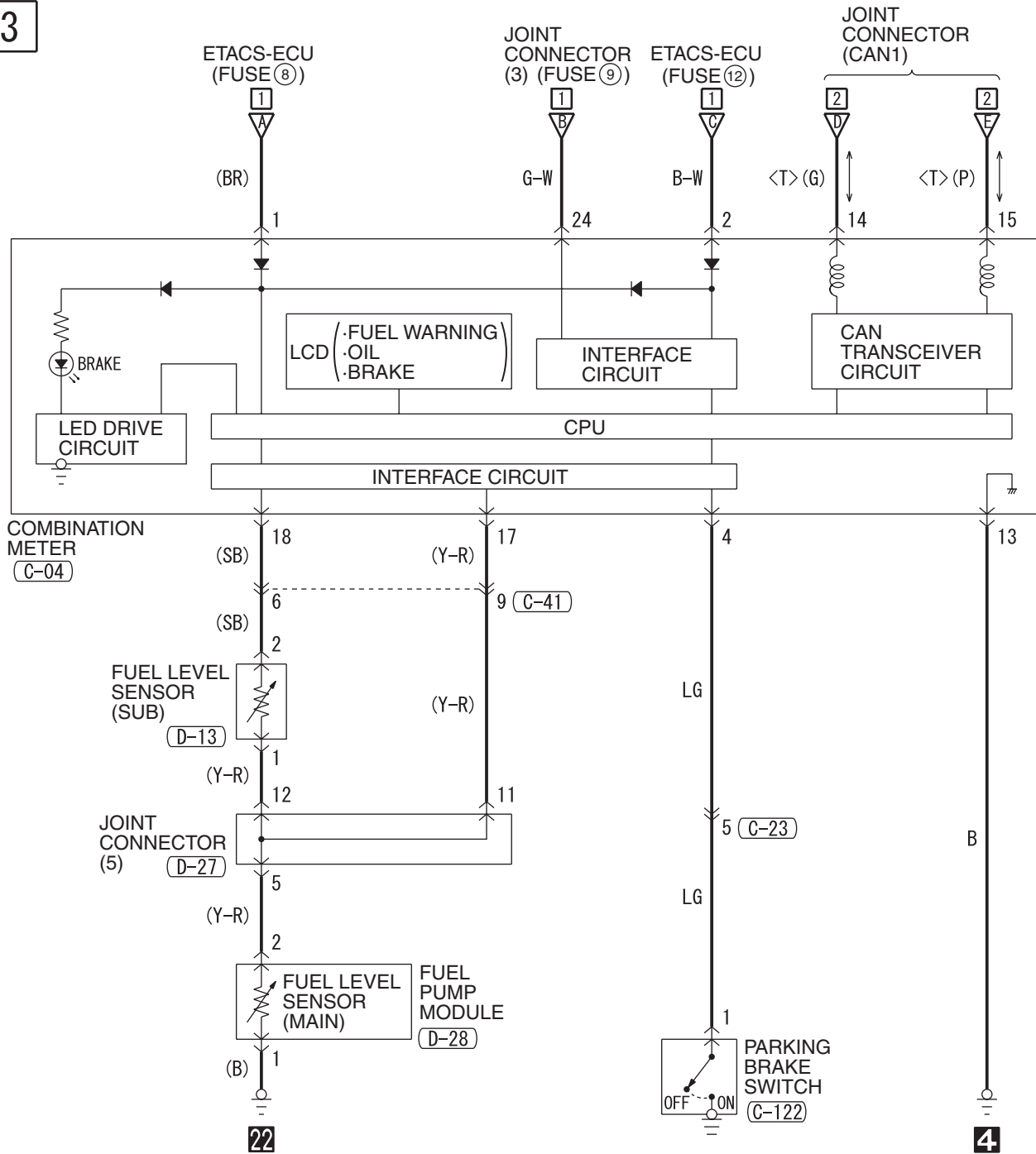

C-04

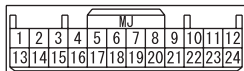

C-23

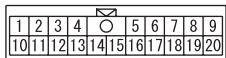

C-41

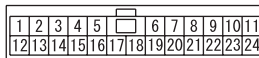

C-122



D-13



D-27

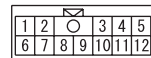

D-28



WIRE COLOR CODE
 B: BLACK LG: LIGHT GREEN G: GREEN L: BLUE W: WHITE Y: YELLOW SB: SKY BLUE
 BR: BROWN O: ORANGE GR: GRAY R: RED P: PINK V: VIOLET PU: PURPLE SI: SILVER

NOTES

POWER WINDOWS

M1901004603380

1

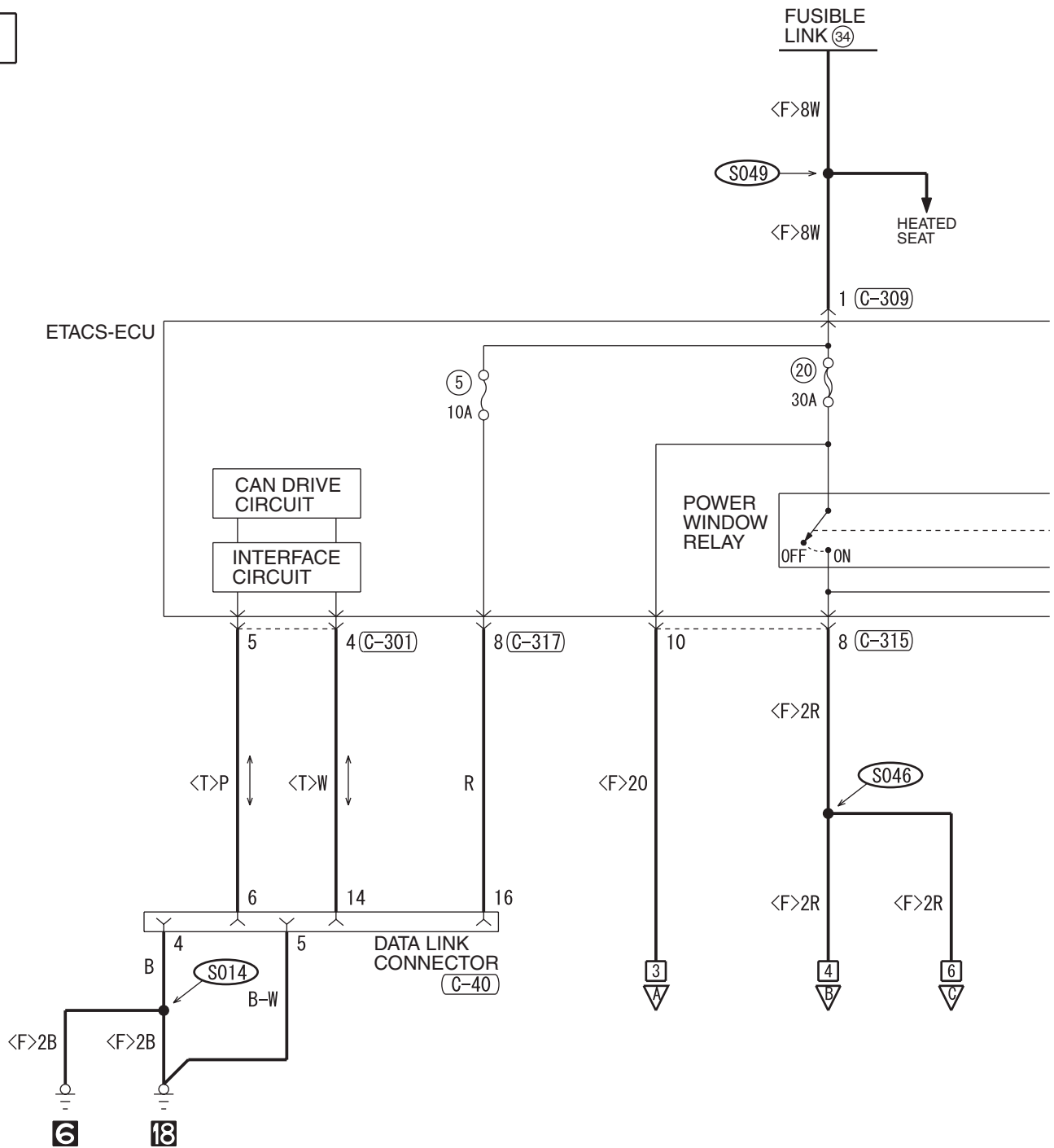

(C-40) FRONT SIDE

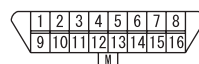

(C-102)

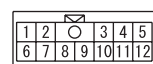

(C-301)

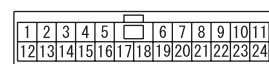

(C-307) MU801325



(C-309)



(C-311)

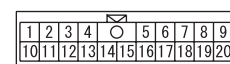

(C-313)

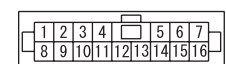

H8G11M08AA

2

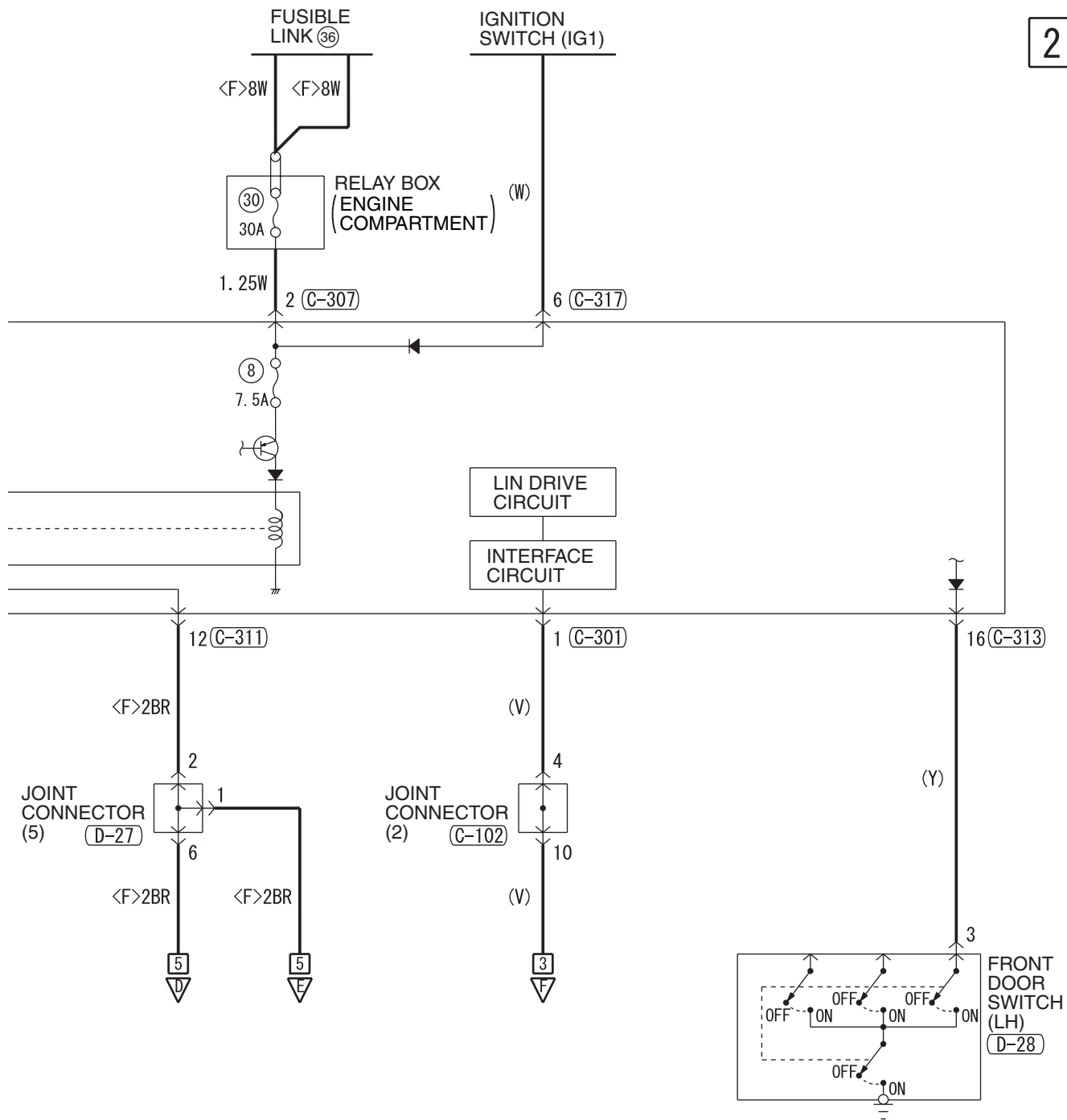

WIRE COLOR CODE

B: BLACK LG: LIGHT GREEN G: GREEN L: BLUE W: WHITE Y: YELLOW SB: SKY BLUE
BR: BROWN O: ORANGE GR: GRAY R: RED P: PINK V: VIOLET PU: PURPLE SI: SILVER

H8G11M08AB

POWER WINDOWS (CONTINUED)

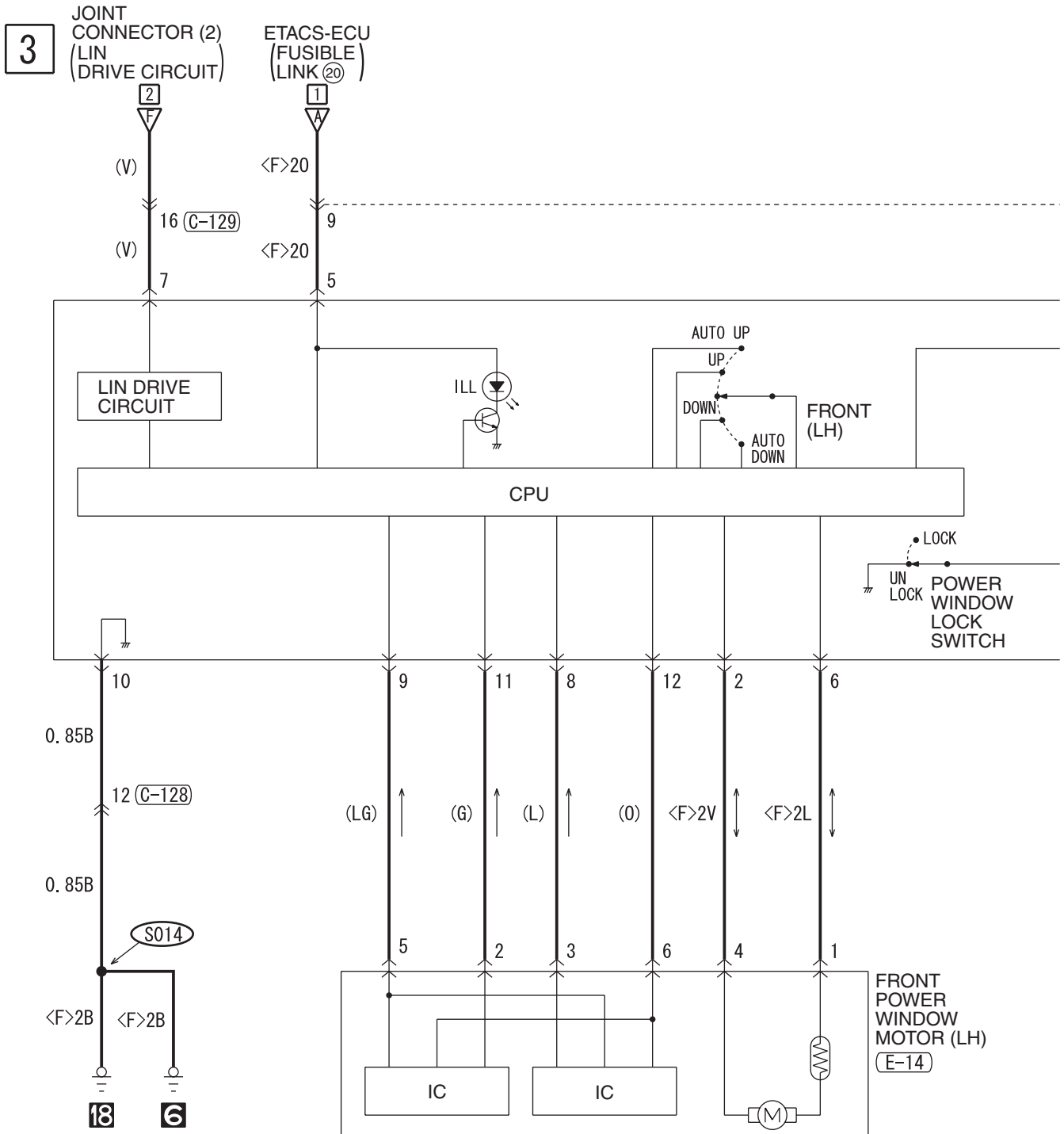

(C-128)

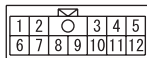

(C-129)

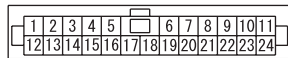

(E-14)



(E-15)

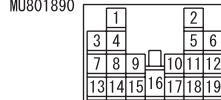

4

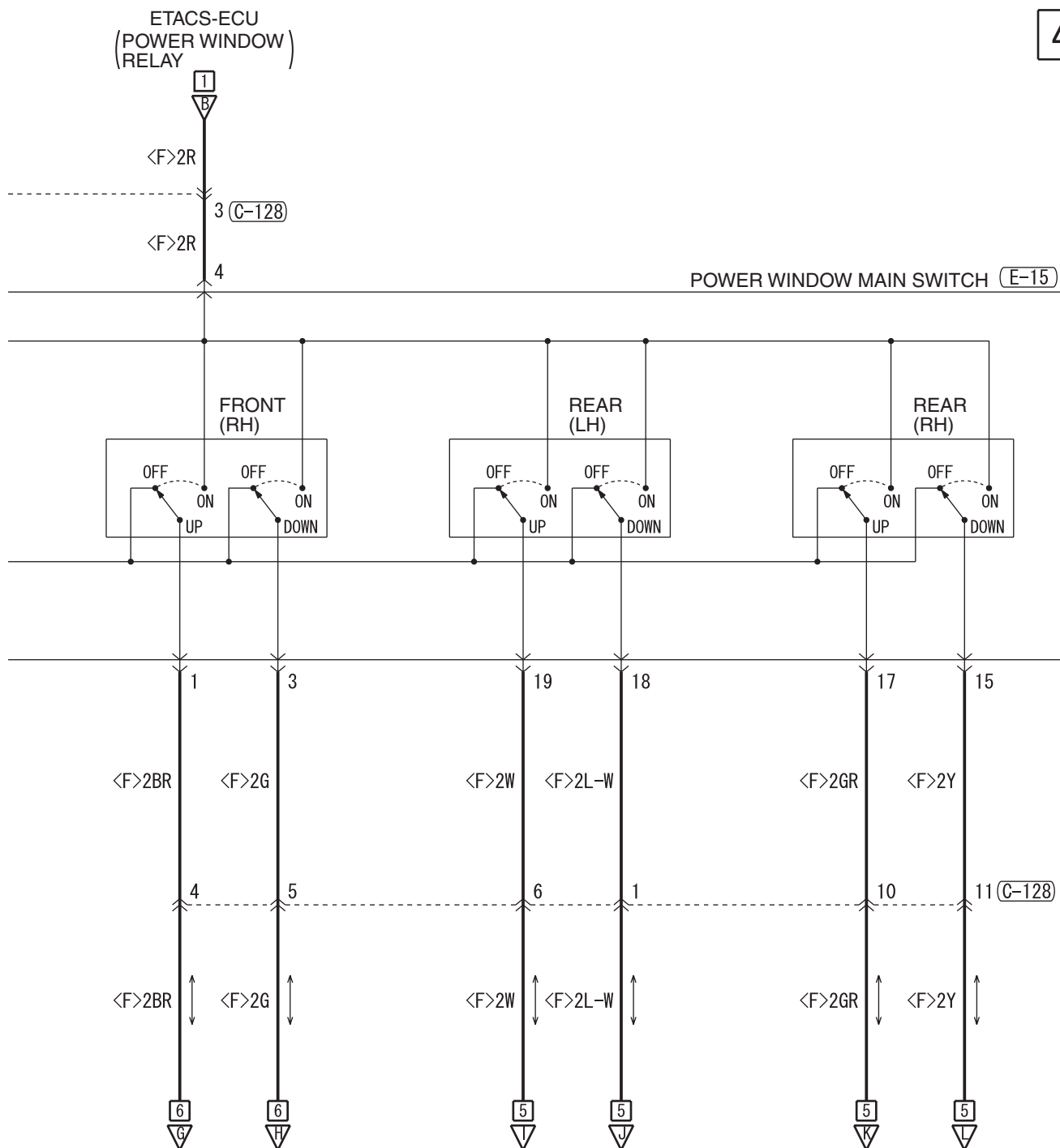

WIRE COLOR CODE

B: BLACK LG: LIGHT GREEN G: GREEN L: BLUE W: WHITE Y: YELLOW SB: SKY BLUE
BR: BROWN O: ORANGE GR: GRAY R: RED P: PINK V: VIOLET PU: PURPLE SI: SILVER

H8G11M08BB

TSB Revision

POWER WINDOWS (CONTINUED)

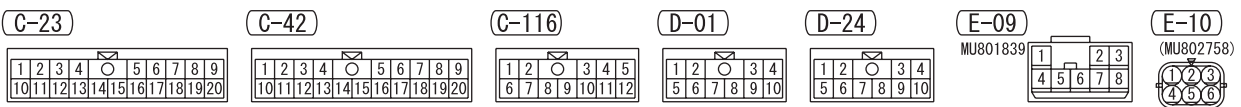
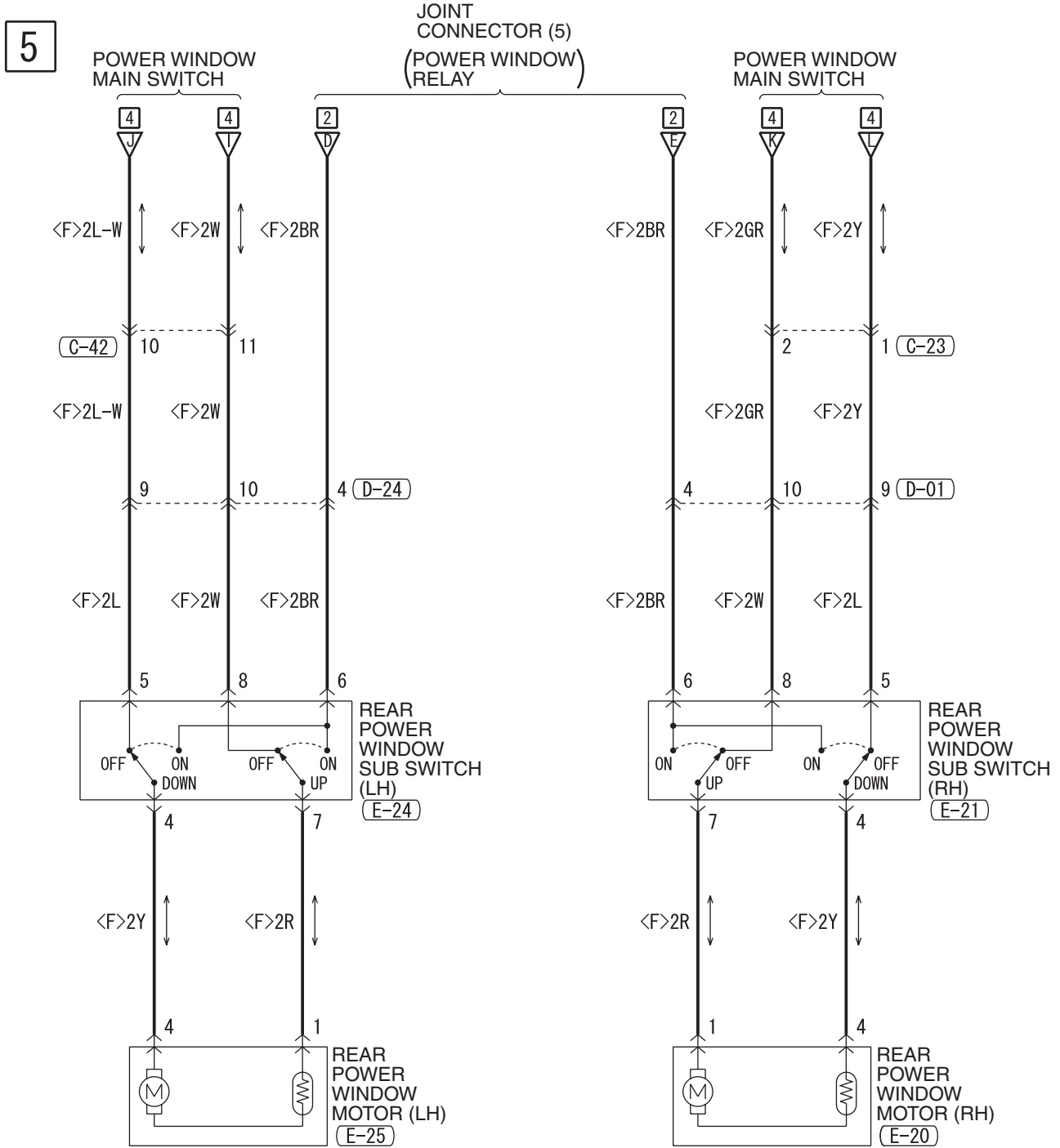

6

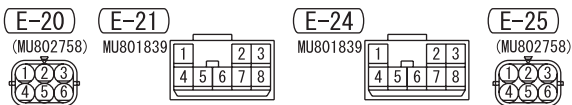
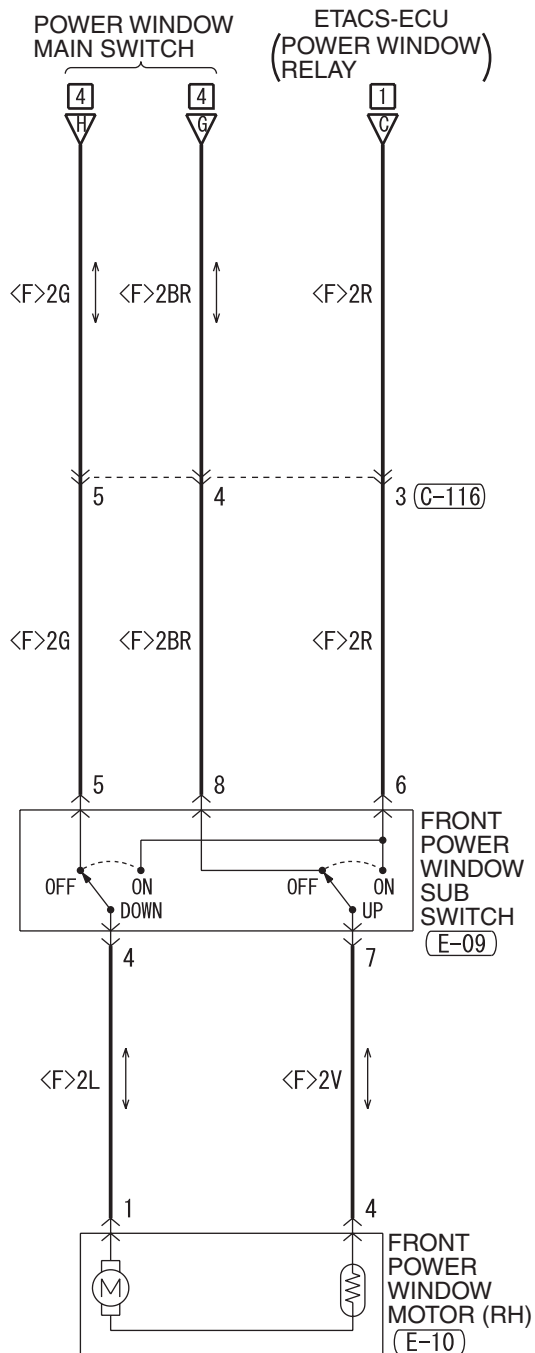

WIRE COLOR CODE
 B: BLACK LG: LIGHT GREEN G: GREEN L: BLUE W: WHITE Y: YELLOW SB: SKY BLUE
 BR: BROWN O: ORANGE GR: GRAY R: RED P: PINK V: VIOLET PU: PURPLE SI: SILVER

H8G11M08CB

CENTRAL DOOR LOCKING SYSTEM

M1901004705220

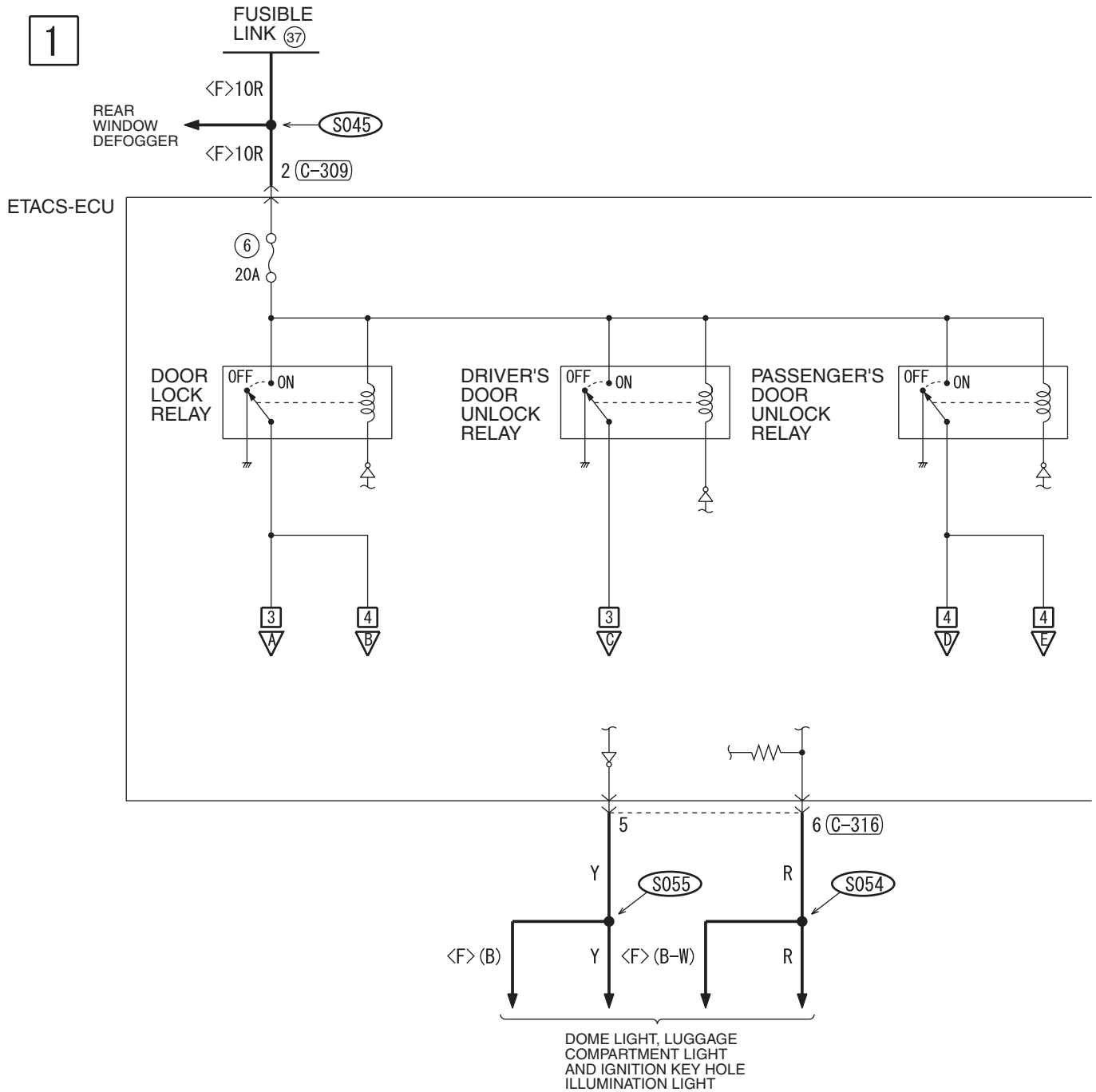

C-40 FRONT SIDE

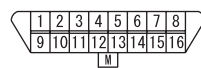

C-301

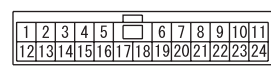

C-304

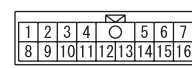

C-309



C-311

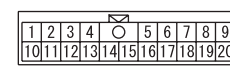

C-316



2

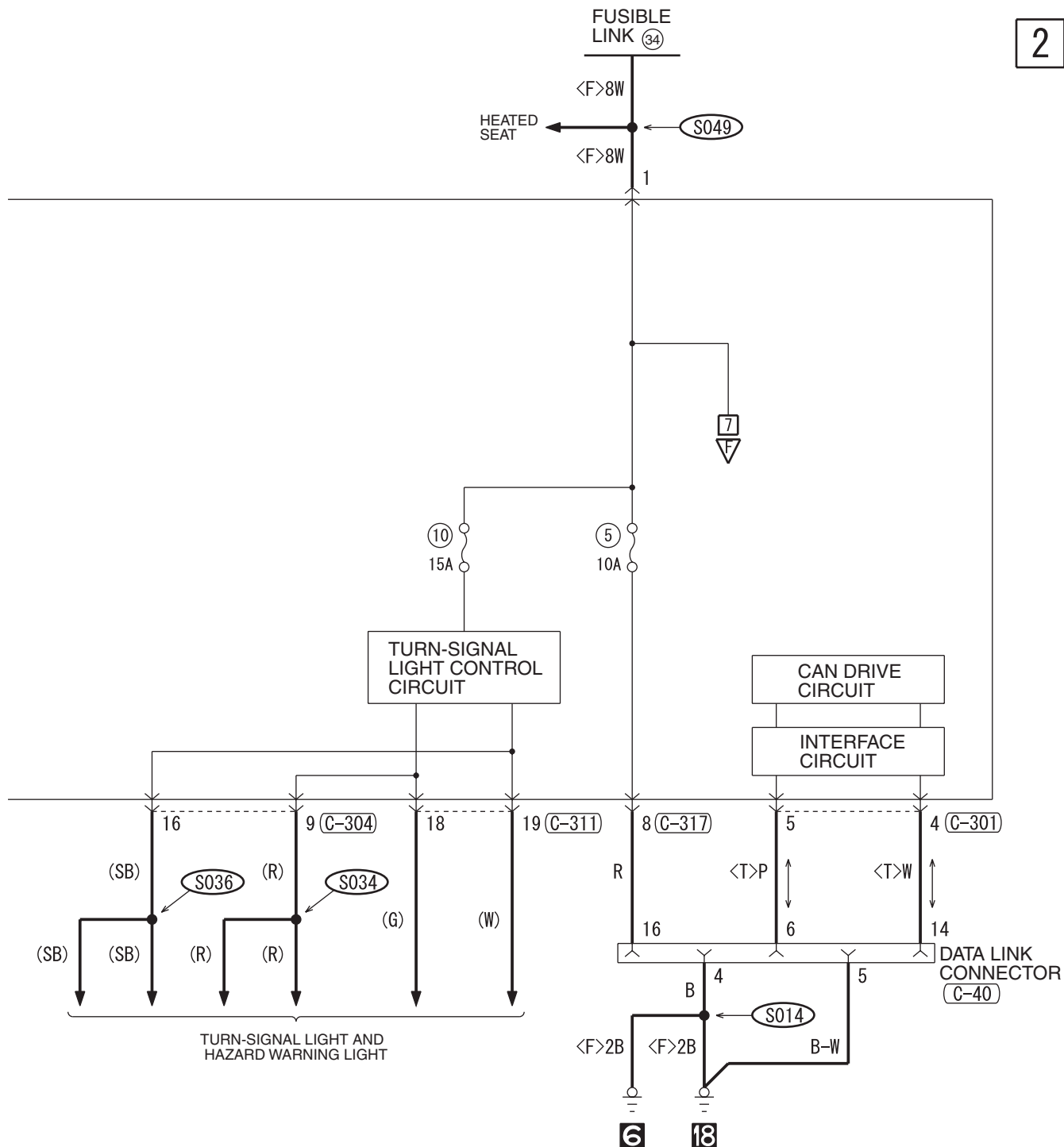

(C-317)

1	2	3	4	5	6	7	
8	9	10	11	12	13	14	15

WIRE COLOR CODE

B: BLACK LG: LIGHT GREEN G: GREEN L: BLUE W: WHITE Y: YELLOW SB: SKY BLUE
BR: BROWN O: ORANGE GR: GRAY R: RED P: PINK V: VIOLET PU: PURPLE SI: SILVER

H8G11M09AB

TSB Revision

CENTRAL DOOR LOCKING SYSTEM (CONTINUED)

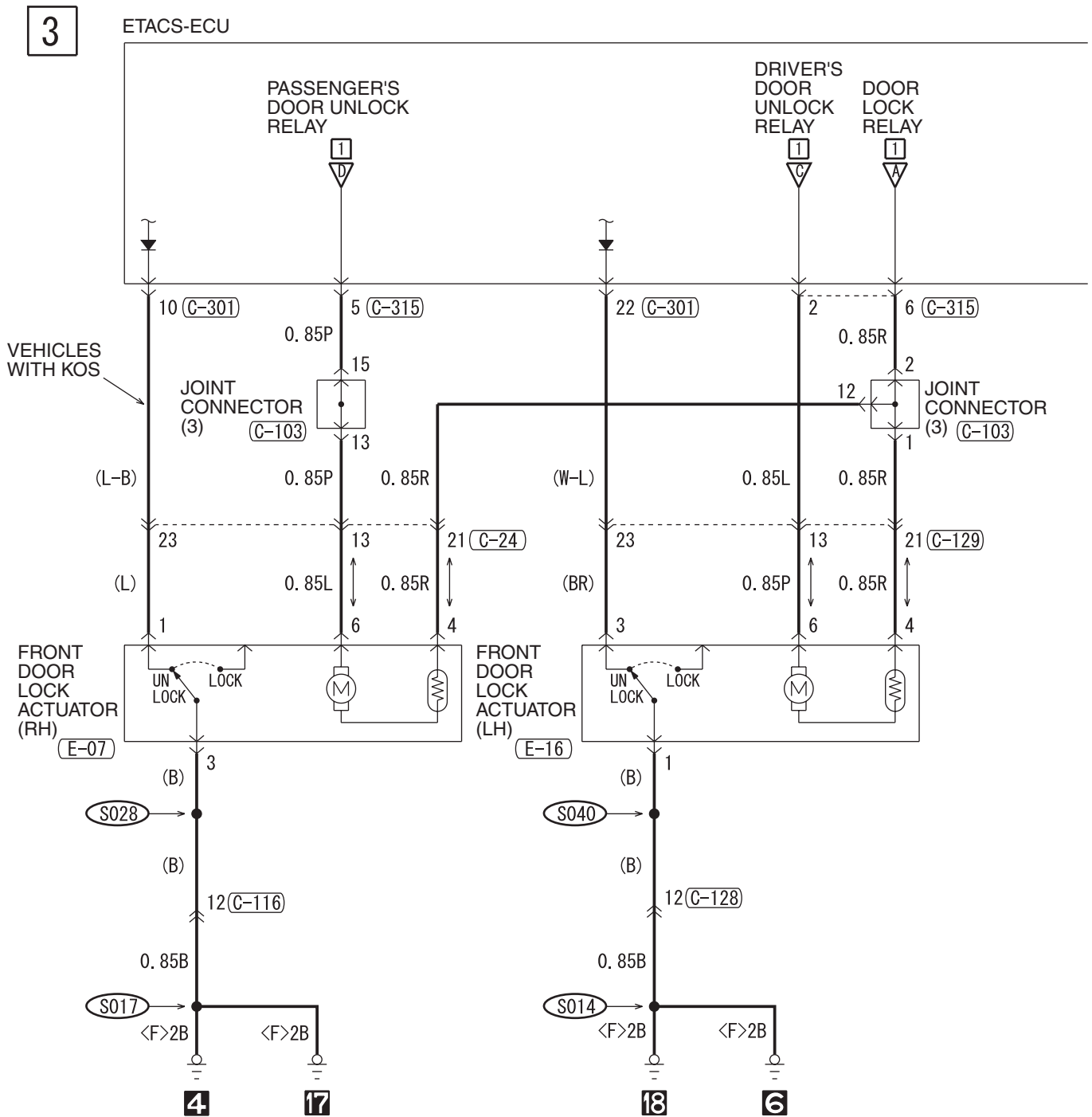

C-24

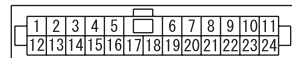

C-43

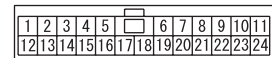

C-103

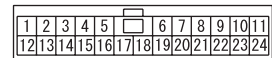

C-116

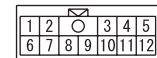

C-128

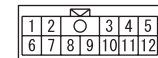

D-24

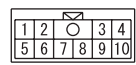

E-07



E-16



E-19



E-26



4

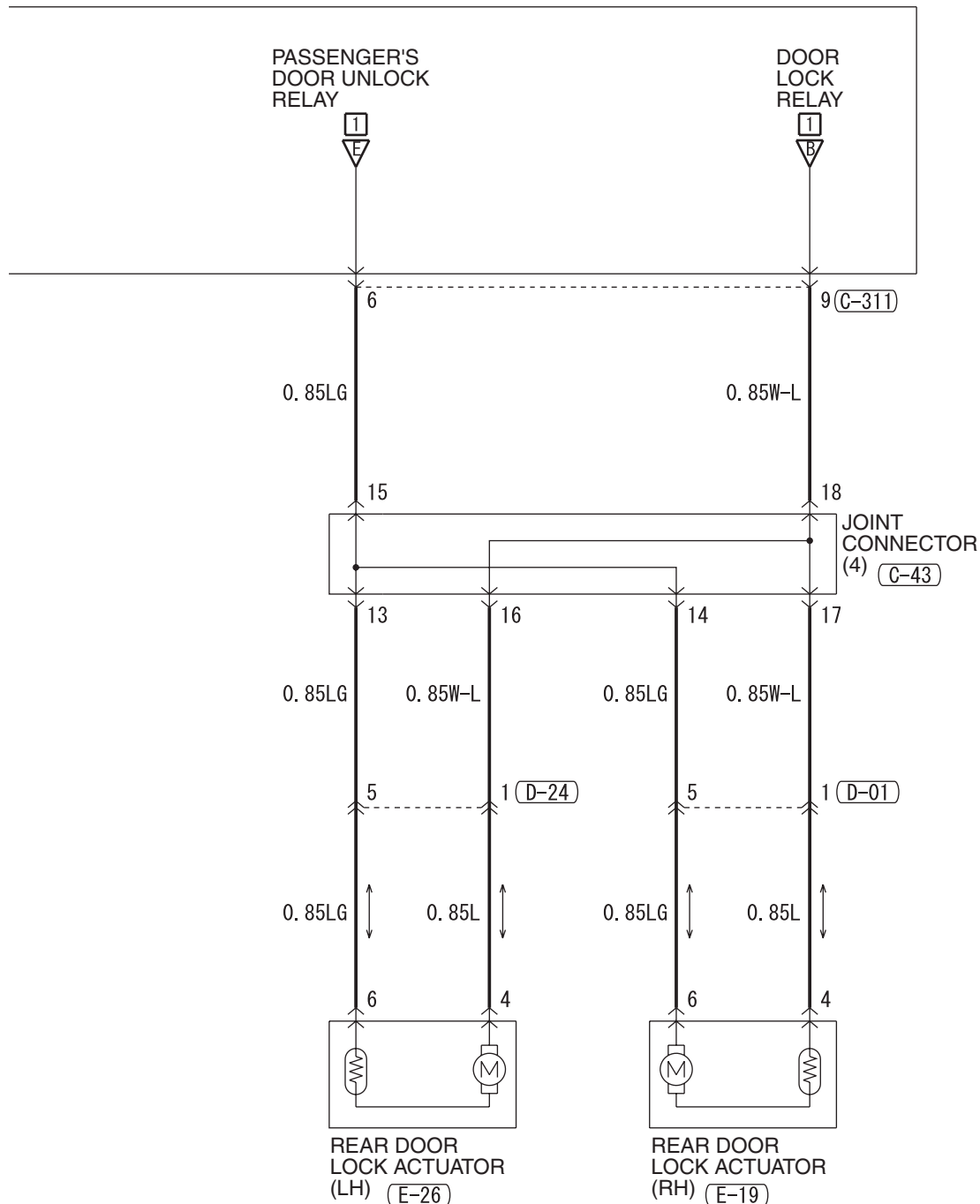

(C-129)

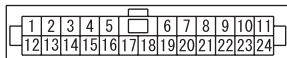

(C-301)

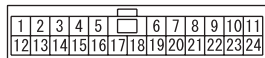

(C-311)

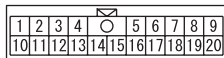

(C-315)

MU801890

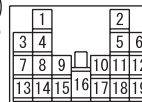

(D-01)

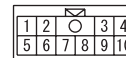

WIRE COLOR CODE

B : BLACK LG : LIGHT GREEN G : GREEN L : BLUE W : WHITE Y : YELLOW SB : SKY BLUE
BR : BROWN O : ORANGE GR : GRAY R : RED P : PINK V : VIOLET PU : PURPLE SI : SILVER

H8G11M09BB

CENTRAL DOOR LOCKING SYSTEM (CONTINUED)

5

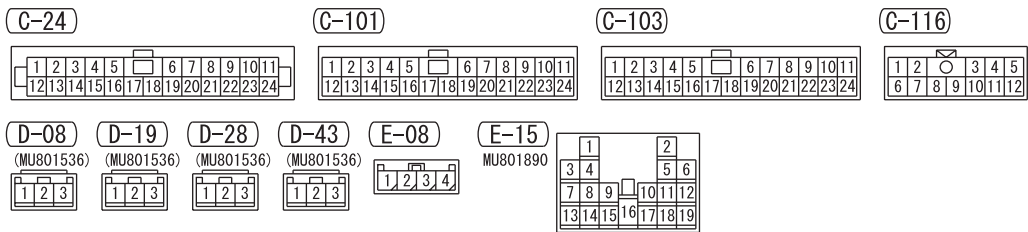
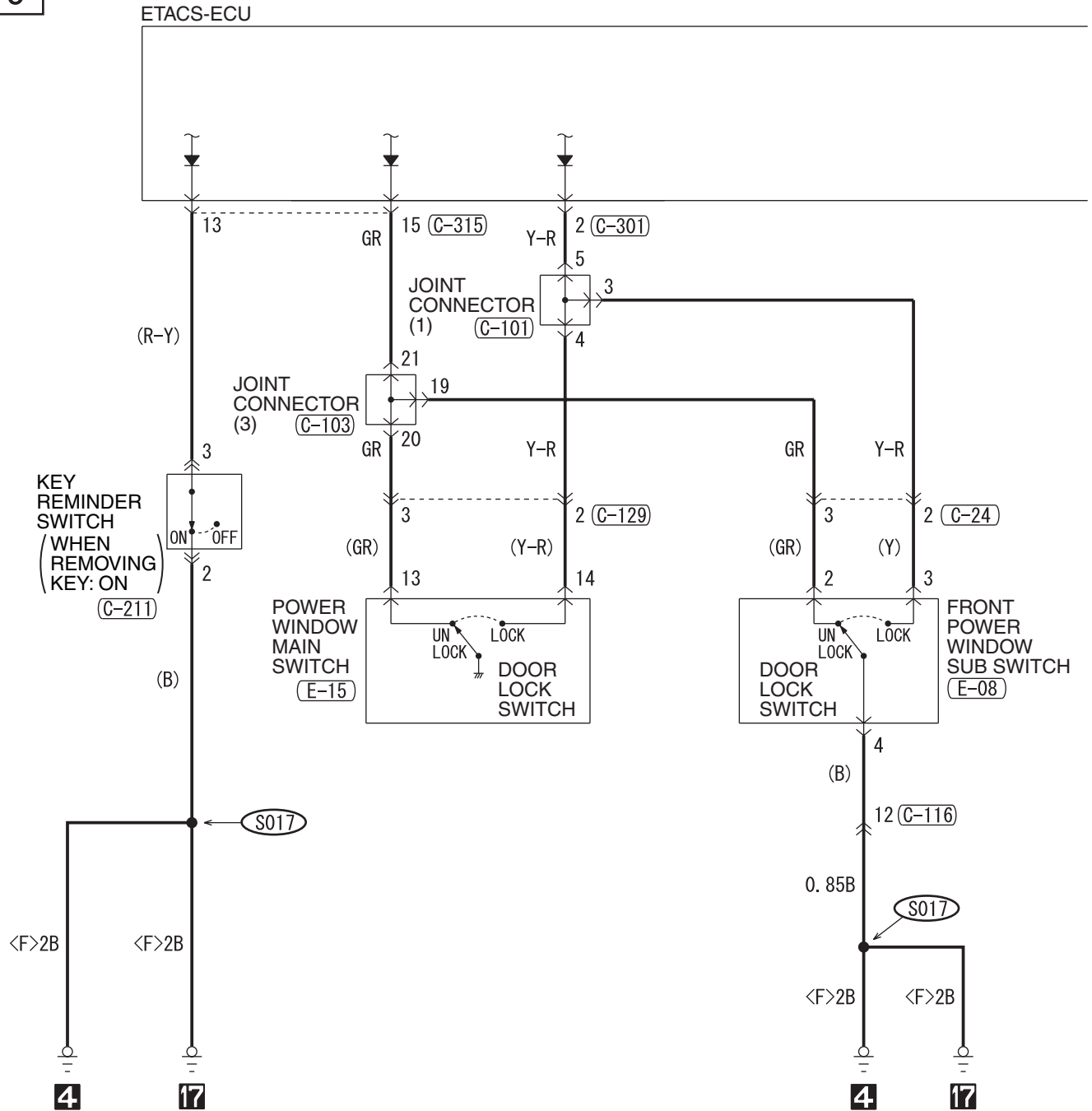

6

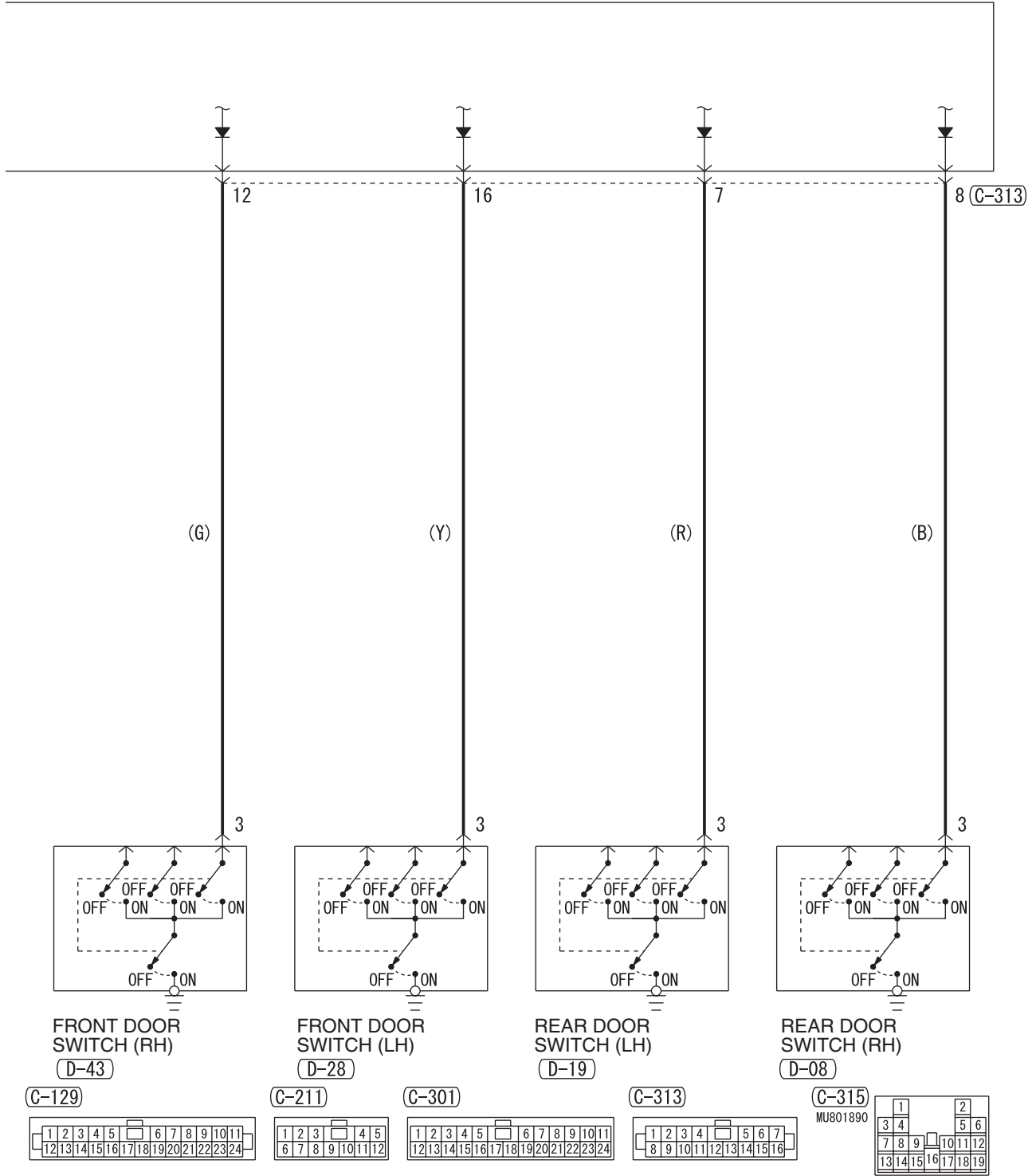

WIRE COLOR CODE

B: BLACK LG: LIGHT GREEN G: GREEN L: BLUE W: WHITE Y: YELLOW SB: SKY BLUE
BR: BROWN O: ORANGE GR: GRAY R: RED P: PINK V: VIOLET PU: PURPLE SI: SILVER

H8G11M09CB

TSB Revision

CENTRAL DOOR LOCKING SYSTEM (CONTINUED)

7

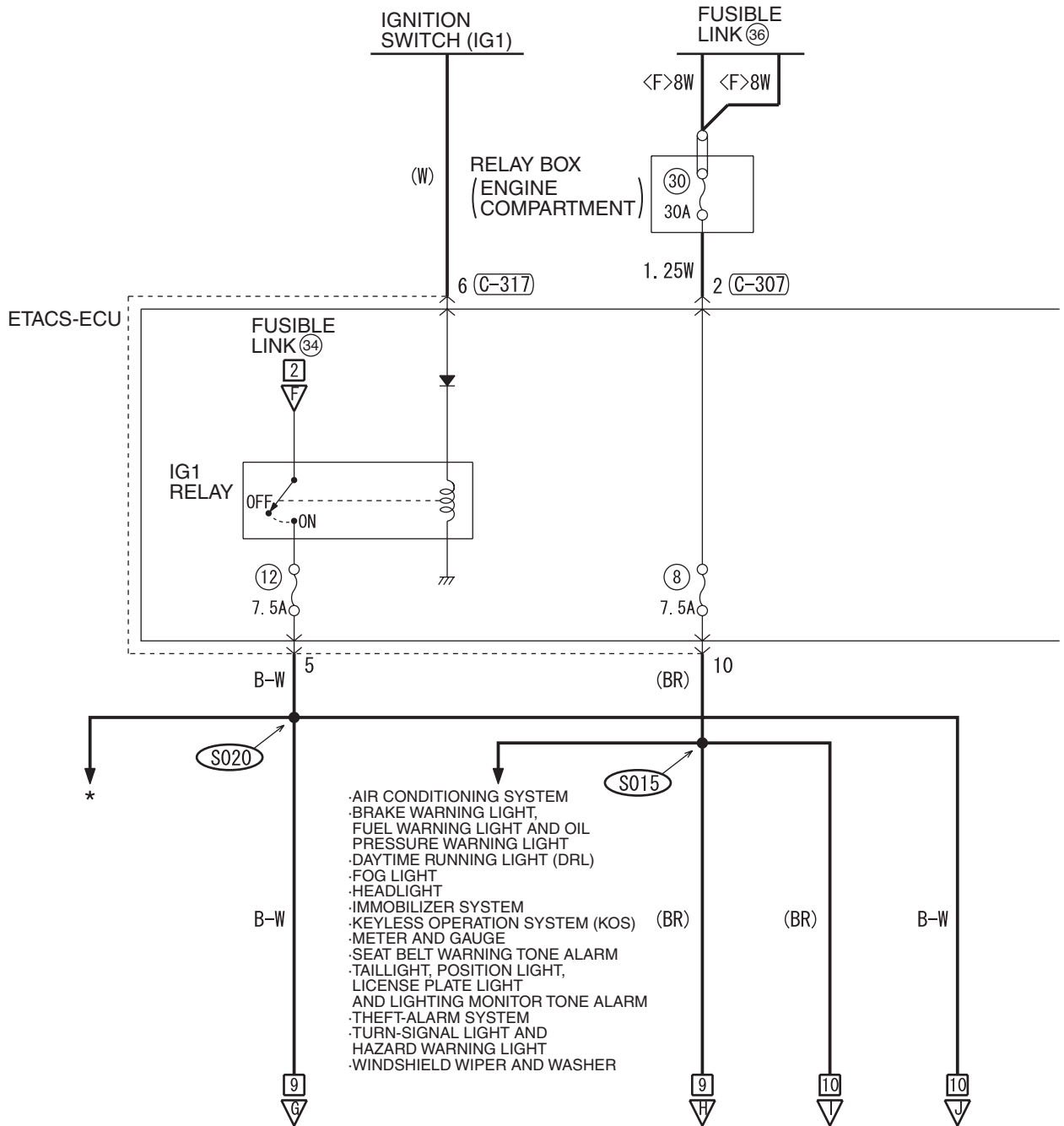

(C-105)

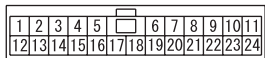

(C-301)

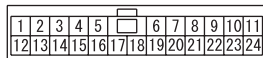

(C-307)



(C-317)

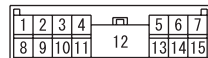

NOTE

- * : .ABS, ASC, ACD, AYC AND S-AWC
- .AIR CONDITIONING SYSTEM
- .AUTO-CRUISE CONTROL SYSTEM
- .BRAKE WARNING LIGHT,
- FUEL WARNING LIGHT AND
- OIL PRESSURE WARNING LIGHT
- .CHARGING SYSTEM
- .COOLING SYSTEM
- .DAYTIME RUNNING LIGHT (DRL)
- .DOOR AJAR WARNING TONE ALARM
- .FOG LIGHT
- .HEADLIGHT
- .HEATED SEAT
- .IGNITION KEY REMINDER TONE
- ALARM
- .KEYLESS OPERATING SYSTEM
- (KOS)
- .METER AND GAUGE
- .MFI SYSTEM
- .PARKING BRAKE WARNING
- TONE ALARM
- .REAR WINDOW DEFOGGER
- .SEAT BELT WARNING TONE ALARM
- SHIFT LOCK MECHANISM
- .SUNROOF
- .SUPPLEMENTAL RESTRAINT
- SYSTEM (SRS)
- .TAILLIGHT, POSITION LIGHT,
- LICENSE PLATE LIGHT AND
- LIGHTING MONITOR TONE ALARM
- .TC-SST
- .THEFT-ALARM SYSTEM
- .TIRE PRESSURE MONITORING
- SYSTEM (TPMS)
- .TURN-SIGNAL LIGHT AND
- HAZARD WARNING LIGHT
- .WINDSHIELD WIPER AND WASHER

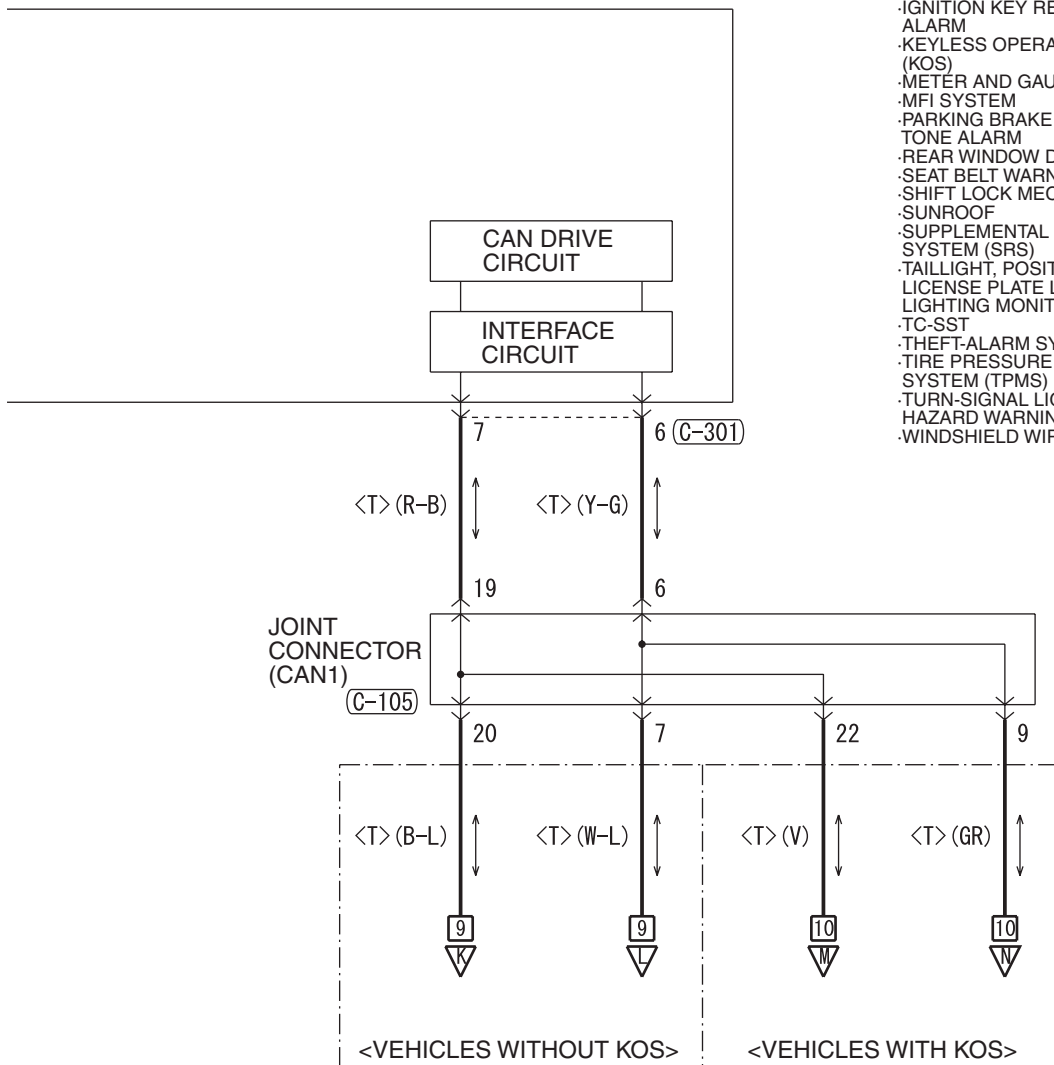

WIRE COLOR CODE

B : BLACK LG : LIGHT GREEN G : GREEN L : BLUE W : WHITE Y : YELLOW SB : SKY BLUE
BR : BROWN O : ORANGE GR : GRAY R : RED P : PINK V : VIOLET PU : PURPLE SI : SILVER

CENTRAL DOOR LOCKING SYSTEM (CONTINUED)

9

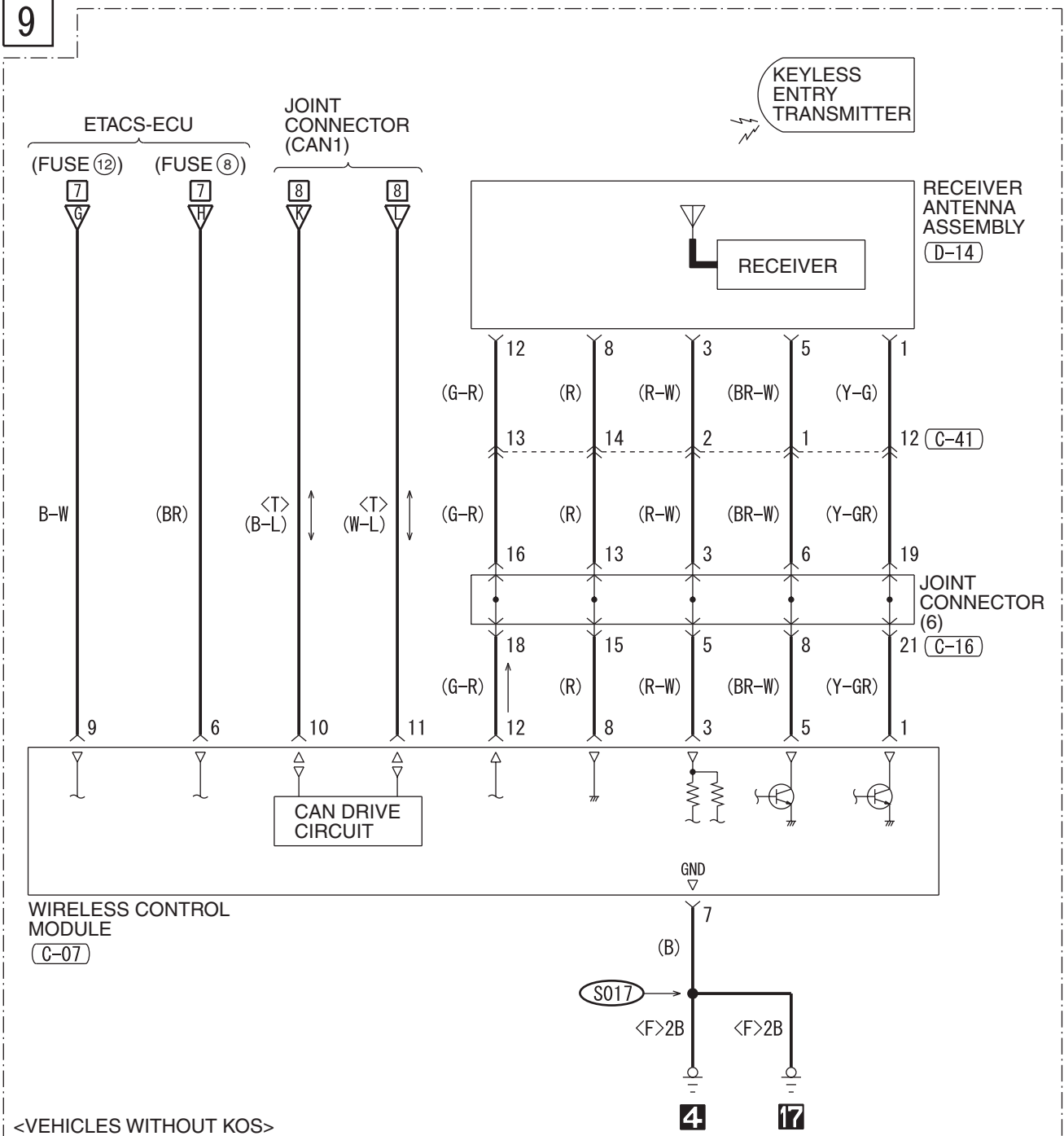

<VEHICLES WITHOUT KOS>

(C-05)

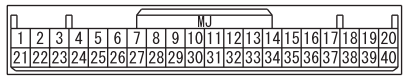

(C-07)

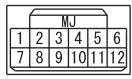

(C-16)

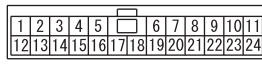

(C-41)

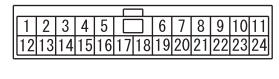

(D-14)

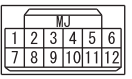

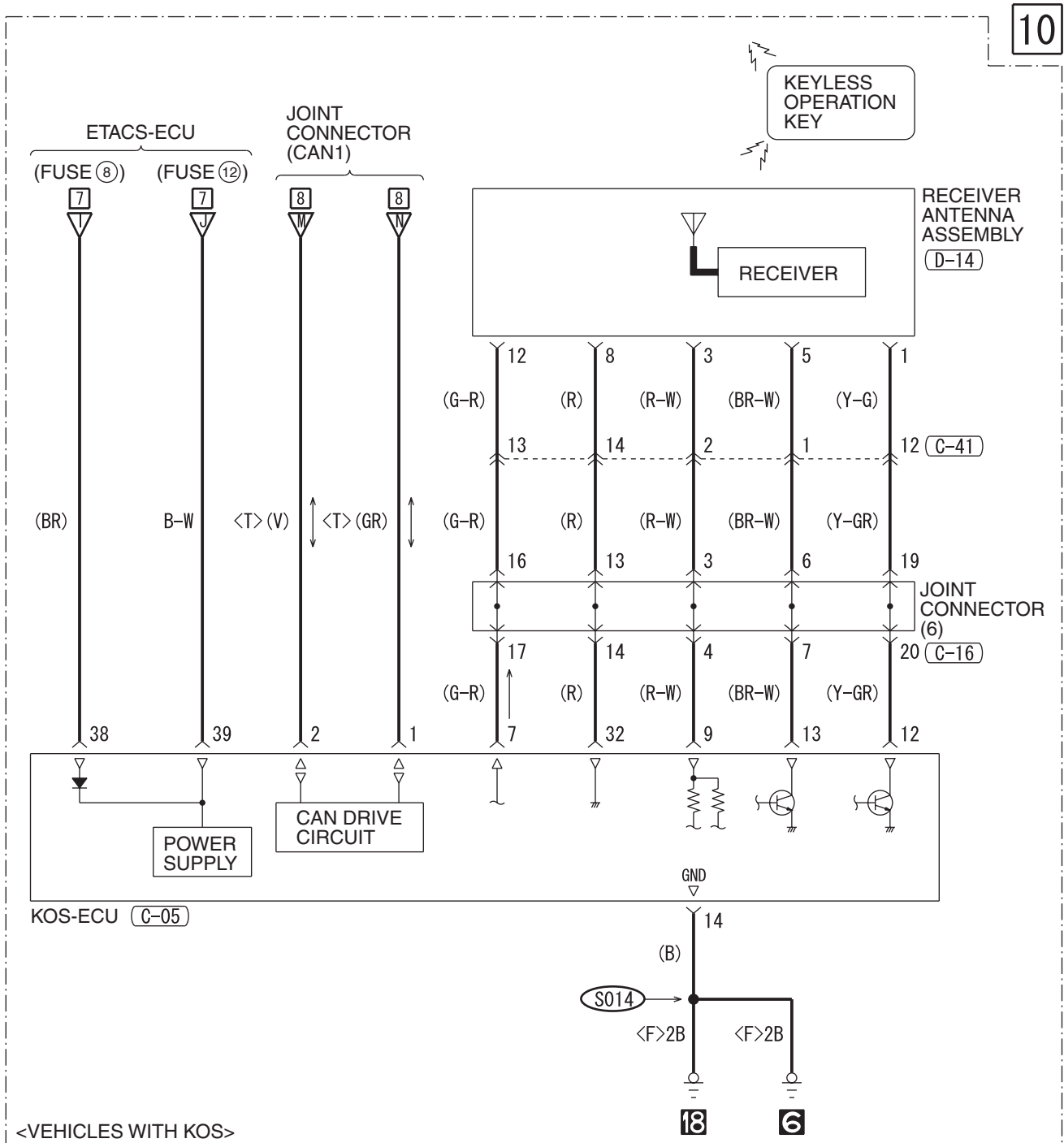

<VEHICLES WITH KOS>

WIRE COLOR CODE
 B: BLACK LG: LIGHT GREEN G: GREEN L: BLUE W: WHITE Y: YELLOW SB: SKY BLUE
 BR: BROWN O: ORANGE GR: GRAY R: RED P: PINK V: VIOLET PU: PURPLE SI: SILVER

H8G11M09EB

TSB Revision

CENTRAL DOOR LOCKING SYSTEM (CONTINUED)

11

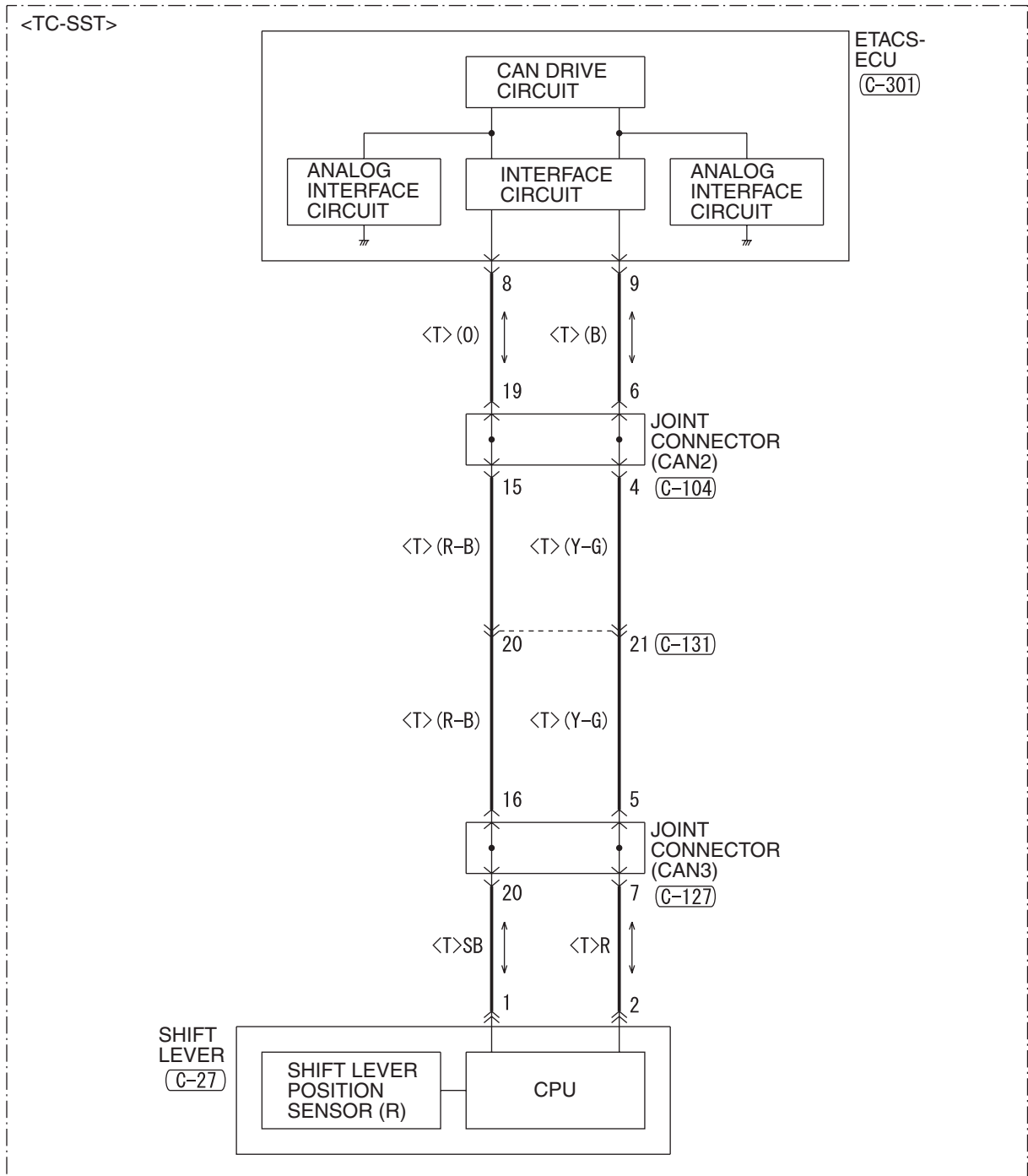

(C-27)

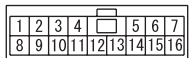

(C-104)

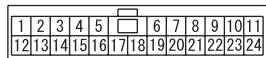

(C-127)

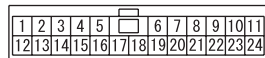

(C-131)

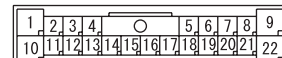

(C-301)

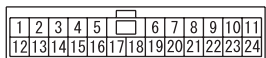

WIRE COLOR CODE

B: BLACK LG: LIGHT GREEN G: GREEN L: BLUE W: WHITE
Y: YELLOW SB: SKY BLUE BR: BROWN O: ORANGE GR: GRAY
R: RED P: PINK V: VIOLET PU: PURPLE SI: SILVER

H8G11M09FA

NOTES

KEYLESS OPERATING SYSTEM (KOS)

M1901025500271

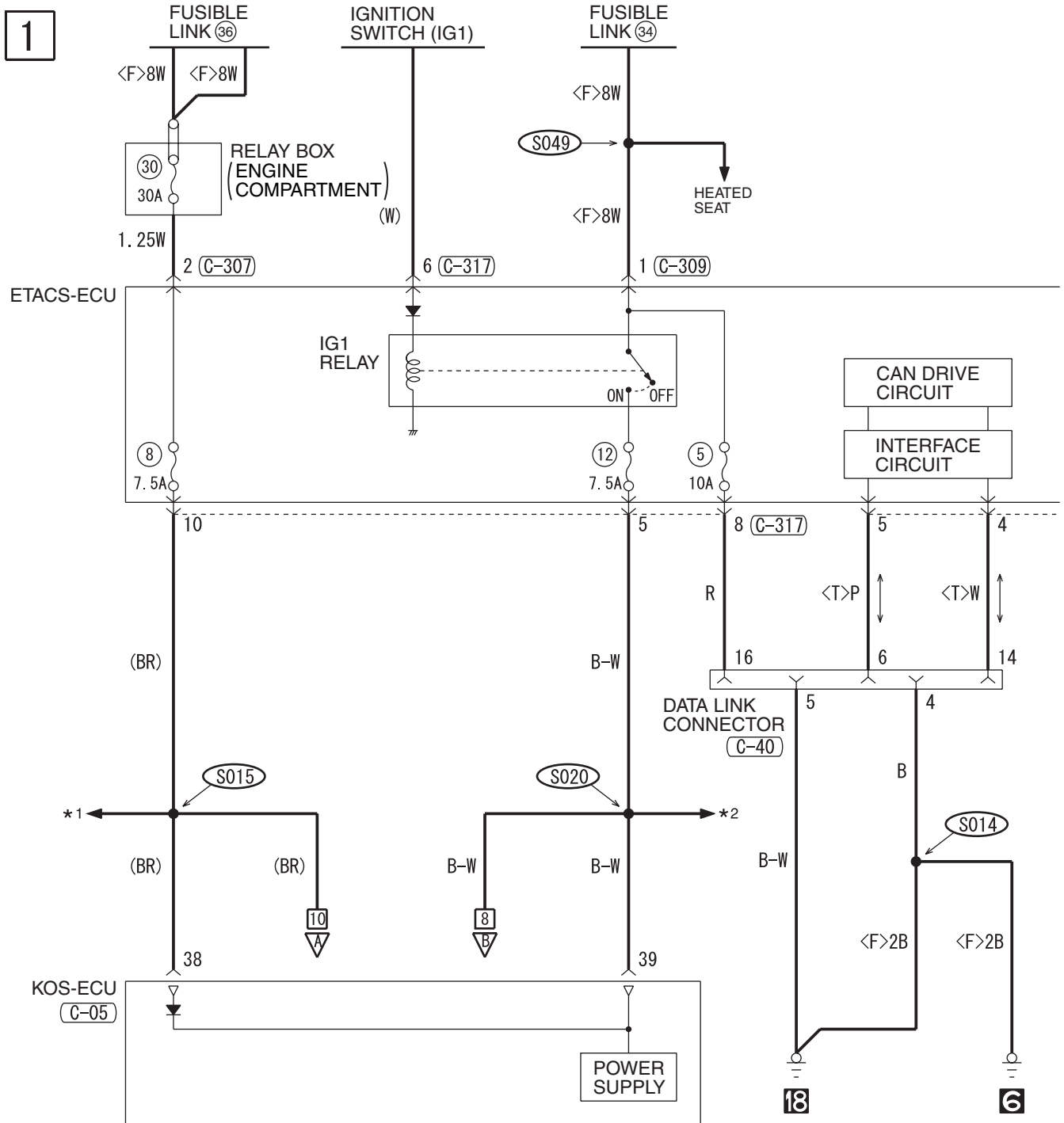

(A-05)

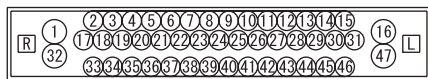

(A-13)

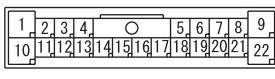

(A-14)

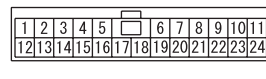

(C-104)

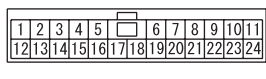

(C-127)

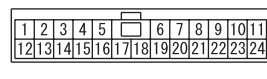

(C-131)

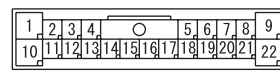

(C-301)

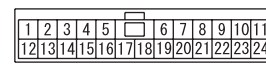

(C-307)



MU801325
H8G11M10AA

2

NOTE

- *1: -AIR CONDITIONING SYSTEM
-BRAKE WARNING LIGHT,
FUEL WARNING LIGHT AND OIL
PRESSURE WARNING LIGHT
-DAYTIME RUNNING LIGHT (DRL)
-DOME LIGHT, LUGGAGE COMPARTMENT LIGHT AND
IGNITION KEY HOLE ILLUMINATION LIGHT
-FOG LIGHT
-HEADLIGHT
-IMMOBILIZER SYSTEM
-METER AND GAUGE
-SEAT BELT WARNING TONE ALARM
-TAILLIGHT, POSITION LIGHT, LICENSE PLATE LIGHT
AND LIGHTING MONITOR TONE ALARM
-THEFT-ALARM SYSTEM
-TURN-SIGNAL LIGHT AND HAZARD WARNING LIGHT
-WINDSHIELD WIPER AND WASHER

- *2: -ABS, ASC, ACD, AYC AND S-AWC
-AIR CONDITIONING SYSTEM
-CENTRAL DOOR LOCKING SYSTEM
-DAYTIME RUNNING LIGHT (DRL)
-FOG LIGHT
-HEADLIGHT
-HEATED DOOR MIRROR
-HEATED SEAT
-IGNITION KEY REMINDER TONE
ALARM
-IMMOBILIZER SYSTEM
-REAR WINDOW DEFOGGER
-SEAT BELT WARNING TONE ALARM
-SHIFT LOCK MECHANISM

- SUNROOF
-SUPPLEMENTAL RESTRAINT
SYSTEM (SRS)
-TAILLIGHT, POSITION LIGHT,
LICENSE PLATE LIGHT AND
LIGHTING MONITOR TONE ALARM
-TC-SST
-THEFT-ALARM SYSTEM
-TIRE PRESSURE MONITORING
SYSTEM (TPMS)
-TURN-SIGNAL LIGHT AND
HAZARD WARNING LIGHT
-WINDSHIELD WIPER AND WASHER

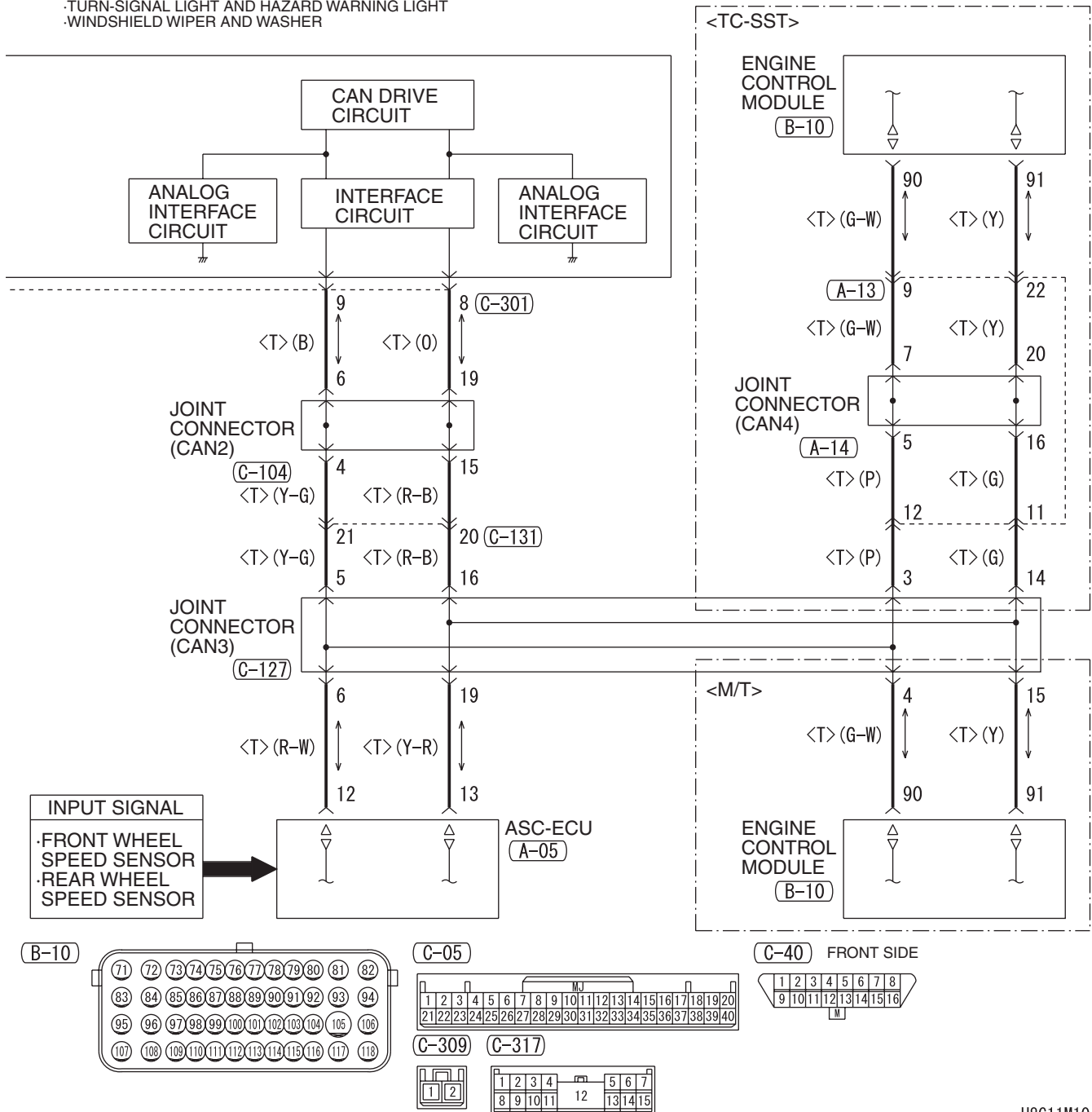

KEYLESS OPERATING SYSTEM (KOS) (CONTINUED)

3

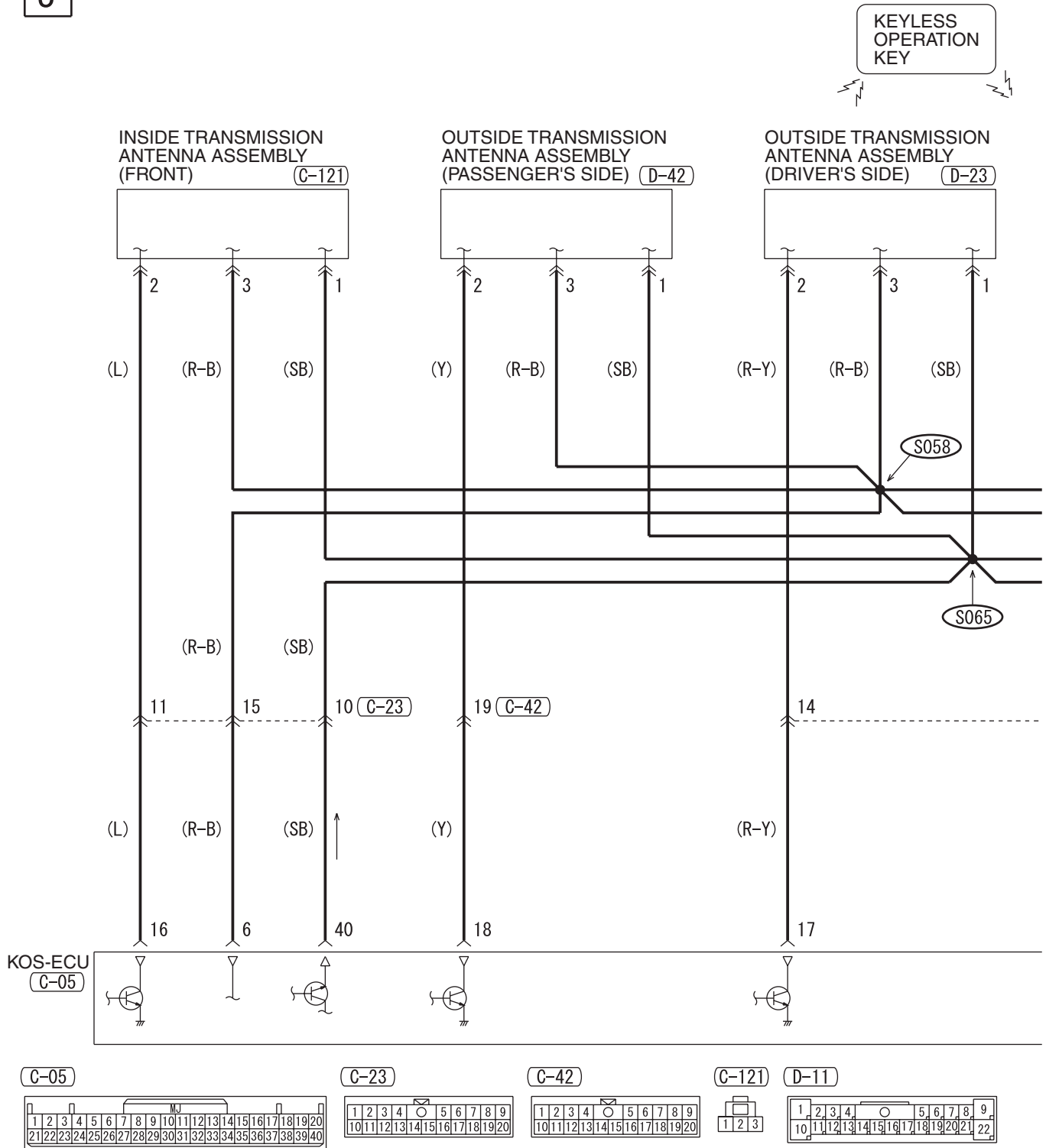

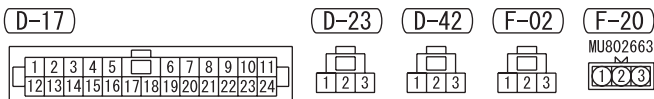
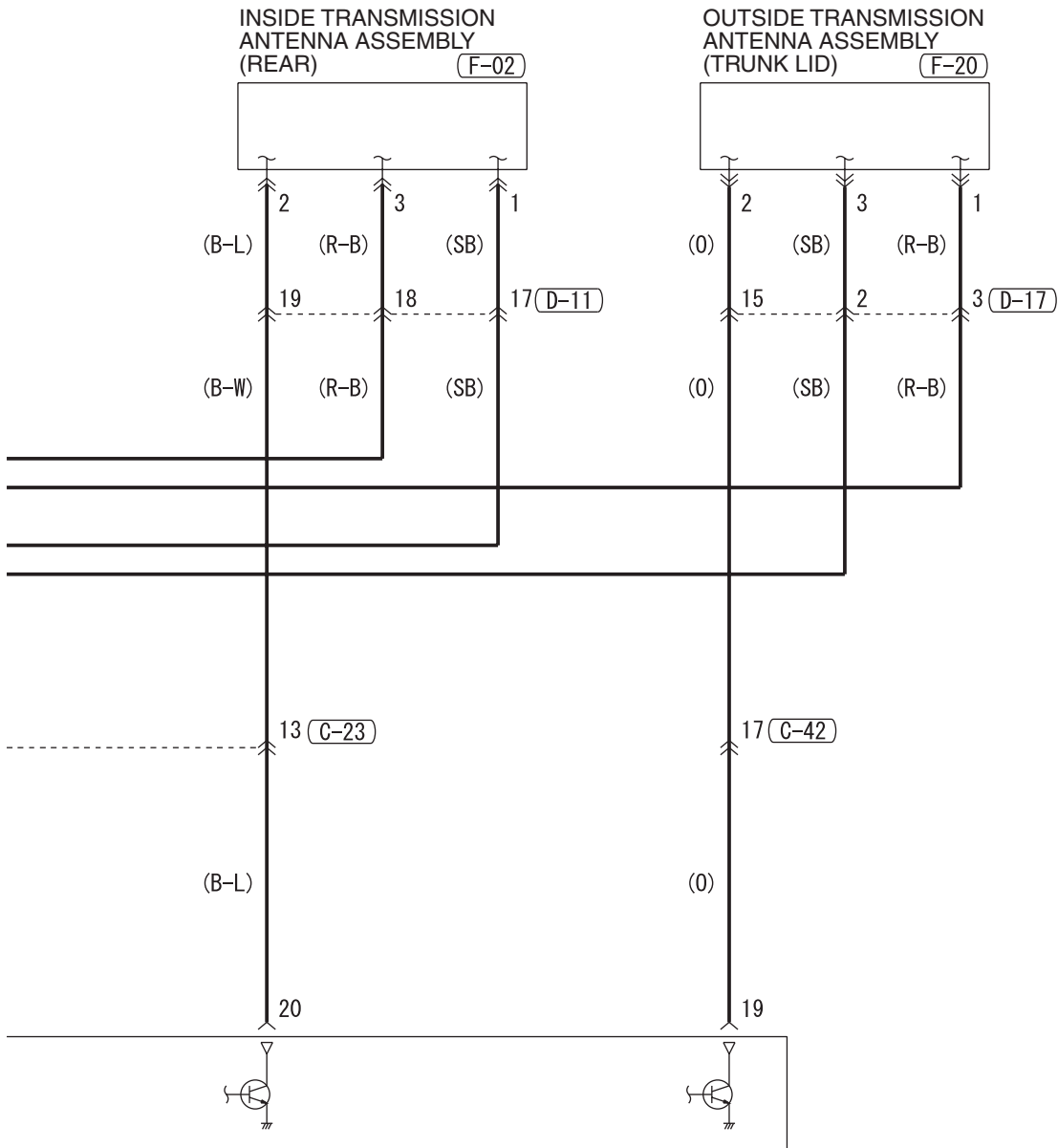

WIRE COLOR CODE
B: BLACK LG: LIGHT GREEN G: GREEN L: BLUE W: WHITE Y: YELLOW SB: SKY BLUE
BR: BROWN O: ORANGE GR: GRAY R: RED P: PINK V: VIOLET PU: PURPLE SI: SILVER

H8G11J10BB

KEYLESS OPERATING SYSTEM (KOS) (CONTINUED)

5

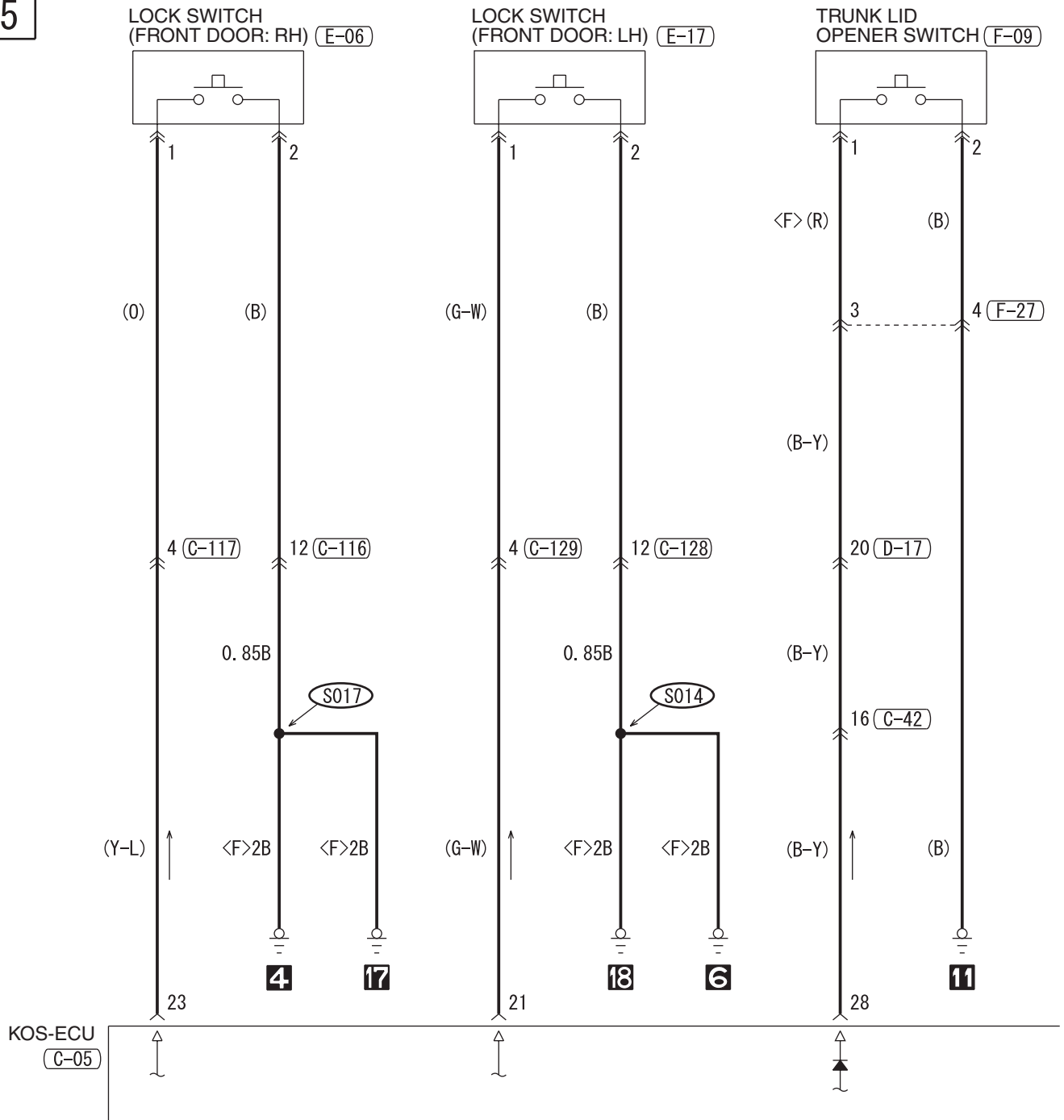

(C-05)

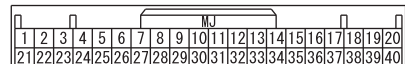

(C-42)

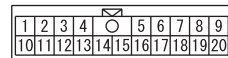

(C-101)

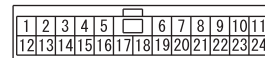

(C-116)

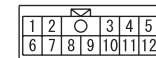

(E-17)

(E-18)

(F-09)

(F-27)



6

UNLOCK SENSOR
(FRONT DOOR: RH) (E-05)

UNLOCK SENSOR
(FRONT DOOR: LH) (E-18)

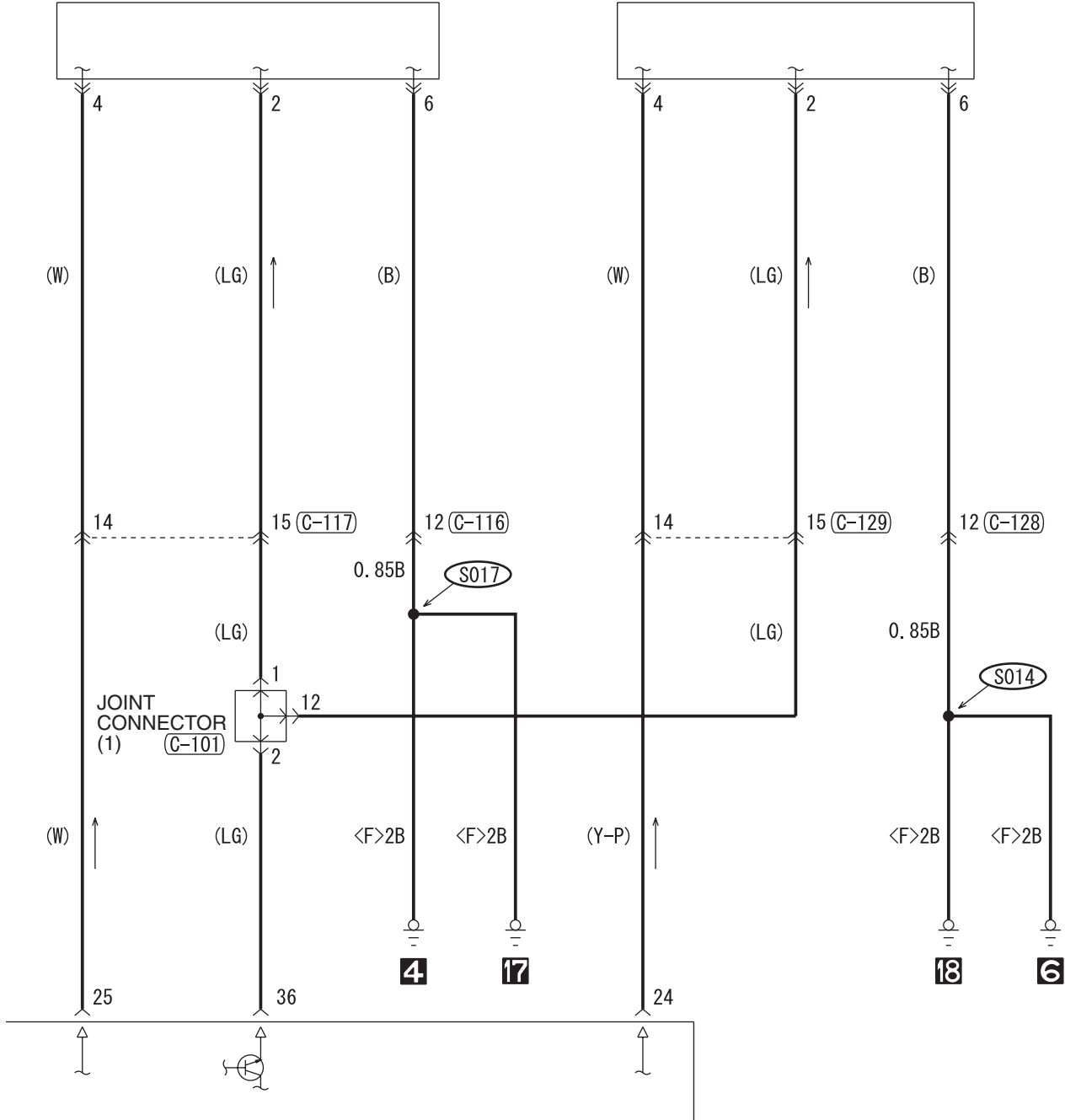

(C-117)

(C-128)

(C-129)

(D-17)

(E-05)

(E-06)

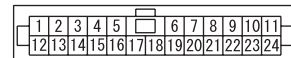
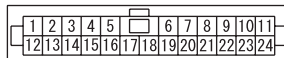
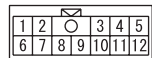
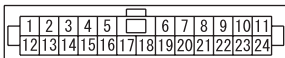

WIRE COLOR CODE

B: BLACK LG: LIGHT GREEN G: GREEN L: BLUE W: WHITE Y: YELLOW SB: SKY BLUE
BR: BROWN O: ORANGE GR: GRAY R: RED P: PINK V: VIOLET PU: PURPLE SI: SILVER

H8G11M10CB

TSB Revision

KEYLESS OPERATING SYSTEM (KOS) (CONTINUED)

7

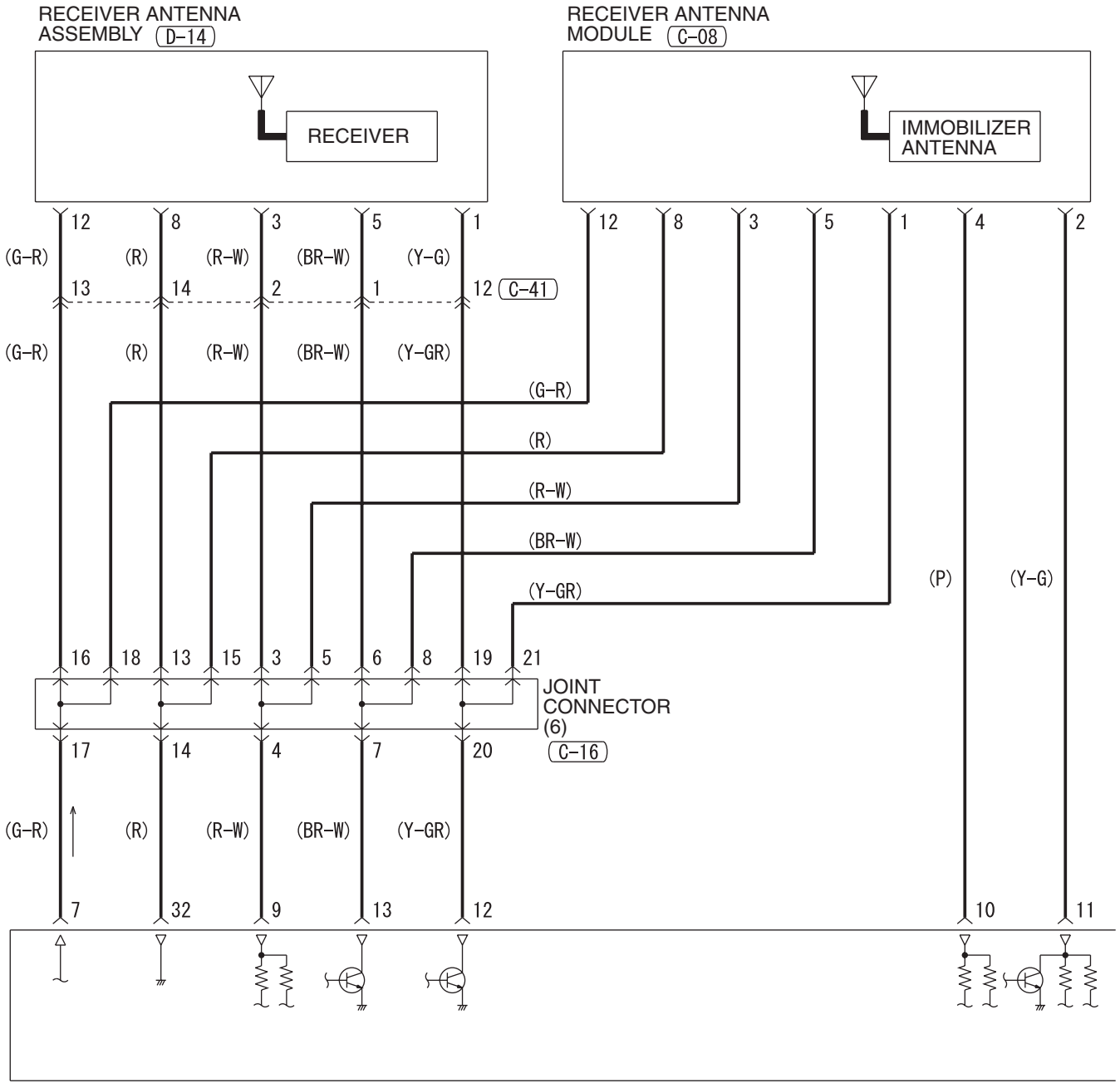

KOS-ECU (C-05)

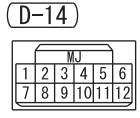
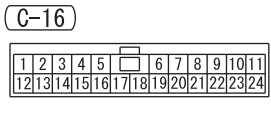
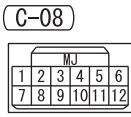
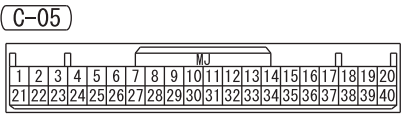
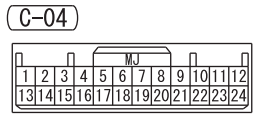

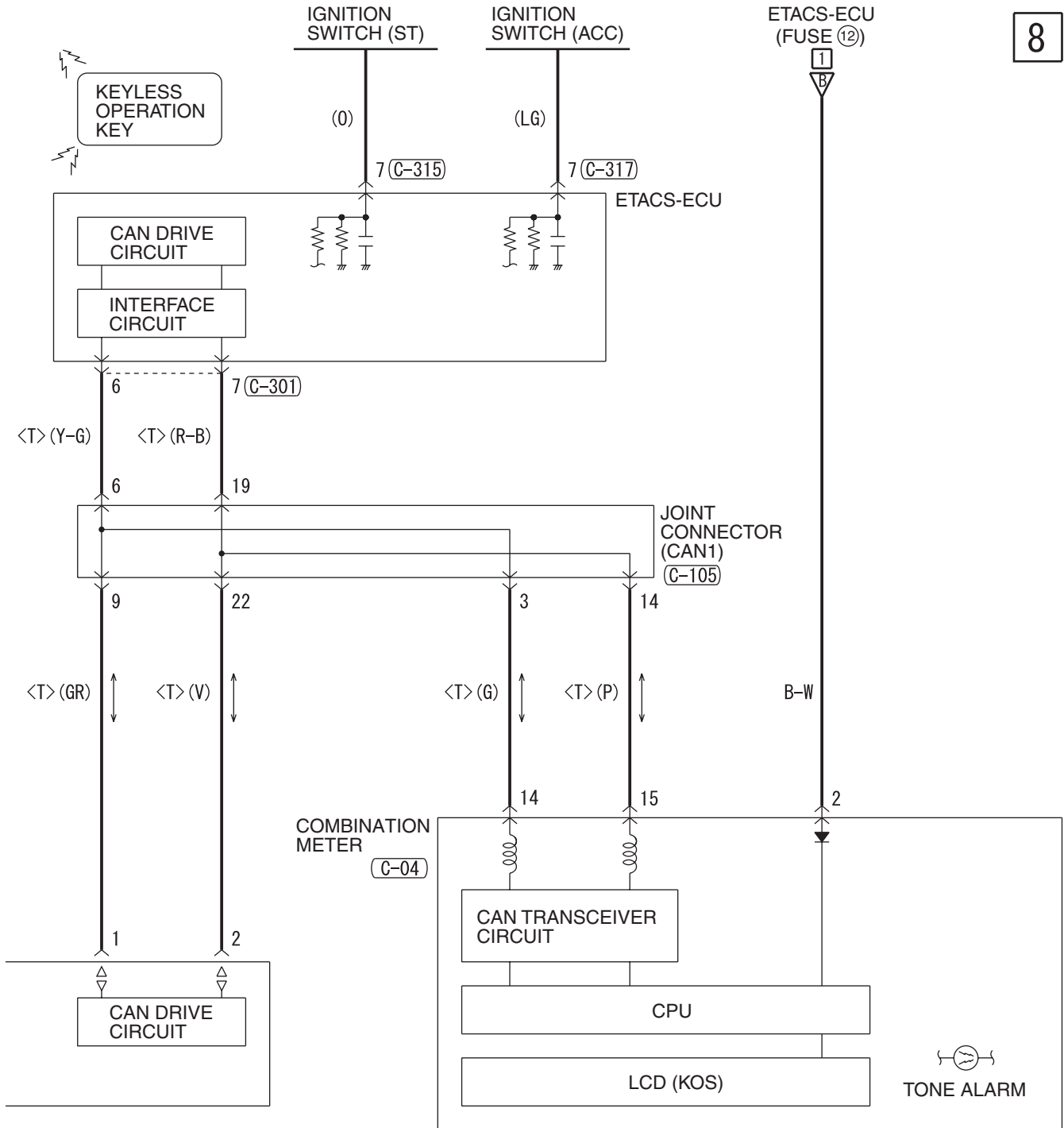

(C-41)

1	2	3	4	5	6	7	8	9	10	11		
12	13	14	15	16	17	18	19	20	21	22	23	24

(C-105)

1	2	3	4	5	6	7	8	9	10	11		
12	13	14	15	16	17	18	19	20	21	22	23	24

(C-301)

1	2	3	4	5	6	7	8	9	10	11		
12	13	14	15	16	17	18	19	20	21	22	23	24

(C-315)

MU801890

1	2
3	4
5	6
7	8
9	10
11	12
13	14
15	16
17	18
19	

(C-317)

1	2	3	4	5	6	7
8	9	10	11	12	13	14
15						

WIRE COLOR CODE

B: BLACK LG: LIGHT GREEN G: GREEN L: BLUE W: WHITE Y: YELLOW SB: SKY BLUE
BR: BROWN O: ORANGE GR: GRAY R: RED P: PINK V: VIOLET PU: PURPLE SI: SILVER

KEYLESS OPERATING SYSTEM (KOS) (CONTINUED)

9

ETACS-
ECU

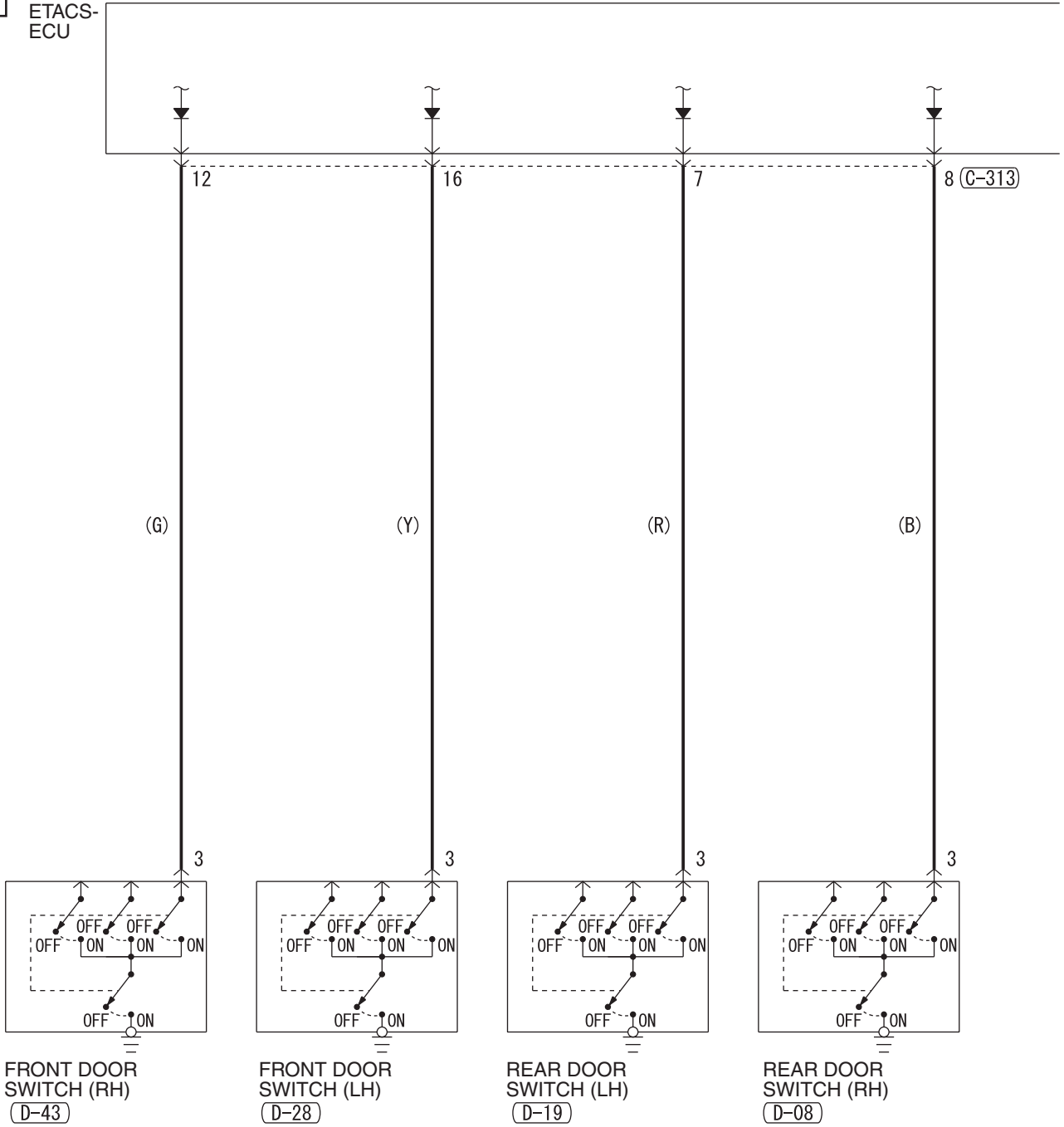

FRONT DOOR SWITCH (RH)
(D-43)

FRONT DOOR SWITCH (LH)
(D-28)

REAR DOOR SWITCH (LH)
(D-19)

REAR DOOR SWITCH (RH)
(D-08)

(C-05)

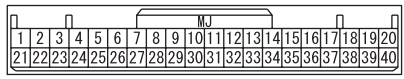

(C-42)

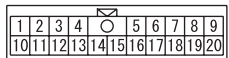

(C-211)

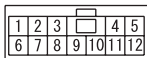

(C-313)

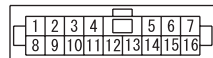

(C-315)

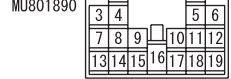

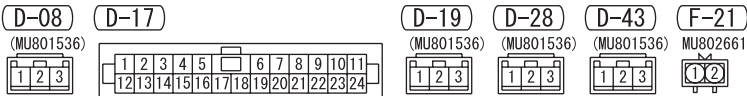
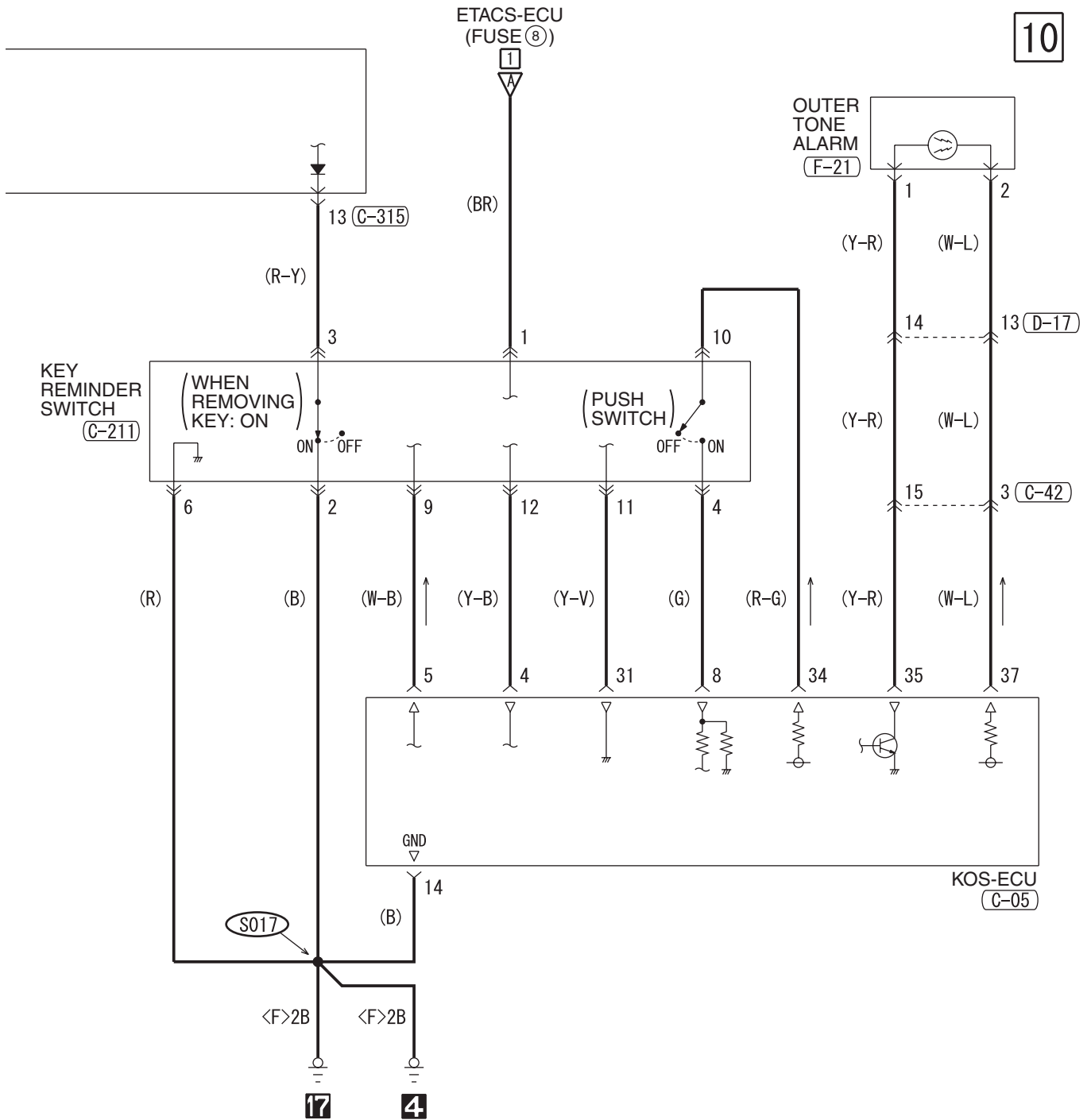

WIRE COLOR CODE
 B: BLACK LG: LIGHT GREEN G: GREEN L: BLUE W: WHITE Y: YELLOW SB: SKY BLUE
 BR: BROWN O: ORANGE GR: GRAY R: RED P: PINK V: VIOLET PU: PURPLE SI: SILVER

H8G11M10EB

TRUNK LID OPENER

1

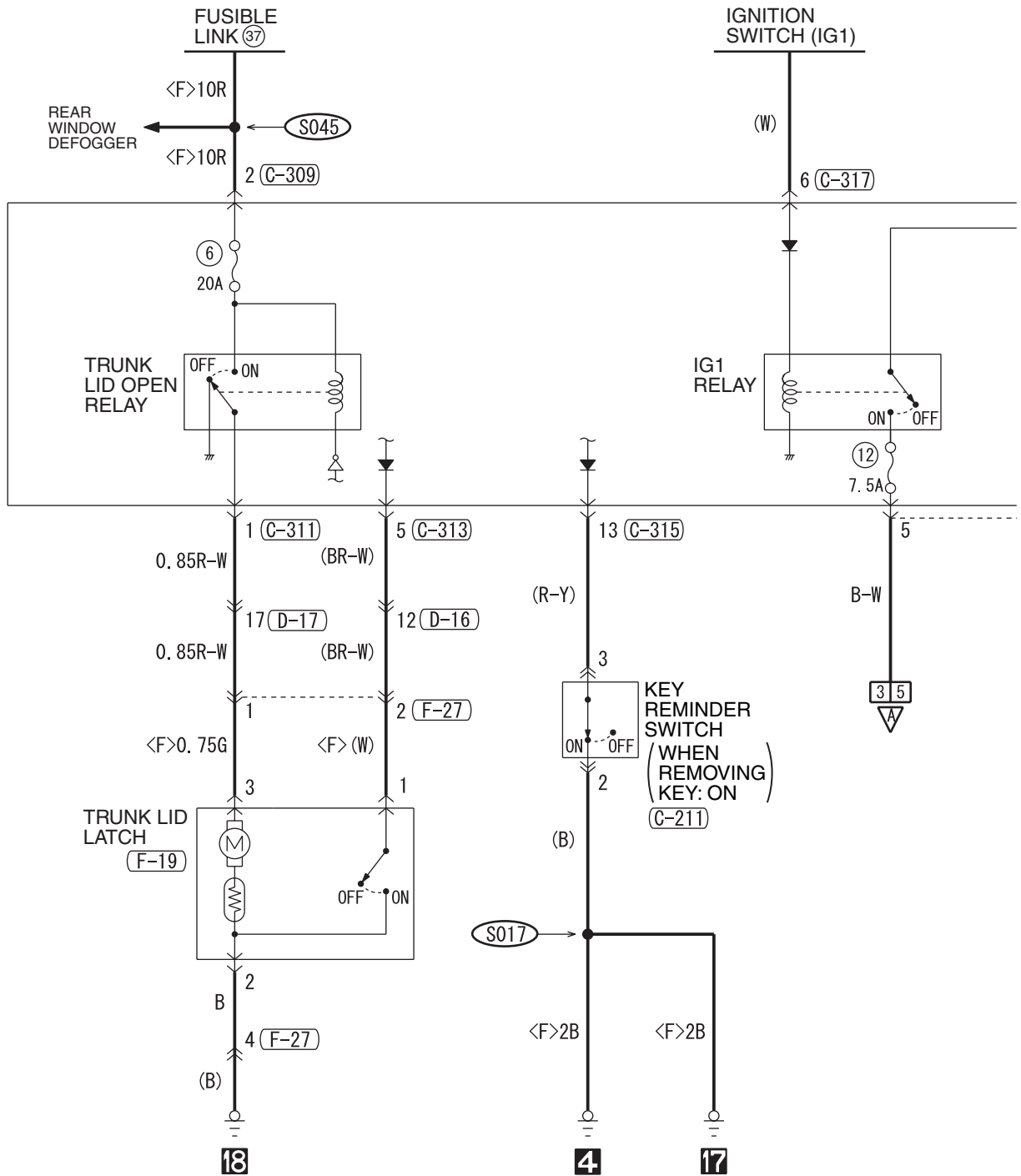

A-05

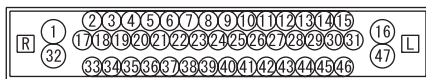

C-40 FRONT SIDE



C-104

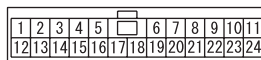

C-127

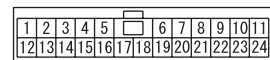

C-315



C-317

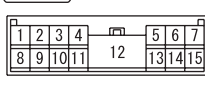

D-16

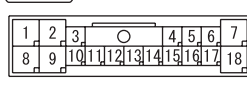

D-17

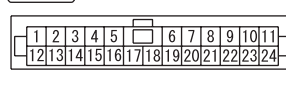

F-19



2

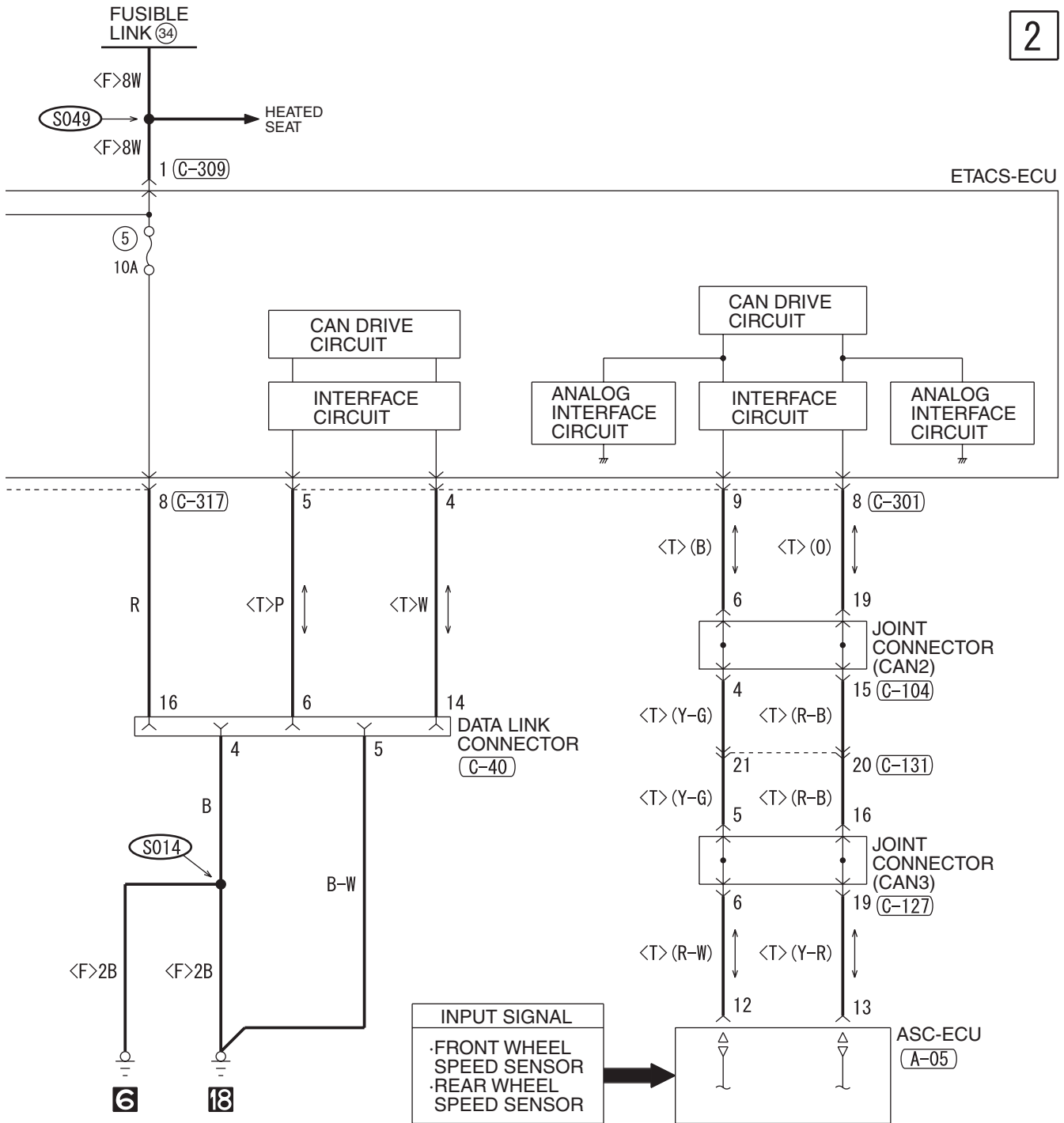

(C-131)

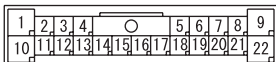

(C-211)

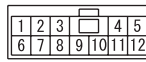

(C-301)

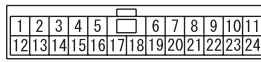

(C-309)



(C-311)

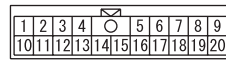

(C-313)

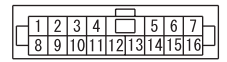

(F-27)

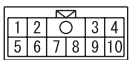

WIRE COLOR CODE

B : BLACK LG : LIGHT GREEN G : GREEN L : BLUE W : WHITE
 Y : YELLOW SB : SKY BLUE BR : BROWN O : ORANGE GR : GRAY
 R : RED P : PINK V : VIOLET PU : PURPLE SI : SILVER

H8G11M11AB

TRUNK LID OPENER (CONTINUED)

3

- ABS, ASC, ACD,
- AYC AND S-AWC
- AIR CONDITIONING SYSTEM
- AUTO-CRUISE CONTROL SYSTEM
- BRAKE WARNING LIGHT, FUEL WARNING LIGHT AND OIL PRESSURE WARNING LIGHT
- CHARGING SYSTEM
- COOLING SYSTEM
- DAYTIME RUNNING LIGHT (DRL)
- DOOR AJAR WARNING TONE ALARM
- FOG LIGHT
- HEADLIGHT
- HEATED DOOR MIRROR
- HEATED SEAT
- IGNITION KEY REMINDER TONE ALARM
- METER AND GAUGE
- MFI SYSTEM
- PARKING BRAKE WARNING TONE ALARM
- REAR WINDOW DEFOGGER
- SEAT BELT WARNING TONE ALARM
- SHIFT LOCK MECHANISM
- SUNROOF
- SUPPLEMENTAL RESTRAINT SYSTEM (SRS)
- TAILLIGHT, POSITION LIGHT, LICENSE PLATE LIGHT AND LIGHTING MONITOR TONE ALARM
- TC-SST
- THEFT-ALARM SYSTEM
- TIRE PRESSURE MONITORING SYSTEM (TPMS)
- TURN-SIGNAL LIGHT AND HAZARD WARNING LIGHT
- WINDSHIELD WIPER AND WASHER

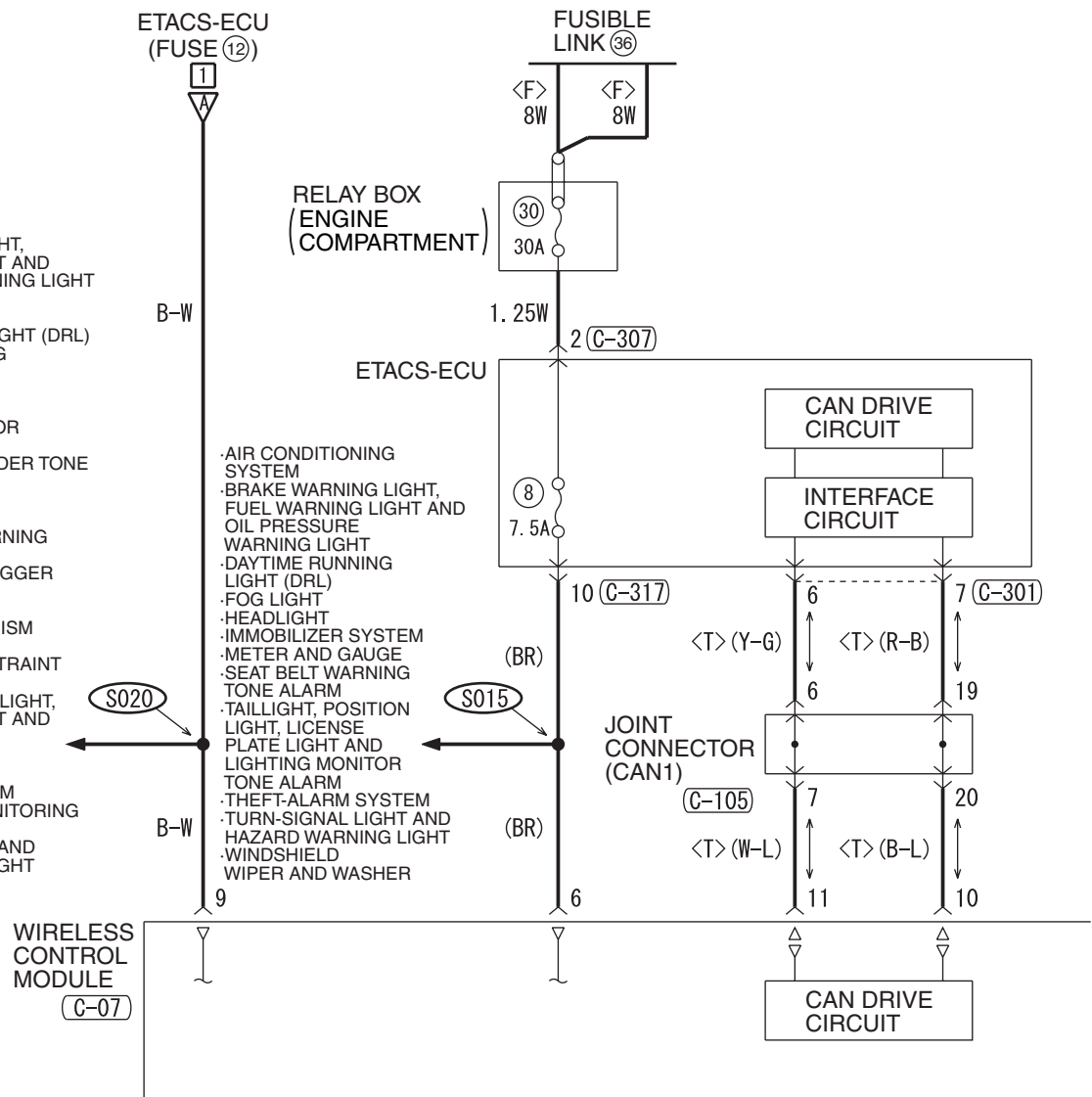

<VEHICLES WITHOUT KOS>

(C-07)

(C-16)

(C-41)

(C-105)

(C-301)

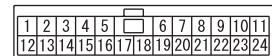
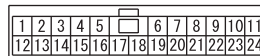
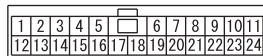
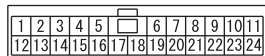
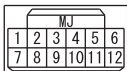

4

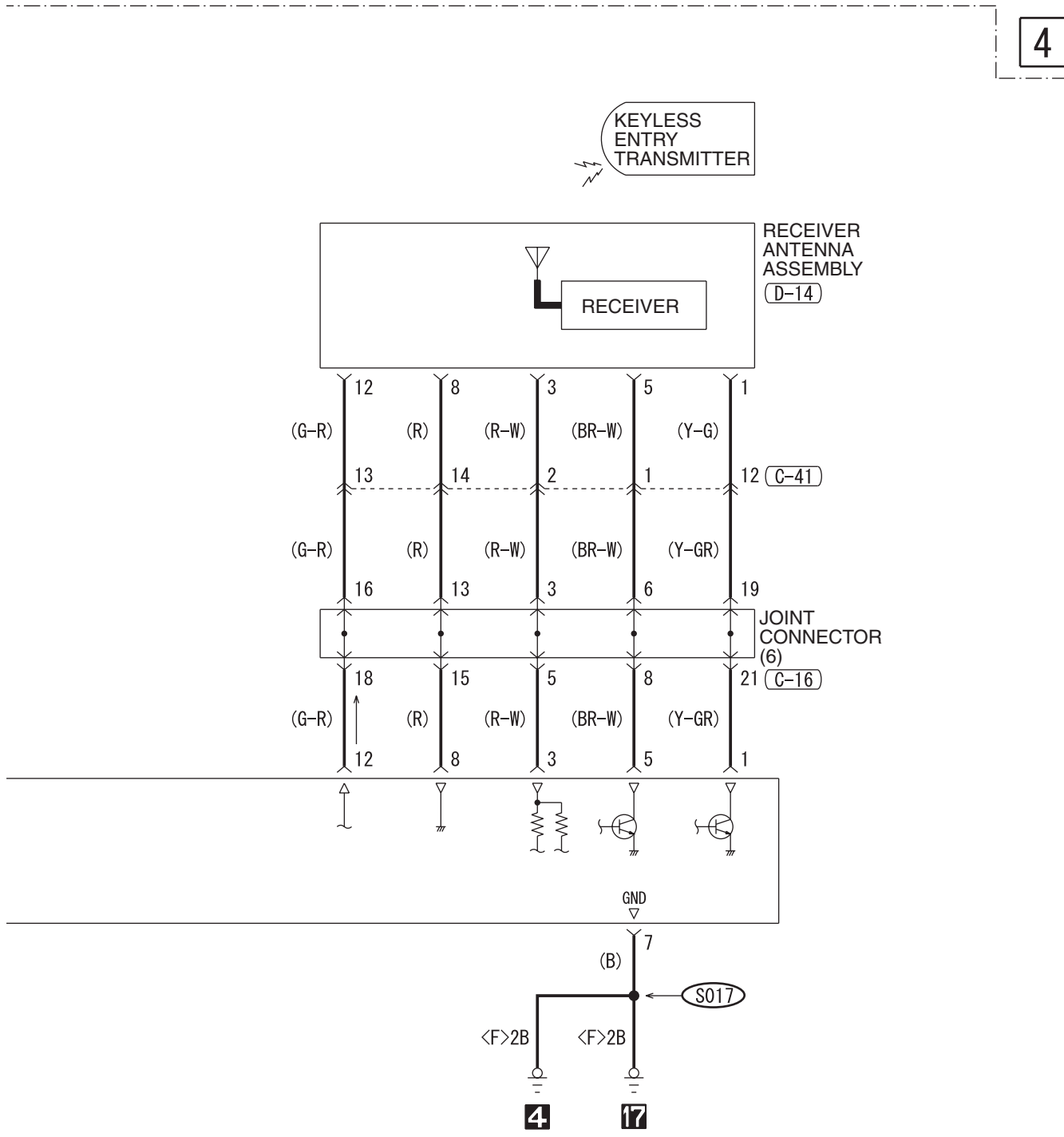

(C-307)

(C-317)

(D-14)

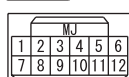
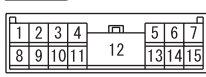

WIRE COLOR CODE

B: BLACK LG: LIGHT GREEN G: GREEN L: BLUE W: WHITE Y: YELLOW SB: SKY BLUE
BR: BROWN O: ORANGE GR: GRAY R: RED P: PINK V: VIOLET PU: PURPLE SI: SILVER

H8G11M11BB

TRUNK LID OPENER (CONTINUED)

5

- ABS, ASC, ACD, AYC AND S-AWC
- AIR CONDITIONING SYSTEM
- AUTO-CRUISE CONTROL SYSTEM
- BRAKE WARNING LIGHT, FUEL WARNING LIGHT AND OIL PRESSURE WARNING LIGHT
- CHARGING SYSTEM
- COOLING SYSTEM
- DAYTIME RUNNING LIGHT (DRL)
- DOOR AJAR WARNING TONE ALARM
- FOG LIGHT
- HEADLIGHT
- HEATED DOOR MIRROR
- HEATED SEAT
- IGNITION KEY REMINDER TONE ALARM
- IMMOBILIZER SYSTEM
- METER AND GAUGE
- MFI SYSTEM
- PARKING BRAKE WARNING TONE ALARM
- REAR WINDOW DEFOGGER
- SEAT BELT WARNING TONE ALARM
- SHIFT LOCK MECHANISM
- SUNROOF
- SUPPLEMENTAL RESTRAINT SYSTEM (SRS)
- TAILLIGHT, POSITION LIGHT, LICENSE PLATE LIGHT AND LIGHTING MONITOR TONE ALARM
- TC-SST
- THEFT-ALARM SYSTEM
- TIRE PRESSURE MONITORING SYSTEM (TPMS)
- TURN-SIGNAL LIGHT AND HAZARD WARNING LIGHT
- WINDSHIELD WIPER AND WASHER

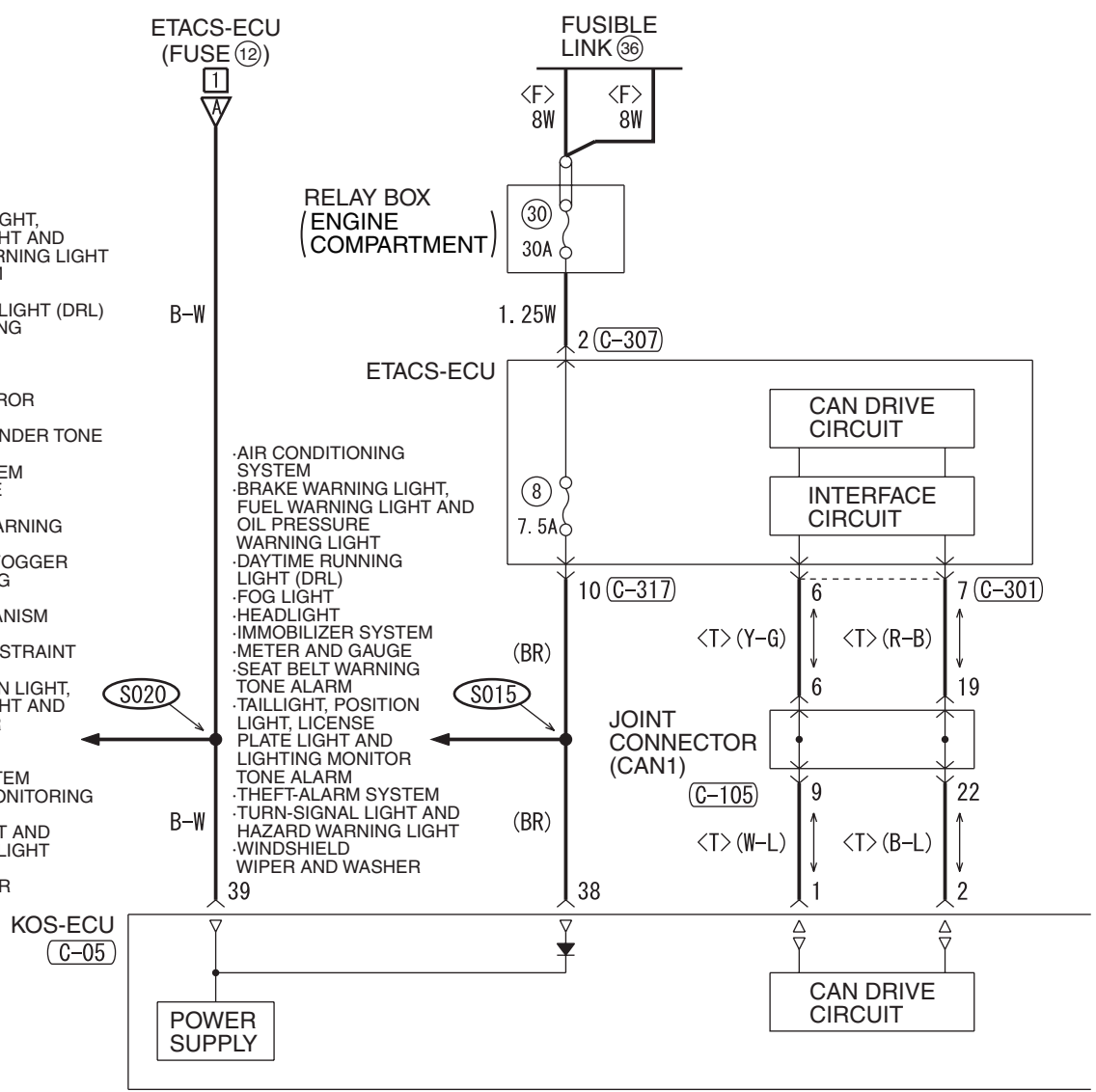

<VEHICLES WITH KOS>

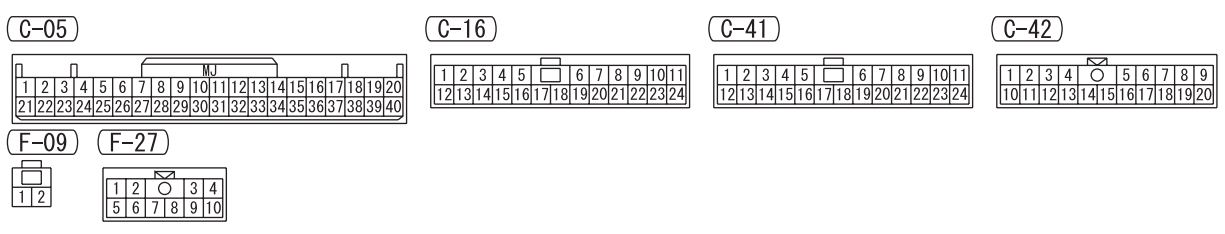

6

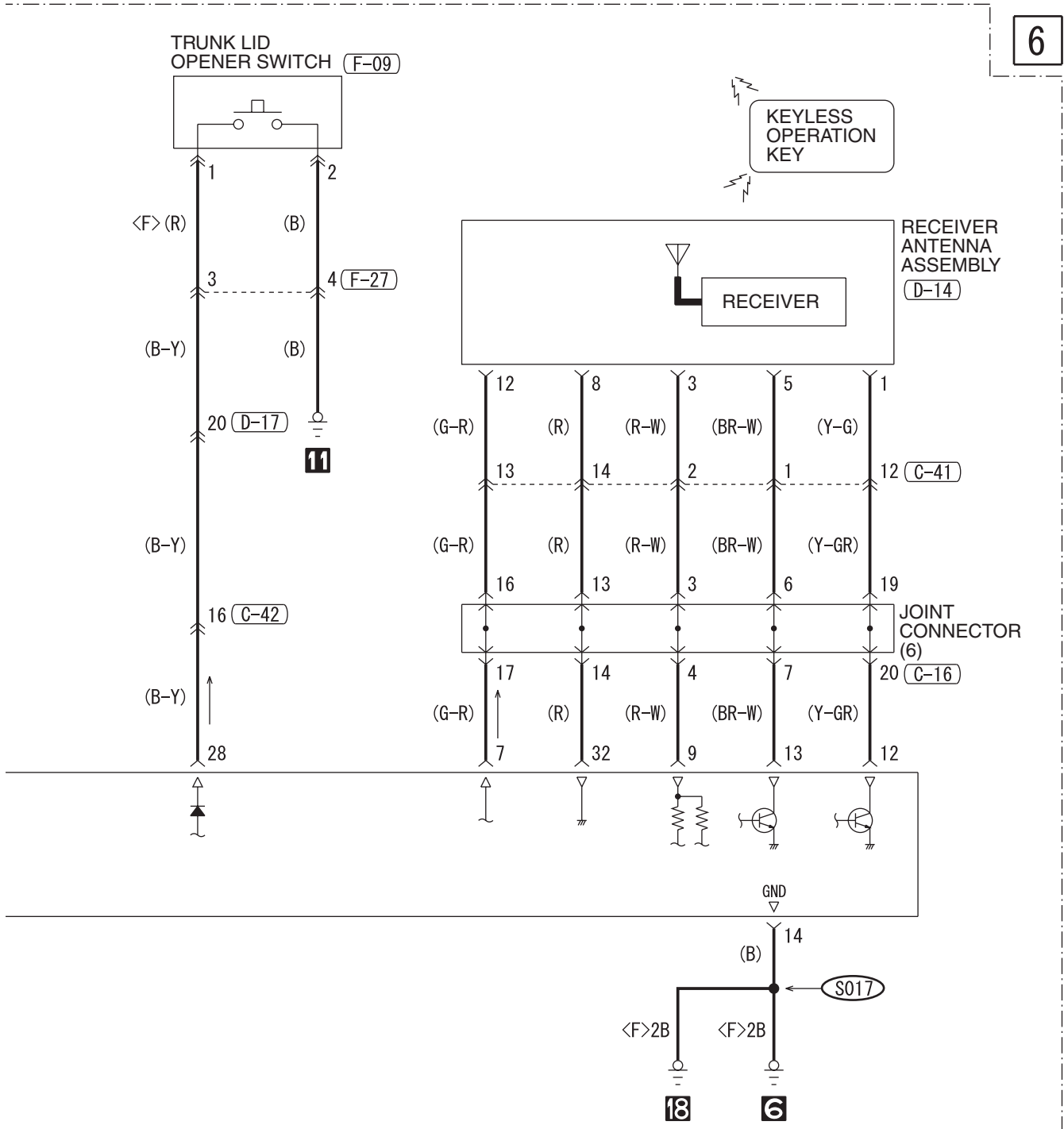

(C-105)

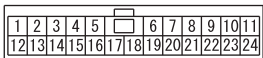

(C-301)

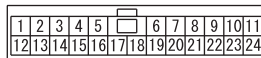

(C-307)



(C-317)

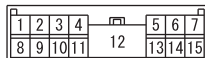

(D-14)

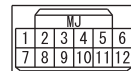

(D-17)

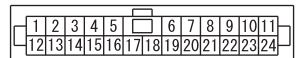

WIRE COLOR CODE

B: BLACK LG: LIGHT GREEN G: GREEN L: BLUE W: WHITE Y: YELLOW SB: SKY BLUE
BR: BROWN O: ORANGE GR: GRAY R: RED P: PINK V: VIOLET PU: PURPLE SI: SILVER

H8G11M11CB

AIR CONDITIONING SYSTEM

M1901032100071

1

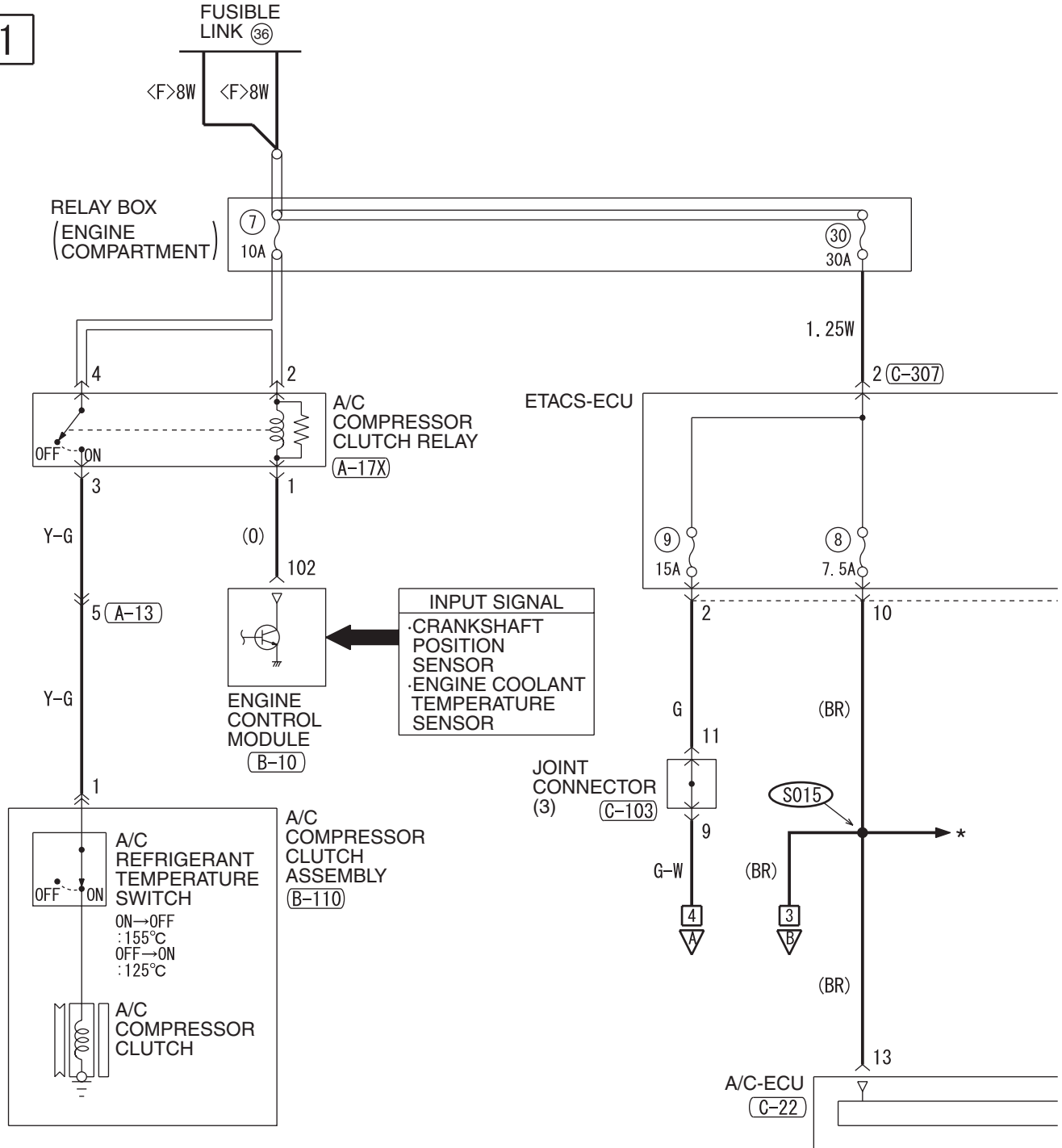

(A-13)

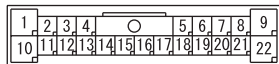

(A-17X) (B-10)

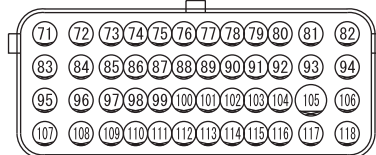

(B-110)



(C-22)

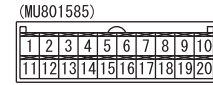

(C-40) FRONT SIDE

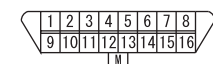

H8G12M03AA

TSB Revision

2

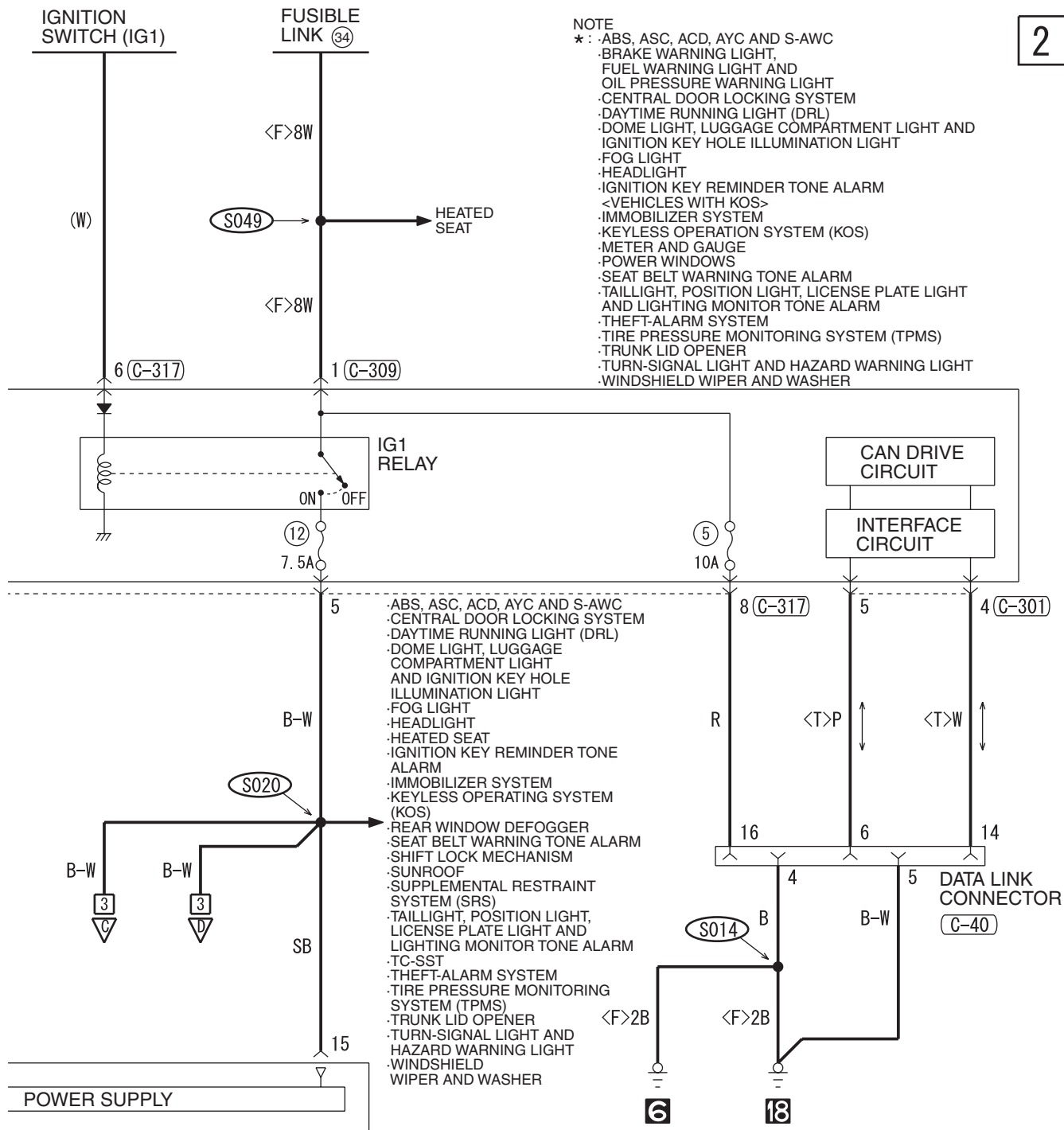

(C-103)

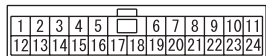

(C-301)

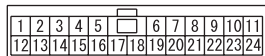

(C-307)



(C-309)



(C-317)

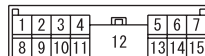

WIRE COLOR CODE

B : BLACK LG : LIGHT GREEN G : GREEN L : BLUE W : WHITE Y : YELLOW SB : SKY BLUE
 BR : BROWN O : ORANGE GR : GRAY R : RED P : PINK V : VIOLET PU : PURPLE SI : SILVER

AIR CONDITIONING SYSTEM (CONTINUED)

3

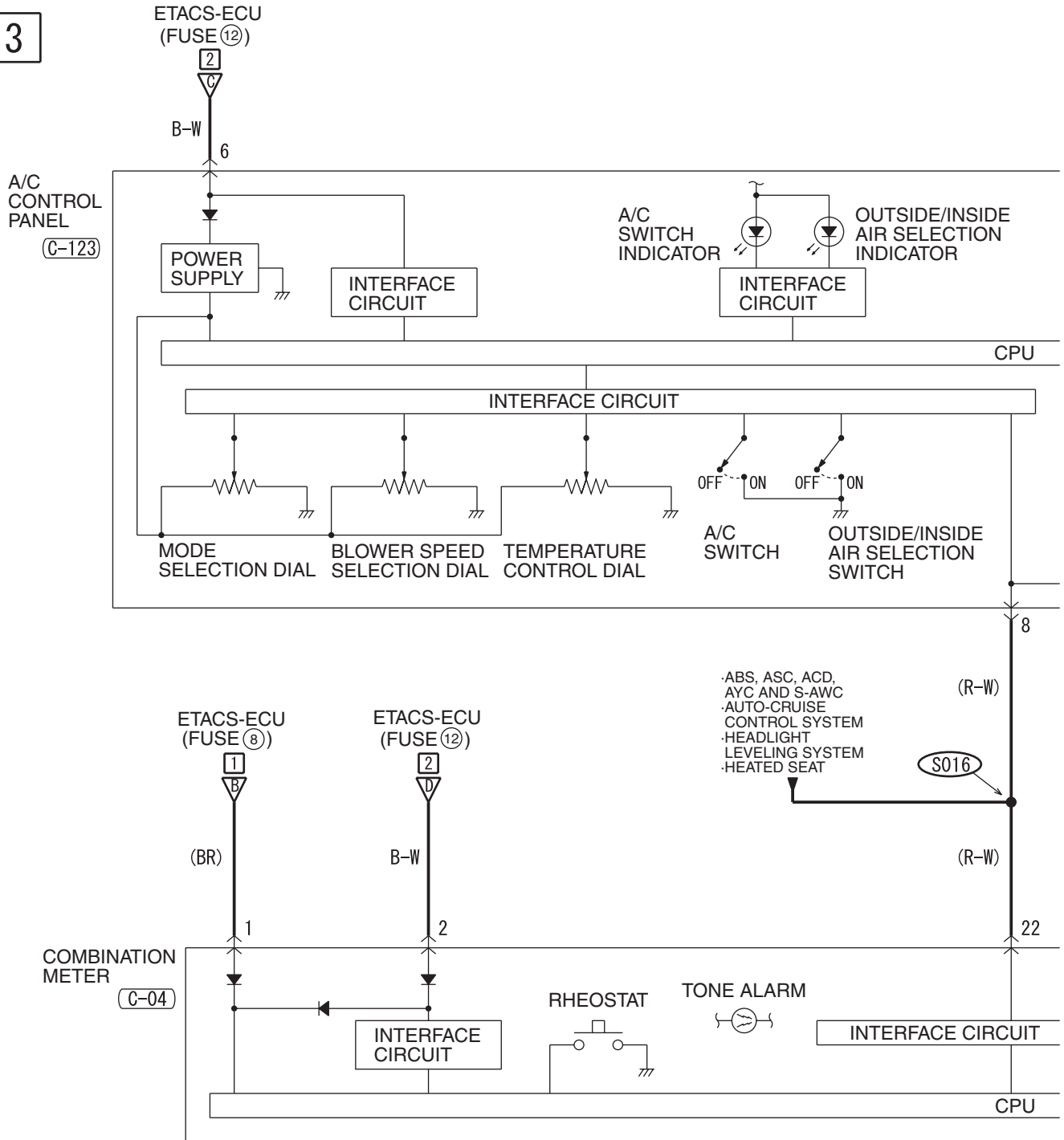

C-04

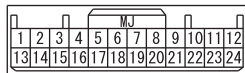

C-123

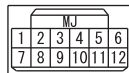

4

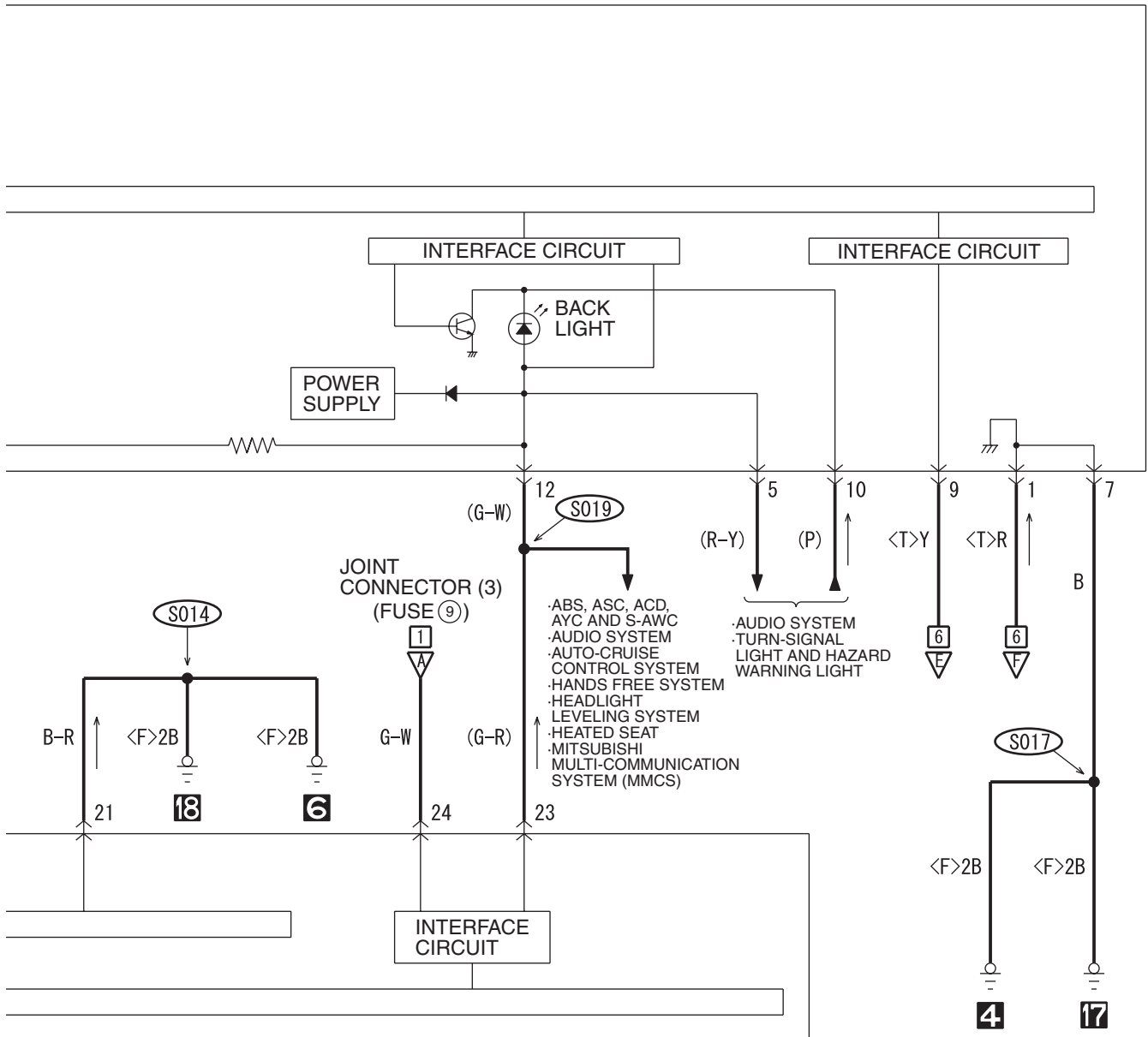

WIRE COLOR CODE
B: BLACK LG: LIGHT GREEN G: GREEN L: BLUE W: WHITE Y: YELLOW SB: SKY BLUE
BR: BROWN O: ORANGE GR: GRAY R: RED P: PINK V: VIOLET PU: PURPLE SI: SILVER

H8G12M03BB

TSB Revision

AIR CONDITIONING SYSTEM (CONTINUED)

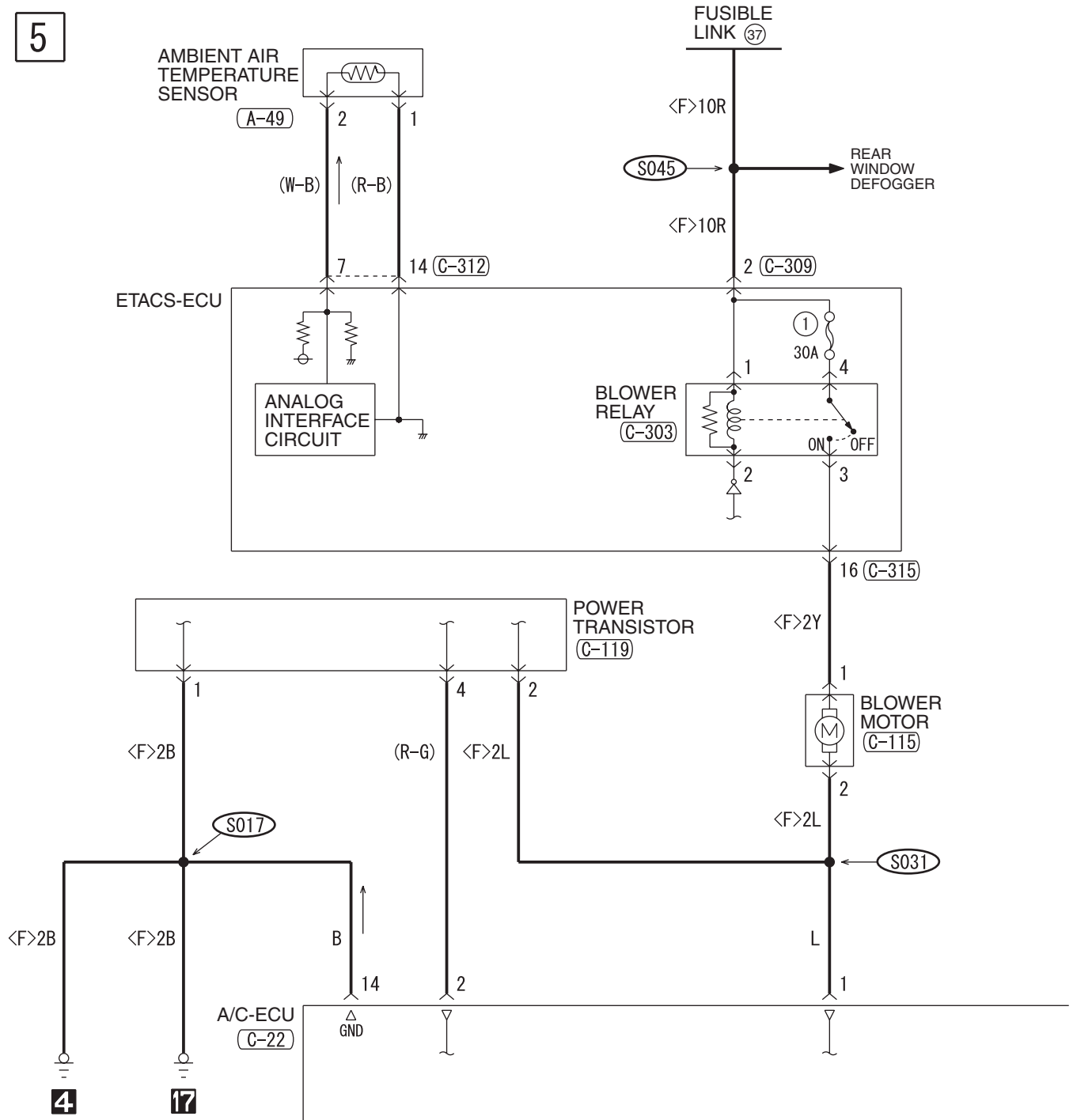

- A-49**
 MU802777
- A-53**
 (MU802509)
- C-03**
- C-06**
 MU801669
- C-22**
 (MU801585)
- C-102**
- C-115**
 MU801325
- C-119**
- C-131**
- C-303**

6

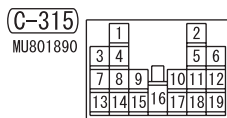
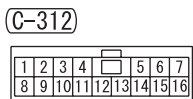
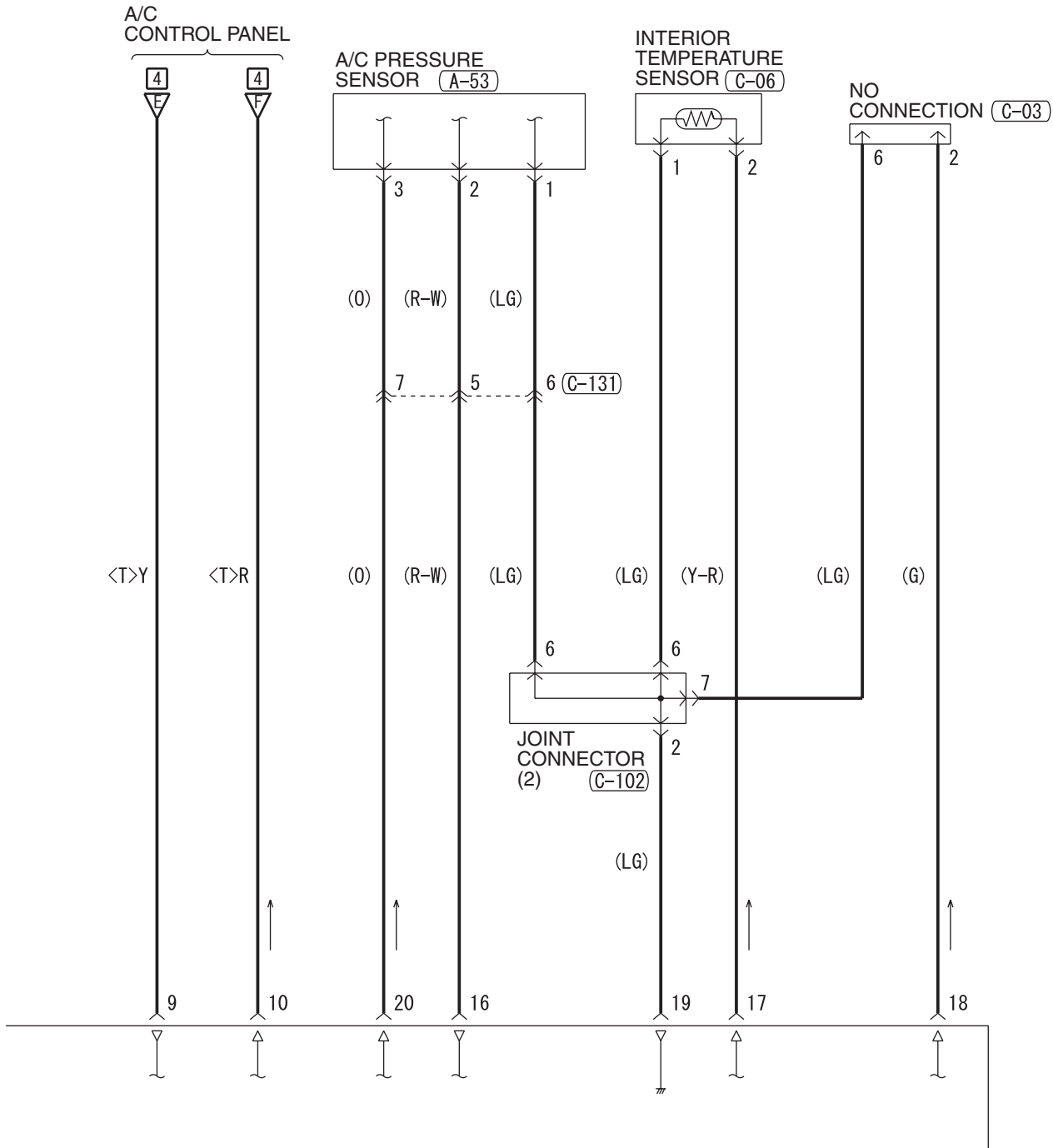

WIRE COLOR CODE
 B: BLACK LG: LIGHT GREEN G: GREEN L: BLUE W: WHITE Y: YELLOW SB: SKY BLUE
 BR: BROWN O: ORANGE GR: GRAY R: RED P: PINK V: VIOLET PU: PURPLE SI: SILVER

H8G12M03CB

AIR CONDITIONING SYSTEM (CONTINUED)

7

A/C-ECU
(C-20)

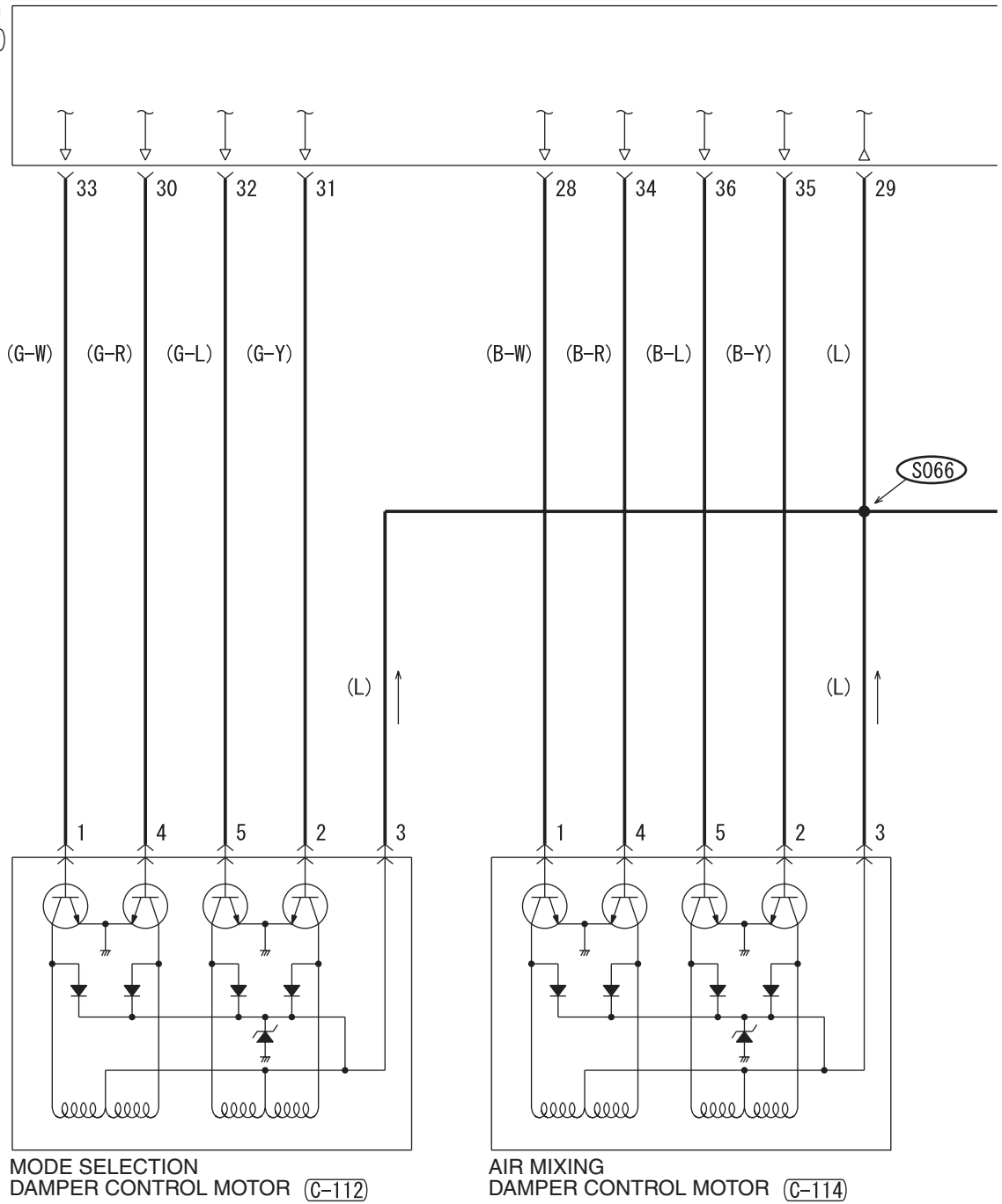

(C-20)

(MU801584)

21	22	23	24	25	26	27	28
29	30	31	32	33	34	35	36

(C-111)

1	2	3	4	5
---	---	---	---	---

(C-112)

1	2	3	4	5
---	---	---	---	---

(C-113)

1
2

(C-114)

1	2	3	4	5
---	---	---	---	---

8

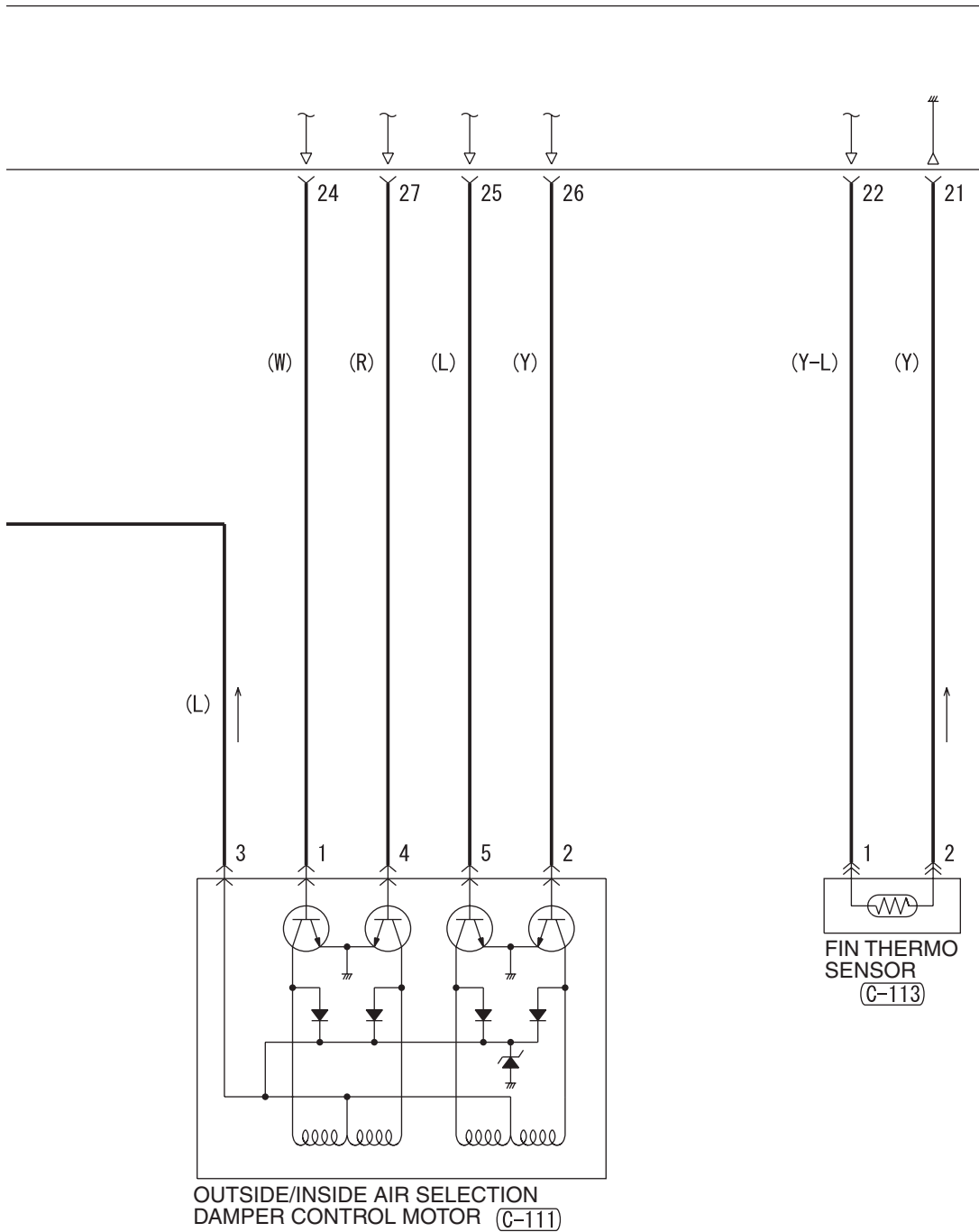

WIRE COLOR CODE
 B : BLACK LG : LIGHT GREEN G : GREEN L : BLUE W : WHITE Y : YELLOW SB : SKY BLUE
 BR : BROWN O : ORANGE GR : GRAY R : RED P : PINK V : VIOLET PU : PURPLE SI : SILVER

H8G12M03DB

TSB Revision

AIR CONDITIONING SYSTEM (CONTINUED)

9

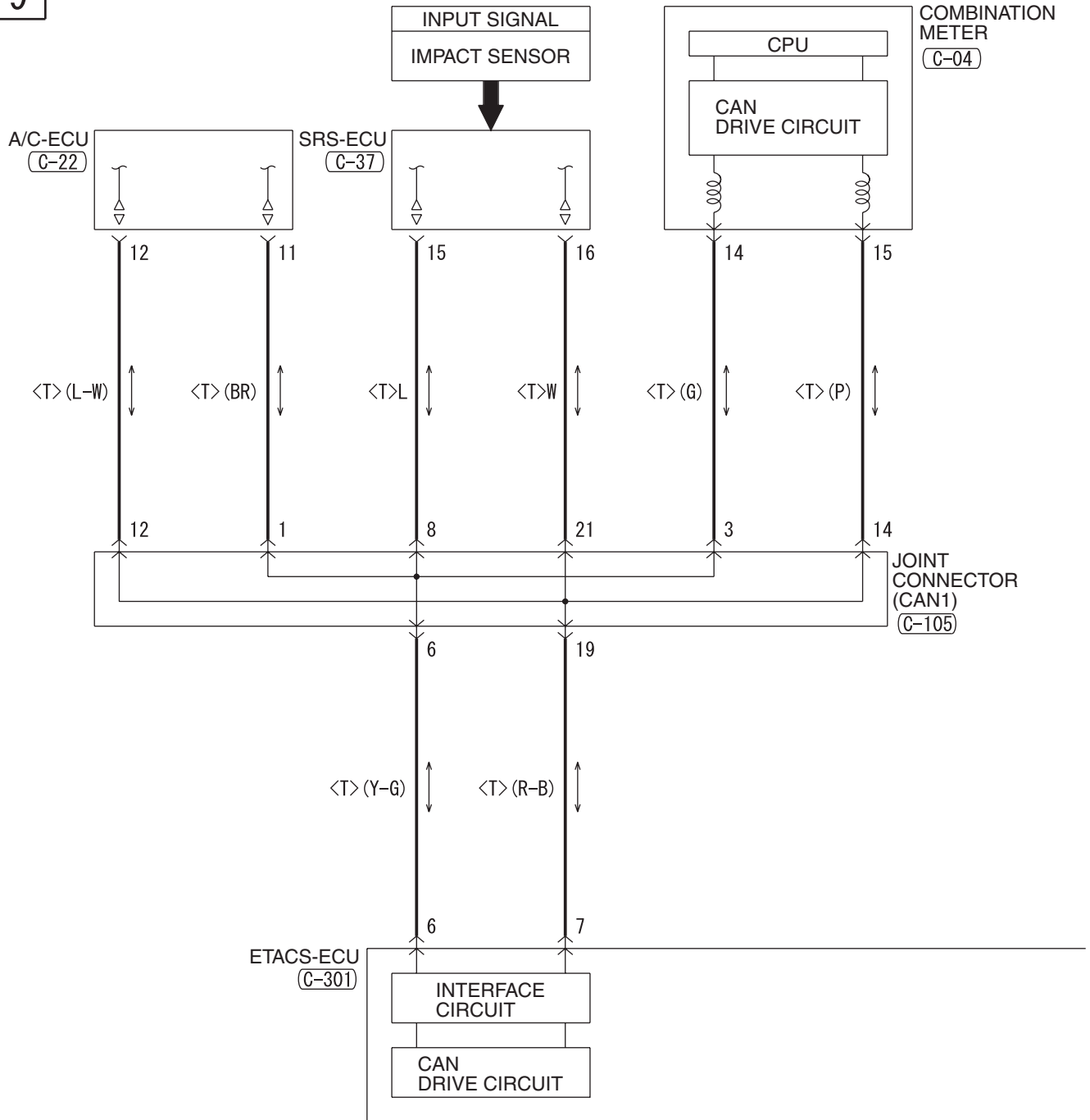

(A-05)

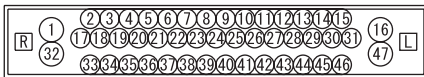

(C-04)

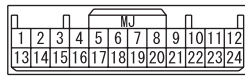

(C-22)

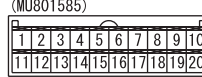

(C-37)

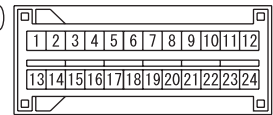

(C-301)

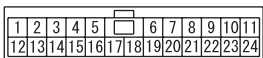

10

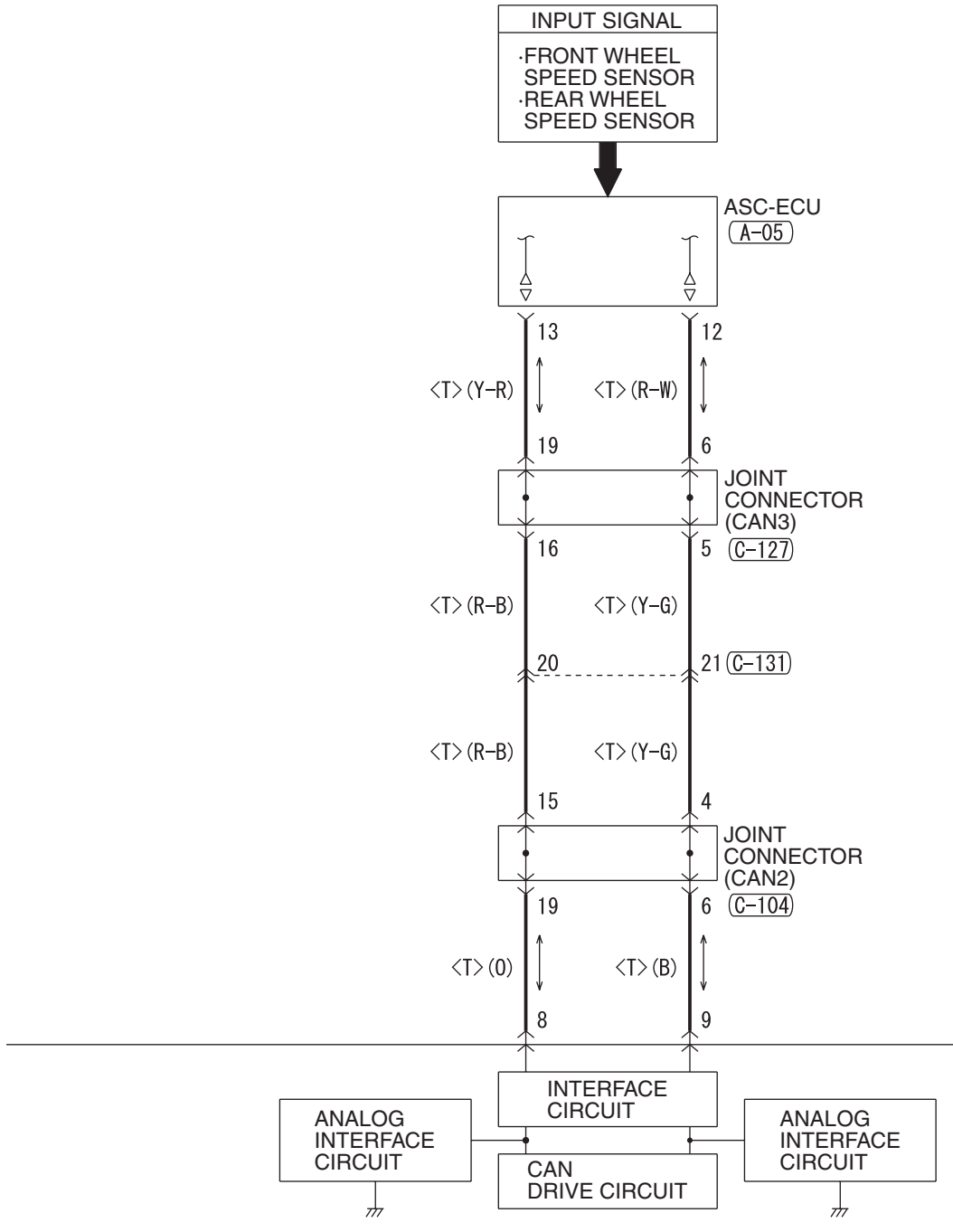

(C-104)

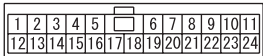

(C-105)

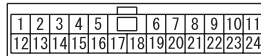

(C-127)

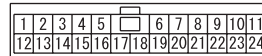

(C-131)

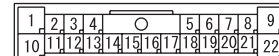

WIRE COLOR CODE

B: BLACK LG: LIGHT GREEN G: GREEN L: BLUE W: WHITE Y: YELLOW SB: SKY BLUE
BR: BROWN O: ORANGE GR: GRAY R: RED P: PINK V: VIOLET PU: PURPLE SI: SILVER

H8G12M03EB

AIR CONDITIONING SYSTEM (CONTINUED)

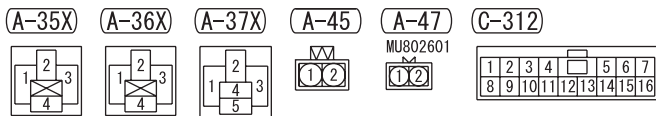
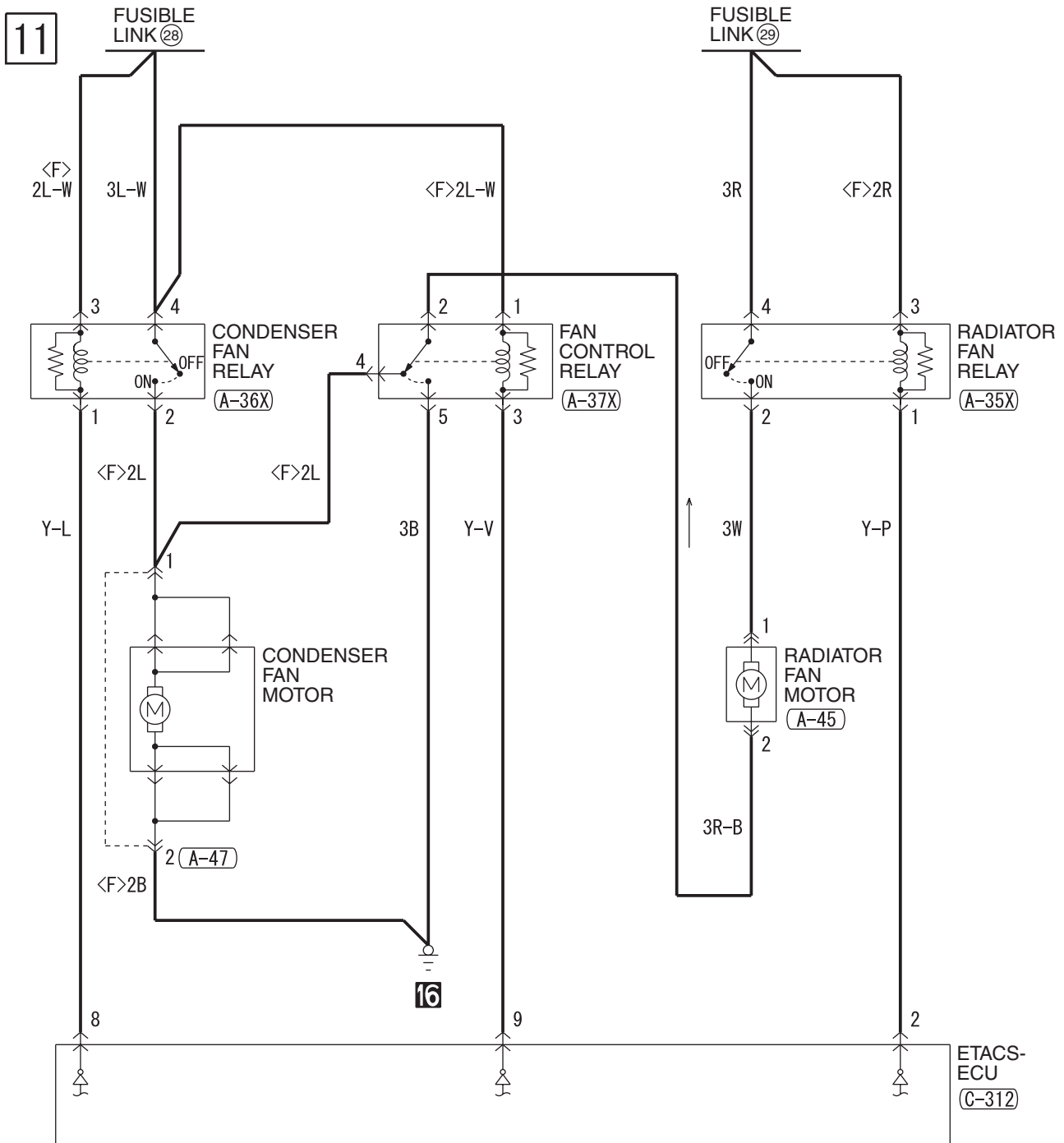

WIRE COLOR CODE
 B: BLACK LG: LIGHT GREEN G: GREEN L: BLUE W: WHITE Y: YELLOW SB: SKY BLUE
 BR: BROWN O: ORANGE GR: GRAY R: RED P: PINK V: VIOLET PU: PURPLE SI: SILVER

H8G12M03FA

NOTES

WINDSHIELD WIPER AND WASHER

M1901006103411

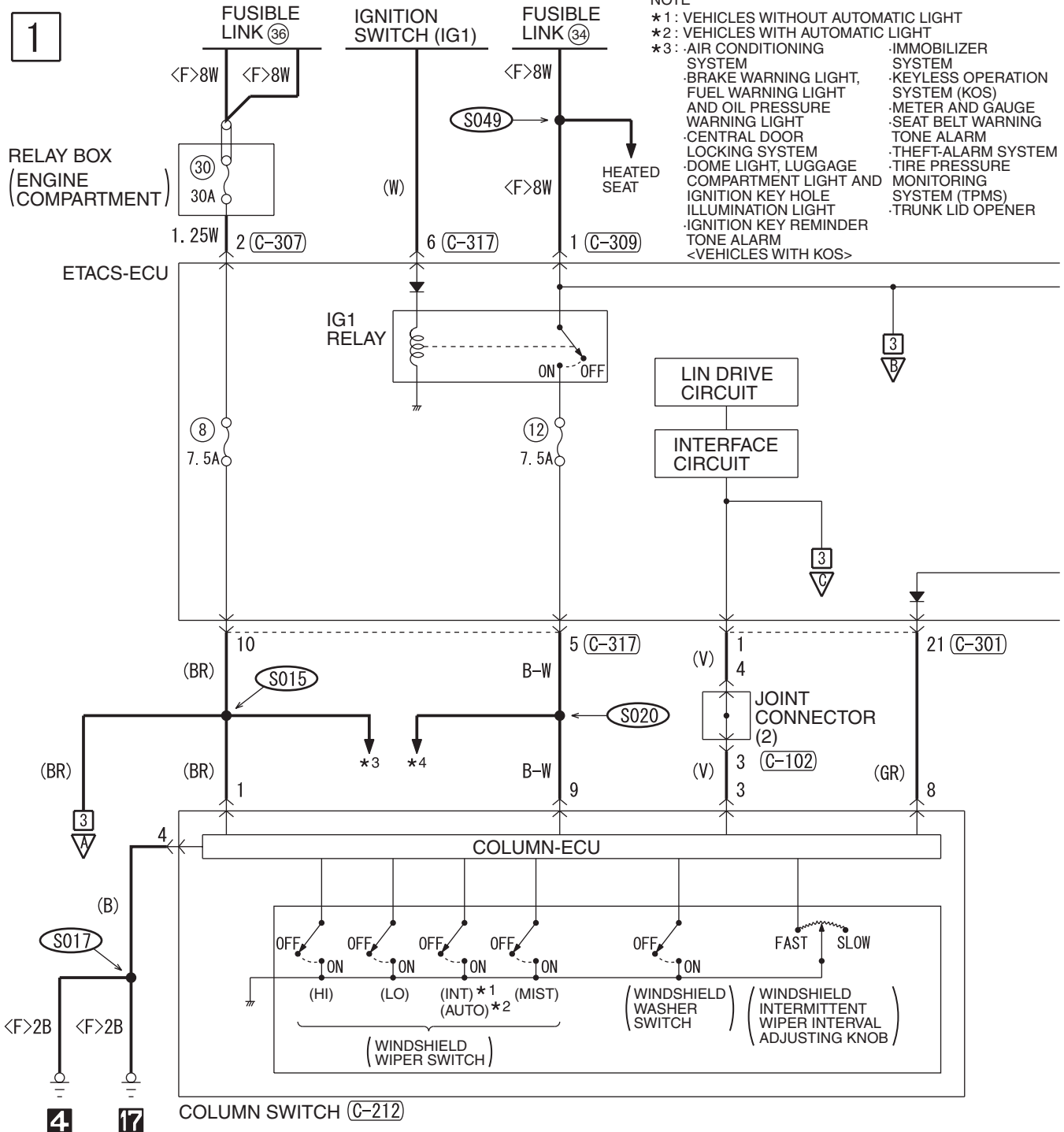

- *4: ·ABS, ASC, ACD, AYC AND S-AWC
 ·AIR CONDITIONING SYSTEM
 ·AUTO-CRUISE CONTROL SYSTEM
 ·BRAKE WARNING LIGHT, FUEL WARNING LIGHT AND OIL PRESSURE WARNING LIGHT
 ·CENTRAL DOOR LOCKING SYSTEM
 ·CHARGING SYSTEM
 ·COOLING SYSTEM
 ·DAYTIME RUNNING LIGHT (DRL)

- DOME LIGHT, LUGGAGE COMPARTMENT LIGHT AND IGNITION KEY HOLE ILLUMINATION LIGHT
 ·DOOR AJAR WARNING TONE ALARM
 ·FOG LIGHT
 ·HEADLIGHT
 ·HEATED SEAT
 ·IGNITION KEY REMINDER TONE ALARM
 ·IMMOBILIZER SYSTEM
 ·KEYLESS OPERATING SYSTEM (KOS)

- MFI SYSTEM
 ·PARKING BRAKE WARNING TONE ALARM
 ·REAR WINDOW DEFOGGER
 ·SEAT BELT WARNING TONE ALARM
 ·SHIFT LOCK MECHANISM
 ·SUNROOF
 ·SUPPLEMENTAL RESTRAINT SYSTEM (SRS)

- TAILLIGHT, POSITION LIGHT, LICENSE PLATE LIGHT AND LIGHTING MONITOR TONE ALARM
 ·TC-SST
 ·THEFT-ALARM SYSTEM (LG)
 ·TIRE PRESSURE MONITORING SYSTEM (TPMS)
 ·TRUNK LID OPENER
 ·TURN-SIGNAL LIGHT AND HAZARD WARNING LIGHT

2

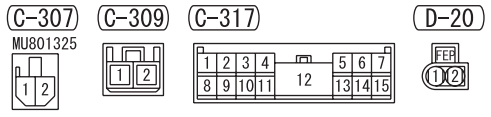
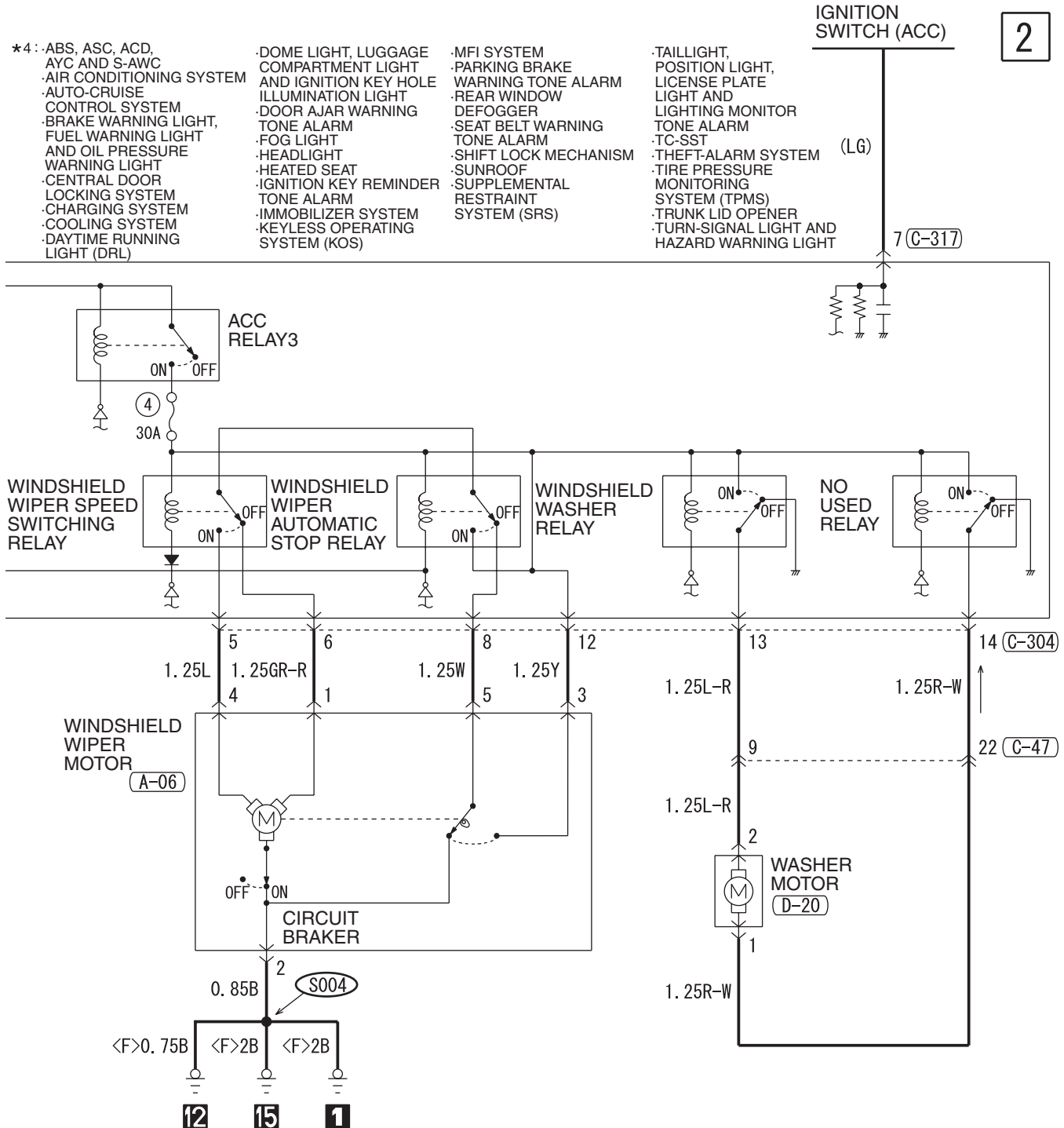

WIRE COLOR CODE
 B: BLACK LG: LIGHT GREEN G: GREEN L: BLUE W: WHITE Y: YELLOW SB: SKY BLUE
 BR: BROWN O: ORANGE GR: GRAY R: RED P: PINK V: VIOLET PU: PURPLE SI: SILVER

WINDSHIELD WIPER AND WASHER (CONTINUED)

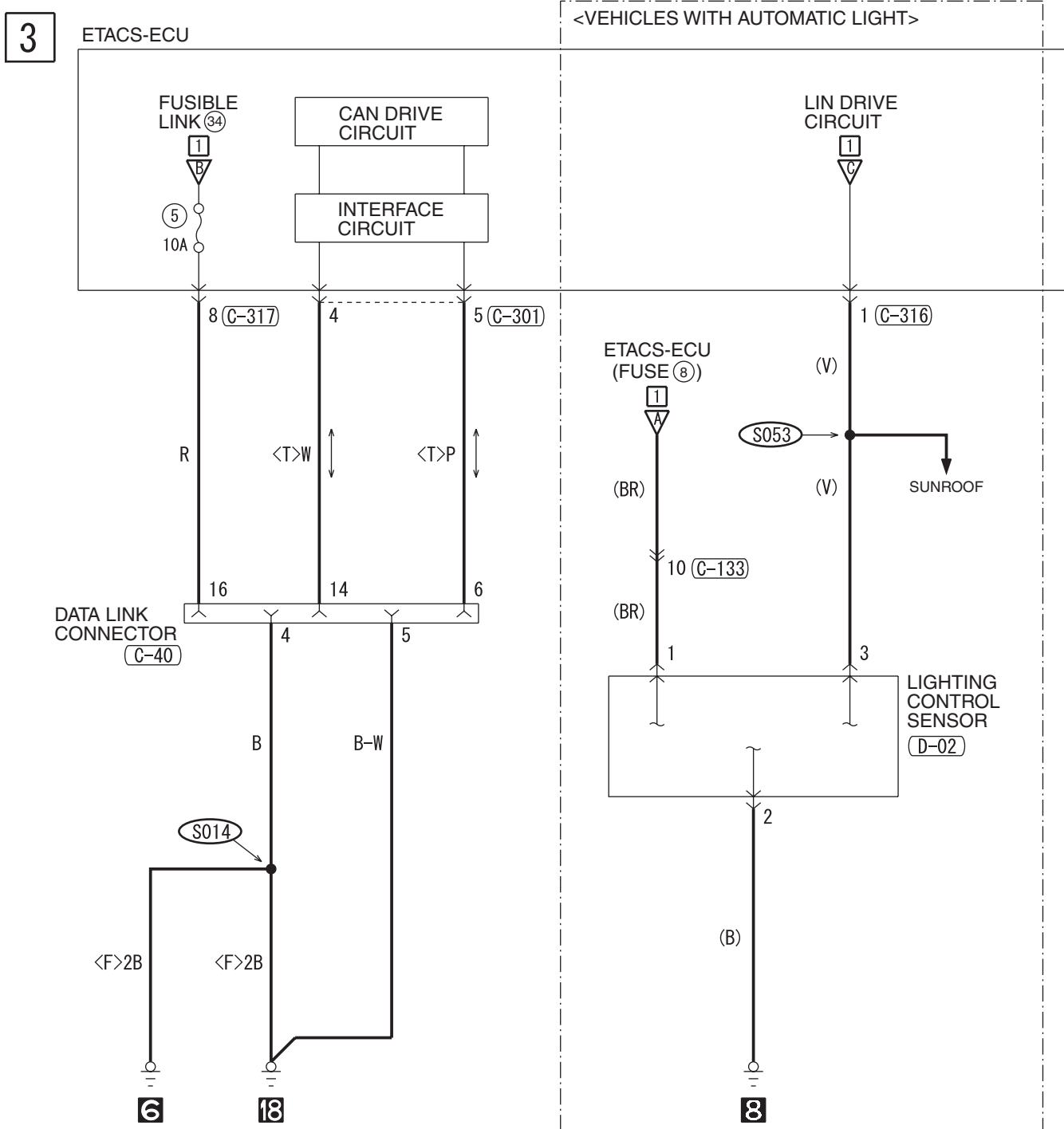

(A-05)

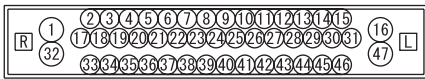

(C-40) FRONT SIDE



(C-104)

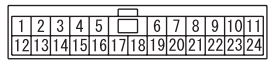

(C-127)

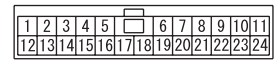

4

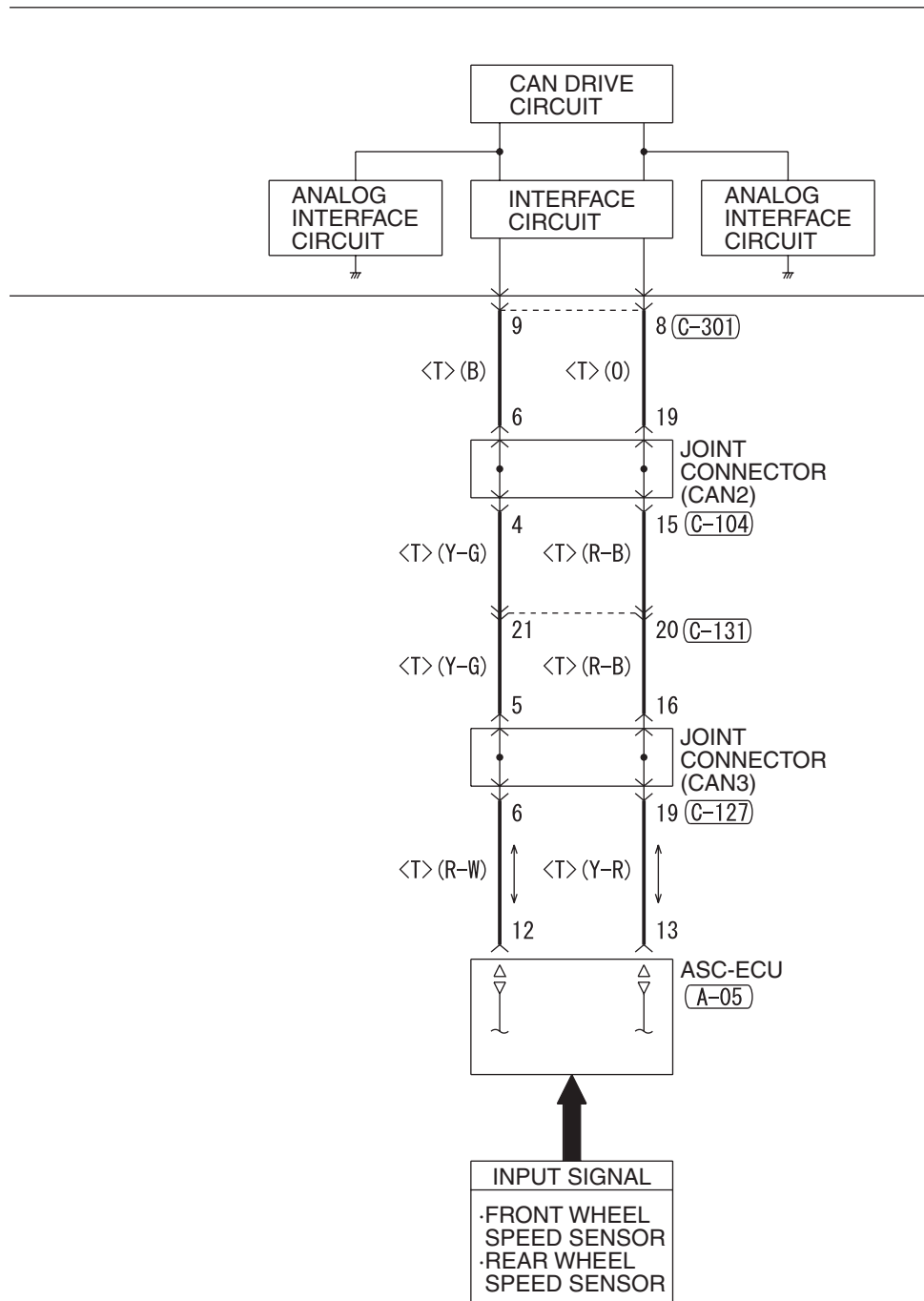

(C-131)

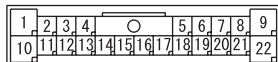

(C-133)

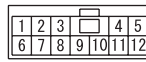

(C-301)

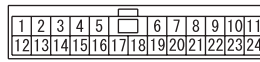

(C-316)



(C-317)



(D-02)



WIRE COLOR CODE

B : BLACK LG : LIGHT GREEN G : GREEN L : BLUE W : WHITE Y : YELLOW SB : SKY BLUE
BR : BROWN O : ORANGE GR : GRAY R : RED P : PINK V : VIOLET PU : PURPLE SI : SILVER

H8G13M11BB

TSB Revision

REMOTE CONTROLLED MIRROR

M1901006502416

1

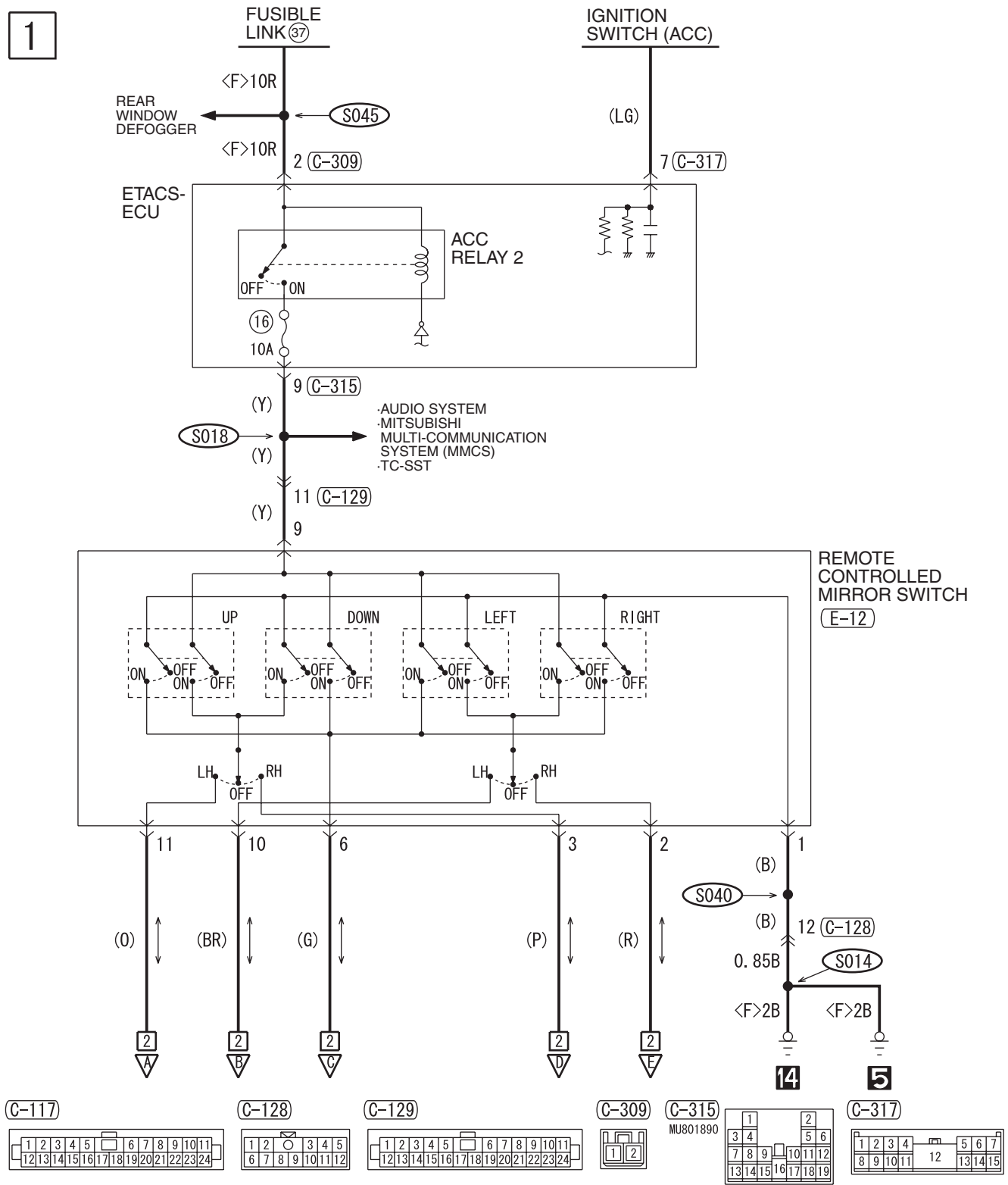

2

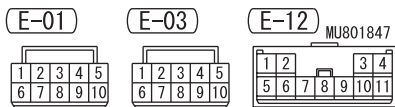
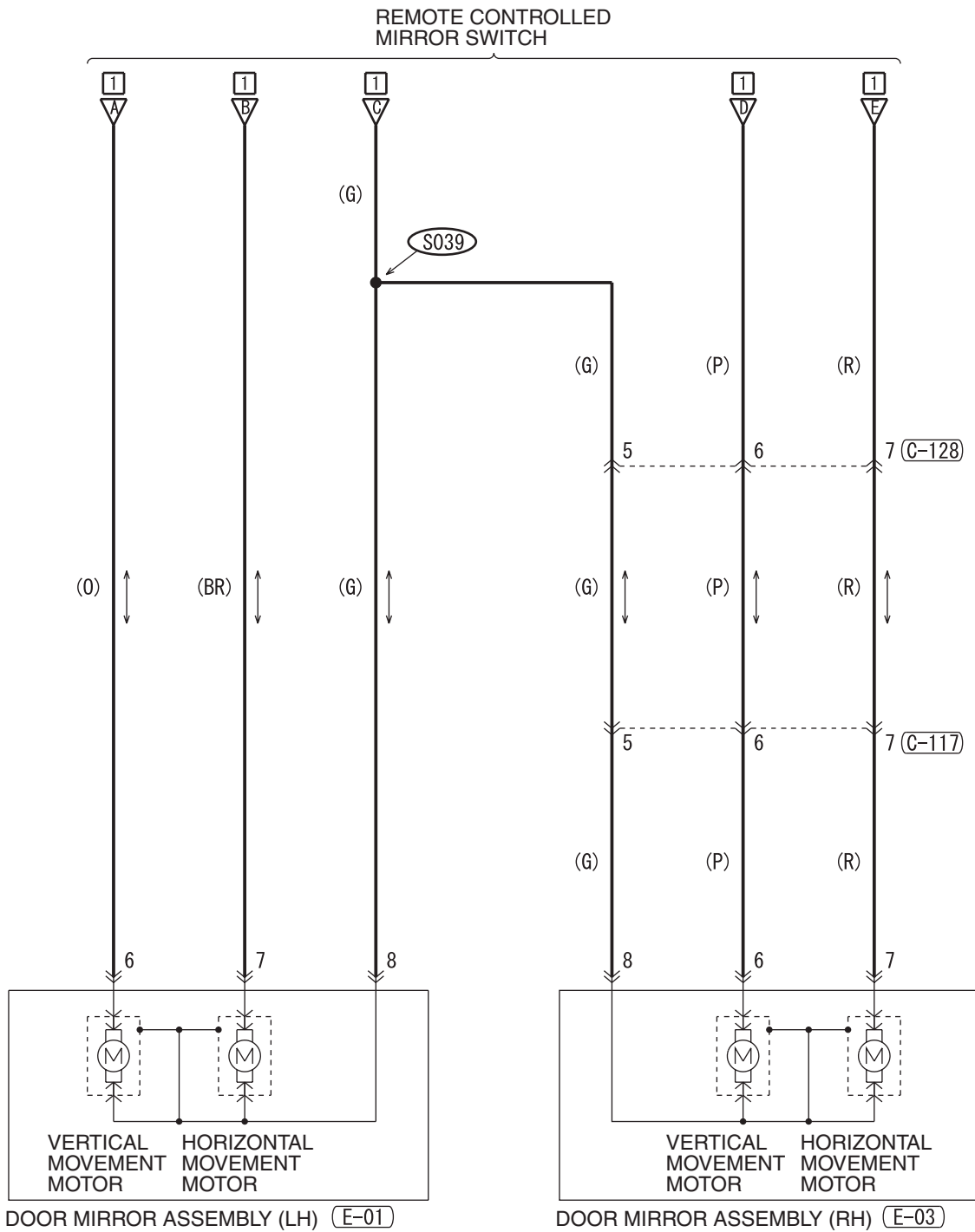

WIRE COLOR CODE
 B: BLACK LG: LIGHT GREEN G: GREEN L: BLUE W: WHITE Y: YELLOW SB: SKY BLUE
 BR: BROWN O: ORANGE GR: GRAY R: RED P: PINK V: VIOLET PU: PURPLE SI: SILVER

H8G13M12AB

REAR WINDOW DEFOGGER

M1901006401922

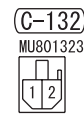
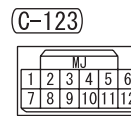
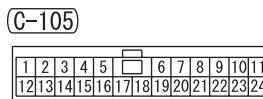
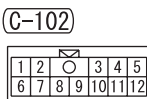
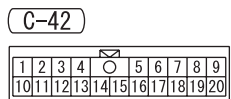
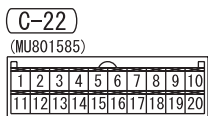
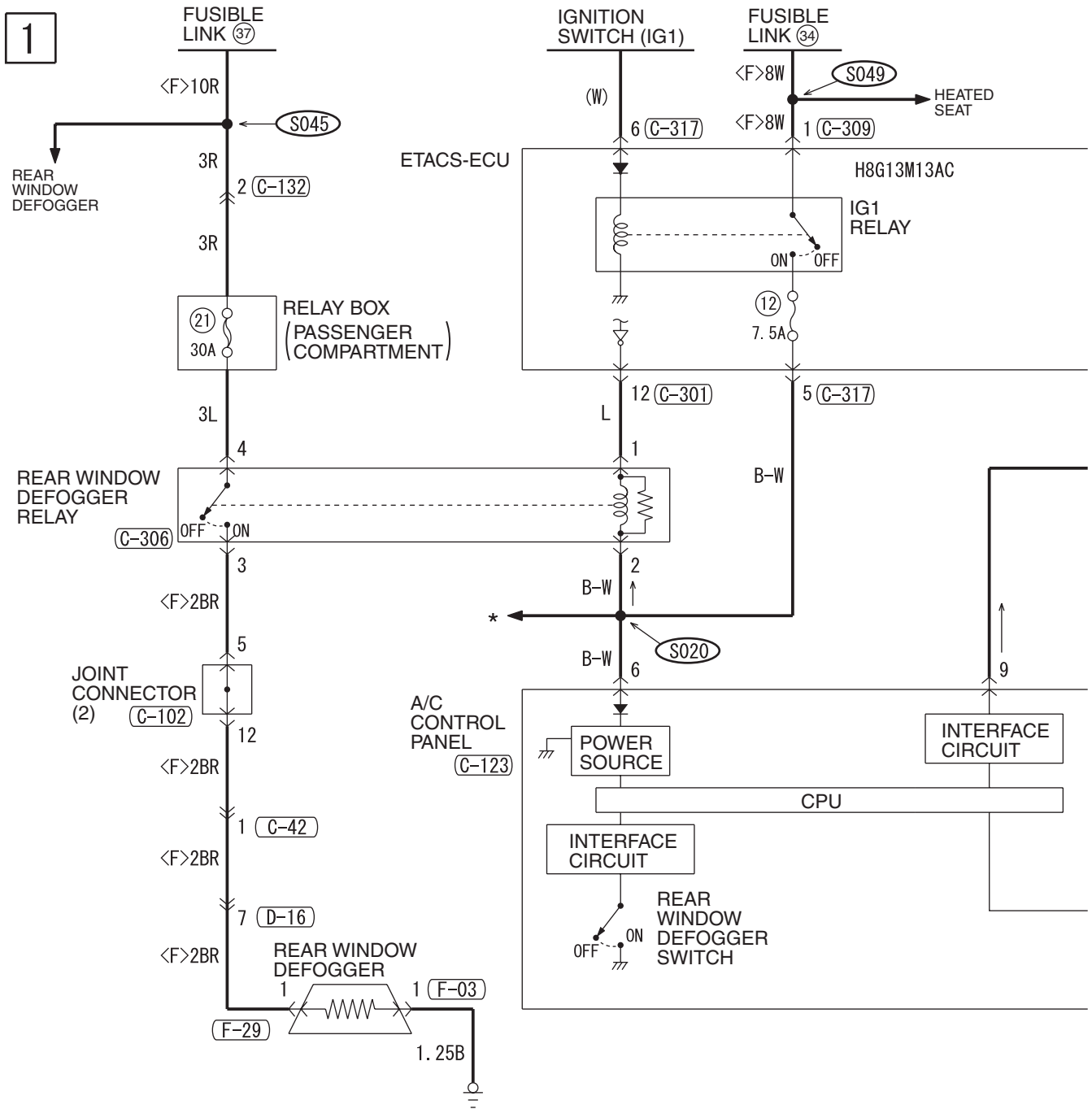

H8G13M13AA

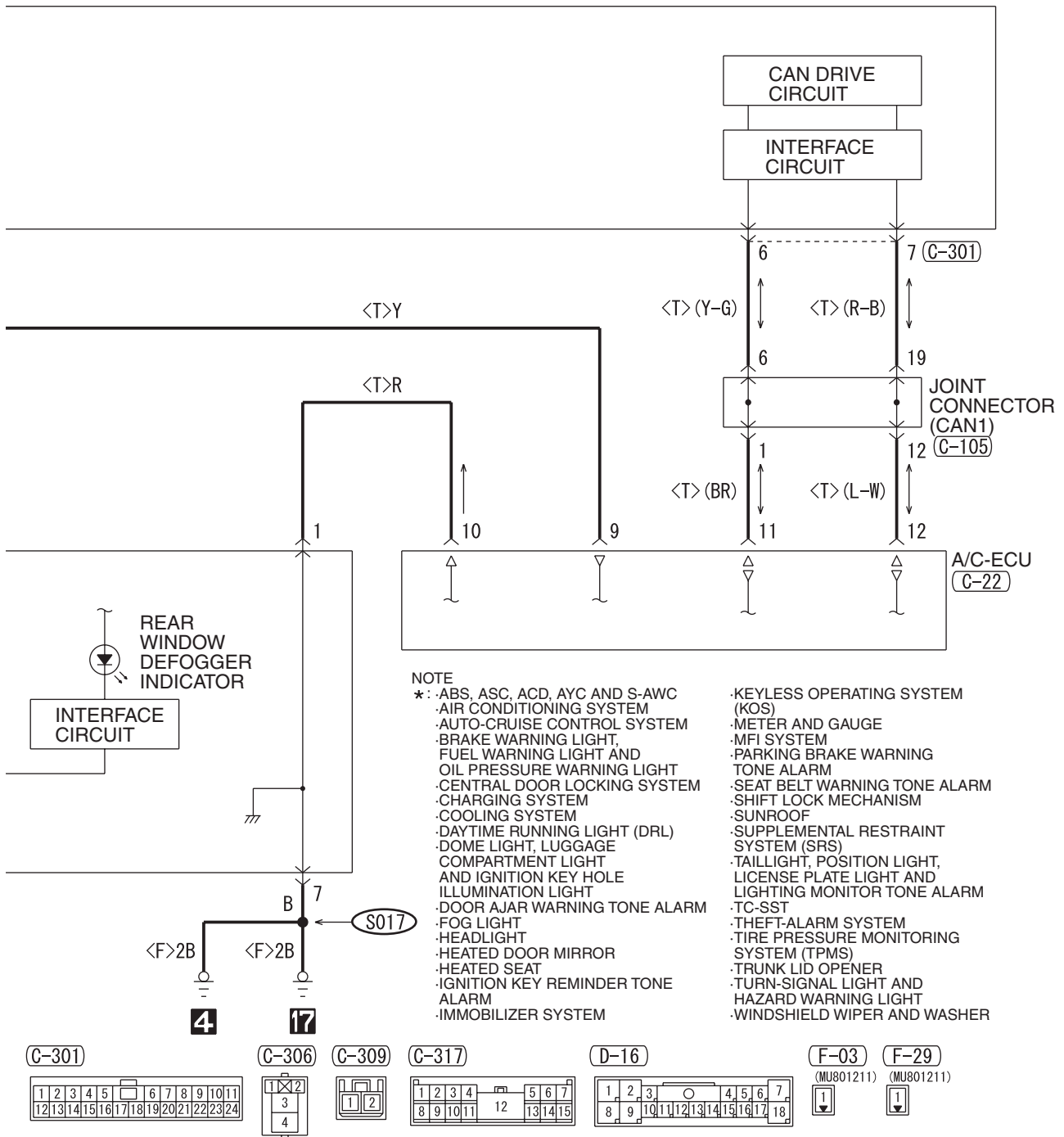

WIRE COLOR CODE
 B : BLACK LG : LIGHT GREEN G : GREEN L : BLUE W : WHITE Y : YELLOW SB : SKY BLUE
 BR : BROWN O : ORANGE GR : GRAY R : RED P : PINK V : VIOLET PU : PURPLE SI : SILVER

H8G13M13AB

AUDIO SYSTEM <VEHICLES WITHOUT AUDIO AMPLIFIER>

M1901015603674

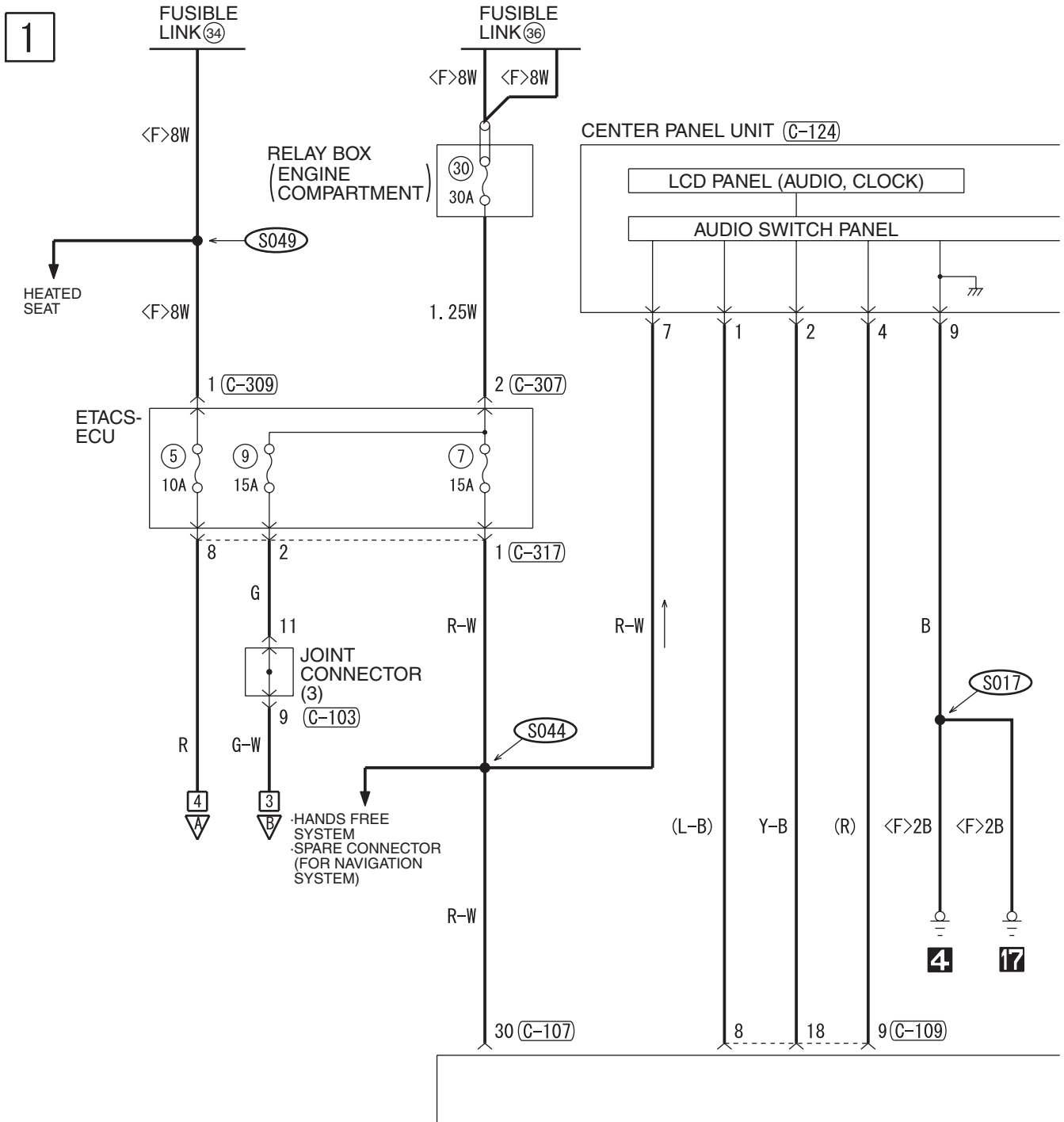

(C-101)

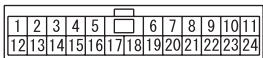

(C-103)

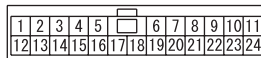

(C-107)

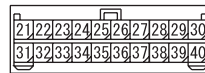

(C-109)

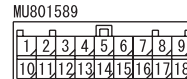

(C-118)



(C-123)

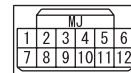

2

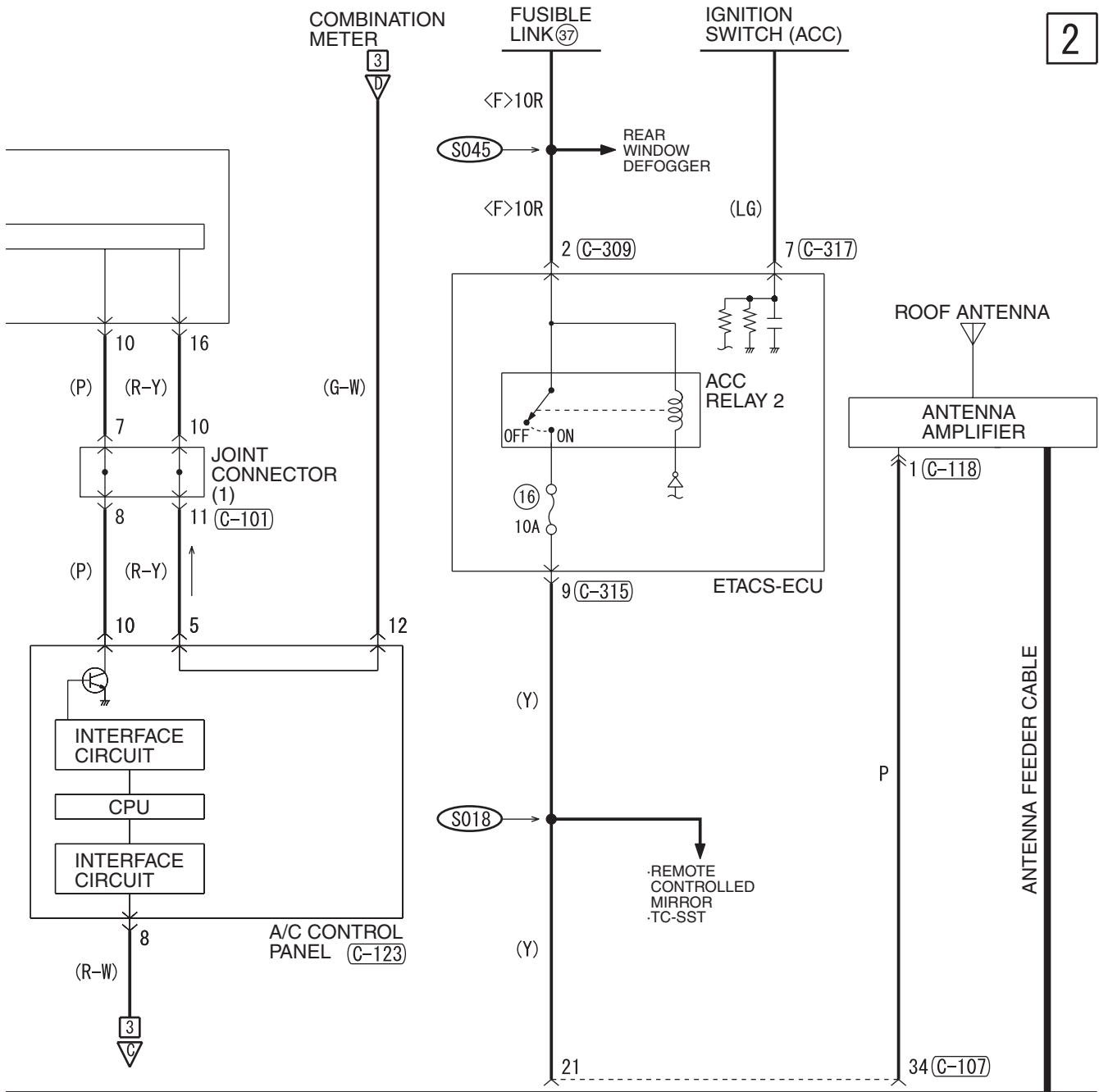

<NO CONNECTION>

RADIO AND CD PLAYER

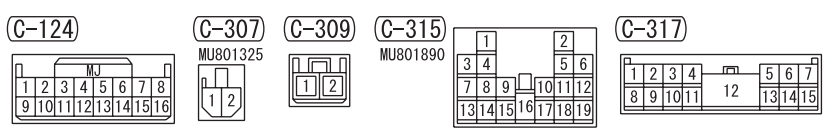

WIRE COLOR CODE
 B : BLACK LG : LIGHT GREEN G : GREEN L : BLUE W : WHITE Y : YELLOW SB : SKY BLUE
 BR : BROWN O : ORANGE GR : GRAY R : RED P : PINK V : VIOLET PU : PURPLE SI : SILVER

AUDIO SYSTEM <VEHICLES WITHOUT AUDIO AMPLIFIER> (CONTINUED)

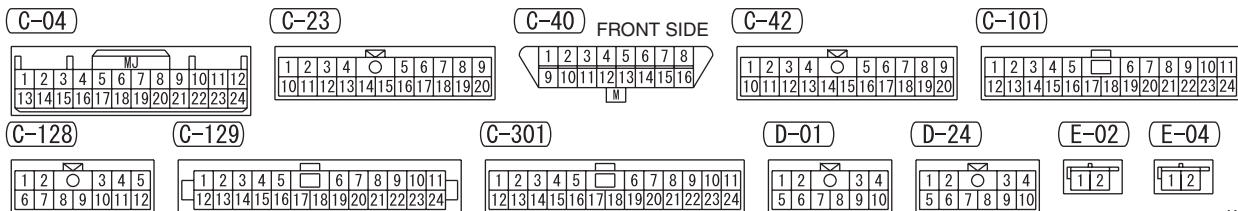
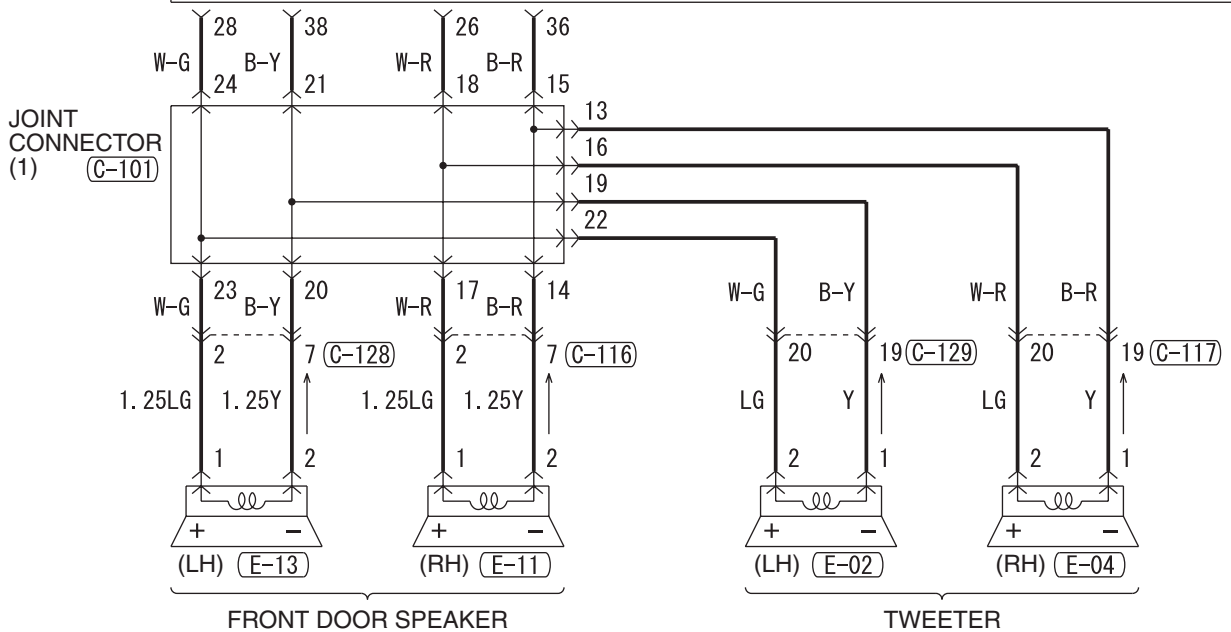
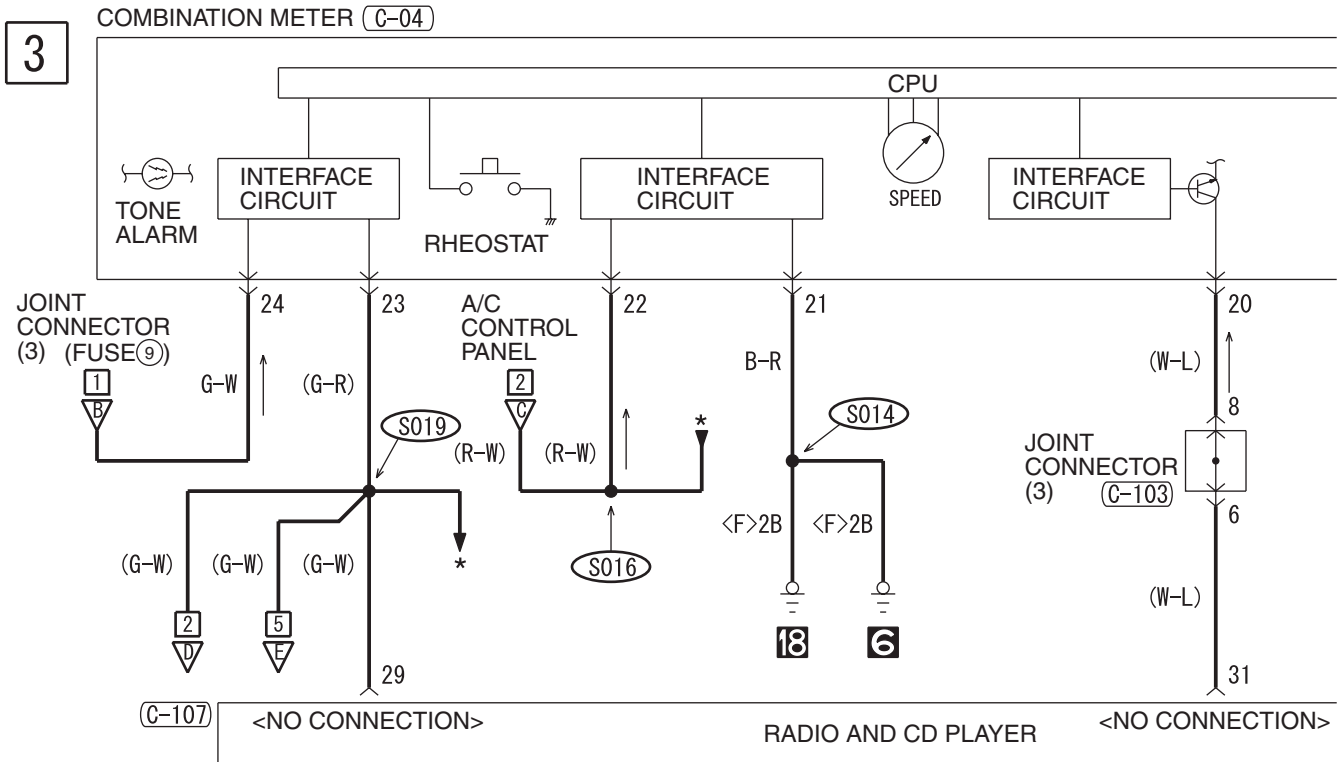

4

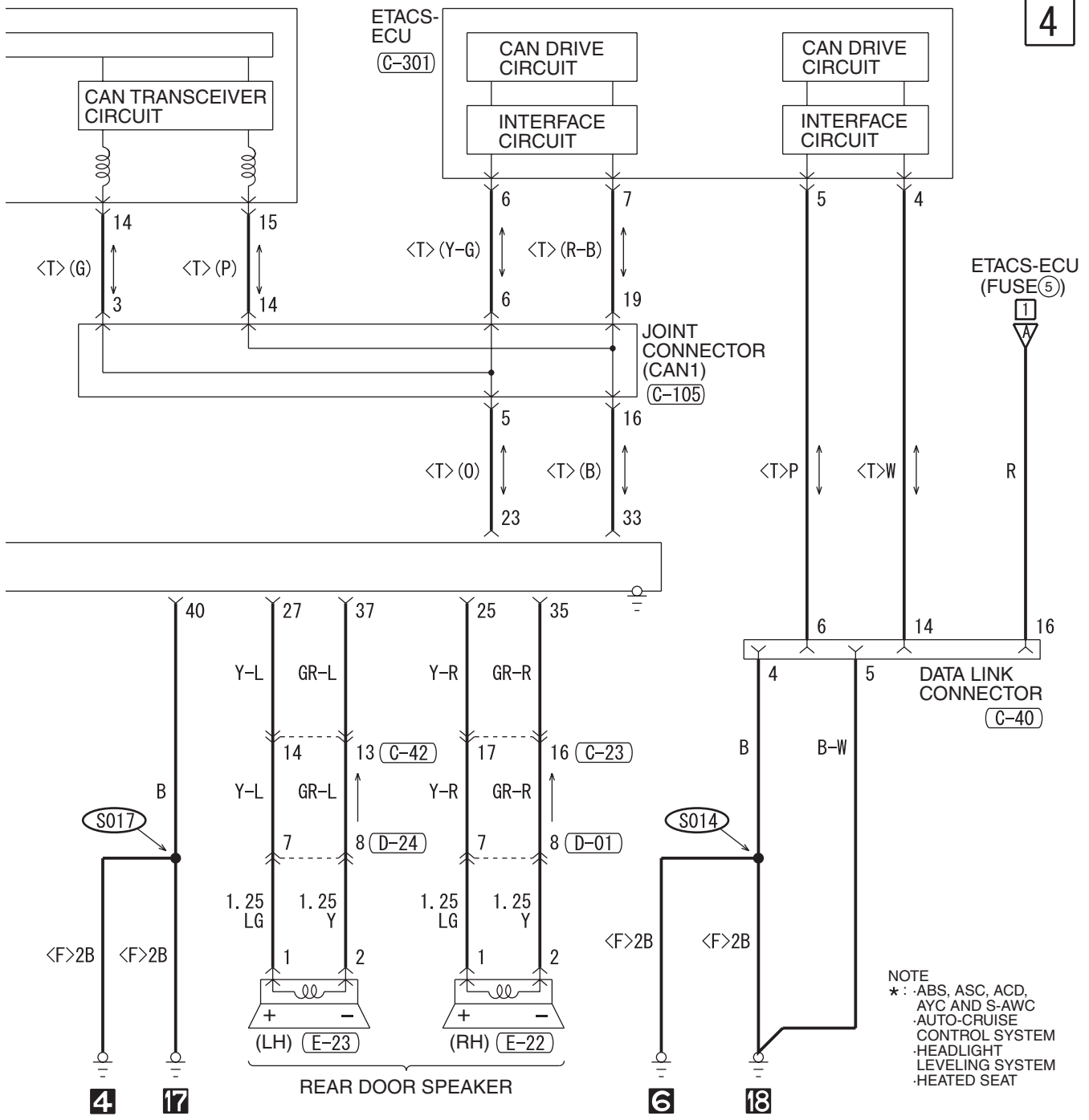

NOTE
* : ABS, ASC, ACD, AYC AND S-AWC, AUTO-CRUISE CONTROL SYSTEM, HEADLIGHT LEVELING SYSTEM, HEATED SEAT

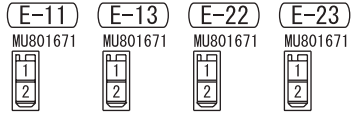
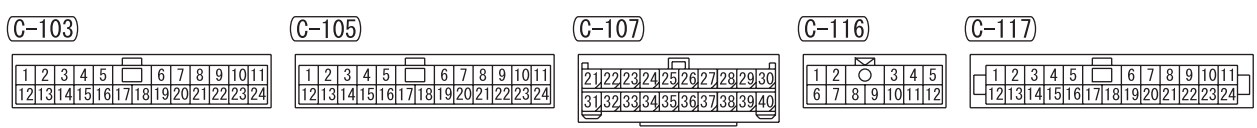

WIRE COLOR CODE
 B : BLACK LG : LIGHT GREEN G : GREEN L : BLUE W : WHITE
 Y : YELLOW SB : SKY BLUE BR : BROWN O : ORANGE GR : GRAY
 R : RED P : PINK V : VIOLET PU : PURPLE SI : SILVER

H8G14M22BB

AUDIO SYSTEM <VEHICLES WITHOUT AUDIO AMPLIFIER> (CONTINUED)

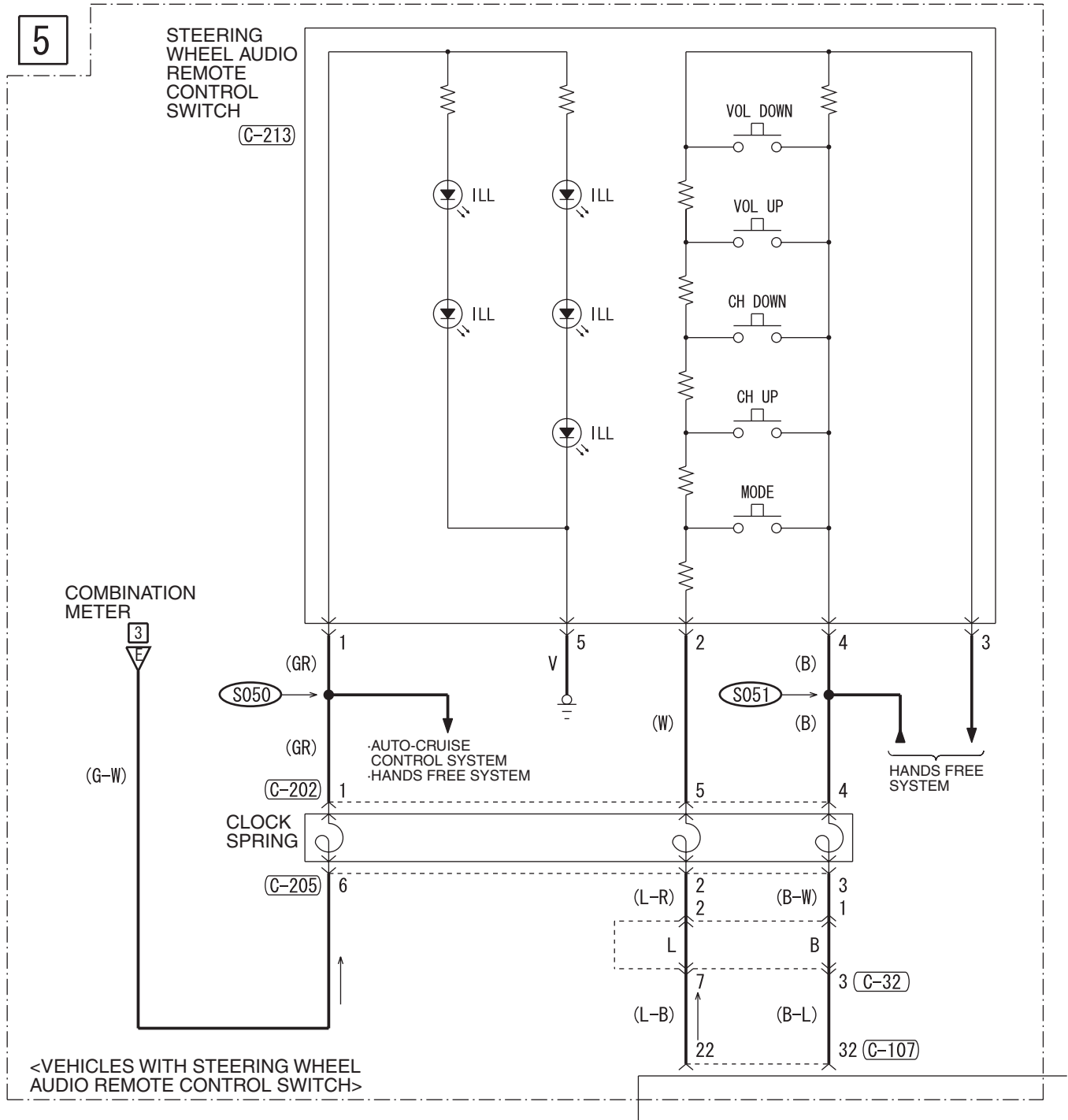

C-32

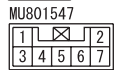

C-107

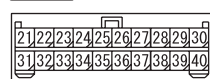

C-109

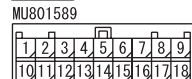

C-130

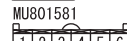

C-202



C-205

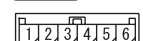

C-213

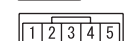

6

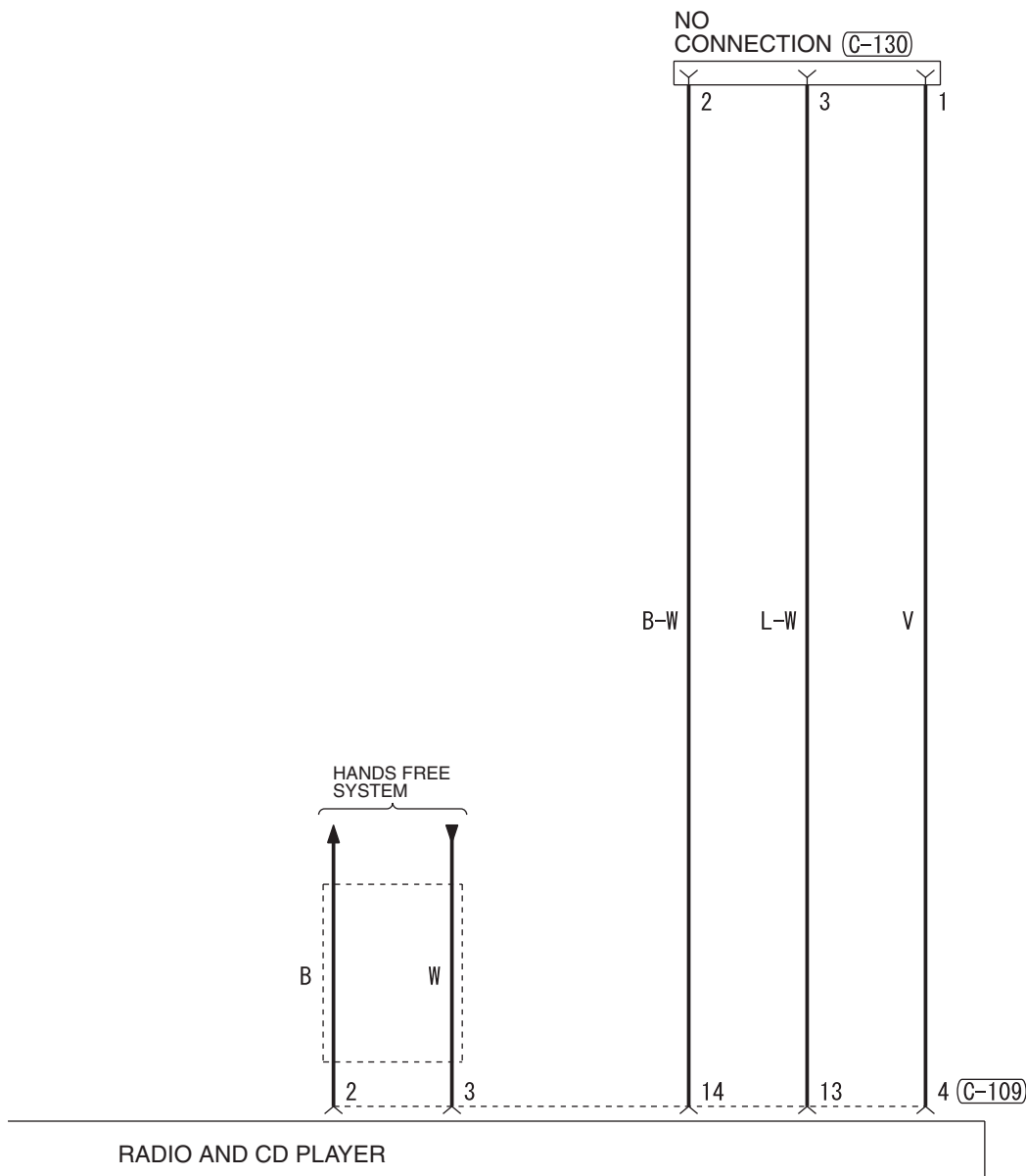

WIRE COLOR CODE

B: BLACK LG: LIGHT GREEN G: GREEN L: BLUE W: WHITE Y: YELLOW SB: SKY BLUE
 BR: BROWN O: ORANGE GR: GRAY R: RED P: PINK V: VIOLET PU: PURPLE SI: SILVER

H8G14M22CB

TSB Revision

AUDIO SYSTEM <VEHICLES WITH AUDIO AMPLIFIER>

M1901015603685

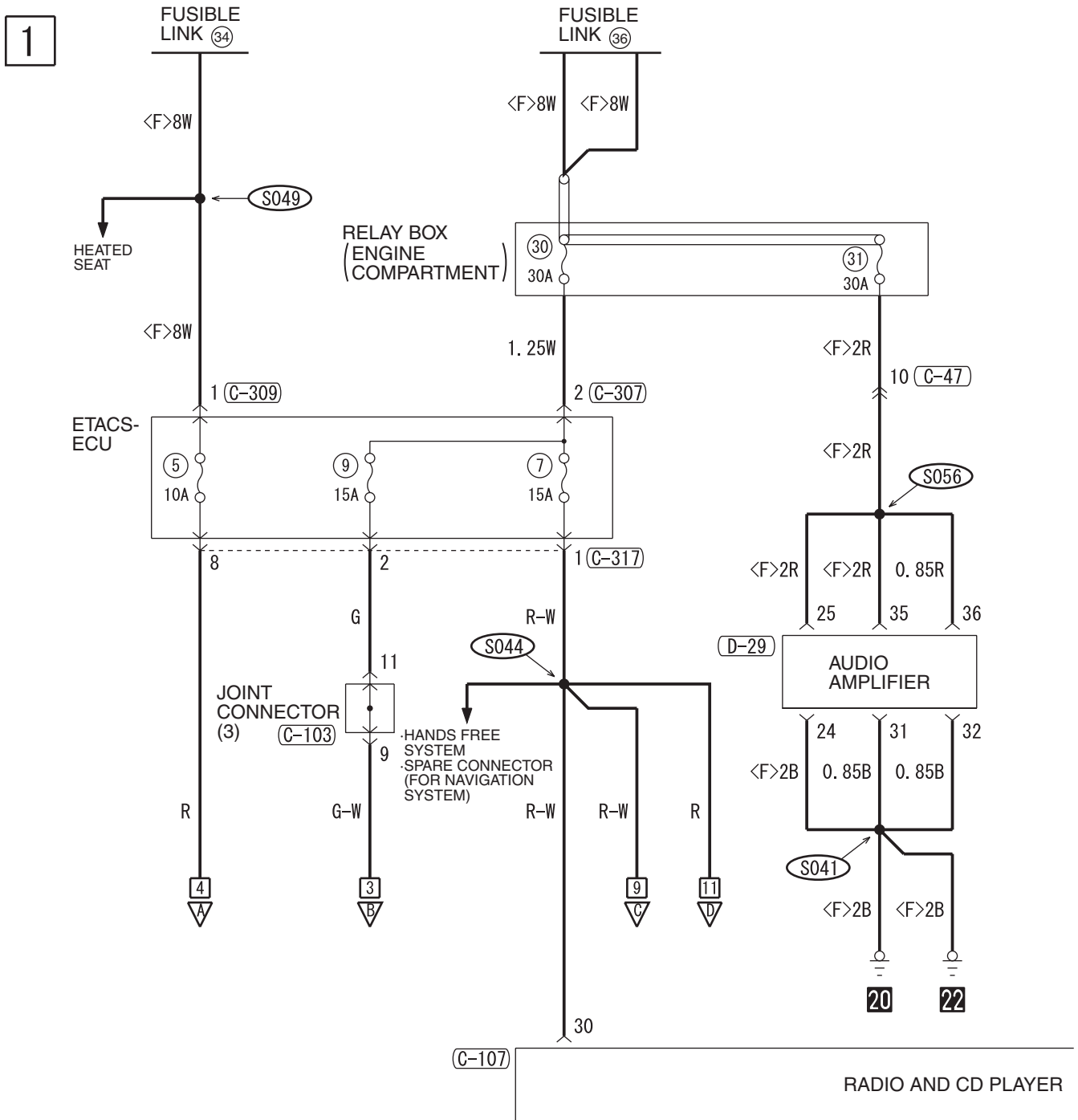

C-47

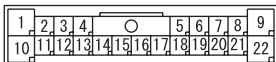

C-103

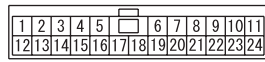

C-107

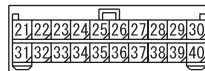

C-118



C-307



C-309



C-315



2

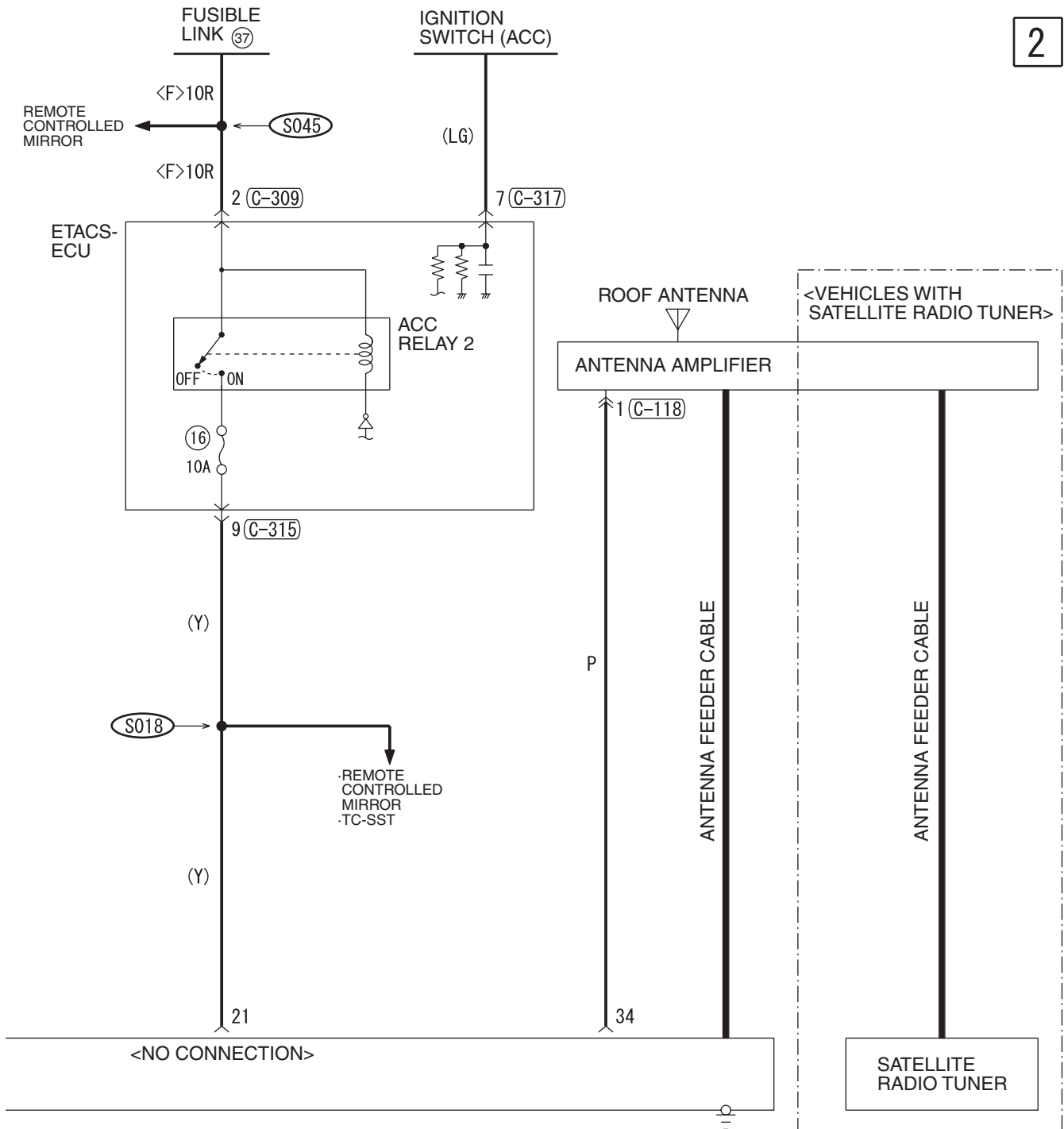

(C-317)

1	2	3	4	5	6	7	
8	9	10	11	12	13	14	15

(D-29)

MU801455

21	22	23	24	25	26	27	28		
29	30	31	32	33	34	35	36	37	38

WIRE COLOR CODE

B : BLACK LG : LIGHT GREEN G : GREEN L : BLUE W : WHITE Y : YELLOW SB : SKY BLUE
BR : BROWN O : ORANGE GR : GRAY R : RED P : PINK V : VIOLET PU : PURPLE SI : SILVER

AUDIO SYSTEM <VEHICLES WITH AUDIO AMPLIFIER> (CONTINUED)

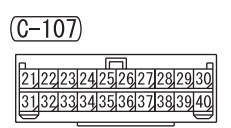
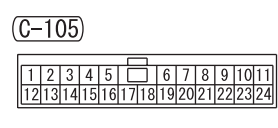
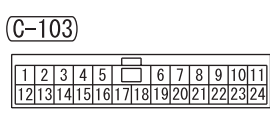
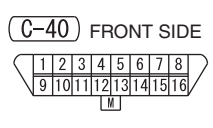
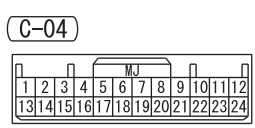
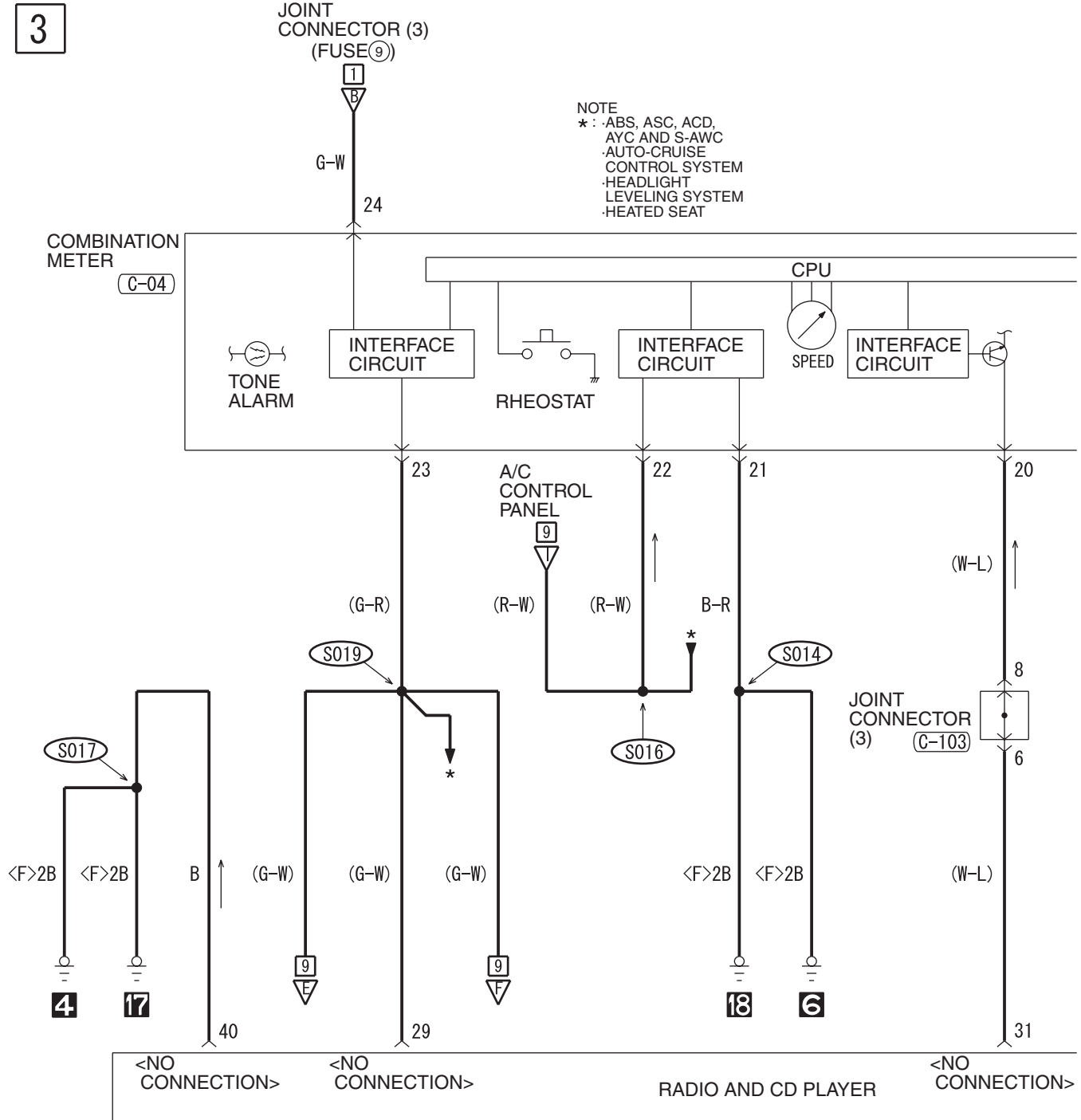

4

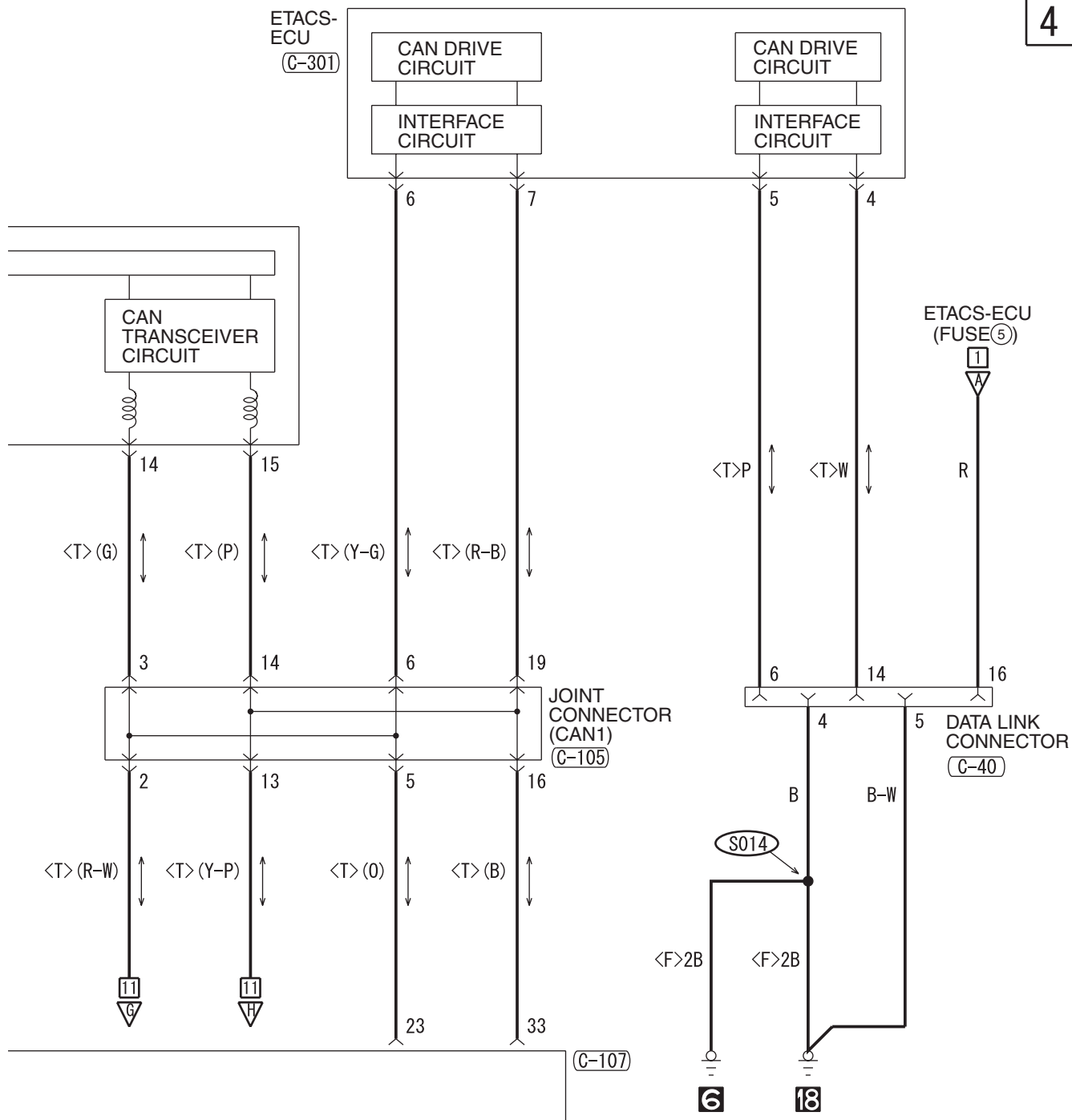

(C-301)

1	2	3	4	5	6	7	8	9	10	11		
12	13	14	15	16	17	18	19	20	21	22	23	24

WIRE COLOR CODE

B : BLACK LG : LIGHT GREEN G : GREEN L : BLUE W : WHITE Y : YELLOW SB : SKY BLUE
BR : BROWN O : ORANGE GR : GRAY R : RED P : PINK V : VIOLET PU : PURPLE SI : SILVER

H8G14M23BB

AUDIO SYSTEM <VEHICLES WITH AUDIO AMPLIFIER> (CONTINUED)

5

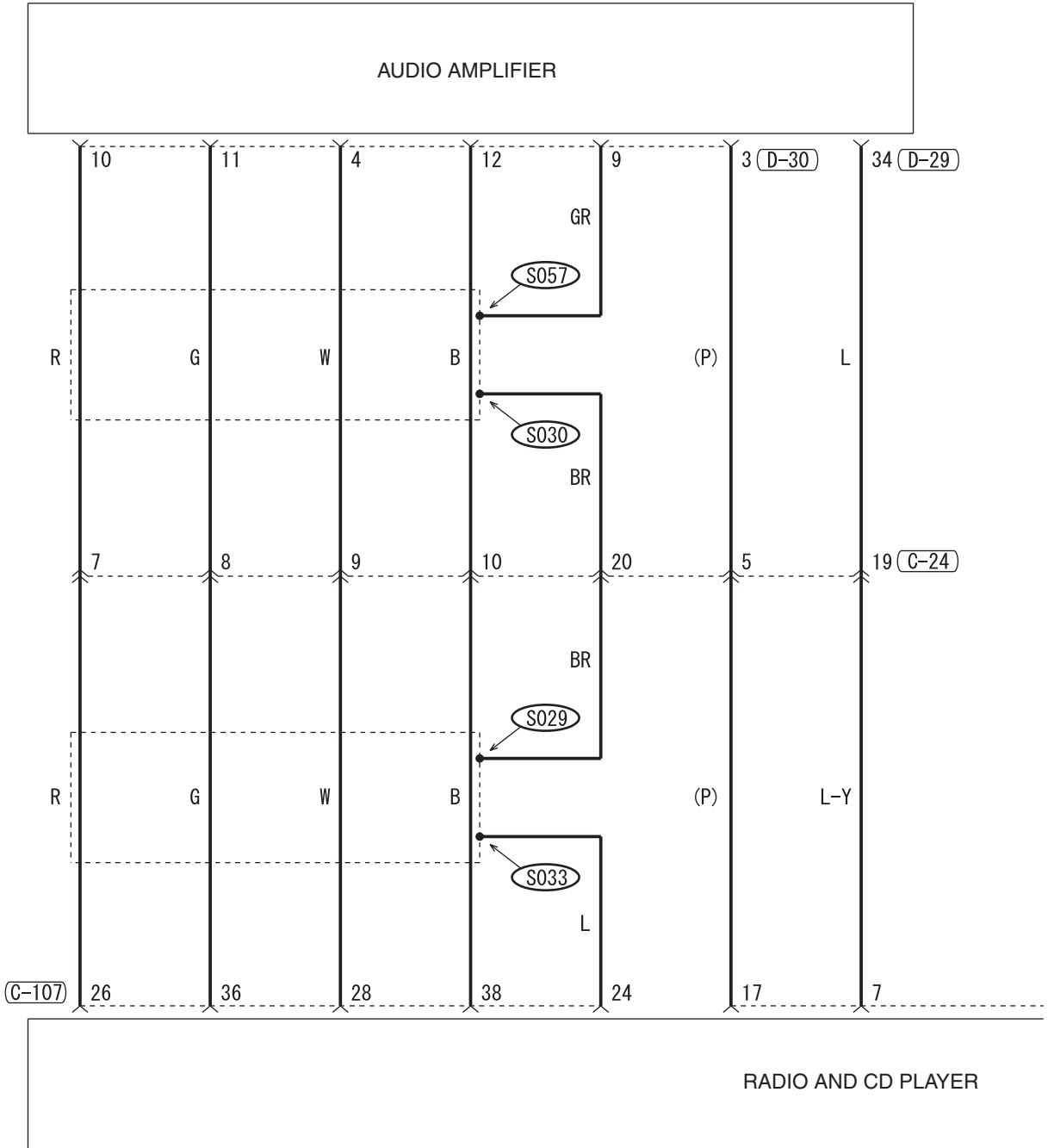

(C-24)

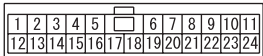

(C-107)

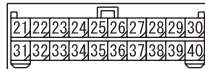

(C-109)



(C-125)

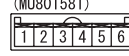

(D-29)

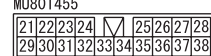

(D-30)

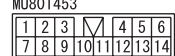

6

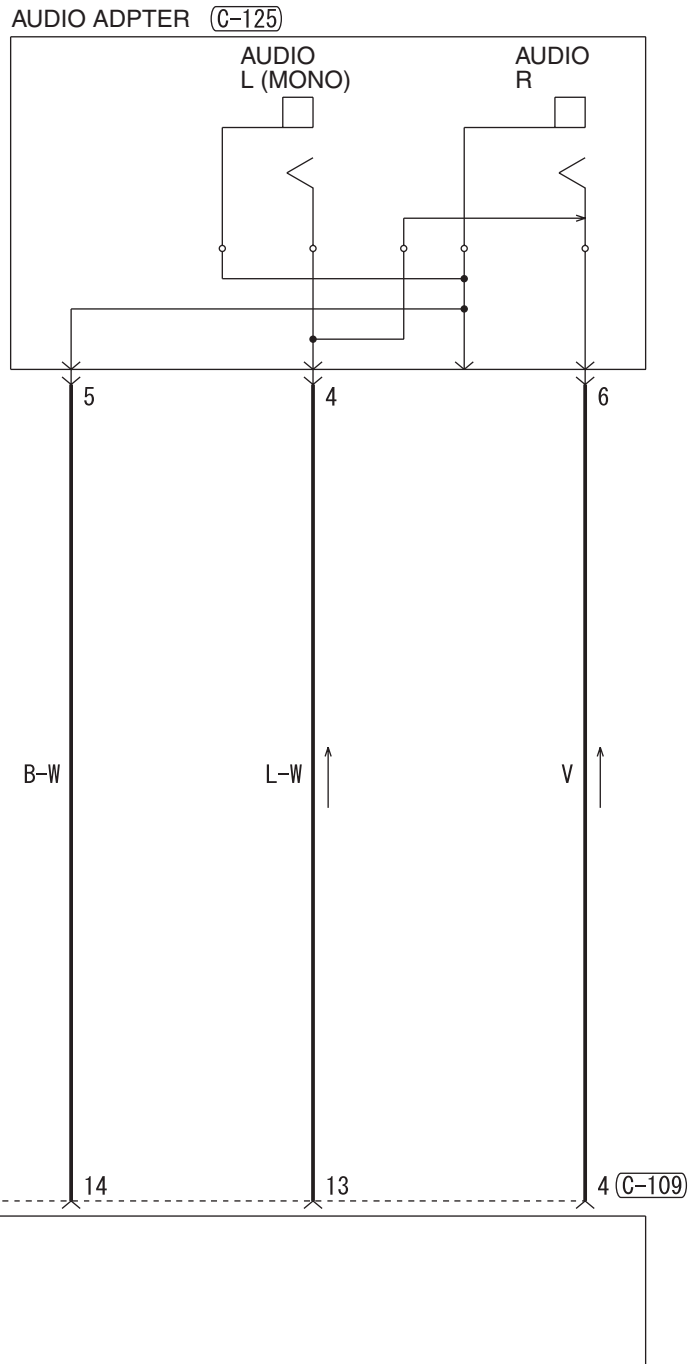

WIRE COLOR CODE
 B: BLACK LG: LIGHT GREEN G: GREEN L: BLUE W: WHITE Y: YELLOW SB: SKY BLUE
 BR: BROWN O: ORANGE GR: GRAY R: RED P: PINK V: VIOLET PU: PURPLE SI: SILVER

H8G14M23CB

TSB Revision

AUDIO SYSTEM <VEHICLES WITH AUDIO AMPLIFIER> (CONTINUED)

7

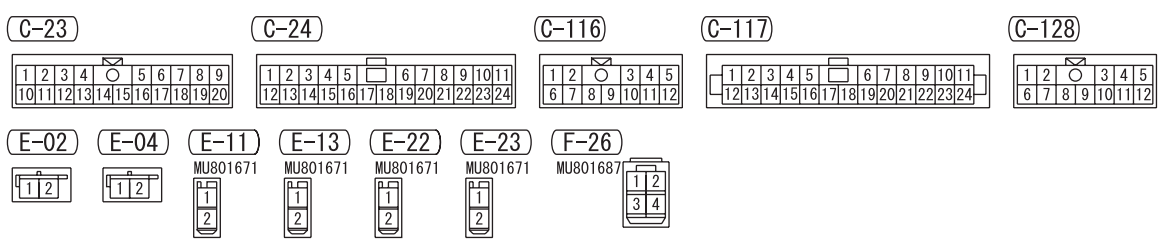
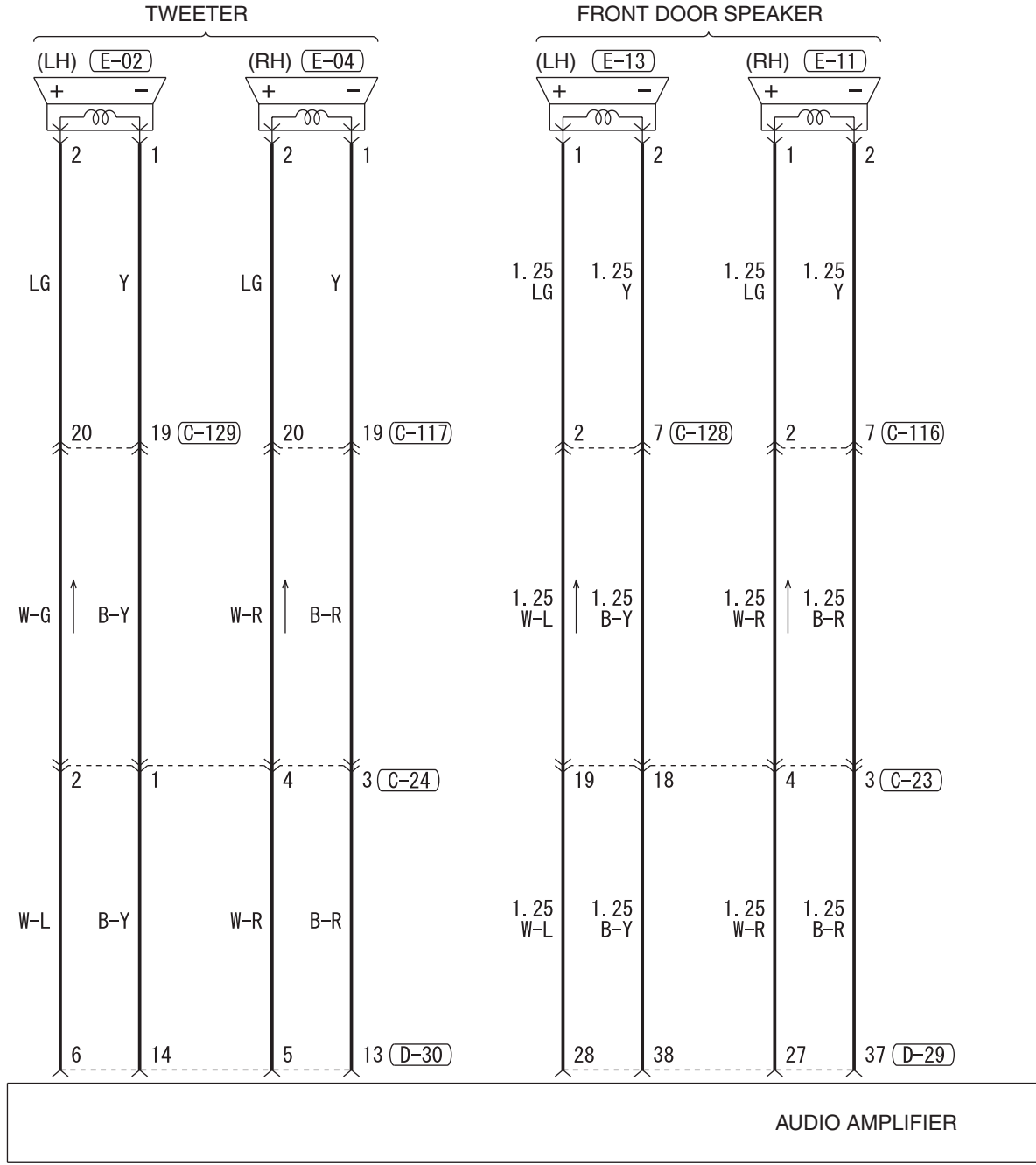

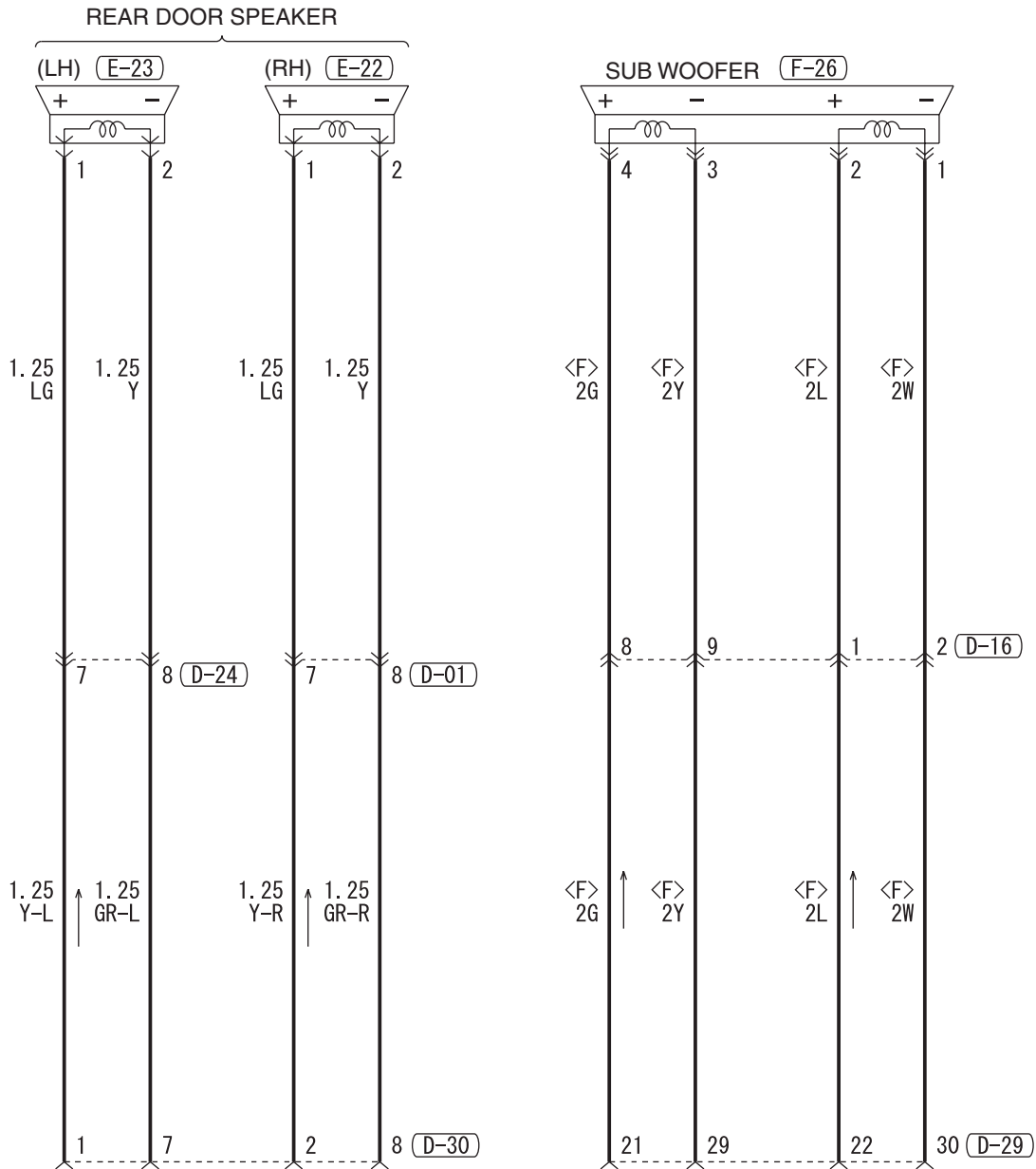

(C-129)

(D-01)

(D-16)

(D-24)

(D-29)

(D-30)

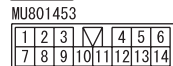
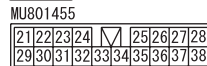
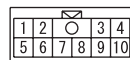
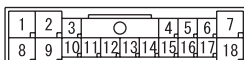
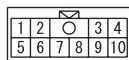
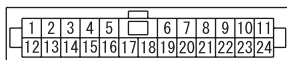

WIRE COLOR CODE

B : BLACK LG : LIGHT GREEN G : GREEN L : BLUE W : WHITE Y : YELLOW SB : SKY BLUE
BR : BROWN O : ORANGE GR : GRAY R : RED P : PINK V : VIOLET PU : PURPLE SI : SILVER

AUDIO SYSTEM <VEHICLES WITH AUDIO AMPLIFIER> (CONTINUED)

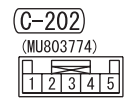
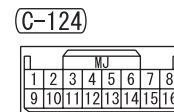
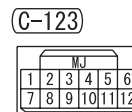
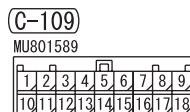
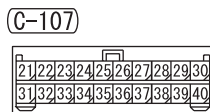
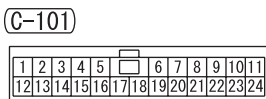
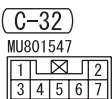
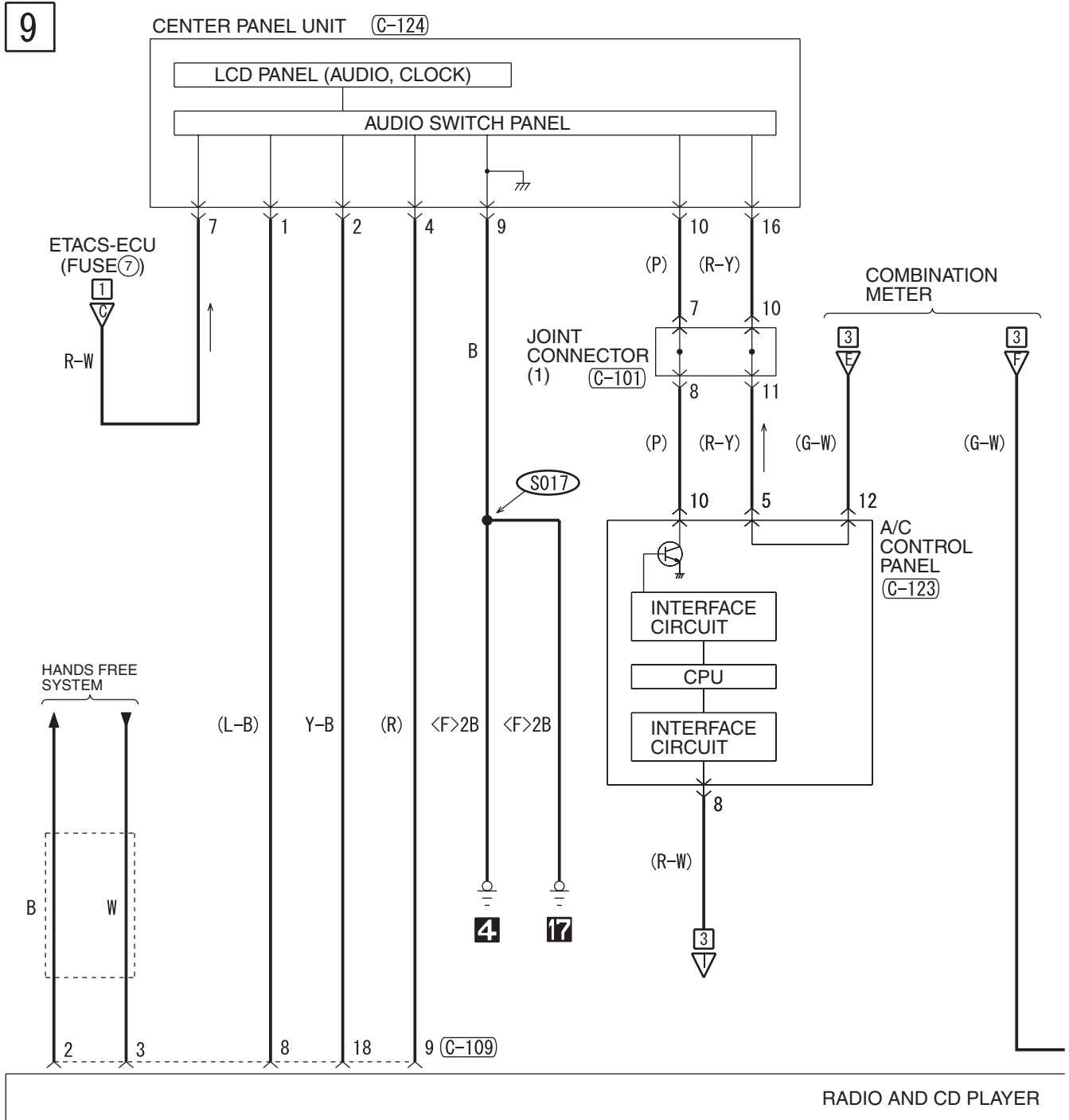

10

STEERING
WHEEL AUDIO
REMOTE
CONTROL
SWITCH

(C-213)

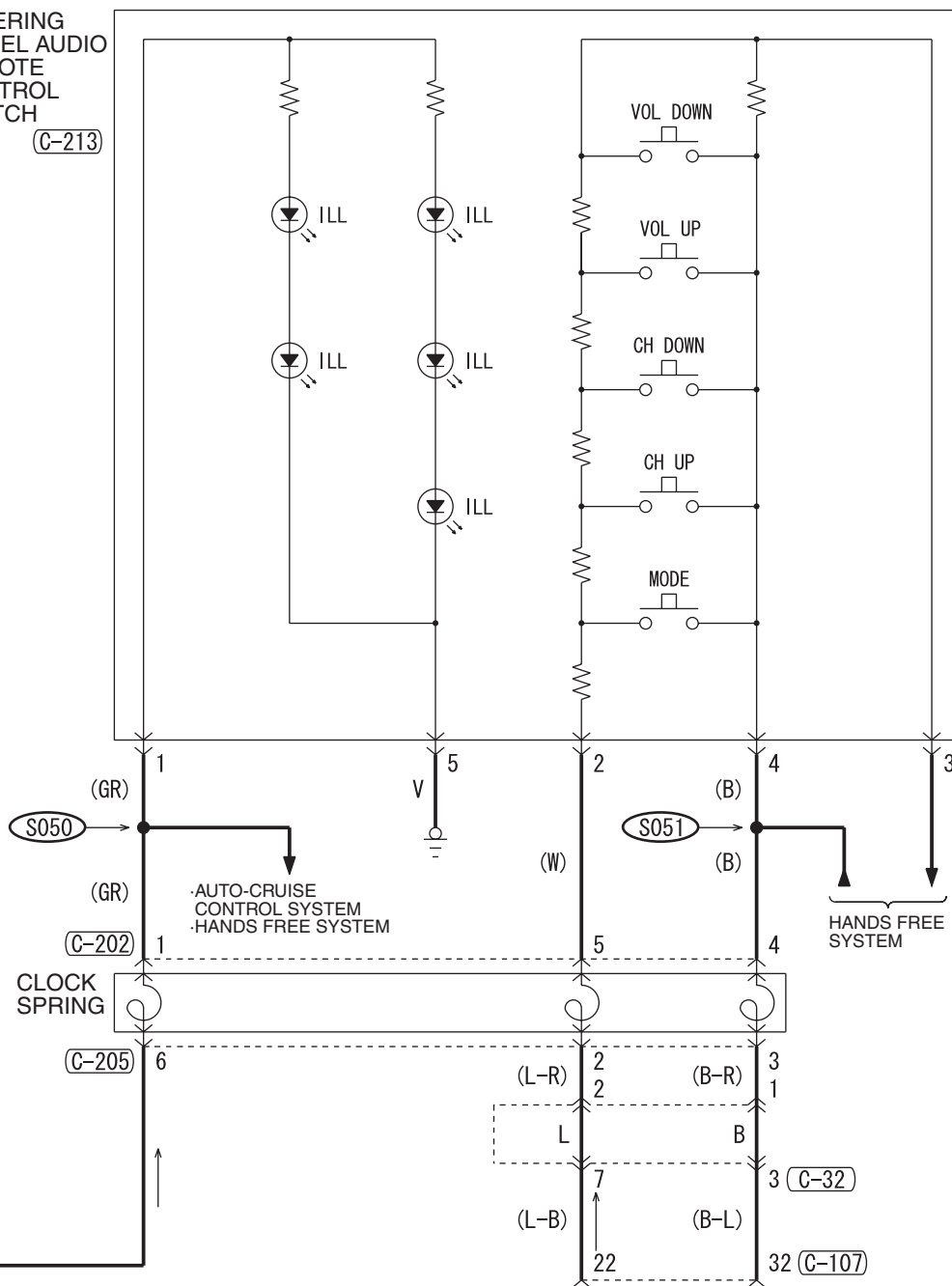

(C-205)

(C-213)

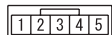
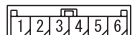

WIRE COLOR CODE

B : BLACK LG : LIGHT GREEN G : GREEN L : BLUE W : WHITE Y : YELLOW SB : SKY BLUE
BR : BROWN O : ORANGE GR : GRAY R : RED P : PINK V : VIOLET PU : PURPLE SI : SILVER

H8G14M23EB

TSB Revision

AUDIO SYSTEM <VEHICLES WITH AUDIO AMPLIFIER> (CONTINUED)

11

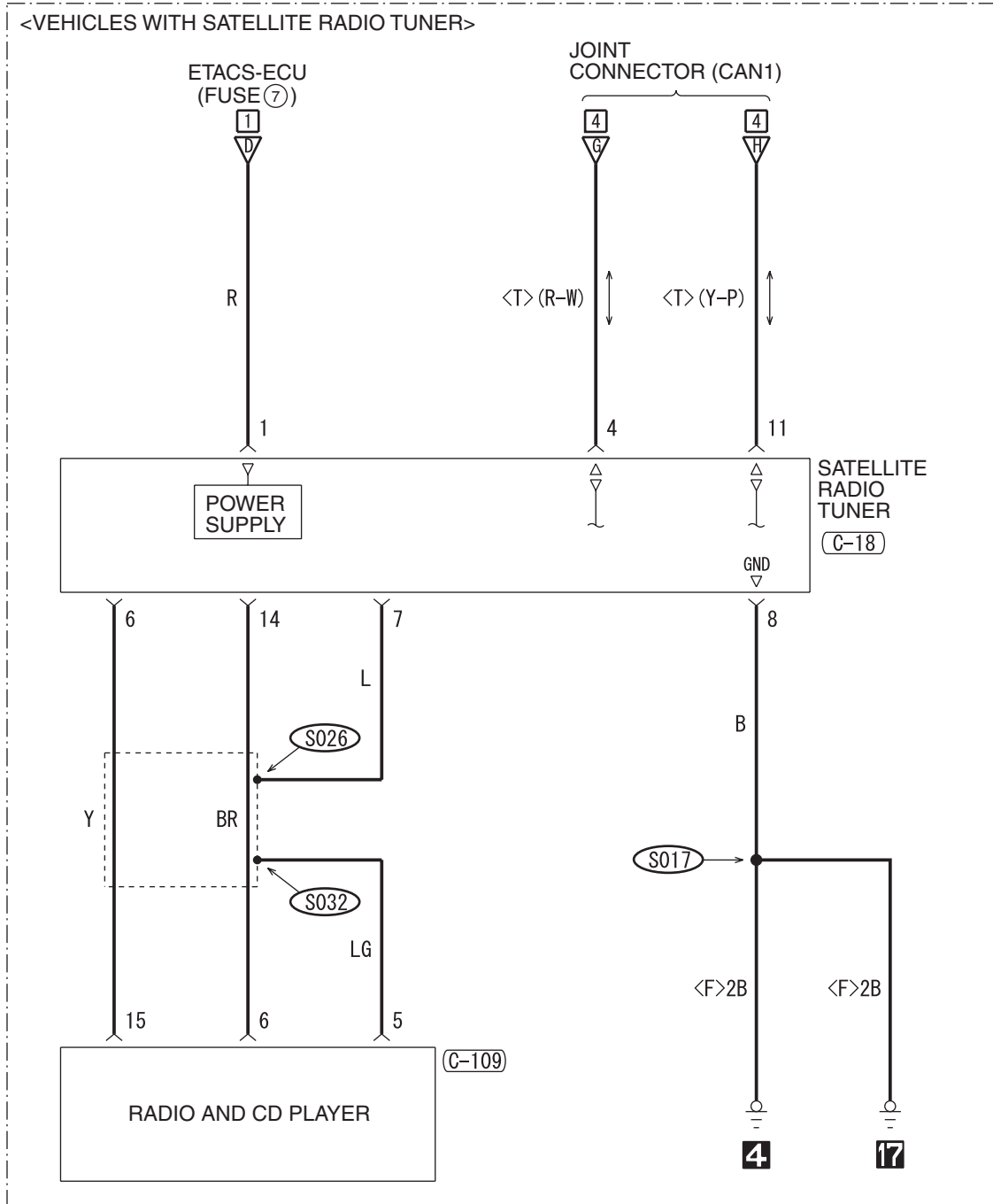

(C-18)

MU801586

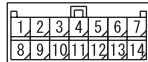

(C-109)

MU801589

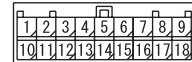

WIRE COLOR CODE

B: BLACK LG: LIGHT GREEN G: GREEN L: BLUE W: WHITE Y: YELLOW SB: SKY BLUE
BR: BROWN O: ORANGE GR: GRAY R: RED P: PINK V: VIOLET PU: PURPLE SI: SILVER

NOTES

MITSUBISHI MULTI-COMMUNICATION SYSTEM (MMCS)

M1901007500394

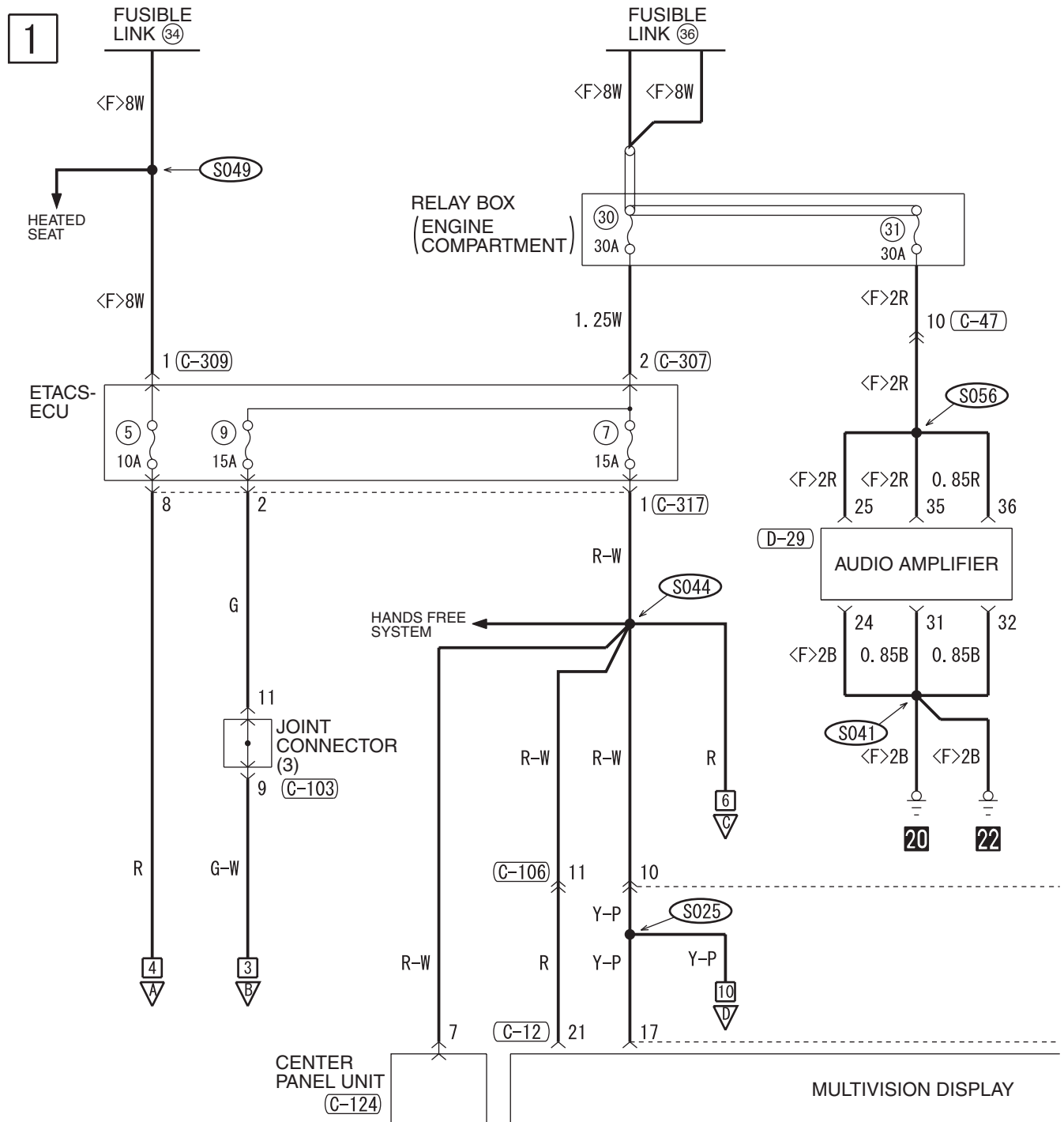

C-09

71	72	73	74	75	76	77
----	----	----	----	----	----	----

C-12

21	22	23	24	25
----	----	----	----	----

C-13

1	2	3	4	5	6	7	8	9
X	10	11	12	X	13	X	14	X

C-47

1	2	3	4	5	6	7	8	9
10	11	12	13	14	15	16	17	18
19	20	21	22					

C-103

1	2	3	4	5	6	7	8	9	10	11
12	13	14	15	16	17	18	19	20	21	22
23	24									

C-317

1	2	3	4	5	6	7
8	9	10	11	12	13	14
15						

D-29

MU801455

21	22	23	24	25	26	27	28
29	30	31	32	33	34	35	36
37	38						

H8G14M24AA

2

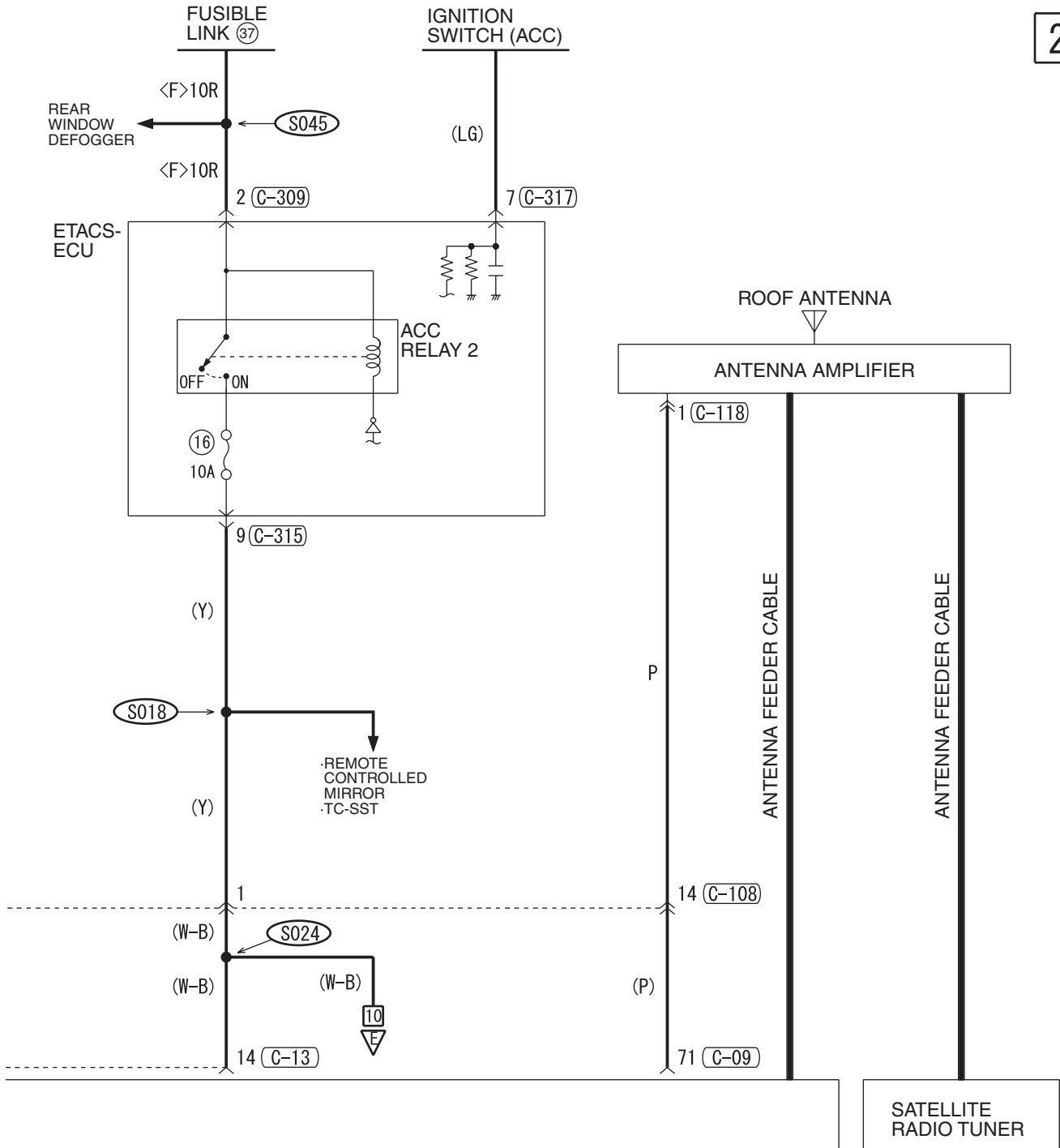

(C-106)

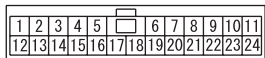

(C-108)

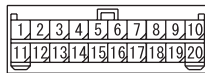

(C-118)



(C-124)

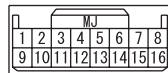

(C-307)



(C-309)



(C-315)



WIRE COLOR CODE

B: BLACK LG: LIGHT GREEN G: GREEN L: BLUE W: WHITE Y: YELLOW SB: SKY BLUE
 BR: BROWN O: ORANGE GR: GRAY R: RED P: PINK V: VIOLET PU: PURPLE SI: SILVER

H8G14M24AB

MITSUBISHI MULTI-COMMUNICATION SYSTEM (MMCS) (CONTINUED)

3

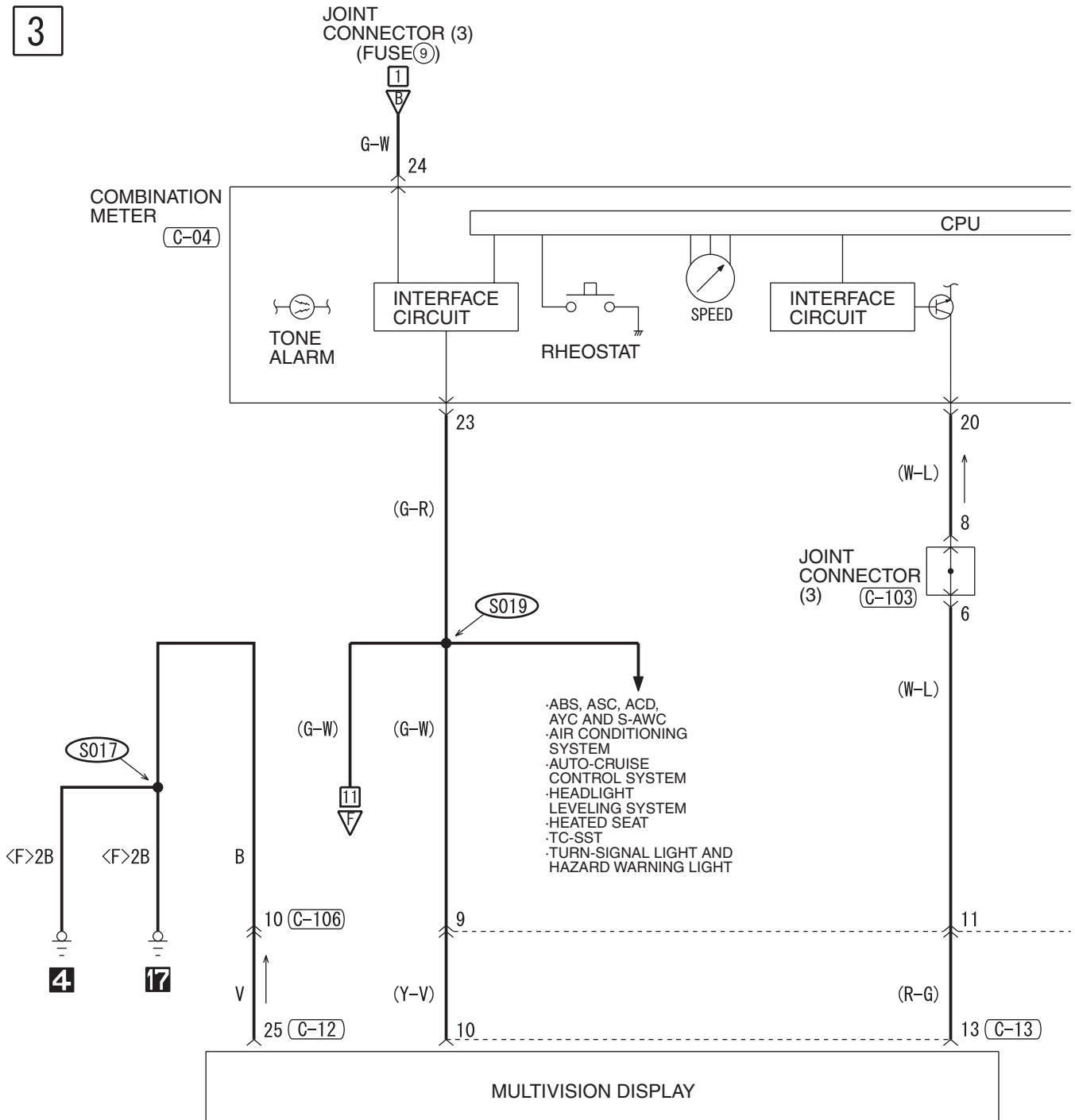

(C-04)

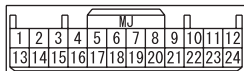

(C-12)

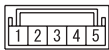

(C-13)

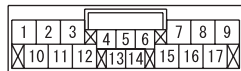

(C-22)

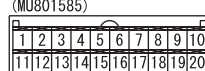

(C-40) FRONT SIDE

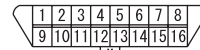

(C-301)



4

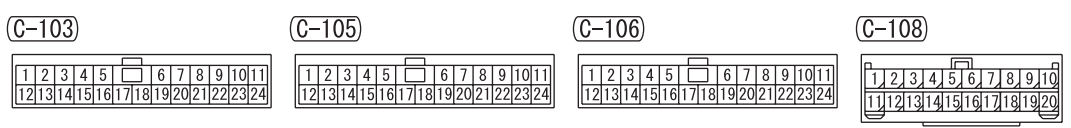
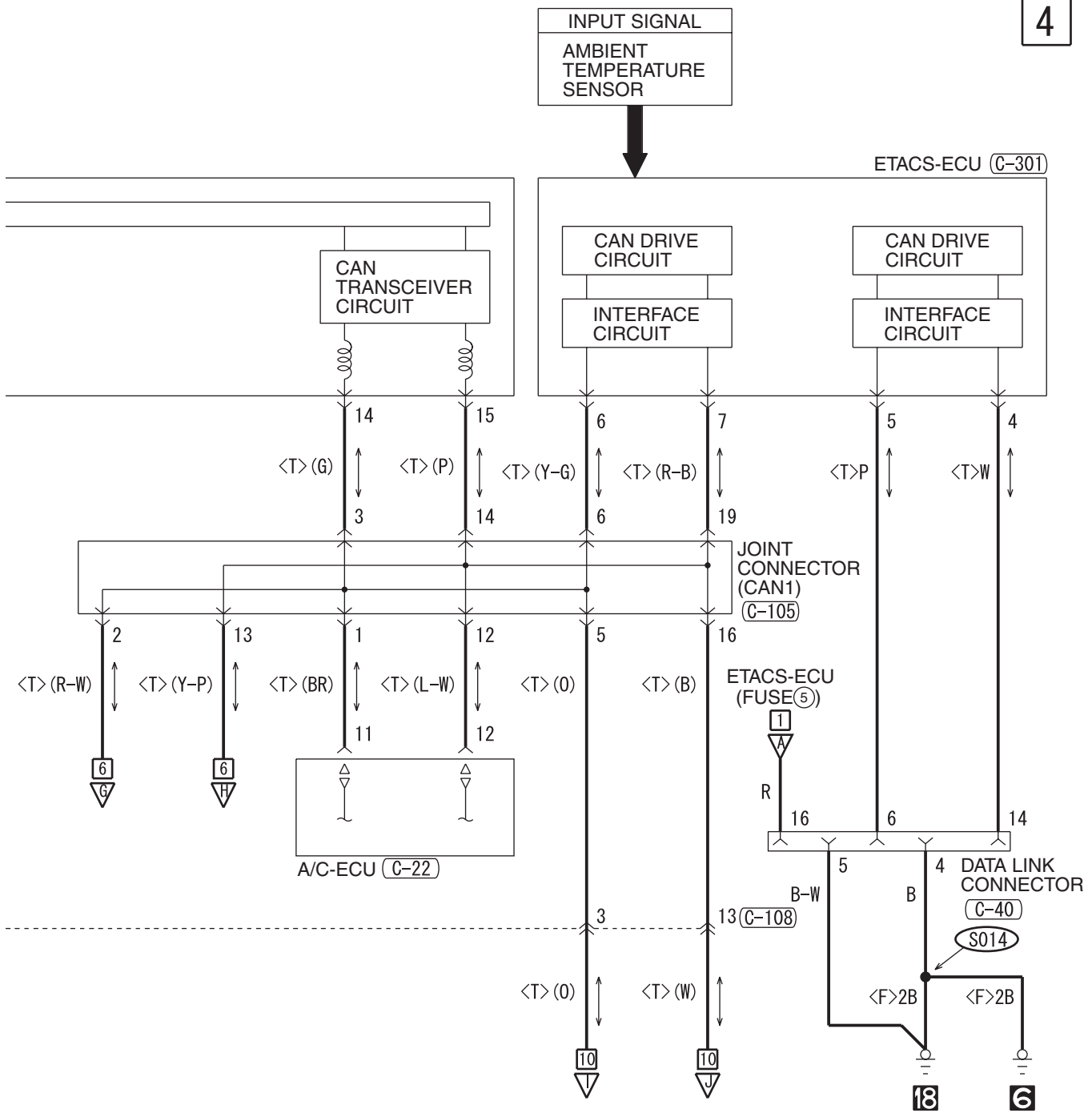

WIRE COLOR CODE
 B : BLACK LG : LIGHT GREEN G : GREEN L : BLUE W : WHITE Y : YELLOW SB : SKY BLUE
 BR : BROWN O : ORANGE GR : GRAY R : RED P : PINK V : VIOLET PU : PURPLE SI : SILVER

H8G14M24BB

TSB Revision

MITSUBISHI MULTI-COMMUNICATION SYSTEM (MMCS) (CONTINUED)

5

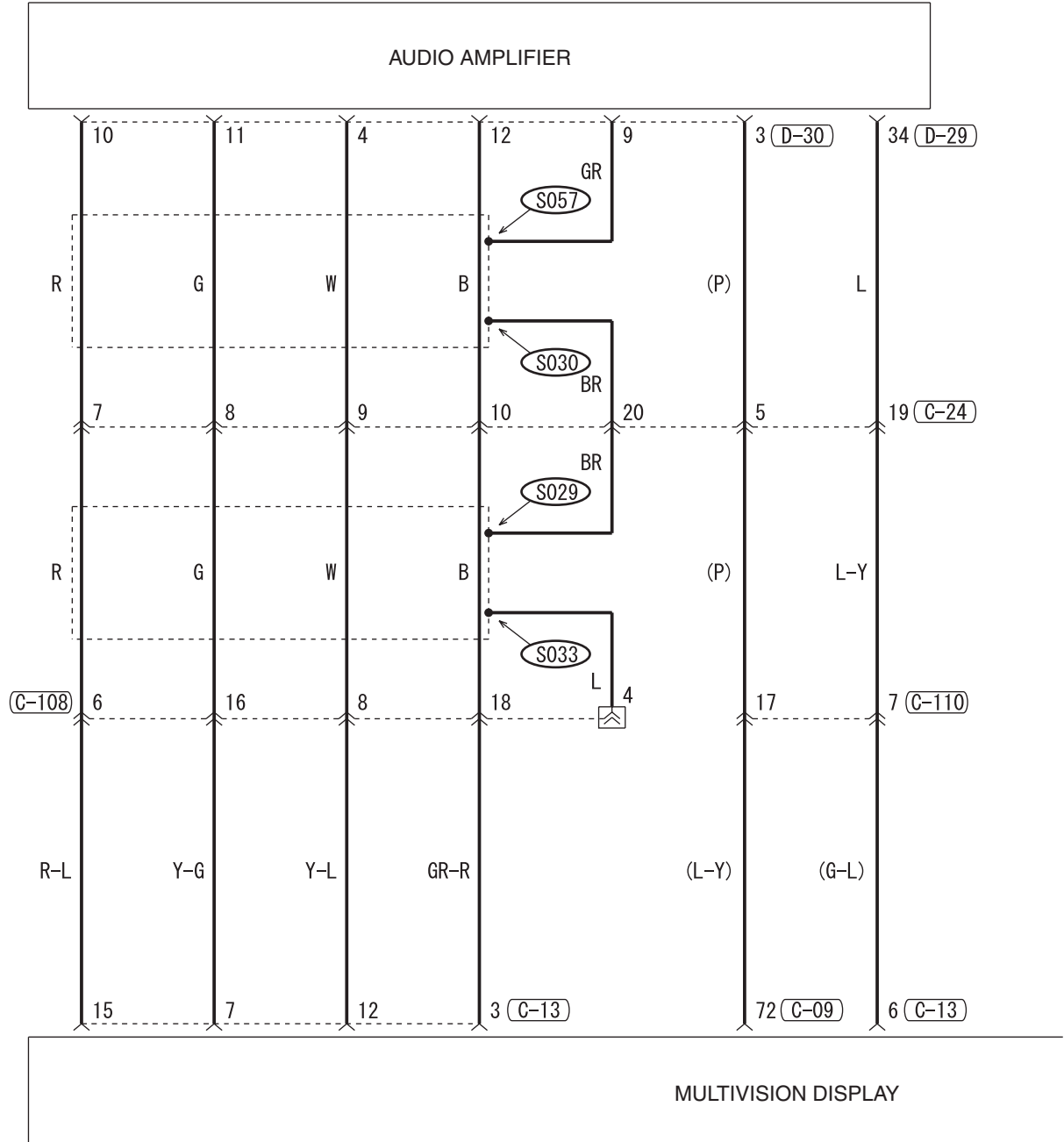

(C-09)

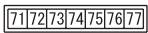

(C-13)

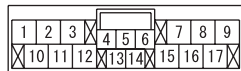

(C-18)

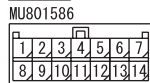

(C-24)



(C-108)

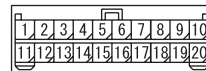

(C-110)

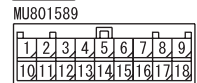

6

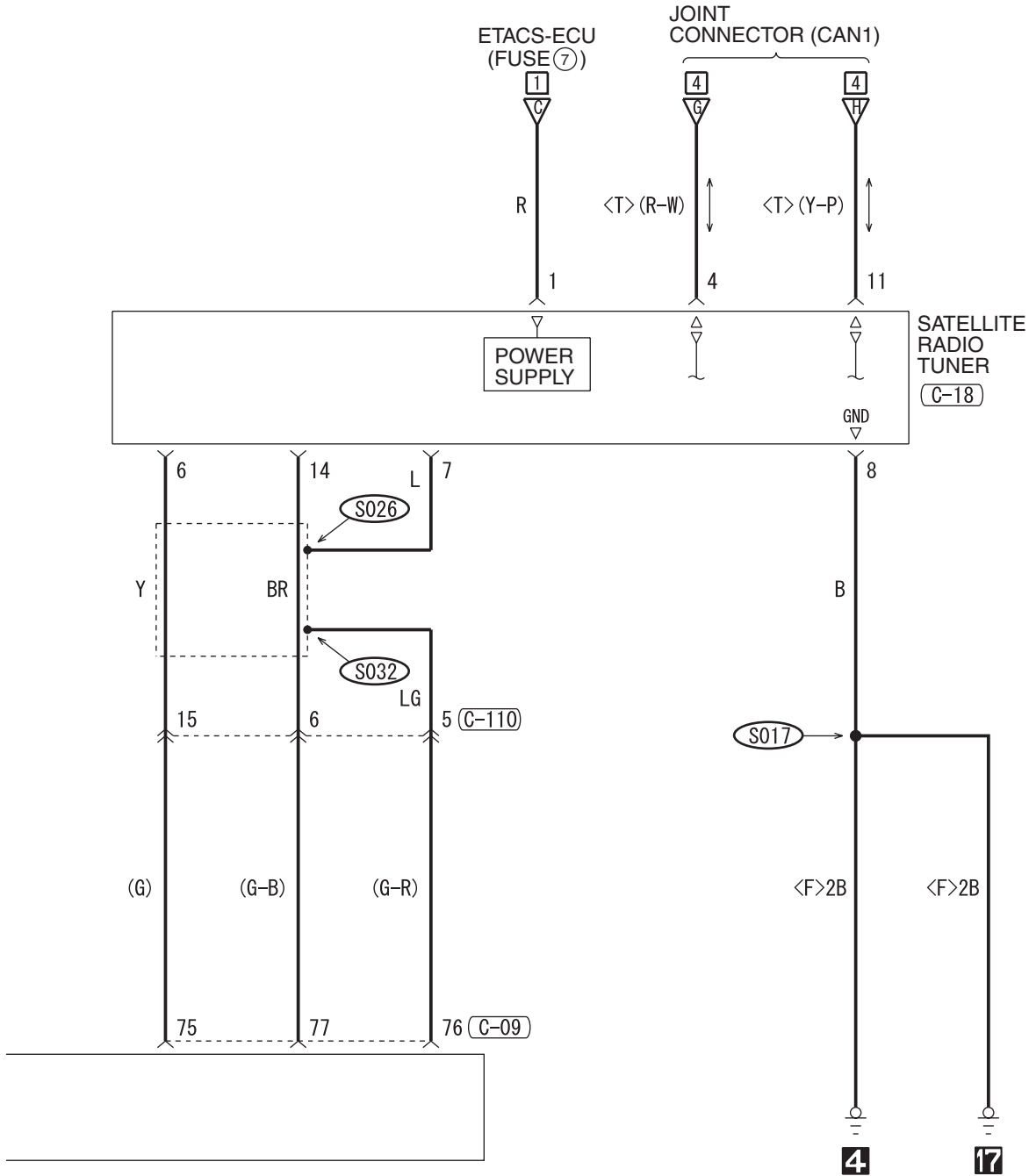

(D-29)

MU801455

21	22	23	24	25	26	27	28		
29	30	31	32	33	34	35	36	37	38

(D-30)

MU801453

1	2	3	4	5	6		
7	8	9	10	11	12	13	14

WIRE COLOR CODE

B: BLACK LG: LIGHT GREEN G: GREEN L: BLUE W: WHITE Y: YELLOW SB: SKY BLUE
 BR: BROWN O: ORANGE GR: GRAY R: RED P: PINK V: VIOLET PU: PURPLE SI: SILVER

H8G14M24CB

TSB Revision

MITSUBISHI MULTI-COMMUNICATION SYSTEM (MMCS) (CONTINUED)

7

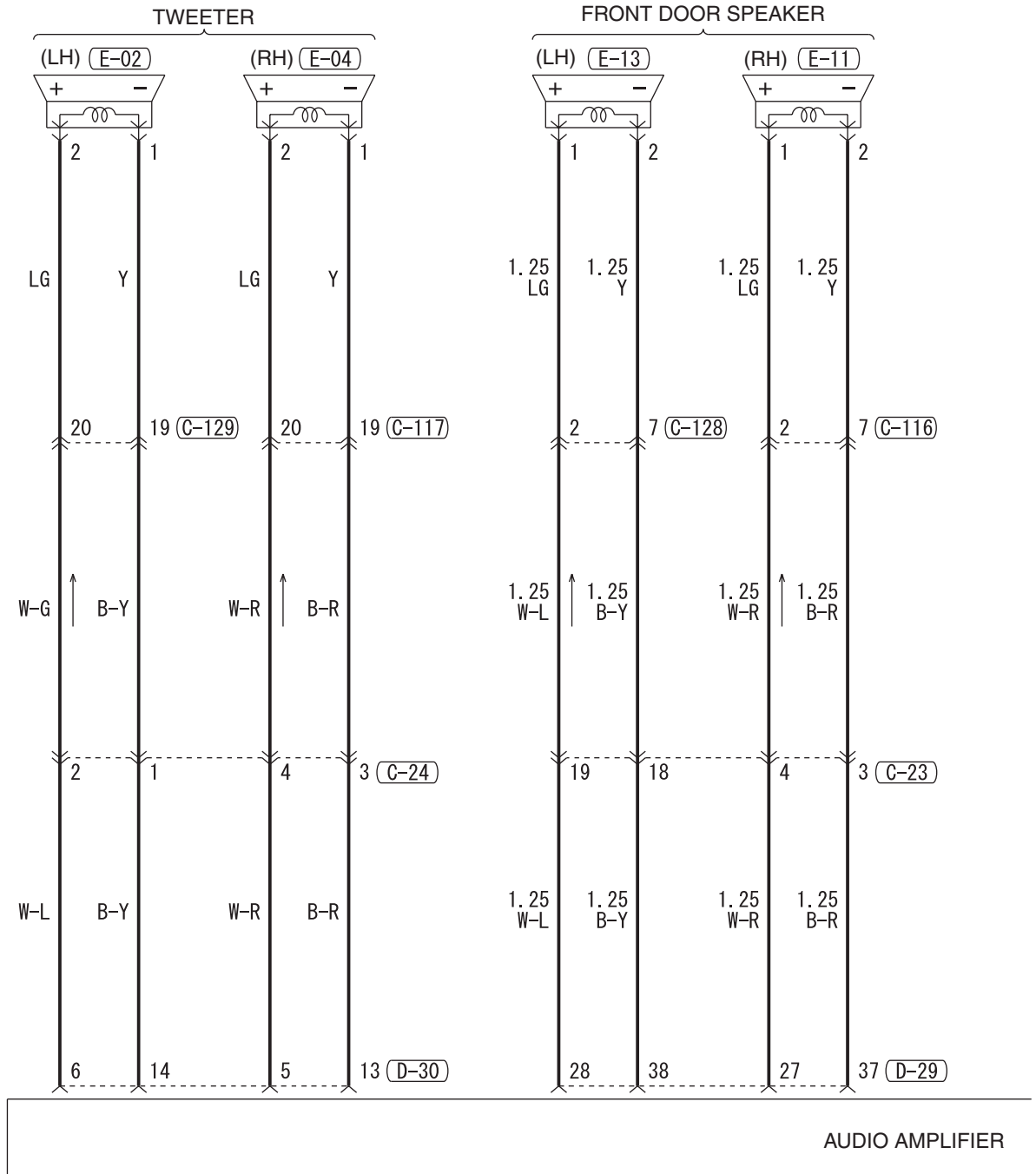

C-23

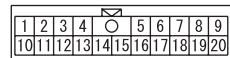

C-24

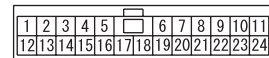

C-116

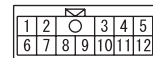

C-117

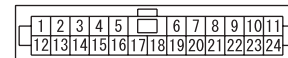

C-128

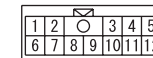

E-02



E-04



E-11



E-13



E-22



E-23



F-26



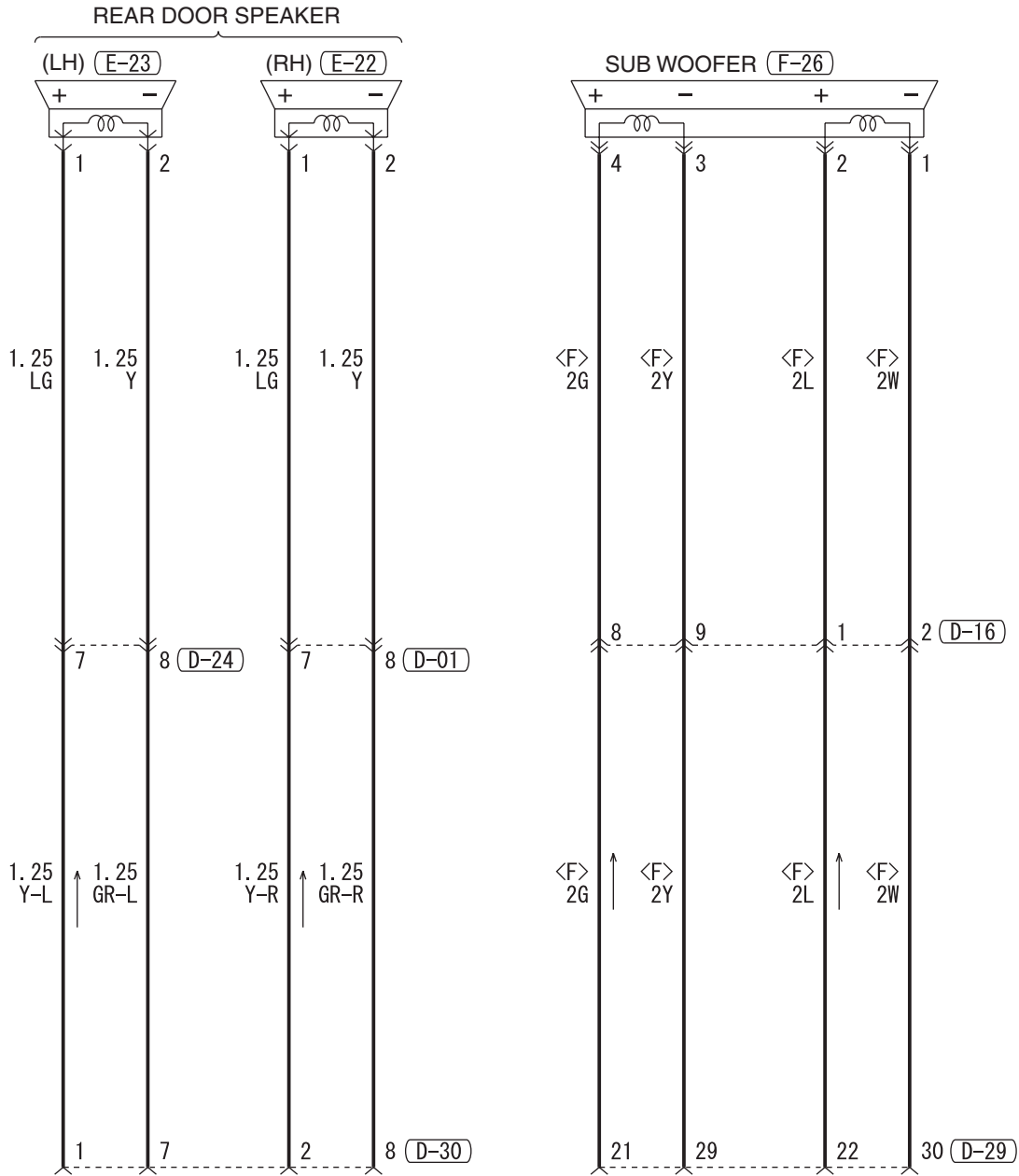

(C-129)

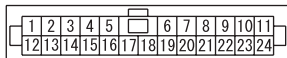

(D-01)

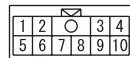

(D-16)

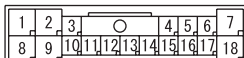

(D-24)

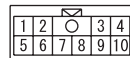

(D-29)

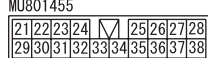

(D-30)

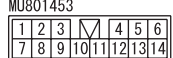

WIRE COLOR CODE

B : BLACK LG : LIGHT GREEN G : GREEN L : BLUE W : WHITE Y : YELLOW SB : SKY BLUE
 BR : BROWN O : ORANGE GR : GRAY R : RED P : PINK V : VIOLET PU : PURPLE SI : SILVER

H8G14M24DB

MITSUBISHI MULTI-COMMUNICATION SYSTEM (MMCS) (CONTINUED)

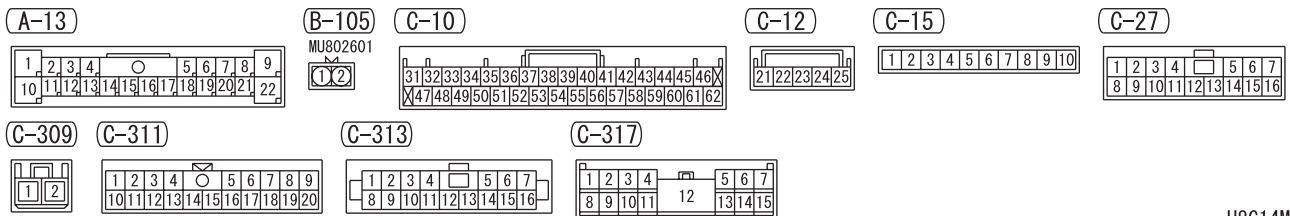
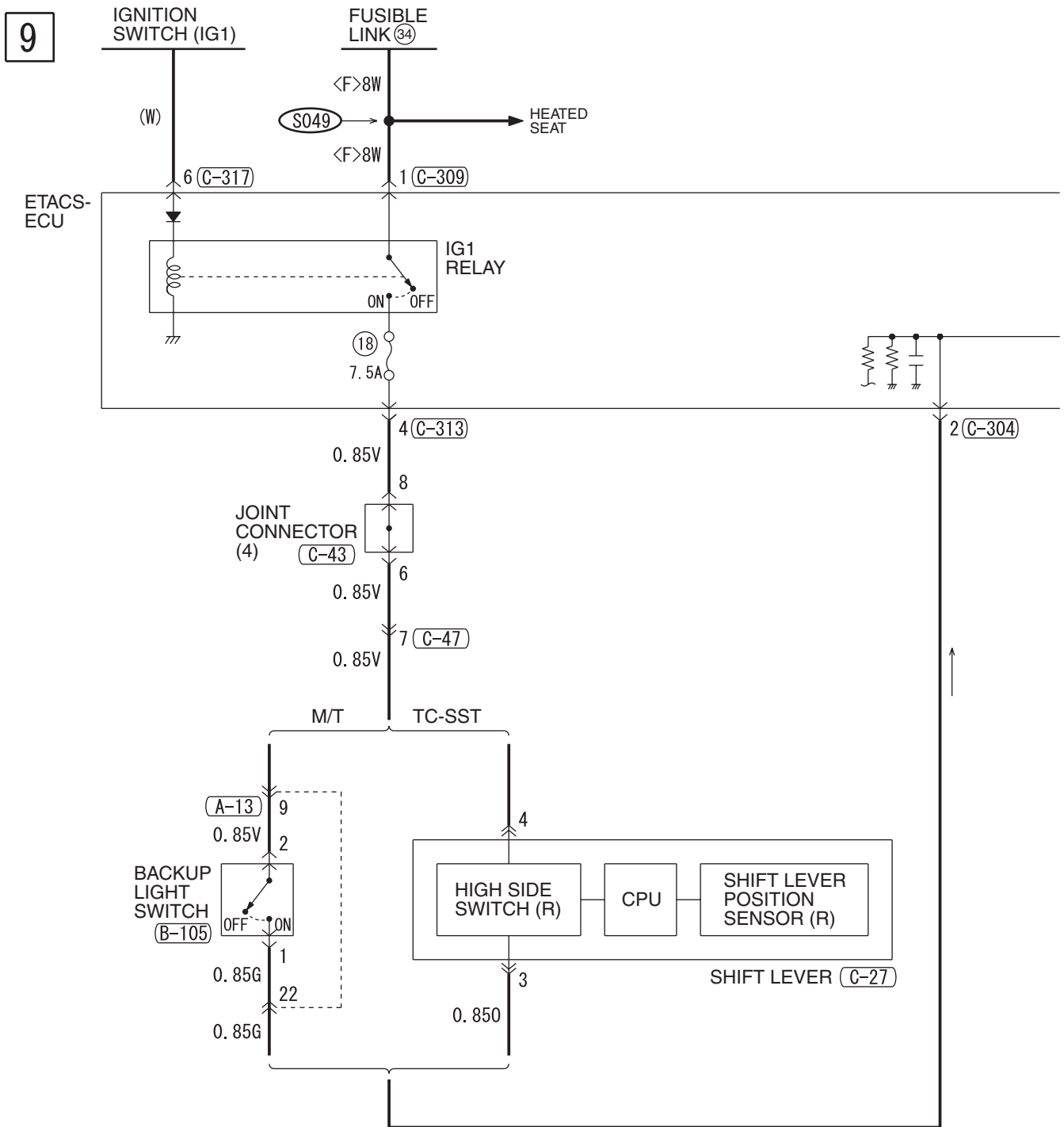

10

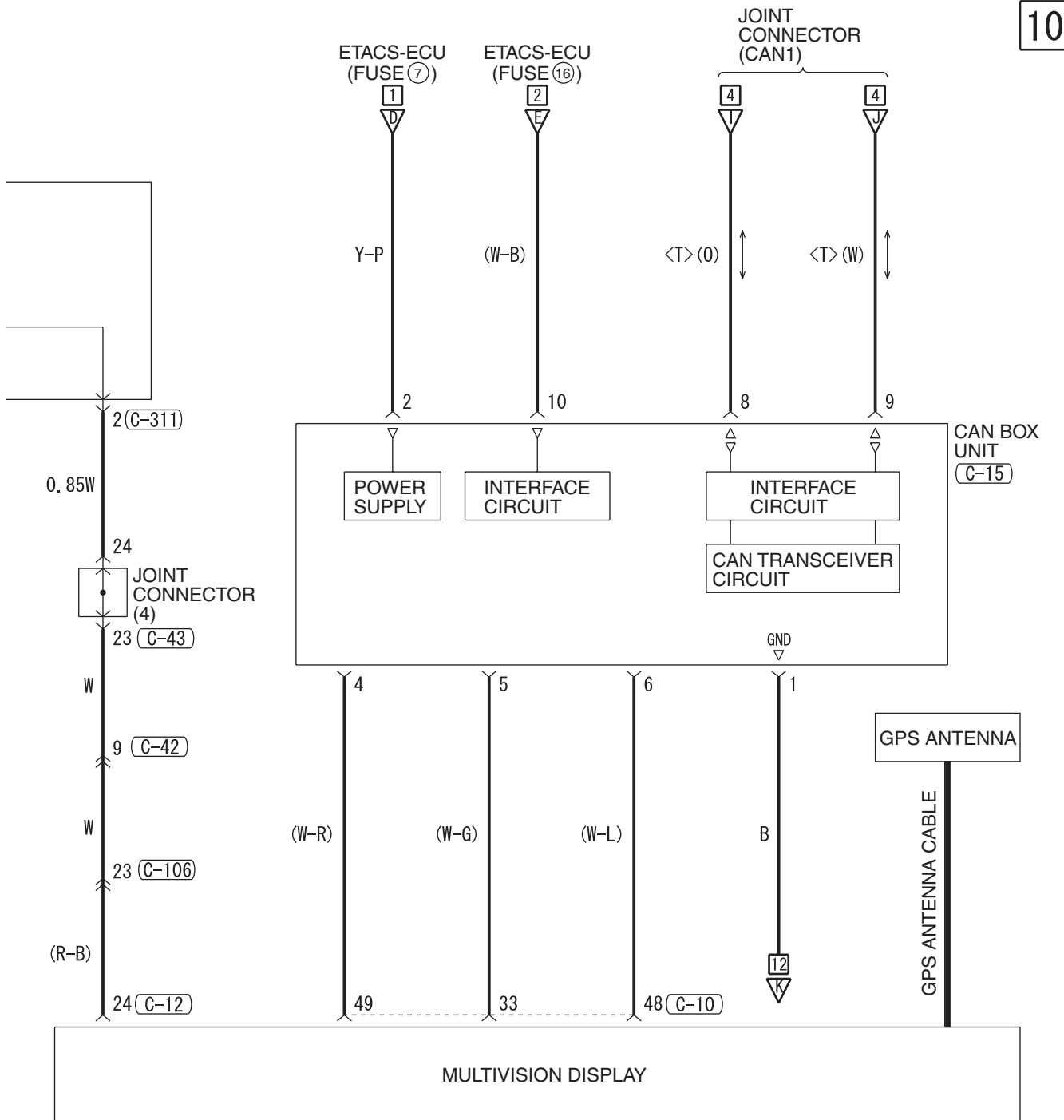

C-42

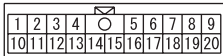

C-43

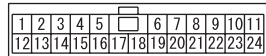

C-47

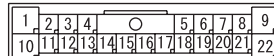

C-106

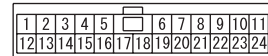

C-304

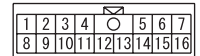

WIRE COLOR CODE

B : BLACK LG : LIGHT GREEN G : GREEN L : BLUE W : WHITE Y : YELLOW SB : SKY BLUE
 BR : BROWN O : ORANGE GR : GRAY R : RED P : PINK V : VIOLET PU : PURPLE SI : SILVER

MITSUBISHI MULTI-COMMUNICATION SYSTEM (MMCS) (CONTINUED)

11

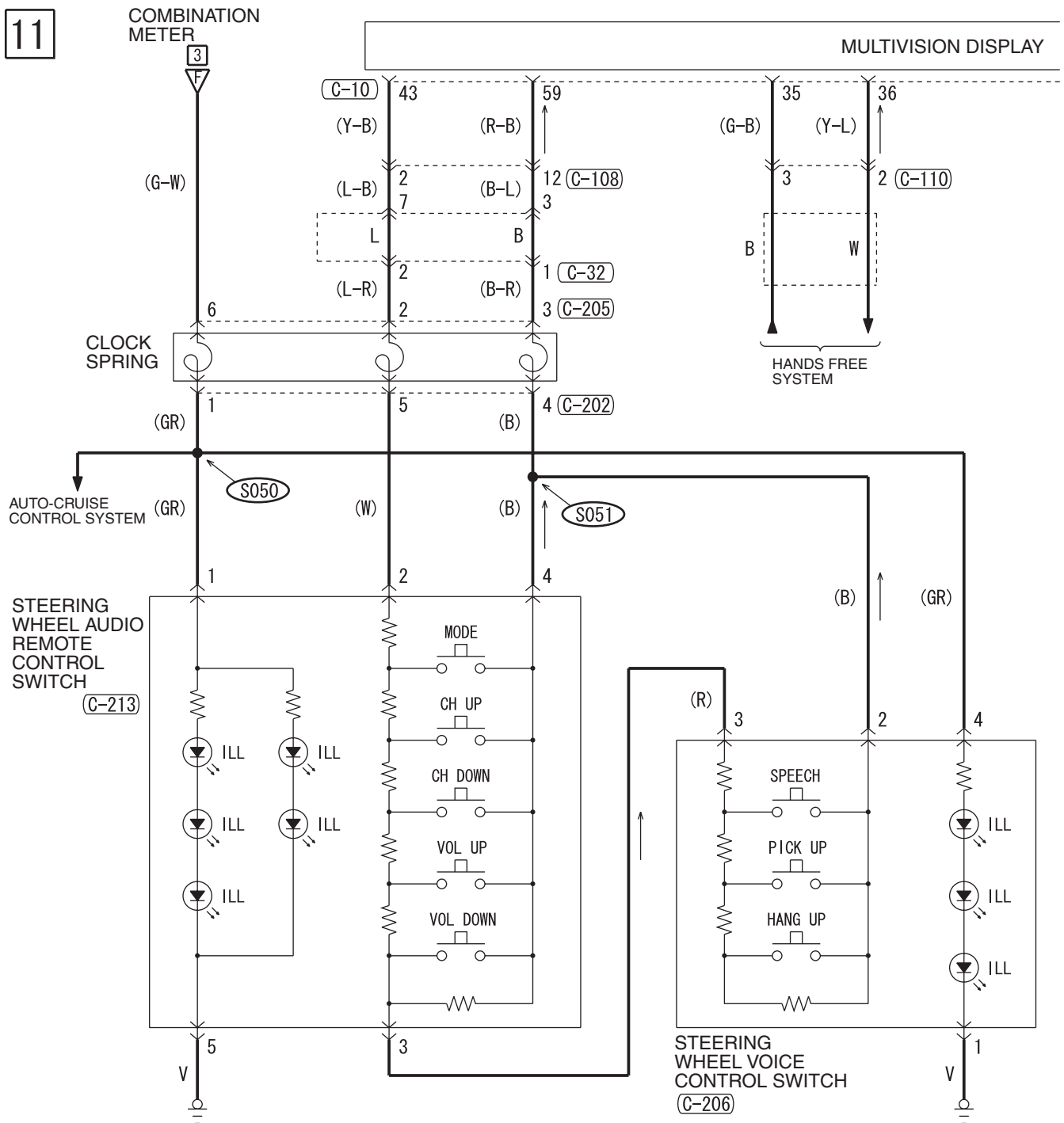

C-10

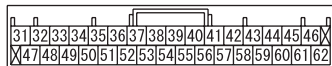

C-13

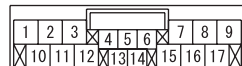

C-32



C-106

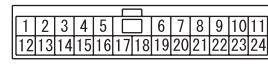

C-108

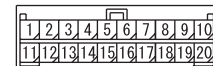

12

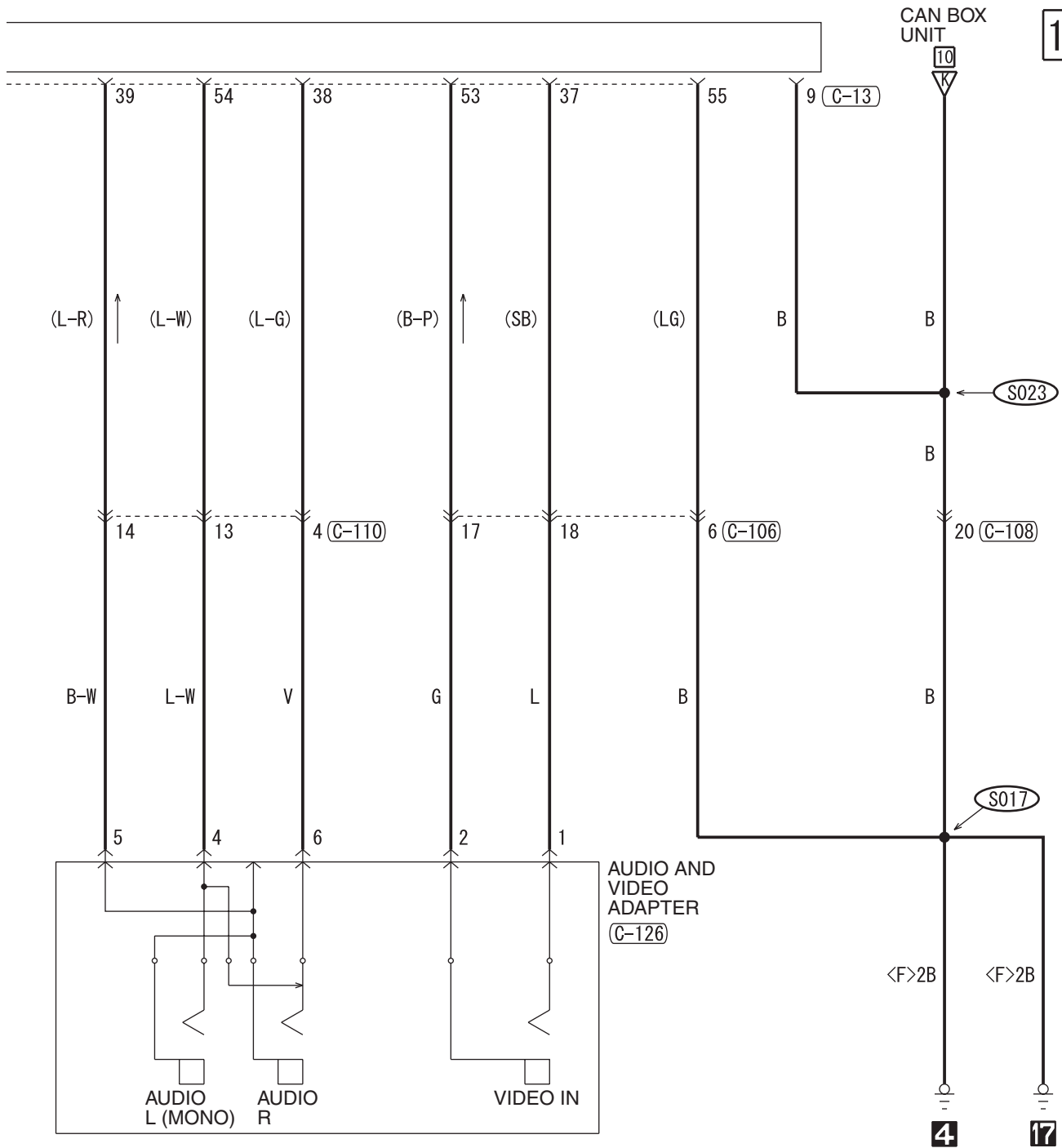

(C-110)

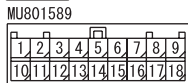

(C-126)

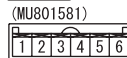

(C-202)

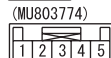

(C-205)

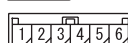

(C-206)



(C-213)

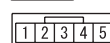

WIRE COLOR CODE

B: BLACK LG: LIGHT GREEN G: GREEN L: BLUE W: WHITE Y: YELLOW SB: SKY BLUE
 BR: BROWN O: ORANGE GR: GRAY R: RED P: PINK V: VIOLET PU: PURPLE SI: SILVER

H8G14M24FB

SPARE CONNECTOR (FOR NAVIGATION SYSTEM)

M1901025000254

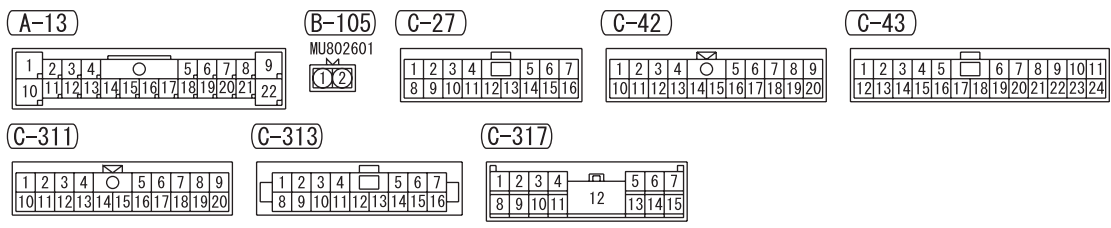
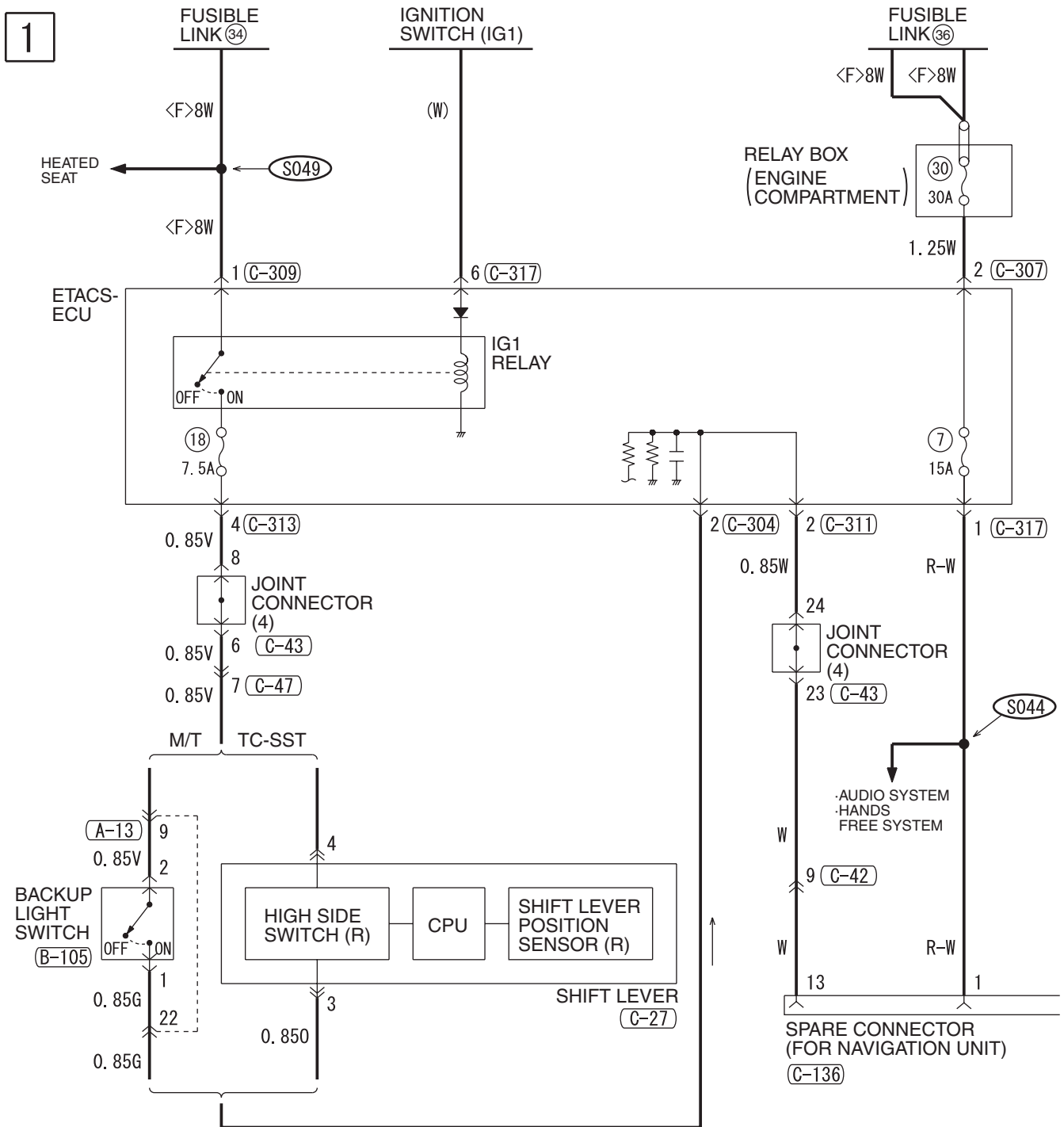

H8G14M25AA

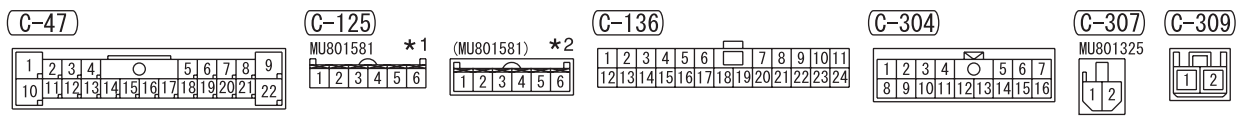
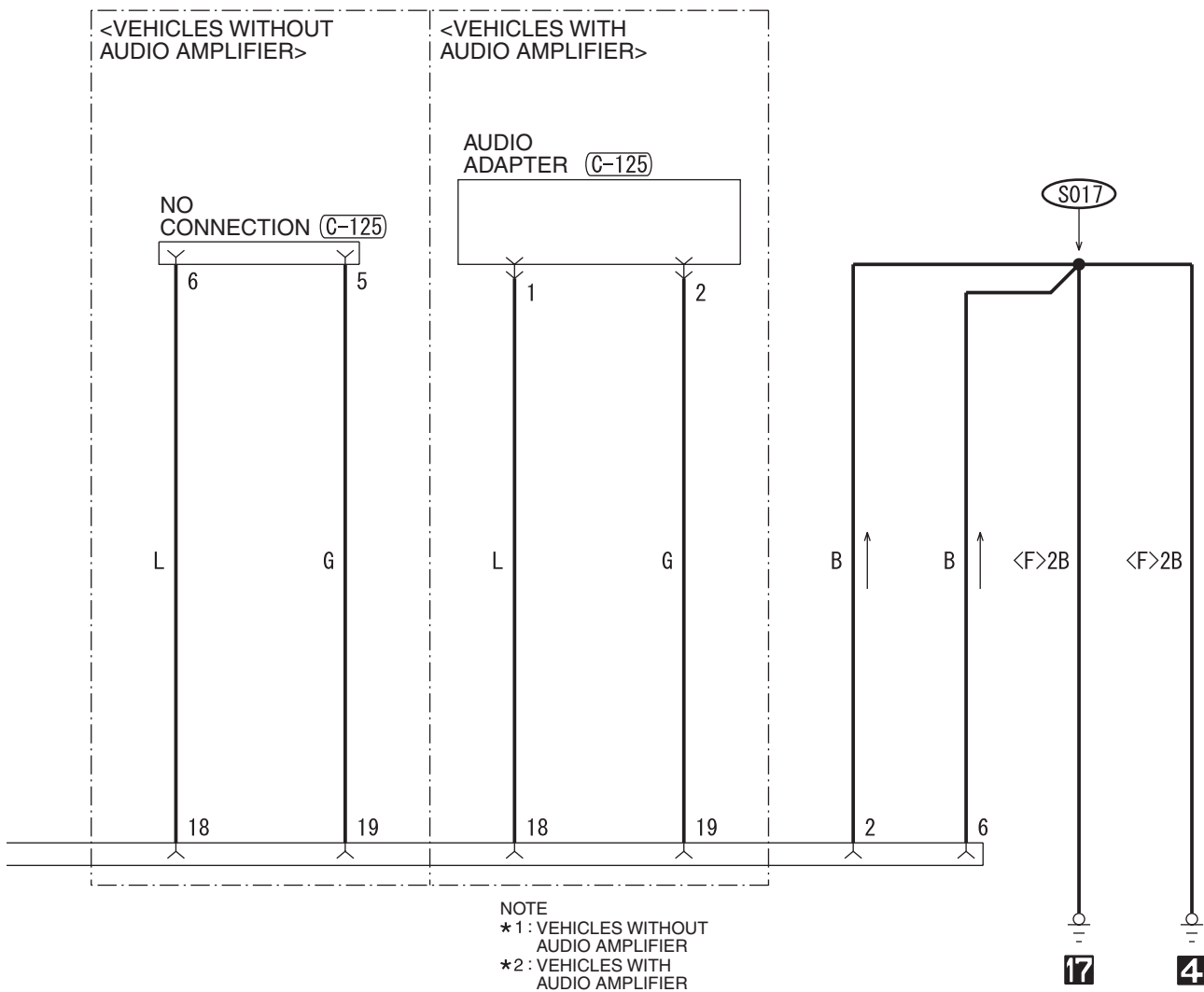

WIRE COLOR CODE
 B : BLACK LG : LIGHT GREEN G : GREEN L : BLUE W : WHITE Y : YELLOW SB : SKY BLUE
 BR : BROWN O : ORANGE GR : GRAY R : RED P : PINK V : VIOLET PU : PURPLE SI : SILVER

ACCESSORY SOCKET AND CIGARETTE LIGHTER

M1901030900059

1

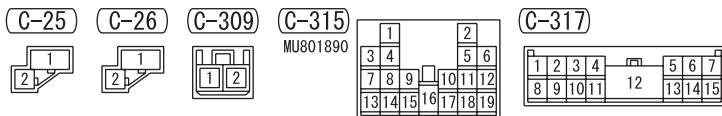
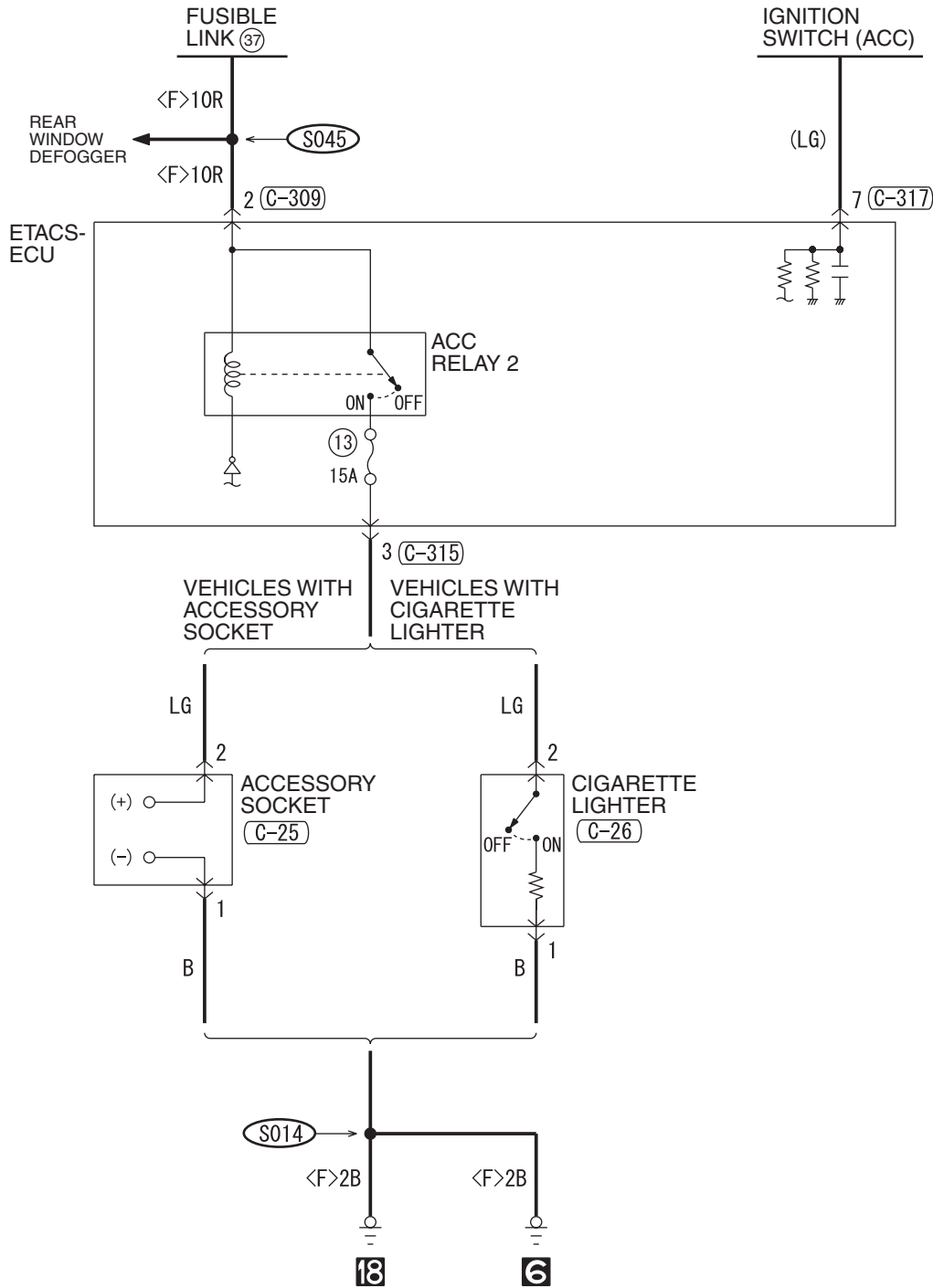

WIRE COLOR CODE

B : BLACK LG : LIGHT GREEN G : GREEN L : BLUE W : WHITE Y : YELLOW SB : SKY BLUE
BR : BROWN O : ORANGE GR : GRAY R : RED P : PINK V : VIOLET PU : PURPLE SI : SILVER

H8G14M26AA

NOTES

ABS, ASC, ACD, AYC AND S-AWC <M/T>

M1901032500057

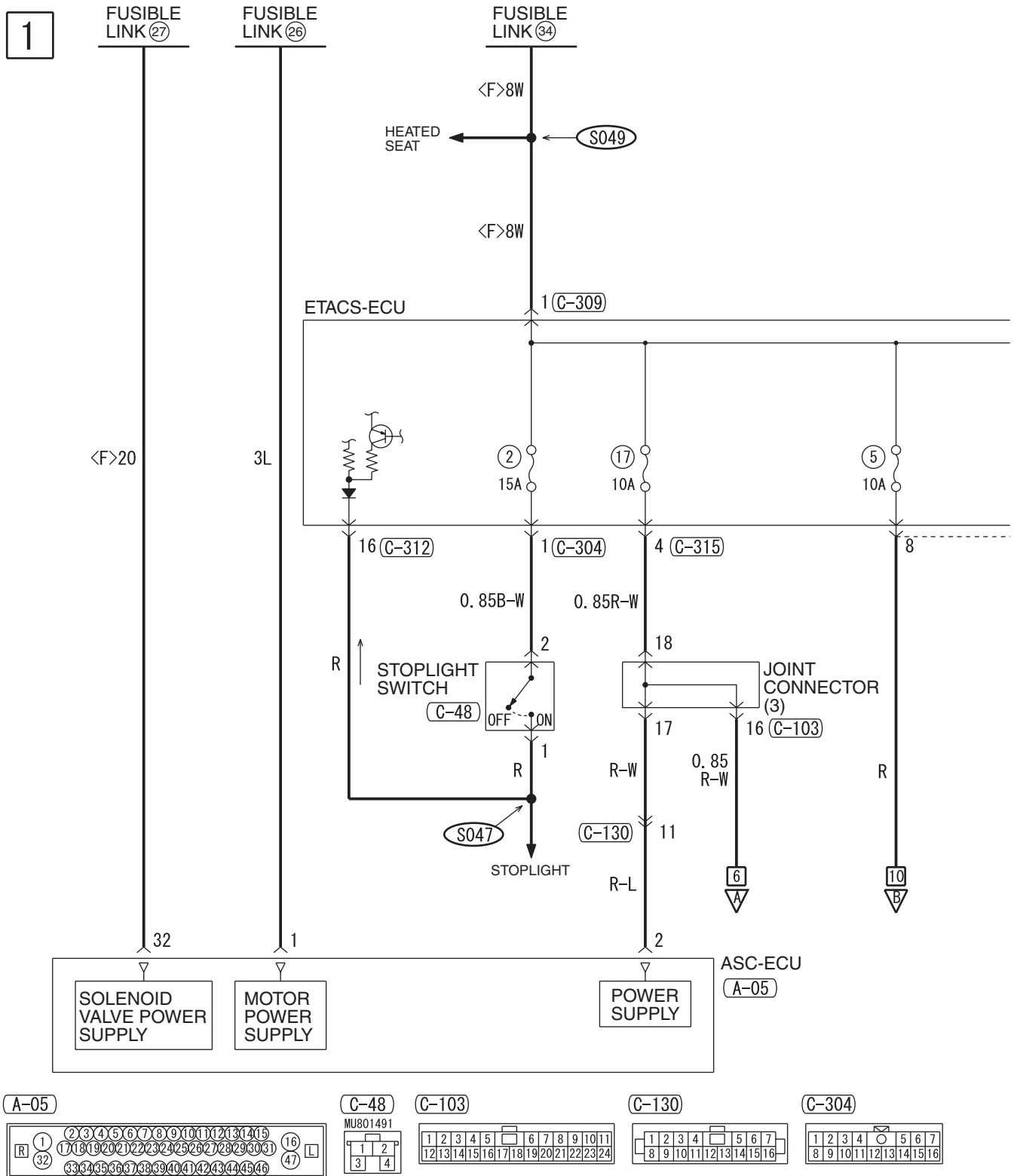

H8G15M36AA

2

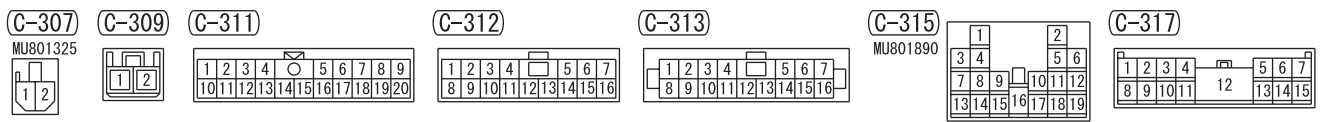
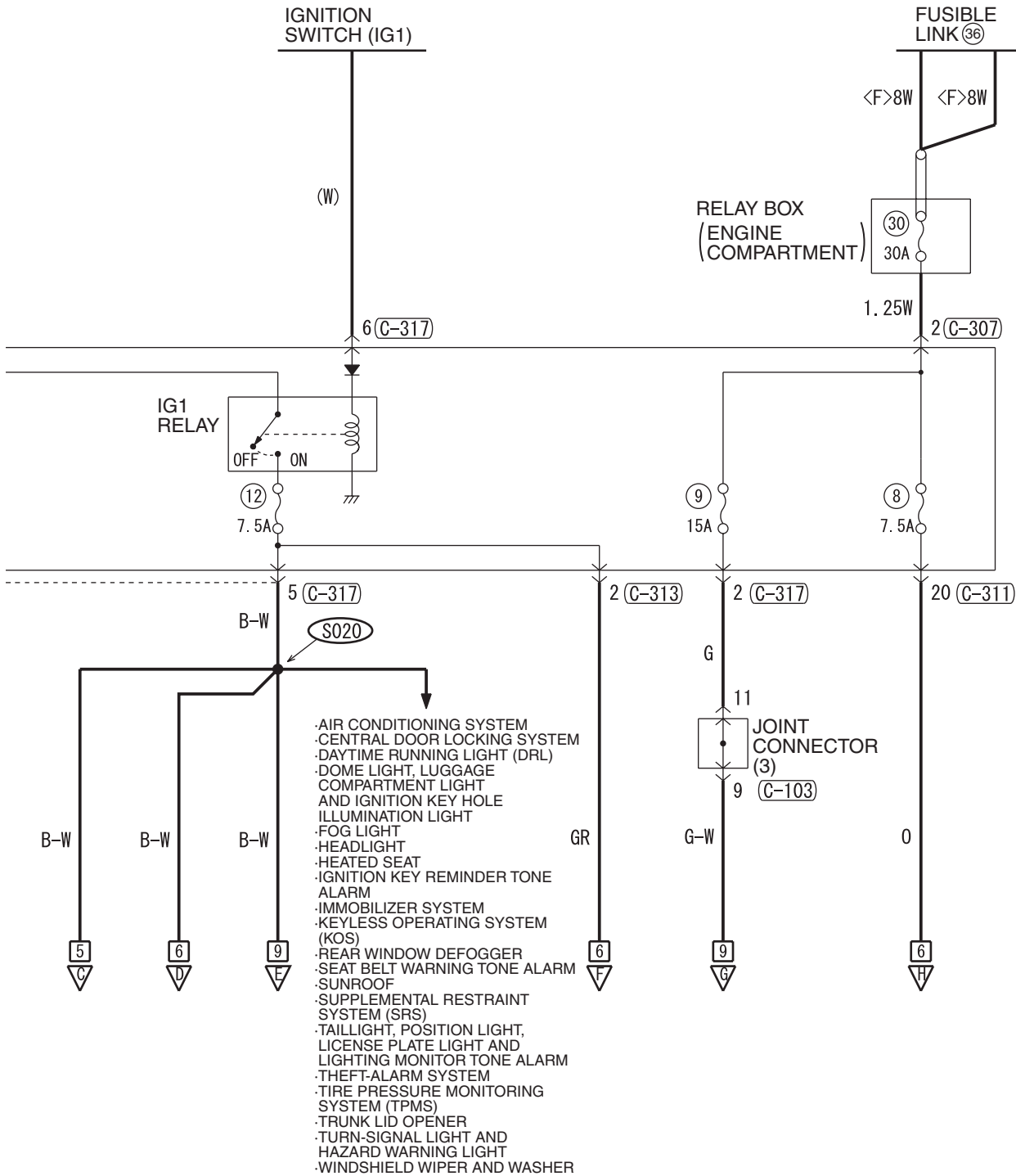

WIRE COLOR CODE
 B: BLACK LG: LIGHT GREEN G: GREEN L: BLUE W: WHITE Y: YELLOW SB: SKY BLUE
 BR: BROWN O: ORANGE GR: GRAY R: RED P: PINK V: VIOLET PU: PURPLE SI: SILVER

H8G15M36AB

TSB Revision

ABS, ASC, ACD, AYC AND S-AWC <M/T> (CONTINUED)

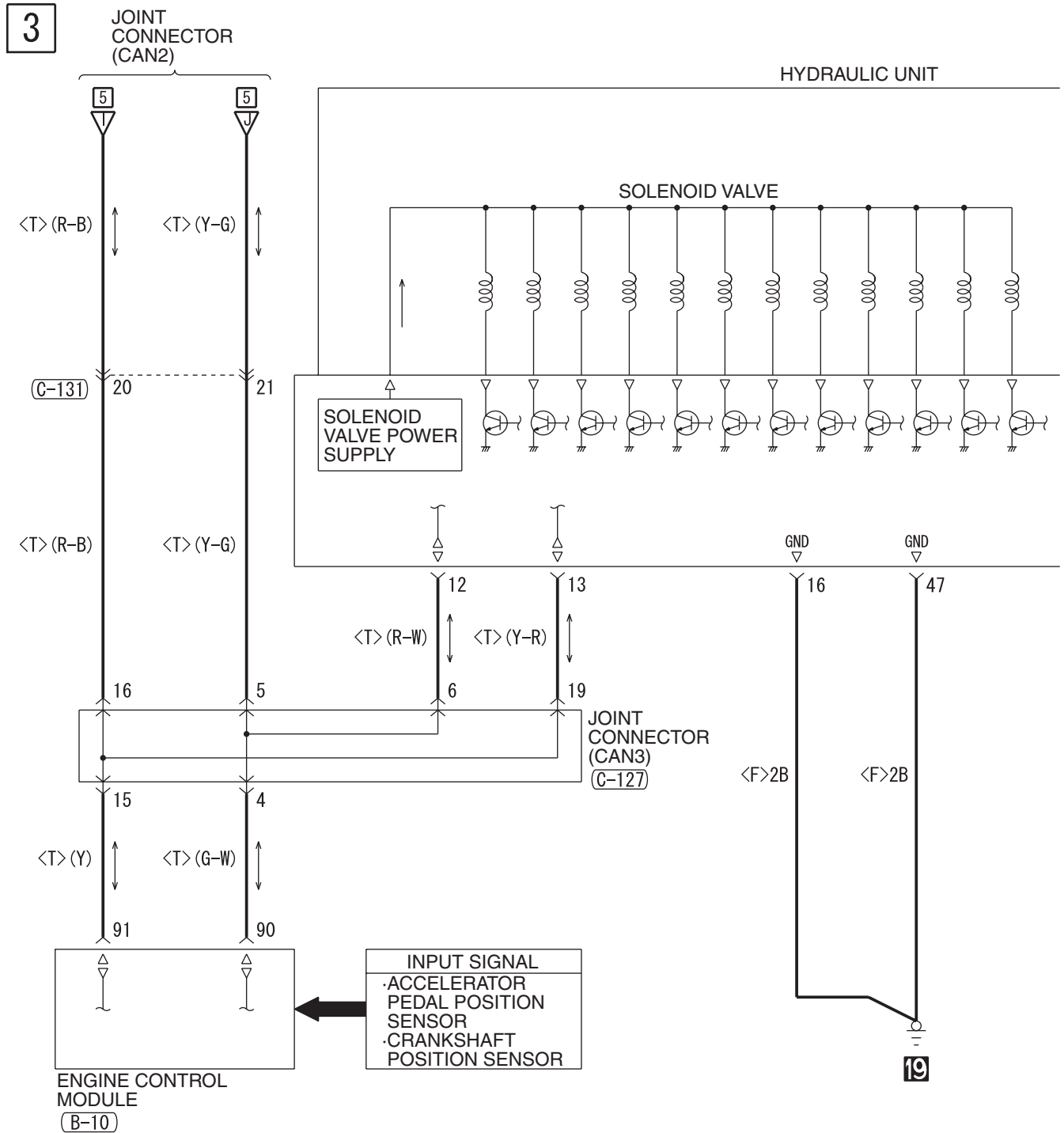

(A-03)

(A-05)

(A-11)

(B-10)

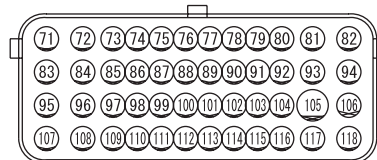
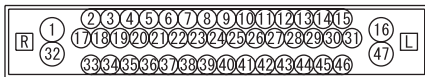

4

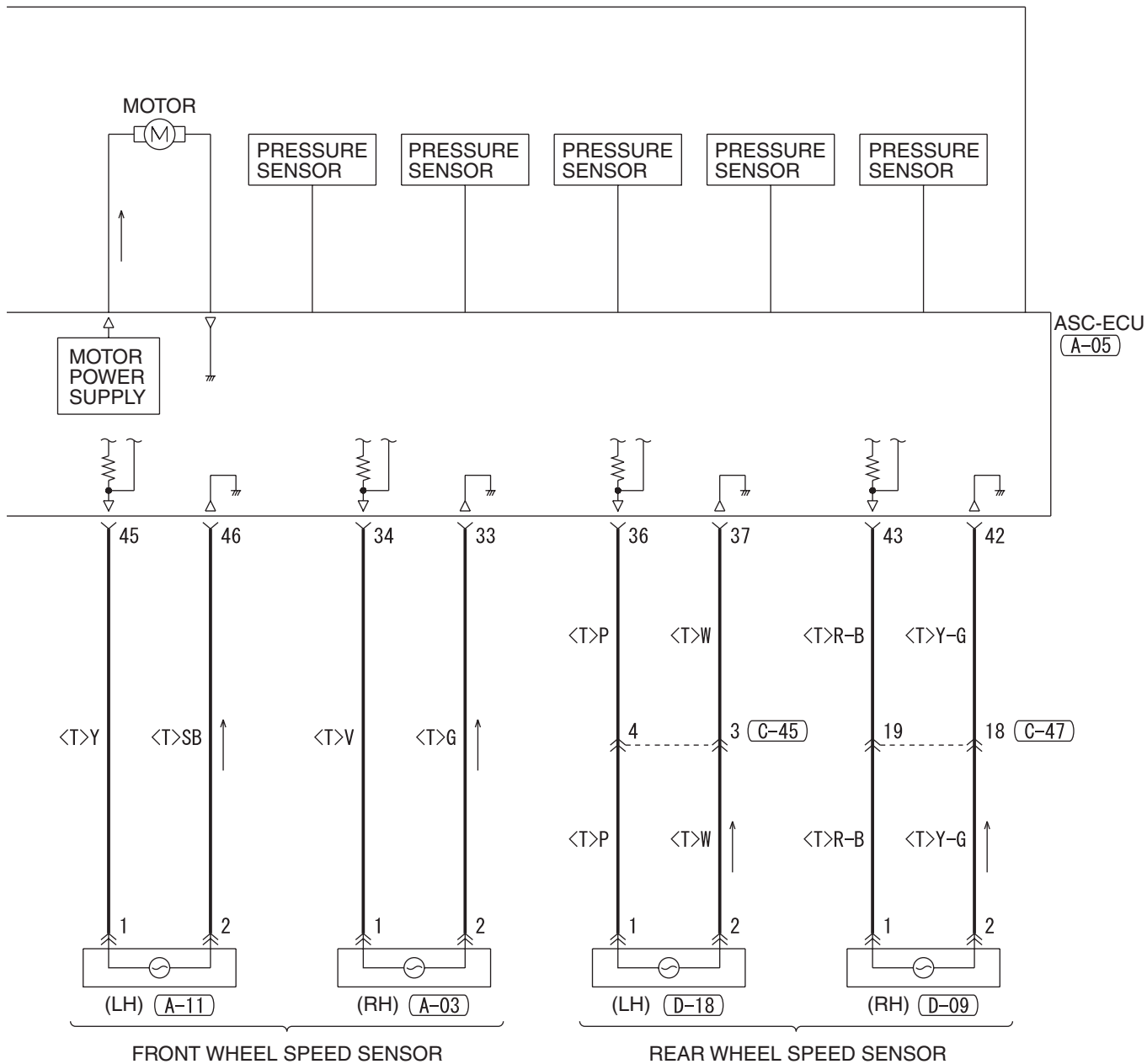

(C-45)

(C-47)

(C-127)

(C-131)

(D-09)

(D-18)

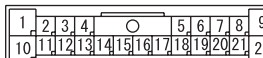
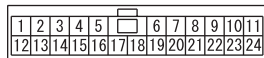

WIRE COLOR CODE

B: BLACK LG: LIGHT GREEN G: GREEN L: BLUE W: WHITE Y: YELLOW SB: SKY BLUE
BR: BROWN O: ORANGE GR: GRAY R: RED P: PINK V: VIOLET PU: PURPLE SI: SILVER

H8G15M36BB

TSB Revision

ABS, ASC, ACD, AYC AND S-AWC <M/T> (CONTINUED)

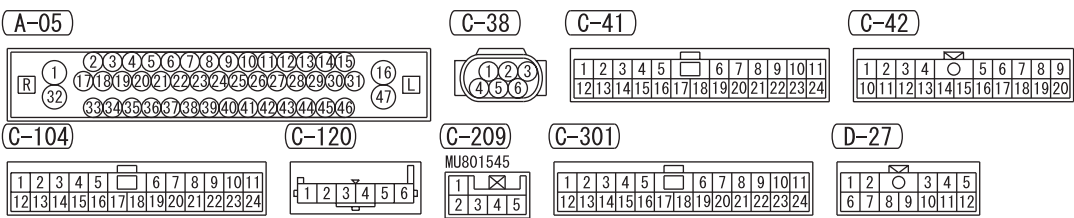
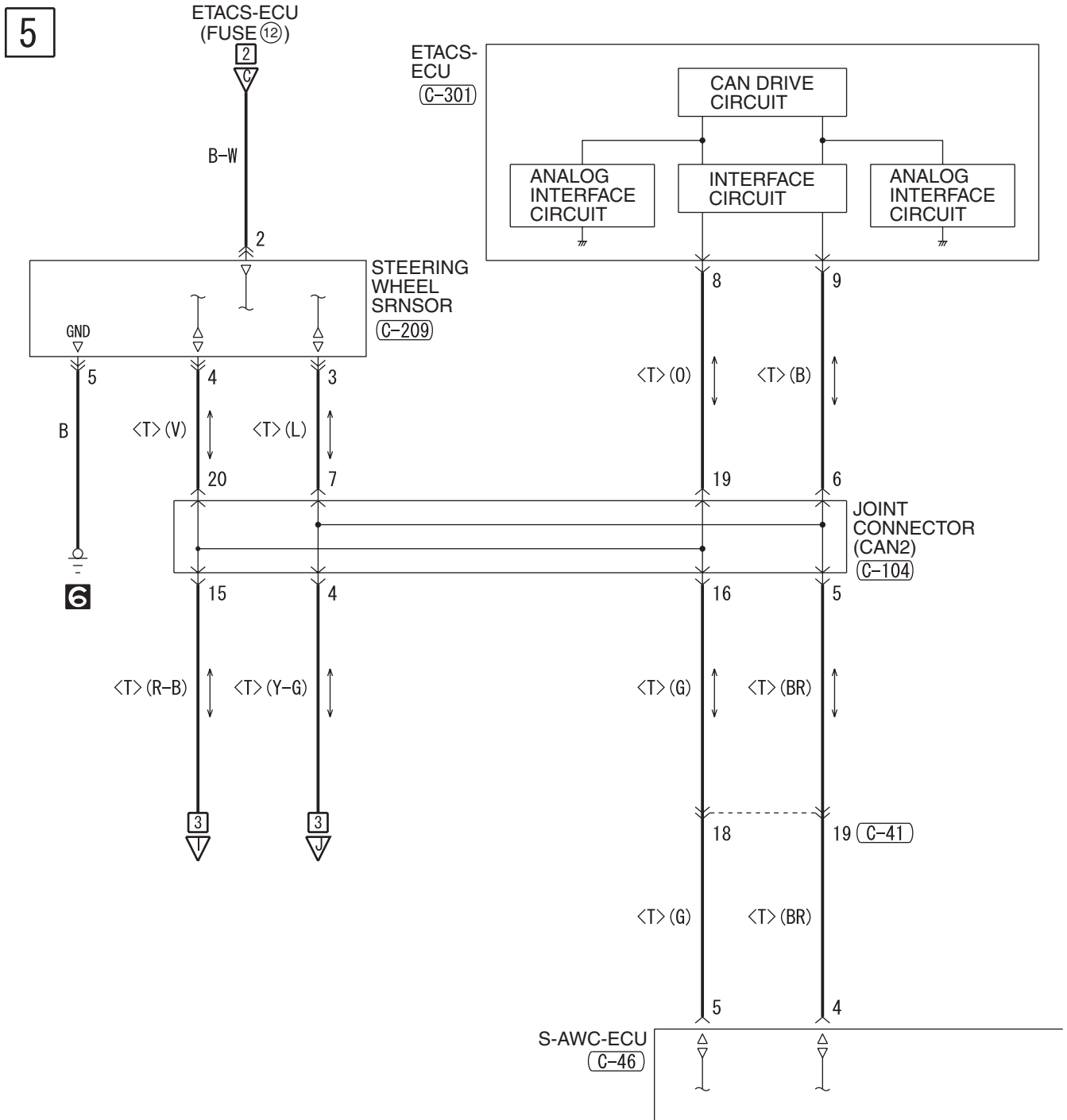

6

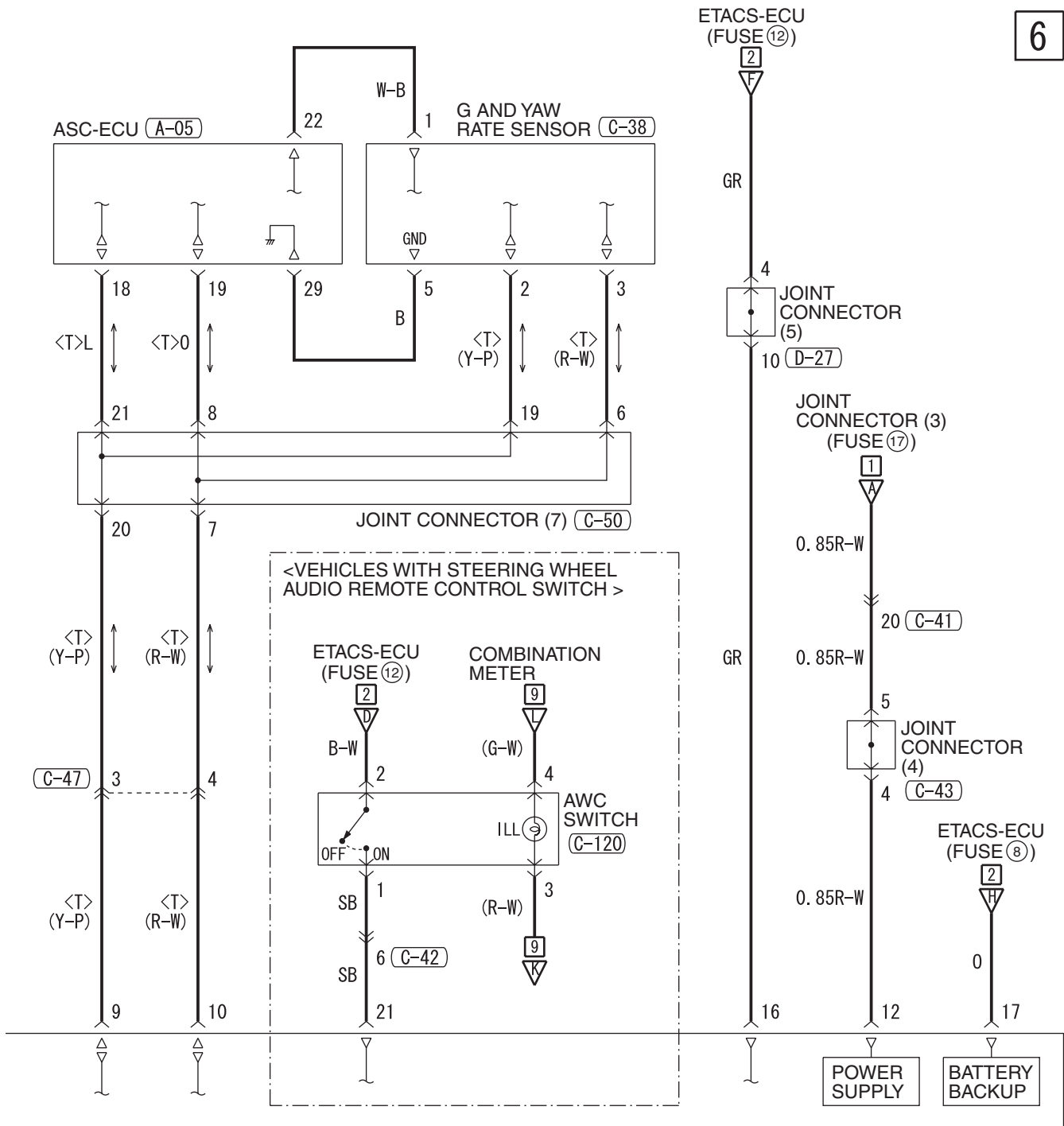

C-43

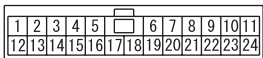

C-46



C-47

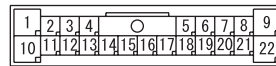

C-50

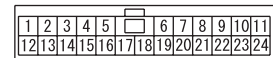

WIRE COLOR CODE

B : BLACK LG : LIGHT GREEN G : GREEN L : BLUE W : WHITE Y : YELLOW SB : SKY BLUE
BR : BROWN O : ORANGE GR : GRAY R : RED P : PINK V : VIOLET PU : PURPLE SI : SILVER

ABS, ASC, ACD, AYC AND S-AWC <M/T> (CONTINUED)

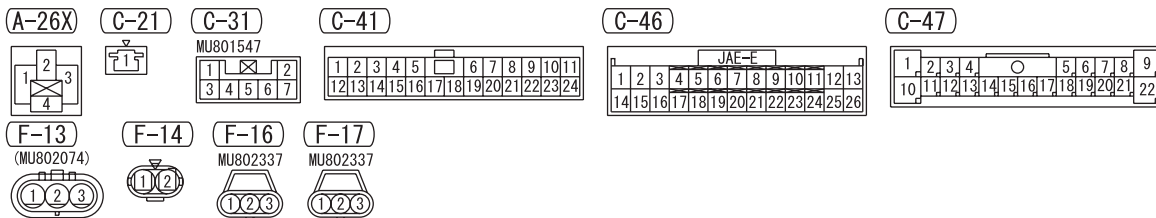
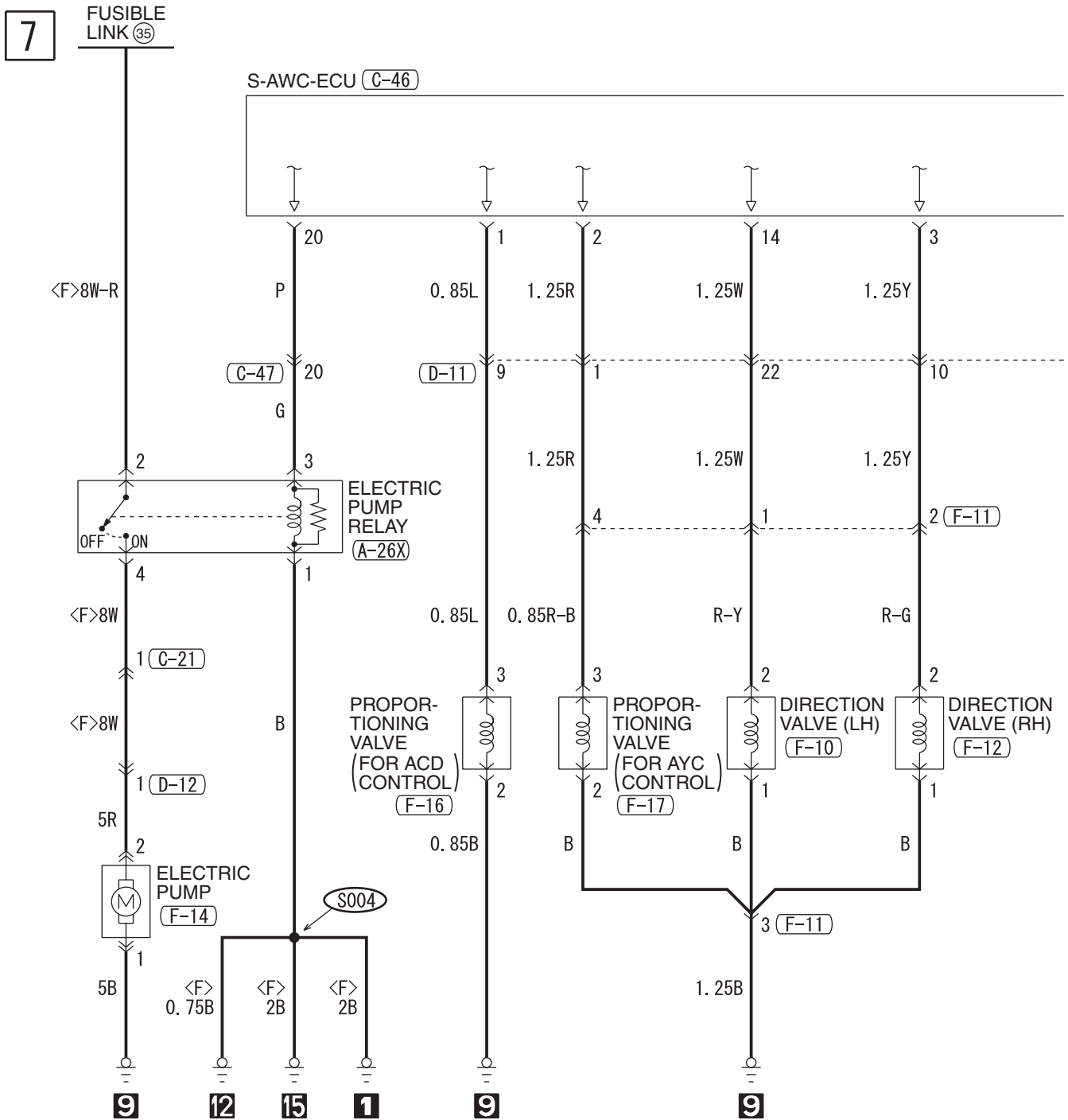

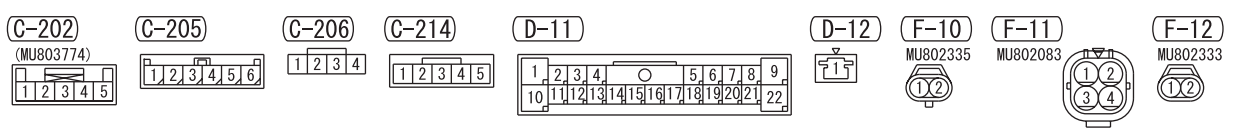
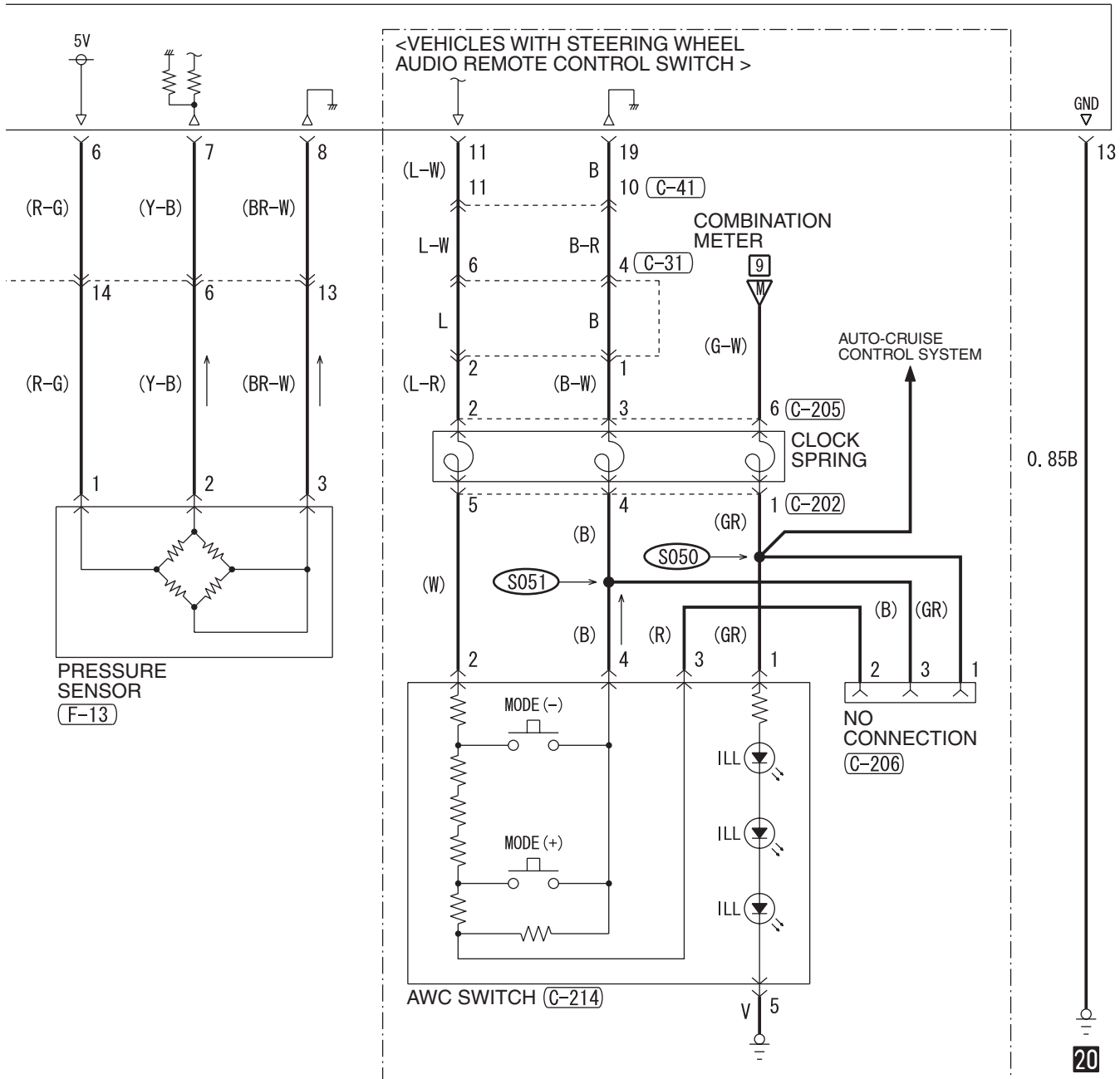

WIRE COLOR CODE
 B : BLACK LG : LIGHT GREEN G : GREEN L : BLUE W : WHITE Y : YELLOW SB : SKY BLUE
 BR : BROWN O : ORANGE GR : GRAY R : RED P : PINK V : VIOLET PU : PURPLE SI : SILVER

ABS, ASC, ACD, AYC AND S-AWC <M/T> (CONTINUED)

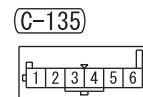
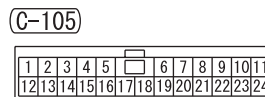
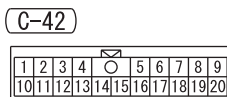
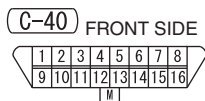
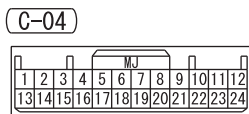
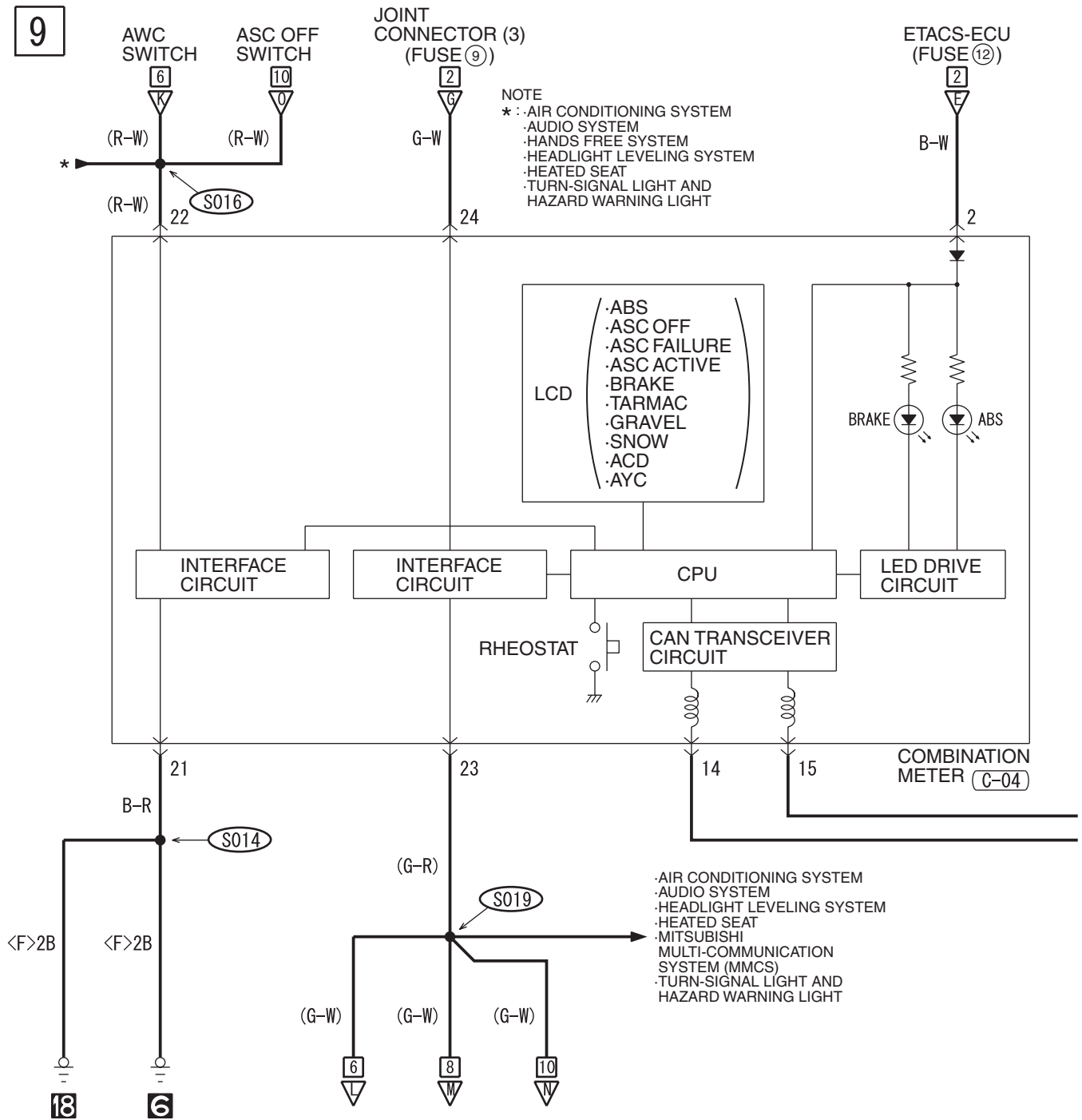

10

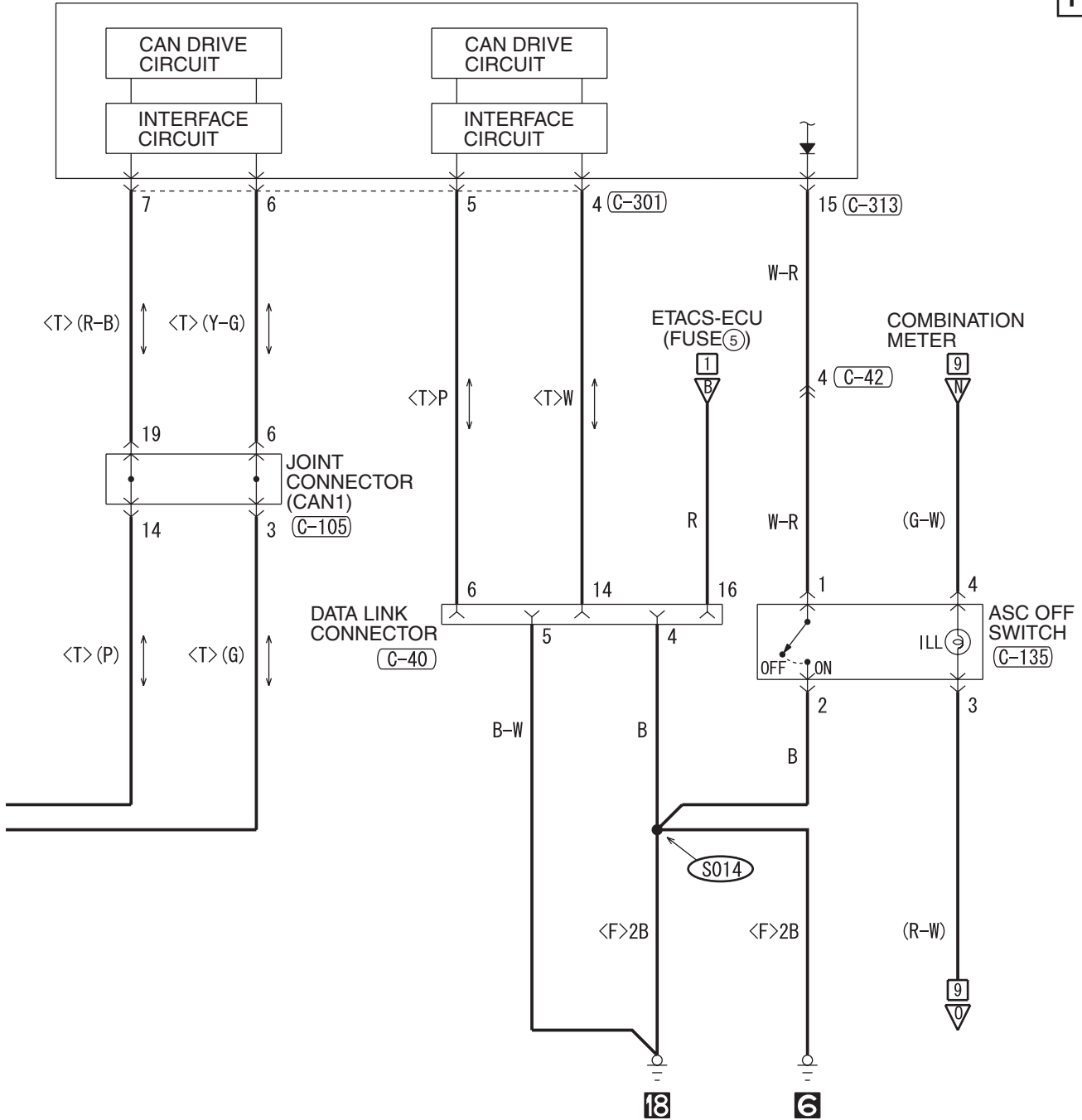

(C-301)

(C-313)

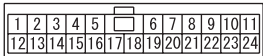

WIRE COLOR CODE

B : BLACK LG : LIGHT GREEN G : GREEN L : BLUE W : WHITE Y : YELLOW SB : SKY BLUE
BR : BROWN O : ORANGE GR : GRAY R : RED P : PINK V : VIOLET PU : PURPLE SI : SILVER

H8G15M36EB

TSB Revision

ABS, ASC, ACD, AYC AND S-AWC <TC-SST>

M1901032500068

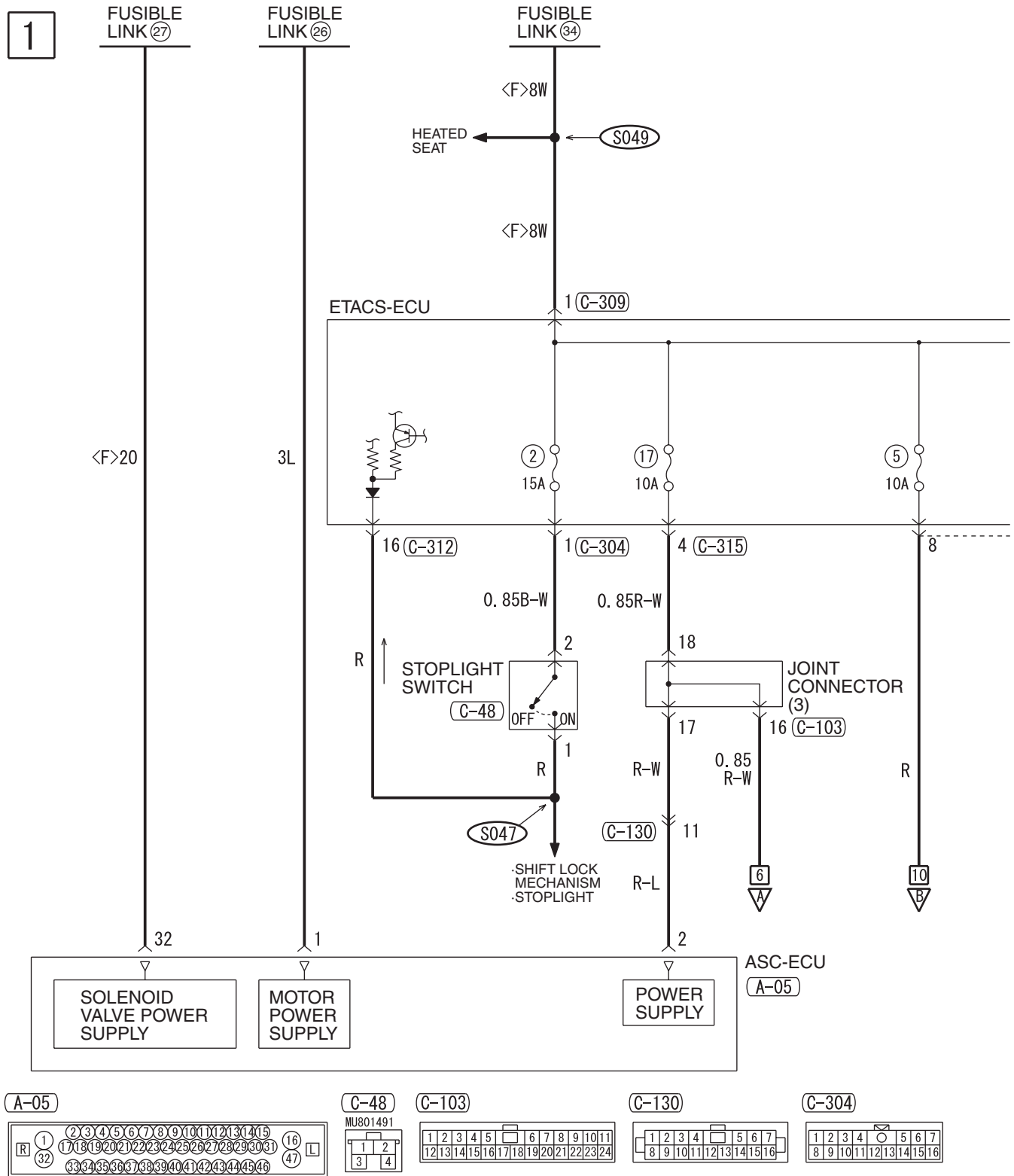

H8G15M37AA

2

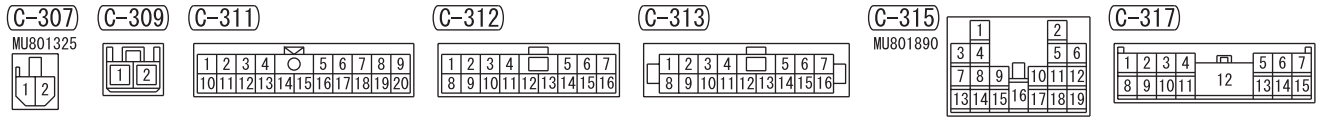
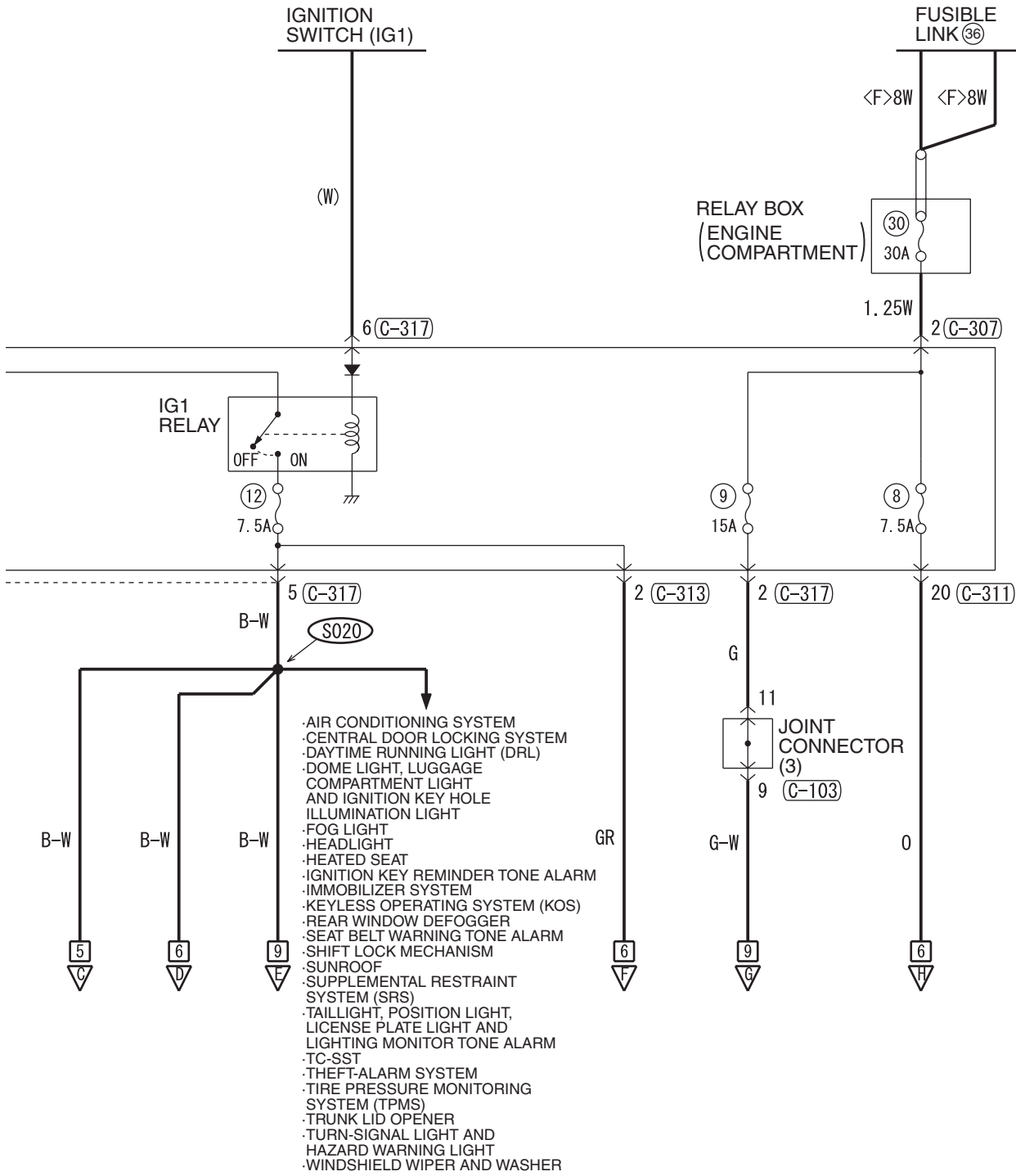

WIRE COLOR CODE
 B: BLACK LG: LIGHT GREEN G: GREEN L: BLUE W: WHITE Y: YELLOW SB: SKY BLUE
 BR: BROWN O: ORANGE GR: GRAY R: RED P: PINK V: VIOLET PU: PURPLE SI: SILVER

H8G15M37AB

ABS, ASC, ACD, AYC AND S-AWC <TC-SST> (CONTINUED)

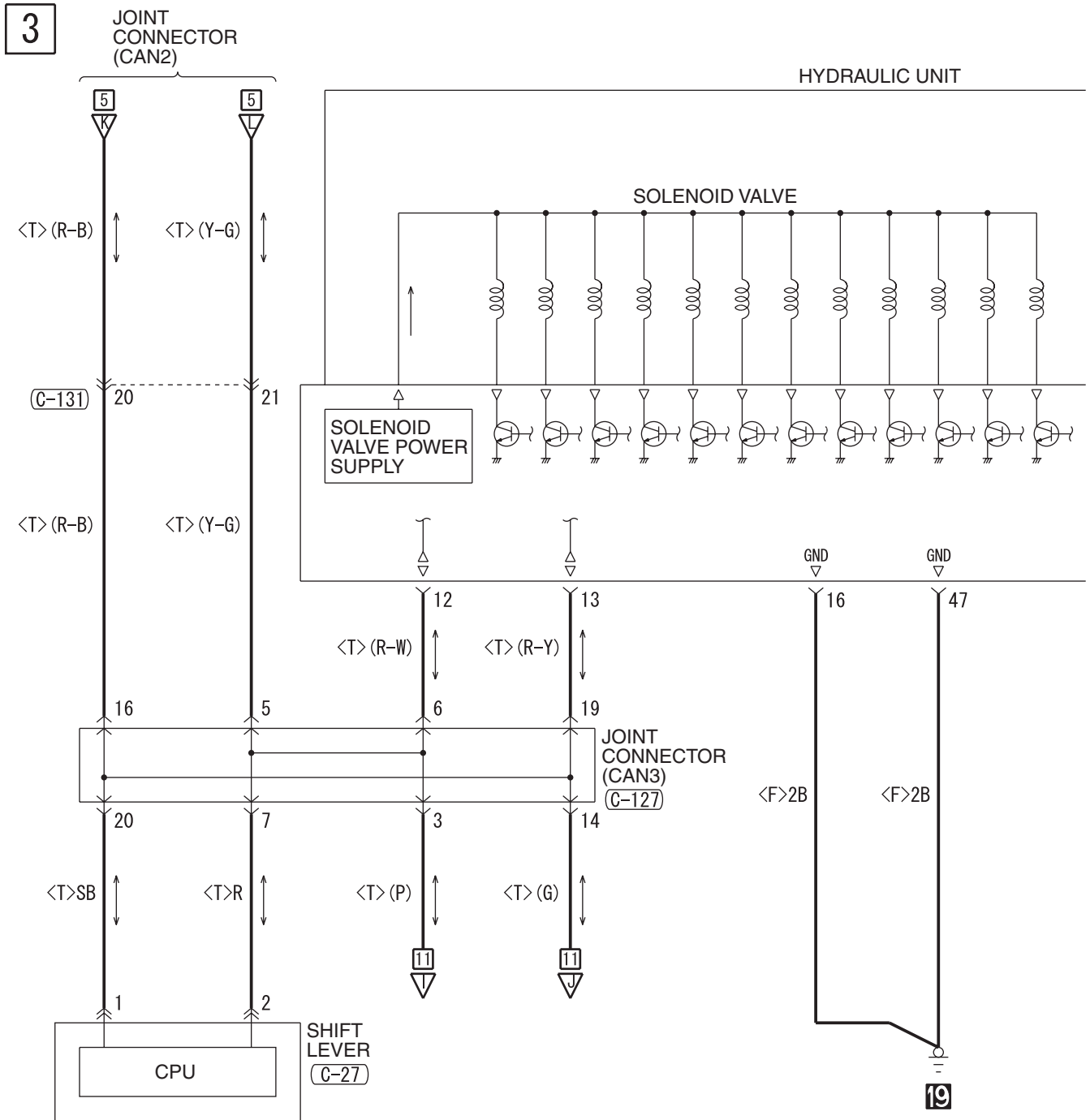

(A-03)

(A-05)

(A-11)

(C-27)

(C-45)

(C-47)

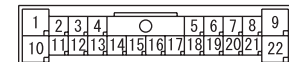
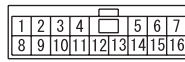
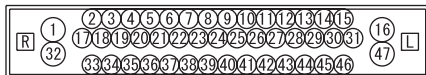

4

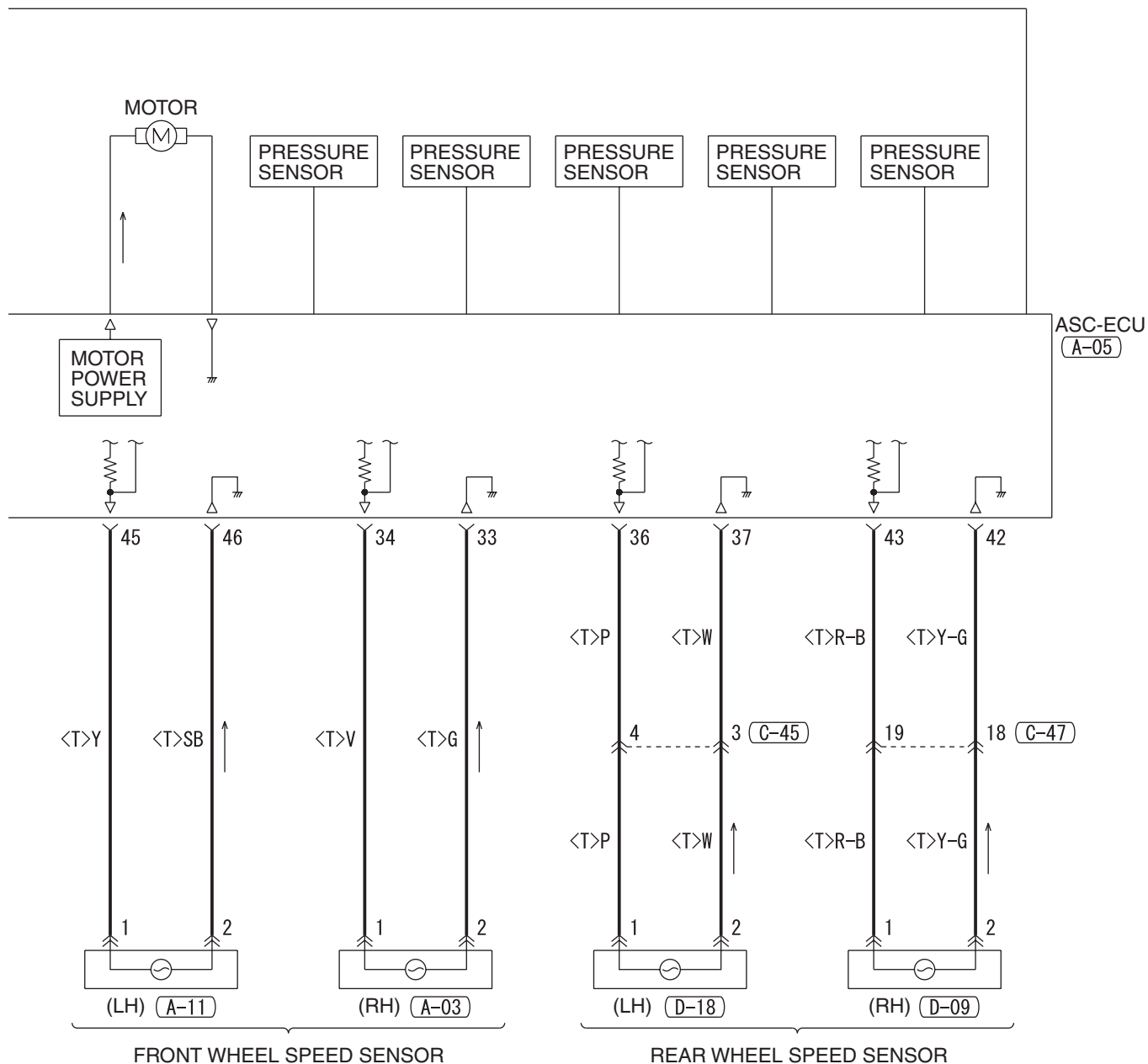

(C-127)

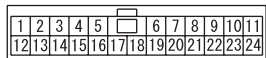

(C-131)

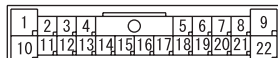

(D-09) (D-18)



WIRE COLOR CODE
B: BLACK LG: LIGHT GREEN G: GREEN L: BLUE W: WHITE Y: YELLOW SB: SKY BLUE
BR: BROWN O: ORANGE GR: GRAY R: RED P: PINK V: VIOLET PU: PURPLE SI: SILVER

H8G15M37BB

ABS, ASC, ACD, AYC AND S-AWC <TC-SST> (CONTINUED)

5

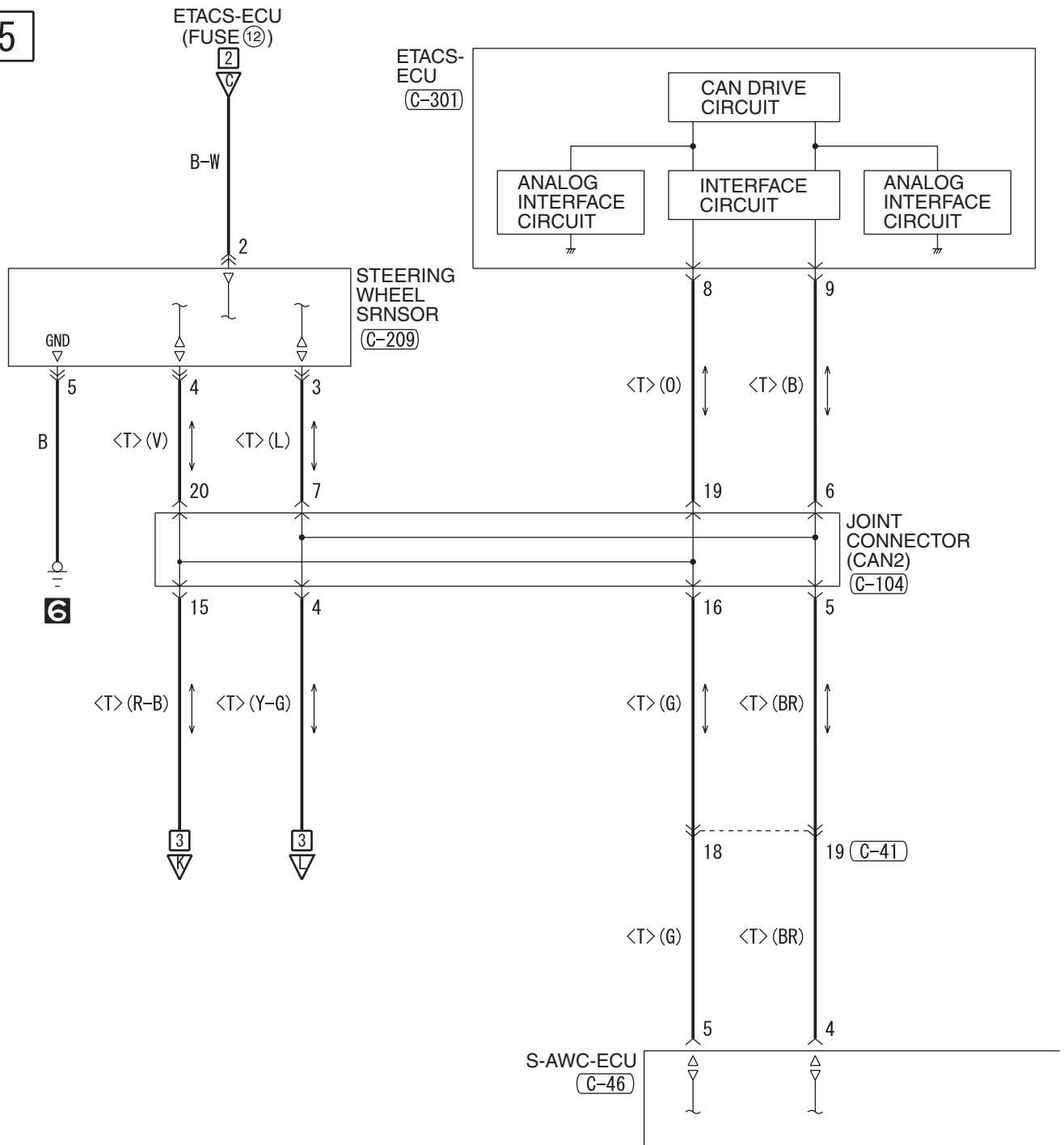

A-05

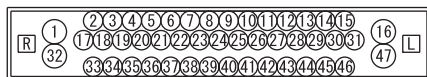

C-38



C-41

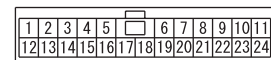

C-42

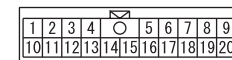

C-104

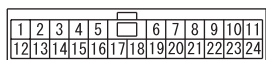

C-120

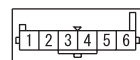

C-209



C-301



D-27

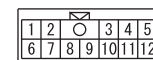

6

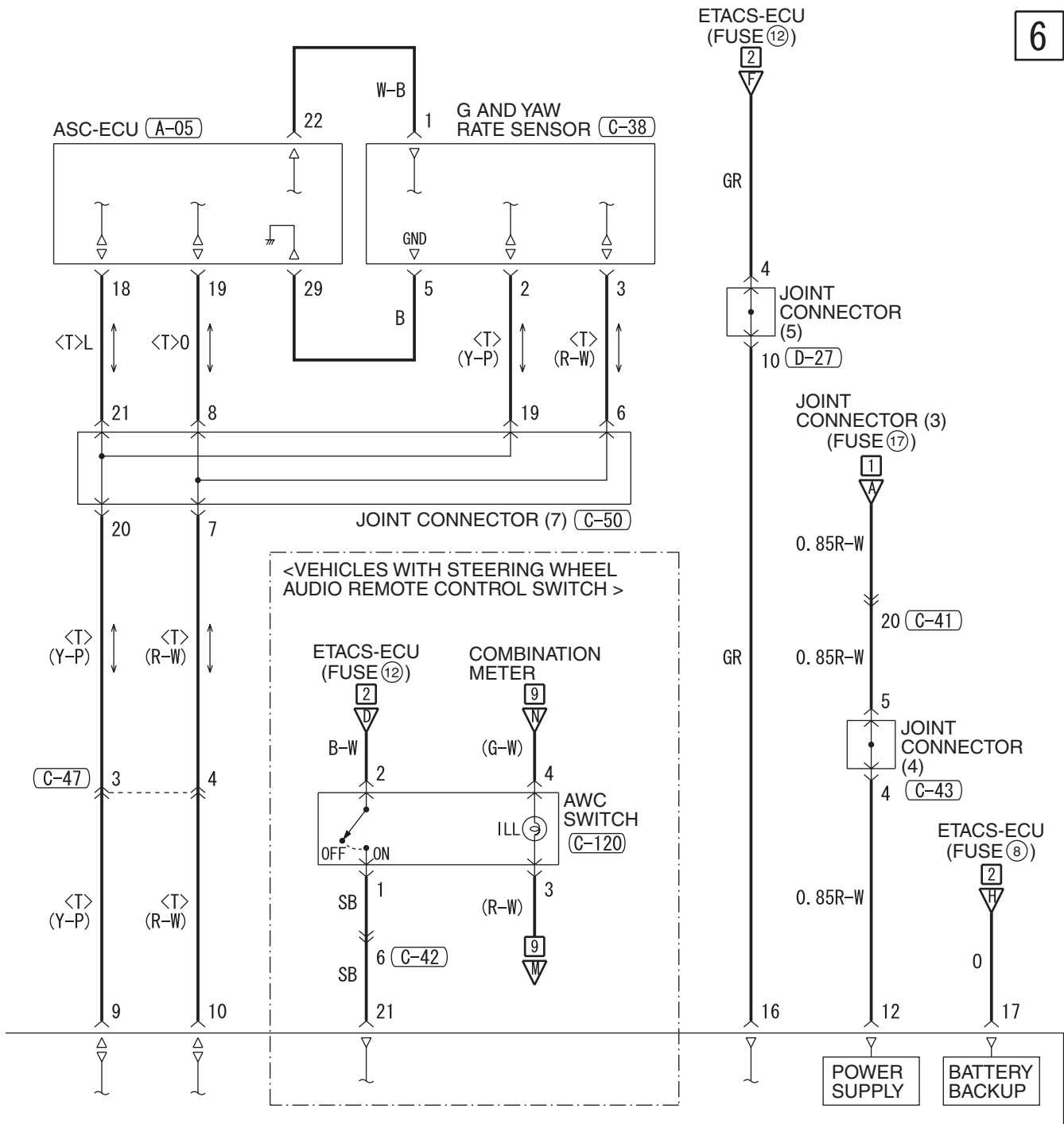

C-43

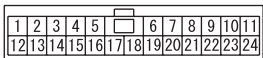

C-46



C-47

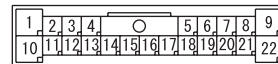

C-50

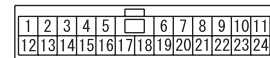

WIRE COLOR CODE

B : BLACK LG : LIGHT GREEN G : GREEN L : BLUE W : WHITE Y : YELLOW SB : SKY BLUE
 BR : BROWN O : ORANGE GR : GRAY R : RED P : PINK V : VIOLET PU : PURPLE SI : SILVER

ABS, ASC, ACD, AYC AND S-AWC <TC-SST> (CONTINUED)

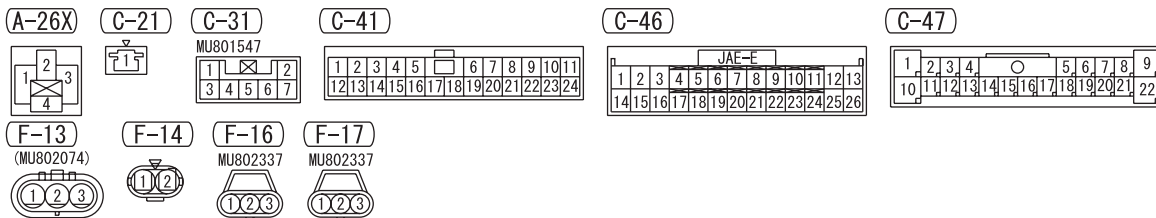
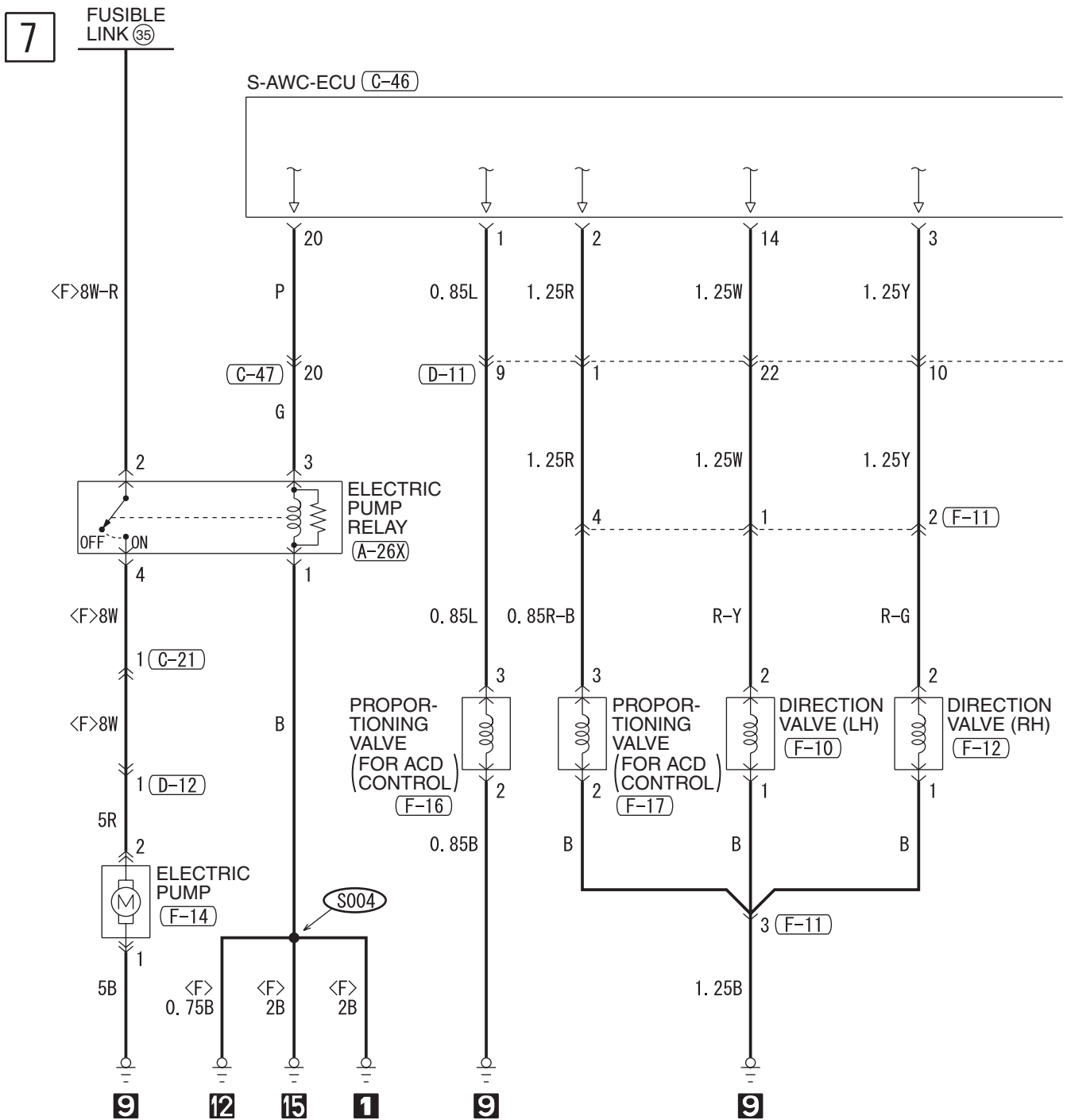

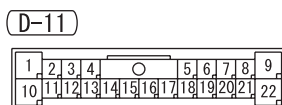
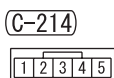
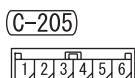
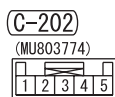
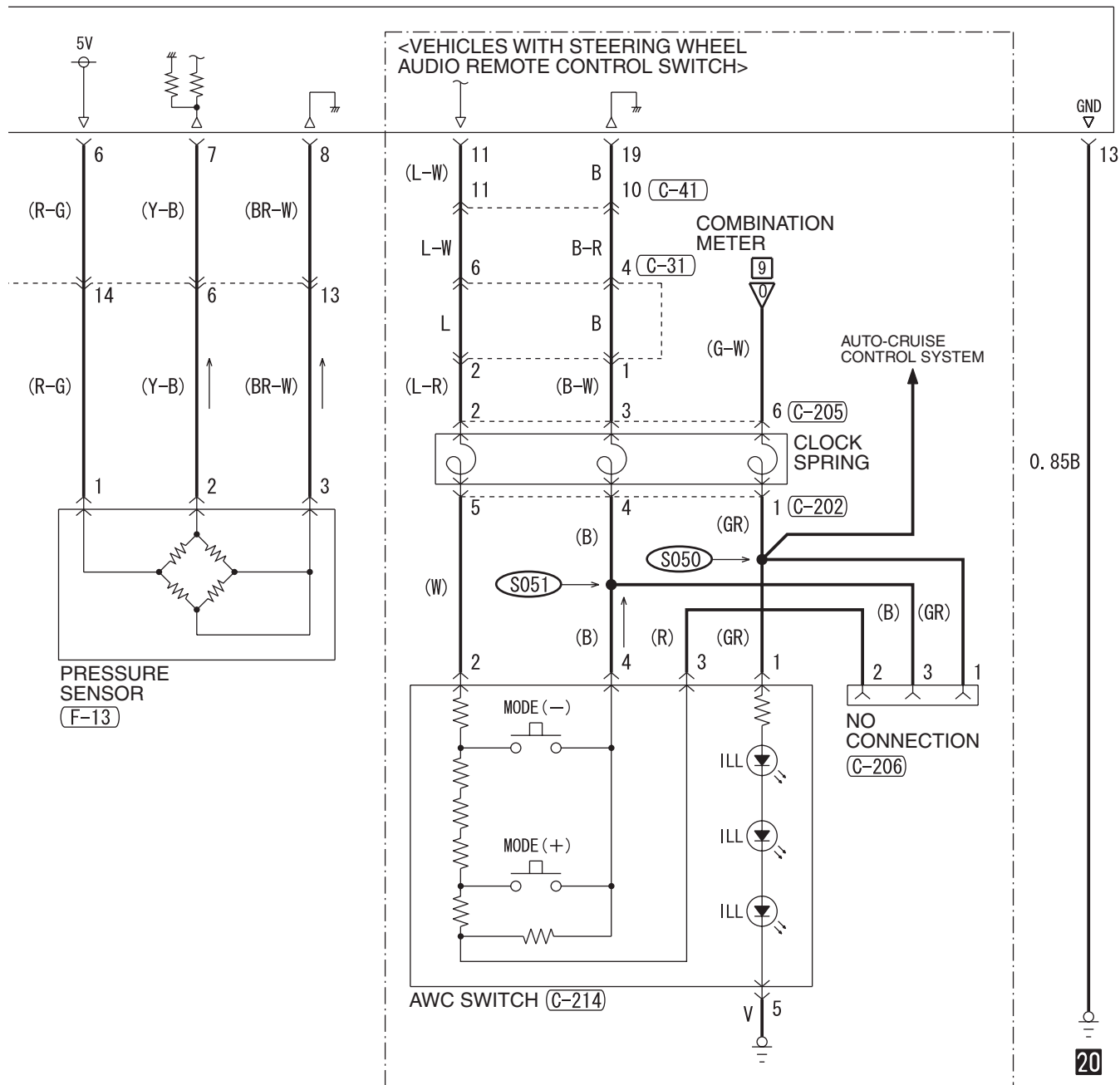

WIRE COLOR CODE

B: BLACK LG: LIGHT GREEN G: GREEN L: BLUE W: WHITE Y: YELLOW SB: SKY BLUE
BR: BROWN O: ORANGE GR: GRAY R: RED P: PINK V: VIOLET PU: PURPLE SI: SILVER

ABS, ASC, ACD, AYC AND S-AWC <TC-SST> (CONTINUED)

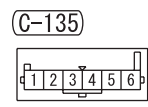
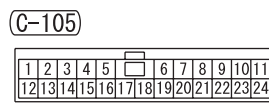
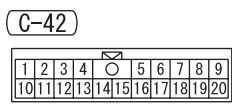
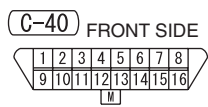
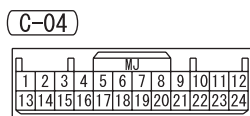
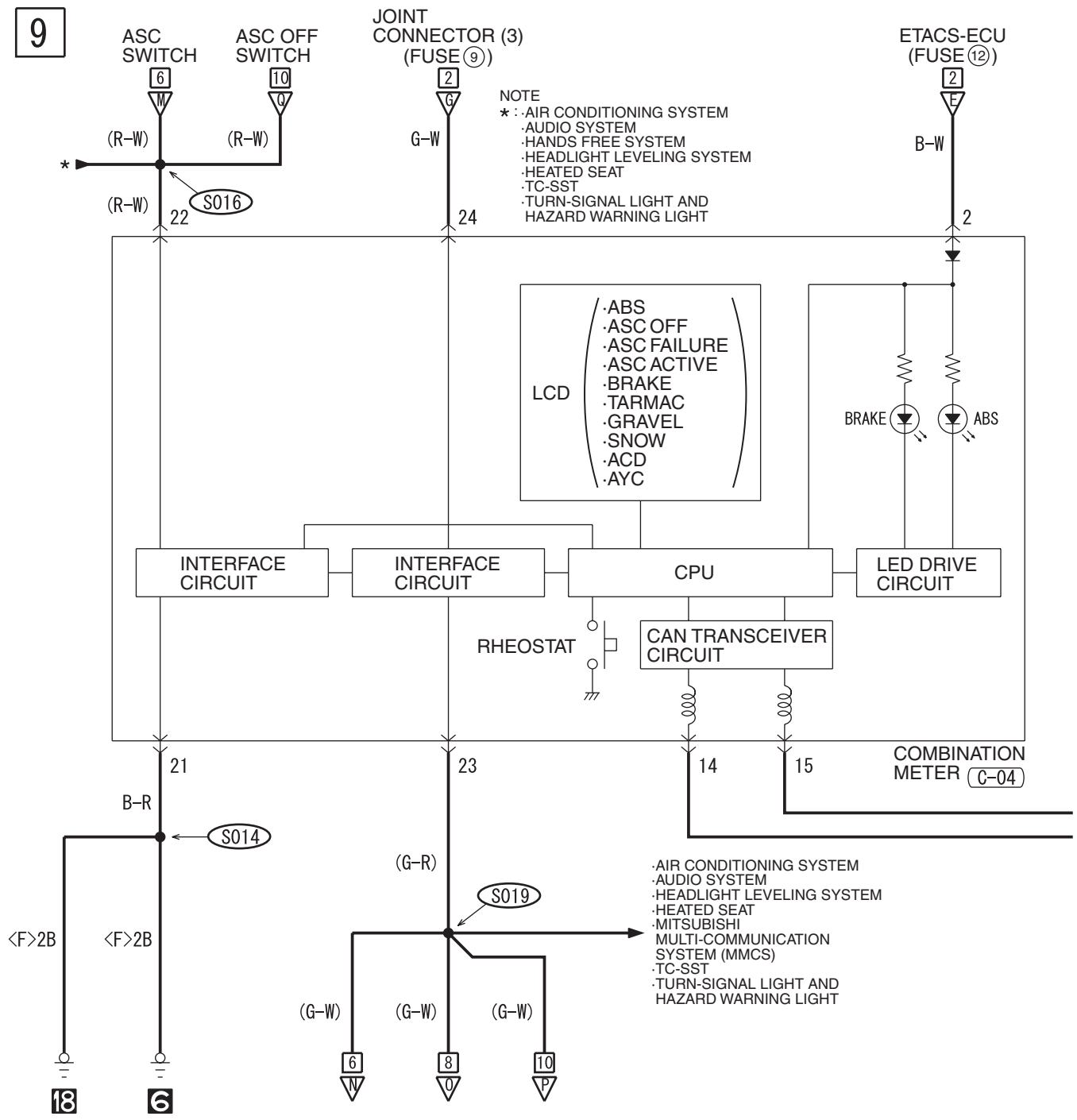

10

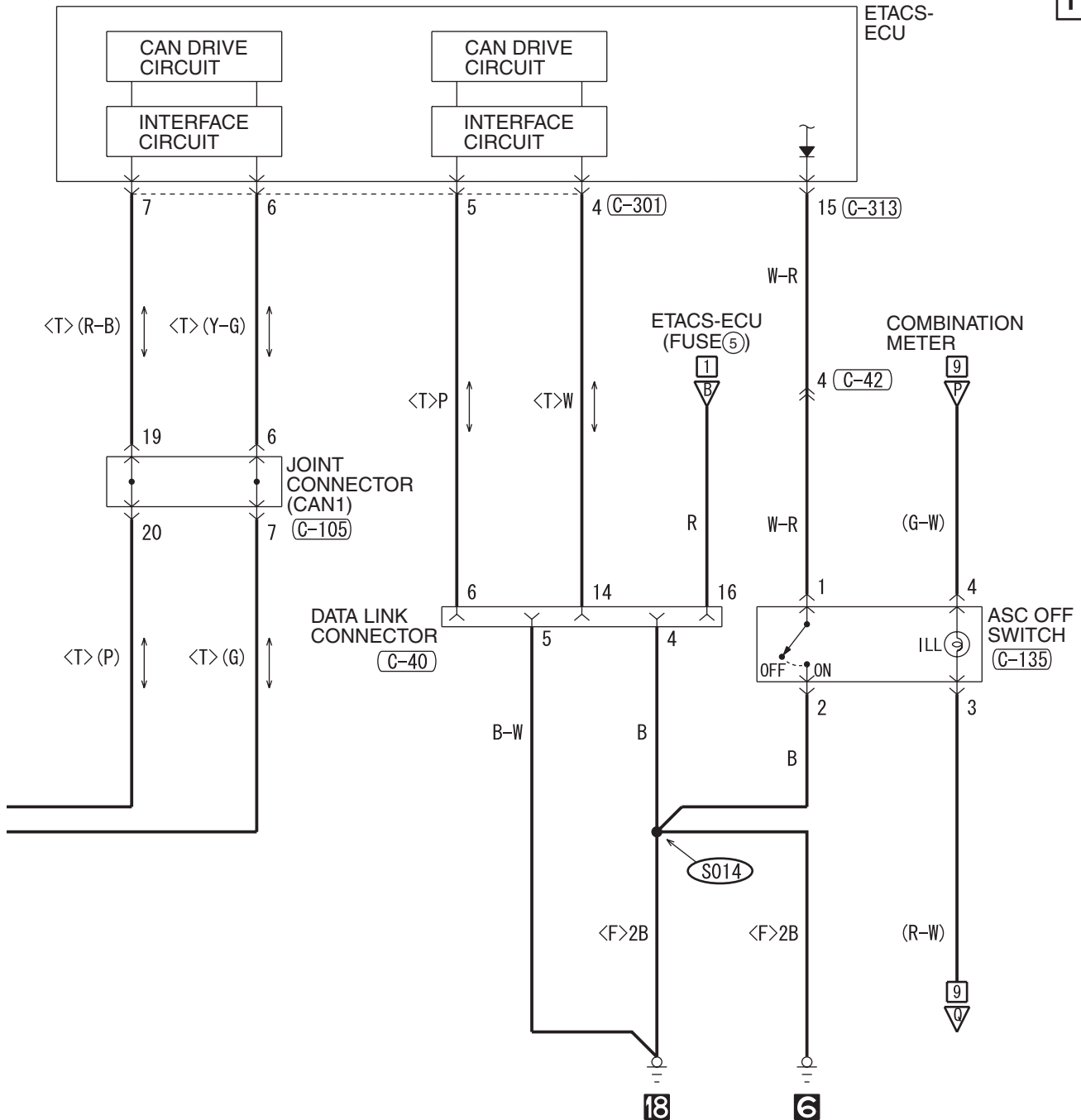

(C-301)

(C-313)

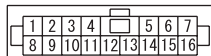
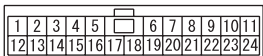

WIRE COLOR CODE

B : BLACK LG : LIGHT GREEN G : GREEN L : BLUE W : WHITE Y : YELLOW SB : SKY BLUE
 BR : BROWN O : ORANGE GR : GRAY R : RED P : PINK V : VIOLET PU : PURPLE SI : SILVER

H8G15M37EB

TSB Revision

ABS, ASC, ACD, AYC AND S-AWC <TC-SST> (CONTINUED)

11

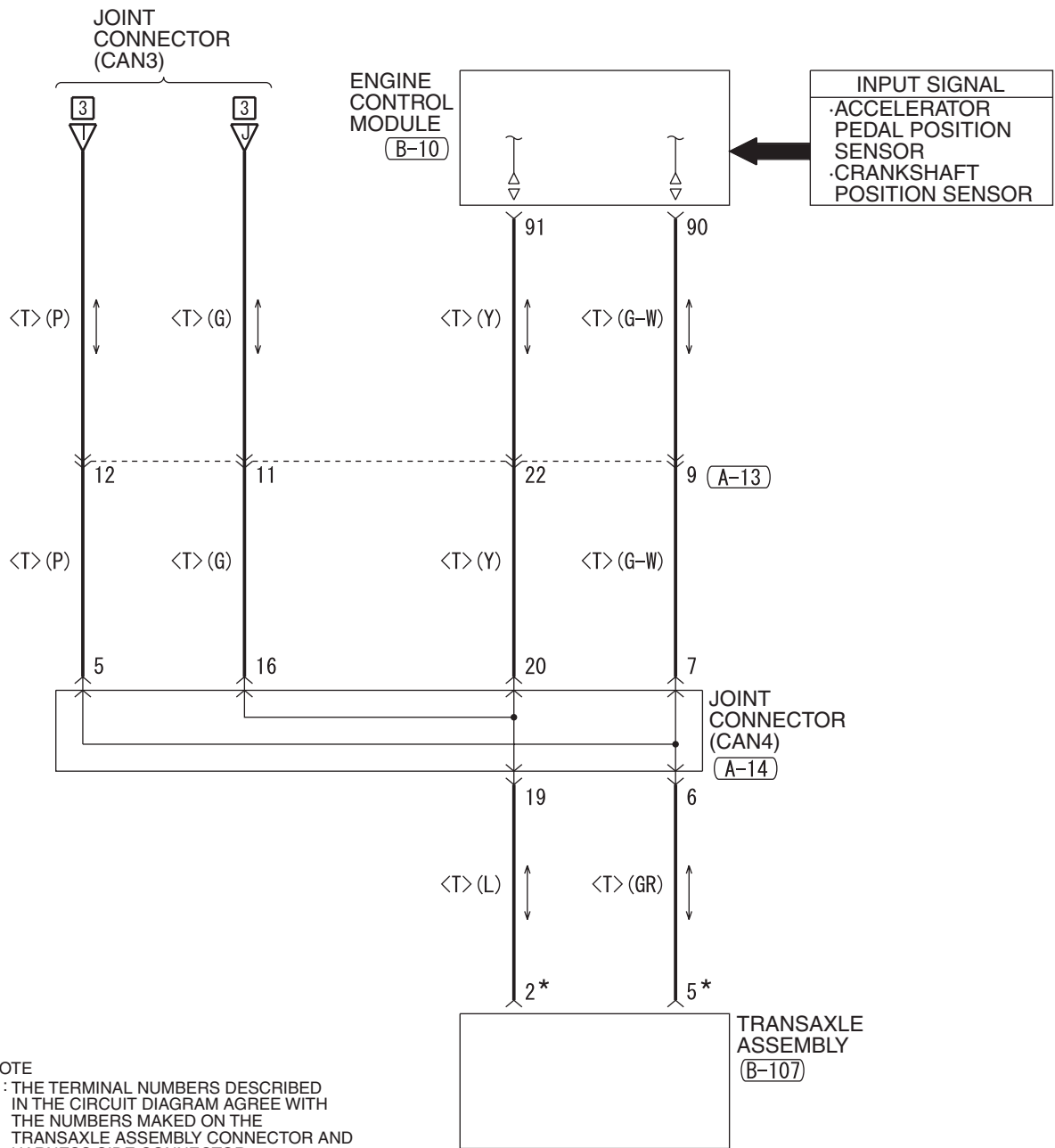

(A-13)

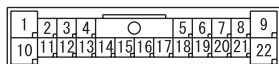

(A-14)

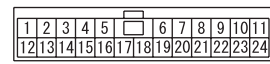

(B-10)

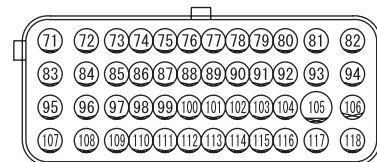

(B-107)*



NOTES

SUPPLEMENTAL RESTRAINT SYSTEM (SRS)

M1901009702497

1

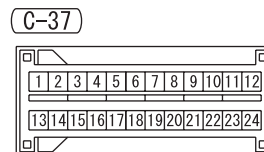
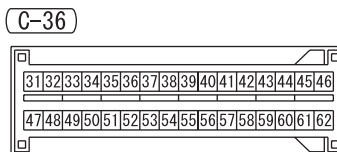
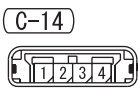
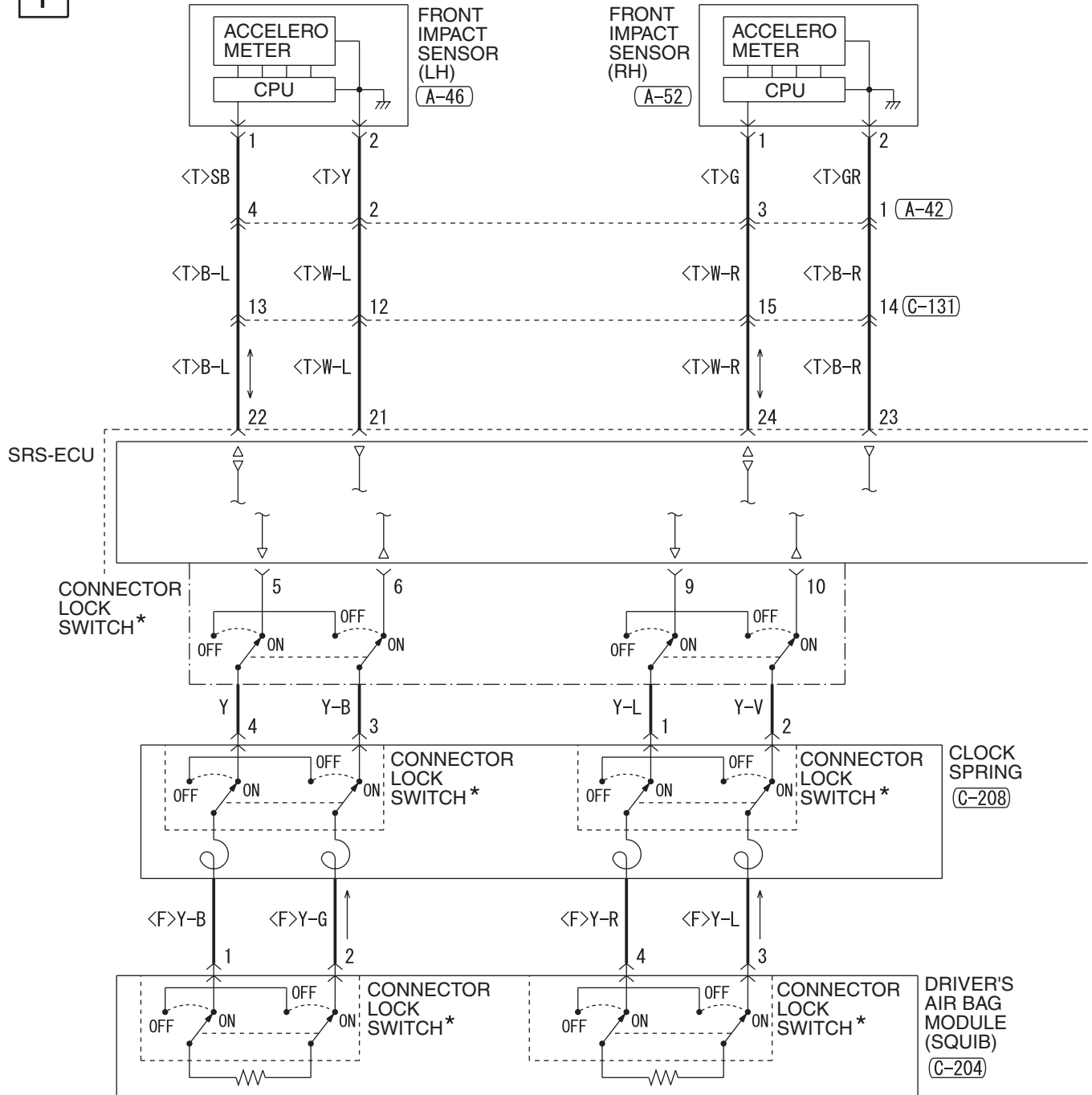

2

NOTE
 * : CONNECTOR COUPLED: ON
 CONNECTOR UNCOUPLED: OFF

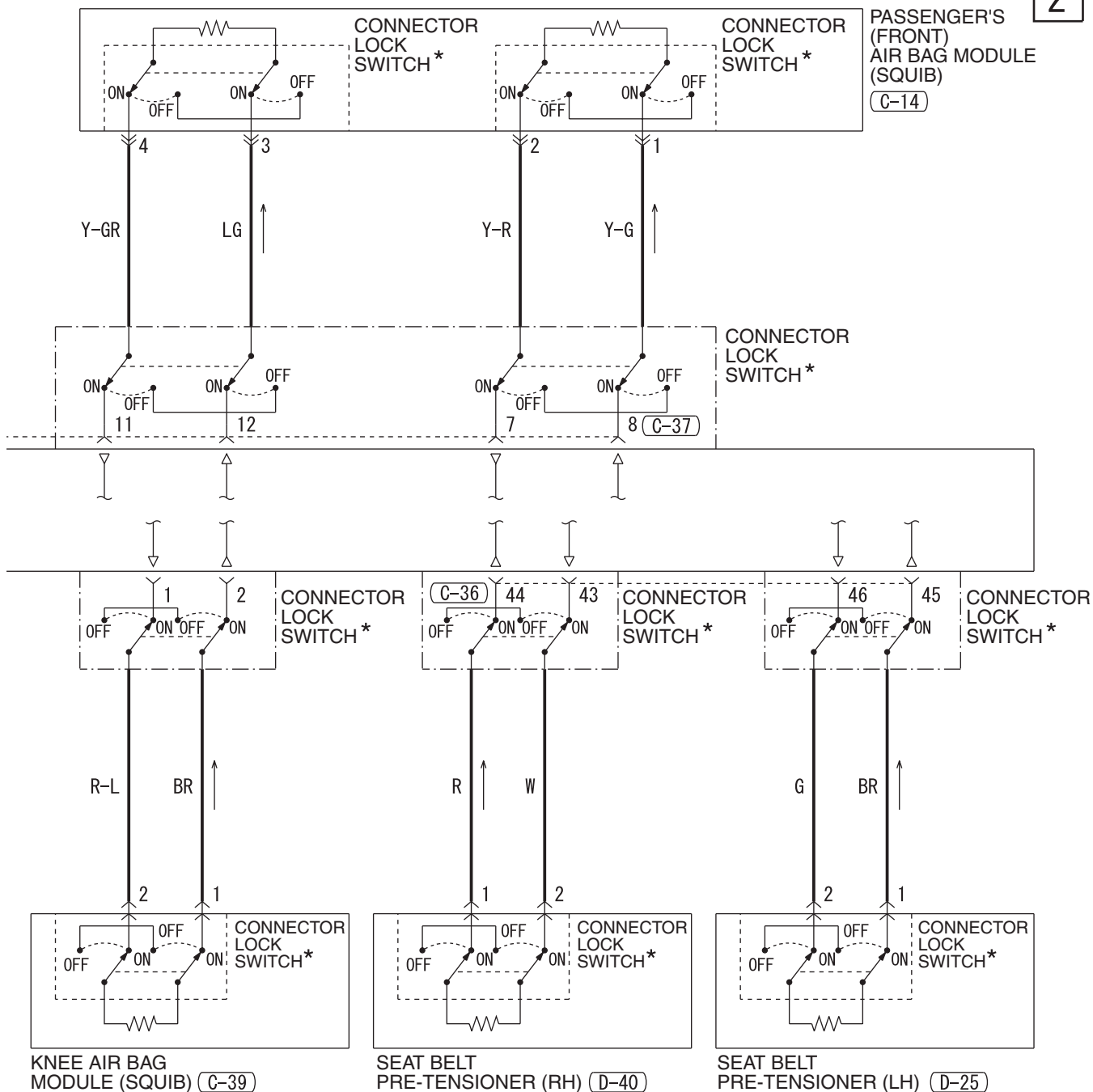

(C-131) (C-204) (C-208) (D-25) (D-40)

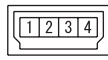
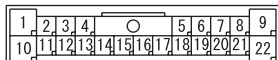

WIRE COLOR CODE

B : BLACK LG : LIGHT GREEN G : GREEN L : BLUE W : WHITE Y : YELLOW SB : SKY BLUE
 BR : BROWN O : ORANGE GR : GRAY R : RED P : PINK V : VIOLET PU : PURPLE SI : SILVER

SUPPLEMENTAL RESTRAINT SYSTEM (SRS) (CONTINUED)

3

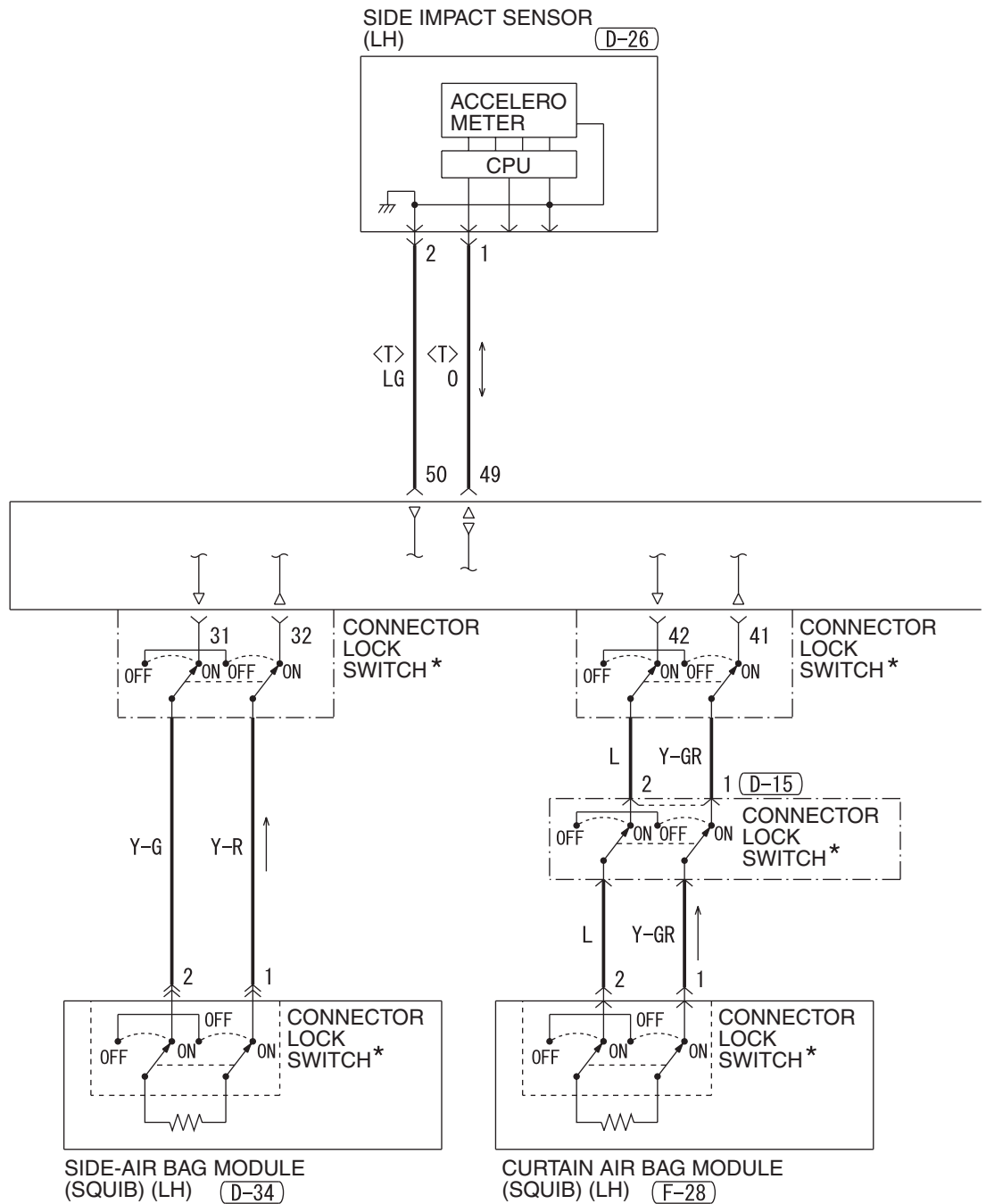

C-36

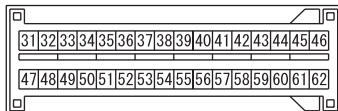

D-10



D-15



D-26

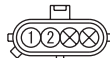

D-34



D-36



D-41

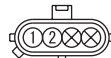

F-04



F-28



4

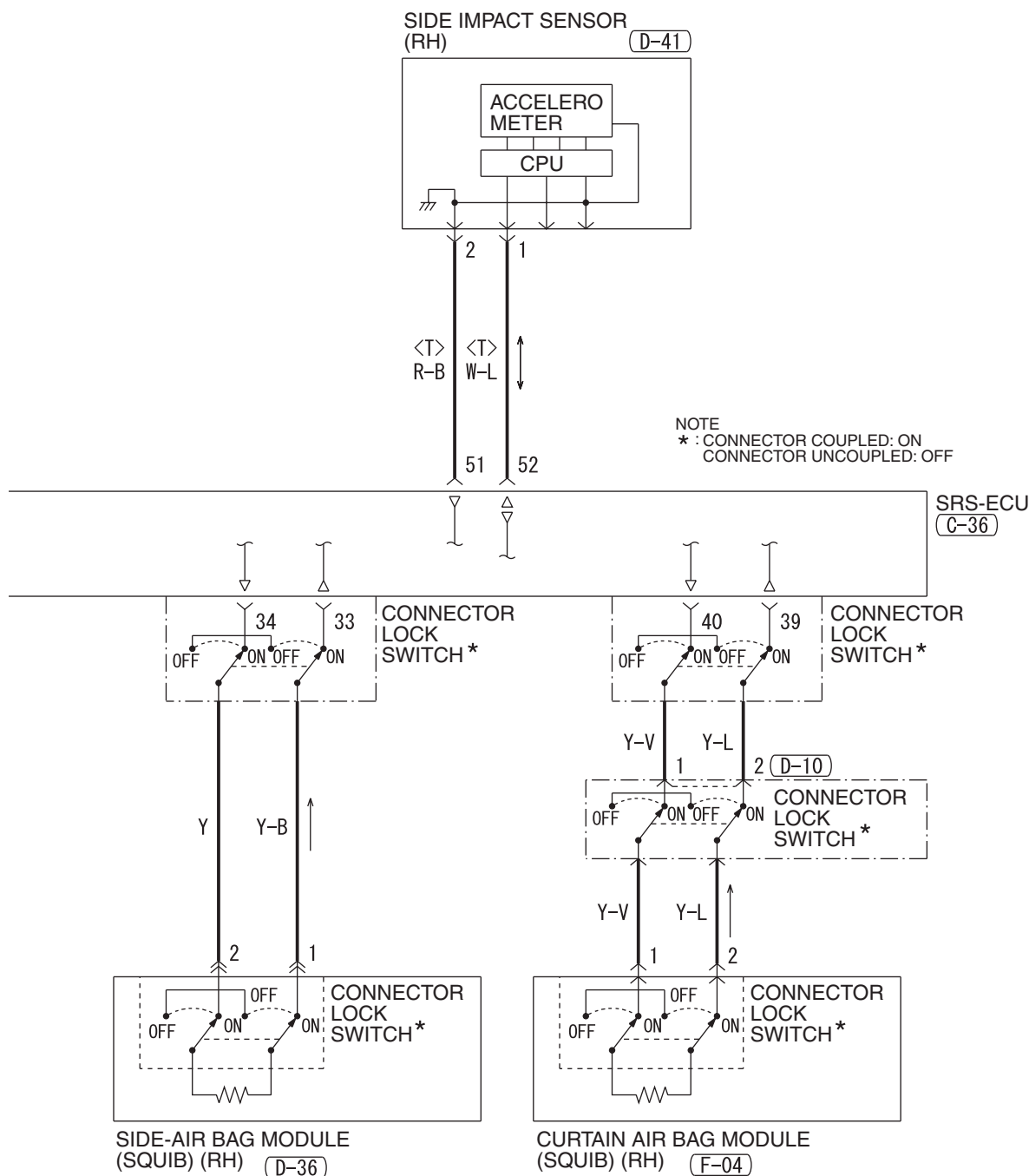

WIRE COLOR CODE
 B:BLACK LG:LIGHT GREEN G:GREEN L:BLUE W:WHITE Y:YELLOW SB:SKY BLUE
 BR:BROWN O:ORANGE GR:GRAY R:RED P:PINK V:VIOLET PU:PURPLE SI:SILVER

H8G15M38BB

SUPPLEMENTAL RESTRAINT SYSTEM (SRS) (CONTINUED)

5

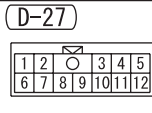
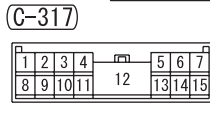
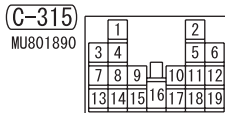
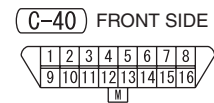
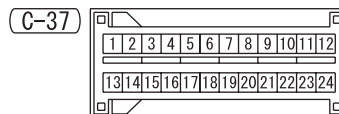
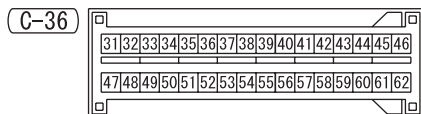
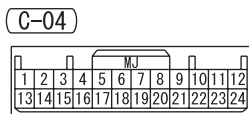
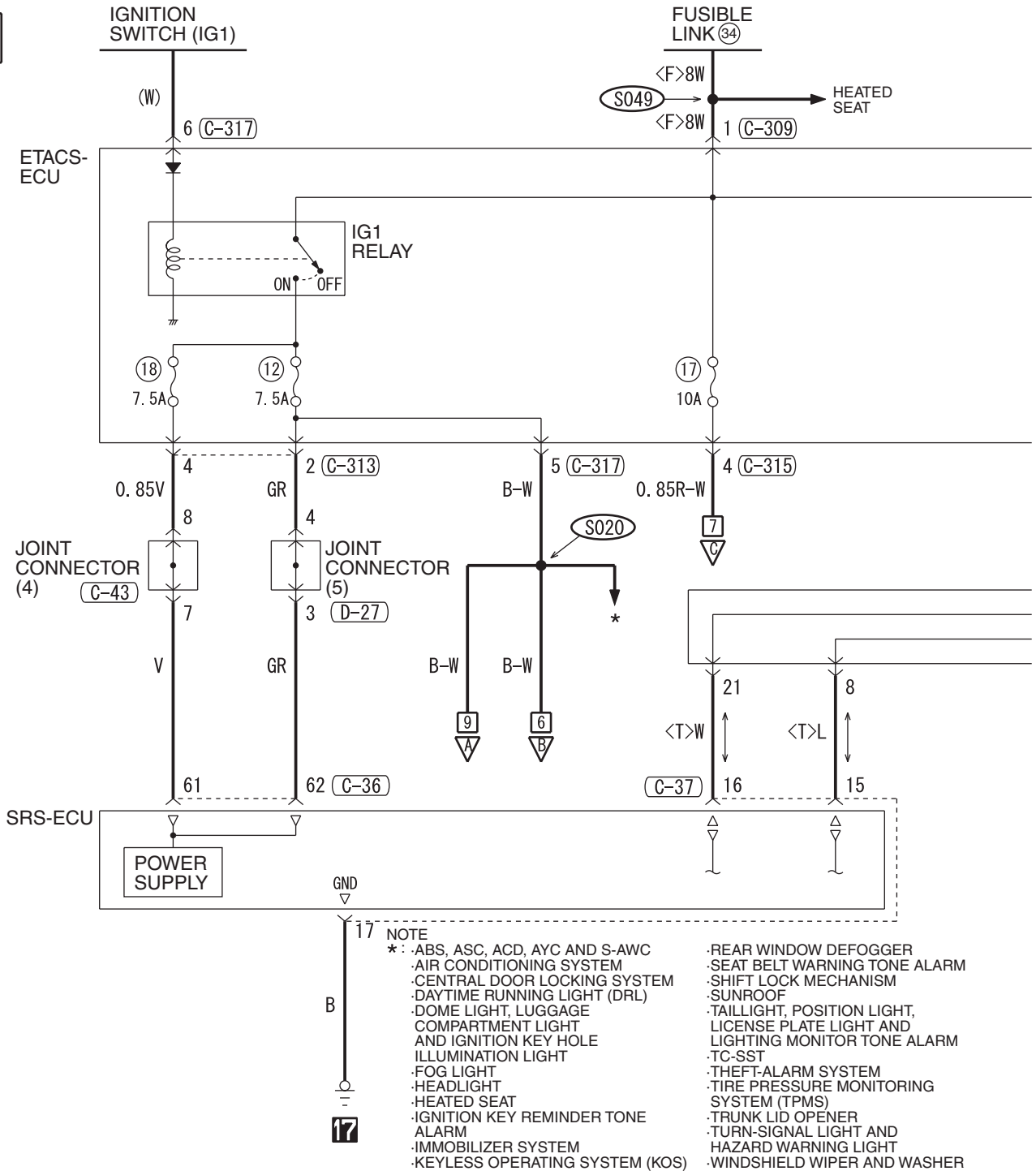

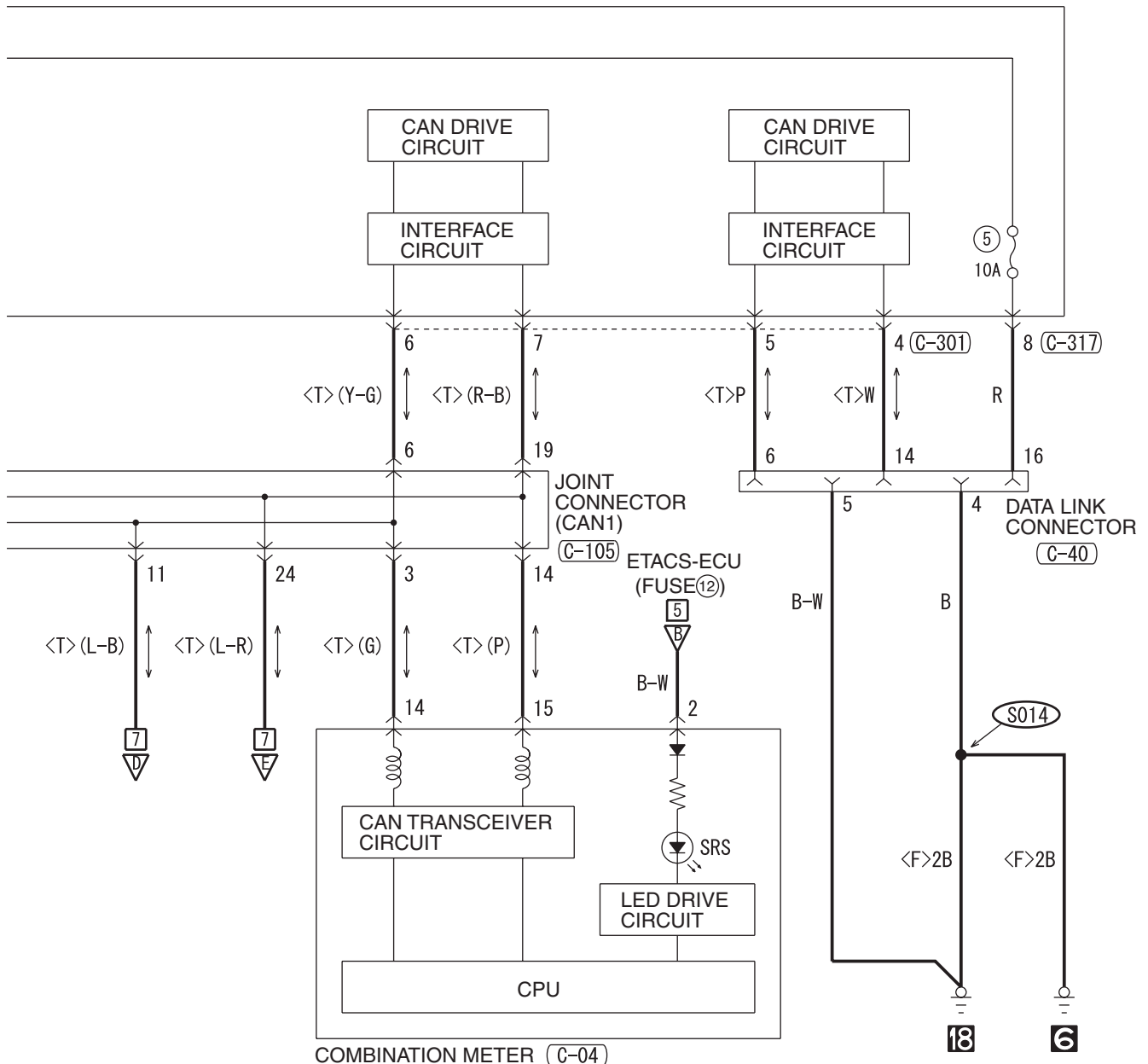

C-43

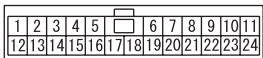

C-105

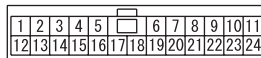

C-301

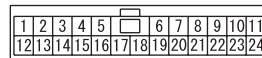

C-309



C-313

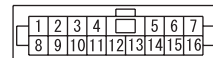

WIRE COLOR CODE

B : BLACK LG : LIGHT GREEN G : GREEN L : BLUE W : WHITE Y : YELLOW SB : SKY BLUE
BR : BROWN O : ORANGE GR : GRAY R : RED P : PINK V : VIOLET PU : PURPLE SI : SILVER

H8G15M38CB

SUPPLEMENTAL RESTRAINT SYSTEM (SRS) (CONTINUED)

7

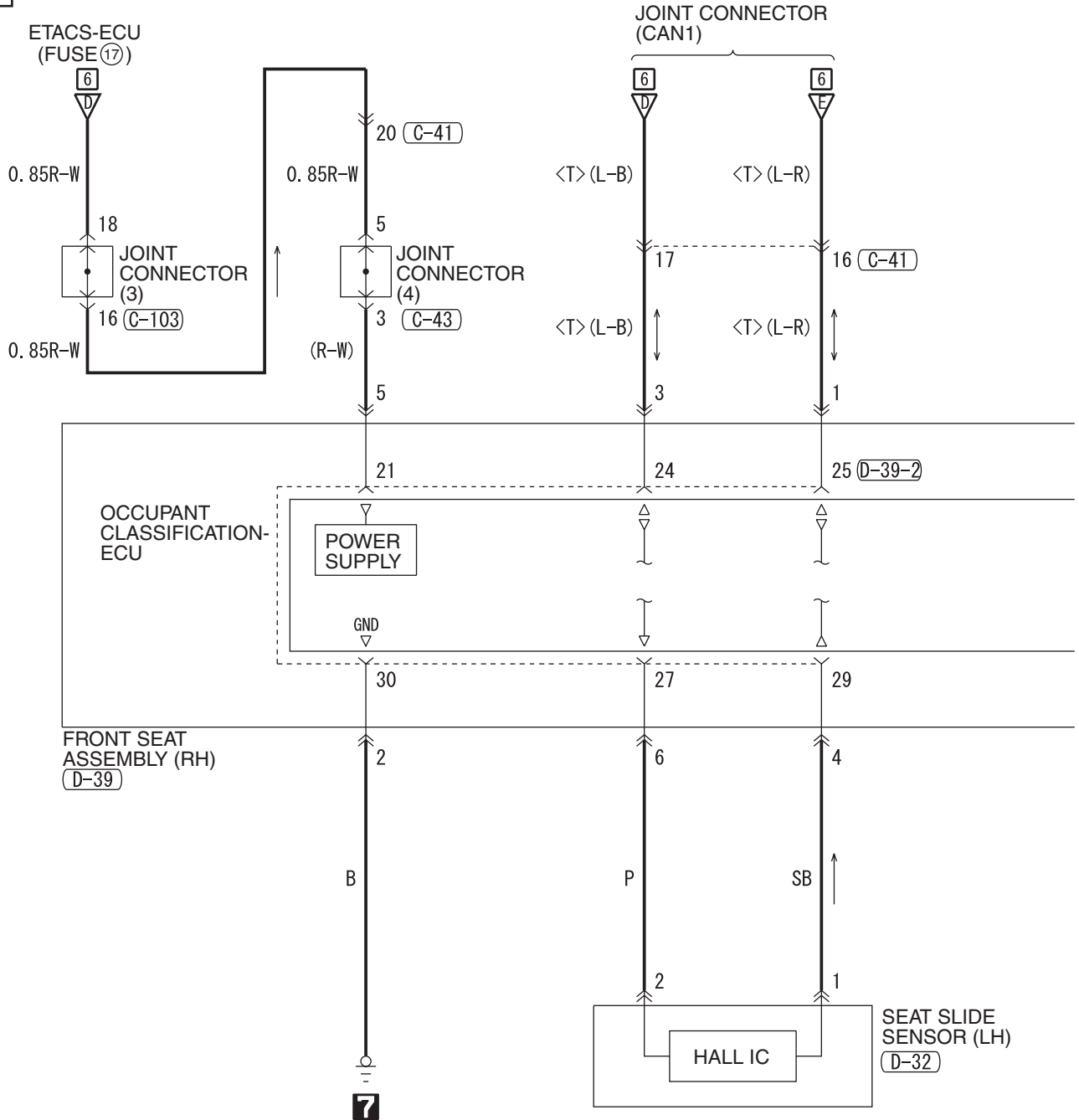

C-41

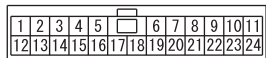

C-43

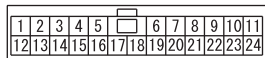

C-103

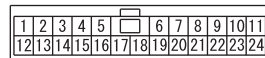

D-32



D-39



D-39-1

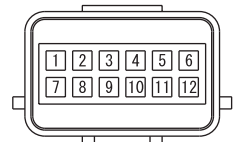

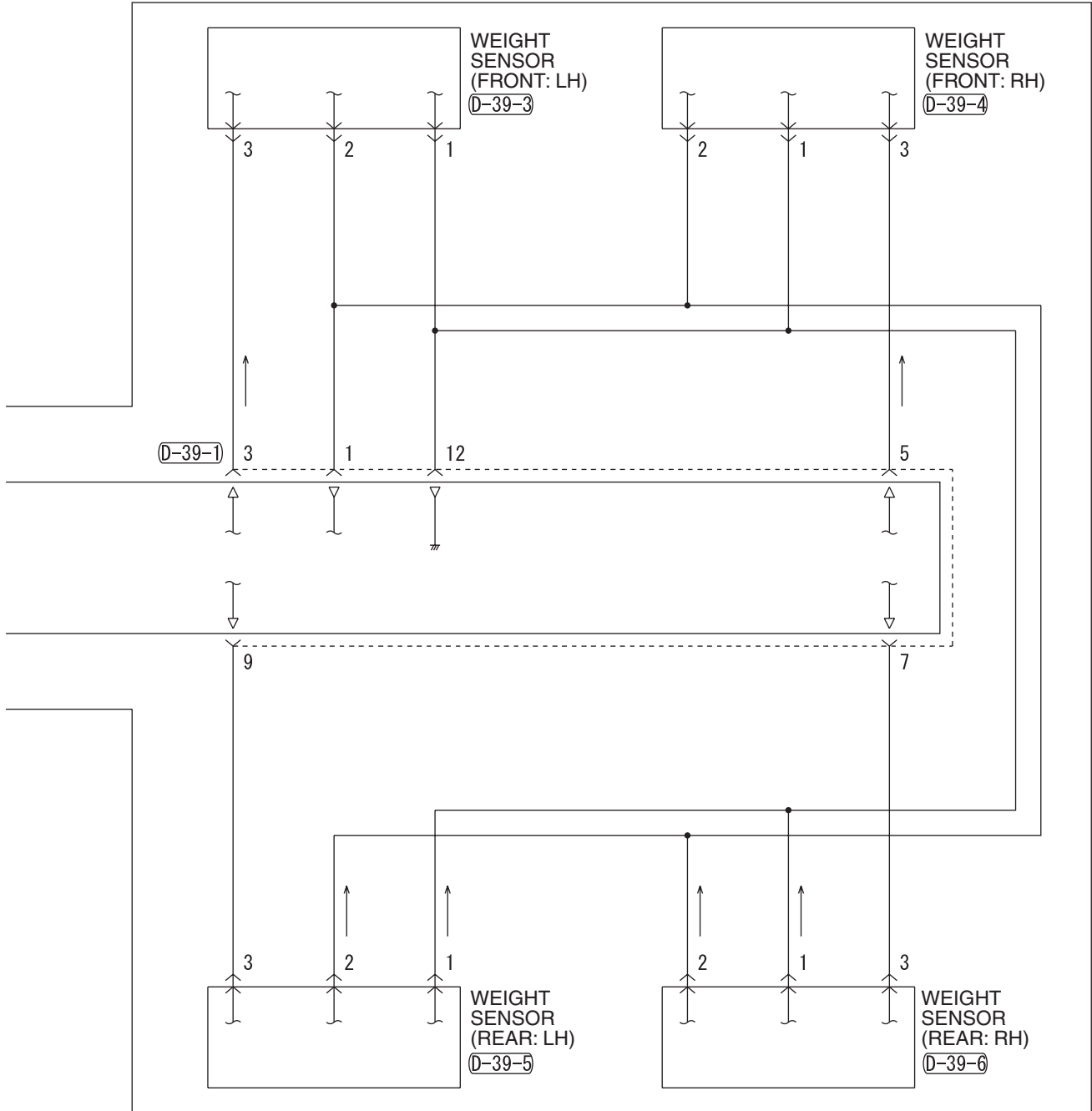

D-39-2

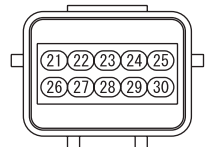

D-39-3



D-39-4



D-39-5



D-39-6



WIRE COLOR CODE

B: BLACK LG: LIGHT GREEN G: GREEN L: BLUE W: WHITE
 Y: YELLOW SB: SKY BLUE BR: BROWN O: ORANGE GR: GRAY
 R: RED P: PINK V: VIOLET PU: PURPLE SI: SILVER

H8G15M38DB

TSB Revision

SUPPLEMENTAL RESTRAINT SYSTEM (SRS) (CONTINUED)

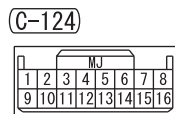
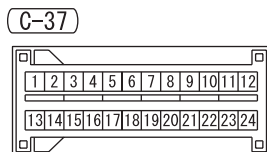
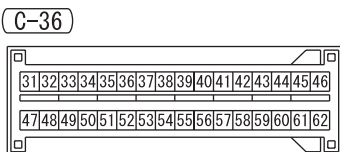
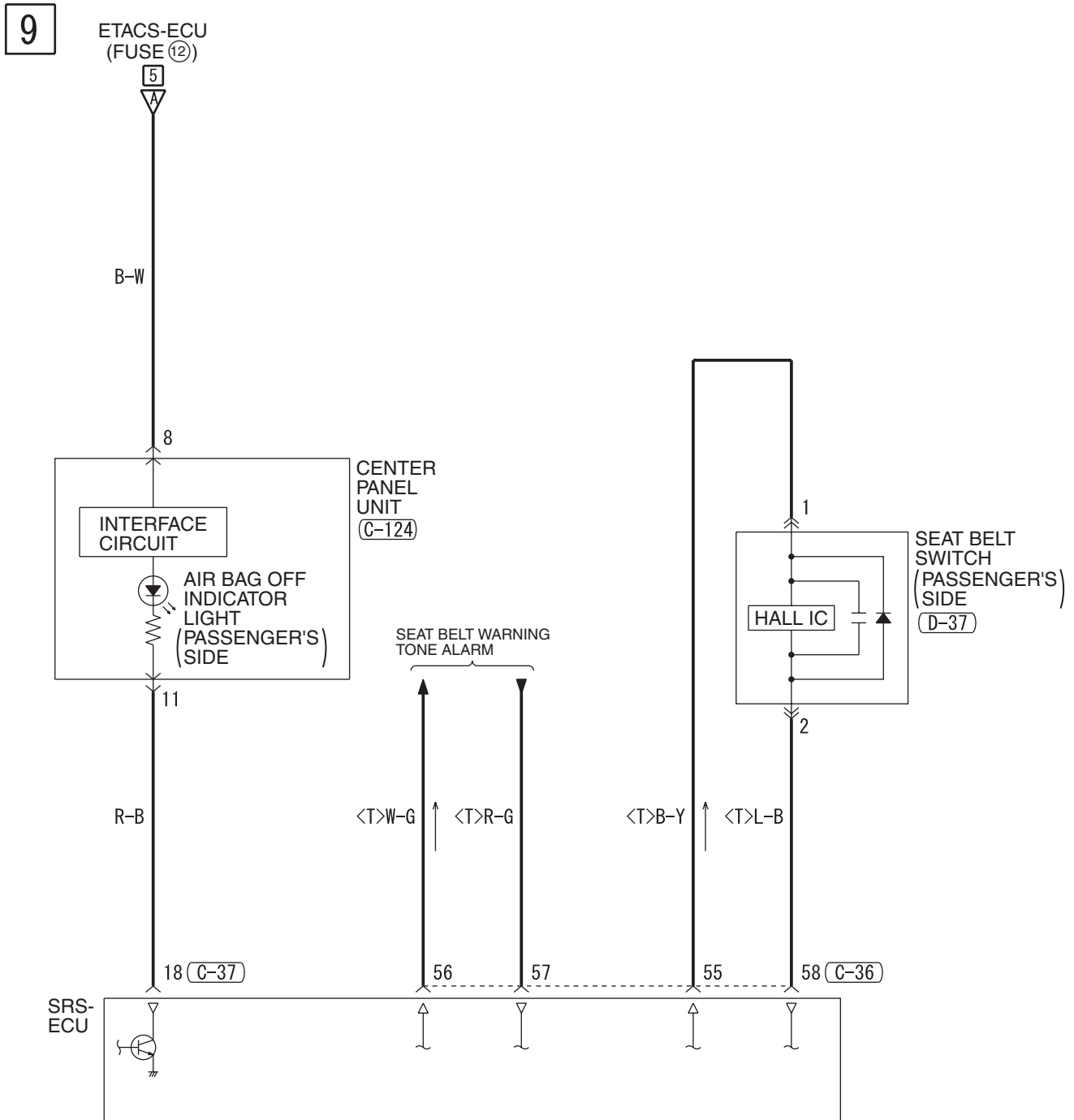

NOTES

AUTO-CRUISE CONTROL SYSTEM <M/T>

M1901009302756

1

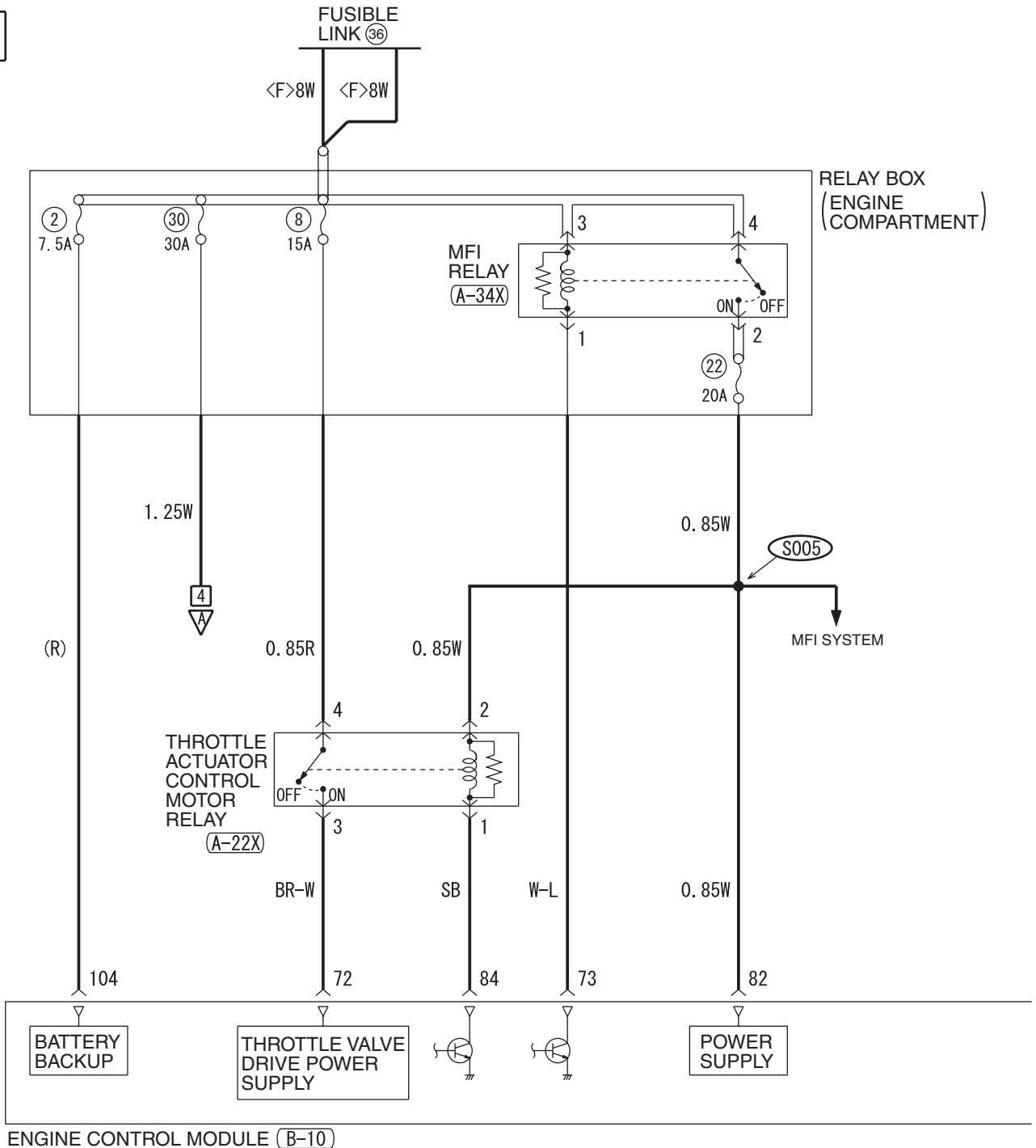

(A-22X) (A-34X) (B-10)

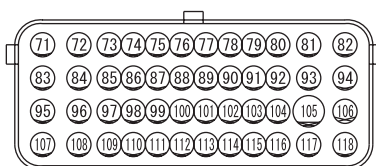

(C-48)



(C-49)



(C-304)

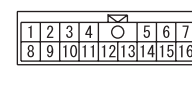

(C-309)



(C-312)

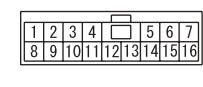

H8G15M39AA

TSB Revision

2

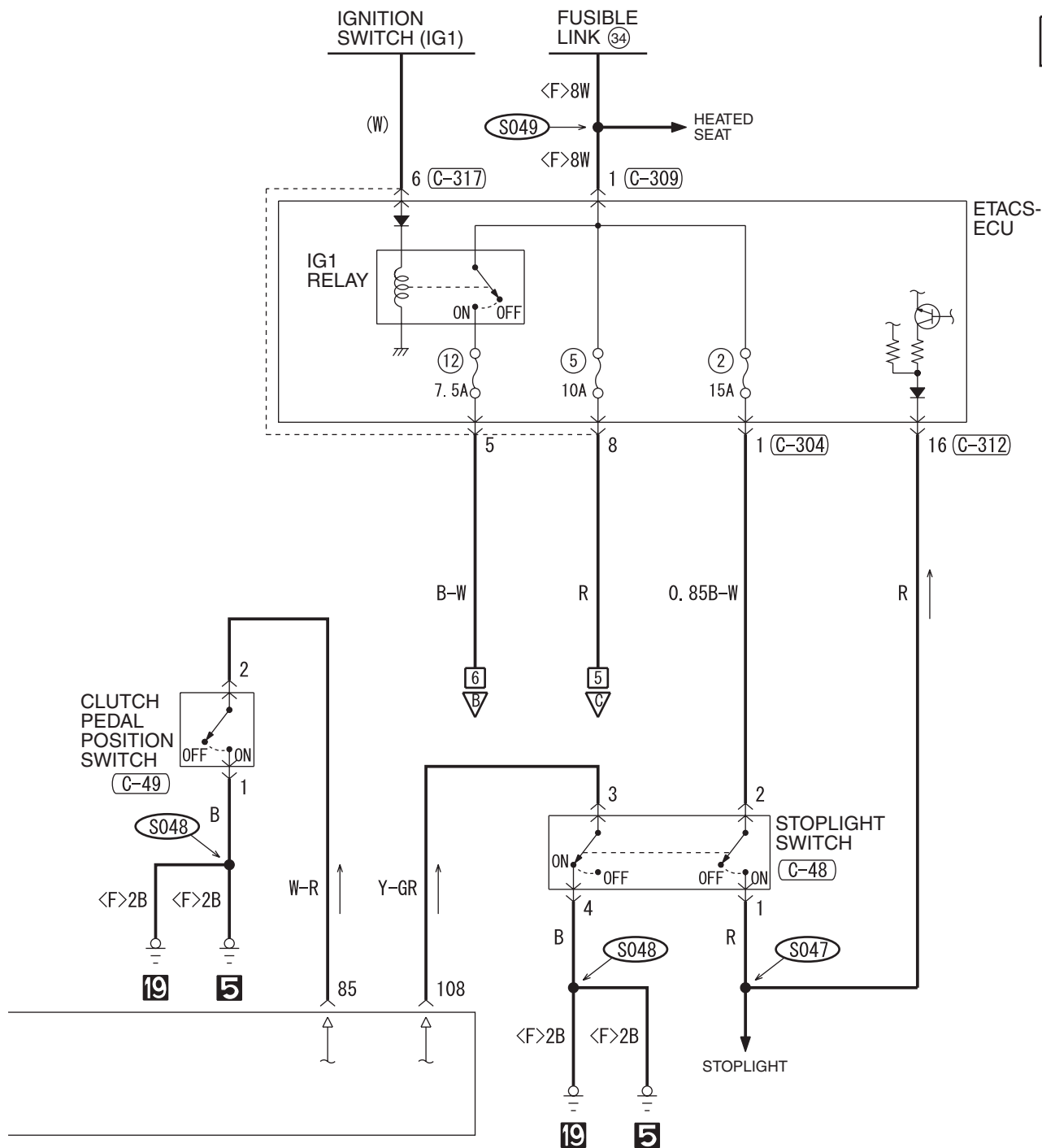

(C-317)

1	2	3	4	5	6	7	
8	9	10	11	12	13	14	15

WIRE COLOR CODE
 B: BLACK LG: LIGHT GREEN G: GREEN L: BLUE W: WHITE Y: YELLOW SB: SKY BLUE
 BR: BROWN O: ORANGE GR: GRAY R: RED P: PINK V: VIOLET PU: PURPLE SI: SILVER

H8G15M39AB

AUTO-CRUISE CONTROL SYSTEM <M/T> (CONTINUED)

3

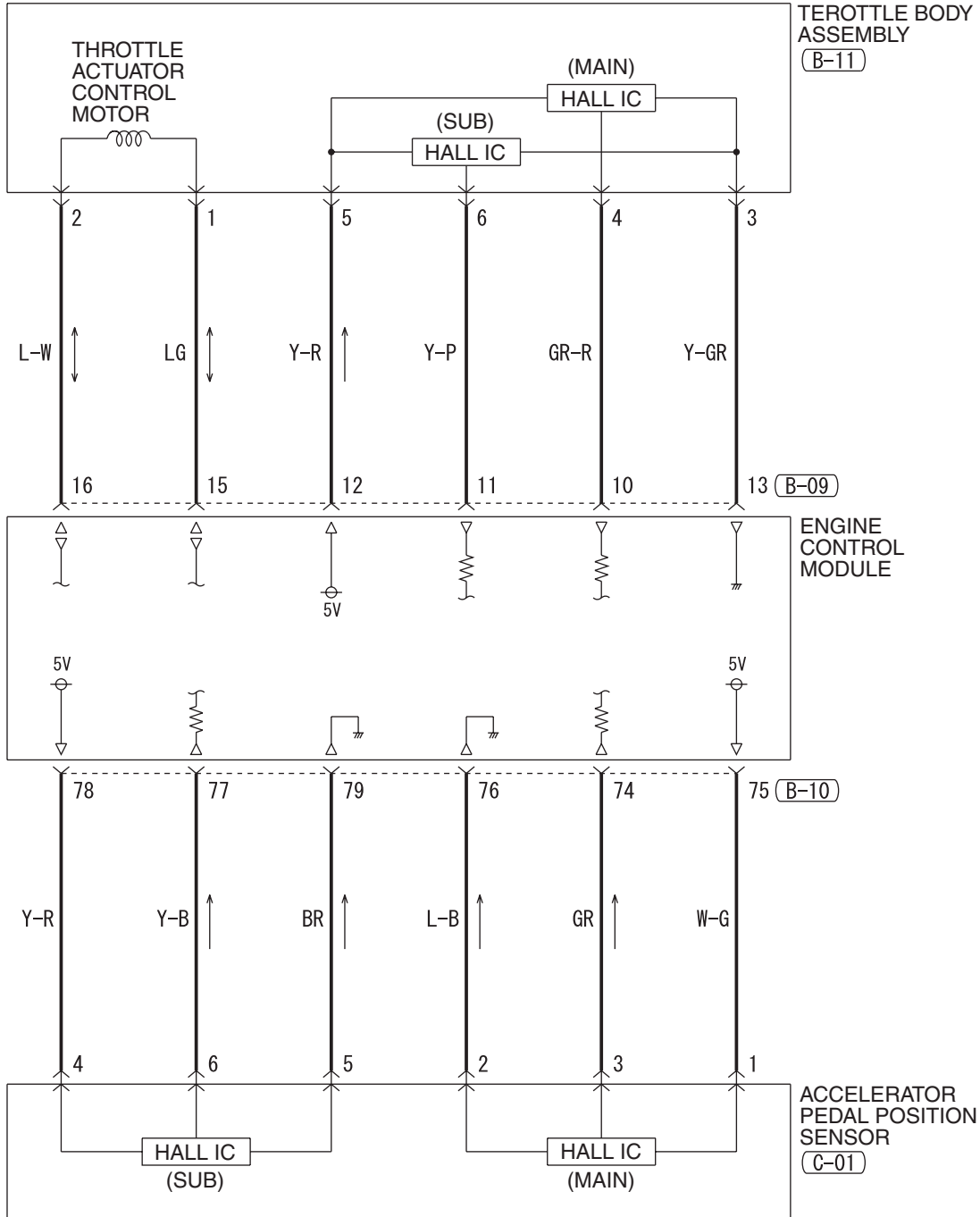

(B-09)

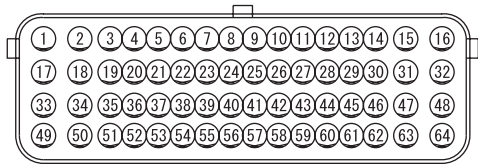

(B-10)

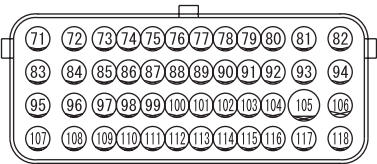

(B-11)

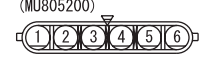

(C-307)



(C-317)

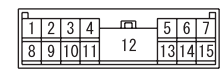

TSB Revision

4

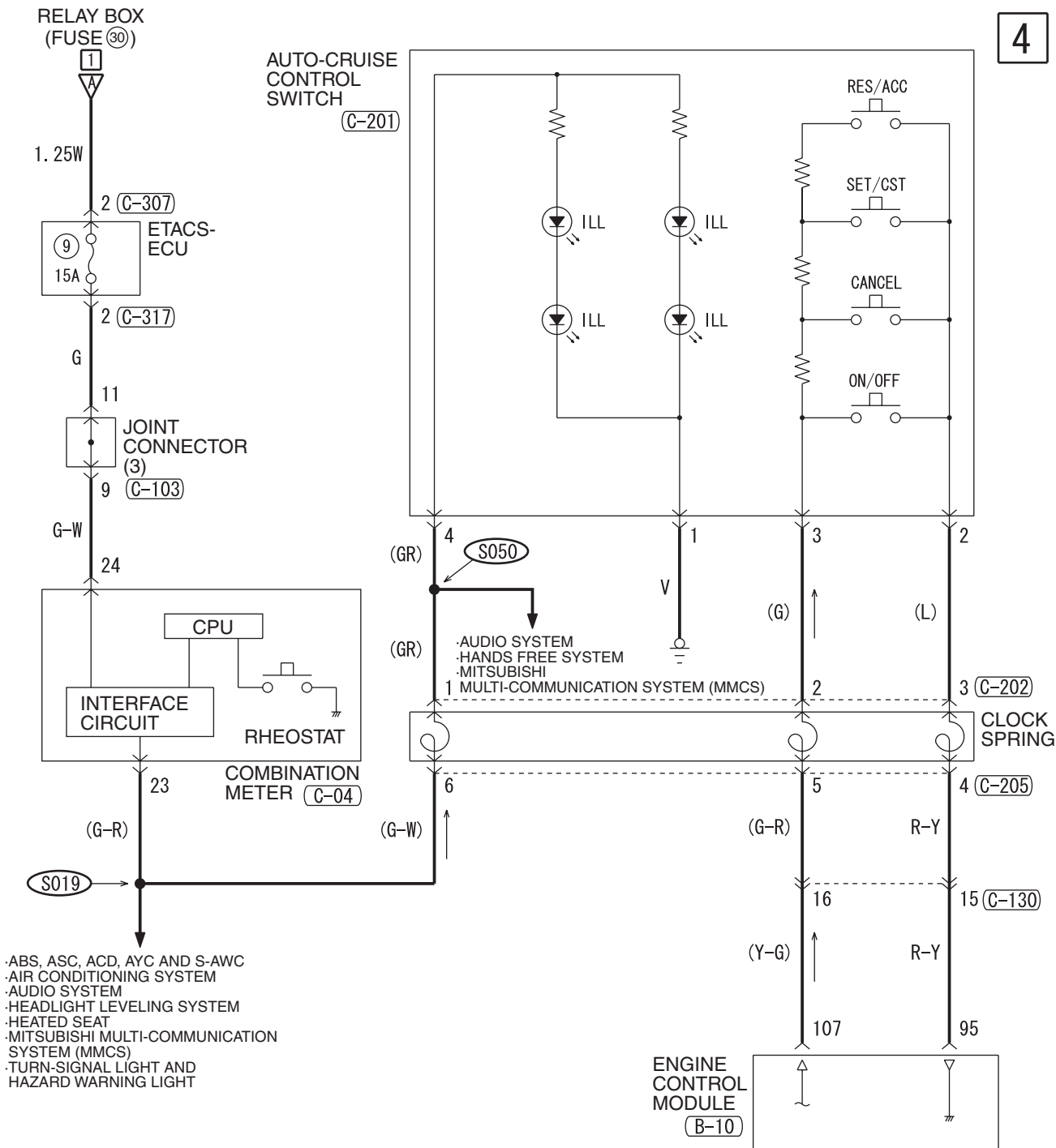

- ABS, ASC, ACD, AYC AND S-AWC
- AIR CONDITIONING SYSTEM
- AUDIO SYSTEM
- HEADLIGHT LEVELING SYSTEM
- HEATED SEAT
- MITSUBISHI MULTI-COMMUNICATION SYSTEM (MMCS)
- TURN-SIGNAL LIGHT AND HAZARD WARNING LIGHT

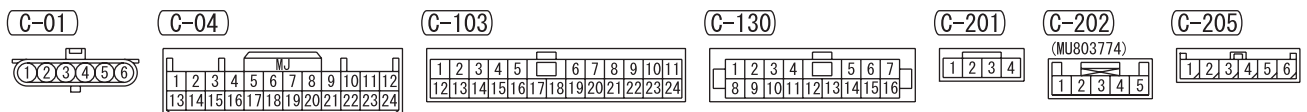

WIRE COLOR CODE
 B: BLACK LG: LIGHT GREEN G: GREEN L: BLUE W: WHITE Y: YELLOW SB: SKY BLUE
 BR: BROWN O: ORANGE GR: GRAY R: RED P: PINK V: VIOLET PU: PURPLE SI: SILVER

H8G15M39BB

AUTO-CRUISE CONTROL SYSTEM <M/T> (CONTINUED)

5

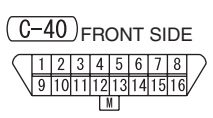
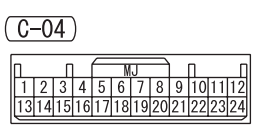
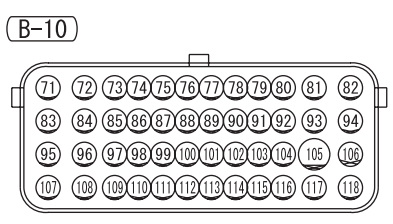
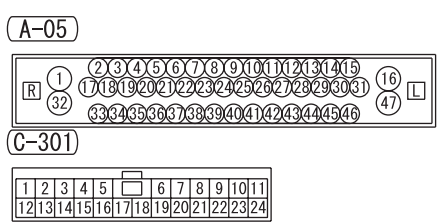
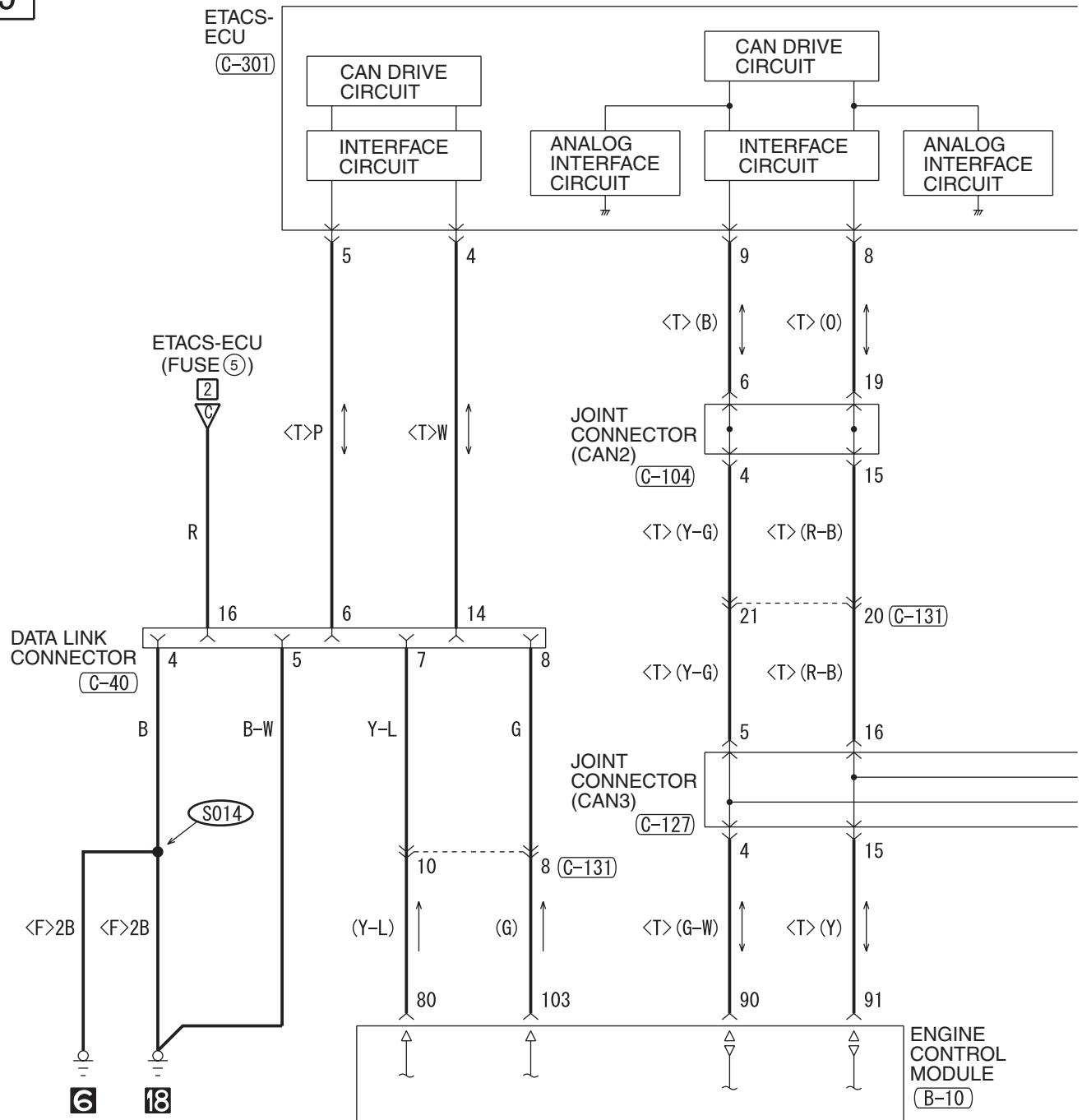

6

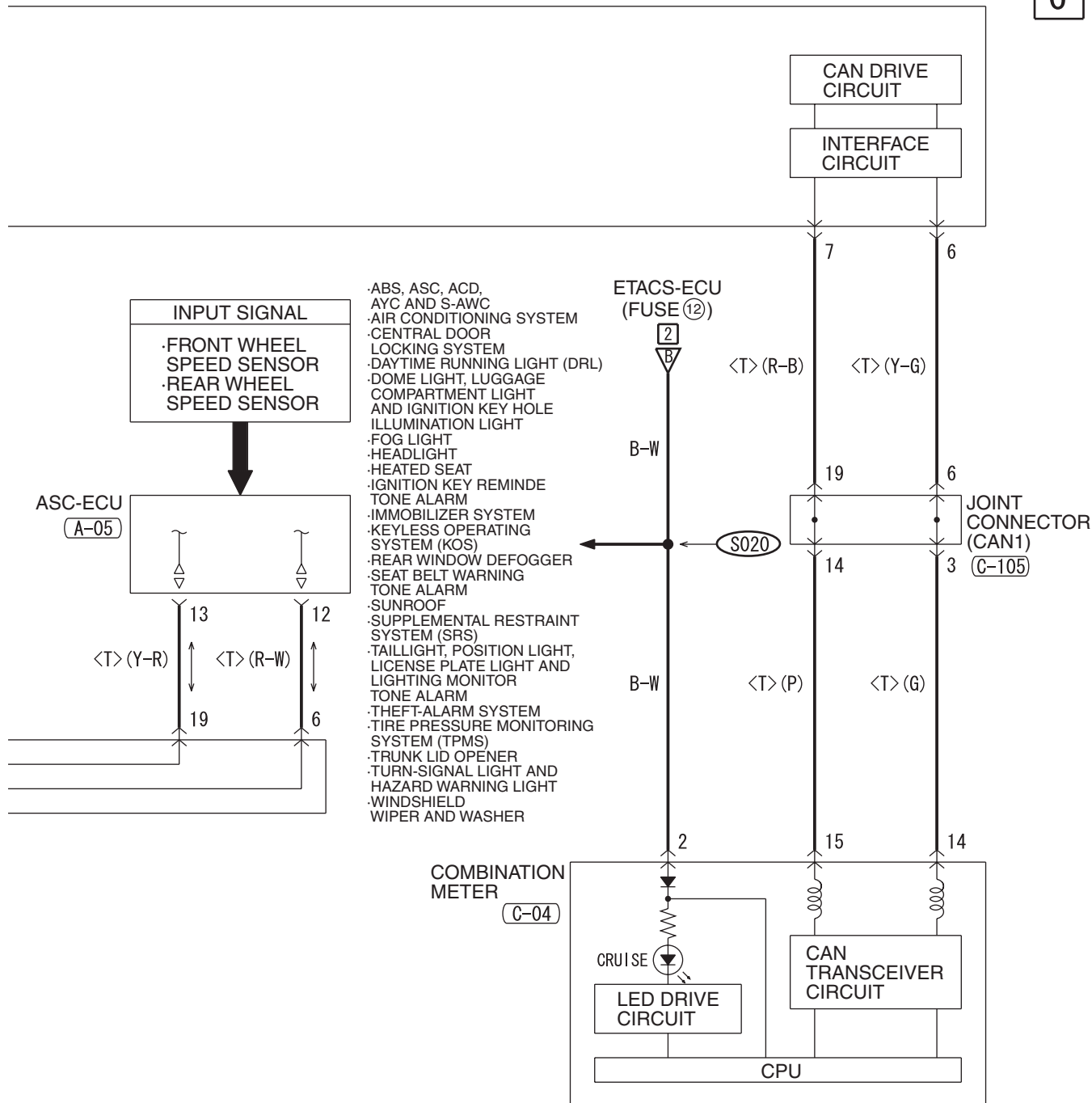

(C-104)

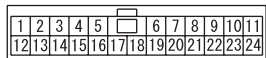

(C-105)

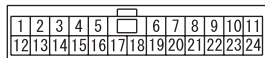

(C-127)

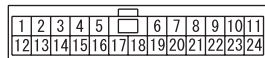

(C-131)

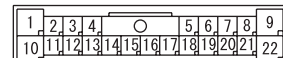

WIRE COLOR CODE
 B: BLACK LG: LIGHT GREEN G: GREEN L: BLUE W: WHITE Y: YELLOW SB: SKY BLUE
 BR: BROWN O: ORANGE GR: GRAY R: RED P: PINK V: VIOLET PU: PURPLE SI: SILVER

H8G15M39CB

AUTO-CRUISE CONTROL SYSTEM <TC-SST>

M1901009302767

1

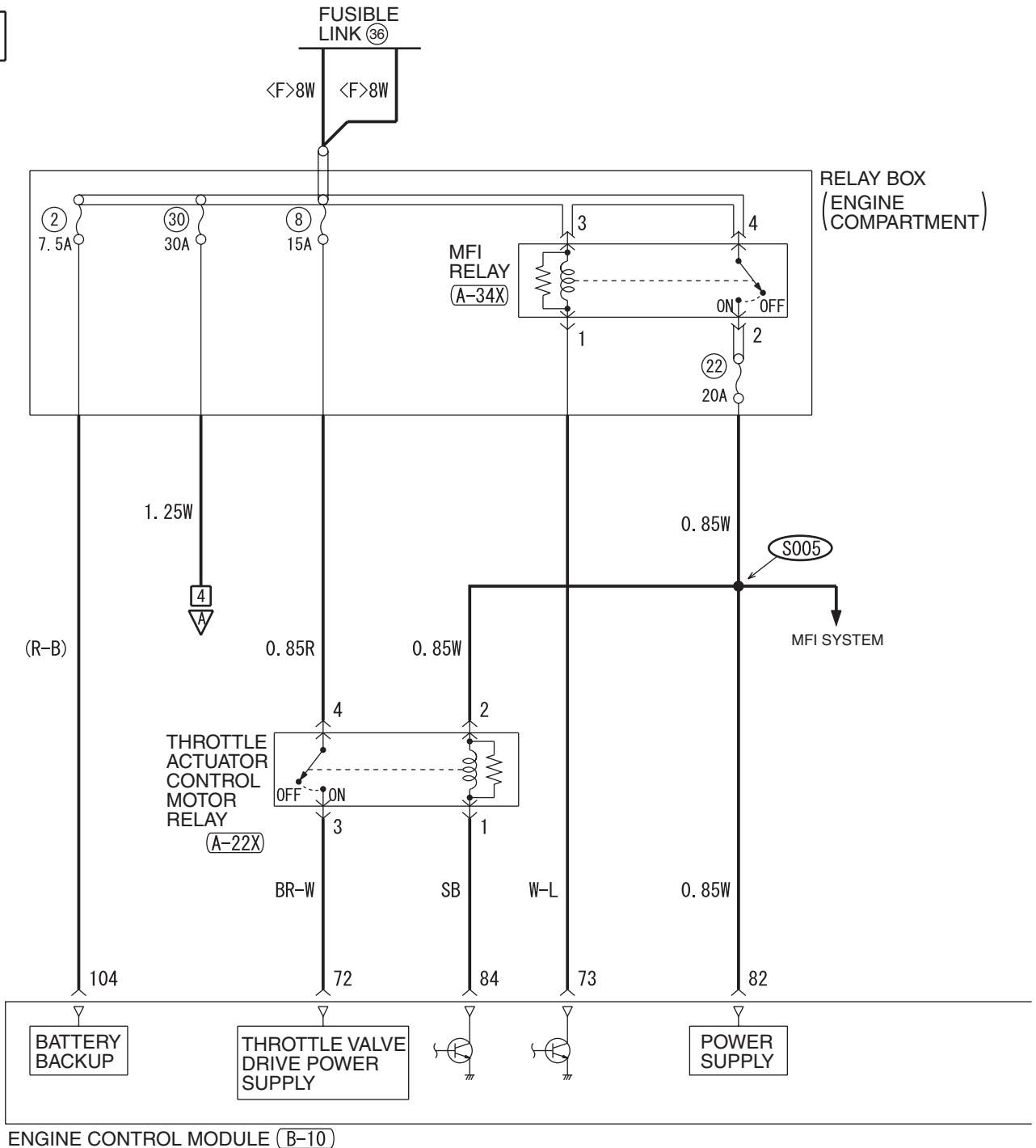

(A-22X)

(A-34X)

(B-10)

(C-48)

(C-304)

(C-309)

(C-312)

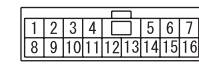
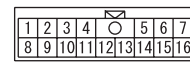
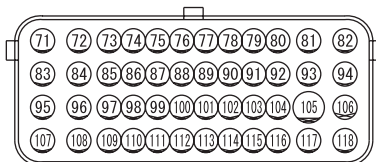

H8G15M40AA

TSB Revision

2

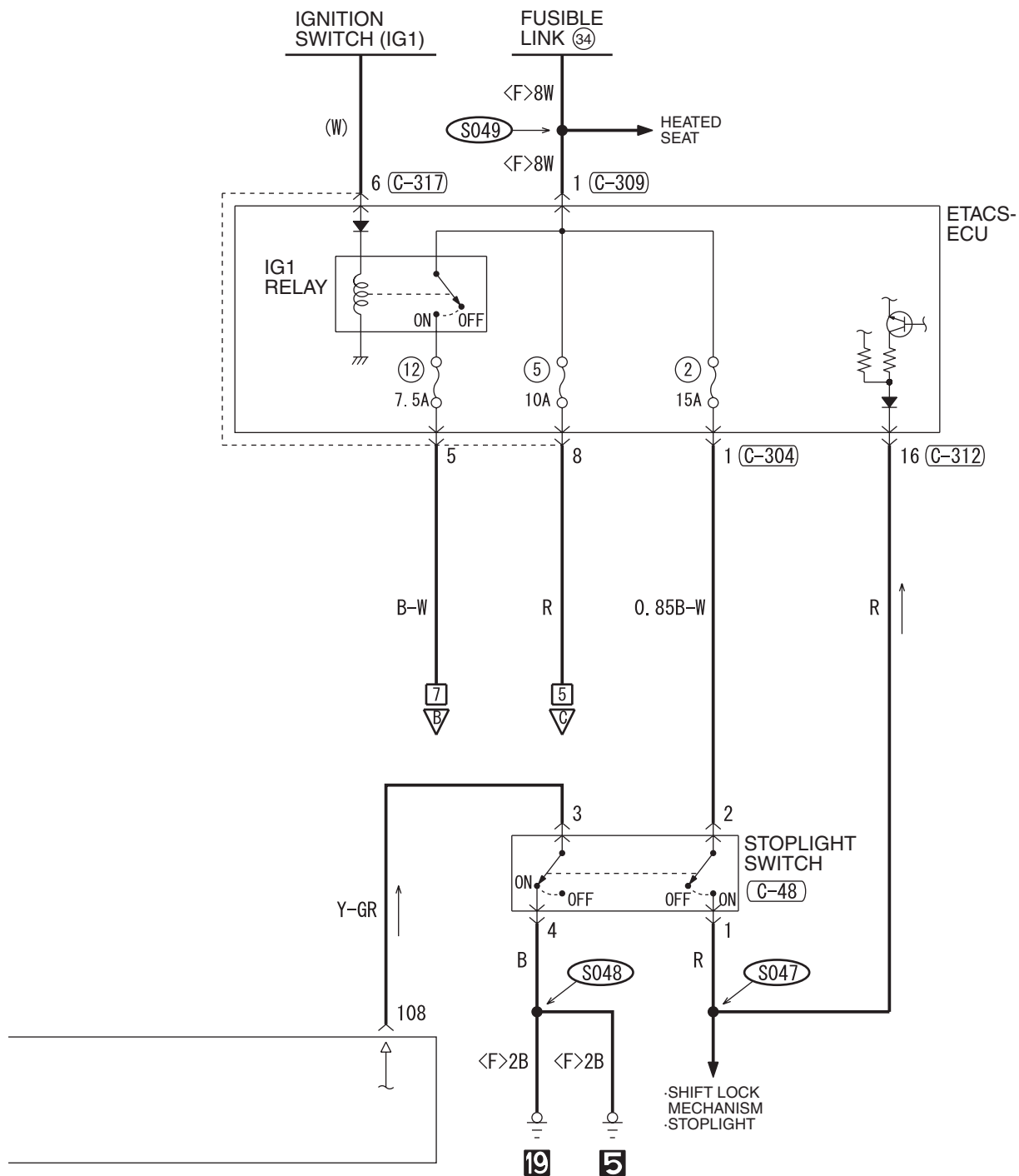

(C-317)

1	2	3	4	5	6	7	
8	9	10	11	12	13	14	15

WIRE COLOR CODE

B: BLACK LG: LIGHT GREEN G: GREEN L: BLUE W: WHITE Y: YELLOW SB: SKY BLUE
 BR: BROWN O: ORANGE GR: GRAY R: RED P: PINK V: VIOLET PU: PURPLE SI: SILVER

H8G15M40AB

AUTO-CRUISE CONTROL SYSTEM <TC-SST> (CONTINUED)

3

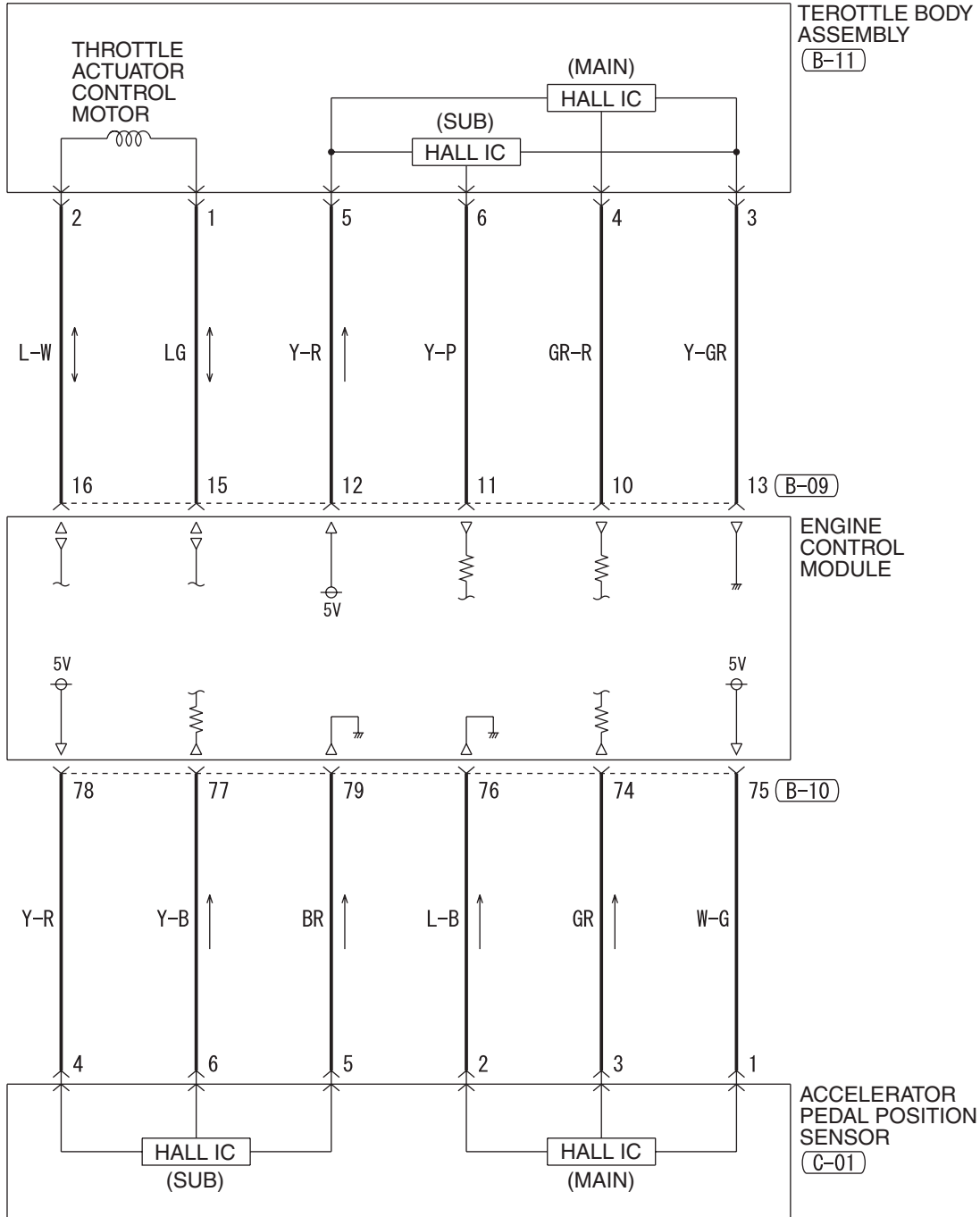

(B-09)

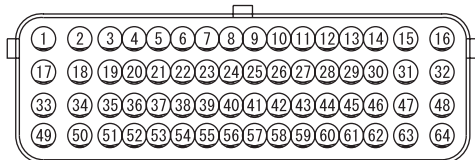

(B-10)

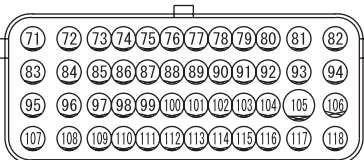

(B-11)

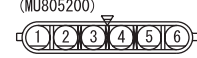

(C-307)



(C-317)

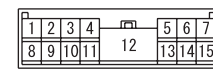

4

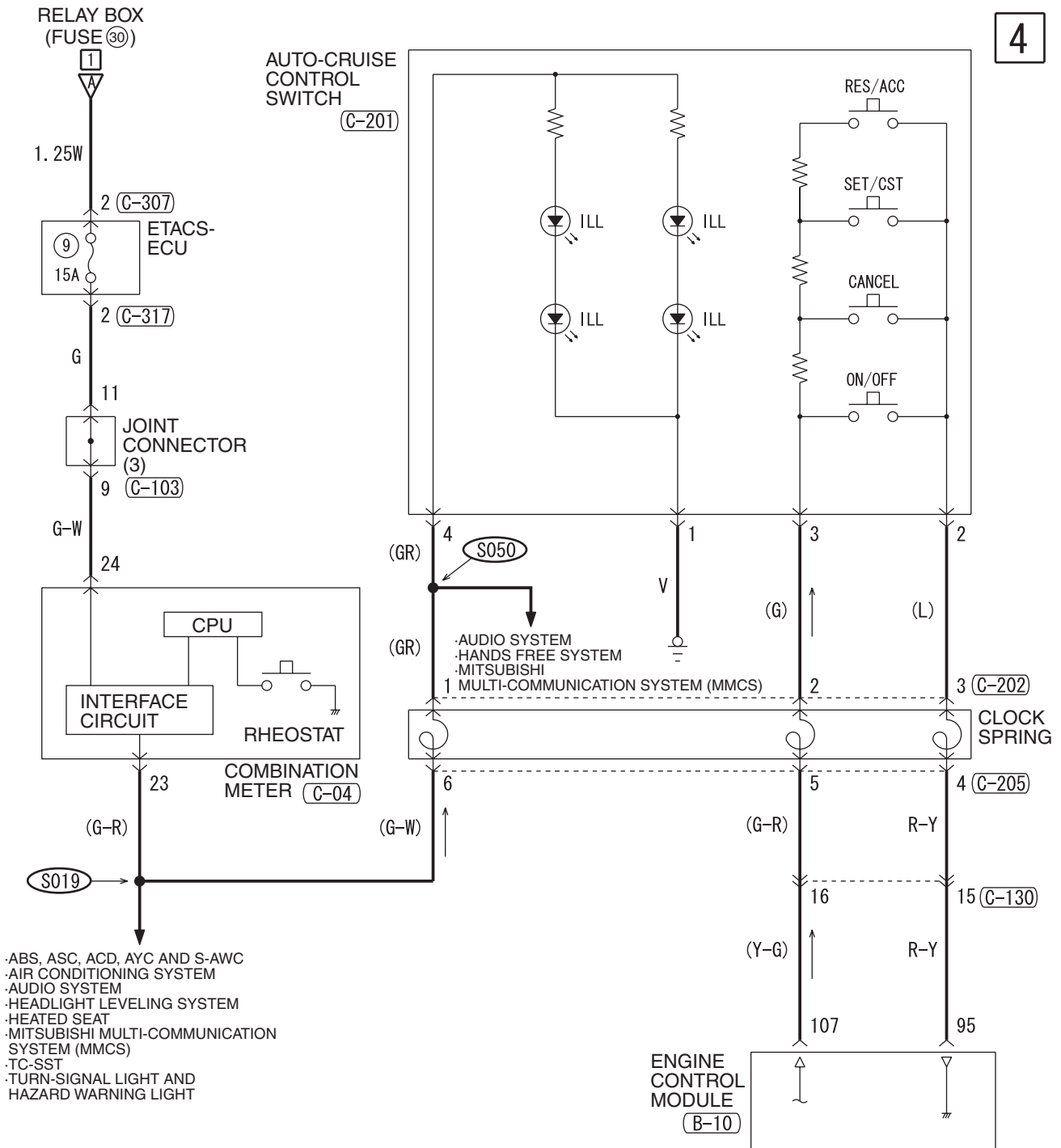

- ABS, ASC, ACD, AYC AND S-AWC
- AIR CONDITIONING SYSTEM
- AUDIO SYSTEM
- HEADLIGHT LEVELING SYSTEM
- HEATED SEAT
- MITSUBISHI MULTI-COMMUNICATION SYSTEM (MMCS)
- TC-SST
- TURN-SIGNAL LIGHT AND HAZARD WARNING LIGHT

(C-01)

(C-04)

(C-103)

(C-130)

(C-201)

(C-202)

(C-205)

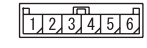
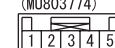
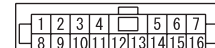
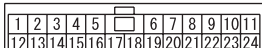
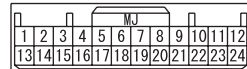

WIRE COLOR CODE

B: BLACK LG: LIGHT GREEN G: GREEN L: BLUE W: WHITE Y: YELLOW SB: SKY BLUE
 BR: BROWN O: ORANGE GR: GRAY R: RED P: PINK V: VIOLET PU: PURPLE SI: SILVER

H8G15M40BB

AUTO-CRUISE CONTROL SYSTEM <TC-SST> (CONTINUED)

5

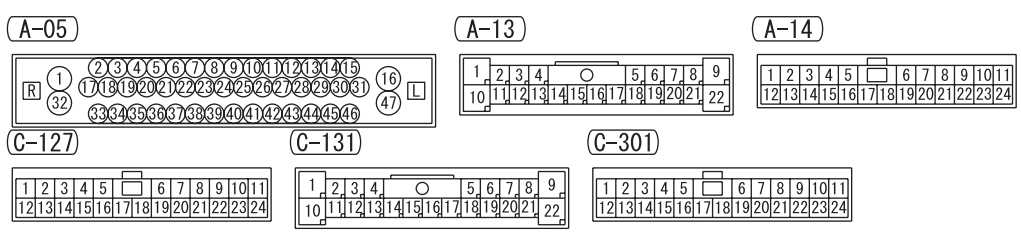
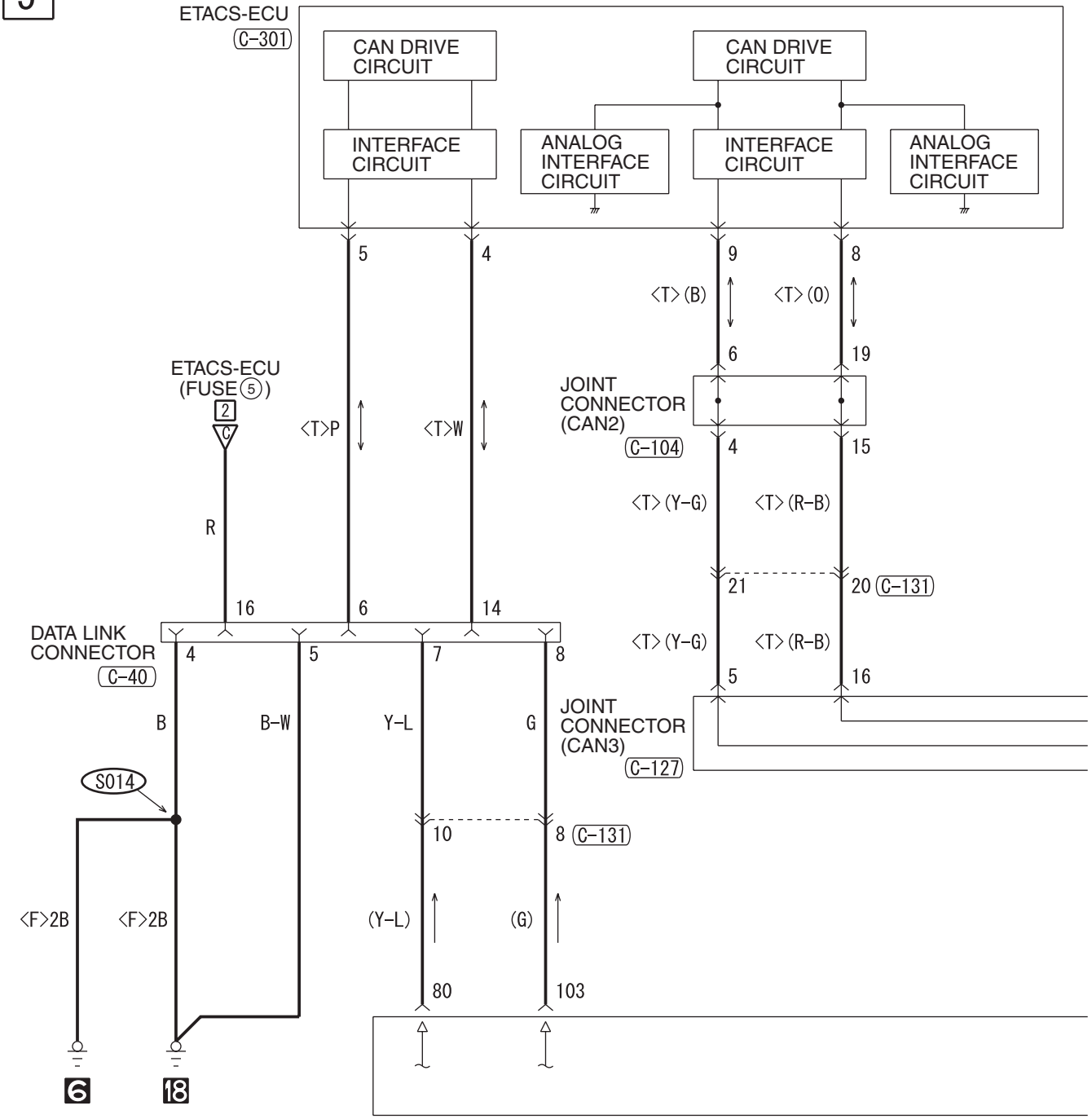

6

NOTE
 * : THE TERMINAL NUMBERS DESCRIBED
 IN THE CIRCUIT DIAGRAM AGREE WITH
 THE NUMBERS MADE ON THE
 TRANSAXLE ASSEMBLY CONNECTOR AND
 HARNESS SIDE CONNECTOR.

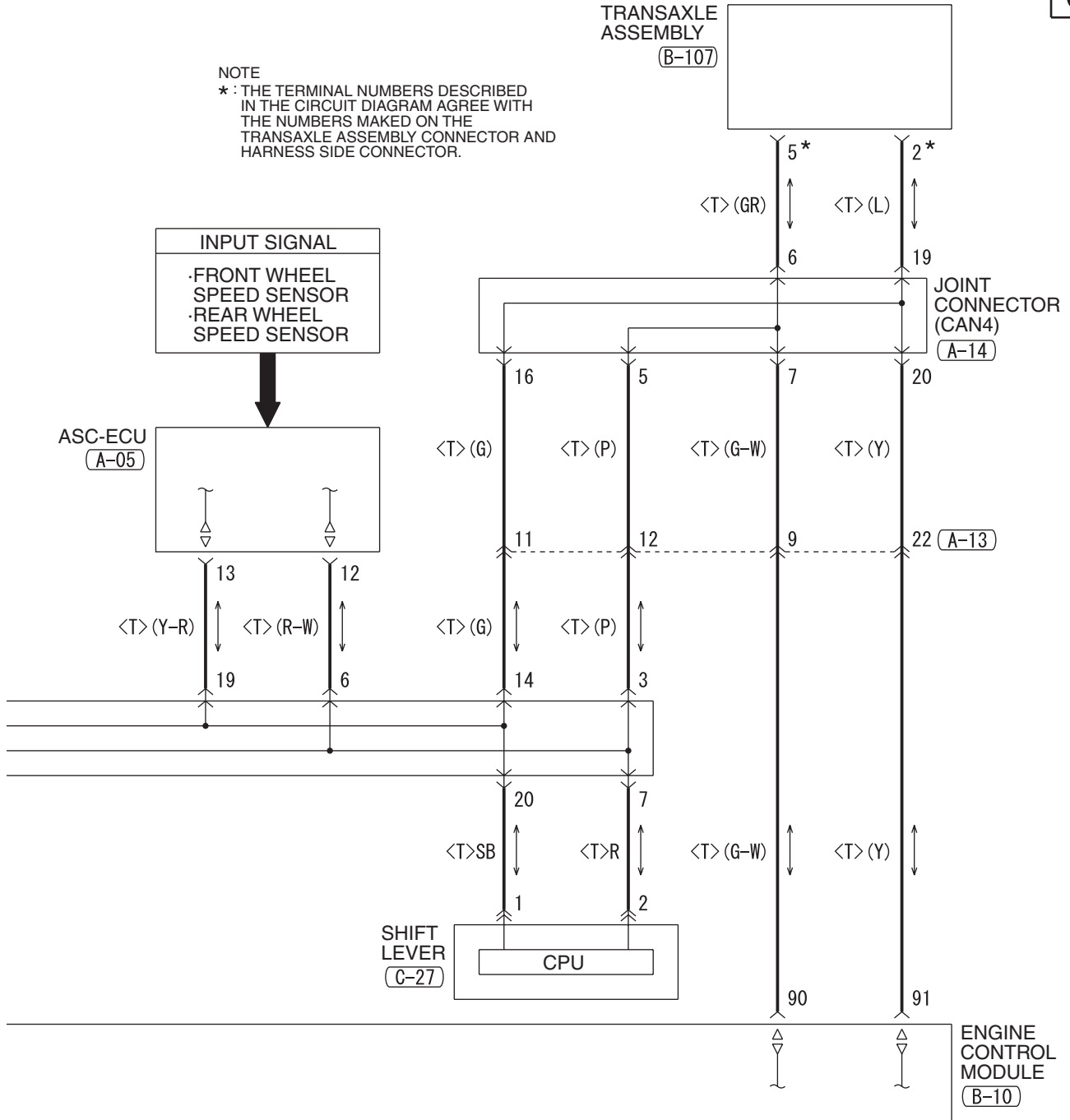

(B-10)

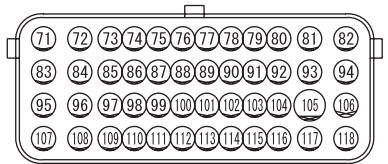

(B-107)*



(C-27)

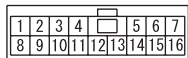

(C-40) FRONT SIDE

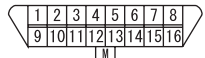

(C-104)

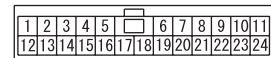

AUTO-CRUISE CONTROL SYSTEM <TC-SST> (CONTINUED)

7

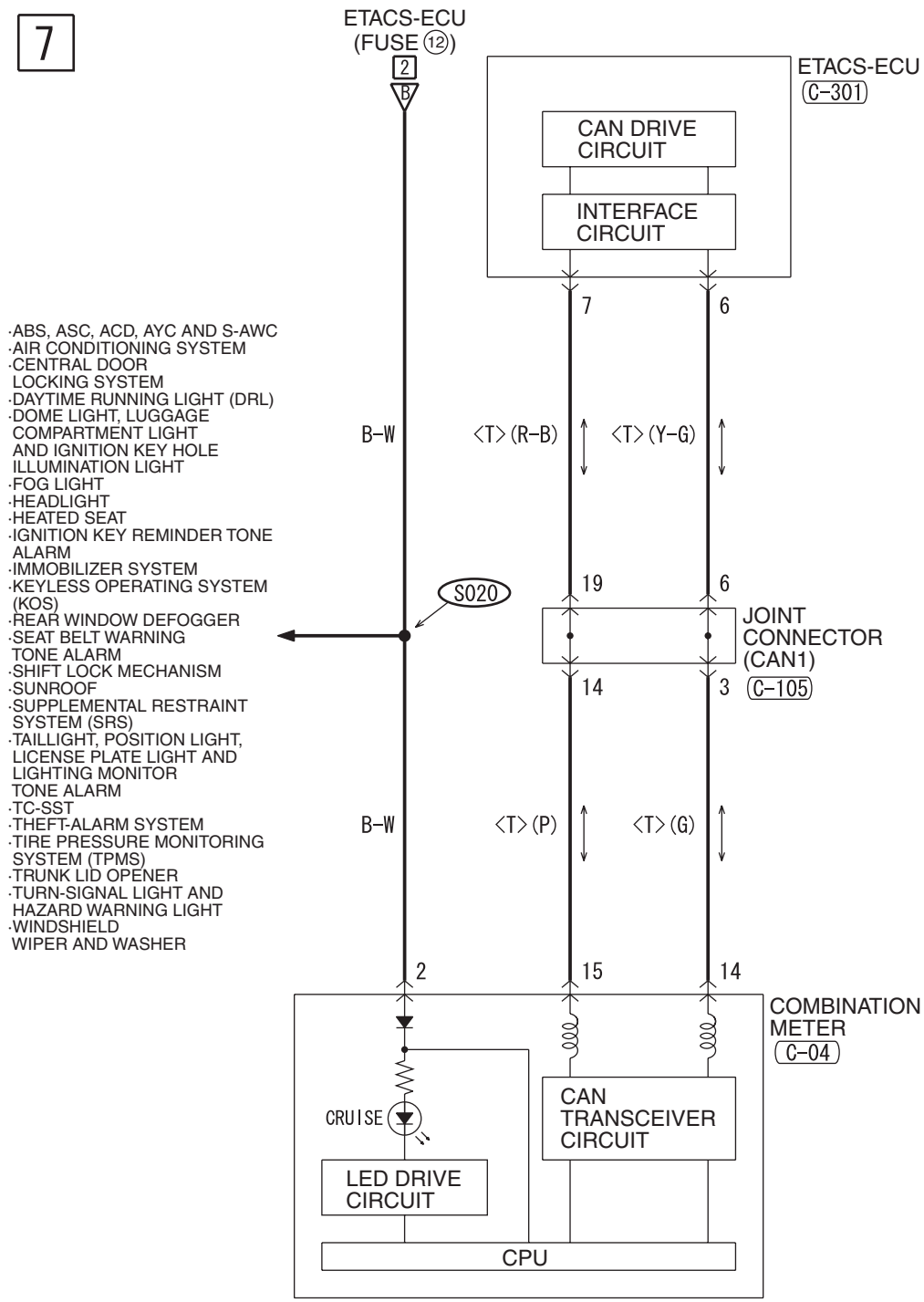

(C-04)

1	2	3	4	5	6	7	8	9	10	11	12
13	14	15	16	17	18	19	20	21	22	23	24

(C-105)

1	2	3	4	5	6	7	8	9	10	11		
12	13	14	15	16	17	18	19	20	21	22	23	24

(C-301)

1	2	3	4	5	6	7	8	9	10	11		
12	13	14	15	16	17	18	19	20	21	22	23	24

WIRE COLOR CODE
 B : BLACK LG : LIGHT GREEN G : GREEN L : BLUE W : WHITE Y : YELLOW SB : SKY BLUE
 BR : BROWN O : ORANGE GR : GRAY R : RED P : PINK V : VIOLET PU : PURPLE SI : SILVER

NOTES

TIRE PRESSURE MONITORING SYSTEM (TPMS) <M/T>

M1901003900419

1

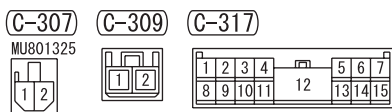
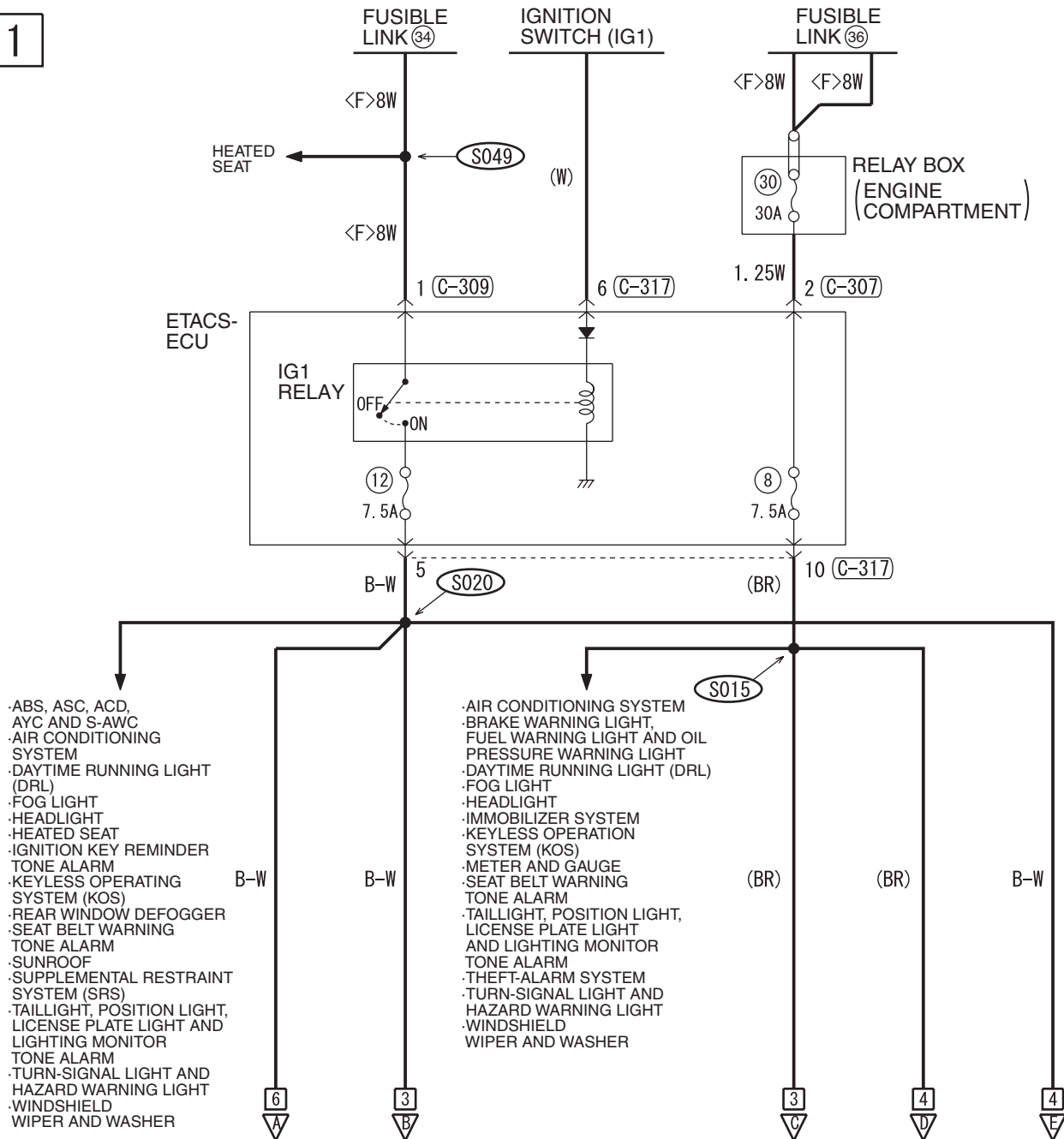

2

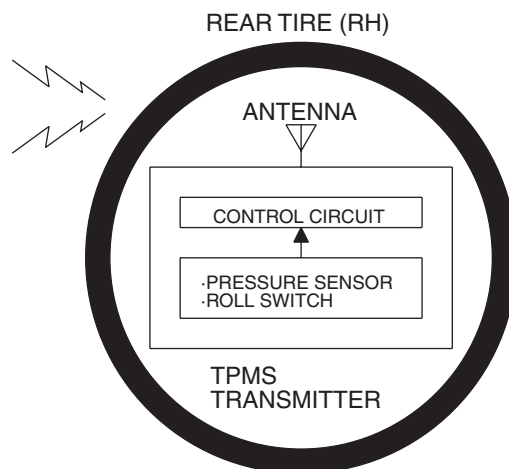
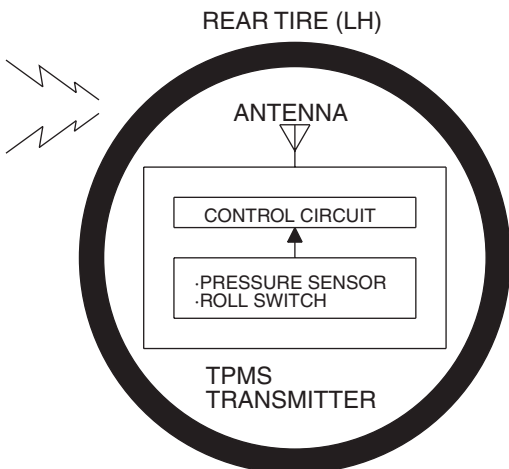
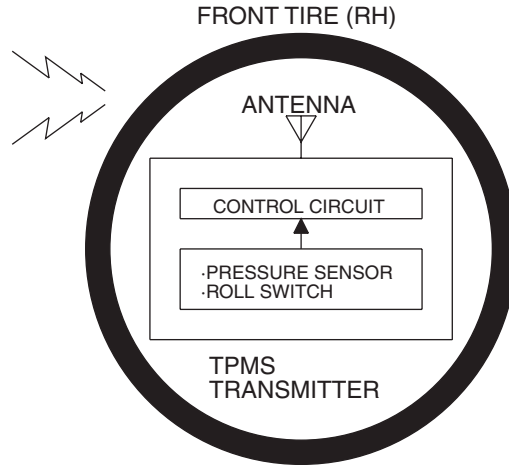
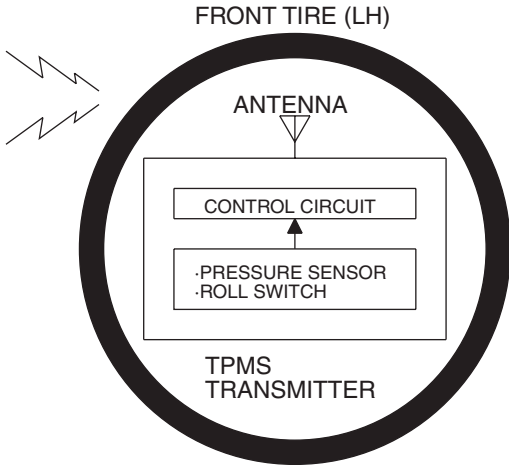

WIRE COLOR CODE
 B : BLACK LG : LIGHT GREEN G : GREEN L : BLUE W : WHITE Y : YELLOW SB : SKY BLUE
 BR : BROWN O : ORANGE GR : GRAY R : RED P : PINK V : VIOLET PU : PURPLE SI : SILVER

H8G15M41AB

TSB Revision

TIRE PRESSURE MONITORING (TPMS) <M/T> (CONTINUED)

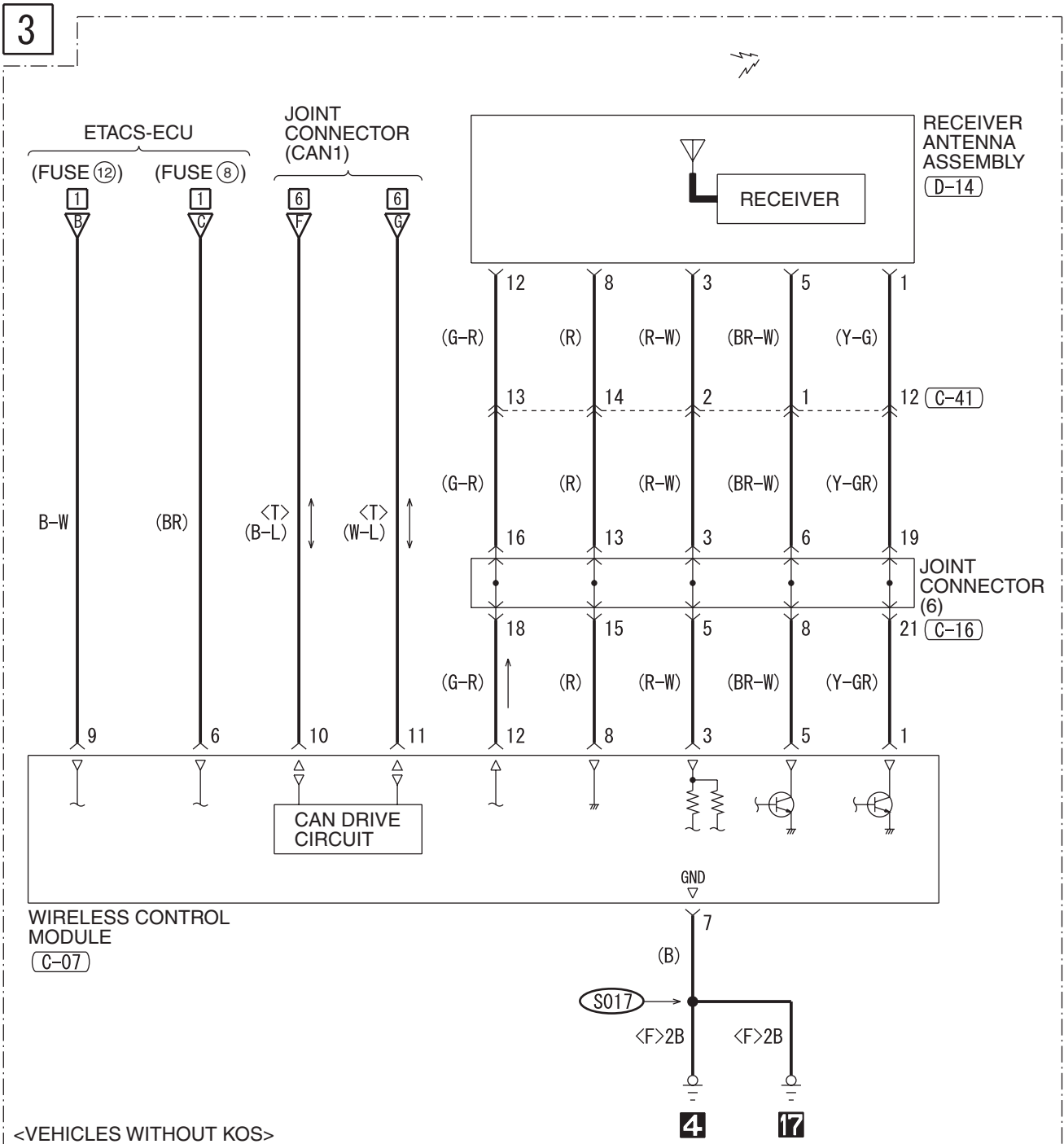

(C-05)

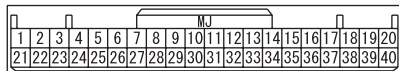

(C-07)

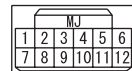

(C-16)

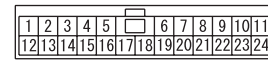

(C-41)

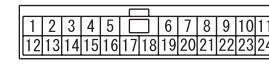

(D-14)

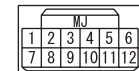

4

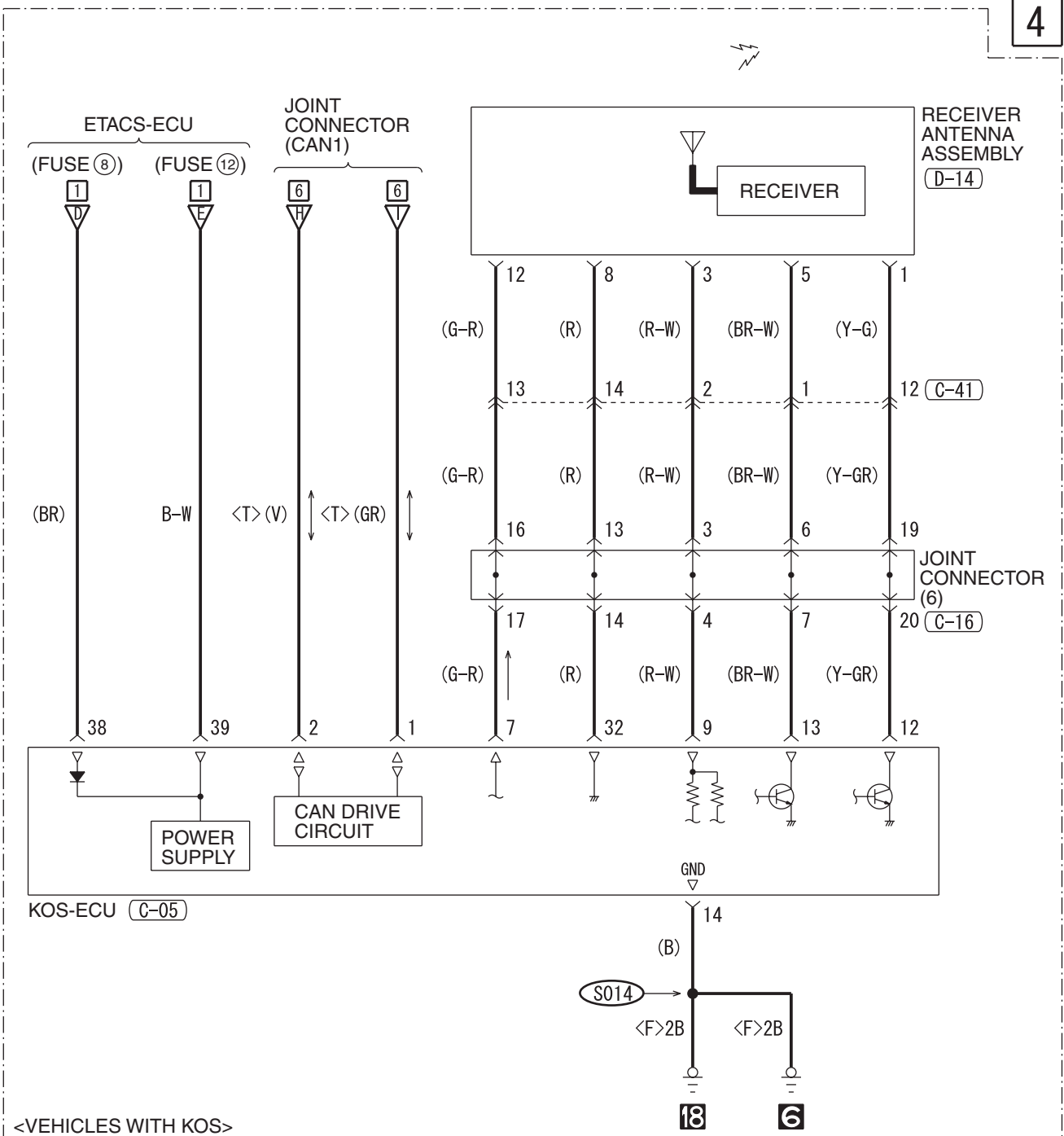

<VEHICLES WITH KOS>

WIRE COLOR CODE
 B: BLACK LG: LIGHT GREEN G: GREEN L: BLUE W: WHITE Y: YELLOW SB: SKY BLUE
 BR: BROWN O: ORANGE GR: GRAY R: RED P: PINK V: VIOLET PU: PURPLE SI: SILVER

H8G15M41BB

TSB Revision

TIRE PRESSURE MONITORING (TPMS) <M/T> (CONTINUED)

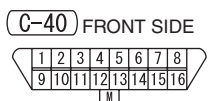
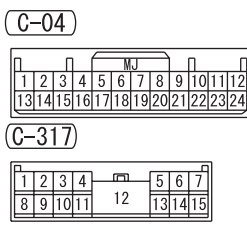
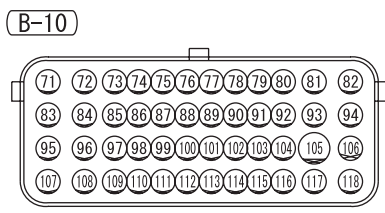
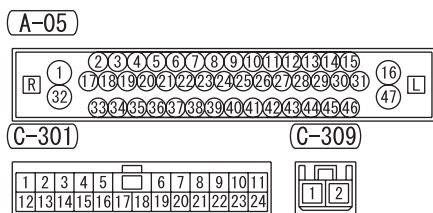
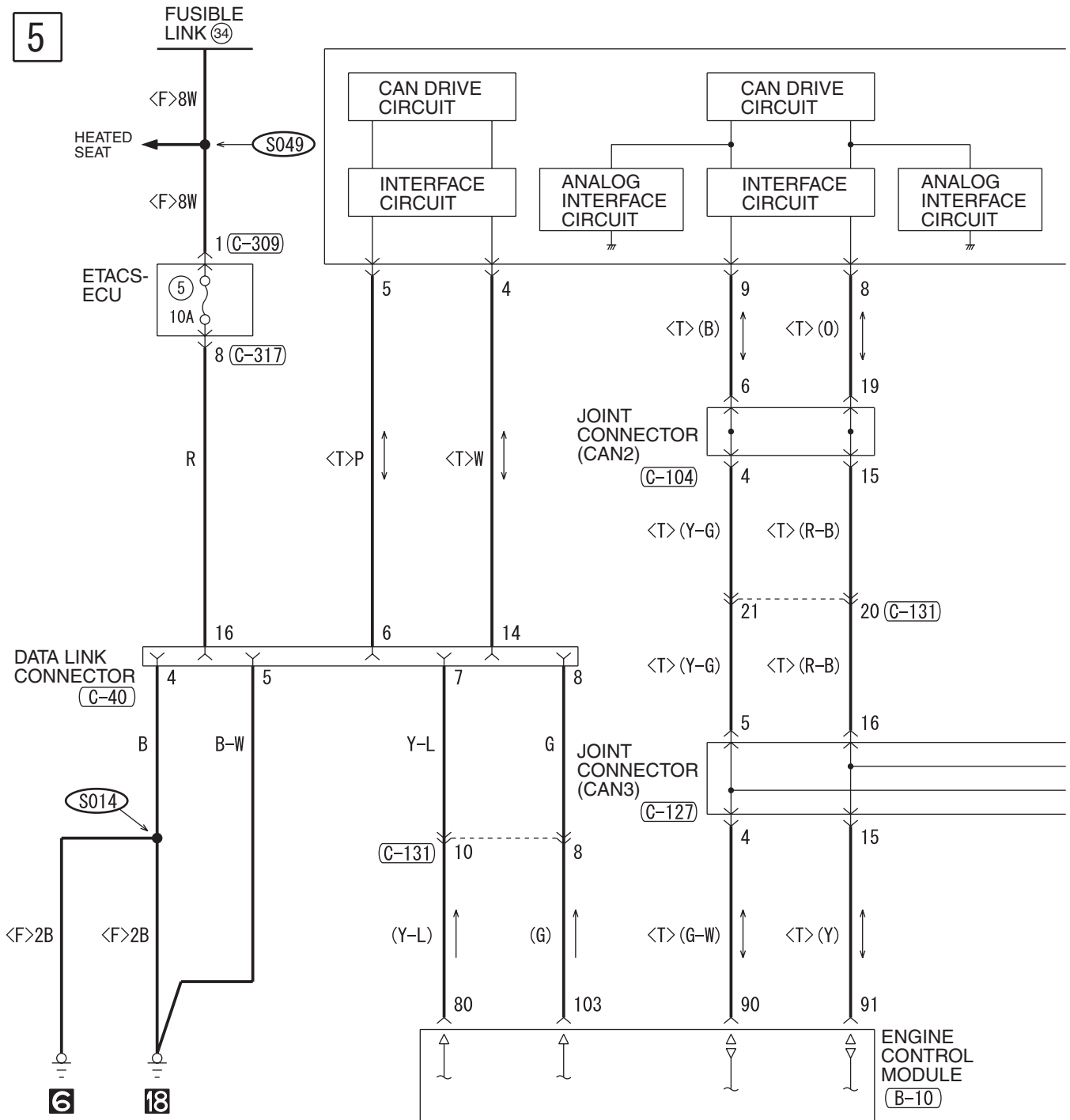

6

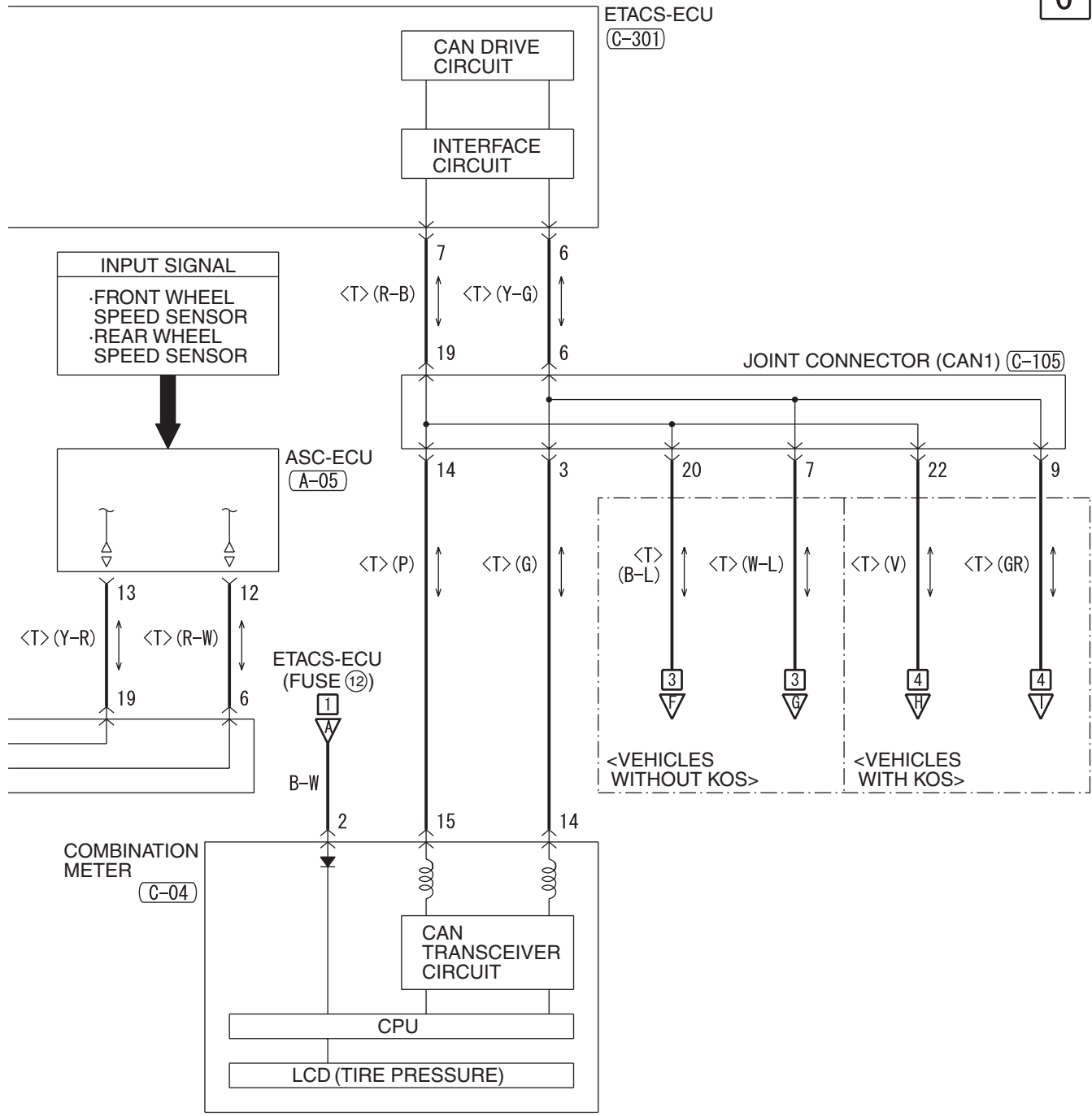

(C-104)

1	2	3	4	5	6	7	8	9	10	11		
12	13	14	15	16	17	18	19	20	21	22	23	24

(C-105)

1	2	3	4	5	6	7	8	9	10	11		
12	13	14	15	16	17	18	19	20	21	22	23	24

(C-127)

1	2	3	4	5	6	7	8	9	10	11		
12	13	14	15	16	17	18	19	20	21	22	23	24

(C-131)

1	2	3	4	5	6	7	8	9				
10	11	12	13	14	15	16	17	18	19	20	21	22

WIRE COLOR CODE

B: BLACK LG: LIGHT GREEN G: GREEN L: BLUE W: WHITE Y: YELLOW SB: SKY BLUE
 BR: BROWN O: ORANGE GR: GRAY R: RED P: PINK V: VIOLET PU: PURPLE SI: SILVER

H8G15M41CB

TIRE PRESSURE MONITORING SYSTEM (TPMS) <TC-SST>

M1901003900420

1

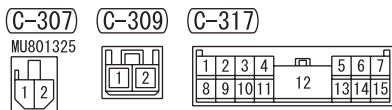
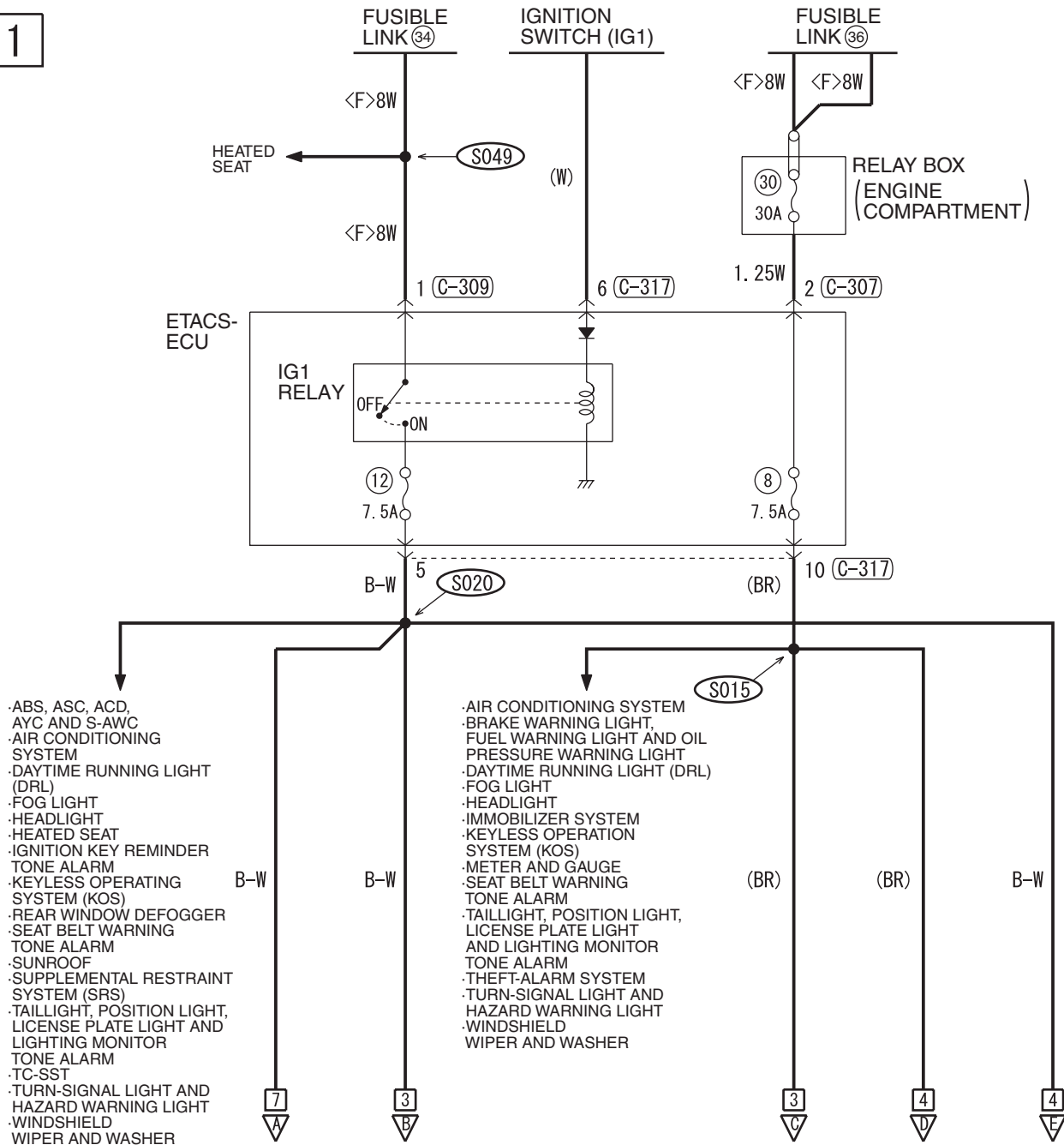

2

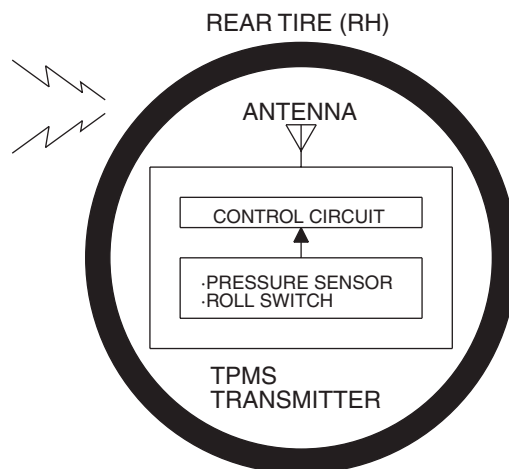
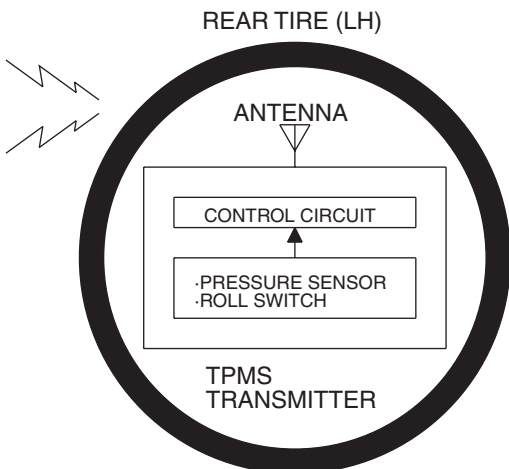
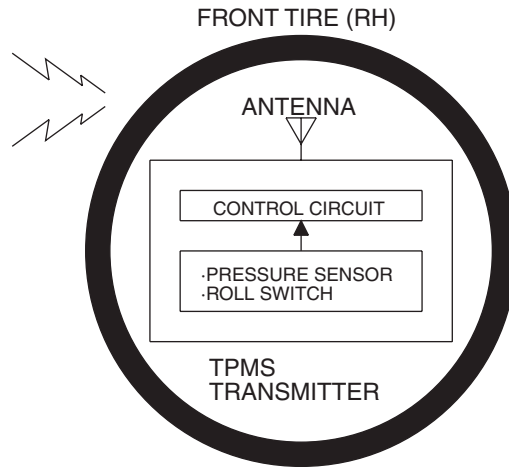
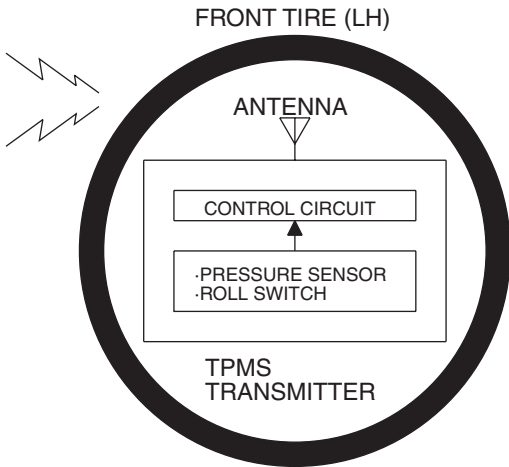

WIRE COLOR CODE
 B : BLACK LG : LIGHT GREEN G : GREEN L : BLUE W : WHITE Y : YELLOW SB : SKY BLUE
 BR : BROWN O : ORANGE GR : GRAY R : RED P : PINK V : VIOLET PU : PURPLE SI : SILVER

H8G15M42AB

TSB Revision

TIRE PRESSURE MONITORING (TPMS) <TC-SST> (CONTINUED)

3

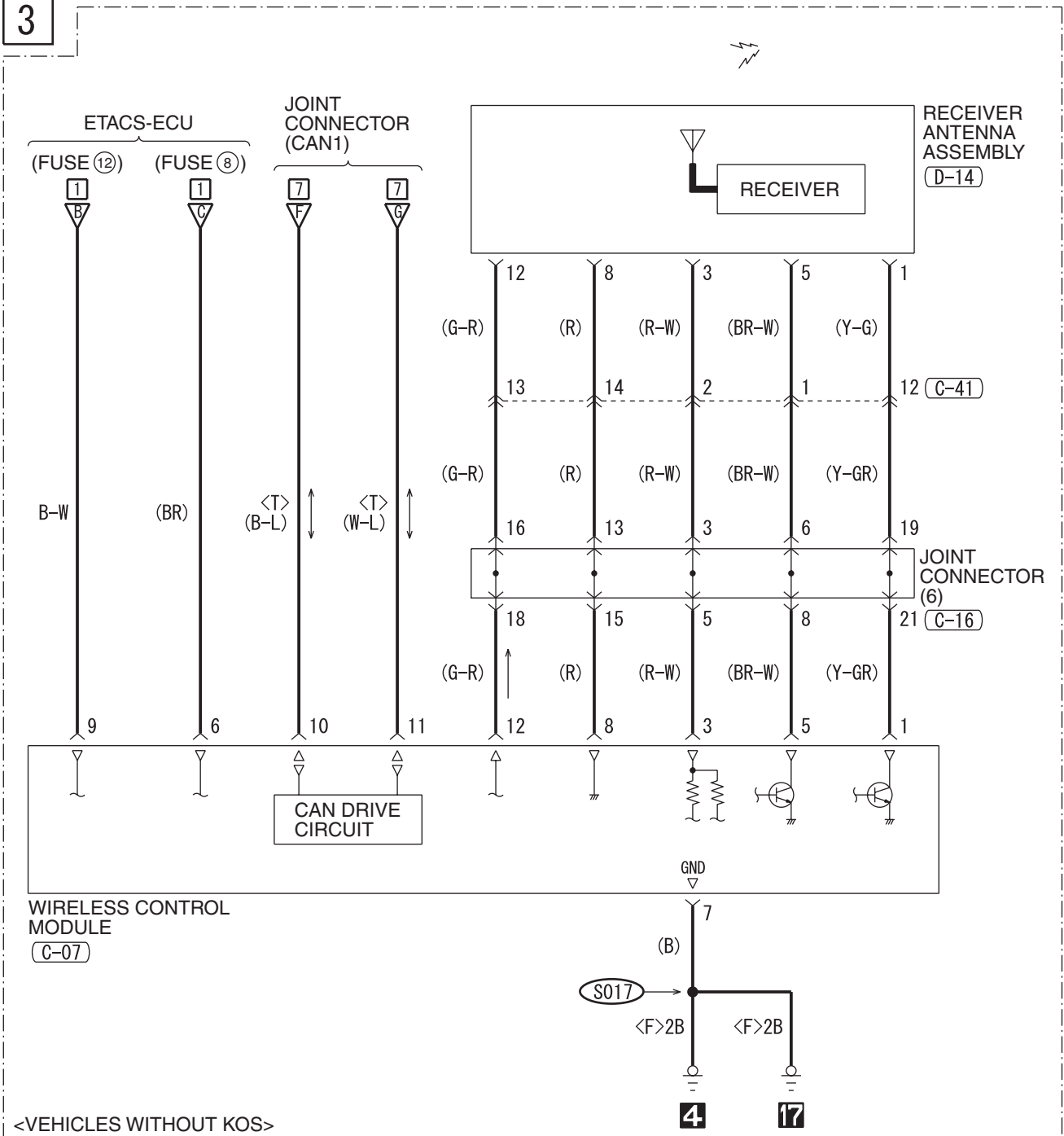

<VEHICLES WITHOUT KOS>

(C-05)

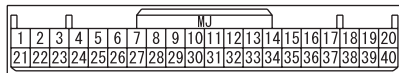

(C-07)

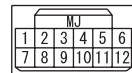

(C-16)

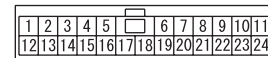

(C-41)

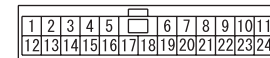

(D-14)

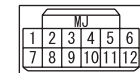

4

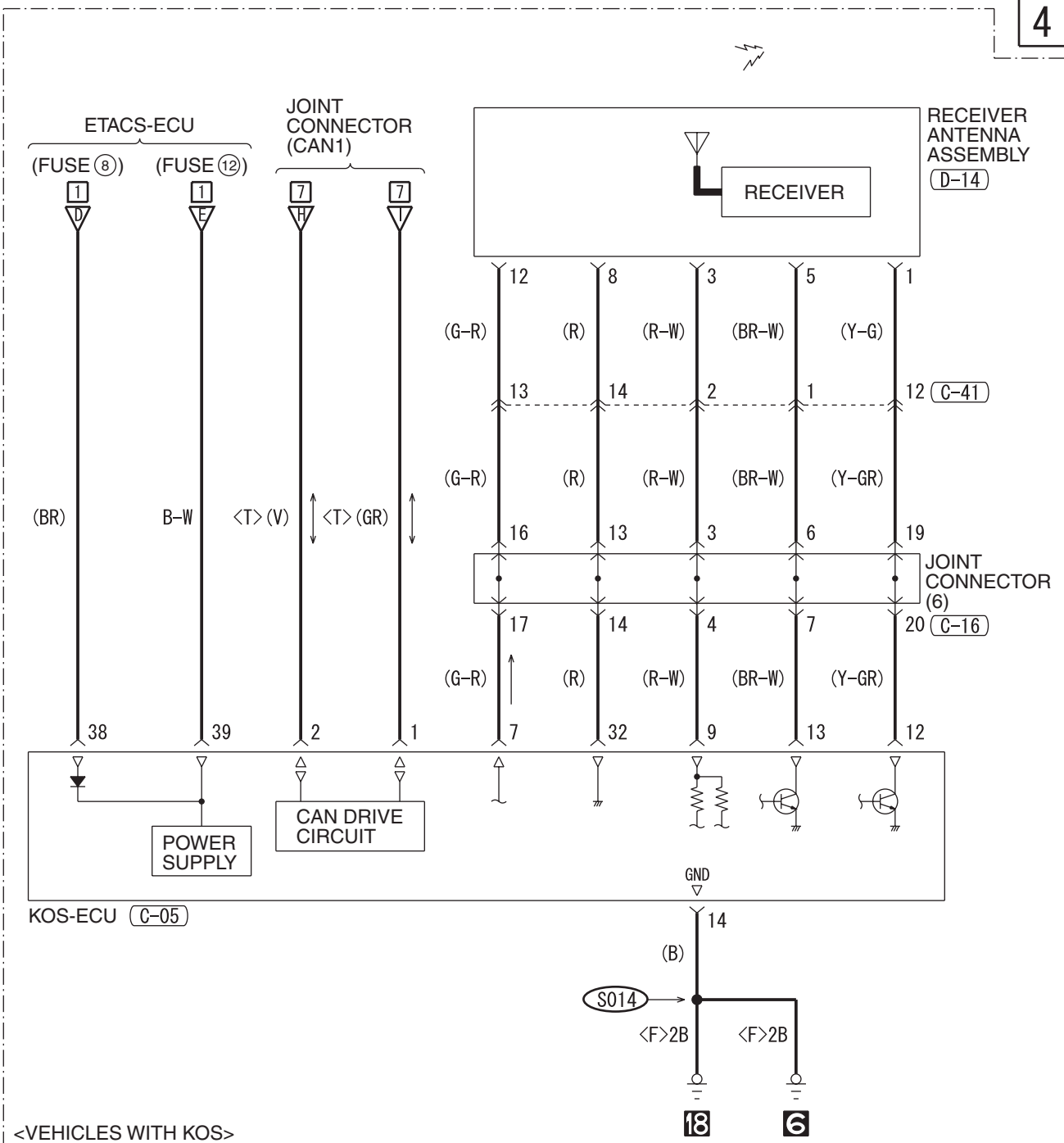

<VEHICLES WITH KOS>

WIRE COLOR CODE
 B: BLACK LG: LIGHT GREEN G: GREEN L: BLUE W: WHITE Y: YELLOW SB: SKY BLUE
 BR: BROWN O: ORANGE GR: GRAY R: RED P: PINK V: VIOLET PU: PURPLE SI: SILVER

H8G15M42BB

TSB Revision

TIRE PRESSURE MONITORING (TPMS) <TC-SST> (CONTINUED)

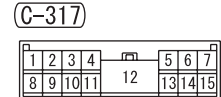
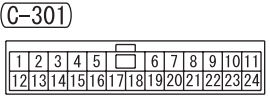
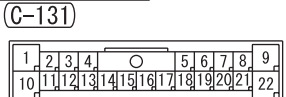
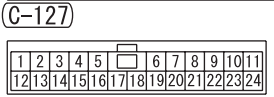
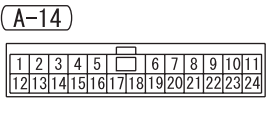
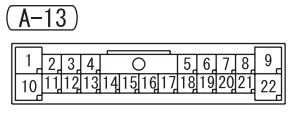
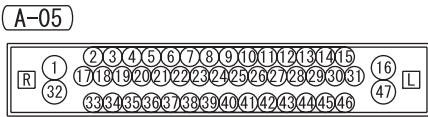
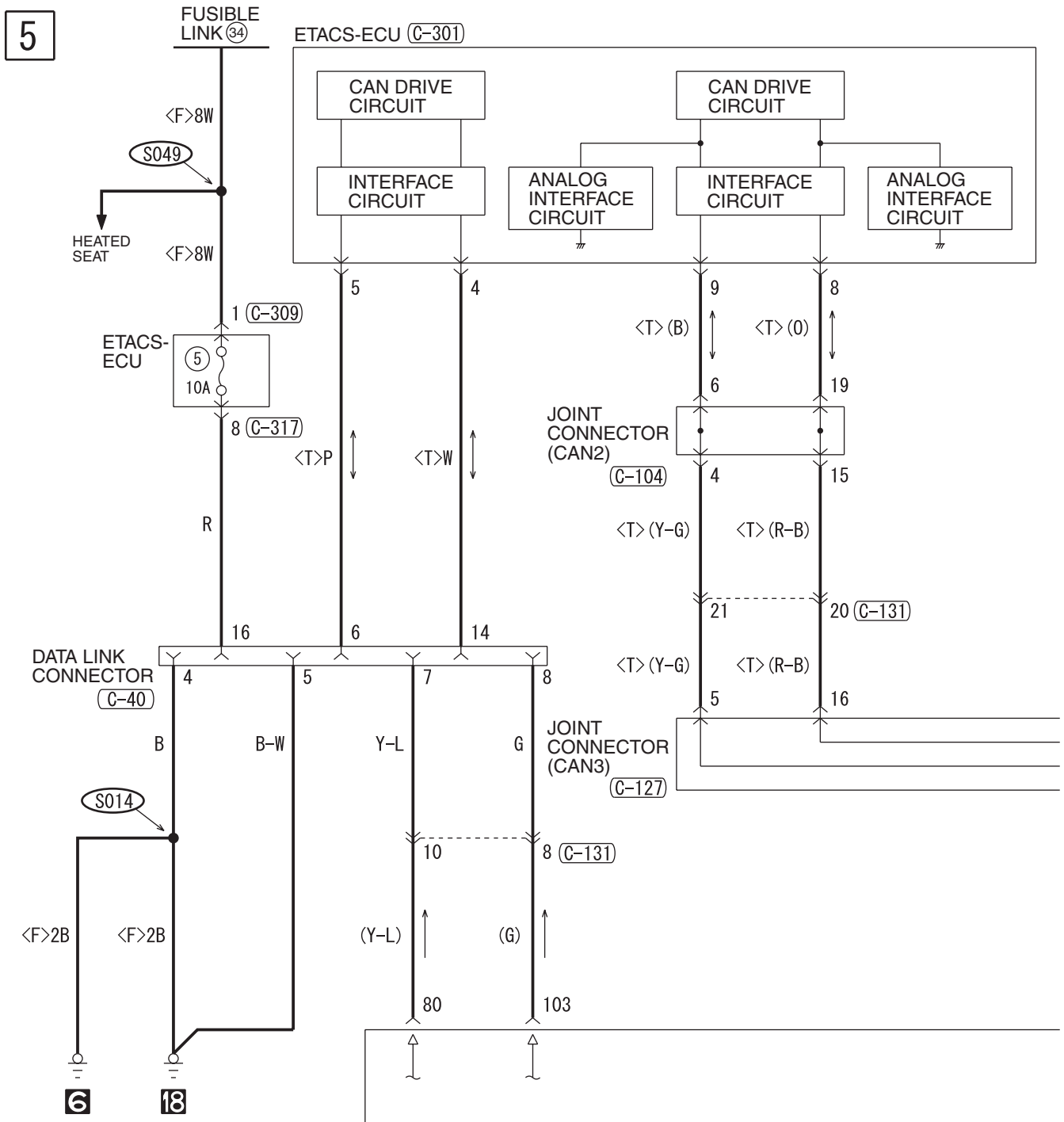

6

NOTE
* : THE TERMINAL NUMBERS DESCRIBED
IN THE CIRCUIT DIAGRAM AGREE WITH
THE NUMBERS MADE ON THE
TRANSAXLE ASSEMBLY CONNECTOR AND
HARNESS SIDE CONNECTOR.

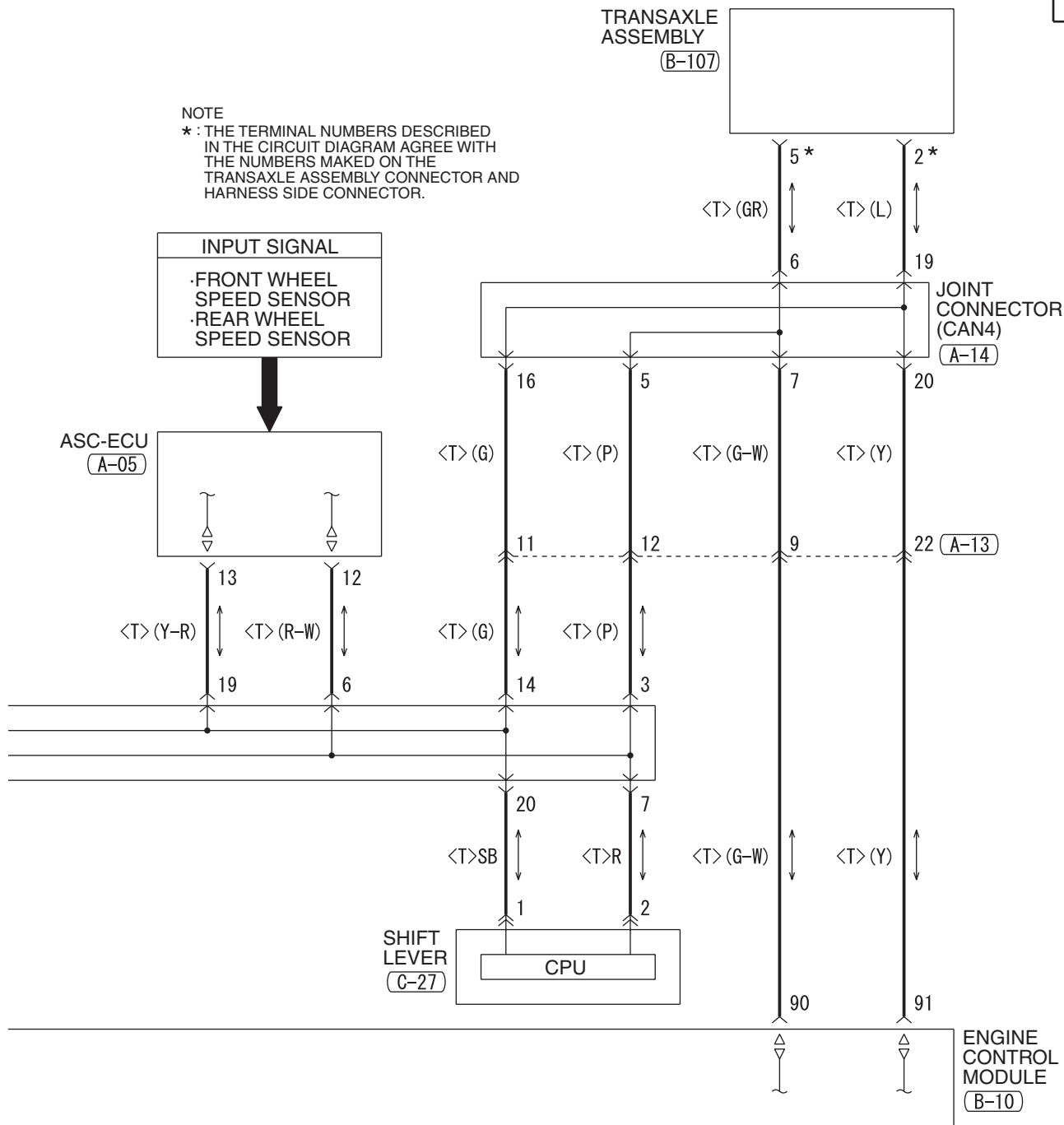

(B-10)

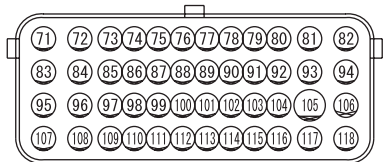

(B-107)*



(C-27)

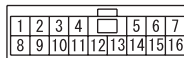

(C-40) FRONT SIDE



(C-104)

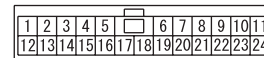

TIRE PRESSURE MONITORING (TPMS) <TC-SST> (CONTINUED)

7

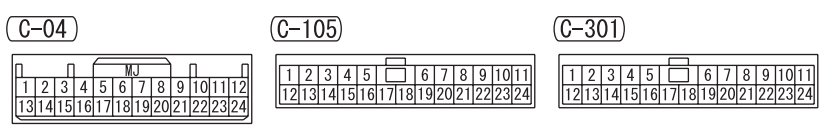
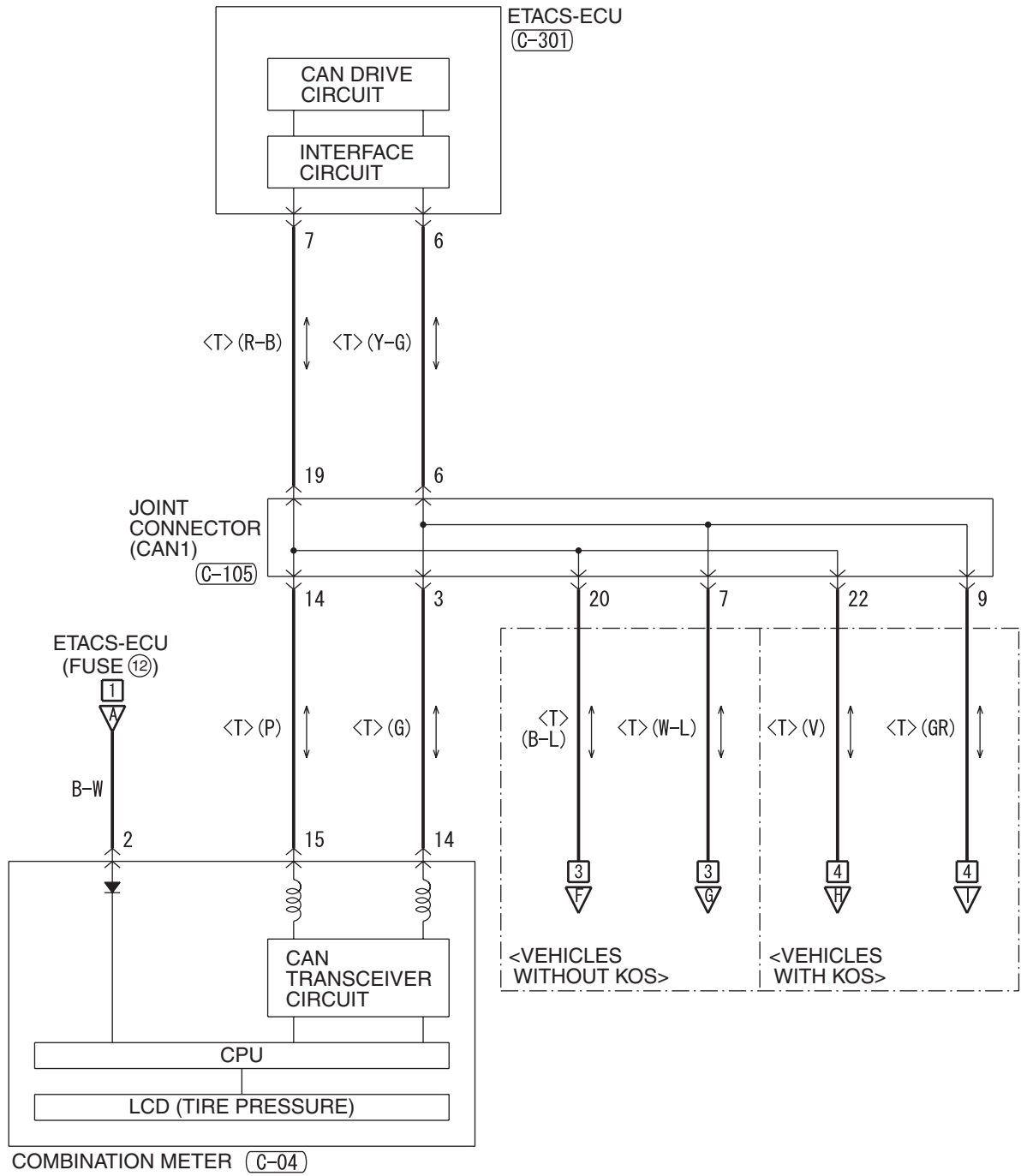

WIRE COLOR CODE
 B: BLACK LG: LIGHT GREEN G: GREEN L: BLUE W: WHITE Y: YELLOW SB: SKY BLUE
 BR: BROWN O: ORANGE GR: GRAY R: RED P: PINK V: VIOLET PU: PURPLE SI: SILVER

H8G15M42DA

NOTES

IMMOBILIZER SYSTEM <M/T>

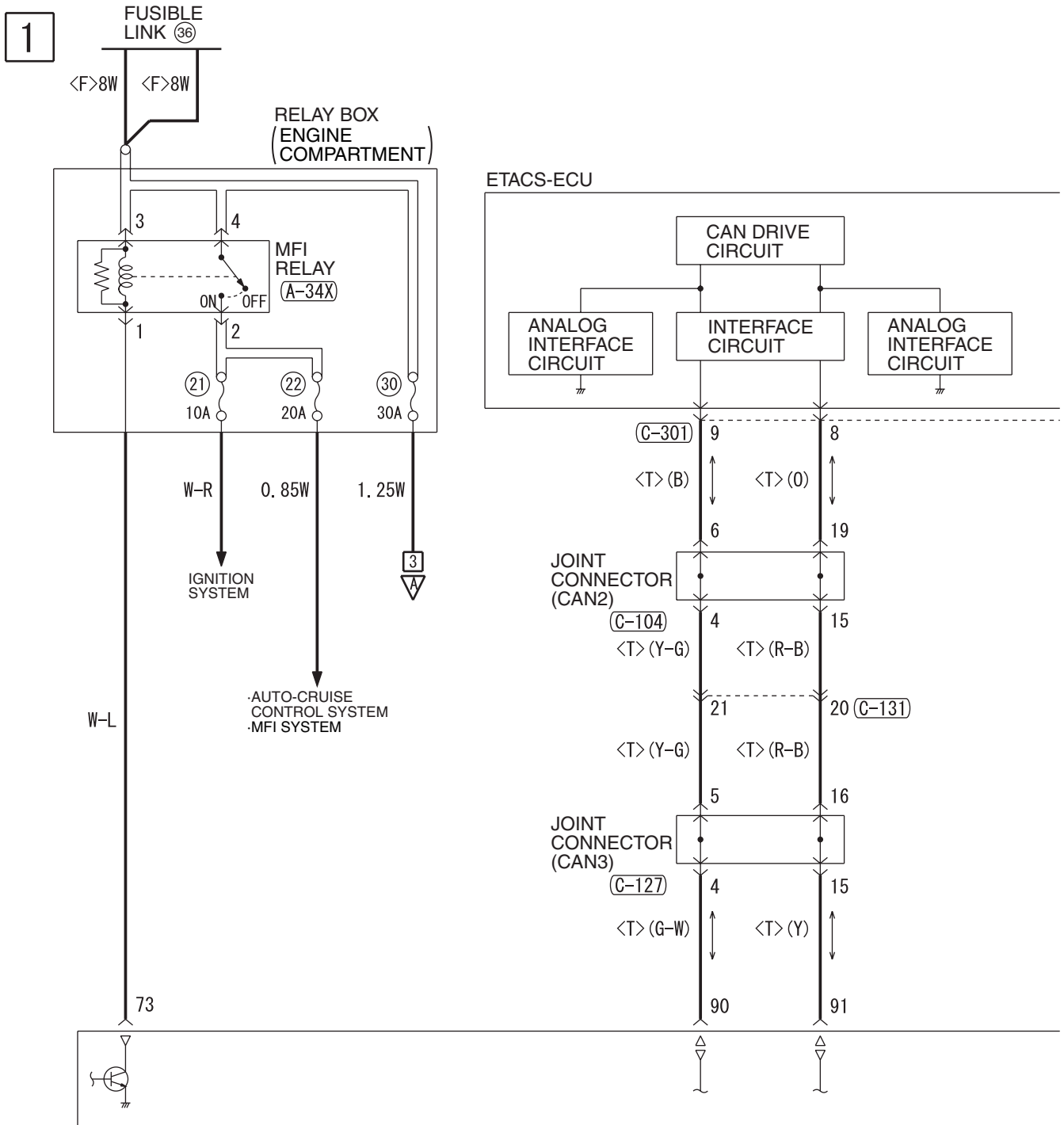

(A-34X)

(B-10)

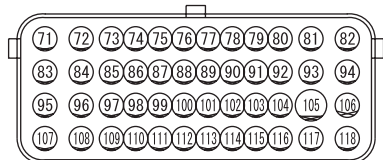

(C-40) FRONT SIDE

(C-104)

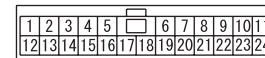
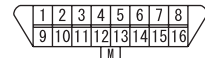

(C-105)

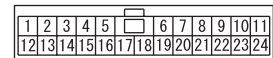

2

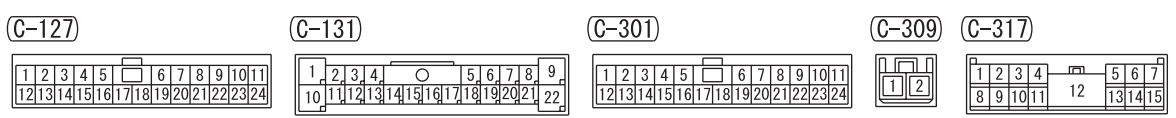
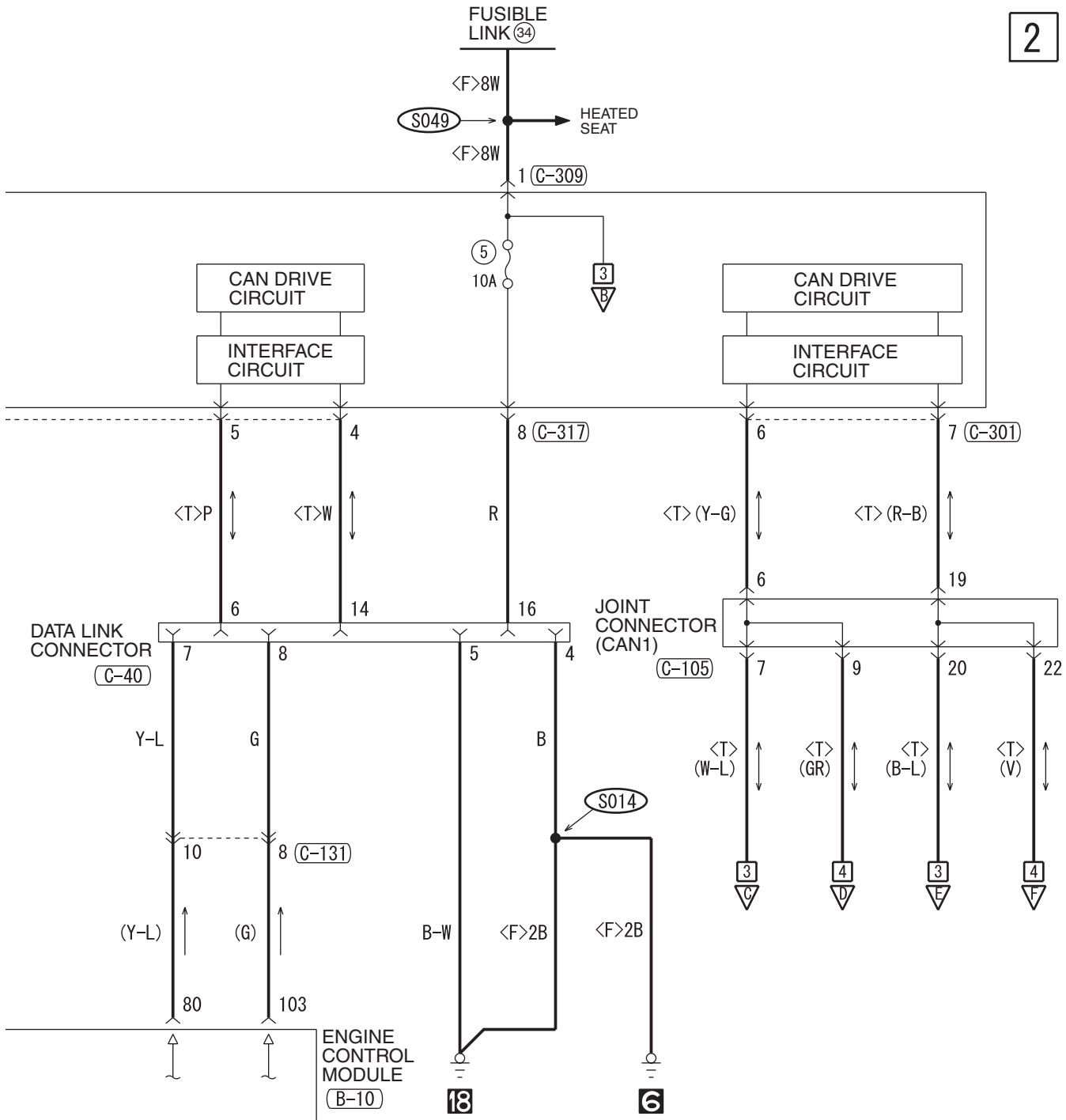

WIRE COLOR CODE
 B : BLACK LG : LIGHT GREEN G : GREEN L : BLUE W : WHITE Y : YELLOW SB : SKY BLUE
 BR : BROWN O : ORANGE GR : GRAY R : RED P : PINK V : VIOLET PU : PURPLE SI : SILVER

IMMOBILIZER SYSTEM <M/T> (CONTINUED)

3

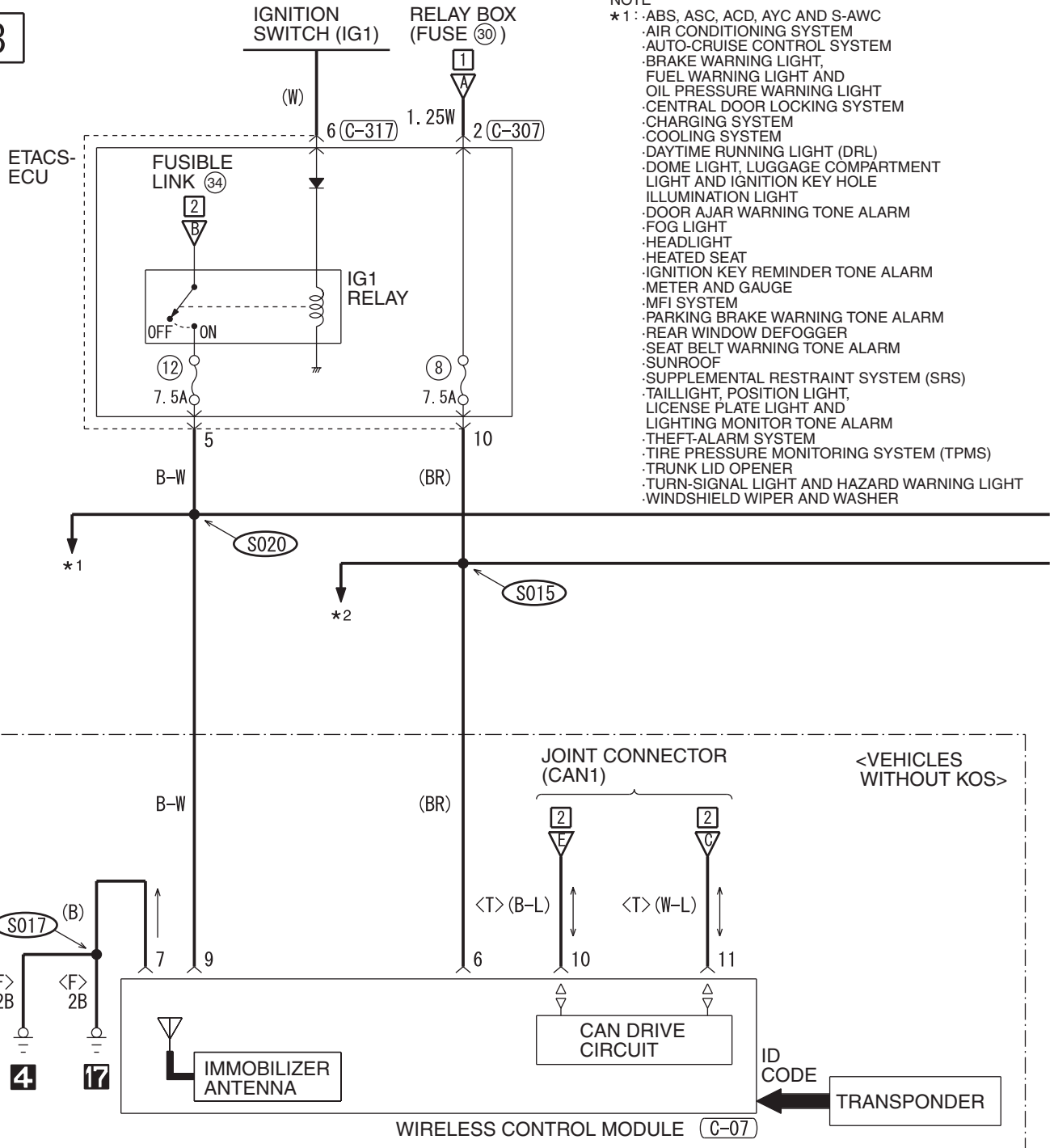

C-05

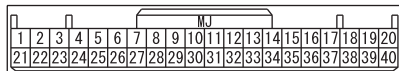

C-07

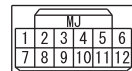

C-08

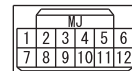

C-16

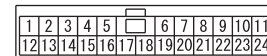

C-307



C-317

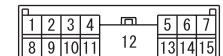

- *2: -AIR CONDITIONING SYSTEM
- BRAKE WARNING LIGHT,
- FUEL WARNING LIGHT AND OIL
- PRESSURE WARNING LIGHT
- CENTRAL DOOR LOCKING SYSTEM
- DAYTIME RUNNING LIGHT (DRL)
- DOME LIGHT, LUGGAGE
- COMPARTMENT LIGHT AND
- IGNITION KEY HOLE
- ILLUMINATION LIGHT
- FOG LIGHT
- HEADLIGHT
- IGNITION KEY REMINDER TONE ALARM
- <VEHICLES WITH KOS>
- METER AND GAUGE
- SEAT BELT WARNING TONE ALARM
- TAILLIGHT, POSITION LIGHT,
- LICENSE PLATE LIGHT
- AND LIGHTING MONITOR
- TONE ALARM
- THEFT-ALARM SYSTEM
- TIRE PRESSURE MONITORING SYSTEM (TPMS)
- TRUNK LID OPENER
- TURN-SIGNAL LIGHT AND HAZARD WARNING LIGHT
- WINDSHIELD WIPER AND WASHER

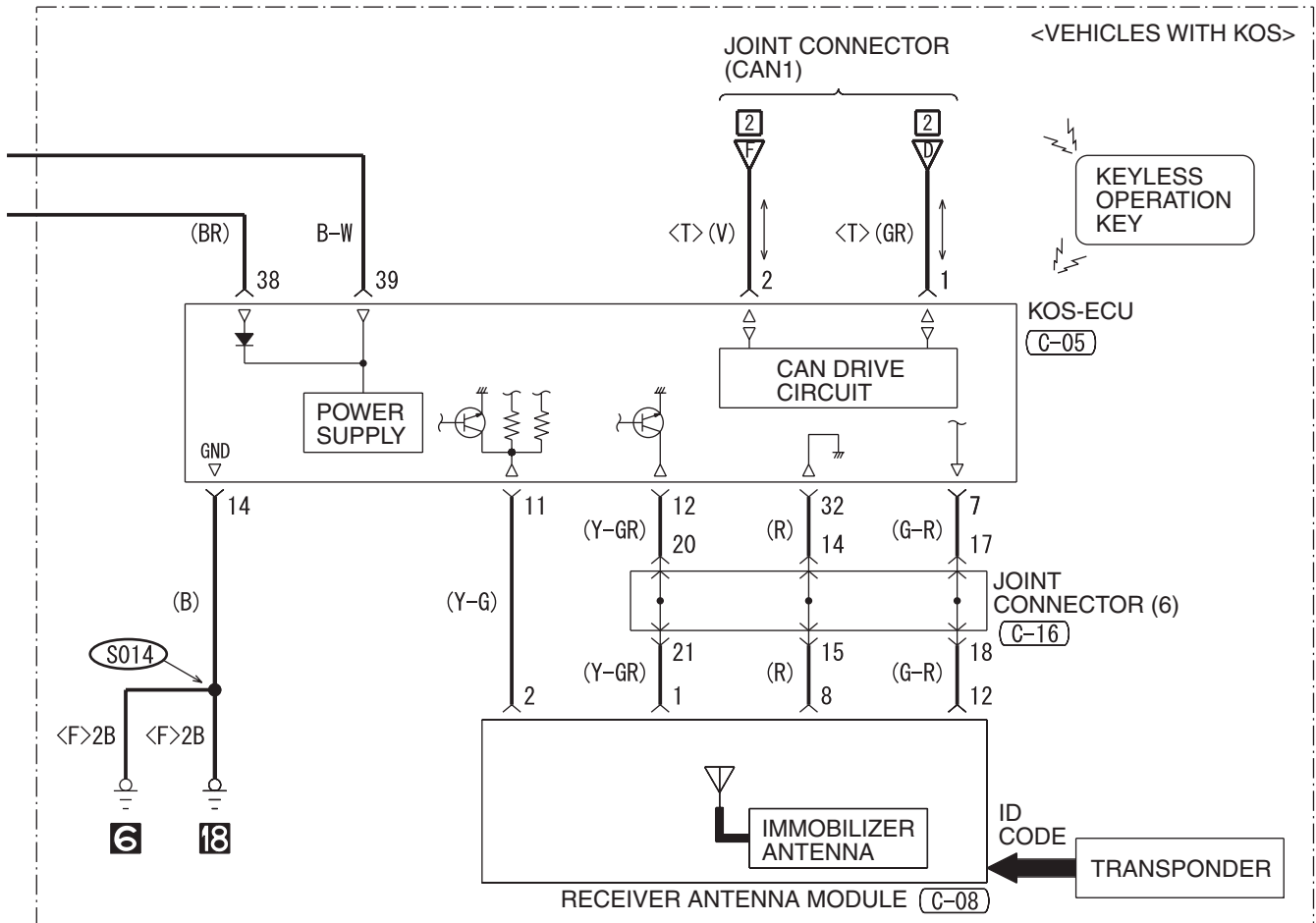

WIRE COLOR CODE

B: BLACK LG: LIGHT GREEN G: GREEN L: BLUE W: WHITE Y: YELLOW SB: SKY BLUE
BR: BROWN O: ORANGE GR: GRAY R: RED P: PINK V: VIOLET PU: PURPLE SI: SILVER

H8G15M43BB

IMMOBILIZER SYSTEM <TC-SST>

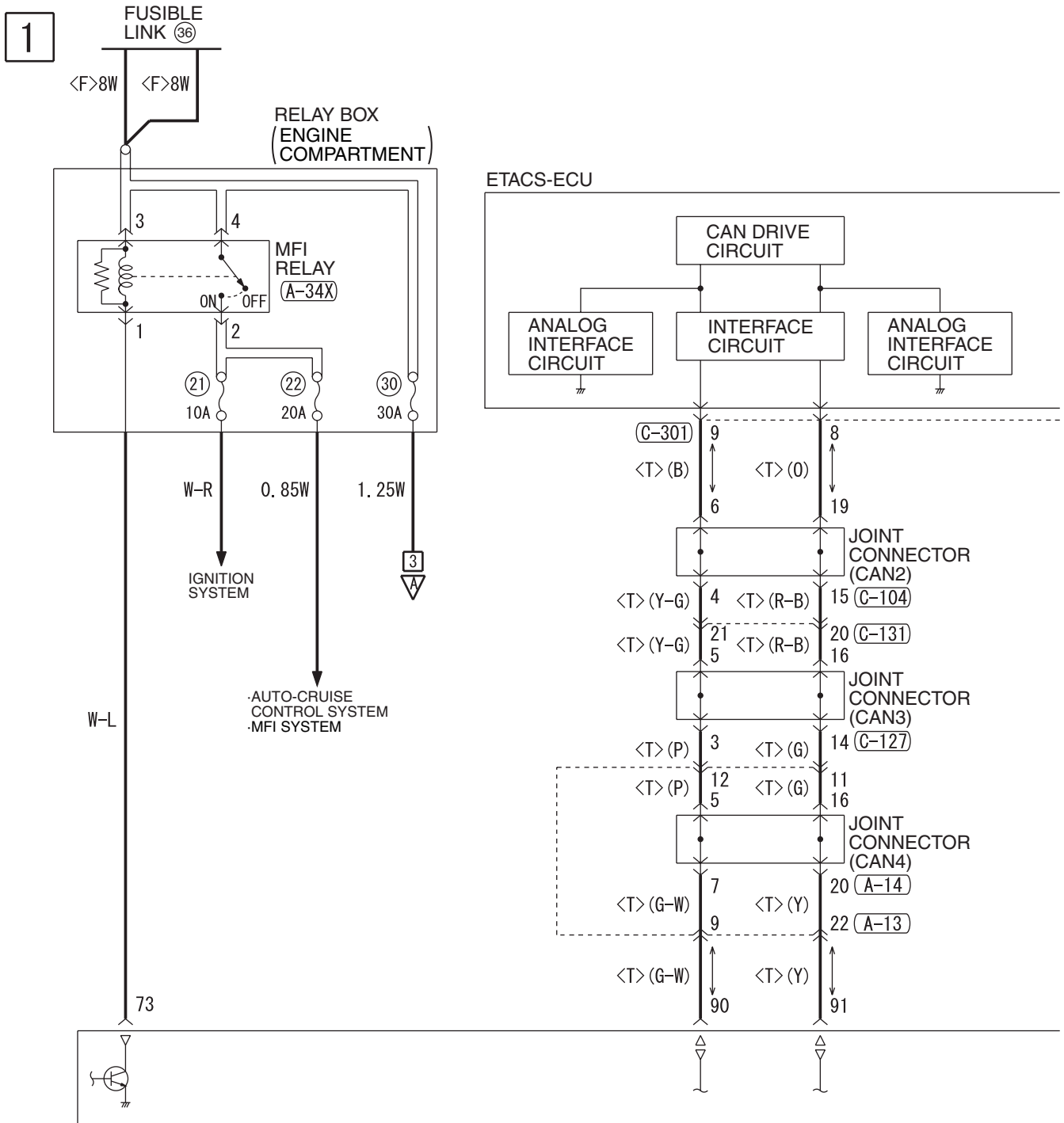

(A-13)

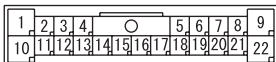

(A-14)

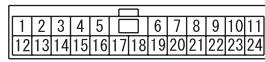

(A-34X)



(B-10)

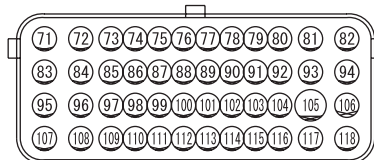

(C-40) FRONT SIDE



(C-301)

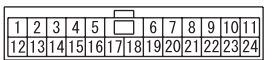

(C-309)



(C-317)

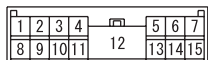

2

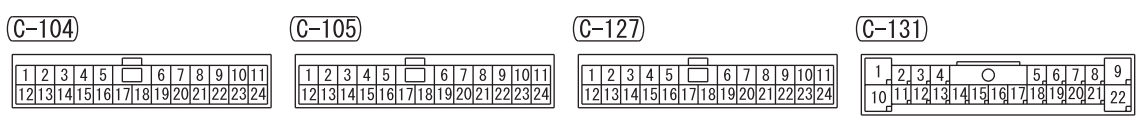
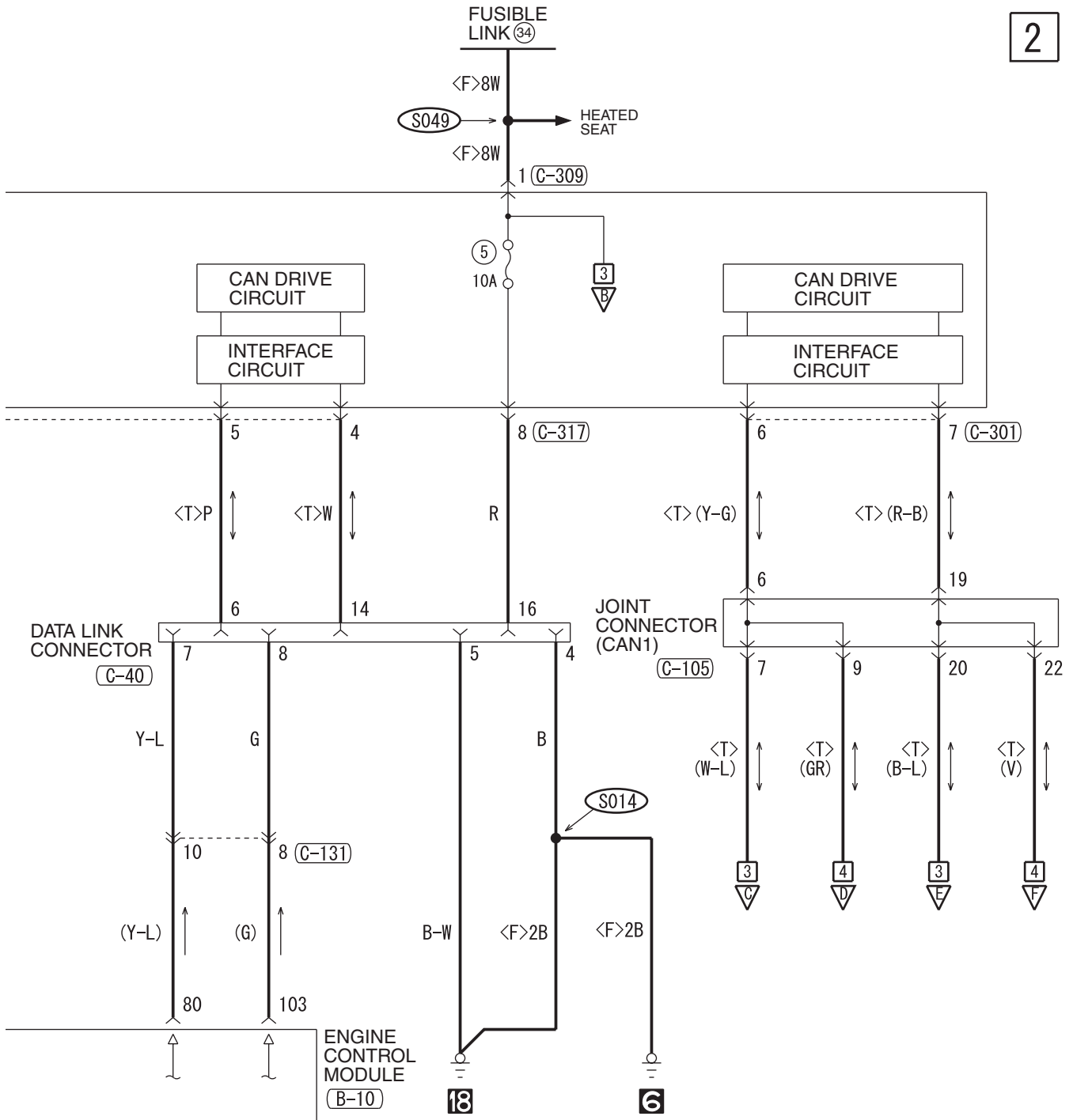

WIRE COLOR CODE
 B : BLACK LG : LIGHT GREEN G : GREEN L : BLUE W : WHITE Y : YELLOW SB : SKY BLUE
 BR : BROWN O : ORANGE GR : GRAY R : RED P : PINK V : VIOLET PU : PURPLE SI : SILVER

IMMOBILIZER SYSTEM <TC-SST> (CONTINUED)

3

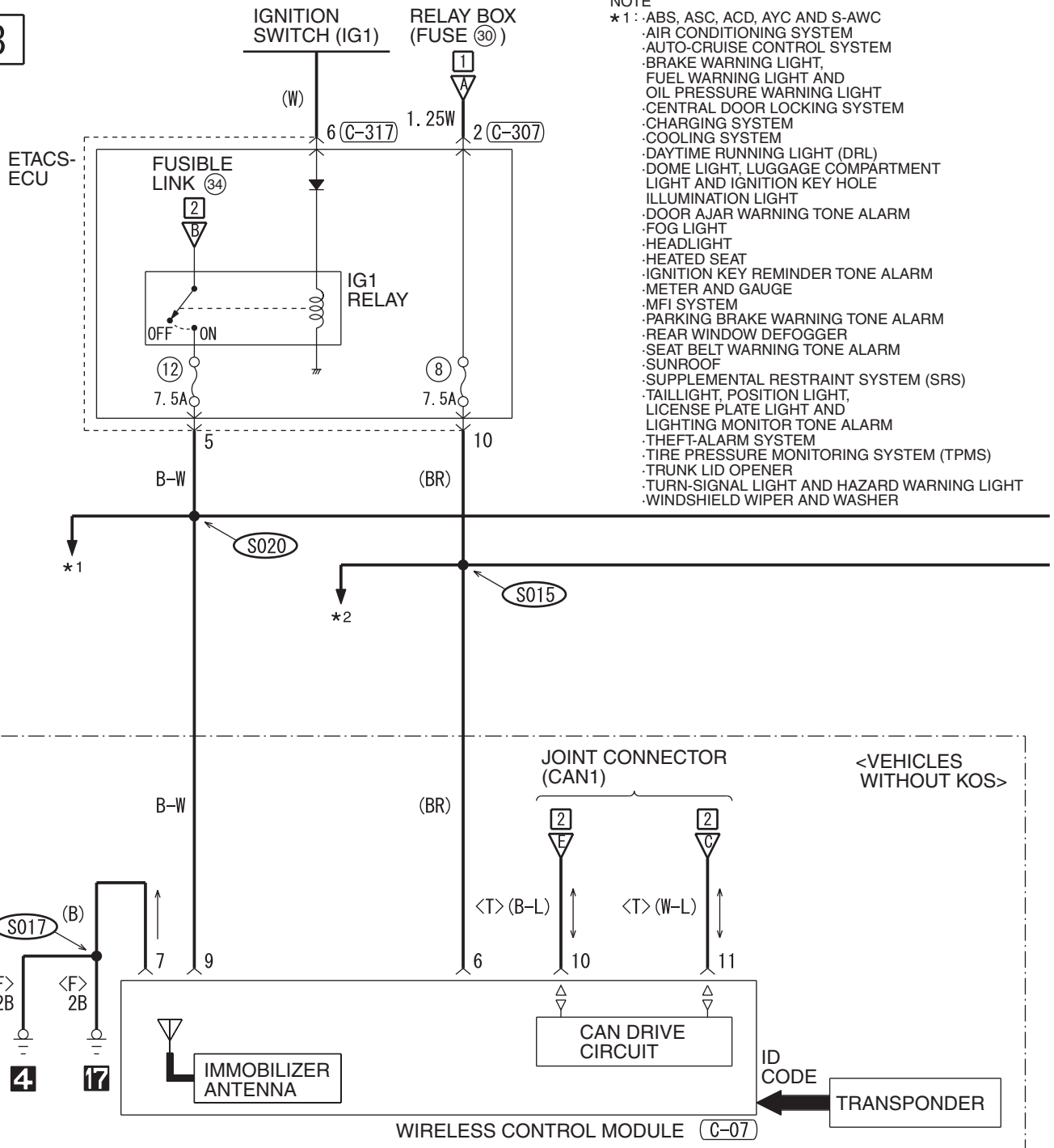

(C-05)

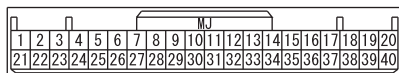

(C-07)

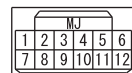

(C-08)

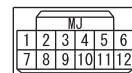

(C-16)

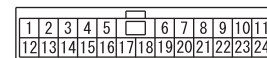

(C-307)



(C-317)

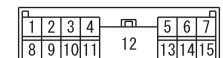

- *2: -AIR CONDITIONING SYSTEM
- BRAKE WARNING LIGHT,
- FUEL WARNING LIGHT AND OIL
- PRESSURE WARNING LIGHT
- CENTRAL DOOR LOCKING SYSTEM
- DAYTIME RUNNING LIGHT (DRL)
- DOME LIGHT, LUGGAGE
- COMPARTMENT LIGHT AND
- IGNITION KEY HOLE
- ILLUMINATION LIGHT
- FOG LIGHT
- HEADLIGHT
- IGNITION KEY REMINDER TONE ALARM
- <VEHICLES WITH KOS>
- METER AND GAUGE
- SEAT BELT WARNING TONE ALARM
- TAILLIGHT, POSITION LIGHT,
- LICENSE PLATE LIGHT
- AND LIGHTING MONITOR
- TONE ALARM
- THEFT-ALARM SYSTEM
- TIRE PRESSURE MONITORING SYSTEM (TPMS)
- TRUNK LID OPENER
- TURN-SIGNAL LIGHT AND HAZARD WARNING LIGHT
- WINDSHIELD WIPER AND WASHER

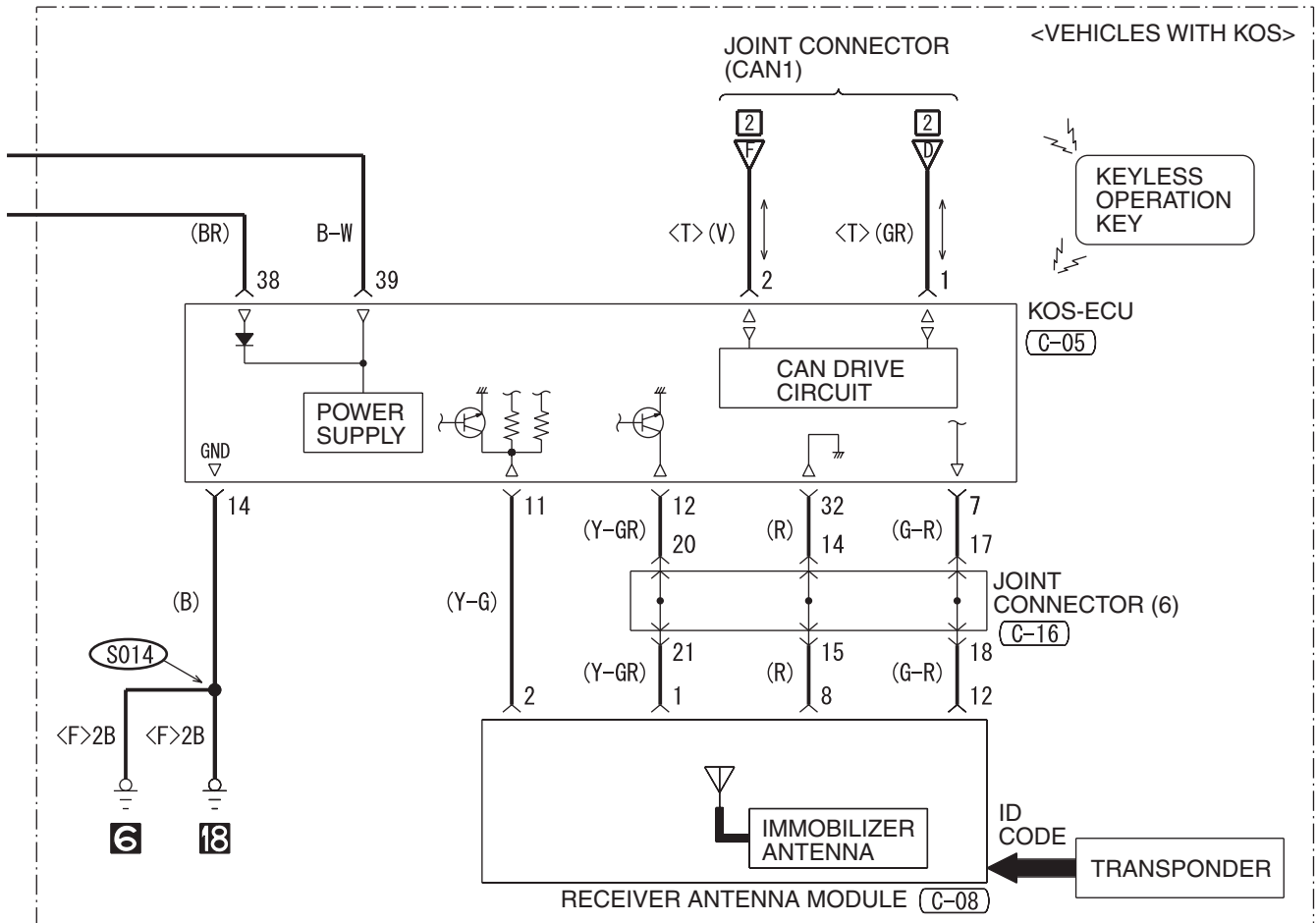

WIRE COLOR CODE

B: BLACK LG: LIGHT GREEN G: GREEN L: BLUE W: WHITE Y: YELLOW SB: SKY BLUE
BR: BROWN O: ORANGE GR: GRAY R: RED P: PINK V: VIOLET PU: PURPLE SI: SILVER

H8G15M44BB

SUNROOF

M1901009902231

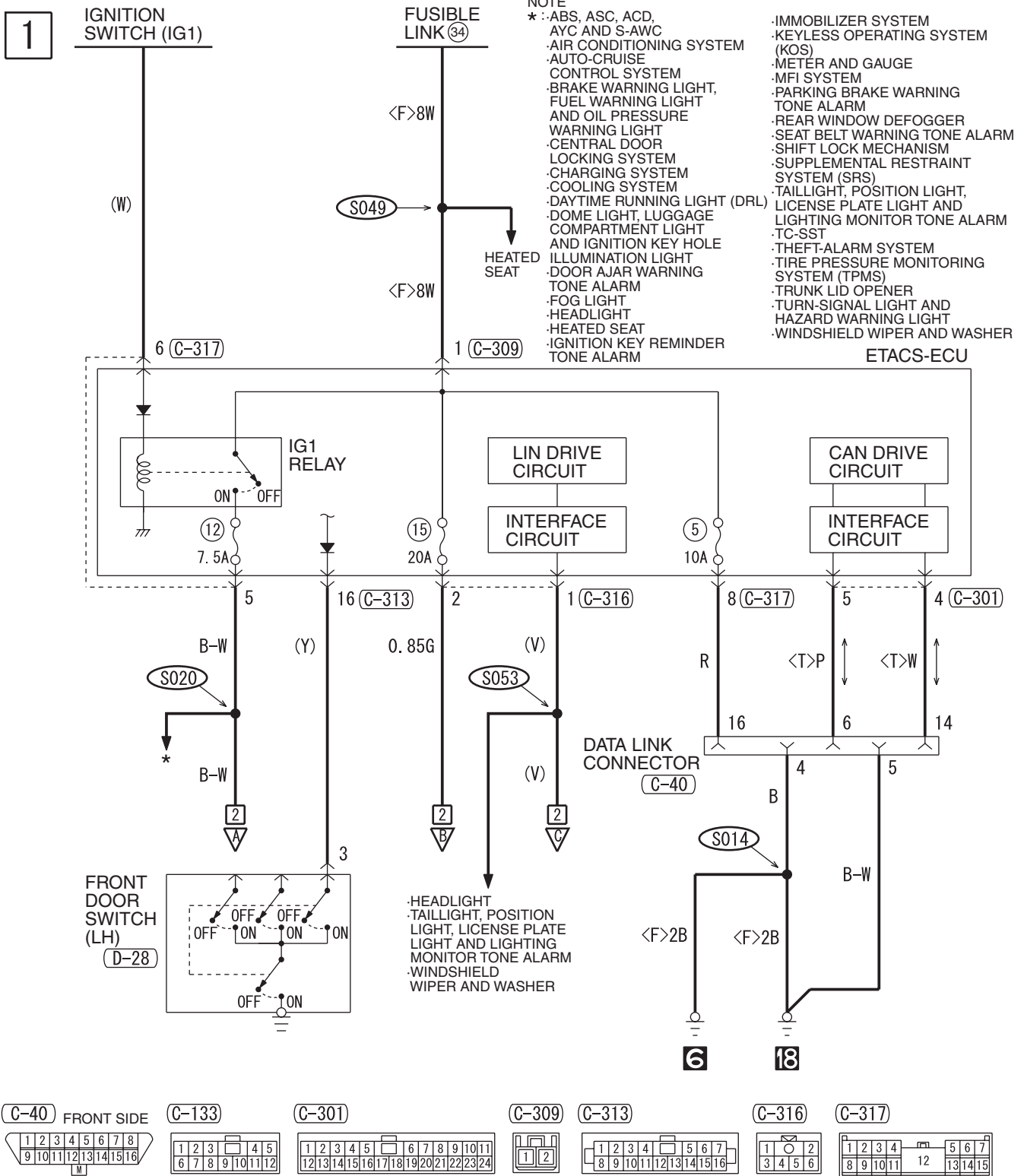

H8G15M45AA

2

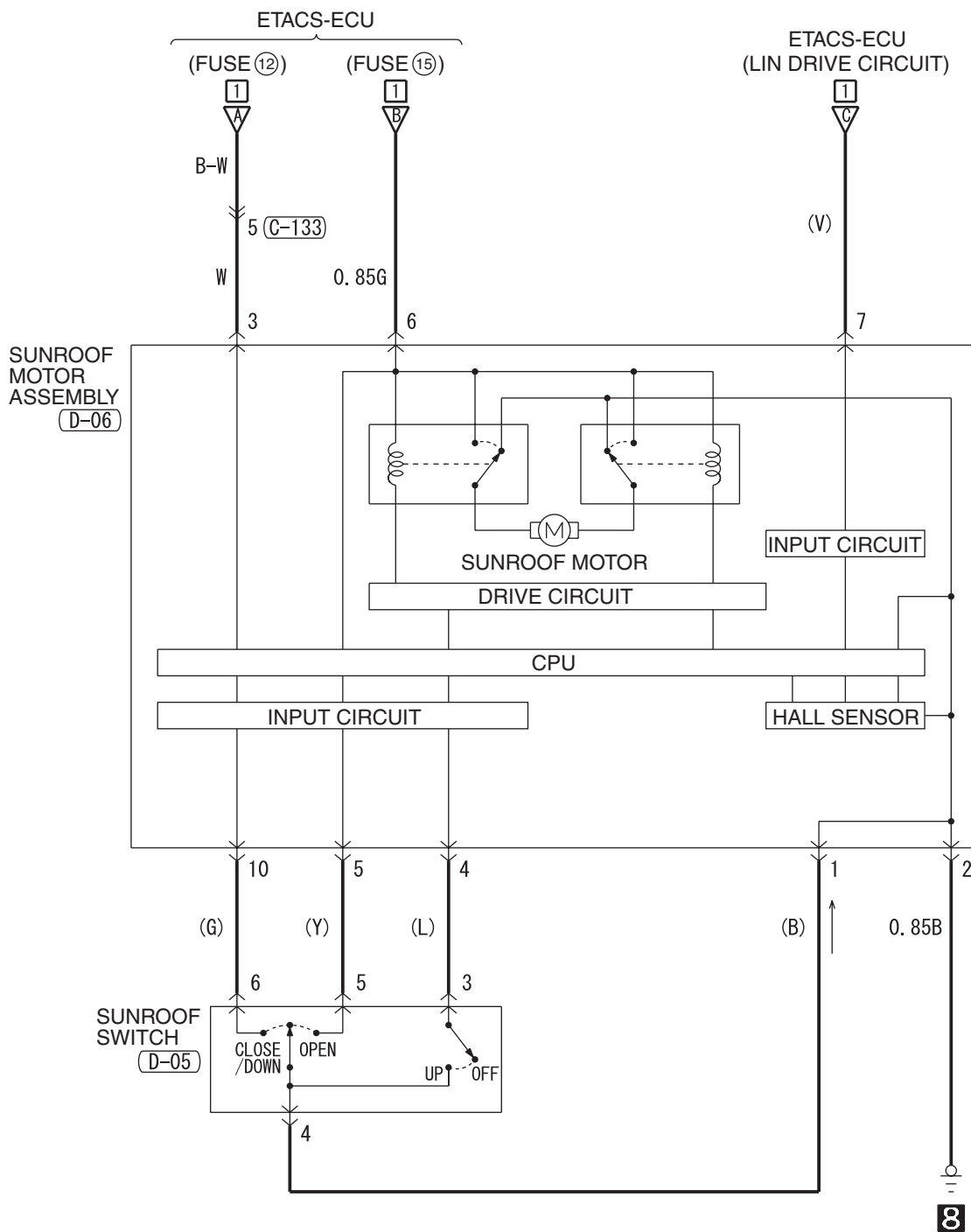

(D-05)

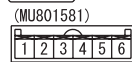

(D-06)



(D-28)



WIRE COLOR CODE

B: BLACK LG: LIGHT GREEN G: GREEN L: BLUE W: WHITE Y: YELLOW SB: SKY BLUE
BR: BROWN O: ORANGE GR: GRAY R: RED P: PINK V: VIOLET PU: PURPLE SI: SILVER

H8G15M45AB

HEATED SEAT

1

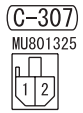
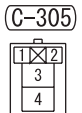
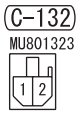
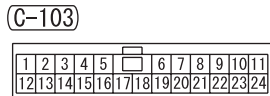
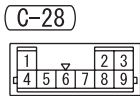
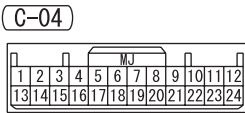
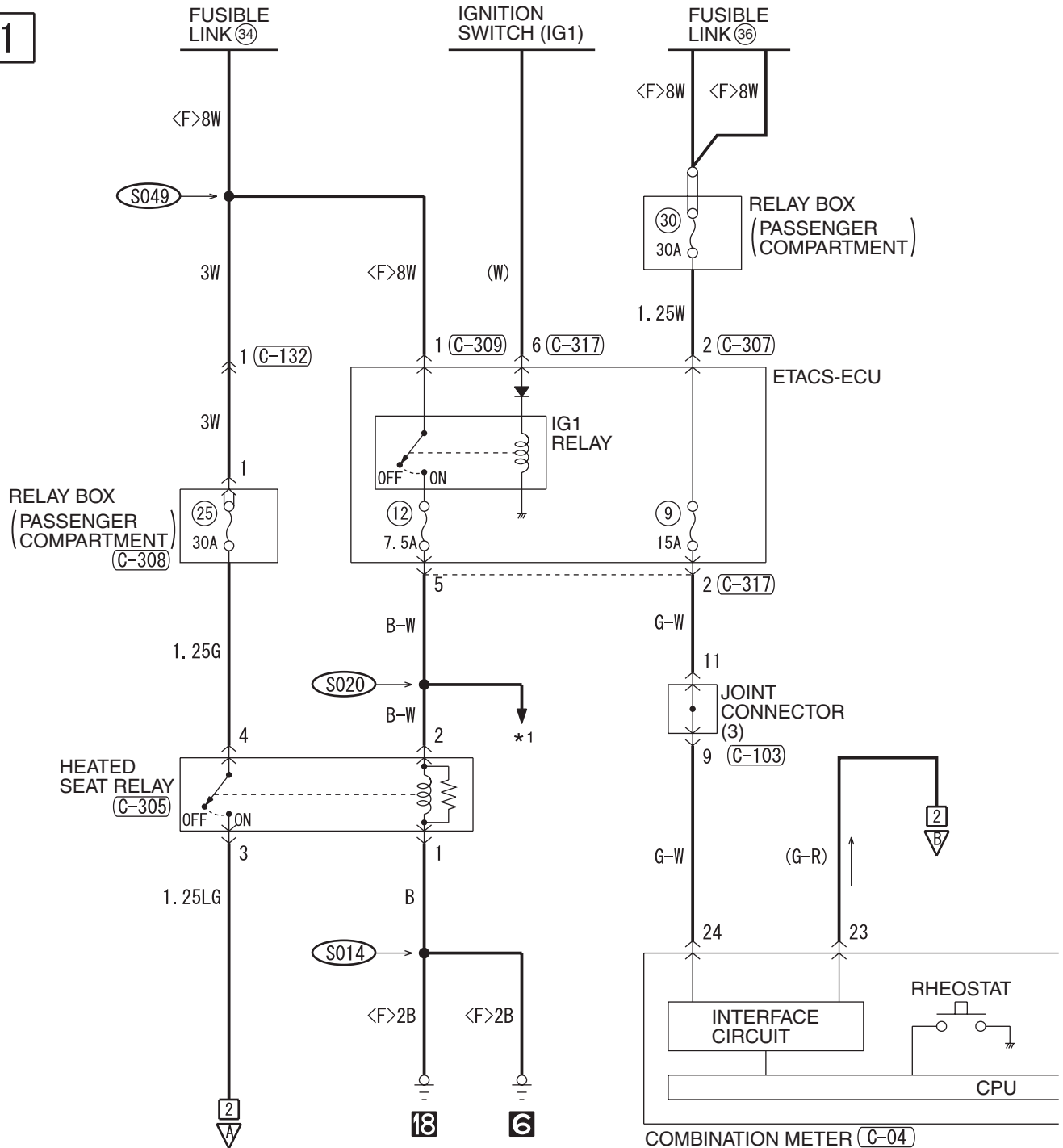

2

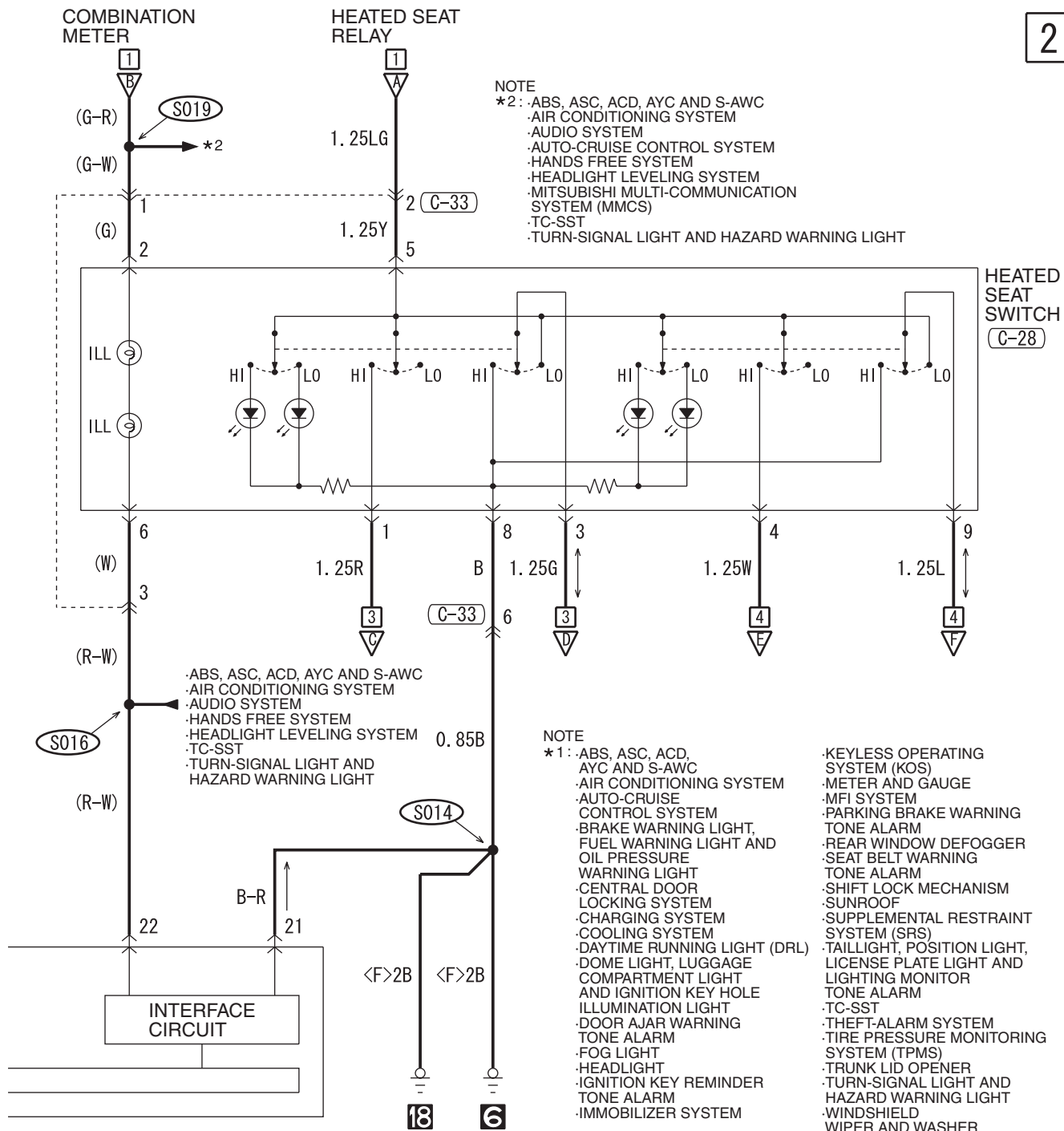

(C-317)

1	2	3	4	5	6	7	
8	9	10	11	12	13	14	15

WIRE COLOR CODE

B : BLACK LG : LIGHT GREEN G : GREEN L : BLUE W : WHITE Y : YELLOW SB : SKY BLUE
 BR : BROWN O : ORANGE GR : GRAY R : RED P : PINK V : VIOLET PU : PURPLE SI : SILVER

H8G15M46AB

HEATED SEAT (CONTINUED)

3

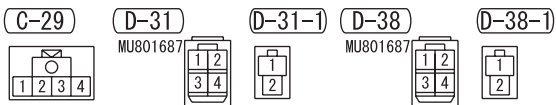
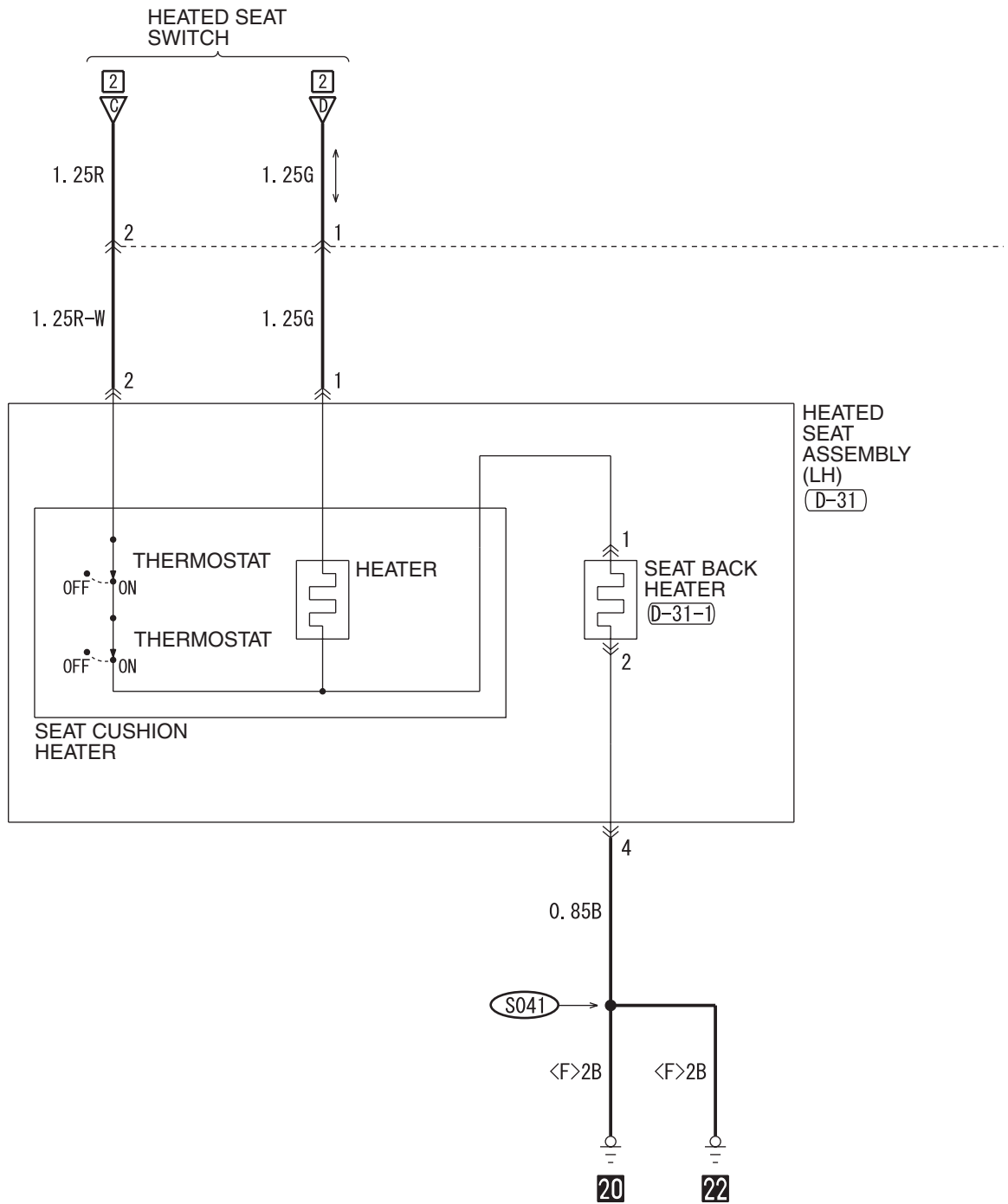

4

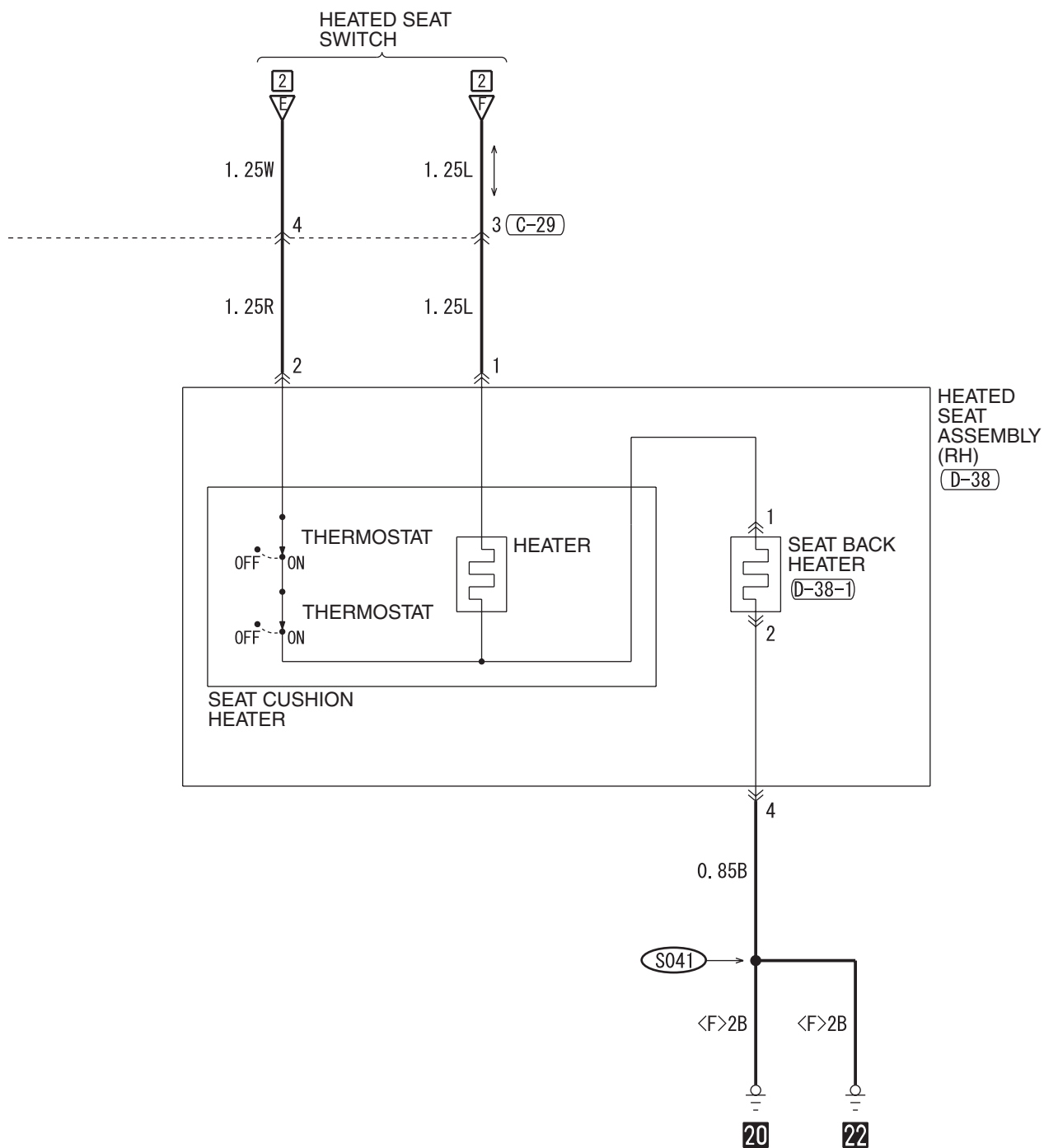

WIRE COLOR CODE

B : BLACK LG : LIGHT GREEN G : GREEN L : BLUE W : WHITE Y : YELLOW SB : SKY BLUE
BR : BROWN O : ORANGE GR : GRAY R : RED P : PINK V : VIOLET PU : PURPLE SI : SILVER

H8G15M46BB

TSB Revision

HANDS FREE SYSTEM

1

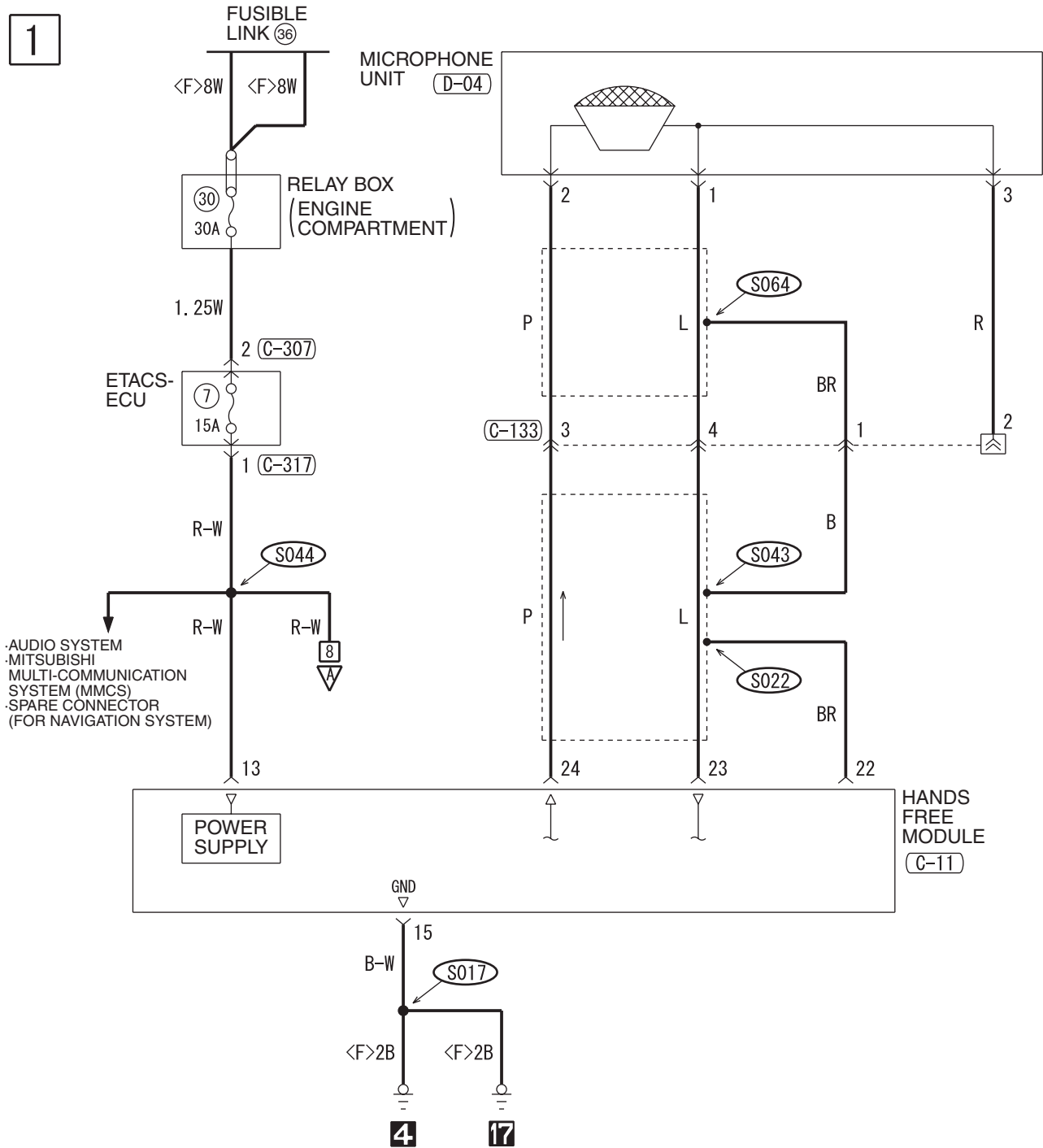

(A-05)

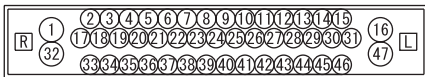

(C-11)

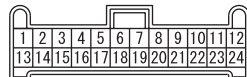

(C-104)

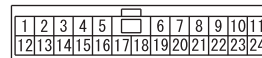

(C-127)

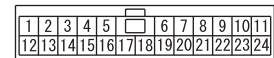

2

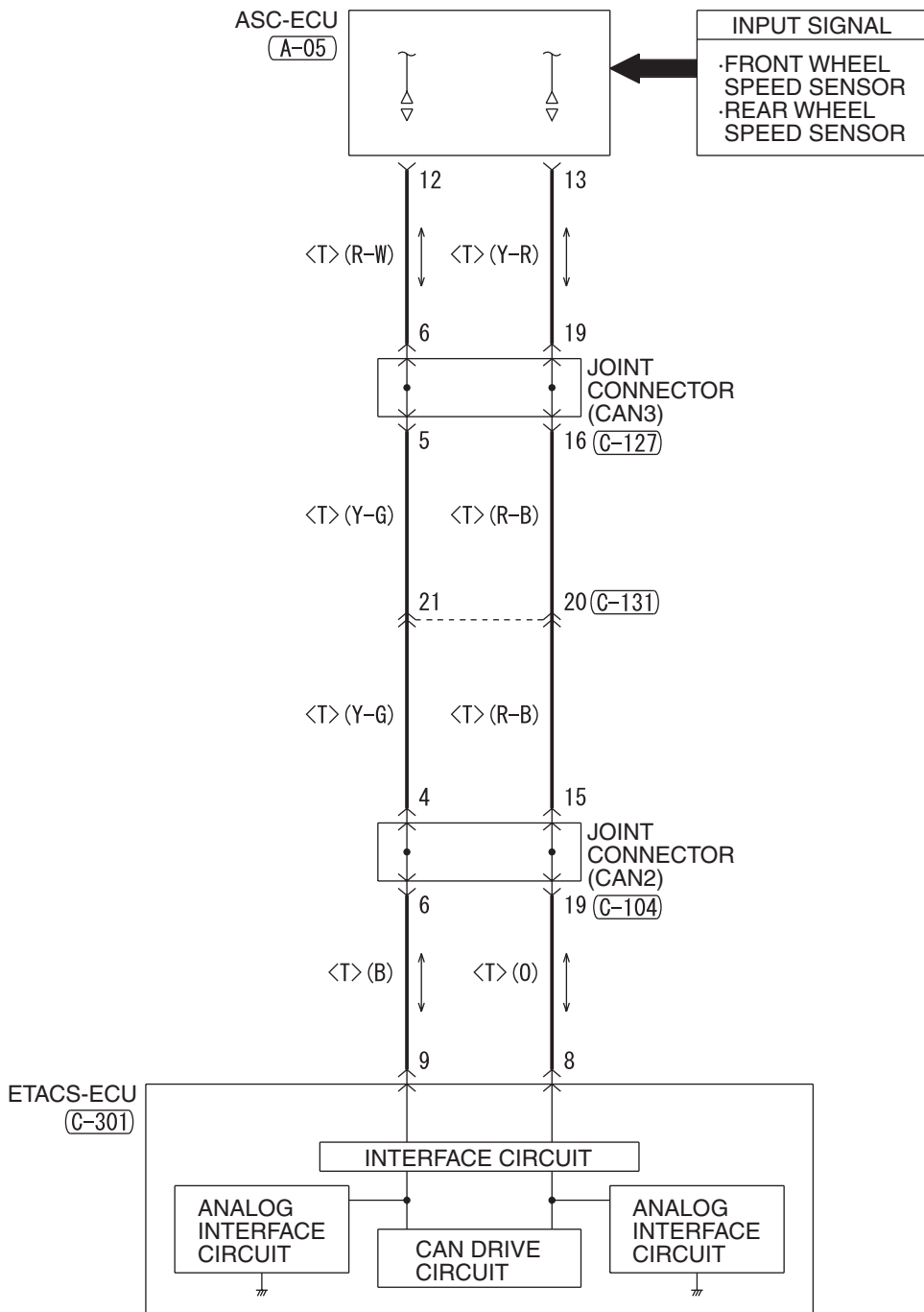

(C-131)

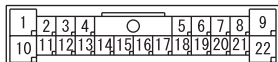

(C-133)

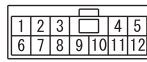

(C-301)

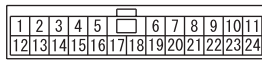

(C-307)



(C-317)



(D-04)



WIRE COLOR CODE

B : BLACK LG : LIGHT GREEN G : GREEN L : BLUE W : WHITE Y : YELLOW SB : SKY BLUE
BR : BROWN O : ORANGE GR : GRAY R : RED P : PINK V : VIOLET PU : PURPLE SI : SILVER

HANDS FREE SYSTEM (CONTINUED)

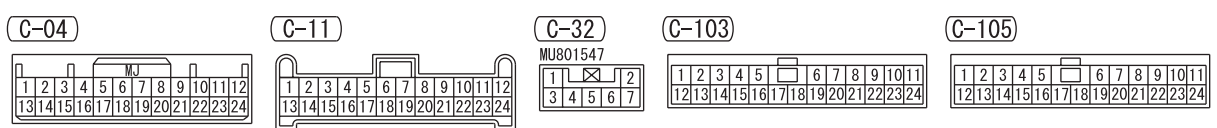
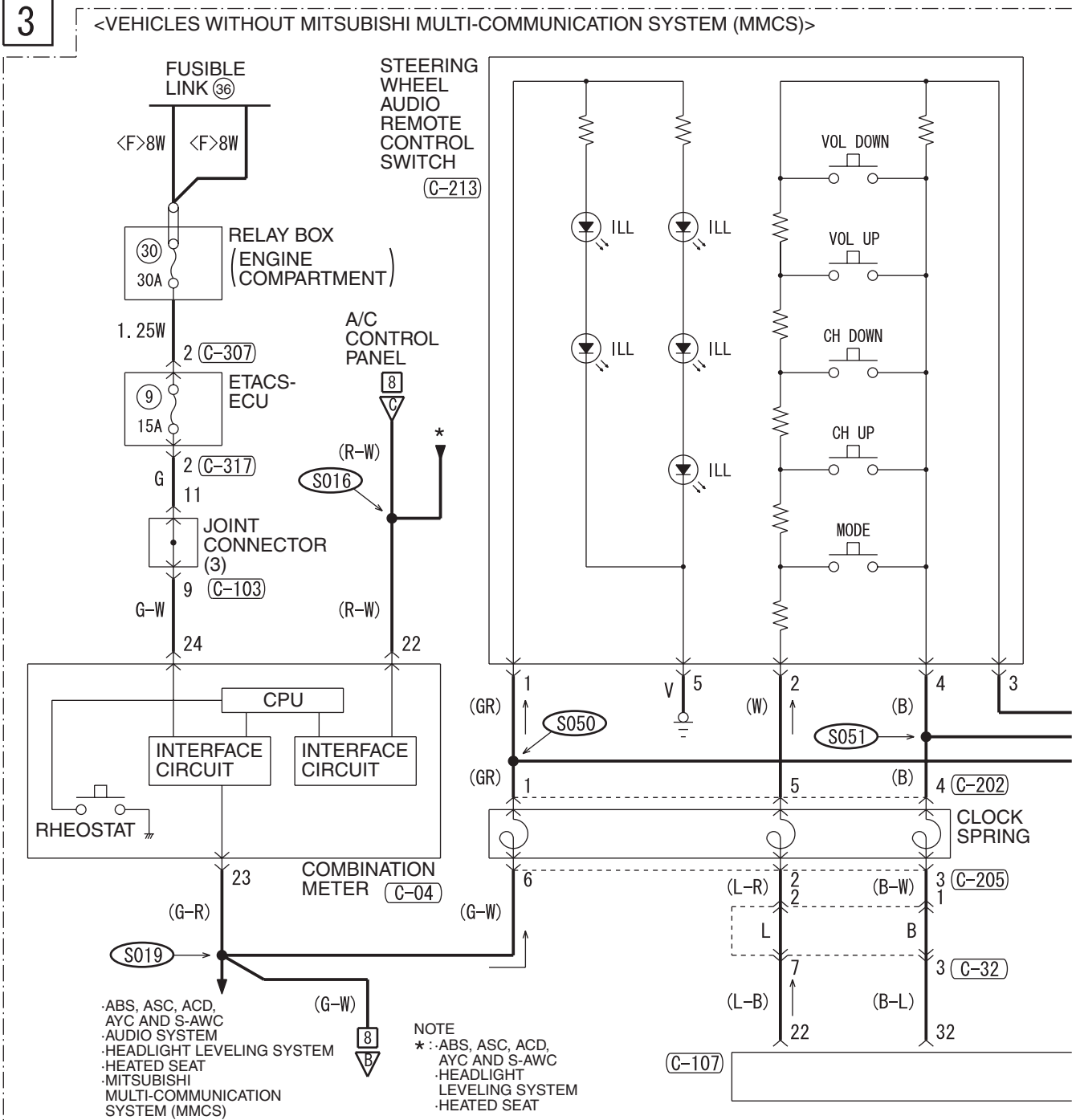

4

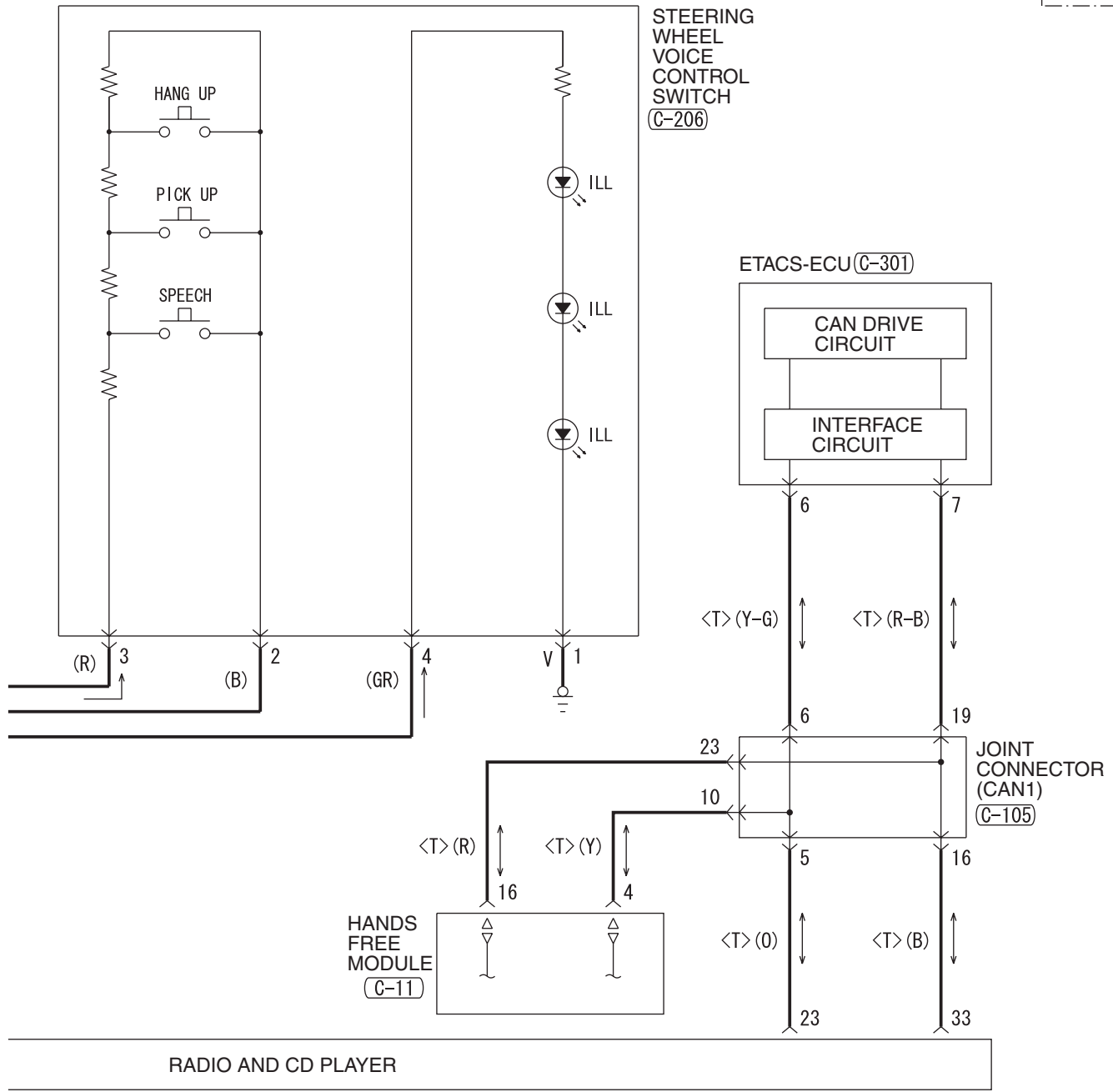

(C-107)



(C-202)

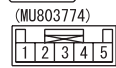

(C-205)

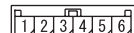

(C-206)



(C-213)

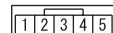

(C-301)

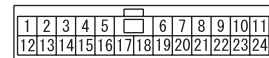

(C-307)



(C-317)

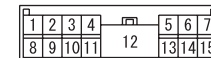

WIRE COLOR CODE

B : BLACK LG : LIGHT GREEN G : GREEN L : BLUE W : WHITE Y : YELLOW SB : SKY BLUE
BR : BROWN O : ORANGE GR : GRAY R : RED P : PINK V : VIOLET PU : PURPLE SI : SILVER

H8G15M47BB

HANDS FREE SYSTEM (CONTINUED)

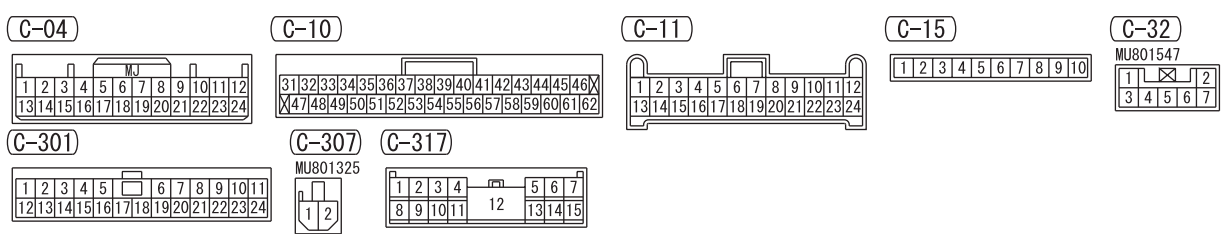
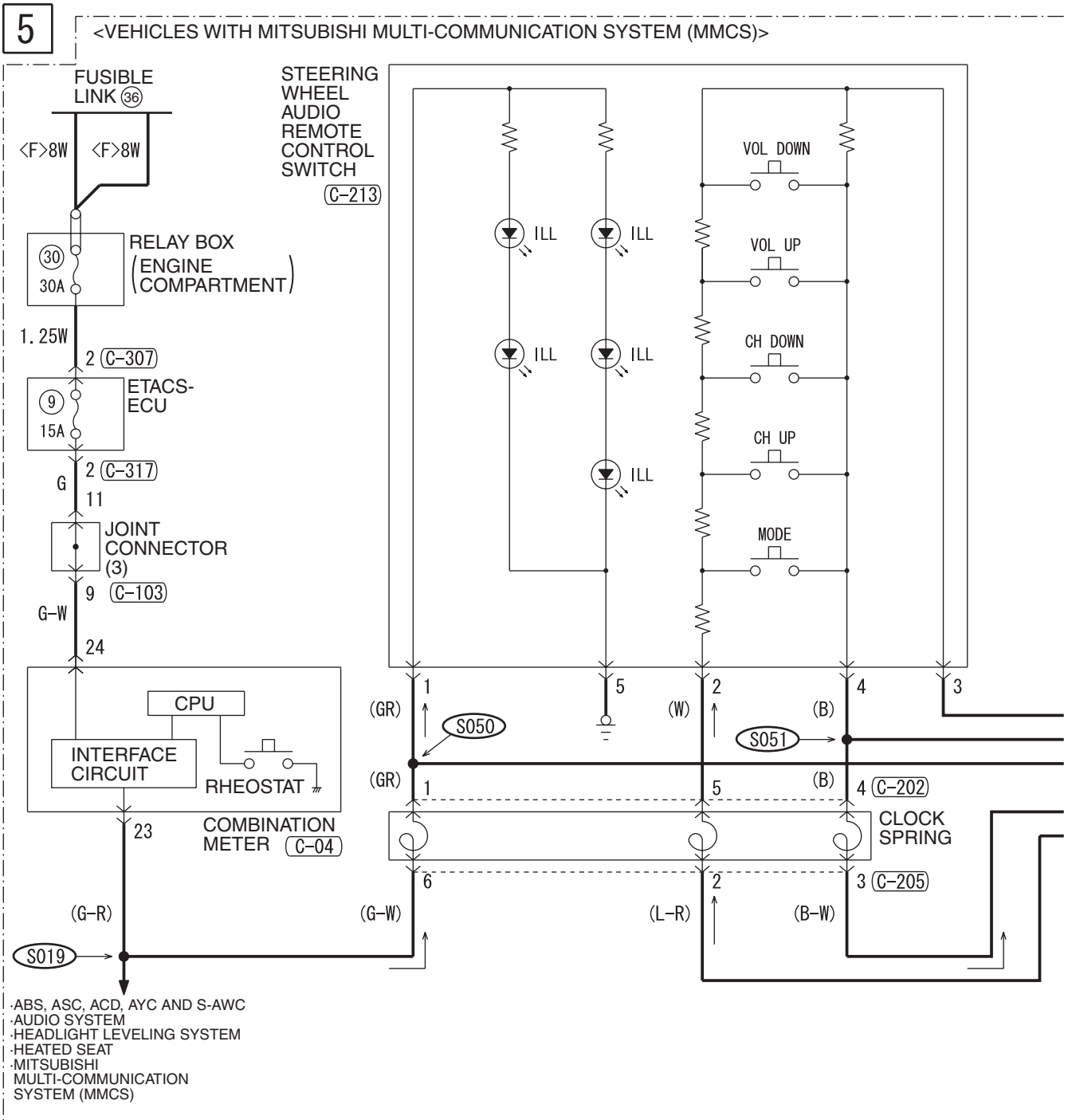

6

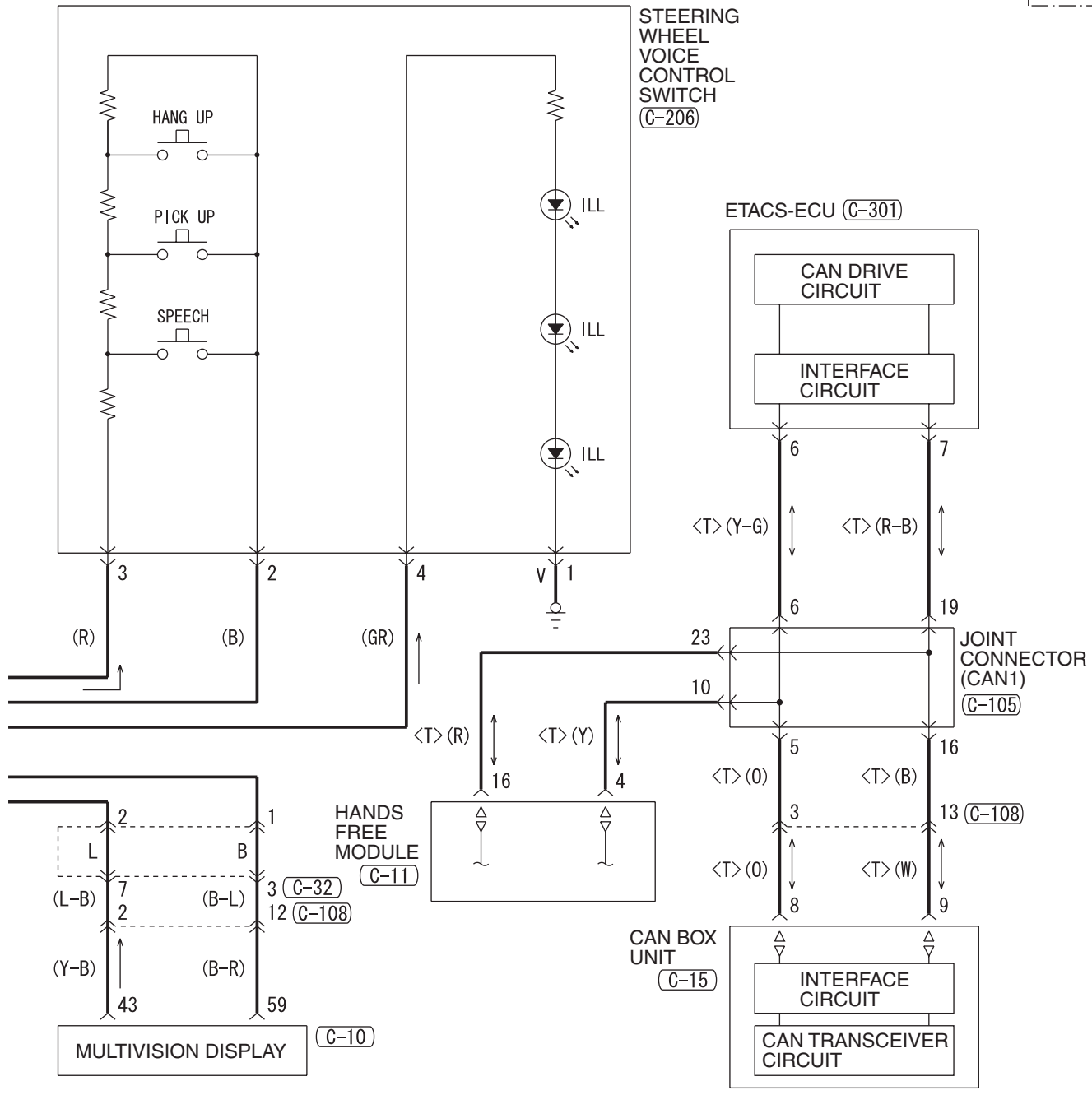

(C-103)

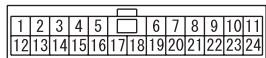

(C-105)

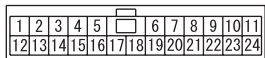

(C-108)

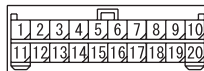

(C-202)

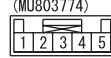

(C-205)

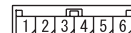

(C-206)



(C-213)

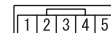

WIRE COLOR CODE

B : BLACK LG : LIGHT GREEN G : GREEN L : BLUE W : WHITE Y : YELLOW SB : SKY BLUE
BR : BROWN O : ORANGE GR : GRAY R : RED P : PINK V : VIOLET PU : PURPLE SI : SILVER

H8G15M47CB

HANDS FREE SYSTEM (CONTINUED)

7

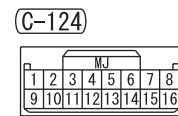
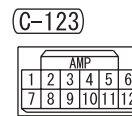
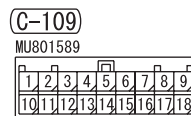
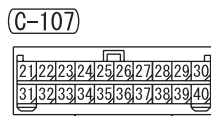
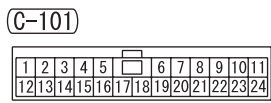
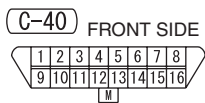
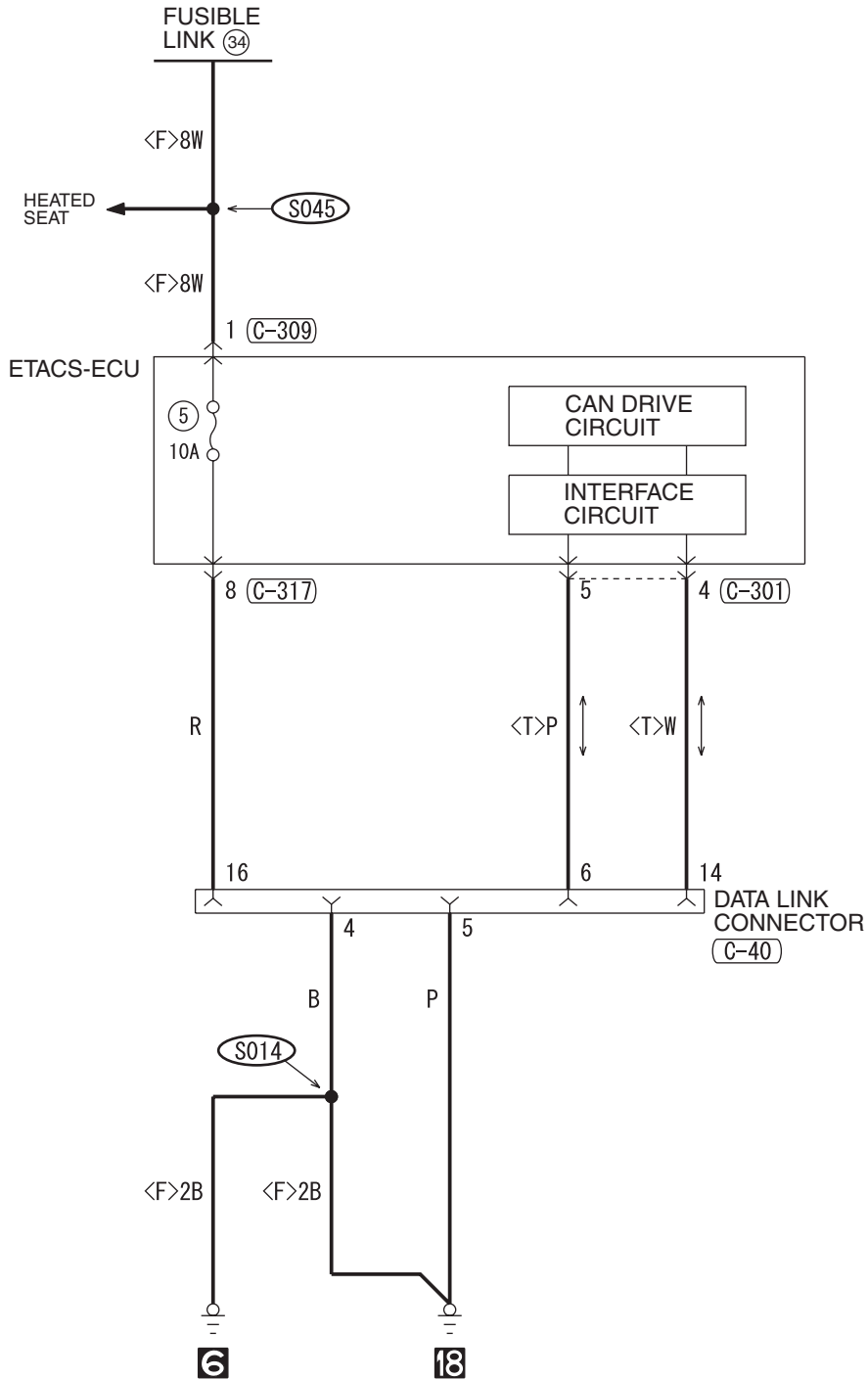

8

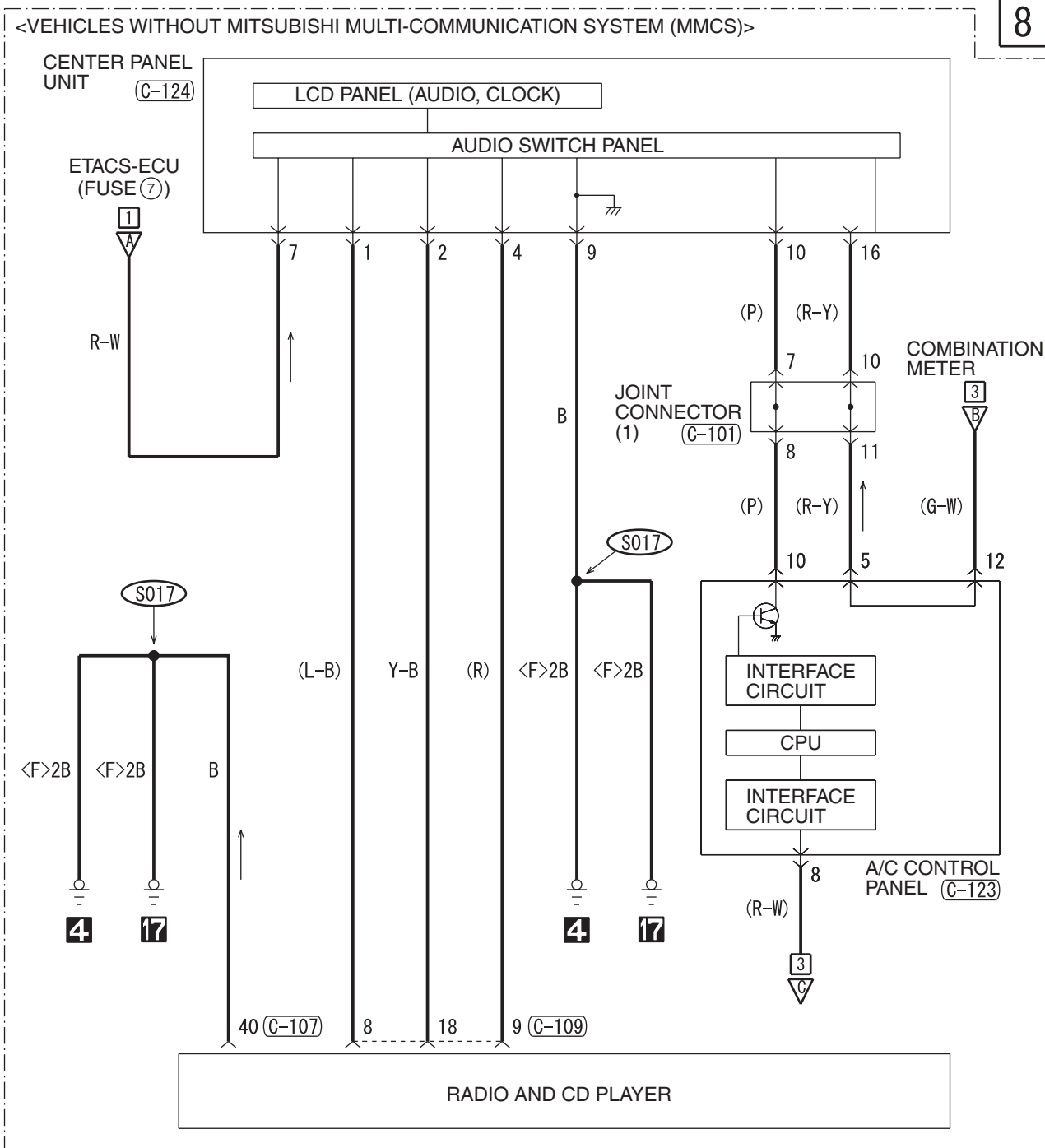

(C-301)

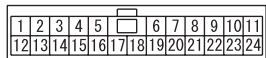

(C-309)



(C-317)

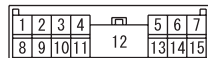

WIRE COLOR CODE

B: BLACK LG: LIGHT GREEN G: GREEN L: BLUE W: WHITE Y: YELLOW SB: SKY BLUE
BR: BROWN O: ORANGE GR: GRAY R: RED P: PINK V: VIOLET PU: PURPLE SI: SILVER

H8G15M47DB

HANDS FREE SYSTEM (CONTINUED)

9

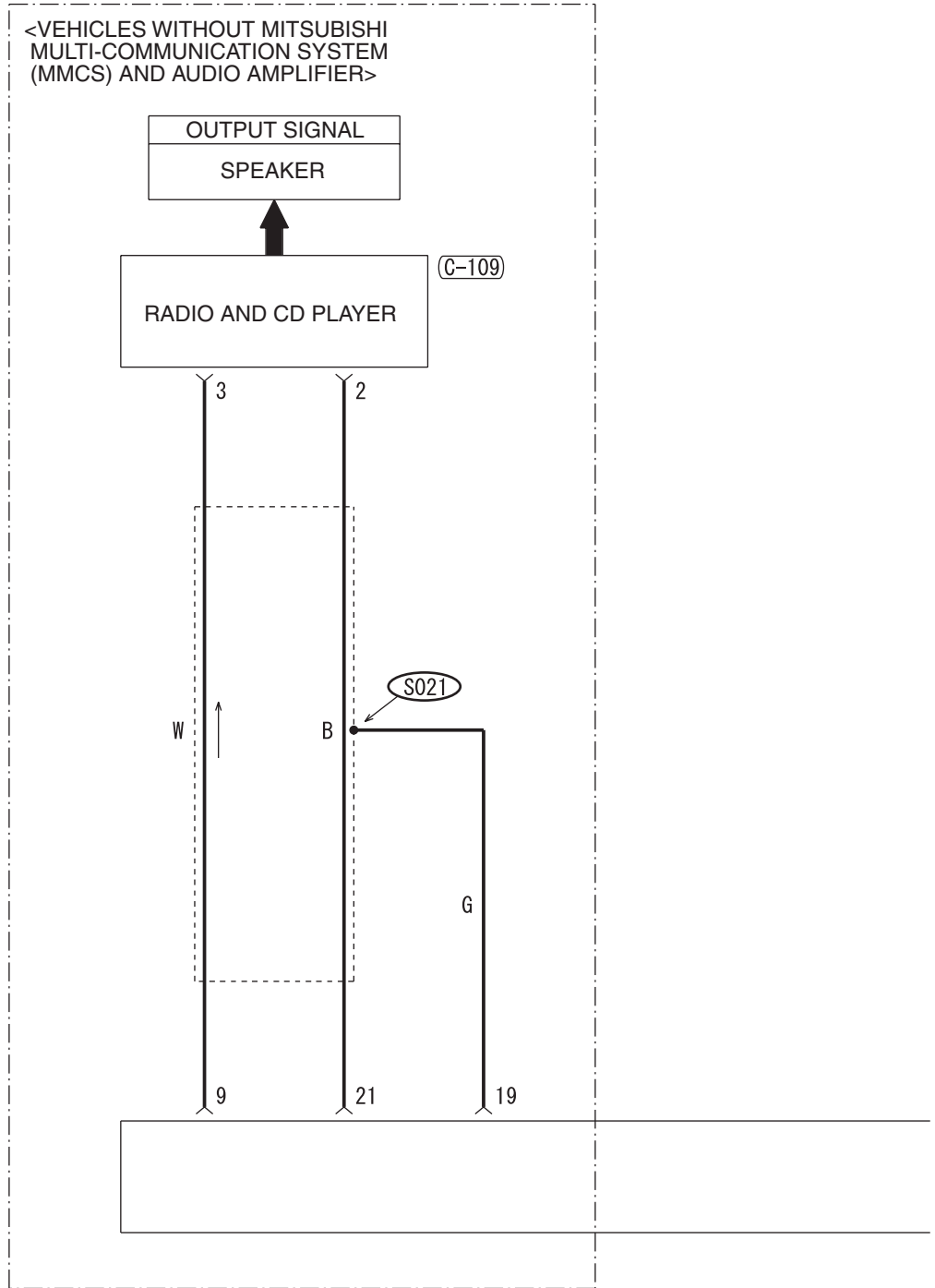

(C-11)

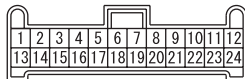

(C-24)

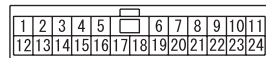

(C-107)

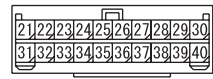

(C-109)

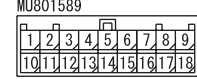

(D-29)

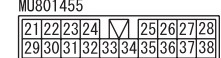

10

<VEHICLES WITHOUT MITSUBISHI MULTI-COMMUNICATION SYSTEM (MMCS) WITH AUDIO AMPLIFIER>

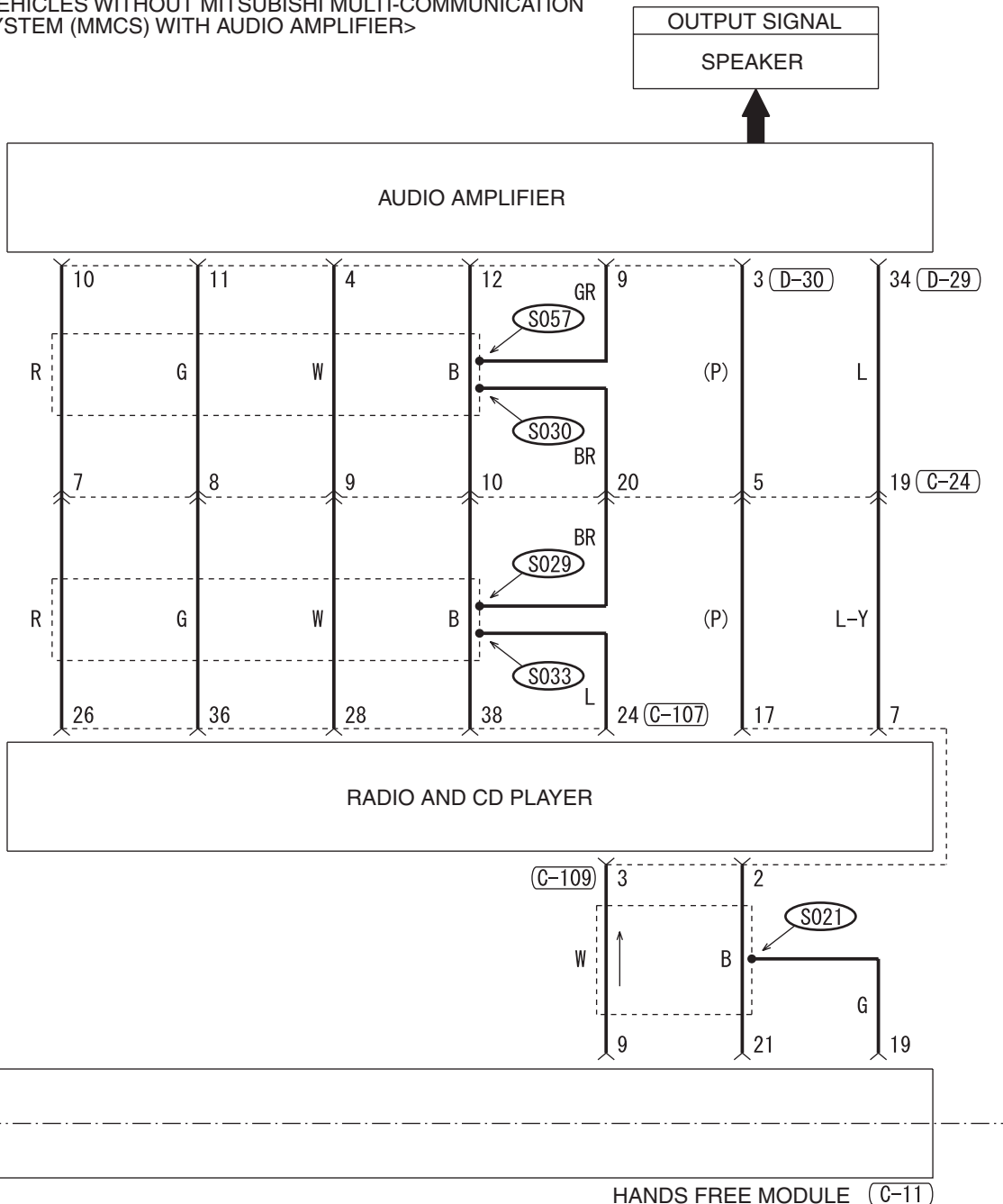

(D-30)

MU801453

1	2	3	4	5	6
7	8	9	10	11	12
13	14				

WIRE COLOR CODE

B: BLACK LG: LIGHT GREEN G: GREEN L: BLUE W: WHITE Y: YELLOW SB: SKY BLUE
BR: BROWN O: ORANGE GR: GRAY R: RED P: PINK V: VIOLET PU: PURPLE SI: SILVER

H8G15M47EB

HANDS FREE SYSTEM (CONTINUED)

11

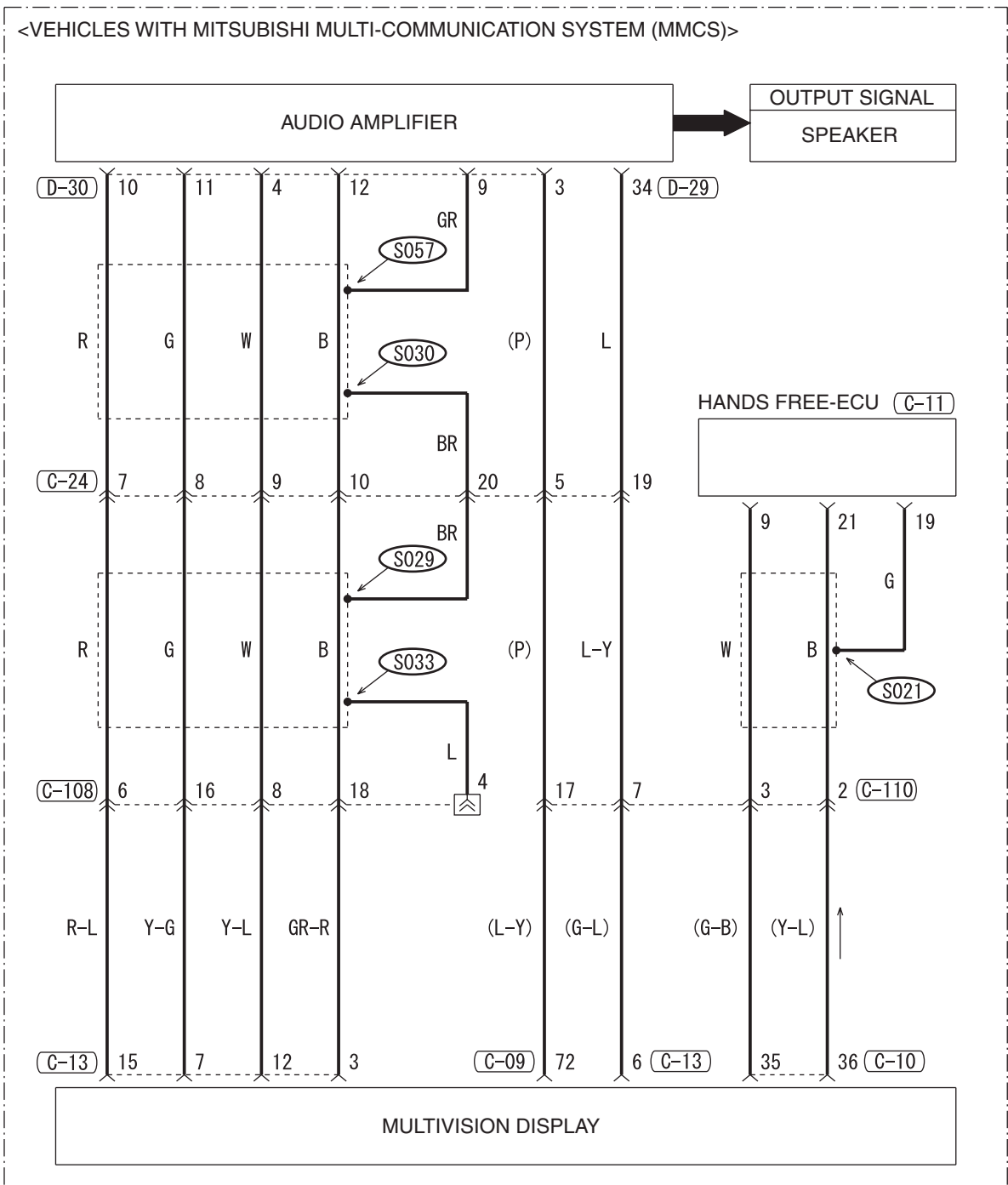

(C-09)

71	72	73	74	75	76	77
----	----	----	----	----	----	----

(C-10)

31	32	33	34	35	36	37	38	39	40	41	42	43	44	45	46	X
X	47	48	49	50	51	52	53	54	55	56	57	58	59	60	61	62

(C-11)

1	2	3	4	5	6	7	8	9	10	11	12
13	14	15	16	17	18	19	20	21	22	23	24

(C-13)

1	2	3	X	4	5	6	X	7	8	9	
X	10	11	12	X	13	14	X	15	16	17	X

(C-24)

1	2	3	4	5	6	7	8	9	10	11		
12	13	14	15	16	17	18	19	20	21	22	23	24

(C-108)

1	2	3	4	5	6	7	8	9	10
11	12	13	14	15	16	17	18	19	20

(C-110)

1	2	3	4	5	6	7	8	9
10	11	12	13	14	15	16	17	18

(D-29)

21	22	23	24	M	25	26	27	28	
29	30	31	32	33	34	35	36	37	38

(D-30)

1	2	3	M	4	5	6	
7	8	9	10	11	12	13	14

NOTES

IGNITION KEY REMINDER TONE ALARM <VEHICLES WITHOUT KOS>

M1901011301642

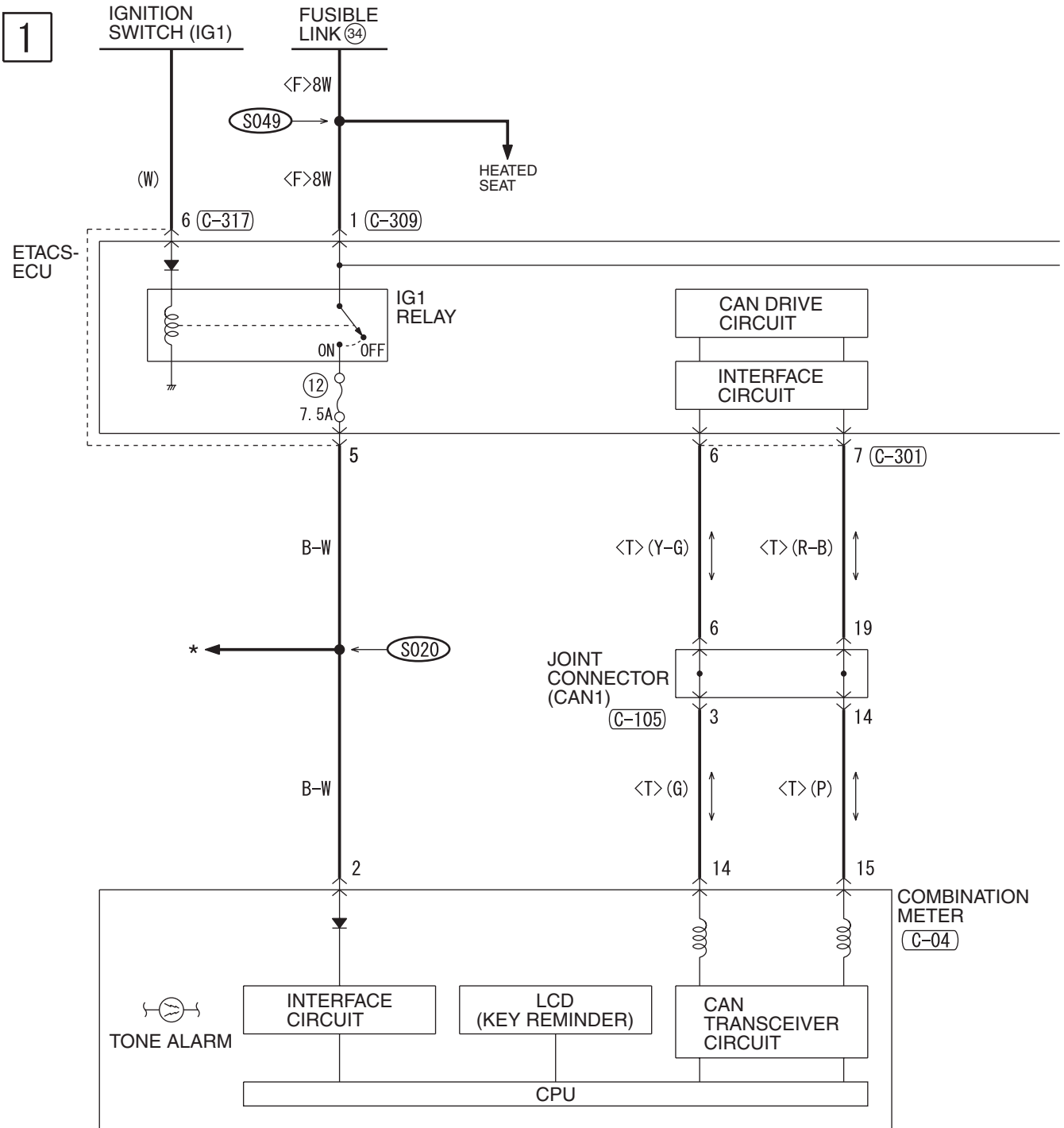

(C-04)

(C-40) FRONT SIDE

(C-105)

(C-211)

(C-301)

(C-309)

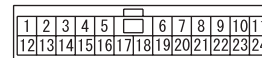
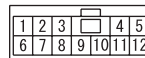
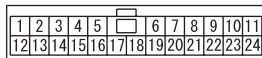
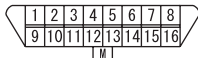
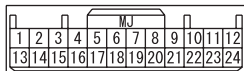

NOTE

- * : -ABS, ASC, ACD, AYC AND S-AWC
- AIR CONDITIONING SYSTEM
- CENTRAL DOOR LOCKING SYSTEM
- CHARGING SYSTEM
- COOLING SYSTEM
- DAYTIME RUNNING LIGHT (DRL)
- DOME LIGHT, LUGGAGE COMPARTMENT LIGHT AND IGNITION KEY HOLE ILLUMINATION LIGHT
- FOG LIGHT
- HEADLIGHT
- HEATED SEAT
- IGNITION KEY REMINDER TONE ALARM
- IMMOBILIZER SYSTEM
- REAR WINDOW DEFOGGER
- SEAT BELT WARNING TONE ALARM
- SHIFT LOCK MECHANISM
- SUNROOF
- SUPPLEMENTAL RESTRAINT SYSTEM (SRS)
- TAILLIGHT, POSITION LIGHT, LICENSE PLATE LIGHT AND LIGHTING MONITOR TONE ALARM
- TC-SST
- THEFT-ALARM SYSTEM
- TIRE PRESSURE MONITORING SYSTEM (TPMS)
- TRUNK LID OPENER
- TURN-SIGNAL LIGHT AND HAZARD WARNING LIGHT
- WINDSHIELD WIPER AND WASHER

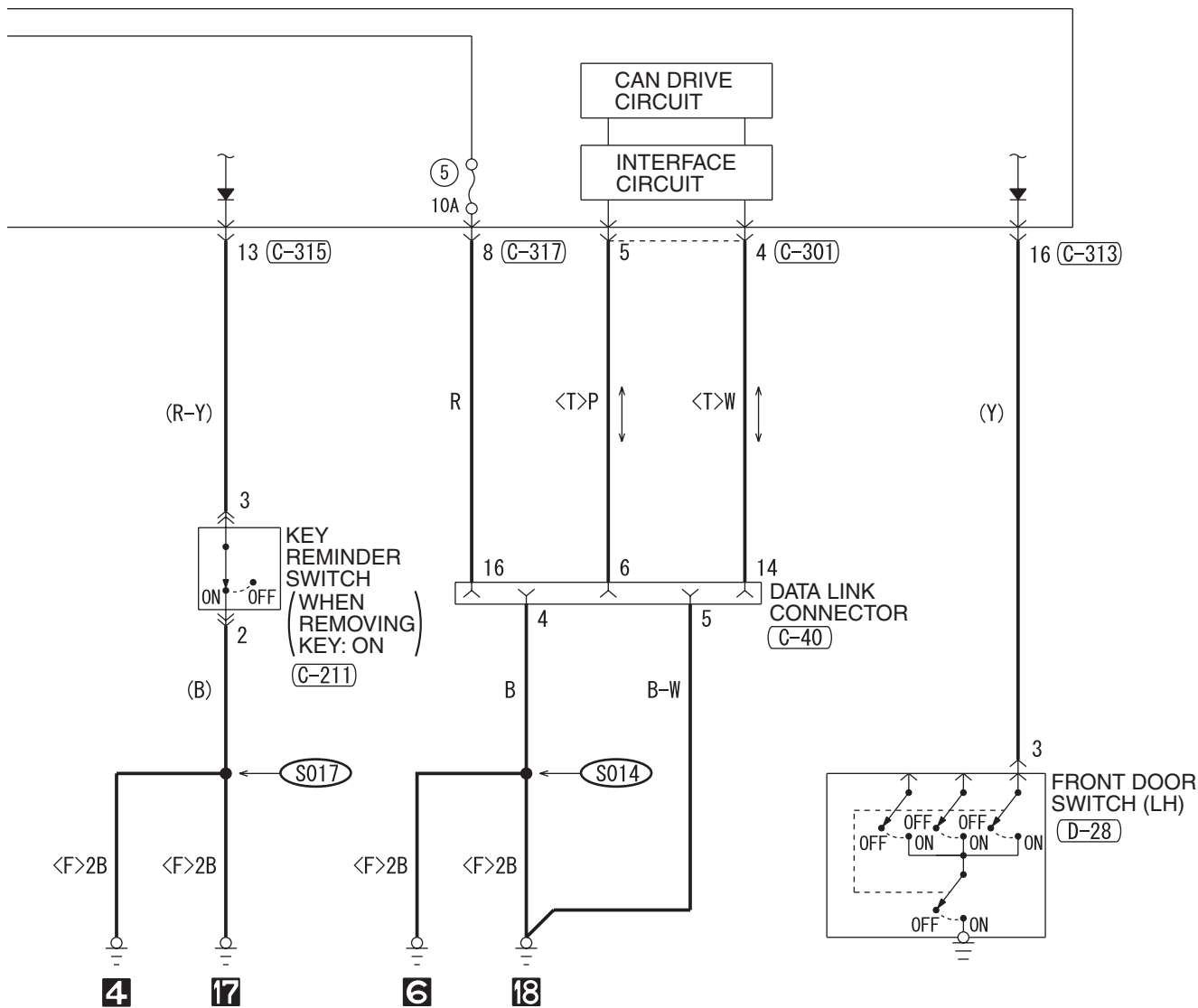

(C-313)

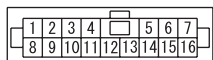

(C-315)



(C-317)

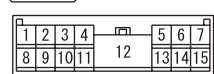

(D-28)



WIRE COLOR CODE

B : BLACK LG : LIGHT GREEN G : GREEN L : BLUE W : WHITE Y : YELLOW SB : SKY BLUE
 BR : BROWN O : ORANGE GR : GRAY R : RED P : PINK V : VIOLET PU : PURPLE SI : SILVER

IGNITION KEY REMINDER TONE ALARM <VEHICLES WITH KOS>

M1901011301653

1

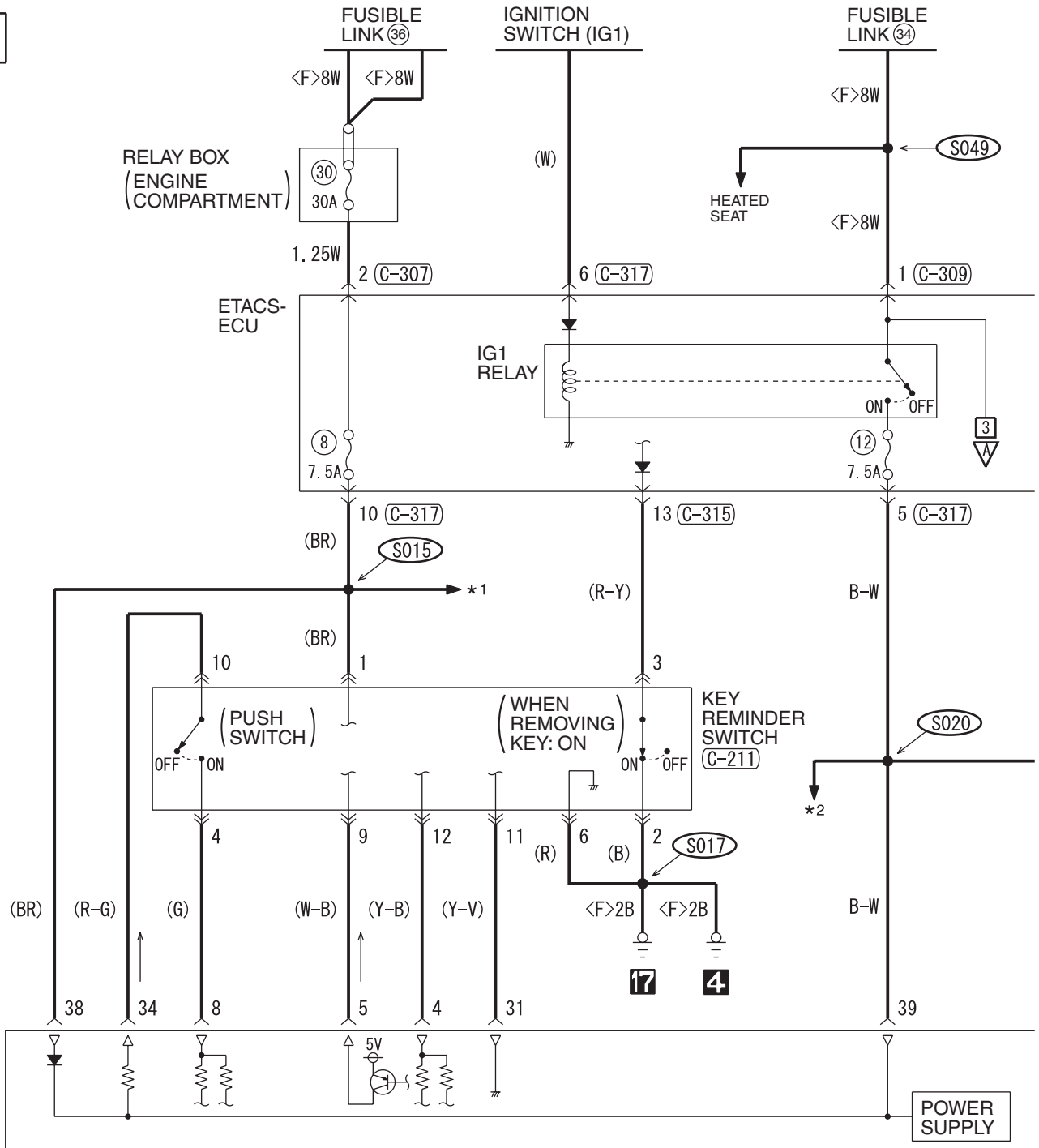

C-04

1	2	3	4	5	6	7	8	9	10	11	12
13	14	15	16	17	18	19	20	21	22	23	24

C-05

1	2	3	4	5	6	7	8	9	10	11	12	13	14	15	16	17	18	19	20
21	22	23	24	25	26	27	28	29	30	31	32	33	34	35	36	37	38	39	40

C-105

1	2	3	4	5	6	7	8	9	10	11		
12	13	14	15	16	17	18	19	20	21	22	23	24

C-211

1	2	3	4	5		
6	7	8	9	10	11	12

NOTE

- *1 :** ·AIR CONDITIONING SYSTEM
 ·DAYTIME RUNNING LIGHT (DRL)
 ·DOME LIGHT, LUGGAGE COMPARTMENT LIGHT AND IGNITION KEY HOLE ILLUMINATION LIGHT
 ·FOG LIGHT
 ·HEADLIGHT
 ·IMMOBILIZER SYSTEM
 ·TAILLIGHT, POSITION LIGHT, LICENSE PLATE LIGHT AND LIGHTING MONITOR TONE ALARM
 ·THEFT-ALARM SYSTEM
 ·TIRE PRESSURE MONITORING SYSTEM (TPMS)
 ·TRUNK LID OPENER
 ·TURN-SIGNAL LIGHT AND HAZARD WARNING LIGHT
 ·WINDSHIELD WIPER AND WASHER

- *2 :** ·ABS, ASC, ACD, AYC AND S-AWC
 ·AIR CONDITIONING SYSTEM
 ·CENTRAL DOOR LOCKING SYSTEM
 ·CHARGING SYSTEM
 ·COOLING SYSTEM
 ·DAYTIME RUNNING LIGHT (DRL)
 ·DOME LIGHT, LUGGAGE COMPARTMENT LIGHT AND IGNITION KEY HOLE ILLUMINATION LIGHT
 ·FOG LIGHT
 ·HEADLIGHT
 ·HEATED SEAT
 ·IGNITION KEY REMINDER TONE ALARM
 ·IMMOBILIZER SYSTEM
 ·REAR WINDOW DEFOGGER
 ·SEAT BELT WARNING TONE ALARM
 ·SHIFT LOCK MECHANISM
 ·SUNROOF
 ·SUPPLEMENTAL RESTRAINT SYSTEM (SRS)
 ·TAILLIGHT, POSITION LIGHT, LICENSE PLATE LIGHT AND LIGHTING MONITOR TONE ALARM
 ·TC-SST
 ·THEFT-ALARM SYSTEM
 ·TIRE PRESSURE MONITORING SYSTEM (TPMS)
 ·TRUNK LID OPENER
 ·TURN-SIGNAL LIGHT AND HAZARD WARNING LIGHT
 ·WINDSHIELD WIPER AND WASHER

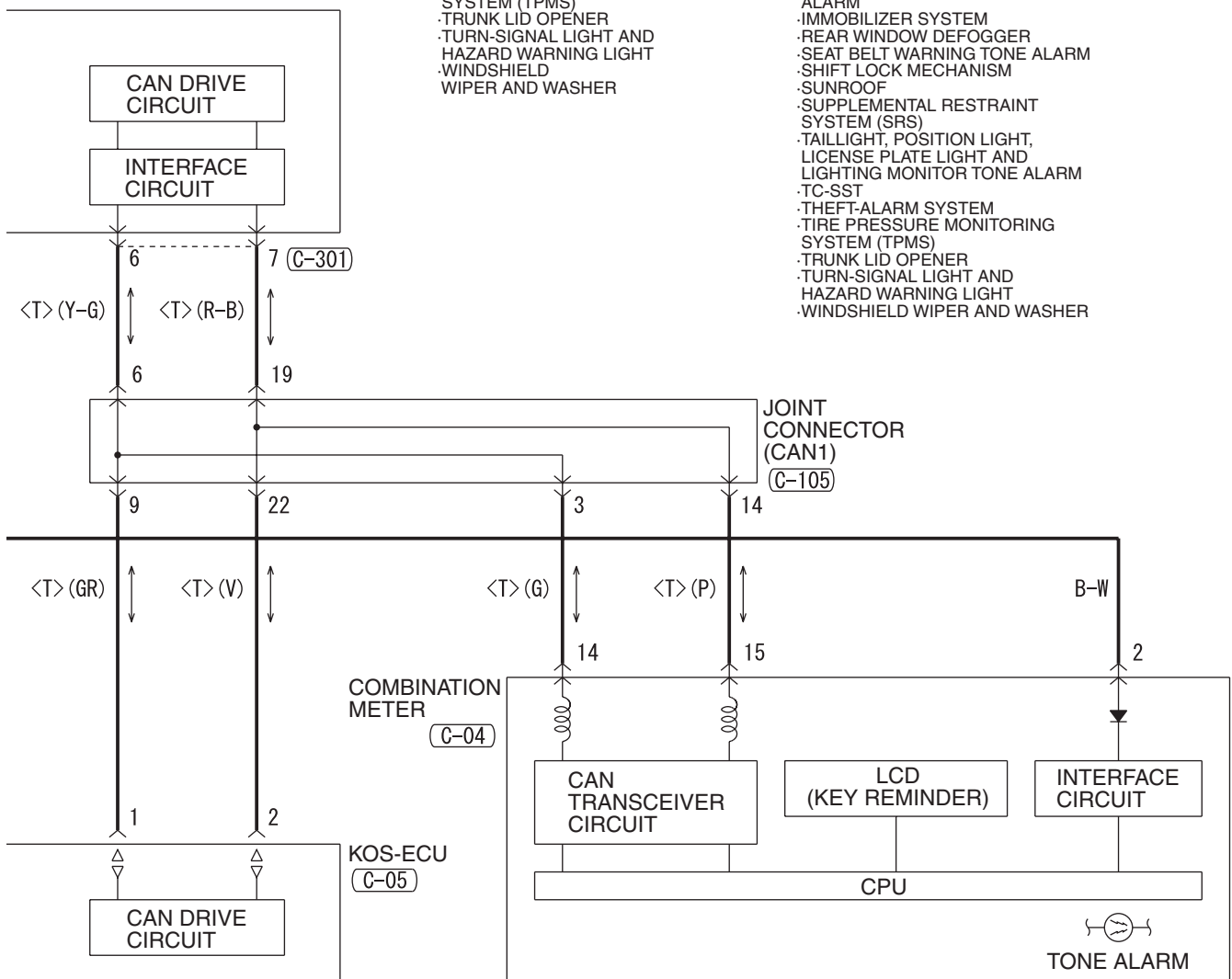

(C-301)

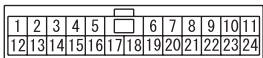

(C-307)



(C-309)



(C-315)

MJ801890

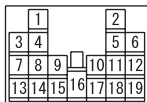

(C-317)



WIRE COLOR CODE

B : BLACK LG : LIGHT GREEN G : GREEN L : BLUE W : WHITE Y : YELLOW SB : SKY BLUE
 BR : BROWN O : ORANGE GR : GRAY R : RED P : PINK V : VIOLET PU : PURPLE SI : SILVER

IGNITION KEY REMINDER TONE ALARM <VEHICLES WITH KOS> (CONTINUED)

3

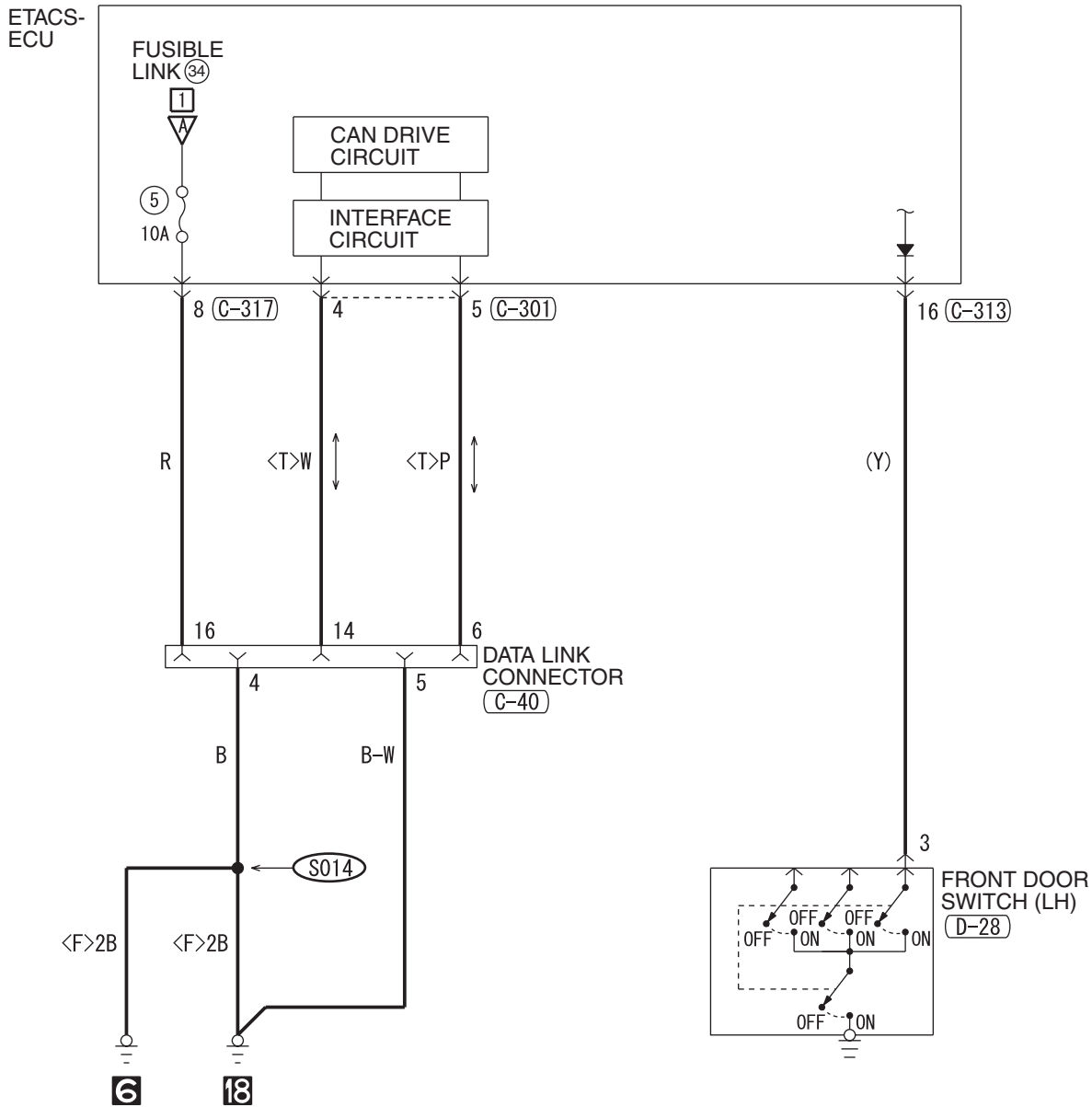

(C-40) FRONT SIDE

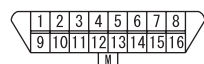

(C-301)

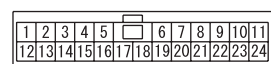

(C-313)

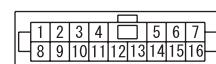

(C-317)

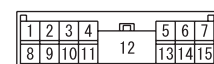

(D-28)



WIRE COLOR CODE

B : BLACK LG : LIGHT GREEN G : GREEN L : BLUE W : WHITE Y : YELLOW SB : SKY BLUE
BR : BROWN O : ORANGE GR : GRAY R : RED P : PINK V : VIOLET PU : PURPLE SI : SILVER

NOTES

SEAT BELT WARNING TONE ALARM

1

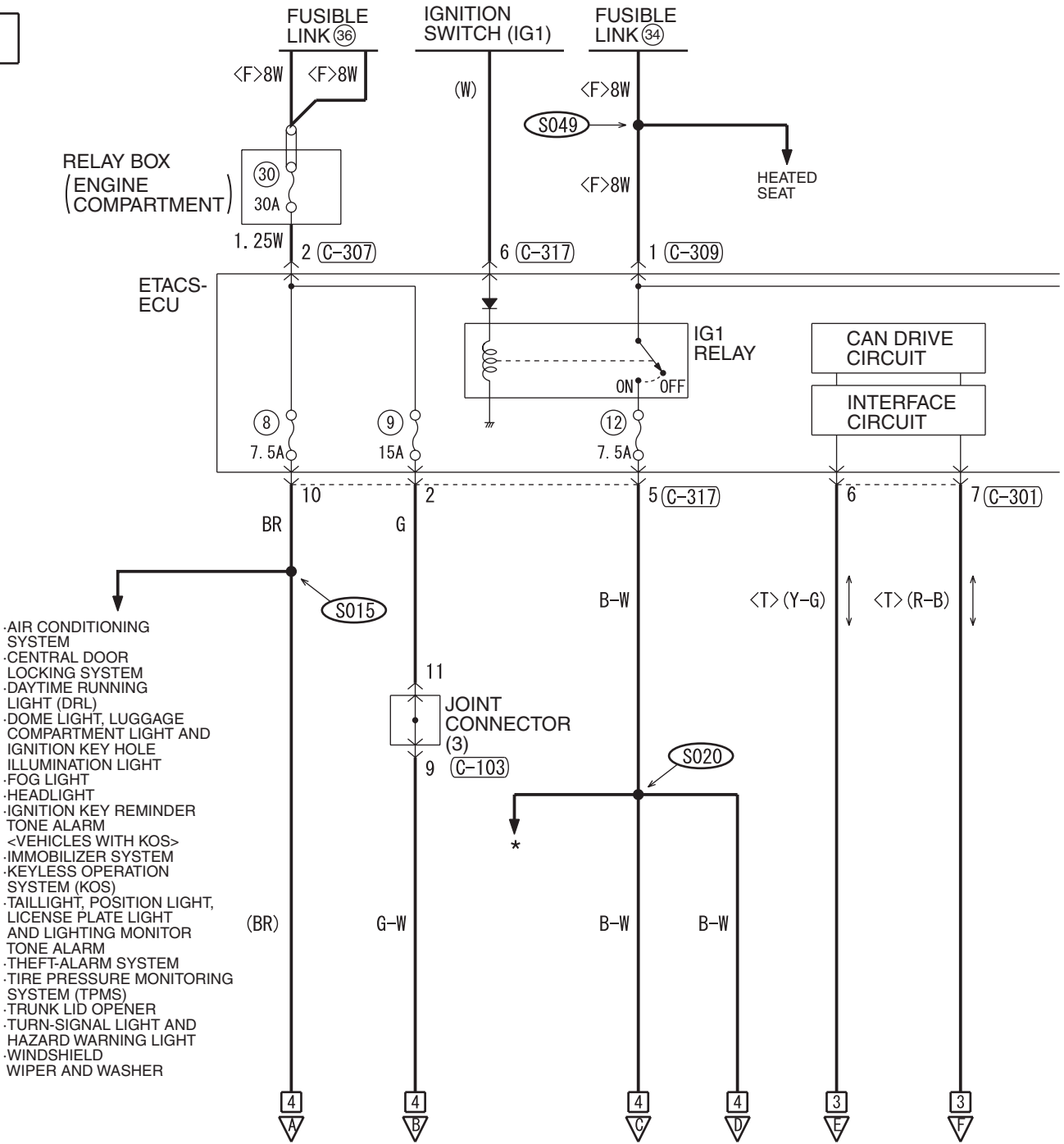

(A-05)

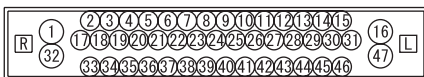

(C-40) FRONT SIDE

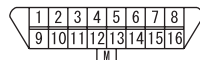

(C-103)

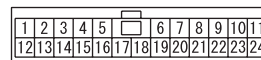

(C-104)

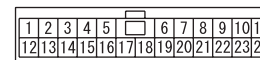

NOTE

- * : ABS, ASC, ACD, AYC AND S-AWC
- AIR CONDITIONING SYSTEM
- CENTRAL DOOR LOCKING SYSTEM
- DAYTIME RUNNING LIGHT (DRL)
- DOME LIGHT, LUGGAGE COMPARTMENT LIGHT AND IGNITION KEY HOLE ILLUMINATION LIGHT
- FOG LIGHT
- HEADLIGHT
- HEATED SEAT
- IGNITION KEY REMINDER TONE ALARM
- IMMOBILIZER SYSTEM
- KEYLESS OPERATING SYSTEM (KOS)
- REAR WINDOW DEFOGGER
- SHIFT LOCK MECHANISM
- SUNROOF
- SUPPLEMENTAL RESTRAINT SYSTEM (SRS)
- TAILLIGHT, POSITION LIGHT, LICENSE PLATE LIGHT AND LIGHTING MONITOR TONE ALARM
- TC-SST
- THEFT-ALARM SYSTEM
- TIRE PRESSURE MONITORING SYSTEM (TPMS)
- TRUNK LID OPENER
- TURN-SIGNAL LIGHT AND HAZARD WARNING LIGHT
- WINDSHIELD WIPER AND WASHER

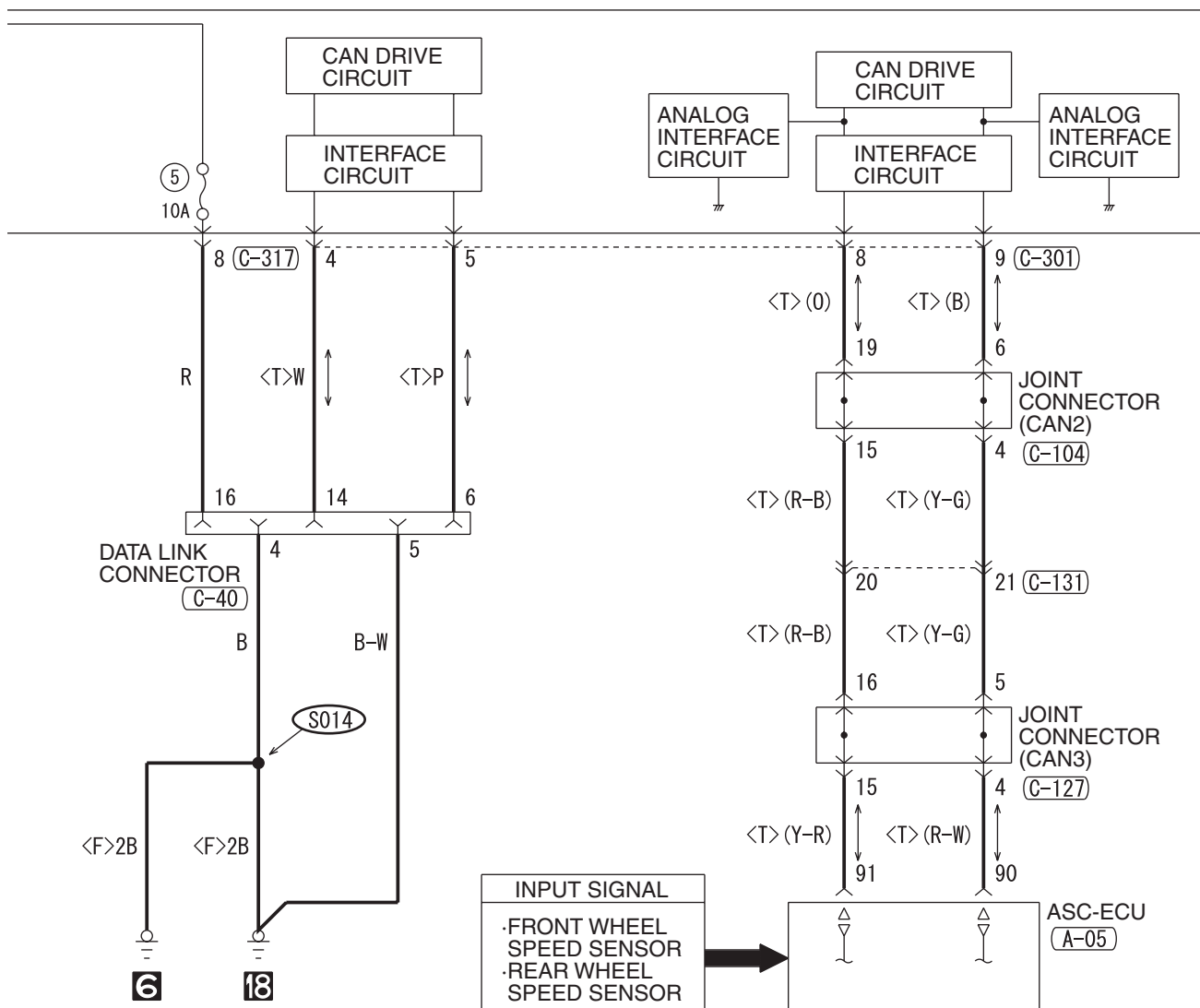

(C-127)

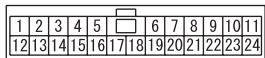

(C-131)

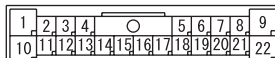

(C-301)

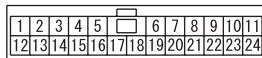

(C-307)



(C-309)



(C-317)

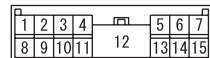

WIRE COLOR CODE

B : BLACK LG : LIGHT GREEN G : GREEN L : BLUE W : WHITE Y : YELLOW SB : SKY BLUE
BR : BROWN O : ORANGE GR : GRAY R : RED P : PINK V : VIOLET PU : PURPLE SI : SILVER

SEAT BELT WARNING TONE ALARM (CONTINUED)

3

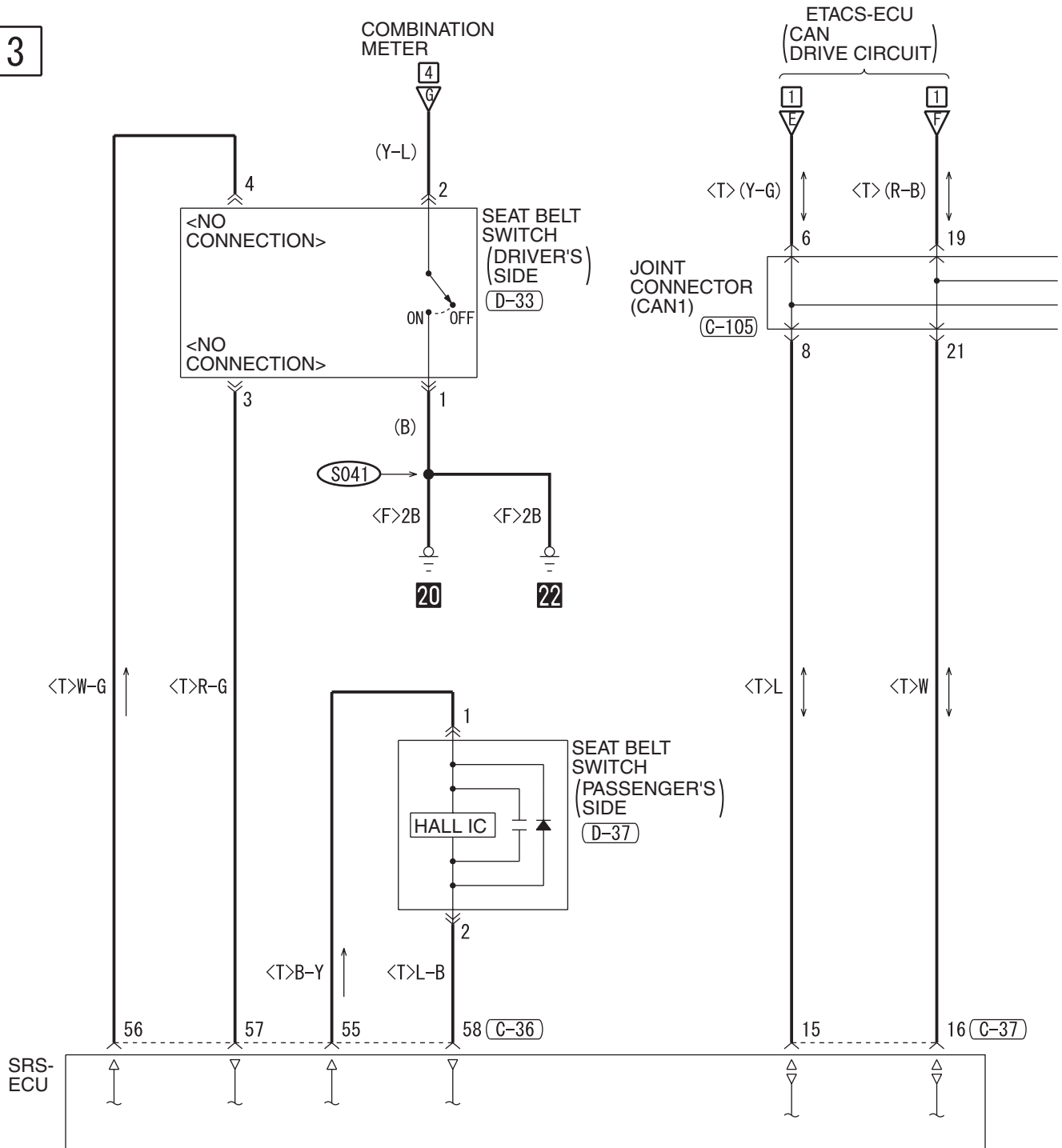

C-04

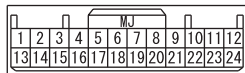

C-36

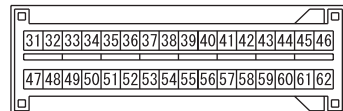

C-37

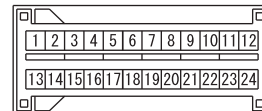

C-41

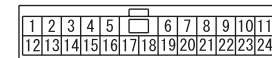

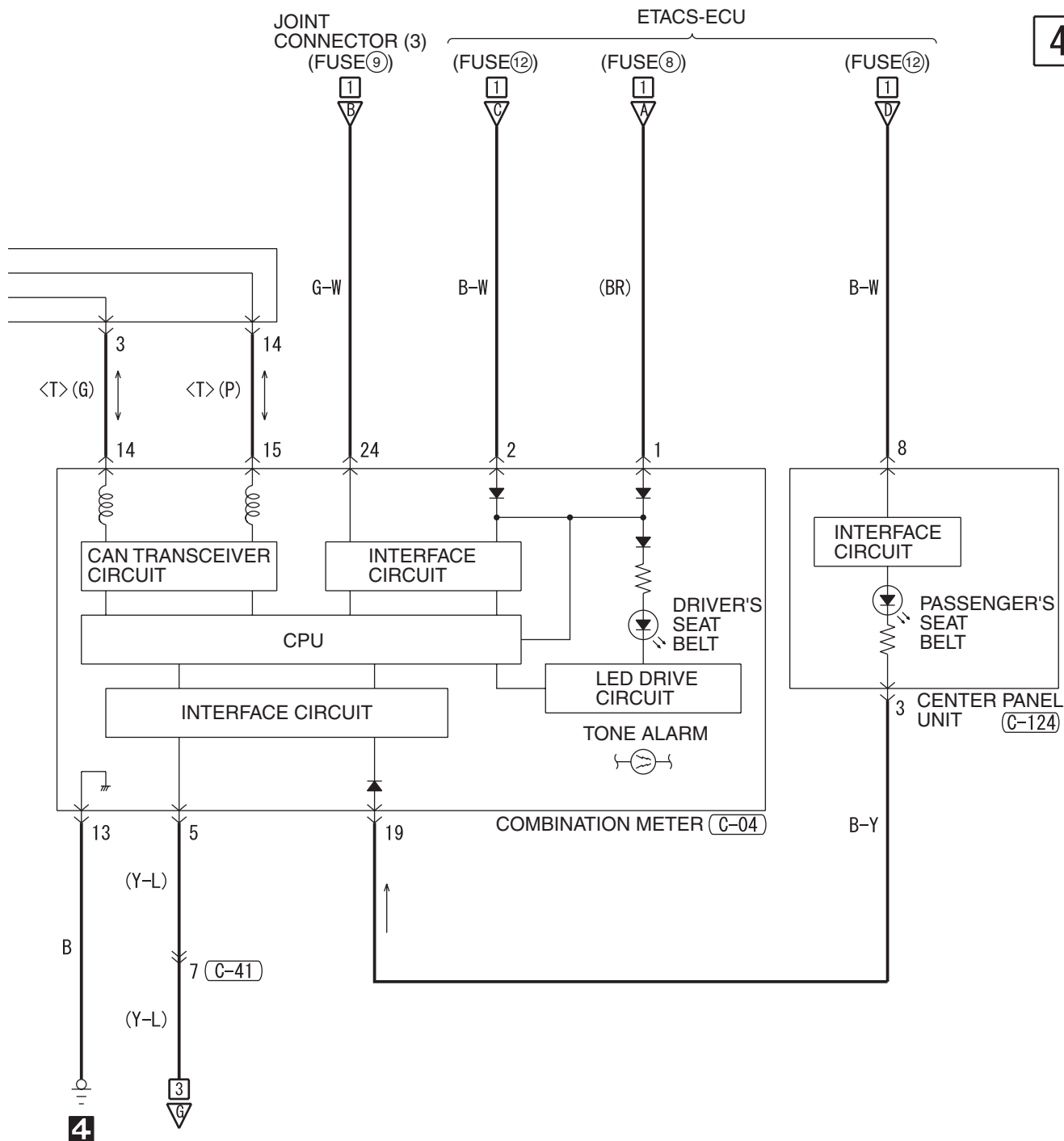

(C-105)

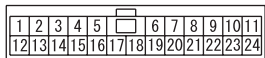

(C-124)

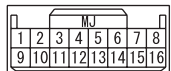

(D-33)



(D-37)



WIRE COLOR CODE

B: BLACK LG: LIGHT GREEN G: GREEN L: BLUE W: WHITE Y: YELLOW SB: SKY BLUE
BR: BROWN O: ORANGE GR: GRAY R: RED P: PINK V: VIOLET PU: PURPLE SI: SILVER

H8G15M50BB

DOOR AJAR WARNING TONE ALARM

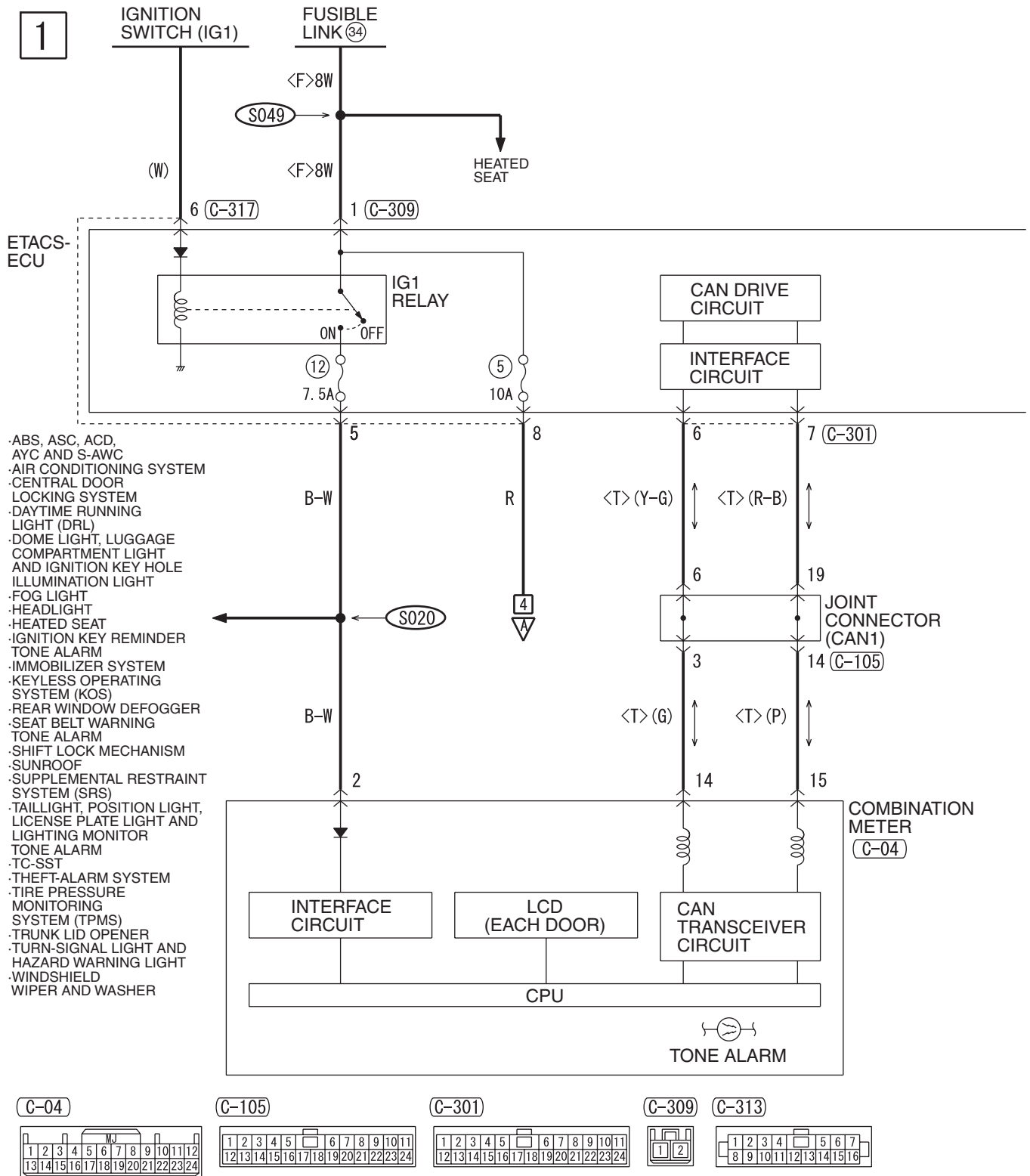

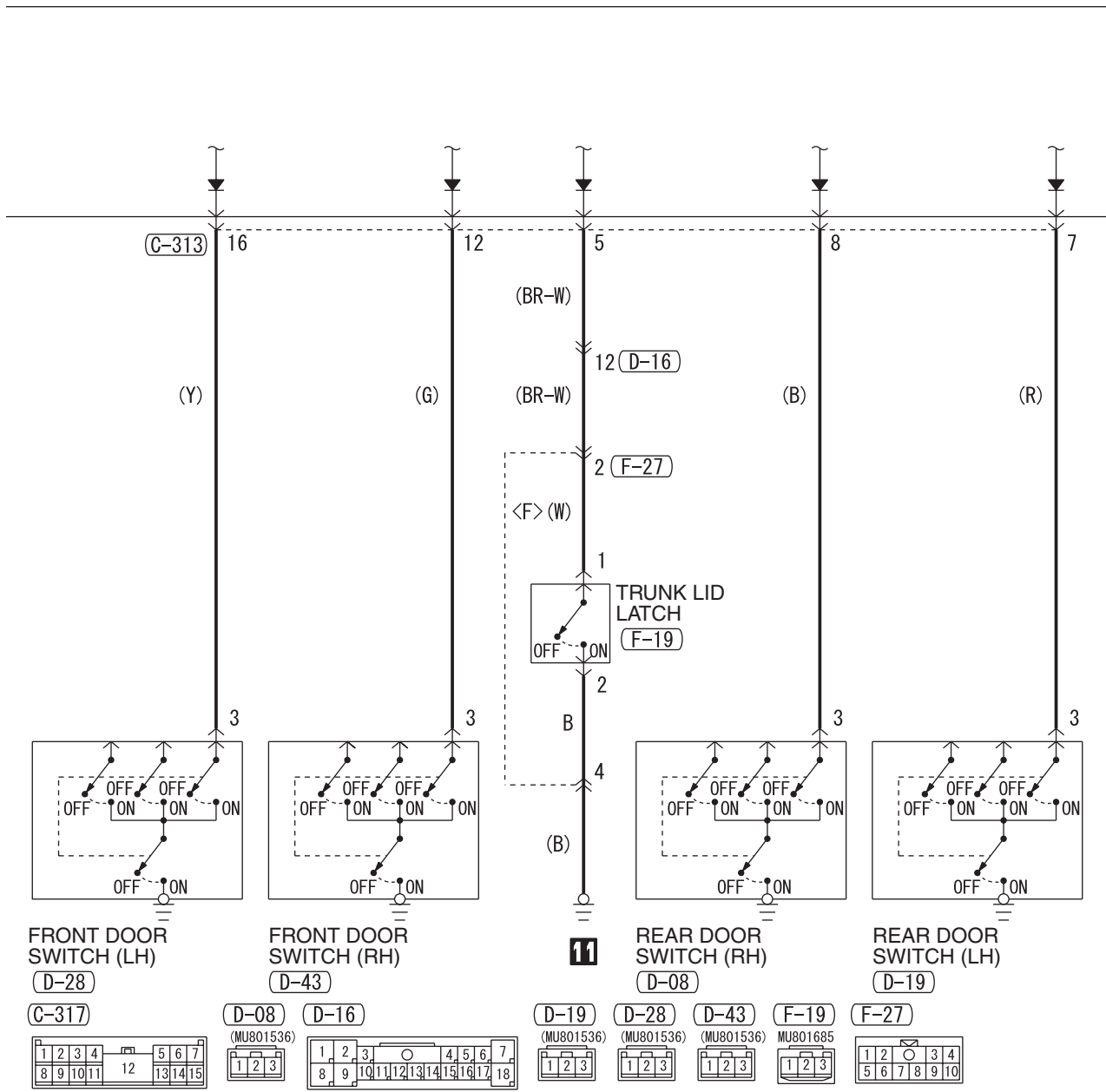

FRONT DOOR SWITCH (LH)
(D-28)

FRONT DOOR SWITCH (RH)
(D-43)

REAR DOOR SWITCH (RH)
(D-08)

REAR DOOR SWITCH (LH)
(D-19)

(C-317)

(D-08)

(D-16)

(D-19)

(D-28)

(D-43)

(F-19)

(F-27)

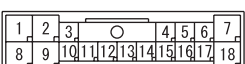
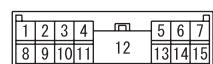

WIRE COLOR CODE
 B : BLACK LG : LIGHT GREEN G : GREEN L : BLUE W : WHITE Y : YELLOW SB : SKY BLUE
 BR : BROWN O : ORANGE GR : GRAY R : RED P : PINK V : VIOLET PU : PURPLE SI : SILVER

DOOR AJAR WARNING TONE ALARM (CONTINUED)

3

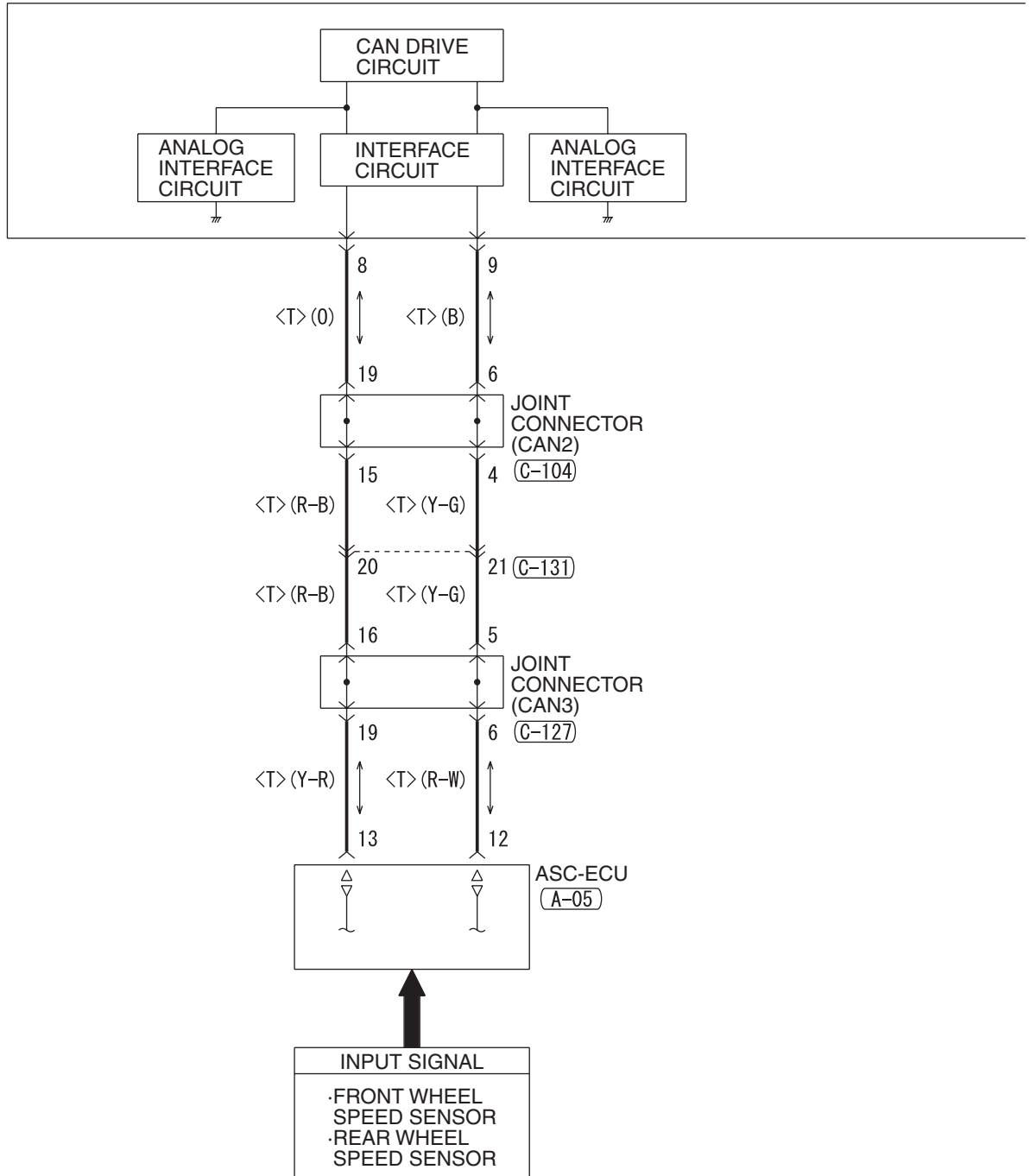

(A-05)

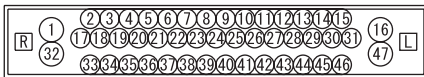

(C-40) FRONT SIDE



(C-104)



(C-127)



4

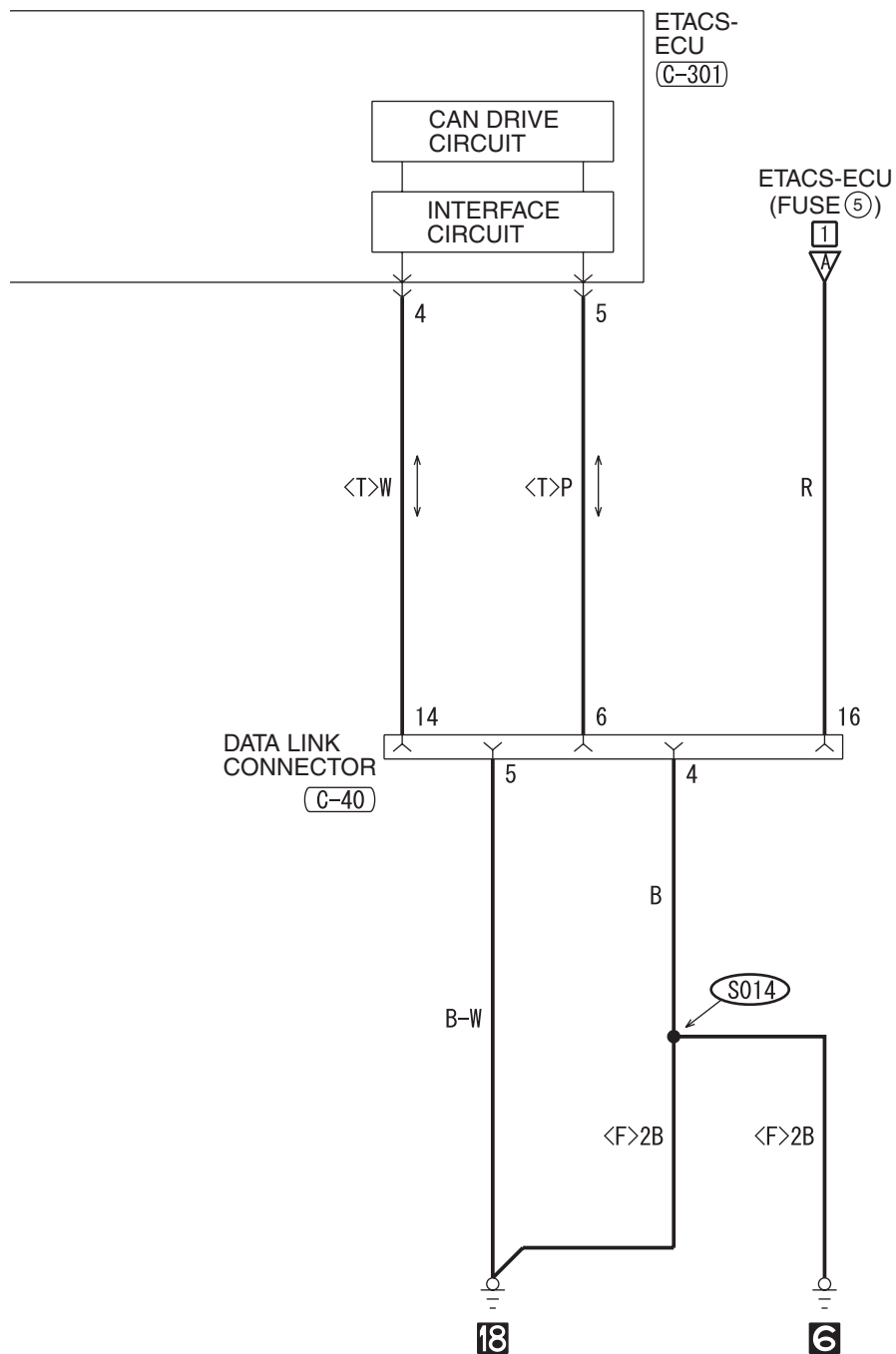

(C-131)

1	2	3	4	5	6	7	8	9	10
11	12	13	14	15	16	17	18	19	20
21	22								

(C-301)

1	2	3	4	5	6	7	8	9	10	11
12	13	14	15	16	17	18	19	20	21	22
23	24									

WIRE COLOR CODE

B : BLACK LG : LIGHT GREEN G : GREEN L : BLUE W : WHITE Y : YELLOW SB : SKY BLUE
BR : BROWN O : ORANGE GR : GRAY R : RED P : PINK V : VIOLET PU : PURPLE SI : SILVER

H8G15M51BB

PARKING BRAKE REMINDER TONE ALARM

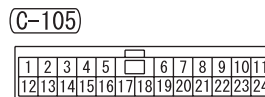
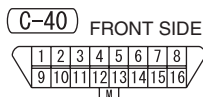
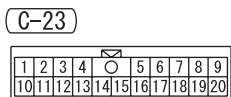
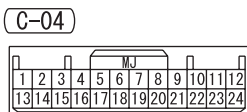
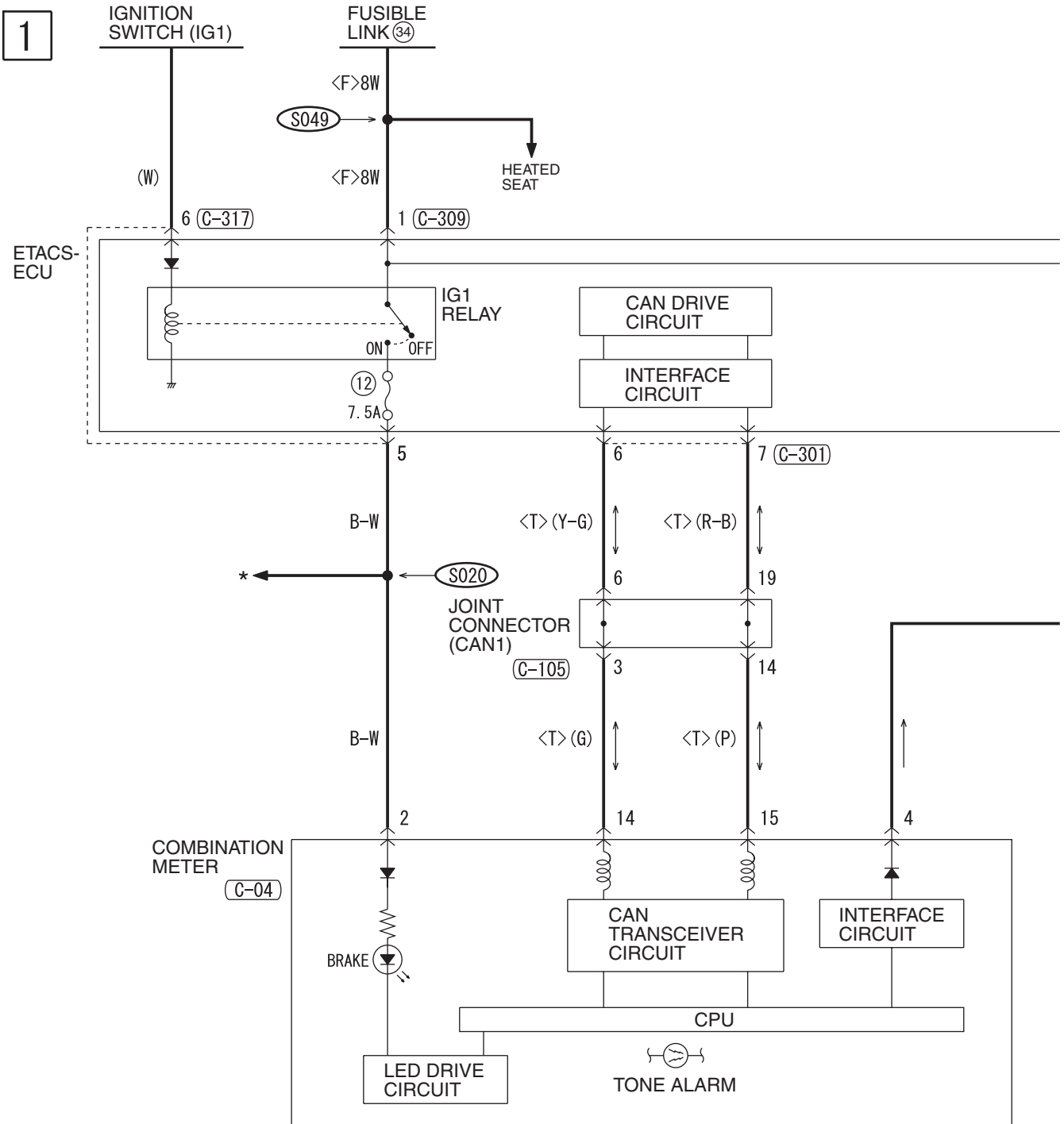

2

NOTE

- * : .ABS, ASC, ACD,
- .AYC AND S-AWC
- .AIR CONDITIONING SYSTEM
- .CENTRAL DOOR LOCKING SYSTEM
- .DAYTIME RUNNING LIGHT (DRL)
- .DOME LIGHT, LUGGAGE COMPARTMENT LIGHT AND IGNITION KEY HOLE ILLUMINATION LIGHT
- .FOG LIGHT
- .HEADLIGHT
- .HEATED SEAT
- .IGNITION KEY REMINDER TONE ALARM
- .IMMOBILIZER SYSTEM
- .KEYLESS OPERATING SYSTEM (KOS)
- .REAR WINDOW DEFOGGER
- .SEAT BELT WARNING TONE ALARM
- .SHIFT LOCK MECHANISM
- .SUNROOF
- .SUPPLEMENTAL RESTRAINT SYSTEM (SRS)
- .TAILLIGHT, POSITION LIGHT, LICENSE PLATE LIGHT AND LIGHTING MONITOR TONE ALARM
- .TC-SST
- .THEFT-ALARM SYSTEM
- .TIRE PRESSURE MONITORING SYSTEM (TPMS)
- .TRUNK LID OPENER
- .TURN-SIGNAL LIGHT AND HAZARD WARNING LIGHT
- .WINDSHIELD WIPER AND WASHER

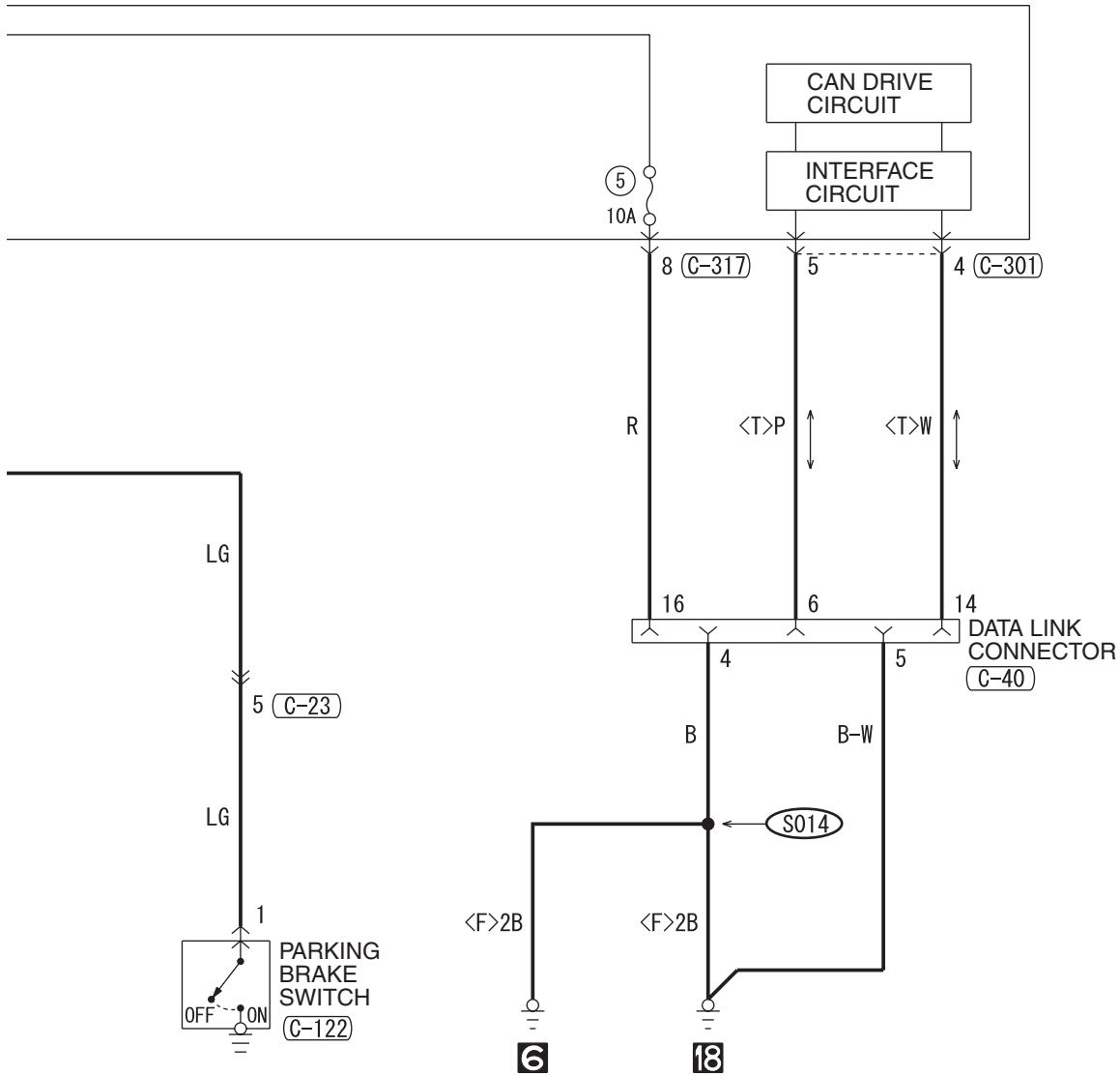

(C-301)

(C-309)

(C-317)

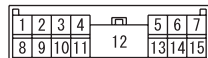
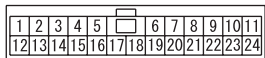

WIRE COLOR CODE

B : BLACK LG : LIGHT GREEN G : GREEN L : BLUE W : WHITE Y : YELLOW SB : SKY BLUE
 BR : BROWN O : ORANGE GR : GRAY R : RED P : PINK V : VIOLET PU : PURPLE SI : SILVER

PARKING BRAKE REMINDER TONE ALARM (CONTINUED)

3

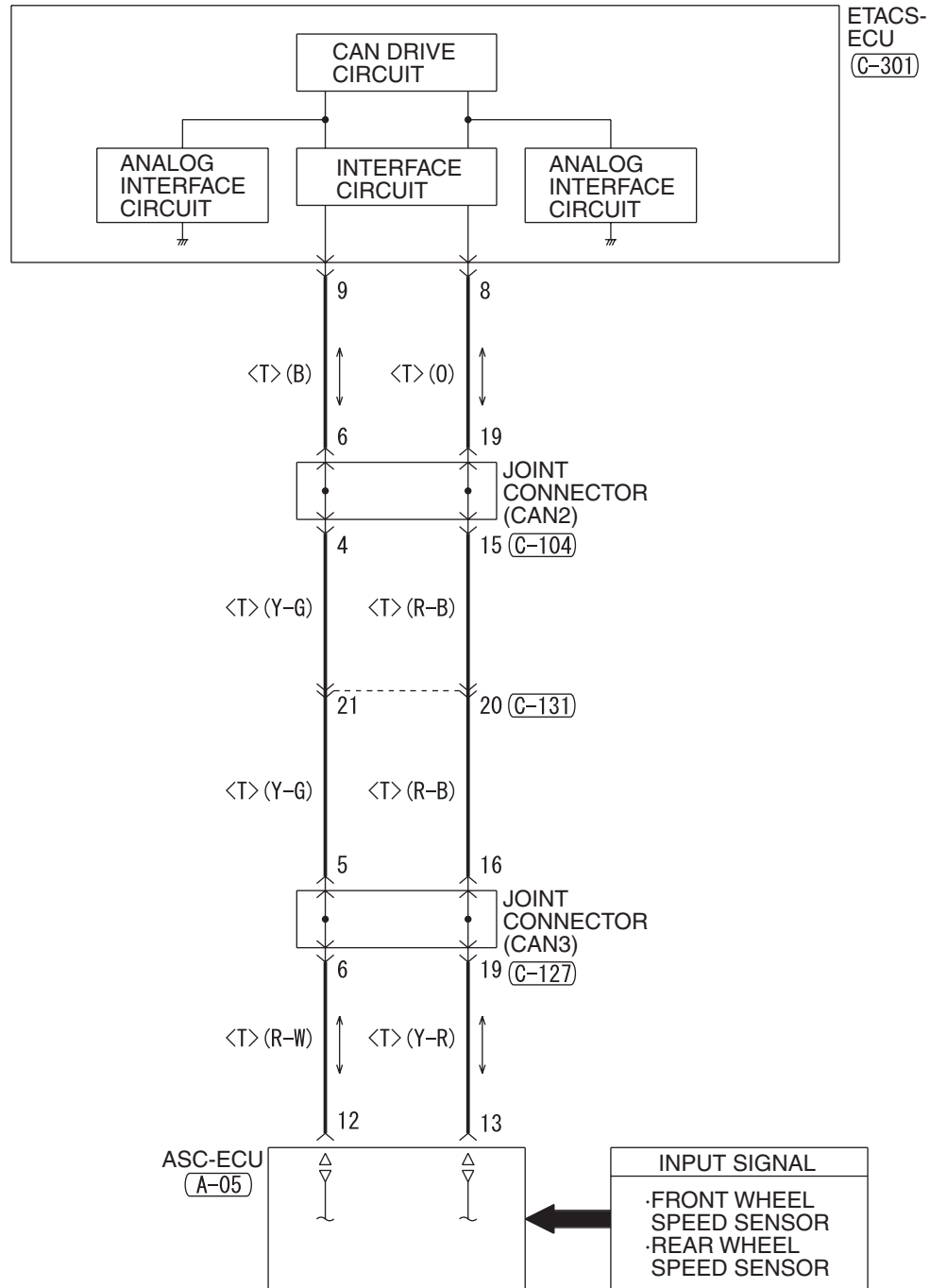

(A-05)

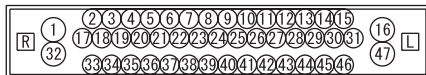

(C-104)

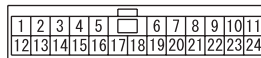

(C-127)

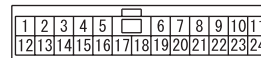

(C-131)

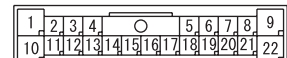

(C-301)



WIRE COLOR CODE

B : BLACK LG : LIGHT GREEN G : GREEN L : BLUE W : WHITE
Y : YELLOW SB : SKY BLUE BR : BROWN O : ORANGE GR : GRAY
R : RED P : PINK V : VIOLET PU : PURPLE SI : SILVER

H8G15M52BA

TSB Revision

NOTES

THEFT-ALARM SYSTEM

M1901012400843

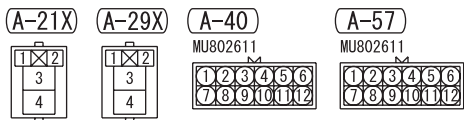
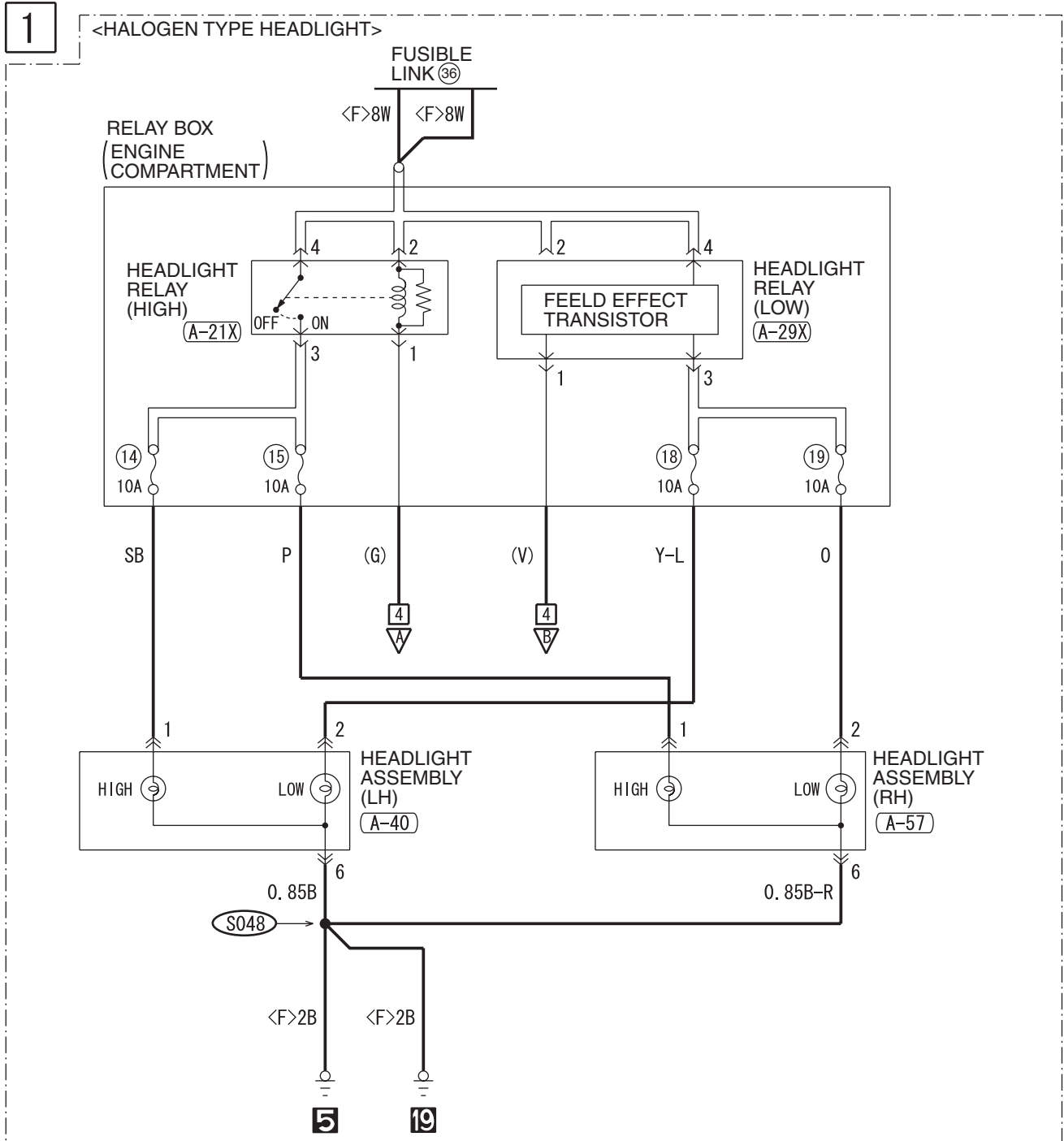

H8G15M53AA

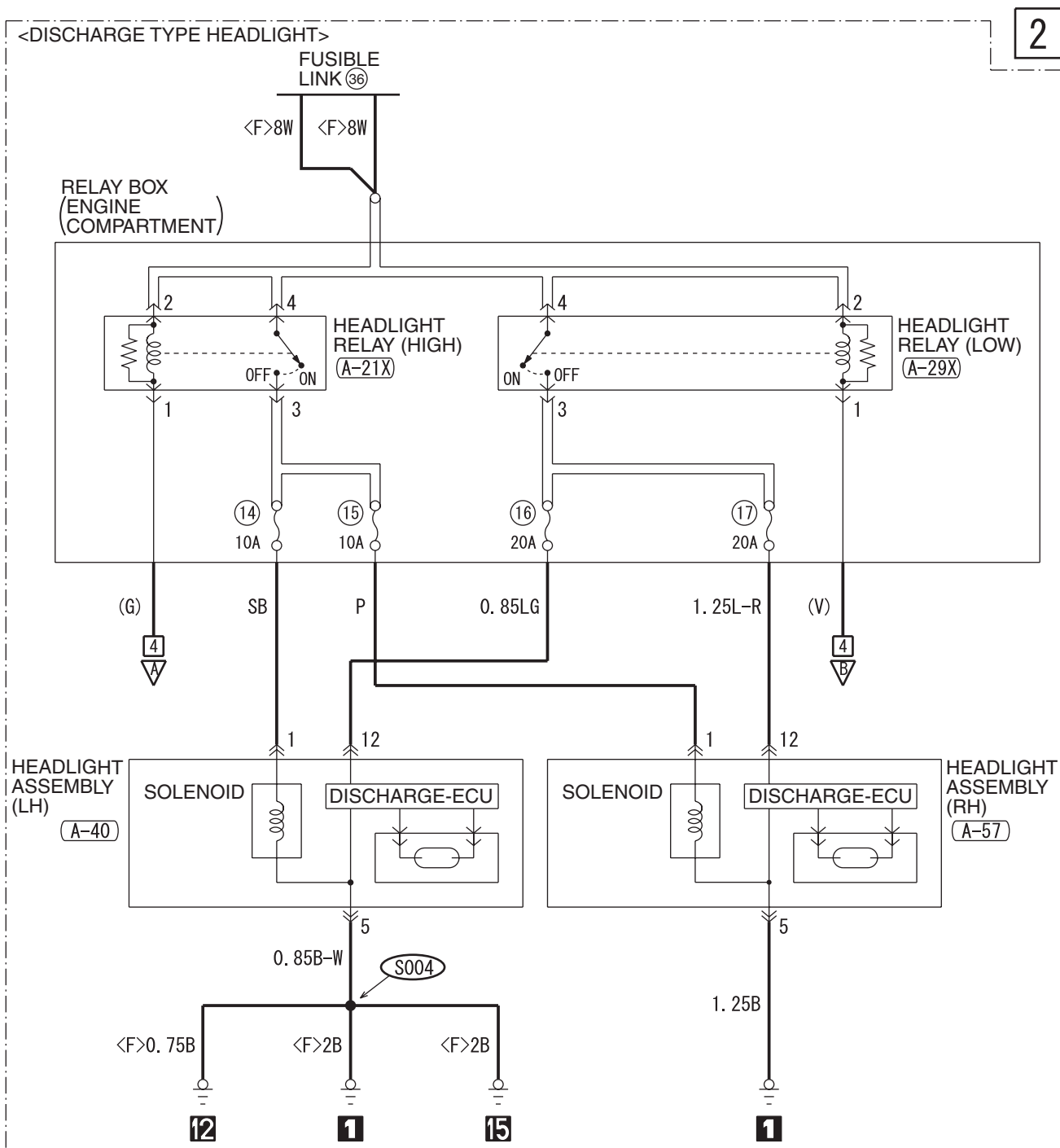

WIRE COLOR CODE

B: BLACK LG: LIGHT GREEN G: GREEN L: BLUE W: WHITE Y: YELLOW SB: SKY BLUE
BR: BROWN O: ORANGE GR: GRAY R: RED P: PINK V: VIOLET PU: PURPLE SI: SILVER

H8G15M53AB

THEFT-ALARM SYSTEM (CONTINUED)

3

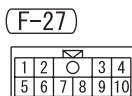
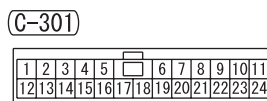
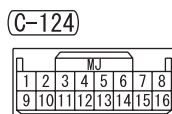
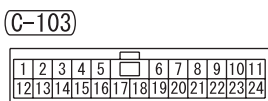
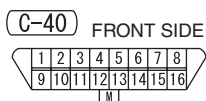
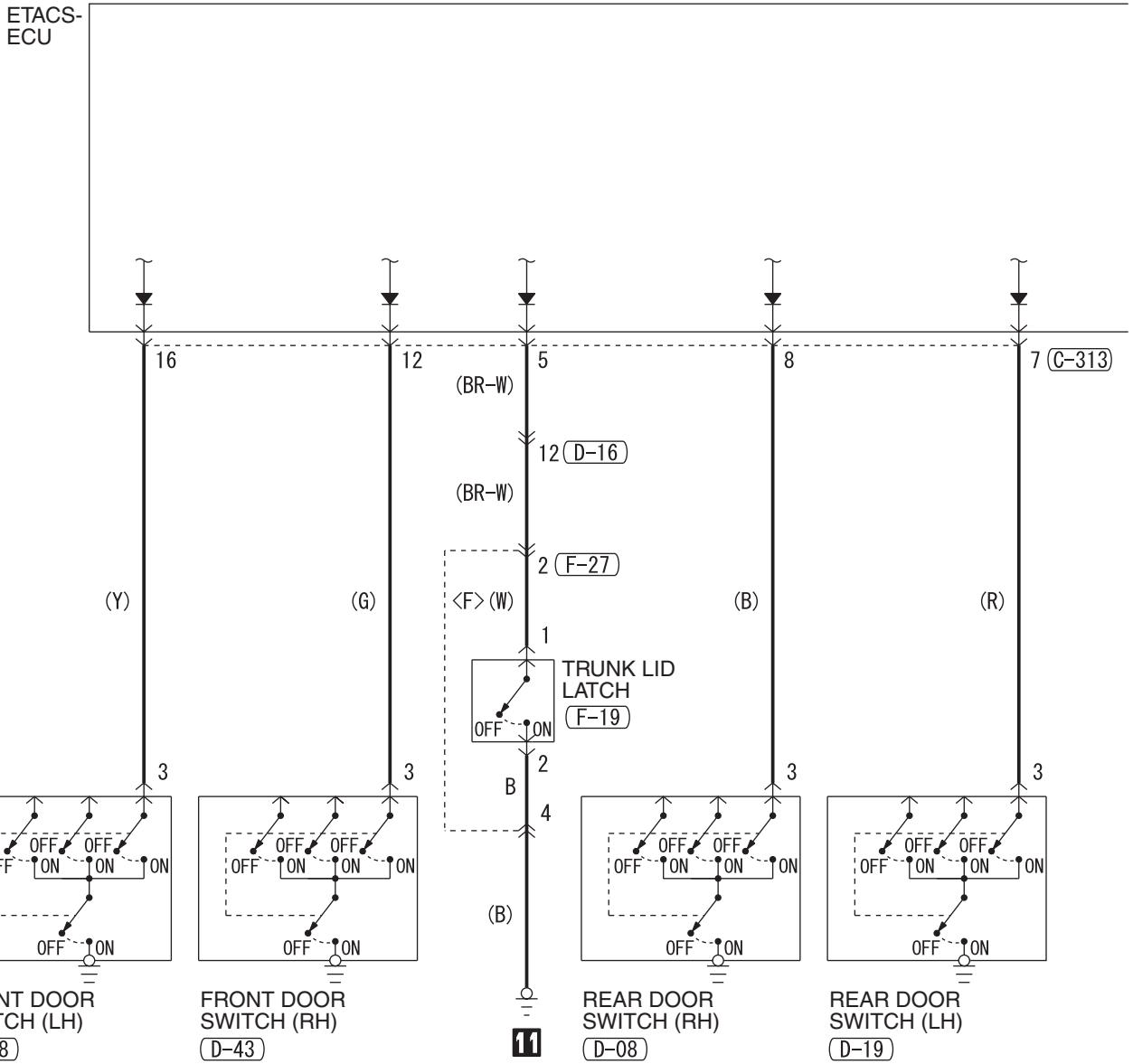

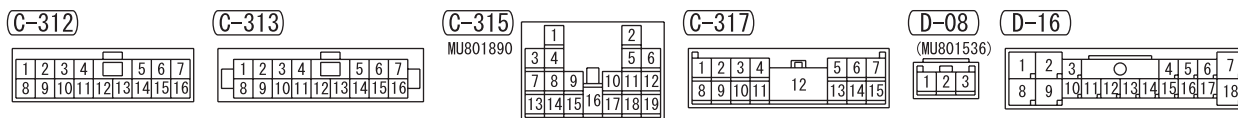
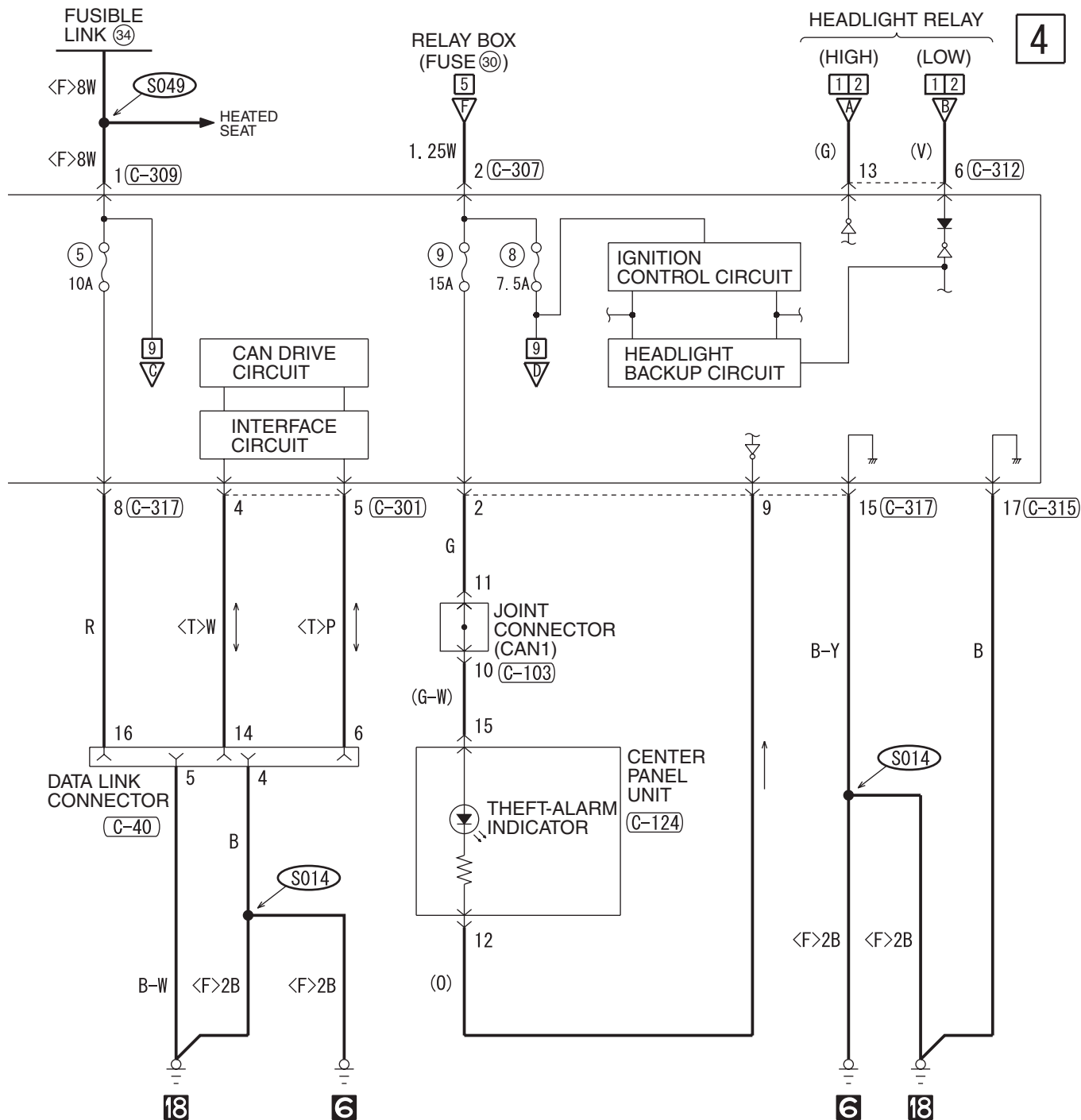

WIRE COLOR CODE
 B : BLACK LG : LIGHT GREEN G : GREEN L : BLUE W : WHITE Y : YELLOW SB : SKY BLUE
 BR : BROWN O : ORANGE GR : GRAY R : RED P : PINK V : VIOLET PU : PURPLE SI : SILVER

THEFT-ALARM SYSTEM (CONTINUED)

5

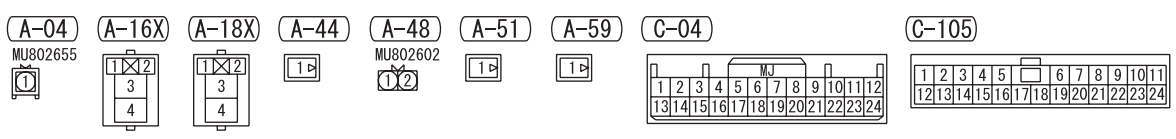
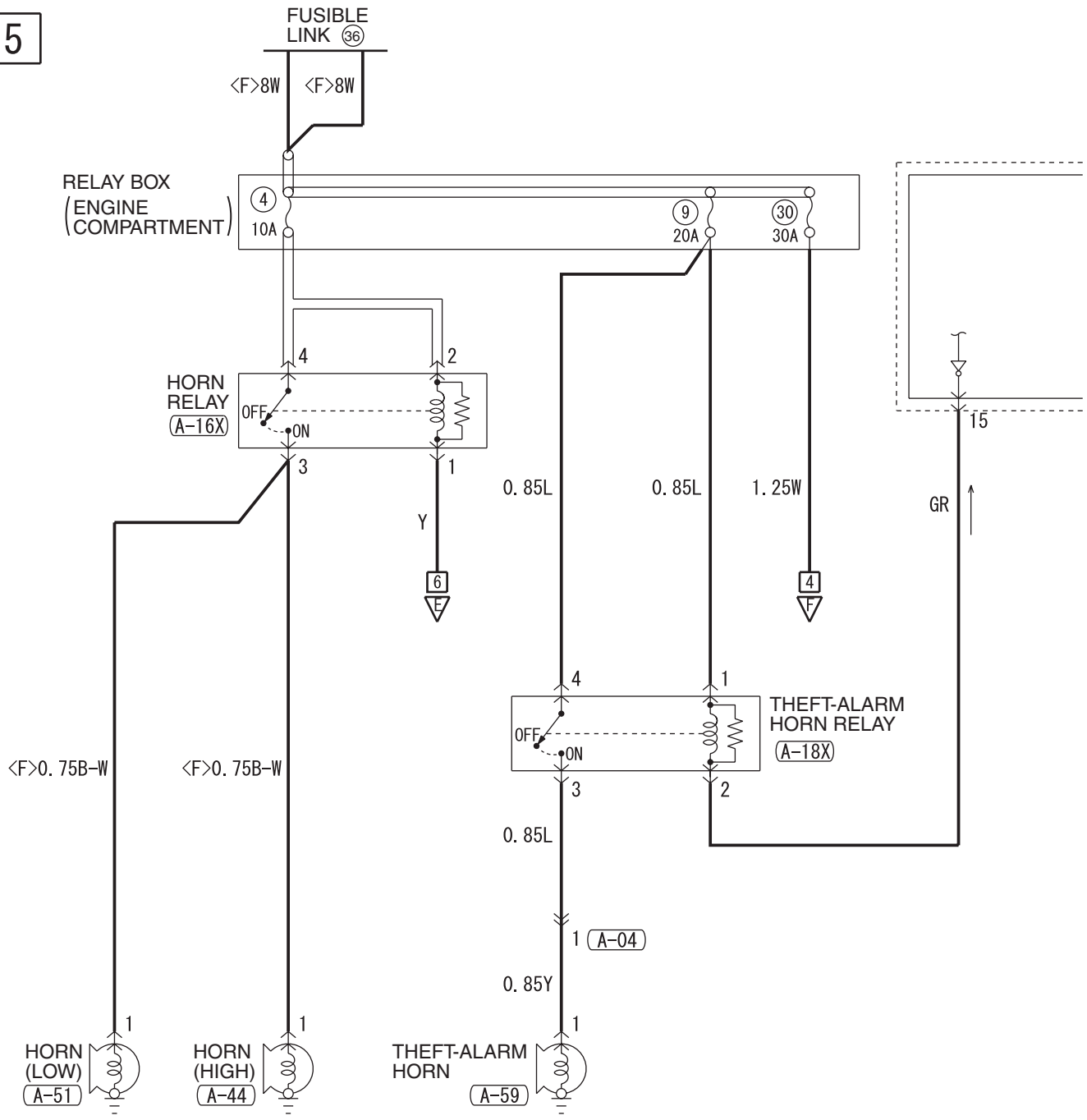

6

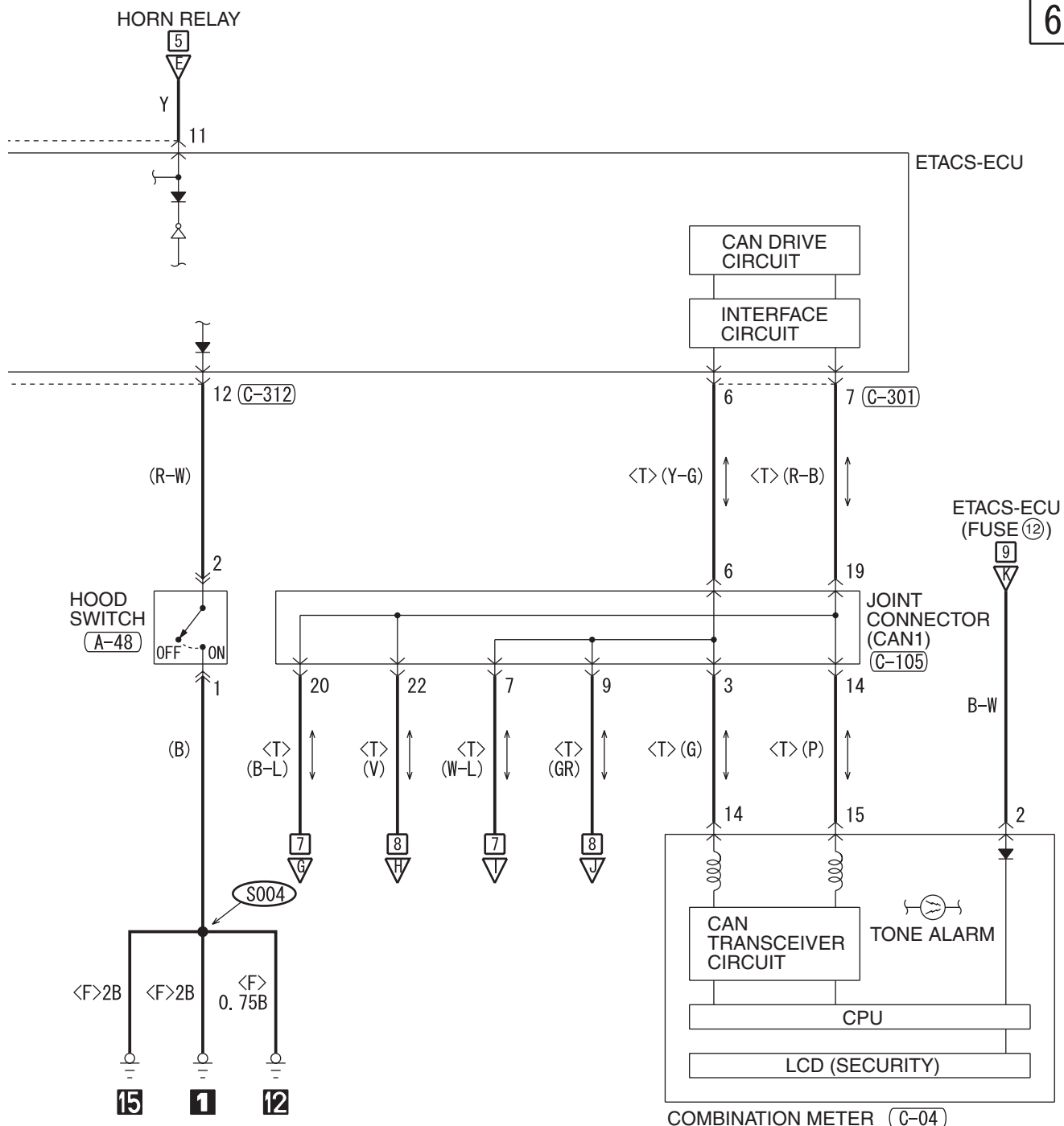

(C-301)

1	2	3	4	5	6	7	8	9	10	11		
12	13	14	15	16	17	18	19	20	21	22	23	24

(C-312)

1	2	3	4	5	6	7		
8	9	10	11	12	13	14	15	16

WIRE COLOR CODE

B: BLACK LG: LIGHT GREEN G: GREEN L: BLUE W: WHITE Y: YELLOW SB: SKY BLUE
BR: BROWN O: ORANGE GR: GRAY R: RED P: PINK V: VIOLET PU: PURPLE SI: SILVER

H8G15M53CB

TSB Revision

THEFT-ALARM SYSTEM (CONTINUED)

7

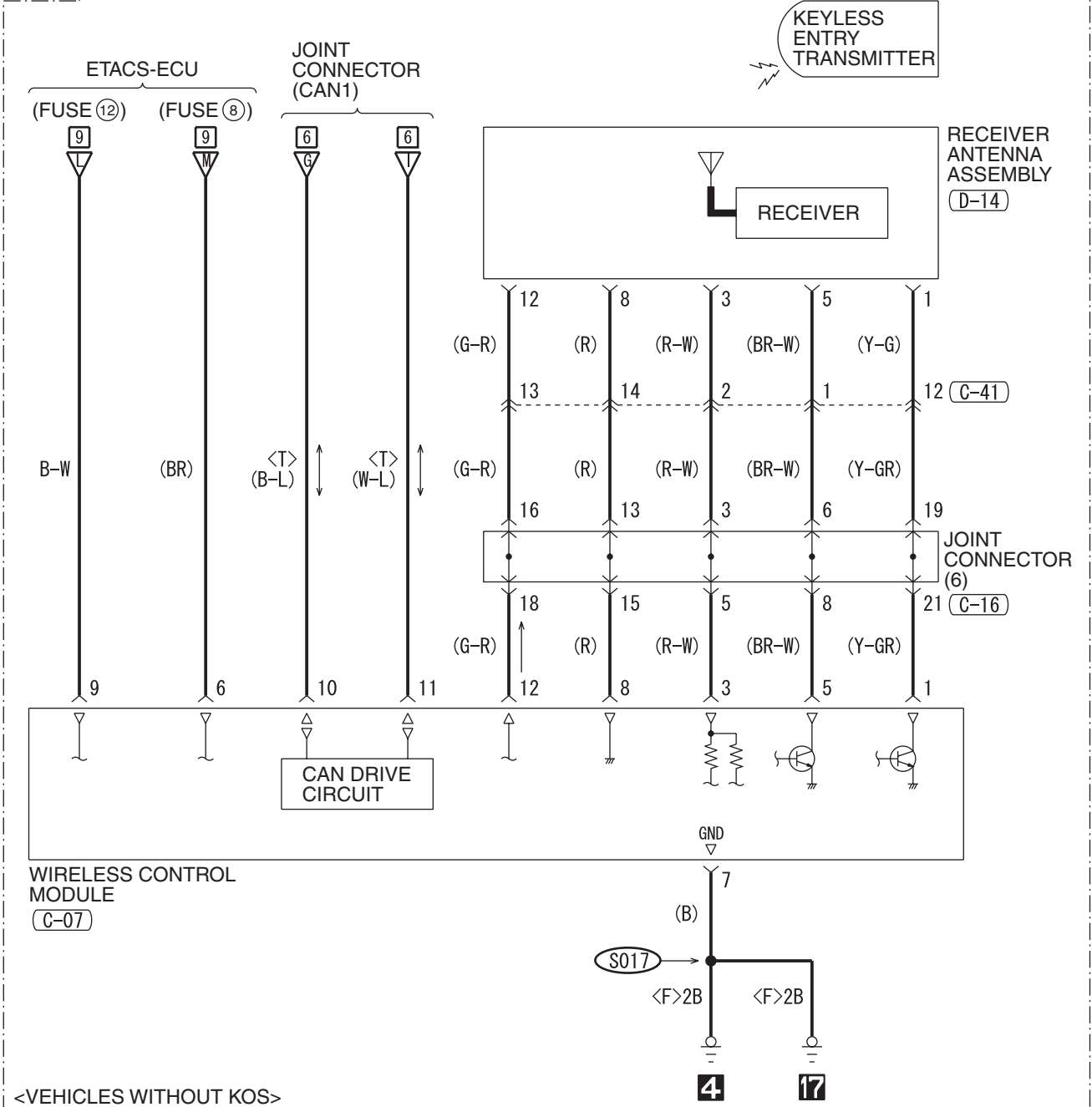

(C-05)

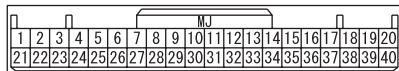

(C-07)

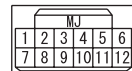

(C-16)



(C-41)

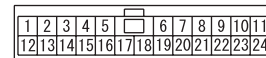

(D-14)

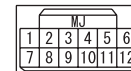

8

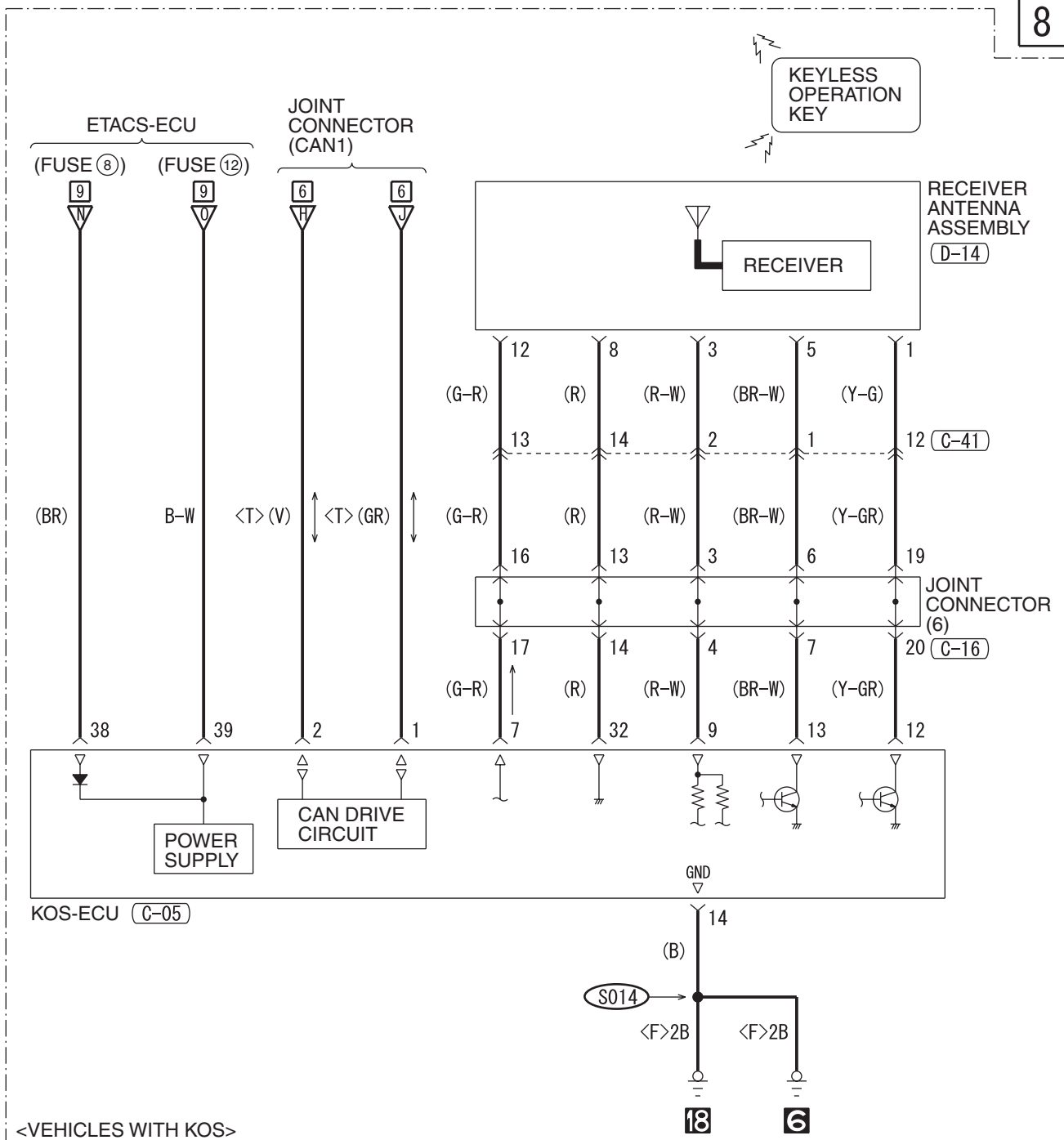

WIRE COLOR CODE
 B: BLACK LG: LIGHT GREEN G: GREEN L: BLUE W: WHITE Y: YELLOW SB: SKY BLUE
 BR: BROWN O: ORANGE GR: GRAY R: RED P: PINK V: VIOLET PU: PURPLE SI: SILVER

H8G15M53DB

TSB Revision

THEFT-ALARM SYSTEM (CONTINUED)

9

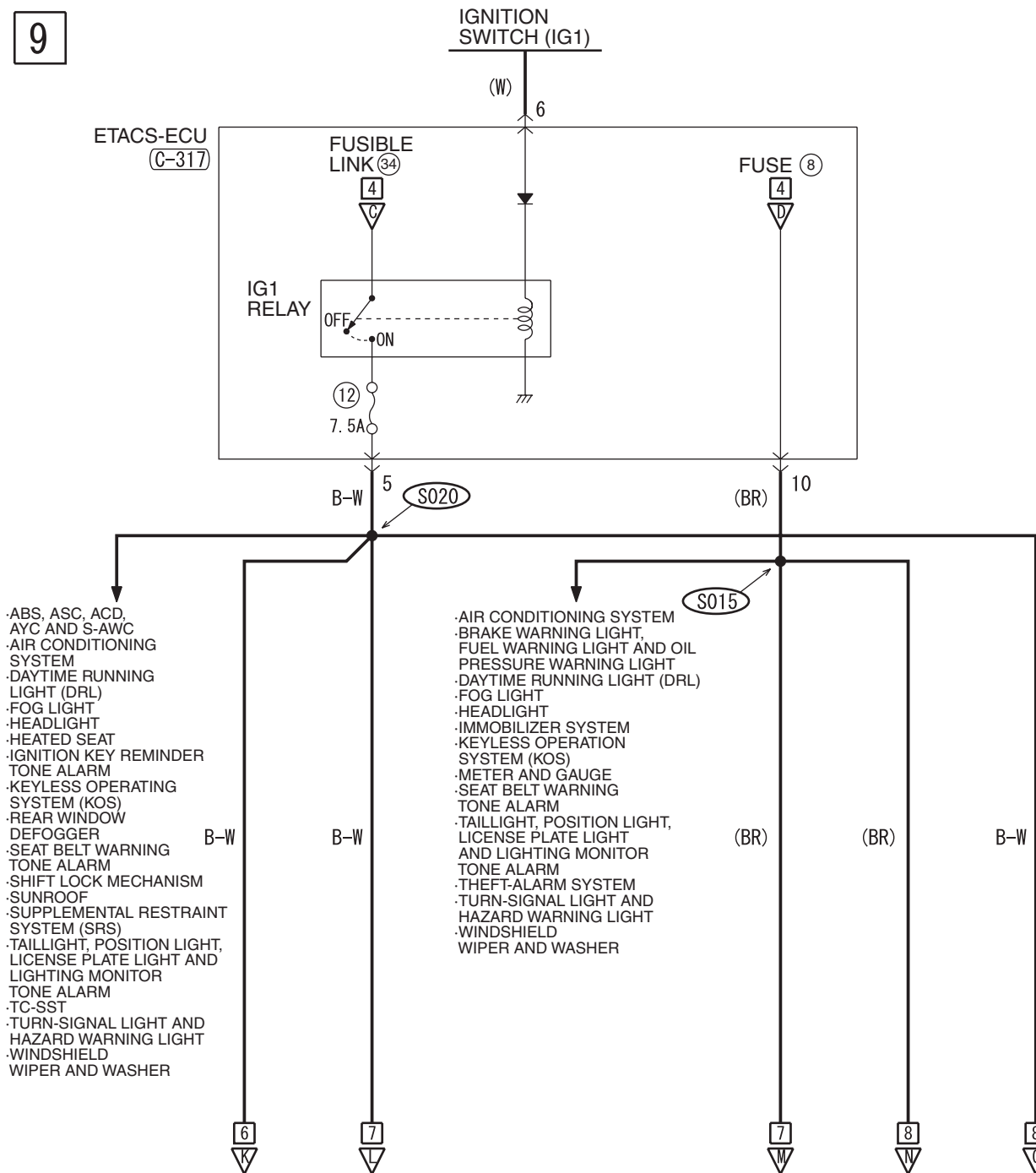

(C-317)

1	2	3	4	5	6	7	
8	9	10	11	12	13	14	15

WIRE COLOR CODE

B : BLACK LG : LIGHT GREEN G : GREEN L : BLUE W : WHITE Y : YELLOW SB : SKY BLUE
BR : BROWN O : ORANGE GR : GRAY R : RED P : PINK V : VIOLET PU : PURPLE SI : SILVER

H8G15M53EA

SPARE CONNECTOR (MULTI-PURPOSE)

M1901022700191

1

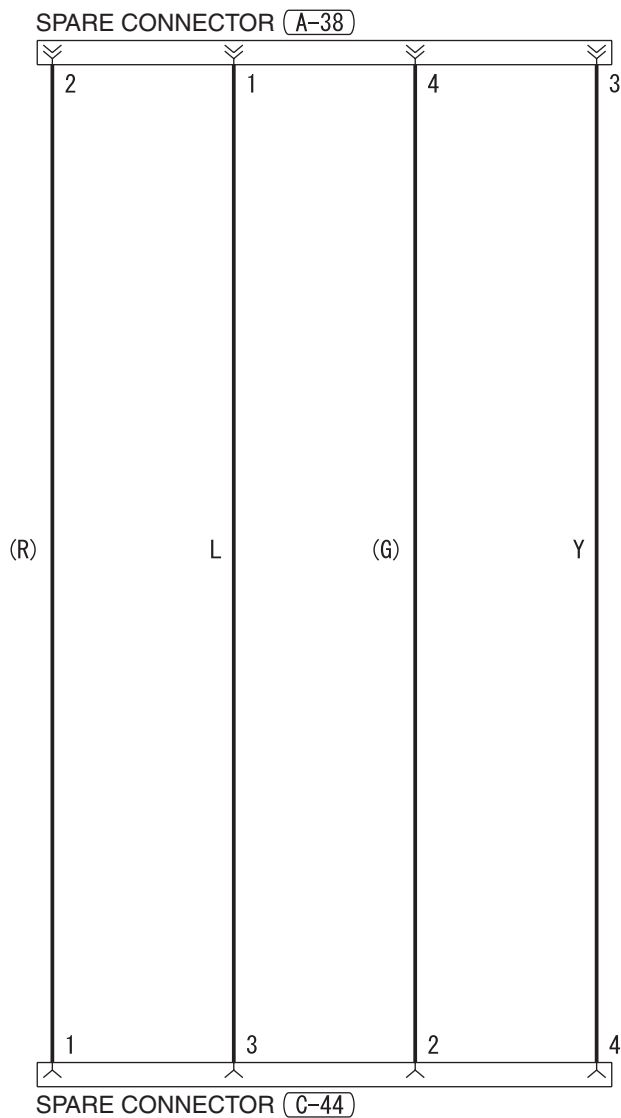

(A-38)

(C-44)

MU802605



WIRE COLOR CODE

B : BLACK LG : LIGHT GREEN G : GREEN L : BLUE W : WHITE Y : YELLOW SB : SKY BLUE
BR : BROWN O : ORANGE GR : GRAY R : RED P : PINK V : VIOLET PU : PURPLE SI : SILVER

H8G15M54AA

TSB Revision

CONTROLLER AREA NETWORK (CAN) <M/T>

M1901004000594

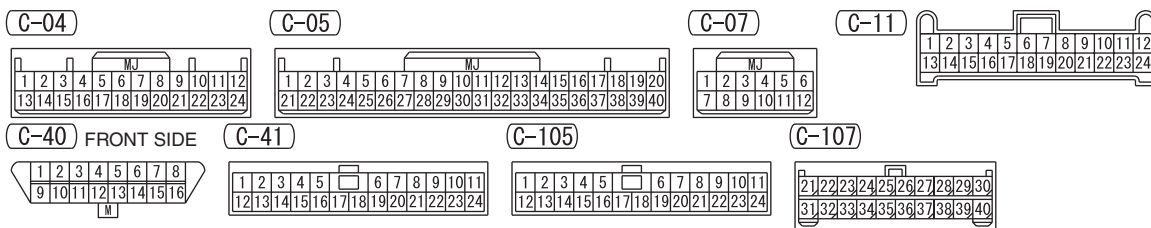
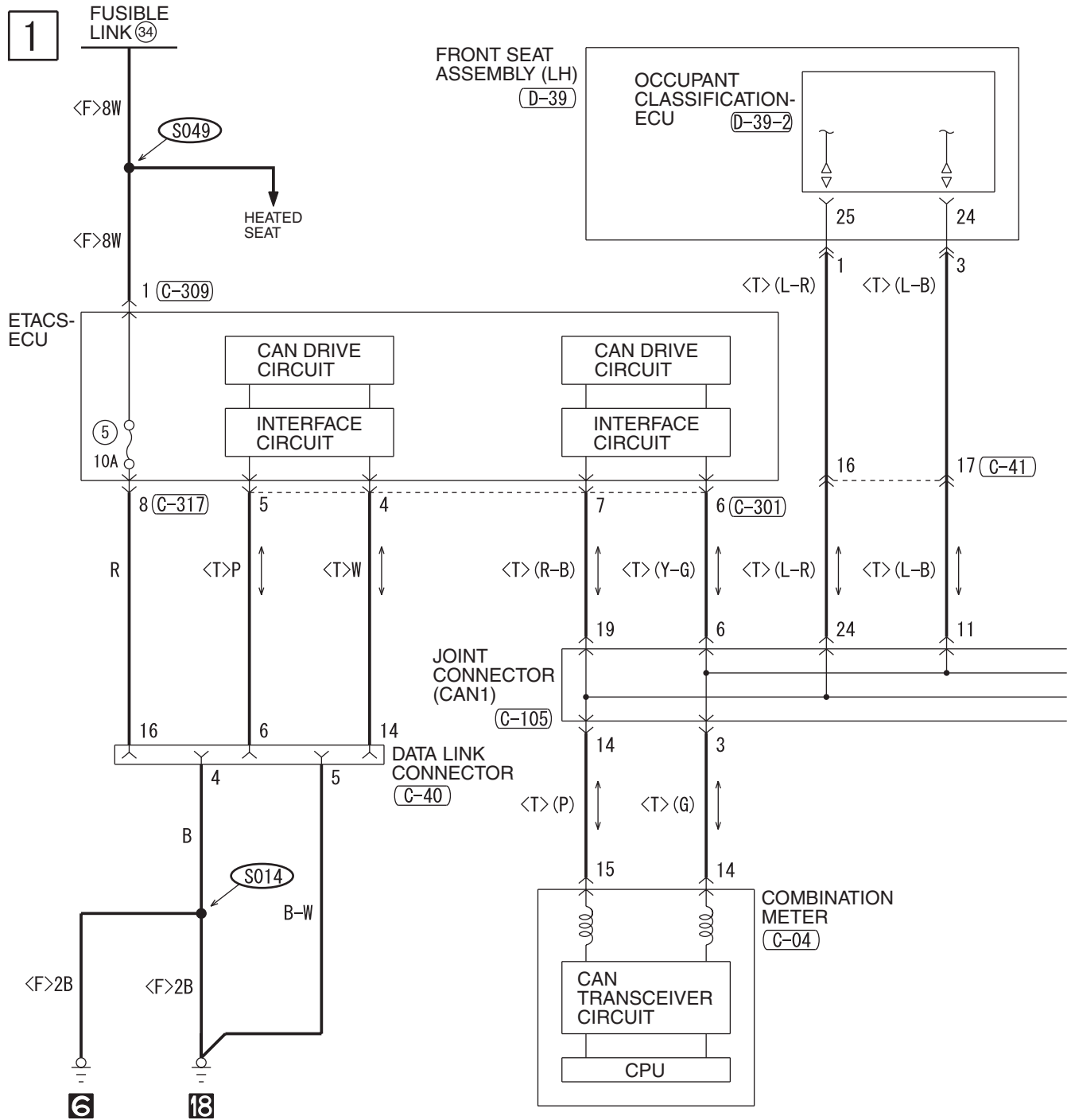

H8G15M55A6

2

NOTE
 *1 : VEHICLES WITHOUT KOS
 *2 : VEHICLES WITH KOS
 *3 : VEHICLES WITHOUT MMCS
 *4 : VEHICLES WITH MMCS

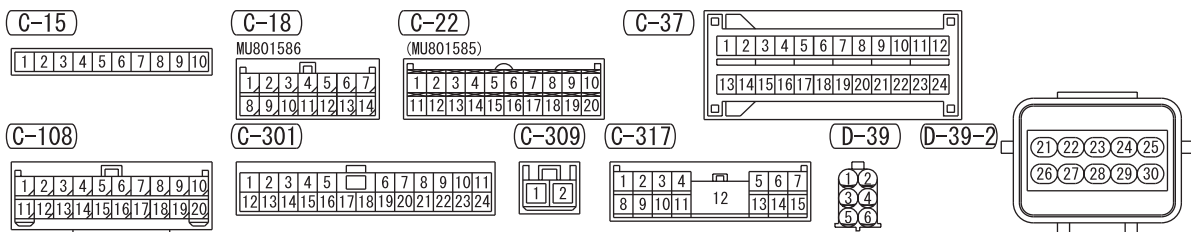
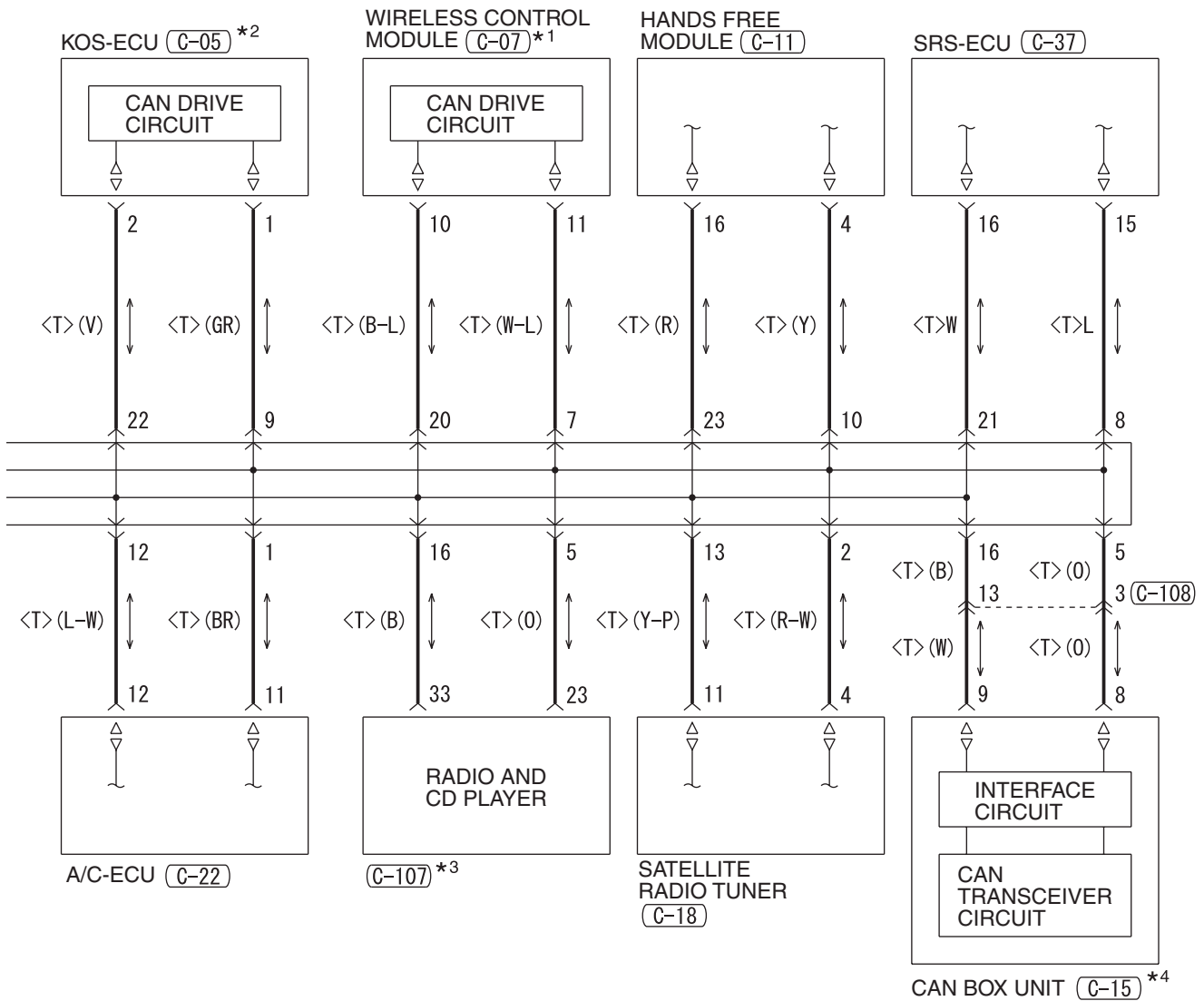

H8G15M55AB

CONTROLLER AREA NETWORK (CAN) <M/T> (CONTINUED)

3

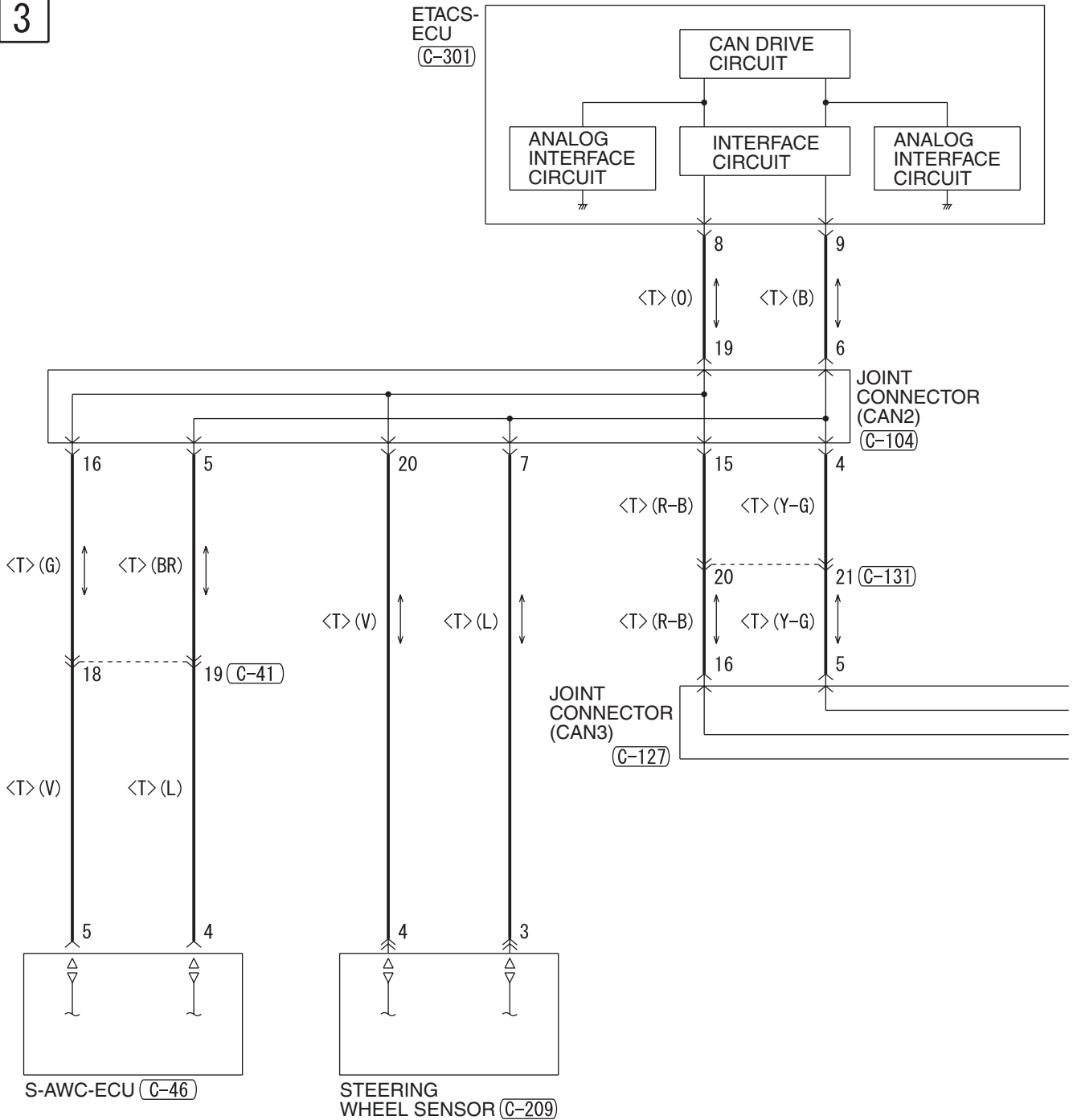

A-05

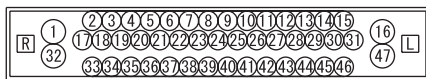

C-301

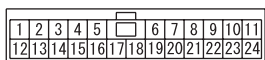

B-10

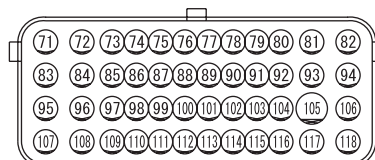

C-41

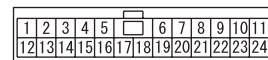

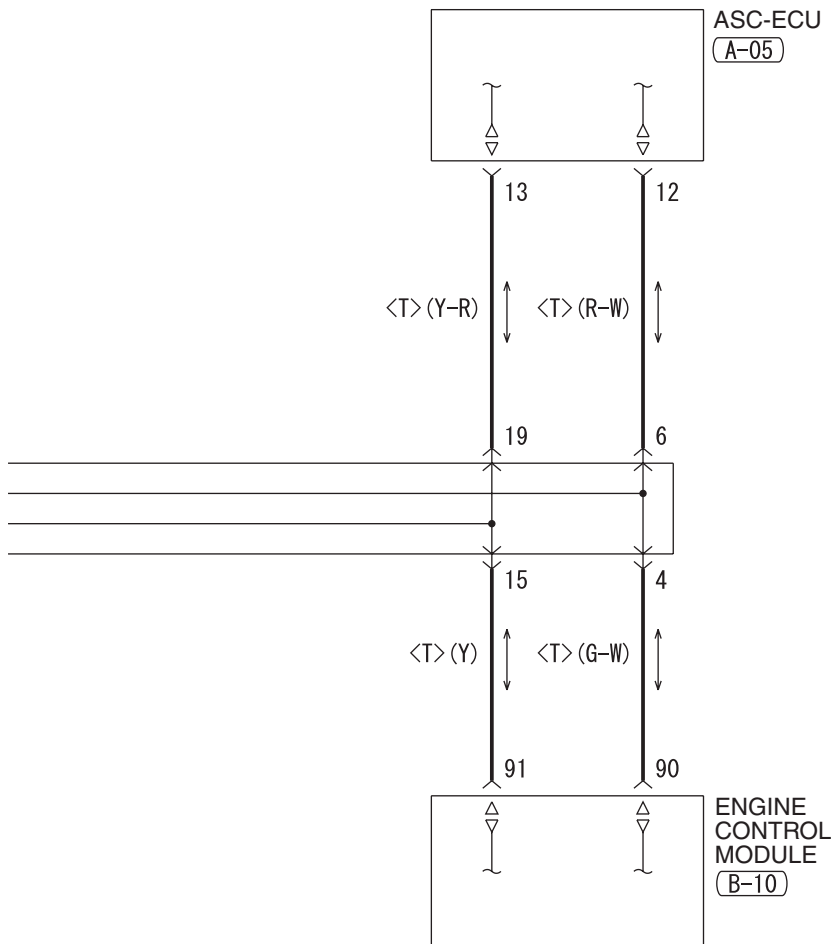

(C-46)

JAE-E												
1	2	3	4	5	6	7	8	9	10	11	12	13
14	15	16	17	18	19	20	21	22	23	24	25	26

(C-104)

1	2	3	4	5	6	7	8	9	10	11		
12	13	14	15	16	17	18	19	20	21	22	23	24

(C-127)

1	2	3	4	5	6	7	8	9	10	11		
12	13	14	15	16	17	18	19	20	21	22	23	24

(C-131)

1	2	3	4	5	6	7	8	9				
10	11	12	13	14	15	16	17	18	19	20	21	22

(C-209)

MU801545				
1	2	3	4	5

WIRE COLOR CODE

B : BLACK LG : LIGHT GREEN G : GREEN L : BLUE W : WHITE Y : YELLOW SB : SKY BLUE
 BR : BROWN O : ORANGE GR : GRAY R : RED P : PINK V : VIOLET PU : PURPLE SI : SILVER

CONTROLLER AREA NETWORK (CAN) <TC-SST>

M1901004000602

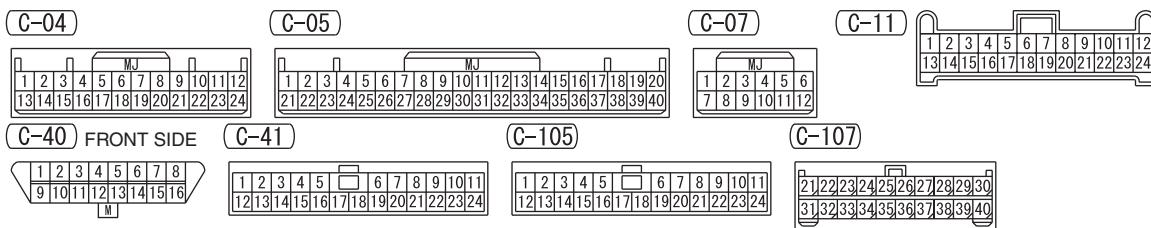
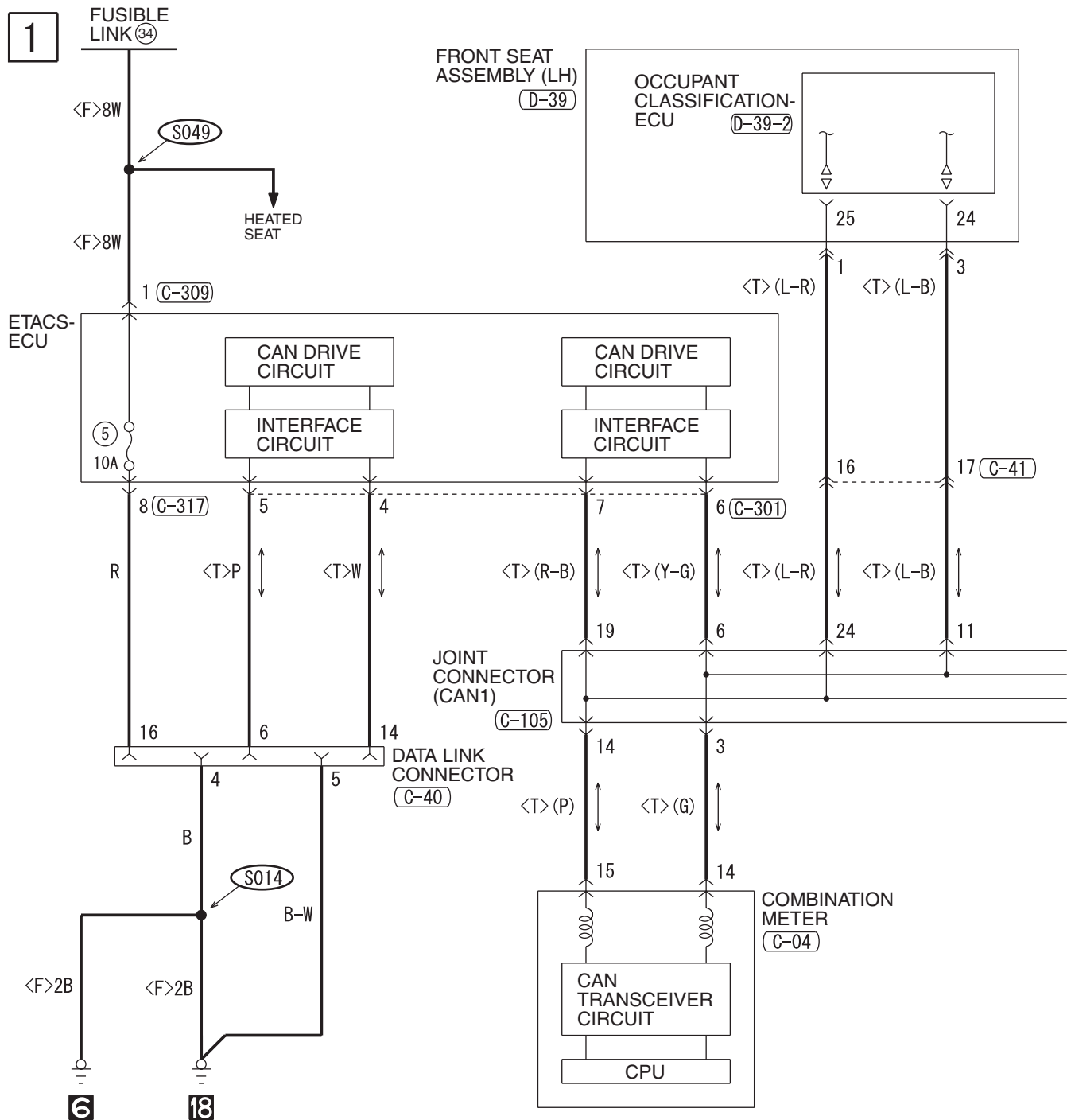

H8G15M56AA

2

NOTE
 *1 : VEHICLES WITHOUT KOS
 *2 : VEHICLES WITH KOS
 *3 : VEHICLES WITHOUT MMCS
 *4 : VEHICLES WITH MMCS

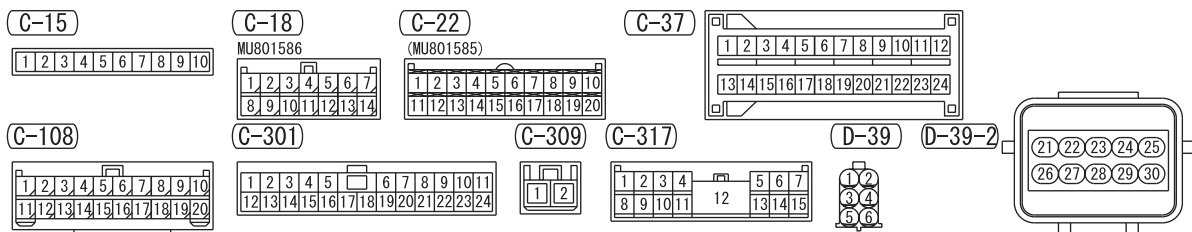
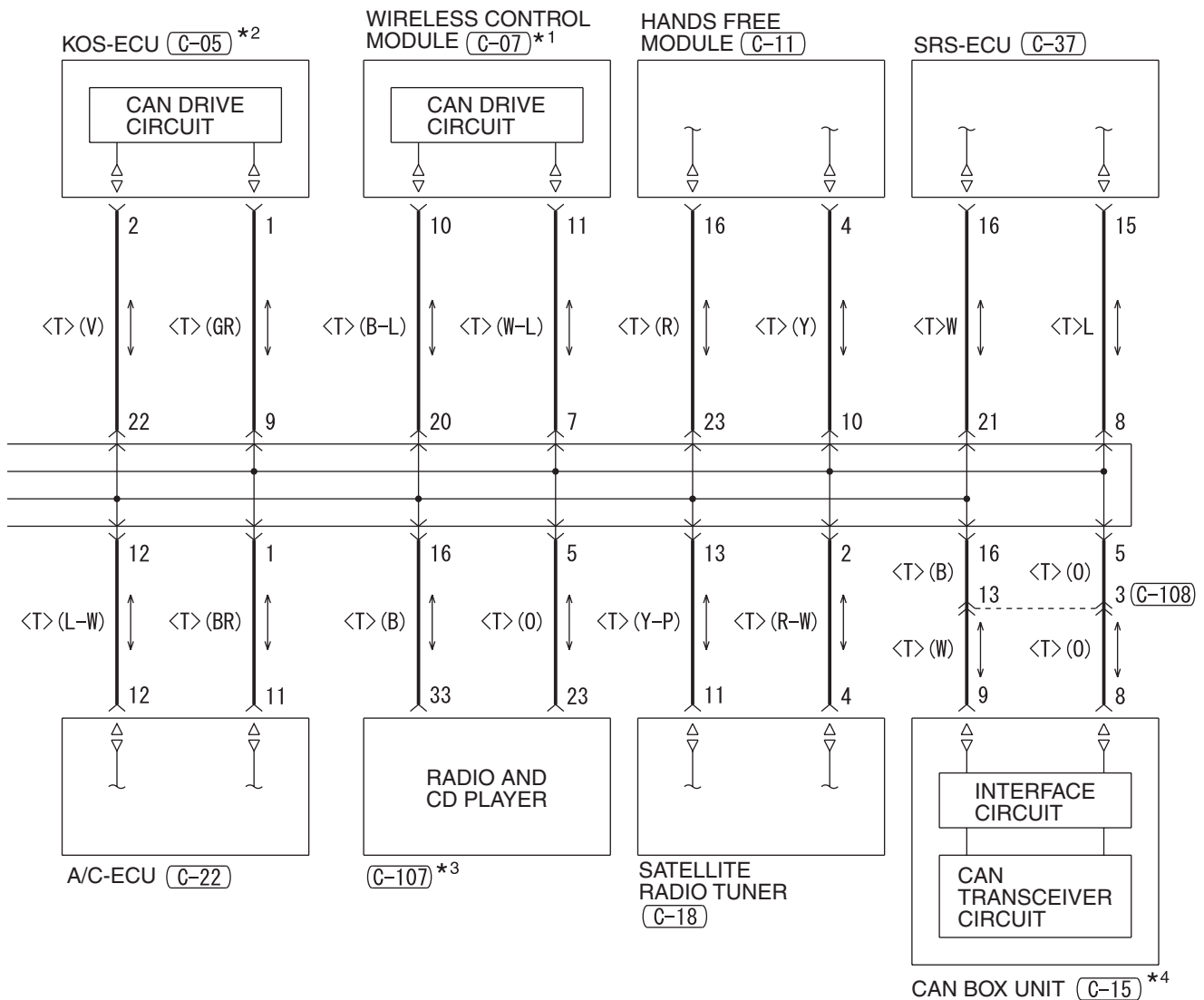

H8G15M56AB

CONTROLLER AREA NETWORK (CAN) <TC-SST> (CONTINUED)

3

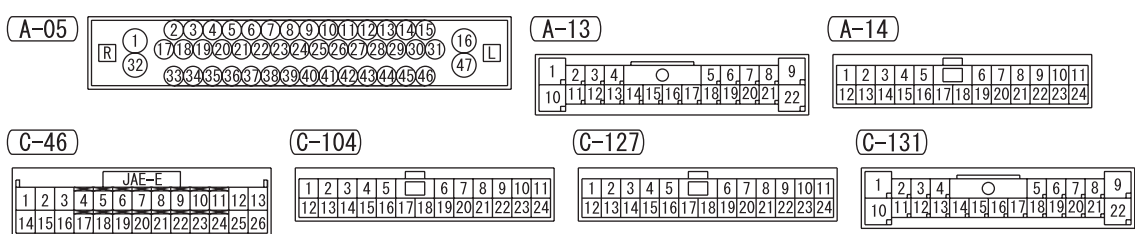
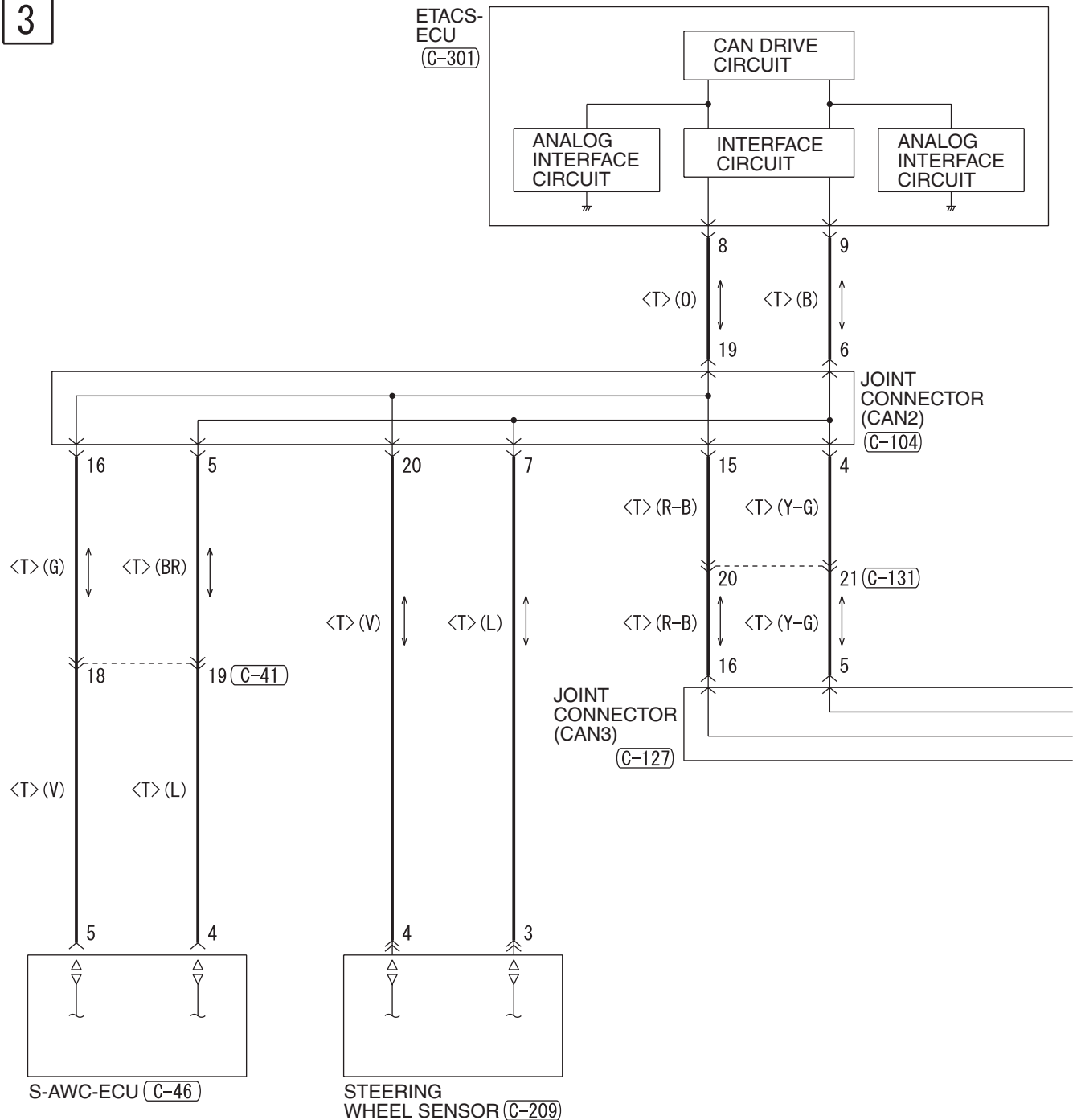

NOTE
 * : THE TERMINAL NUMBERS DESCRIBED
 IN THE CIRCUIT DIAGRAM AGREE WITH
 THE NUMBERS MADE ON THE
 TRANSAXLE ASSEMBLY CONNECTOR AND
 HARNESS SIDE CONNECTOR.

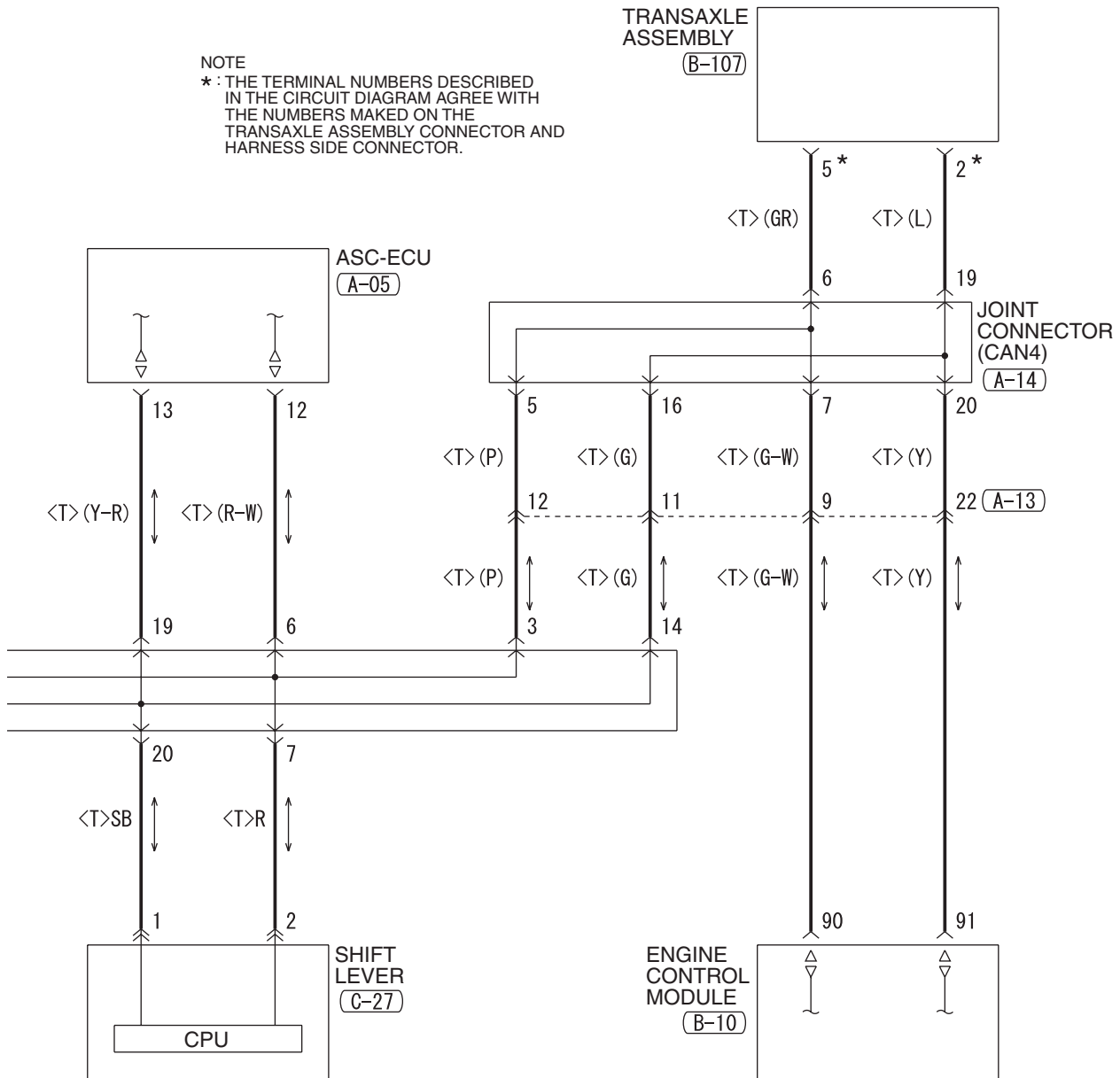

(B-10)

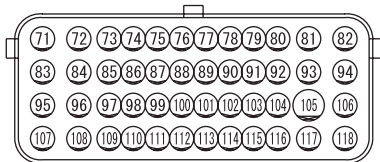

(B-107)*



(C-27)

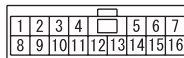

(C-41)

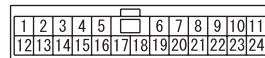

(C-209)



(C-301)

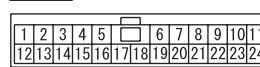

NOTES