

## GROUP 90

## CIRCUIT DIAGRAMS

## CONTENTS

HOW TO READ CIRCUIT DIAGRAMS	90-4	TWIN CLUTCH-SPORTRONIC SHIFT TRANSMISSION (TC-SST).....	90-82
ETACS-ECU.....	90-10	HEADLIGHT <HALOGEN TYPE> ...	90-90
JOINT CONNECTOR.....	90-14	HEADLIGHT <DISCHARGE TYPE> .	90-98
CENTRALIZED JUNCTION.....	90-20	HEADLIGHT LEVELING SYSTEM... .	90-106
POWER DISTRIBUTION SYSTEM ..	90-28	DAYTIME RUNNING LIGHT (DRL) <HALOGEN TYPE> .....	90-110
STARTING SYSTEM <M/T> .....	90-36	DAYTIME RUNNING LIGHT (DRL) <DISCHARGE TYPE> .....	90-114
STARTING SYSTEM <TC-SST> ....	90-38	FOG LIGHT.....	90-118
IGNITION SYSTEM .....	90-40	TAILLIGHT, POSITION LIGHT, LICENSE PLATE LIGHT AND LIGHTING MONITOR TONE ALARM.....	90-120
CHARGING SYSTEM <M/T>.....	90-44	DOMELIGHT, LUGGAGE COMPARTMENT LIGHT AND IGNITION KEY HOLE ILLUMINATION LIGHT.....	90-126
CHARGING SYSTEM <TC-SST> ...	90-48	TURN-SIGNAL LIGHT AND HAZARD WARNING LIGHT.....	90-134
MFI SYSTEM <M/T> .....	90-52		
MFI SYSTEM <TC-SST>.....	90-64		
COOLING SYSTEM.....	90-76		
SHIFT LOCK MECHANISM.....	90-80		

Continued on next page

BACKUP LIGHT <M/T> . . . . .	90-138	REAR WINDOW DEFOGGER . . . . .	90-222
BACKUP LIGHT <TC-SST> . . . . .	90-140	HEATED DOOR MIRROR . . . . .	90-224
STOPLIGHT . . . . .	90-142	AUDIO SYSTEM <VEHICLES WITHOUT AUDIO AMPLIFIER> . . . . .	90-226
HORN . . . . .	90-143	AUDIO SYSTEM <VEHICLES WITH AUDIO AMPLIFIER> . . . . .	90-232
METER AND GAUGE <M/T> . . . . .	90-144	MITSUBISHI MULTI-COMMUNICATION SYSTEM (MMCS) . . . . .	90-244
METER AND GAUGE <TC-SST> . . . . .	90-148	SPARE CONNECTOR (FOR AUDIO) . . . . .	90-256
BRAKE WARNING LIGHT, FUEL WARNING LIGHT AND OIL PRESSURE WARNING LIGHT <M/T> . . . . .	90-152	SPARE CONNECTOR (FOR NAVIGATION SYSTEM) . . . . .	90-262
BRAKE WARNING LIGHT, FUEL WARNING LIGHT AND OIL PRESSURE WARNING LIGHT <TC-SST> . . . . .	90-156	ACCESSORY SOCKET AND CIGARETTE LIGHTER . . . . .	90-264
POWER WINDOWS . . . . .	90-160	ABS, ASC, ACD, AYC AND S-AWC <M/T> . . . . .	90-266
CENTRAL DOOR LOCKING SYSTEM . . . . .	90-166	ABS, ASC, ACD, AYC AND S-AWC <TC-SST> . . . . .	90-276
KEYLESS OPERATING SYSTEM (KOS) . . . . .	90-178	SUPPLEMENTAL RESTRAINT SYSTEM (SRS) . . . . .	90-288
TRUNK LID OPENER . . . . .	90-188	CRUISE CONTROL SYSTEM <M/T> . . . . .	90-298
HEATER <VEHICLES WITHOUT AIR CONDITIONING SYSTEM> . . . . .	90-194	CRUISE CONTROL SYSTEM <TC-SST> . . . . .	90-304
AIR CONDITIONING SYSTEM . . . . .	90-204		
WINDSHIELD WIPER AND WASHER . . . . .	90-216		
REMOTE CONTROLLED MIRROR . . . . .	90-220		

Continued on next page

TIRE PRESSURE MONITORING SYSTEM (TPMS) <M/T> . . . . .	90-312	IGNITION KEY REMINDER TONE ALARM <VEHICLES WITH KOS> . . .	90-358
TIRE PRESSURE MONITORING SYSTEM (TPMS) <TC-SST> . . . . .	90-318	SEAT BELT WARNING TONE ALARM . . . . .	90-362
IMMOBILIZER SYSTEM <M/T> . . . . .	90-326	DOOR AJAR WARNING TONE ALARM . . . . .	90-366
IMMOBILIZER SYSTEM <TC-SST> .	90-330	PARKING BRAKE REMINDER TONE ALARM . . . . .	90-370
SUNROOF . . . . .	90-334	THEFT-ALARM SYSTEM . . . . .	90-374
HEATED SEAT . . . . .	90-338	CONTROLLER AREA NETWORK (CAN) <M/T> . . . . .	90-384
HANDS-FREE CELLULAR PHONE SYSTEM . . . . .	90-344	CONTROLLER AREA NETWORK (CAN) <TC-SST> . . . . .	90-388
IGNITION KEY REMINDER TONE ALARM <VEHICLES WITHOUT KOS> . . . . .	90-356		

# HOW TO READ CIRCUIT DIAGRAMS

M1901000100919

The circuit of each system from the fuse (or fusible link) to ground is shown. The power supply is shown at the top and the ground at the bottom to facilitate understanding of how the current flows. Some variations are included in one circuit diagram. Accordingly, some diagrams may not be applicable for individual vehicles. The circuit diagrams show the state when switches are operated.

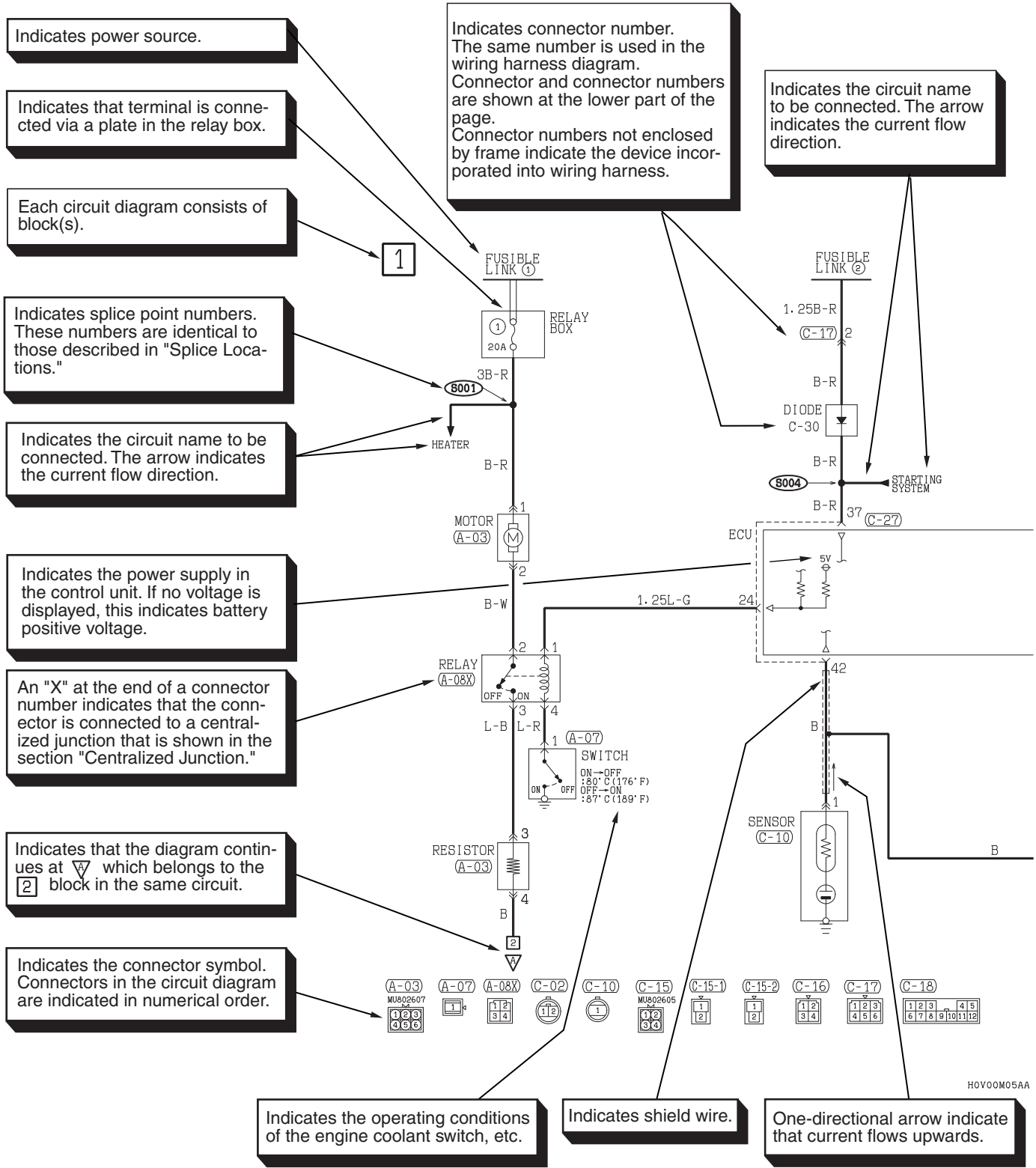

H0V00M05AA

AC106603AG



Indicates input/output to/from control unit (current flow direction).

Input    Output    Input/output

Indicates a wiring connector which is inside the equipment and which is not shown in the wiring harness configuration diagram.

Example C-15-2    Indicates a connector which is inside the equipment, numbered in order starting from 1.

Indicates the connector number shown in the wiring harness configuration diagram.

Indicates that the diagram comes from ▽ which belongs to the 1 block in the same circuit.

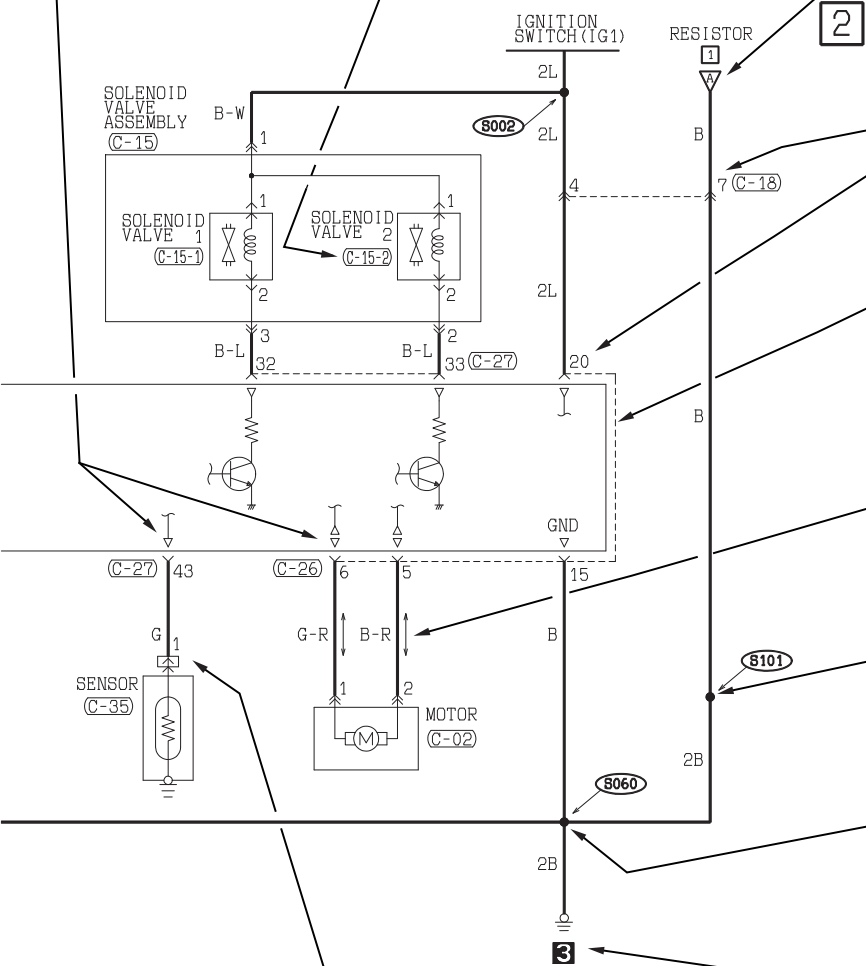

Indicates terminal number.

In case two or more connectors are connected to the same device, markings indicating the same connector is connected by a broken line.

Bi-directional arrow indicates that current flows in both directions due to control by an ECU.

Indicates harness junction where wire diameter or color changes.

+ Indicates intersections at which the lead wires are not connected.

+ Indicates intersections at which the lead wires are connected.

Indicates representative vehicle body ground point. (Same number as that of ground point in GROUNDING LOCATION).

(C-26) (MU801823)

1	2	3	4	5	6	7	8	9	10	11
12	13	14	15	16	17	18	19	20	21	22

(C-27) (MU801822)

31	32	33	34	35	36	37	38
39	40	41	42	43	44	45	46

(C-35)

1
---





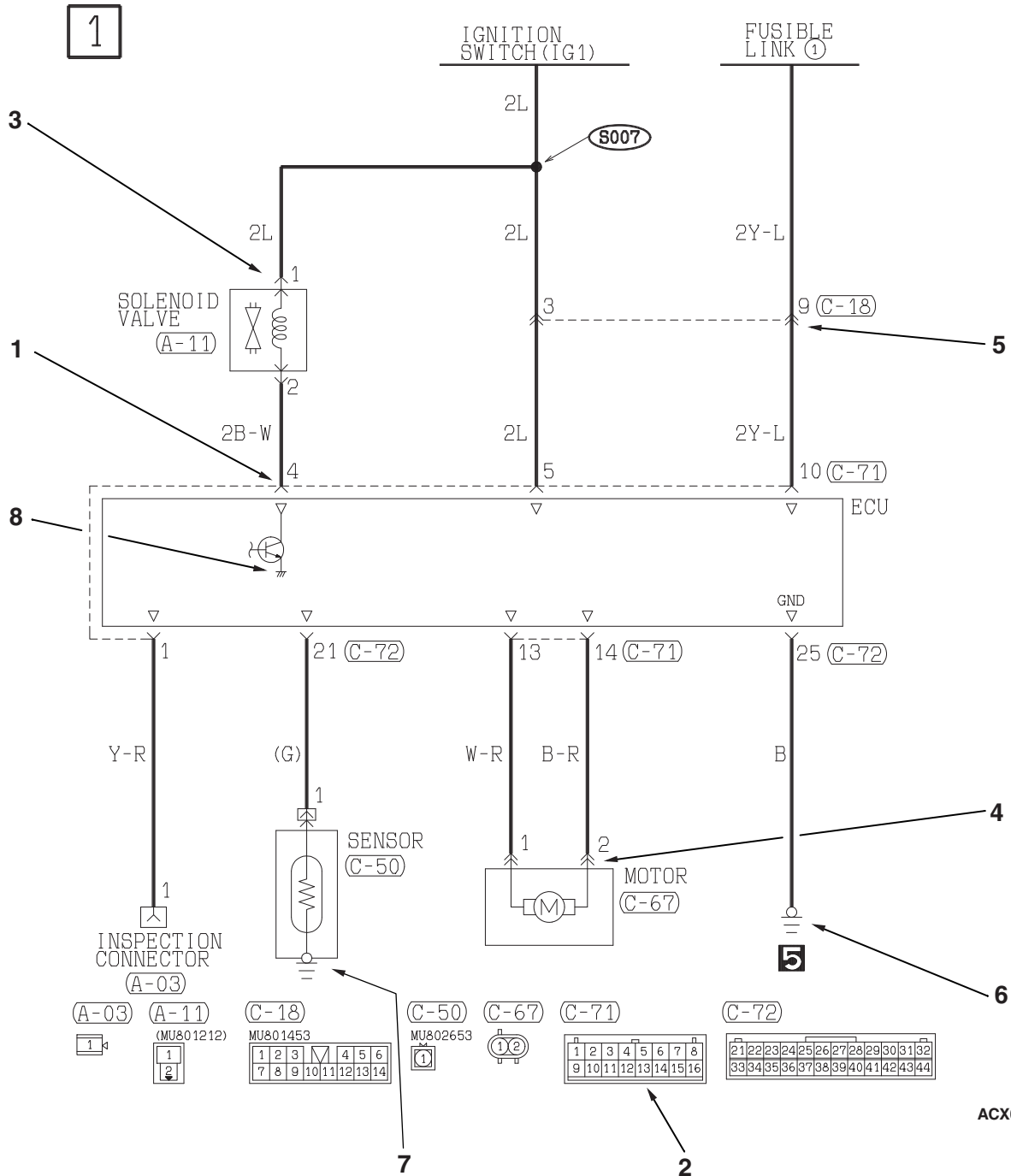

Indicates that the terminal is a spare one if the device (sensor in this case) is not provided.



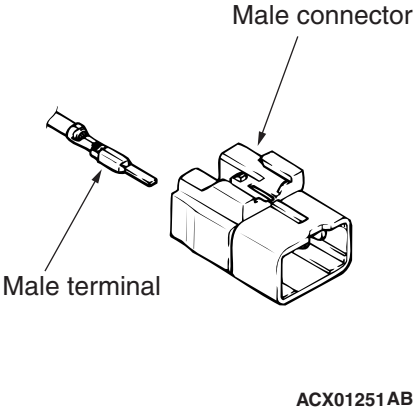

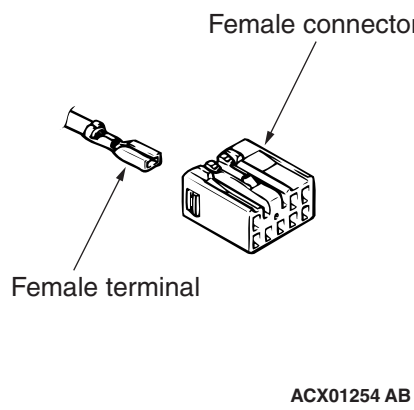
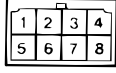
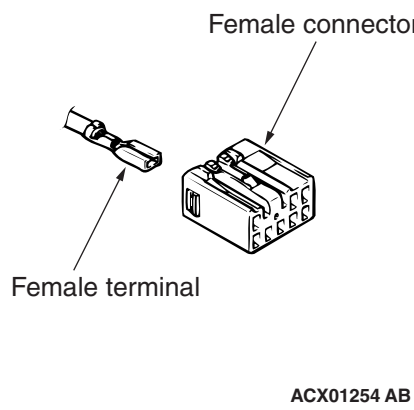

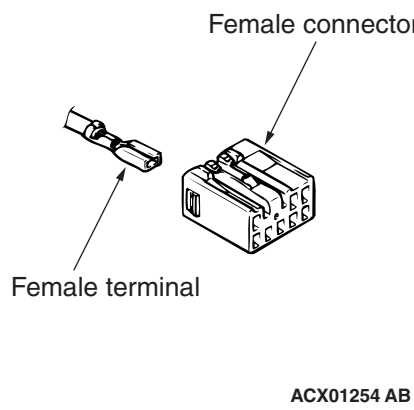
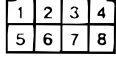
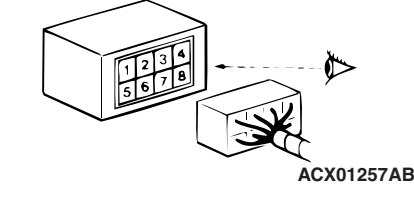
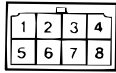
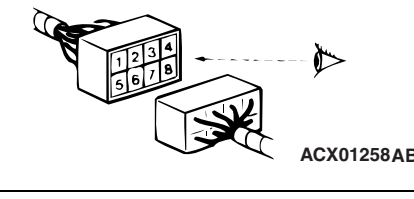

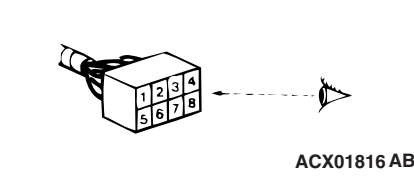
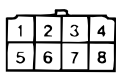
H0V00M05AB

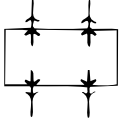
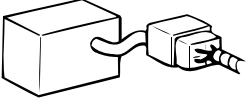
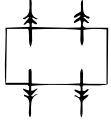
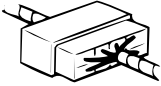
CONNECTOR/GROUNDING INDICATIONS

























ACX02364 AC

Item	No.	Connector/ Grounding	Symbol	Contents
Connector and terminal marking	1		<p>Male terminal</p>  <p>ACX01252 AB</p>	The male and female terminals are indicated as shown. The connector with male terminal(s) is called as male connector and indicated by two connector contour lines, while the connector with female terminal(s) is called as female connector and indicated by single connector contour line.
			<p>Male connector</p>  <p>ACX01253 AB</p>	
			<p>Female terminal</p>  <p>ACX01255 AB</p>	
			<p>Female connector</p>  <p>ACX01256 AB</p>	
Connector symbol marking	2	<p>Device</p> 	 <p>ACX01253</p>	The symbol indicates the connector is viewed as shown. At a device connection, the connector symbol on the device side is shown. For an intermediate connector, the male connector symbol is shown. For spare connectors and check connectors, no device is connected, and so the harness-side connector symbol is shown for these connectors. However, a data link connector is exceptional.
		<p>Intermediate connector</p> 	 <p>ACX01256</p>	
		<p>Spare connector, check connector</p> 	 <p>ACX01256</p>	

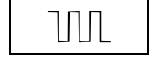
Item	No.	Connector/ Grounding	Symbol	Contents
Connector connection marking	3	Direct connection type   ACX01260 AB	 ACX01261	Connection between a device and the harness is either by direct insertion in the device (direct connection type) or by connection with a harness connector furnished on the device side (harness connection type). The two types are indicated as illustrated.
	4	Harness connection type   ACX01262 AB	 ACX01263	
	5	Intermediate connector   ACX01264 AB	 ACX01265	
Ground marking	6	Body ground   ACX01273 AB	 ACX01274	Grounding is either by body ground, device ground or control unit interior ground. These are indicated as illustrated.
	7	Device ground   ACX01275 AB	 ACX01276	
	8	Ground in control unit   ACX01277 AB	 ACX01278	

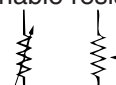
## SYMBOLS (EXCEPT CONNECTOR AND GROUNDING)

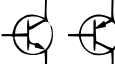
Devices appearing in circuit diagrams are indicated by the following symbols.

<p>Battery</p>  <p>ACX02377 AB</p>	<p>Buzzer</p>  <p>ACX02378 AB</p>	<p>Capacitor</p>  <p>ACX02379 AB</p>	<p>Electrolytic capacitor</p>  <p>ACX02380 AB</p>	<p>Variable capacitor</p>  <p>ACX02381 AB</p>	<p>Coil</p>  <p>ACX02382 AB</p>
<p>Diode</p>  <p>ACX02383 AB</p>	<p>Light emitting diode</p>  <p>ACX02384 AB</p>	<p>Photo diode</p>  <p>ACX02385 AB</p>	<p>Zener diode</p>  <p>ACX02386 AB</p>	<p>Dual filament bulb</p>  <p>ACX02387 AC</p>	<p>Single filament bulb</p>  <p>ACX02388 AC</p>
<p>Fuse</p>  <p>ACX02389 AB</p>	<p>Fusible link</p>  <p>ACX02390 AB</p>	<p>Horn</p>  <p>ACX02391 AB</p>	<p>Motor</p>  <p>ACX02392 AB</p>	<p>Pulse generator</p>  <p>ACX02393 AB</p>	<p>Piezoelectric device</p>  <p>ACX02394 AB</p>
<p>Resistor</p>  <p>ACX02395 AB</p>	<p>Variable resistor</p>  <p>ACX02396 AB</p>	<p>Speaker</p>  <p>ACX02397 AB</p>	<p>Thermistor</p>  <p>ACX02398 AB</p>	<p>Transistor</p>  <p>ACX02399 AB</p>	<p>Photo transistor</p>  <p>ACX02400 AB</p>

## WIRE COLOR CODES

Wire colors are identified by the following color codes.

Code	Wire color	Code	Wire color	Code	Wire color	Code	Wire color
B	Black	L	Blue	PU	Purple	V	Violet
BR	Brown	LG	Light green	R	Red	W	White
G	Green	O	Orange	SB	Sky blue	Y	Yellow
GR	Gray	P	Pink	SI	Silver	-	-

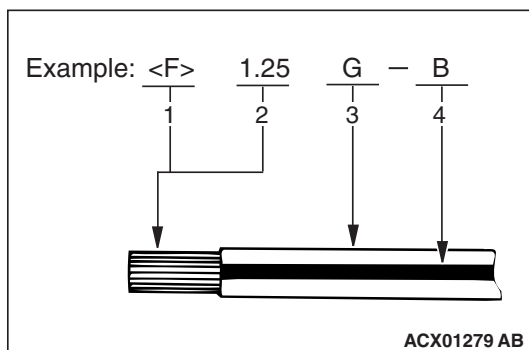

If a cable has two colors, the first of the two color code characters indicates the basic color (color of the cable coating) and the second indicates the marking (tracer) color.

No.	Meaning
1	<F>: Flexible wire <T>: Twisted wire
2	Wire size (mm <sup>2</sup> )*
3	Basic color (color of the cable coating)
4	Marking color

**NOTE:**

\*: No code indicates 0.5 mm<sup>2</sup> (0.0008 in<sup>2</sup>). Cable color code in parentheses indicates 0.3 mm<sup>2</sup> (0.0005 in<sup>2</sup>).

ETACS-ECU

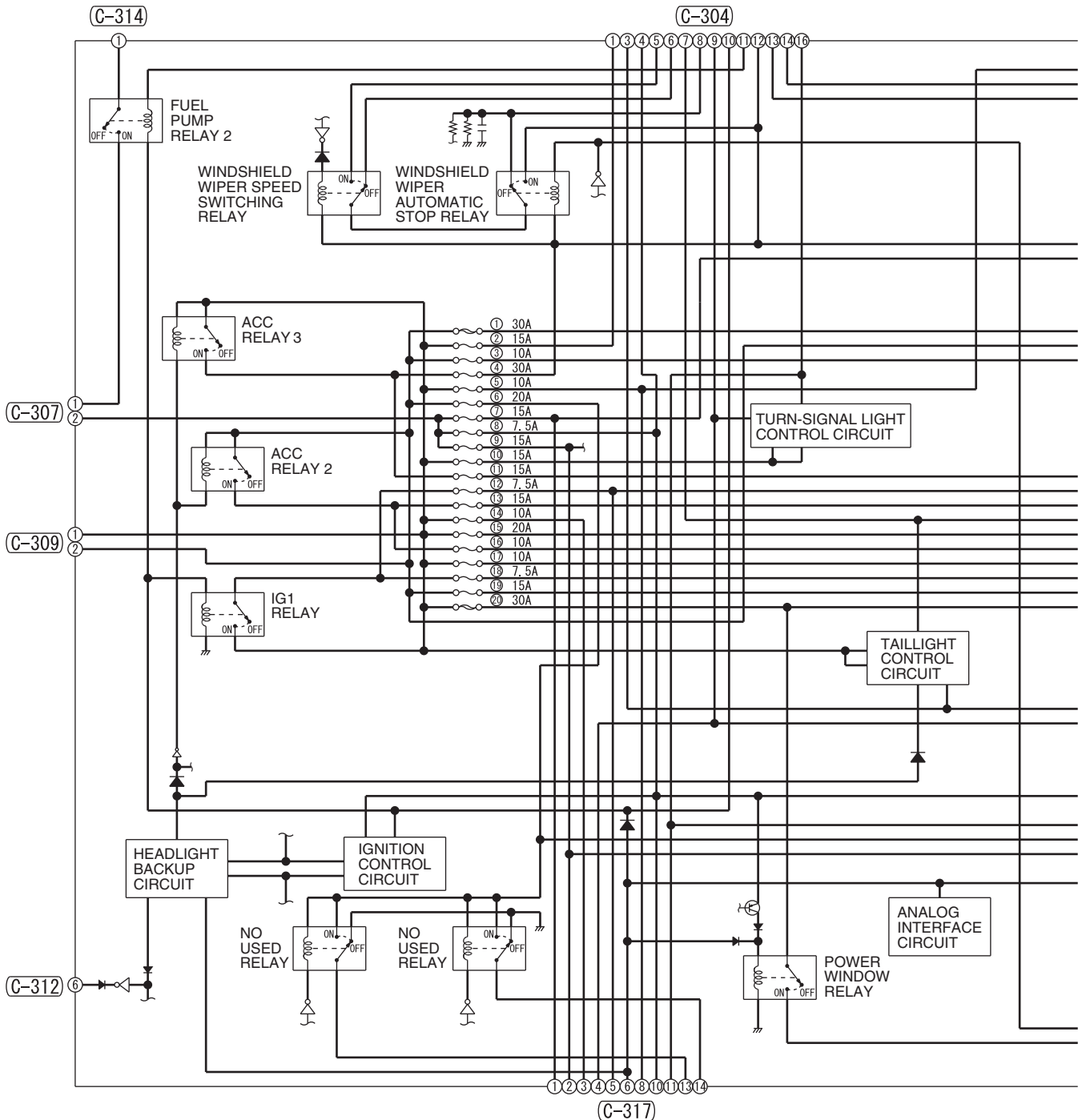

(C-301)

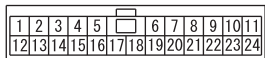

(C-302)



(C-303)



(C-304)

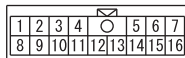

(C-307)



(C-309)



(C-310)



(C-311)

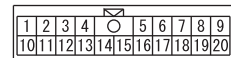

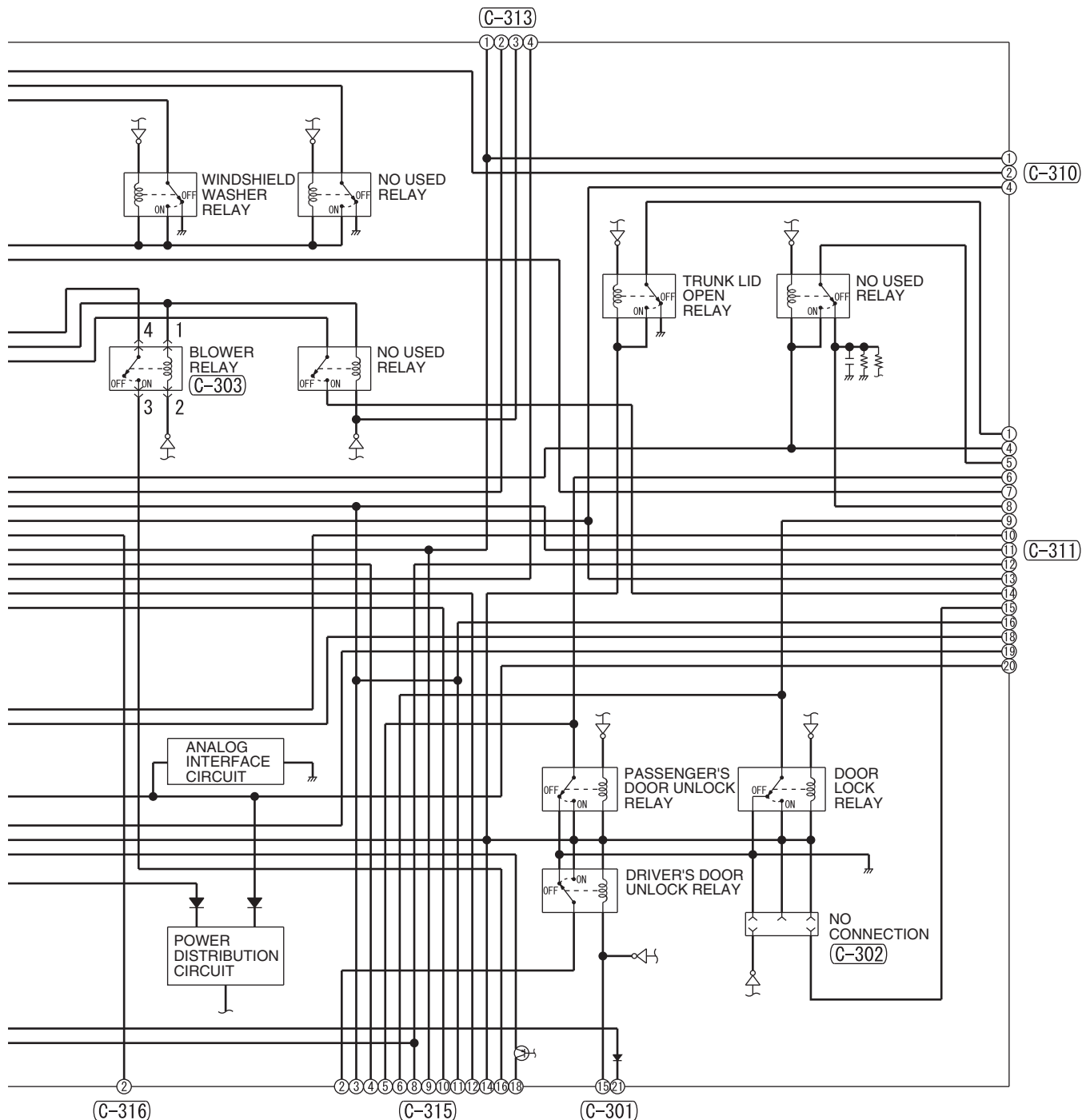

(C-312)

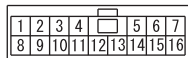

(C-313)

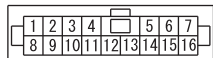

(C-314)



(C-315)

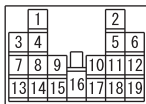

(C-316)



(C-317)

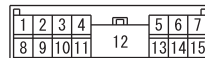

ETACS-ECU (CONTINUED)

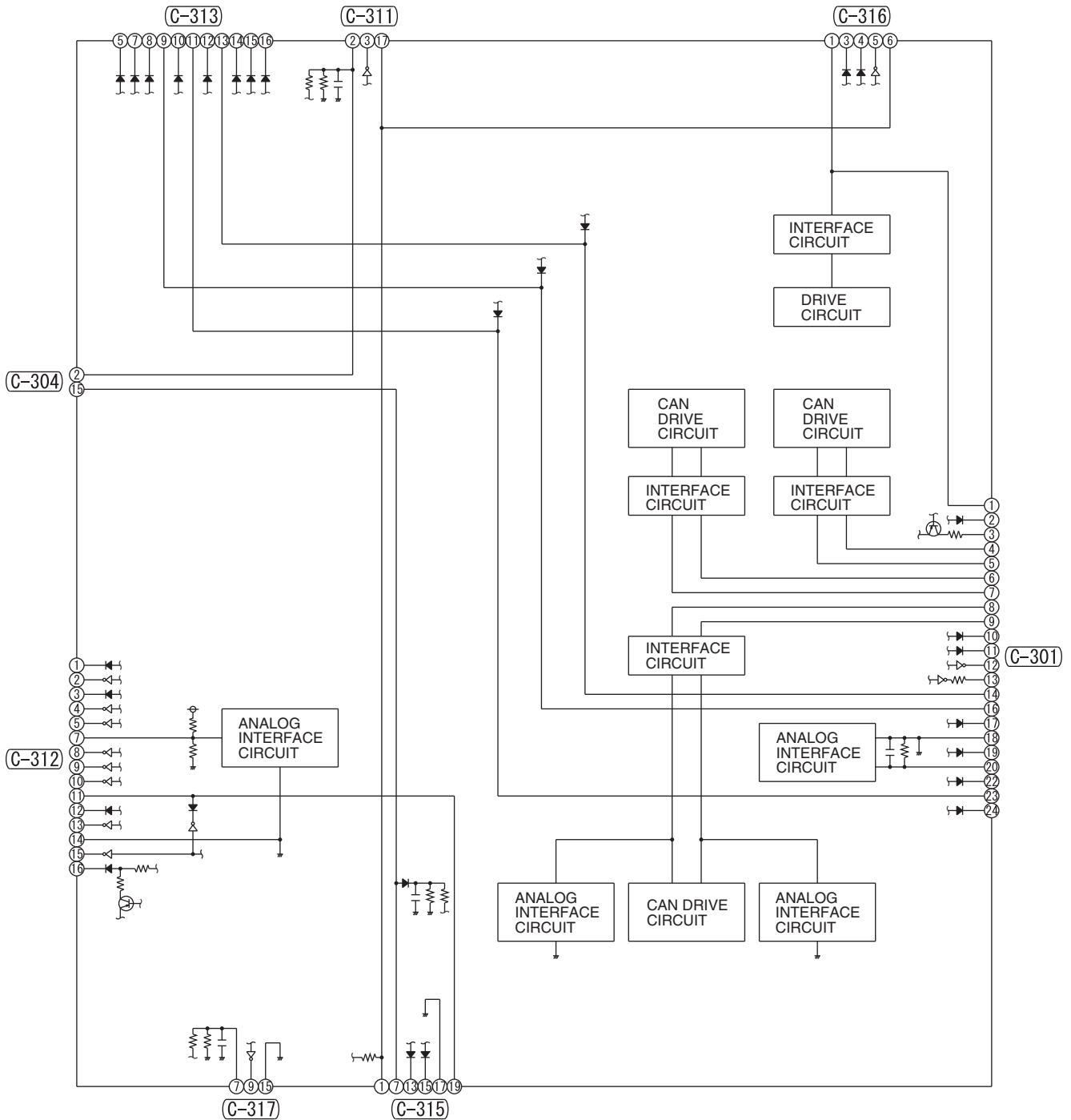

(C-301)

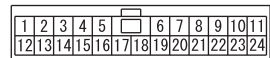

(C-304)

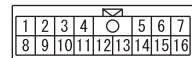

(C-311)

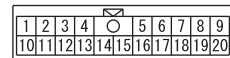

(C-312)

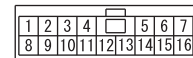

(C-313)

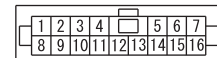

(C-315)



(C-316)



(C-317)

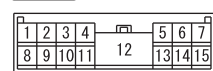



**UPPER VIEW**

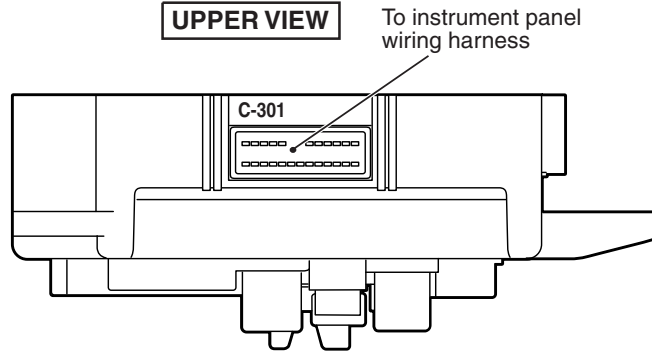

**FRONT VIEW**

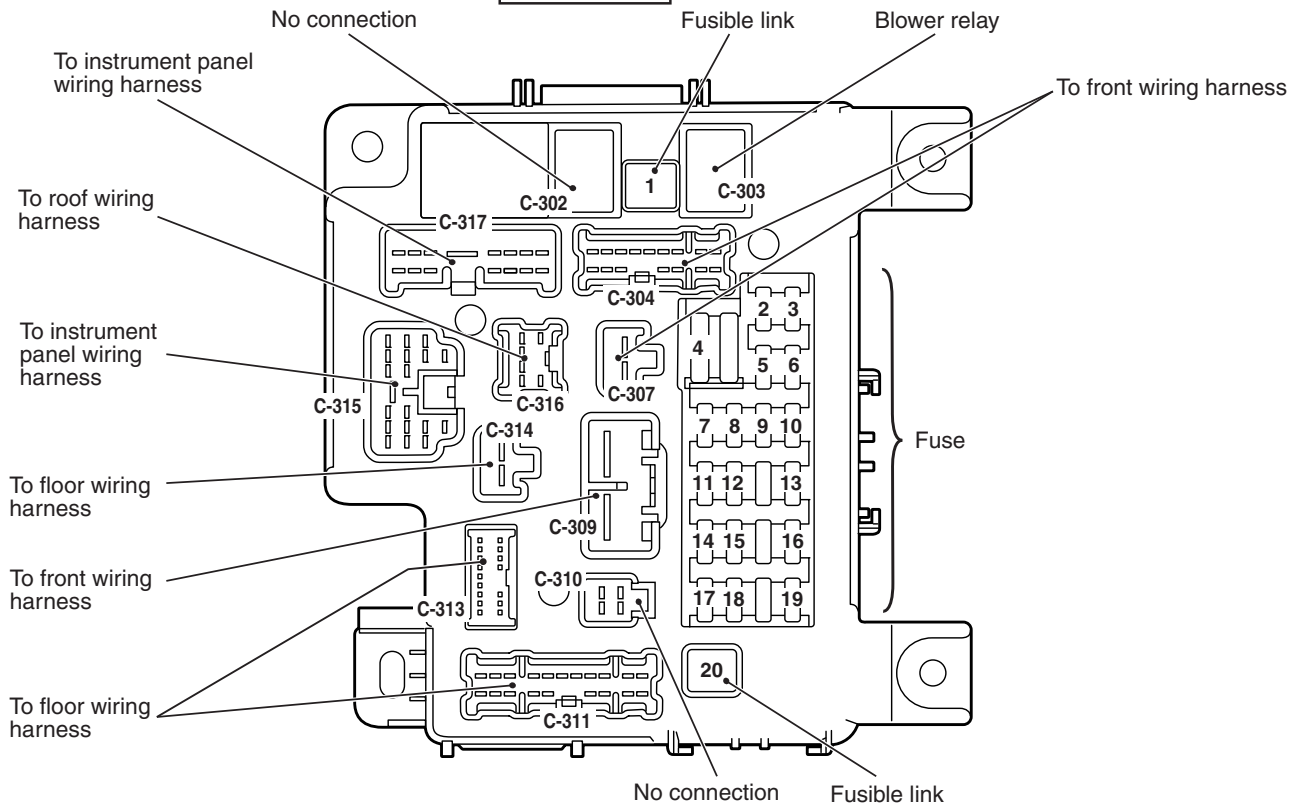

**LOWER VIEW**

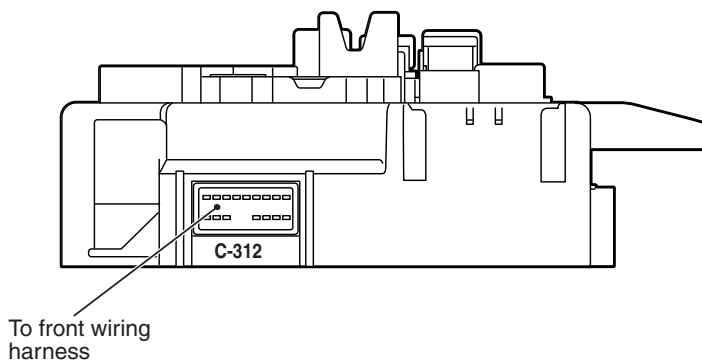

# JOINT CONNECTOR

M1901014204535

**NOTE:**

IN THE ACTUAL VEHICLES, SOME OF THE JOINT CONNECTOR TERMINALS IN THE SAME BUS ARE USED, SO IN SOME CASES, THE TERMINAL ARRANGEMENT INDICATED ON THE CIRCUIT DIAGRAMS DOES NOT AGREE WITH THE ONES IN THE ACTUAL VEHICLES.

HOWEVER, ON JOINT CONNECTOR (CAN1, 2, 3, 4), THE TERMINAL NUMBERS INDICATED ON THE CIRCUIT DIAGRAMS SHOULD ALWAYS AGREE WITH THE TERMINAL ARRANGEMENT IN THE ACTUAL VEHICLES.

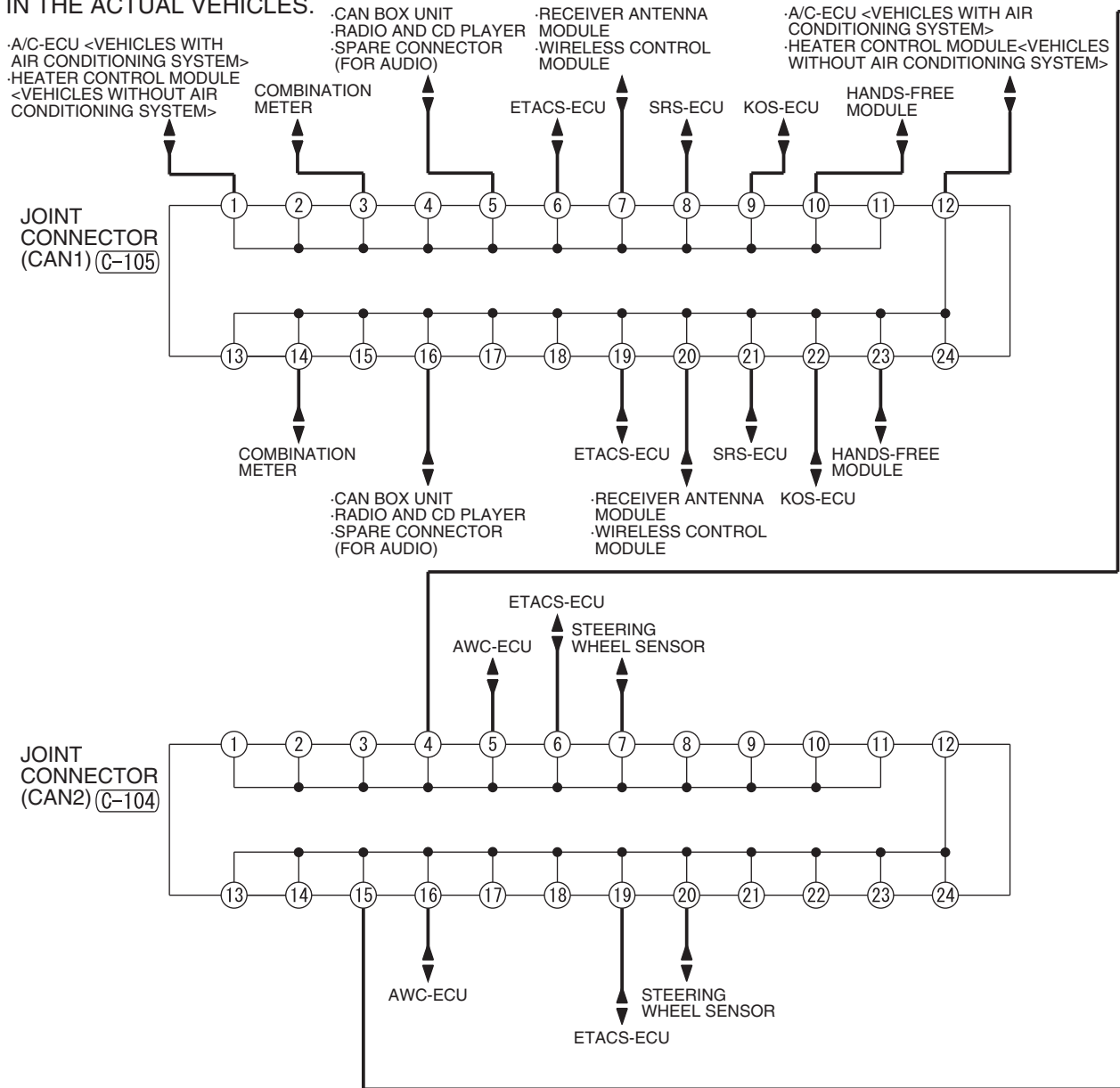

(A-14)

(C-104)

(C-105)

(C-127)

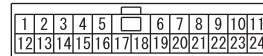
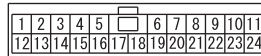
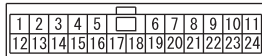
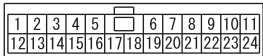

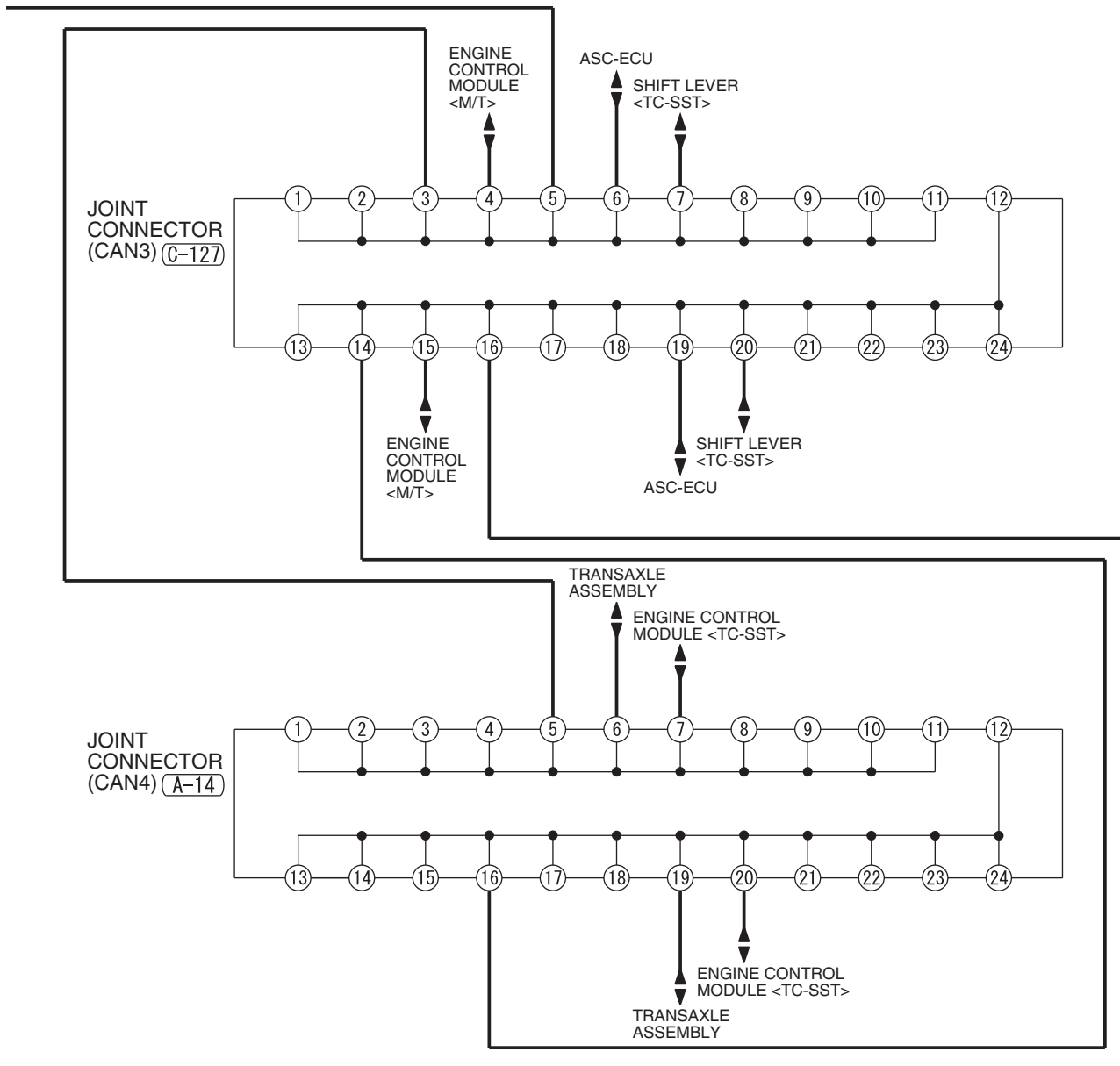

JOINT CONNECTOR (CONTINUED)

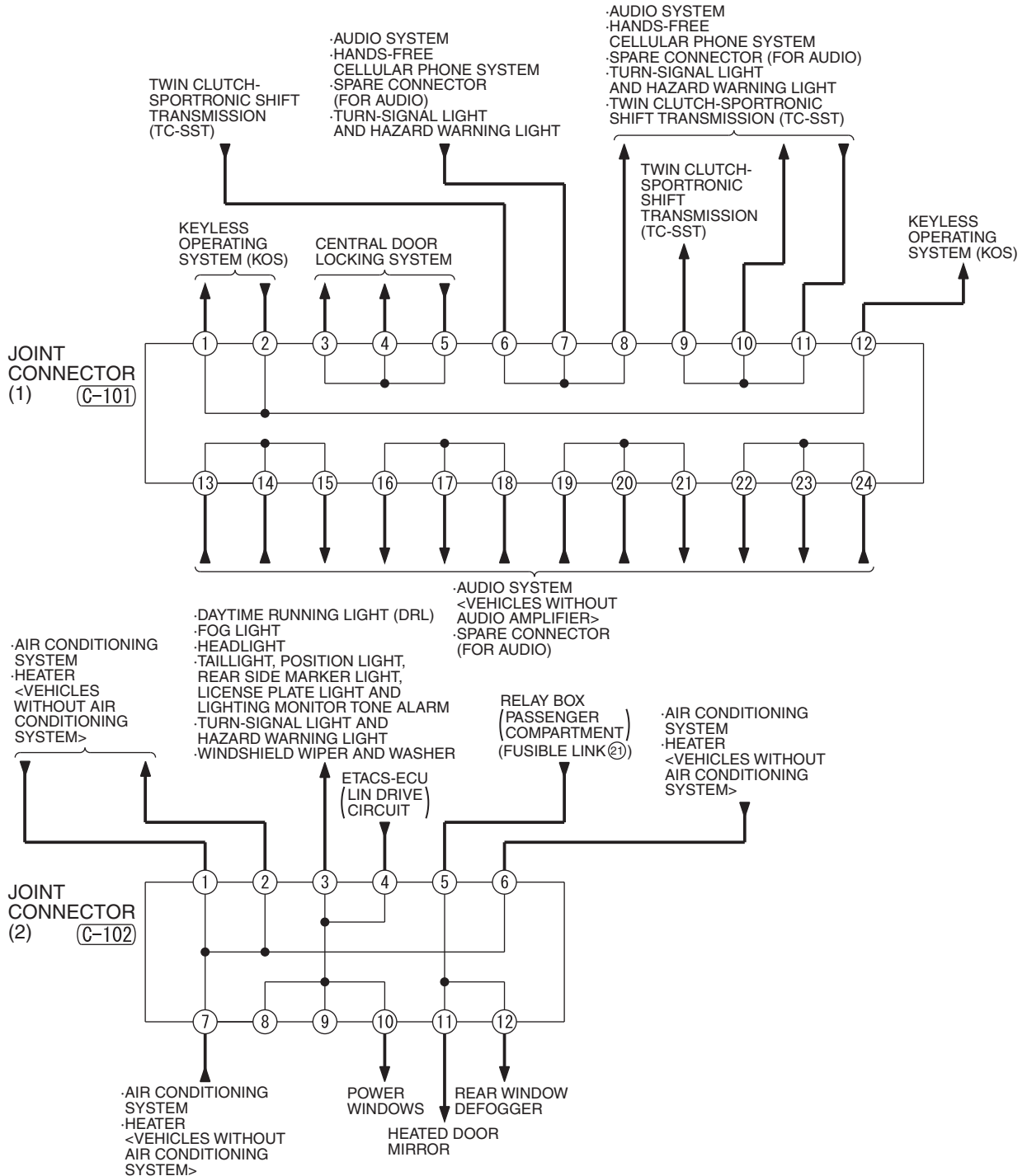

C-43

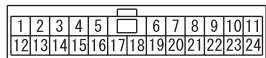

C-101

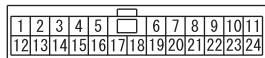

C-102

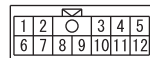

C-103

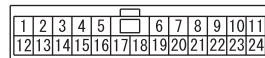

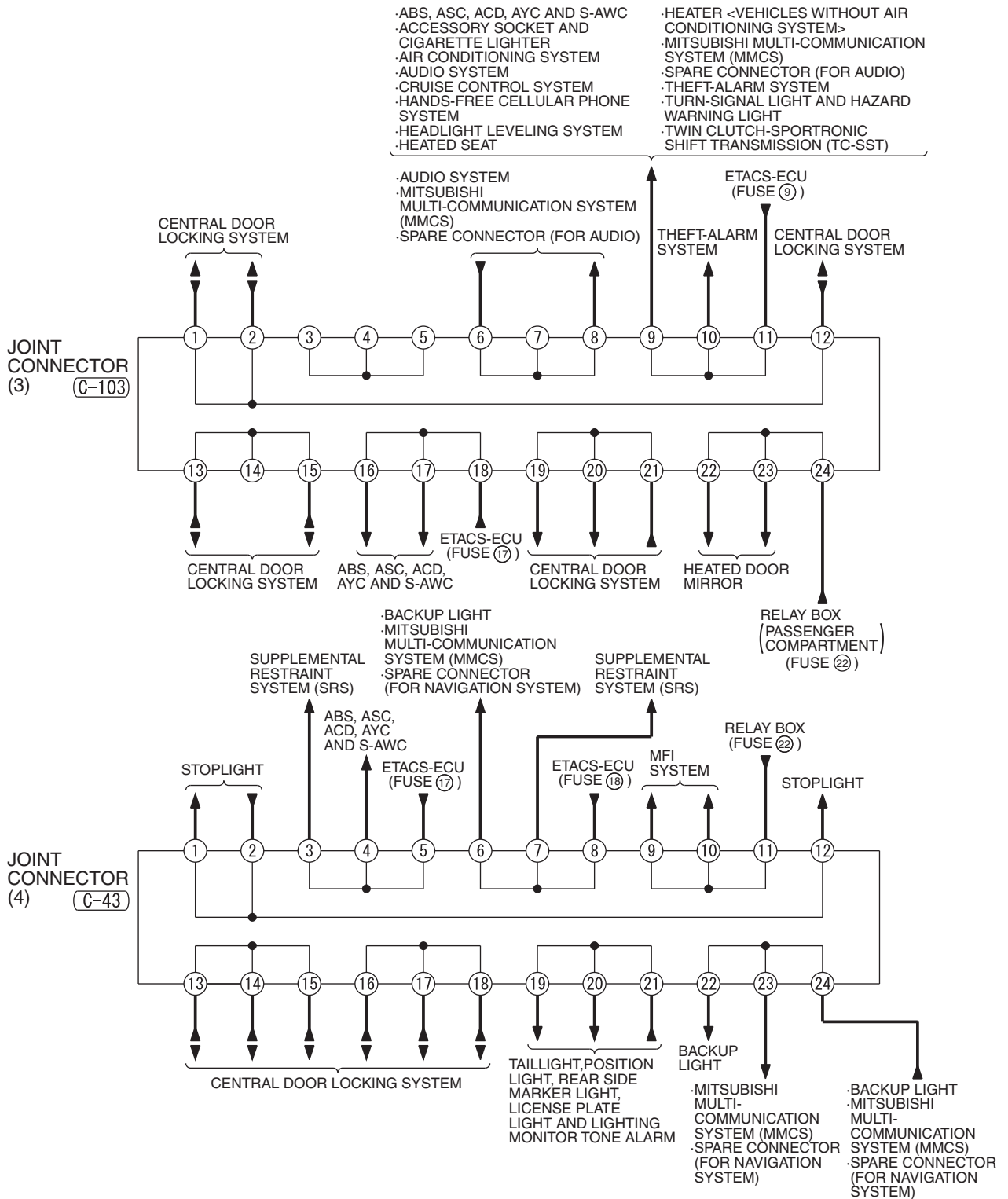

JOINT CONNECTOR (CONTINUED)

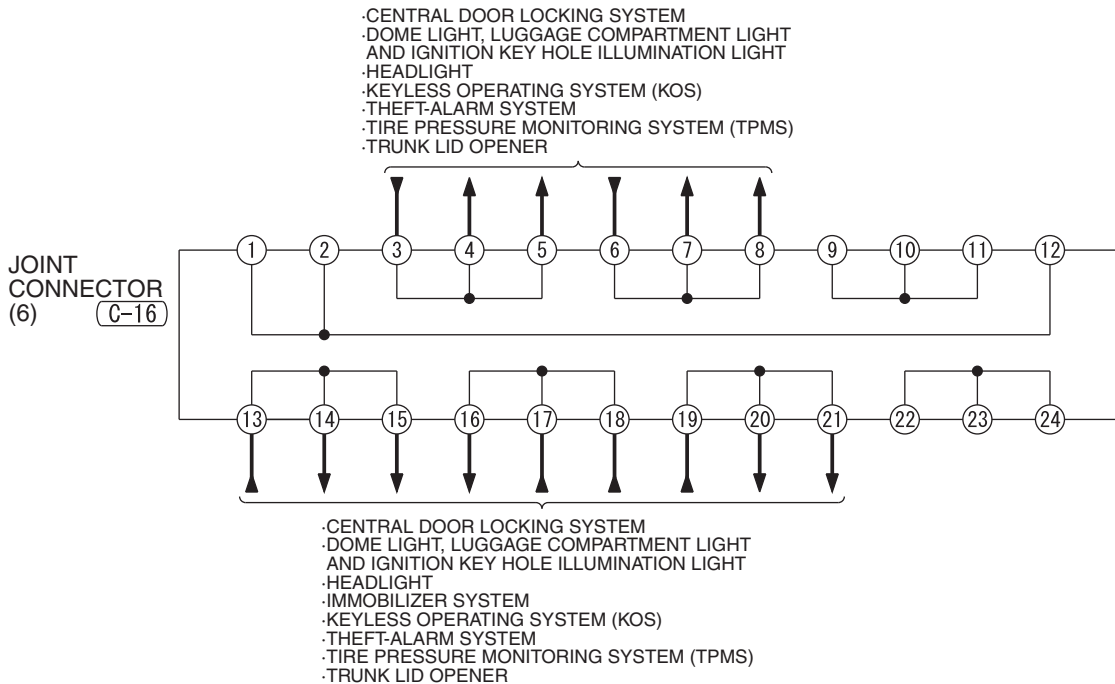
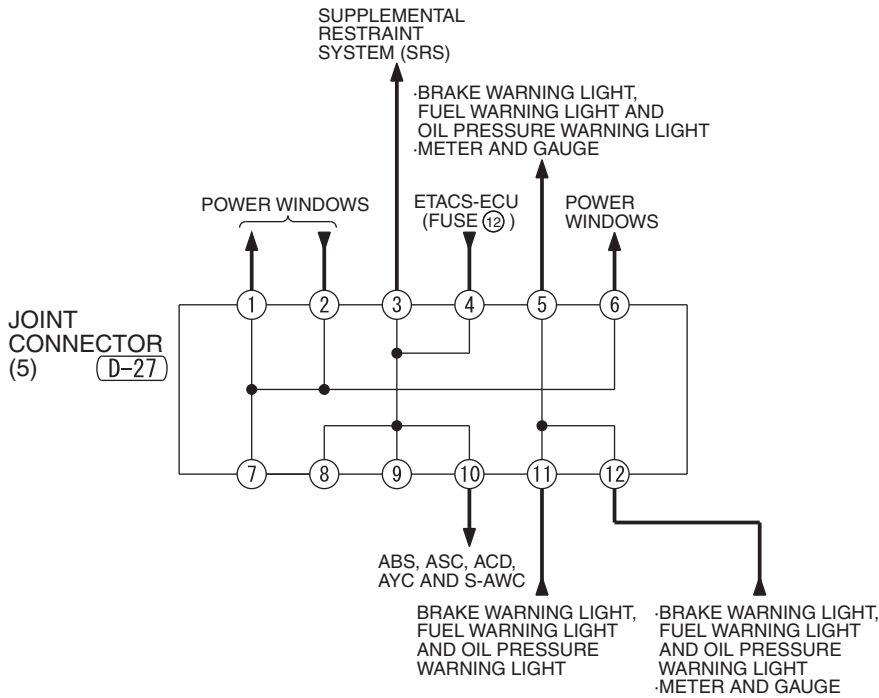

(C-16)

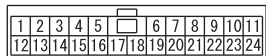

(C-50)

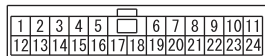

(D-27)

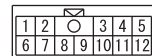

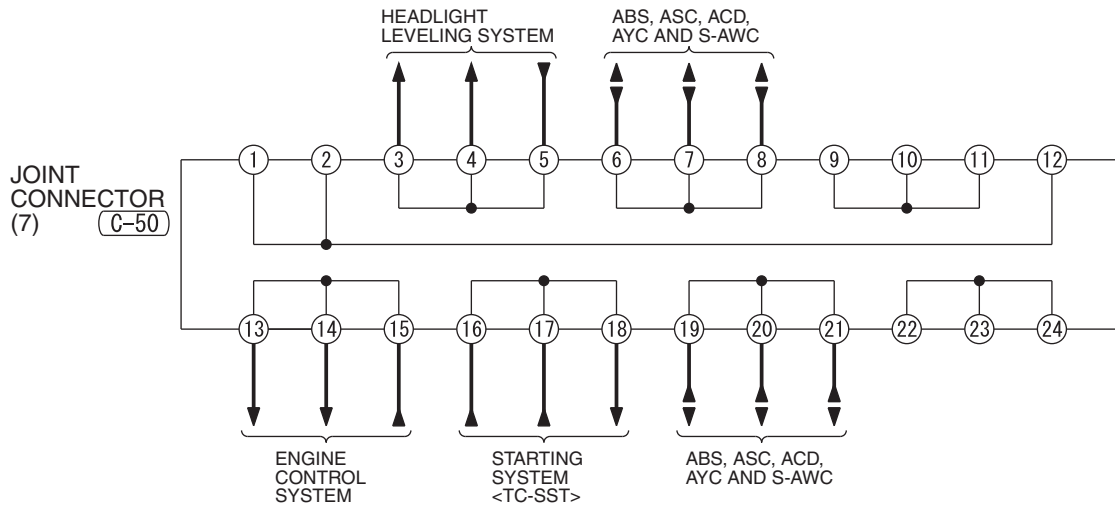

## CENTRALIZED JUNCTION

M1901000303343

## FUSIBLE LINK AND FUSE

## ENGINE COMPARTMENT

No.	Power supply circuit	Name	Rated capacity (A)	Housing color	Load circuit
1	Fusible link No.36	Fuse	15	Blue	Fog light and fog light relay
2			7.5	Brown	Engine control module
3			20	Yellow	Shift lever <TC-SST> and transaxle assembly <TC-SST>
4			10	Red	Horn (Low, High) and horn relay
5			7.5	Brown	Generator
6			–	–	–
7			10	Red	A/C compressor clutch assembly and A/C compressor clutch relay
8			15	Blue	Engine control module
9			20	Yellow	Theft-alarm horn and theft-alarm horn relay
10			–	–	–
11			–	–	–
12			–	–	–
13			10	Red	Daytime running light relay and headlight assembly (LH, RH)
14	Headlight relay (High)		10	Red	Headlight assembly (LH)
15			10	Red	Headlight assembly (RH)
16	Headlight relay (Low)		20	Yellow	Headlight assembly (LH) <Discharge type>
17			20	Yellow	Headlight assembly (RH) <Discharge type>
18			10	Red	Headlight assembly (LH, RH) and headlight leveling switch
19			10	Red	Headlight assembly (RH) <Halogen type>
20			–	–	–
21	MFI relay		10	Red	Ignition coil Nos.1 to 4
22			20	Yellow	Engine control module, evaporative emission purge solenoid, exhaust oil feeder control valve, heated oxygen sensor (Front, rear), injector Nos.1 to 4, intake oil feeder control valve, mass airflow sensor, throttle actuator control motor relay and turbocharger wastegate solenoid No.1 and 2
23			20	Yellow	Fuel pump module, fuel pump relay 1 and fuel pump circuit resistor



No.	Power supply circuit	Name	Rated capacity (A)	Housing color	Load circuit
24	Fusible link No.36	Fusible link	30	Pink	Starter
25			–	–	–
26			40	Green	ASC-ECU
27			30	Pink	ASC-ECU
28			30	Pink	Condenser fan motor, condenser fan relay and fan control relay
29			40	Green	Radiator fan motor and radiator fan relay
30		Fuse	30	Green	Fuse Nos.7 to 9 in passenger compartment
31			30	Green	Audio amplifier
32			MFI relay	–	–
33	Battery/Generator	Fusible link	140	–	Fusible link No.37/ Fusible link No.34 to 36
34	Battery/Fusible link No.33		80	–	ACC relay 3 in ETACS-ECU, fuse No.2, 4, 5, 10, 11, 12, 14, 15, 17, 18, 25 and fusible link No.20 in passenger compartment and ETACS-ECU
35			80	–	Electric pump
36			120	–	Fuse No.1 to 5, 7 to 9, 13 to 23, 30, 31 and fusible link No.24, 26 to 29 in engine compartment, MFI relay and headlight relay (High, Low)
37	Fusible link No.33/ Generator		80	–	ACC relay 2 in ETACS-ECU, fusible link No.1 and 21, Fuse No. 3, 6, 13, 16 in passenger compartment, ETACS-ECU and blower relay

Relay box in engine compartment

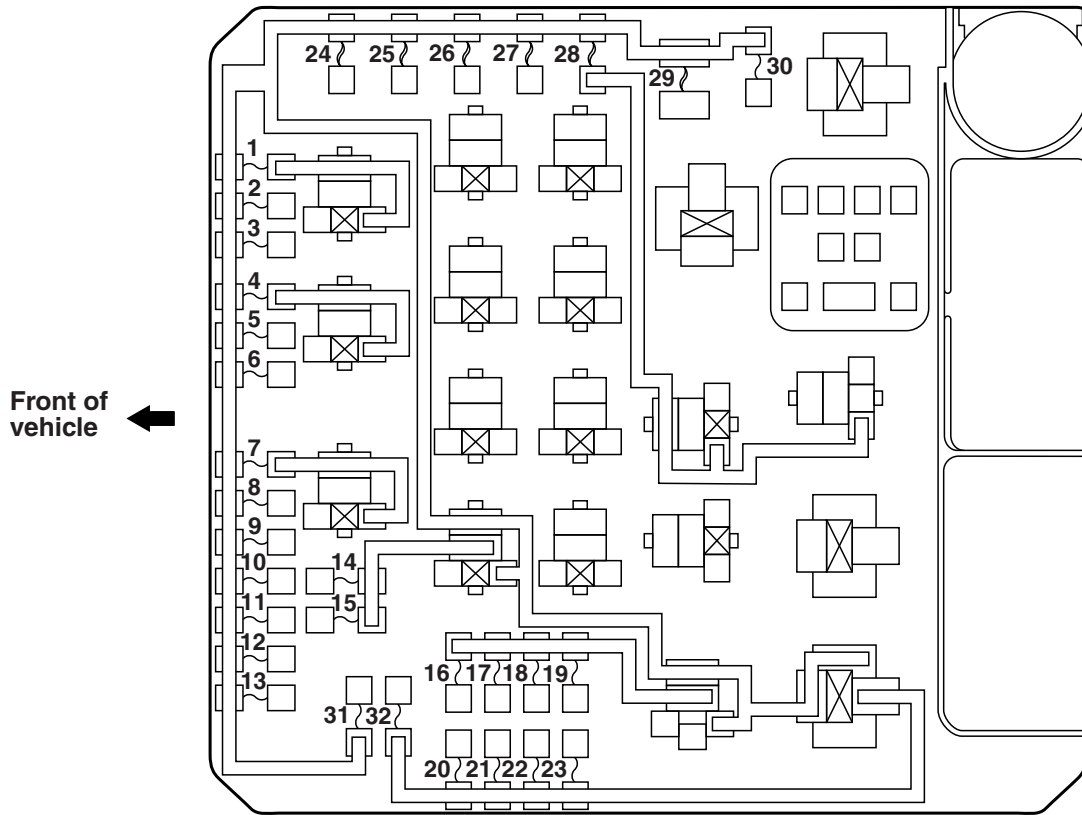

AC609168AT

Fusible link box in engine compartment

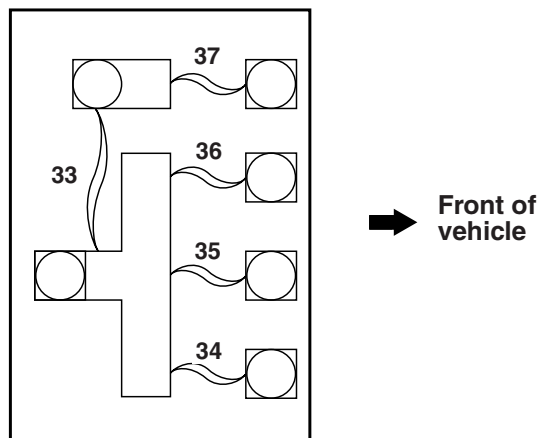

AC506810AJ

**PASSENGER COMPARTMENT**

<b>No.</b>	<b>Power supply circuit</b>	<b>Name</b>	<b>Rated capacity (A)</b>	<b>Housing color</b>	<b>Load circuit</b>
1	Fusible link No.37	Fusible link	30	Pink	Blower motor
2	Fusible link No.34	Fuse	15	Blue	ETACS-ECU, high-mounted stoplight, rear combination light (LH, RH) and shift lever <TC-SST>
3	Fusible link No.37		10	Red	–
4	ETACS-ECU (ACC relay 3)		30	Green	Windshield wiper automatic stop relay, windshield wiper motor and windshield wiper speed switching relay in ETACS-ECU, washer motor and windshield washer relay
5	Fusible link No.34		10	Red	Data link connector
6	Fusible link No.37		20	Yellow	Door lock relay, driver's door unlock relay, passenger's door unlock relay and trunk lid open relay in ETACS-ECU, front door lock actuator (LH, RH), rear door lock actuator (LH, RH) and trunk lid latch
7	Fusible link No.30		15	Blue	CAN box unit, center panel unit, hands free module, multivision display, radio/CD player, satellite radio tuner and spare connector (for navigation unit)
8			7.5	Brown	A/C-ECU <Vehicles with air conditioning system>, column switch, combination meter, ETACS-ECU, heater control module <Vehicles without air conditioning system>, key reminder switch <Vehicles with KOS>, KOS-ECU, lighting control sensor, power window relay in ETACS-ECU, AWC-ECU and wireless control module
9			15	Blue	Center panel unit, combination meter and key reminder switch <Vehicles without KOS>
10	Fusible link No.34		15	Blue	ETACS-ECU
11	ETACS-ECU (ACC relay 3)		15	Blue	–

No.	Power supply circuit	Name	Rated capacity (A)	Housing color	Load circuit	
12	ETACS-ECU (IG1 relay)	Fuse	7.5	Brown	A/C-ECU <Vehicles with air conditioning system>, A/C control panel <Vehicles with air conditioning system>, center panel unit, column switch, combination meter, heater control module <Vehicles without air conditioning system>, heater control panel <Vehicles without air conditioning system>, heated seat relay, KOS-ECU, rear window defogger relay, receiver antenna module <Vehicles with KOS>, AWC-ECU, shift lever <TC-SST>, SRS-ECU, steering wheel sensor, sunroof motor assembly, transaxle assembly <TC-SST> and wireless control module <Vehicles without KOS>	
13	ETACS-ECU (ACC relay 2)		15	Blue	Accessory socket and cigarette lighter	
14	Fusible link No.34		10	Red	Fuel pump relay 2, IG1 relay, power window relay in ETACS-ECU, ETACS-ECU, engine control module and injector relay	
15			20	Yellow	Sunroof motor assembly	
16	ETACS-ECU (ACC relay 2)		10	Red	CAN box unit, multivision display, radio/CD player, door mirror assembly (LH, RH) and shift lever <TC-SST>	
17	Fusible link No.34		10	Red	ASC-ECU, front seat assembly (LH) and AWC-ECU	
18	ETACS-ECU (IG1 relay)		7.5	Brown	Backup light (LH, RH), ETACS-ECU, multivision display, shift lever <TC-SST>, spare connector (for navigation unit) and SRS-ECU	
19	Fusible link No.37		15	Blue	–	
20	Fusible link No.34		Fusible link	30	Pink	Front power window sub switch, power window main switch and rear power window motor (LH, RH)
21	Fusible link No.37			30	Pink	Fuse No.22 in passenger compartment and rear window defogger
22	Rear window defogger relay		Fuse	7.5	Brown	Door mirror assembly
23	Fusible link No.34			–	–	–
24				–	–	–
25		30		Green	Heated seat assembly (LH, RH) and heated seat switch	

Fuse box in ETACS-ECU

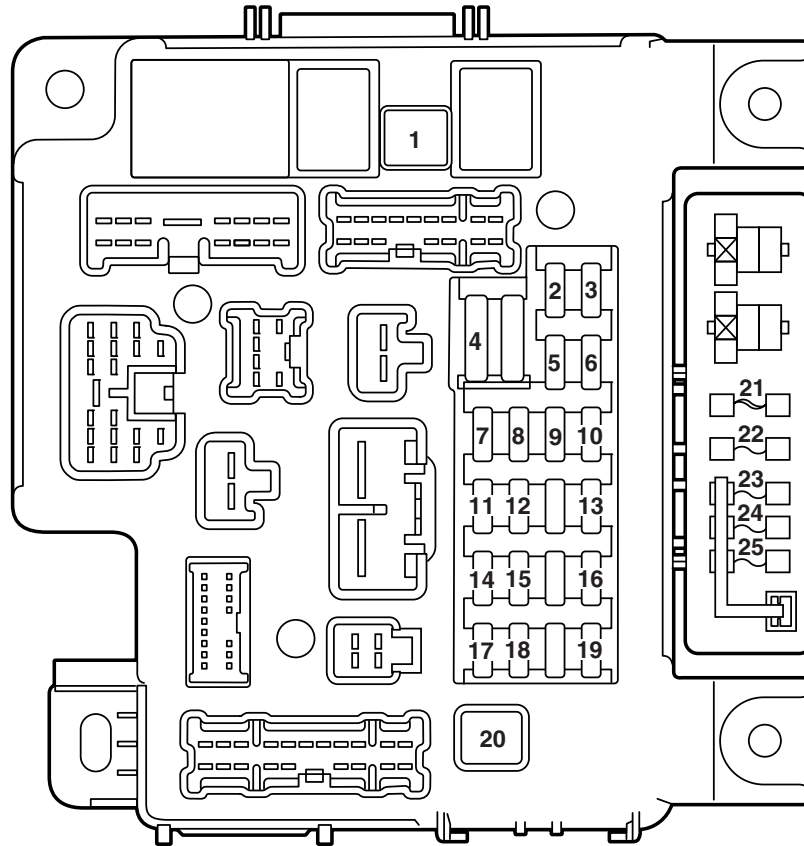

AC607380AC

## CENTRALIZED RELAY

Connector No.	Name	Connector No.	Name
A-15X	Fog light relay	A-27X	Fuel pump relay 1
A-16X	Horn relay	A-28X	Starter relay
A-17X	A/C compressor clutch relay	A-29X	Headlight relay (Low)
A-18X	Theft-alarm horn relay	A-30X	-
A-19X	-	A-31X	-
A-20X	No connection	A-32X	-
A-21X	Headlight relay (High)	A-33X	-
A-22X	Throttle actuator control motor relay	A-34X	MFI relay
A-23X	-	A-35X	Radiator fan relay
A-24X	Daytime running light relay	A-36X	Condenser fan relay
A-25X	Injector relay	A-37X	Fan control relay
A-26X	Electric pump relay		

Relay box in engine compartment

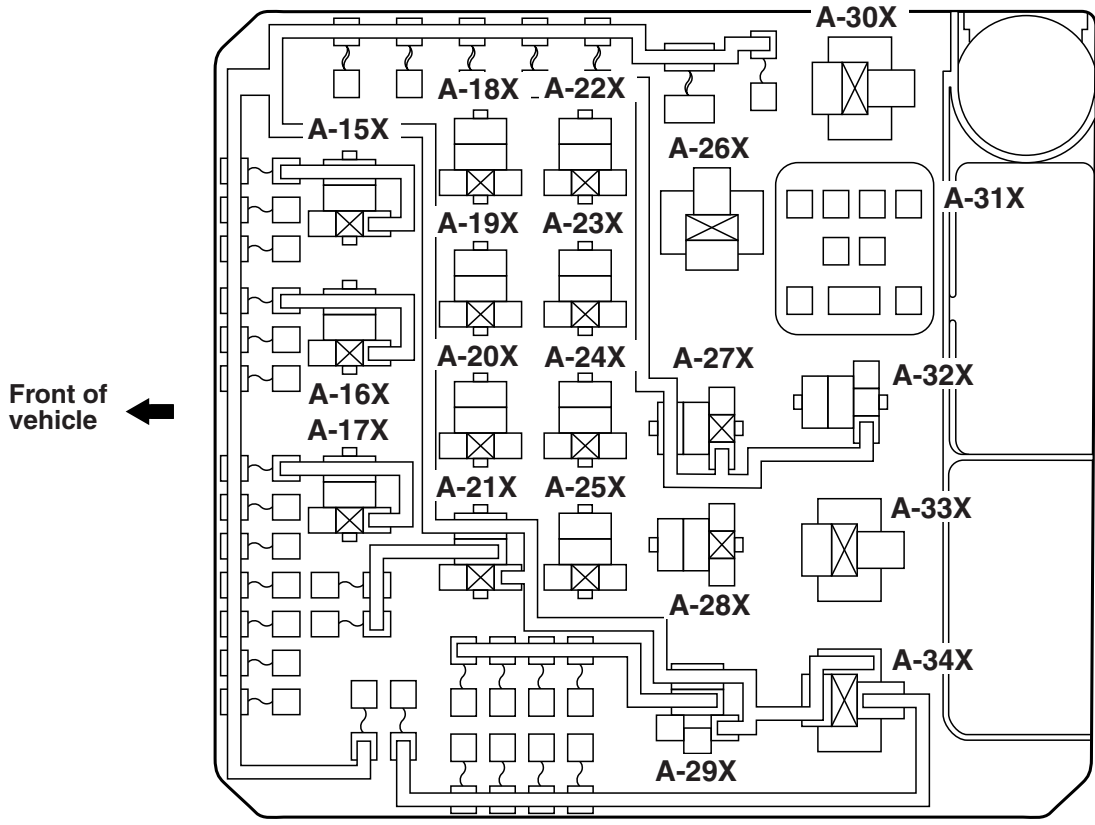

AC609168AU

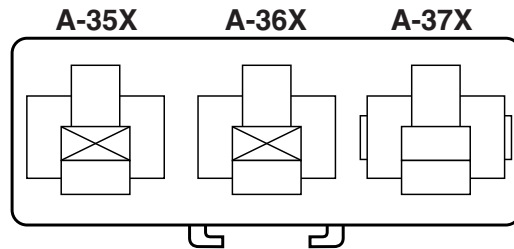

AC706168AC

NOTES

# POWER DISTRIBUTION SYSTEM

M1901000405012

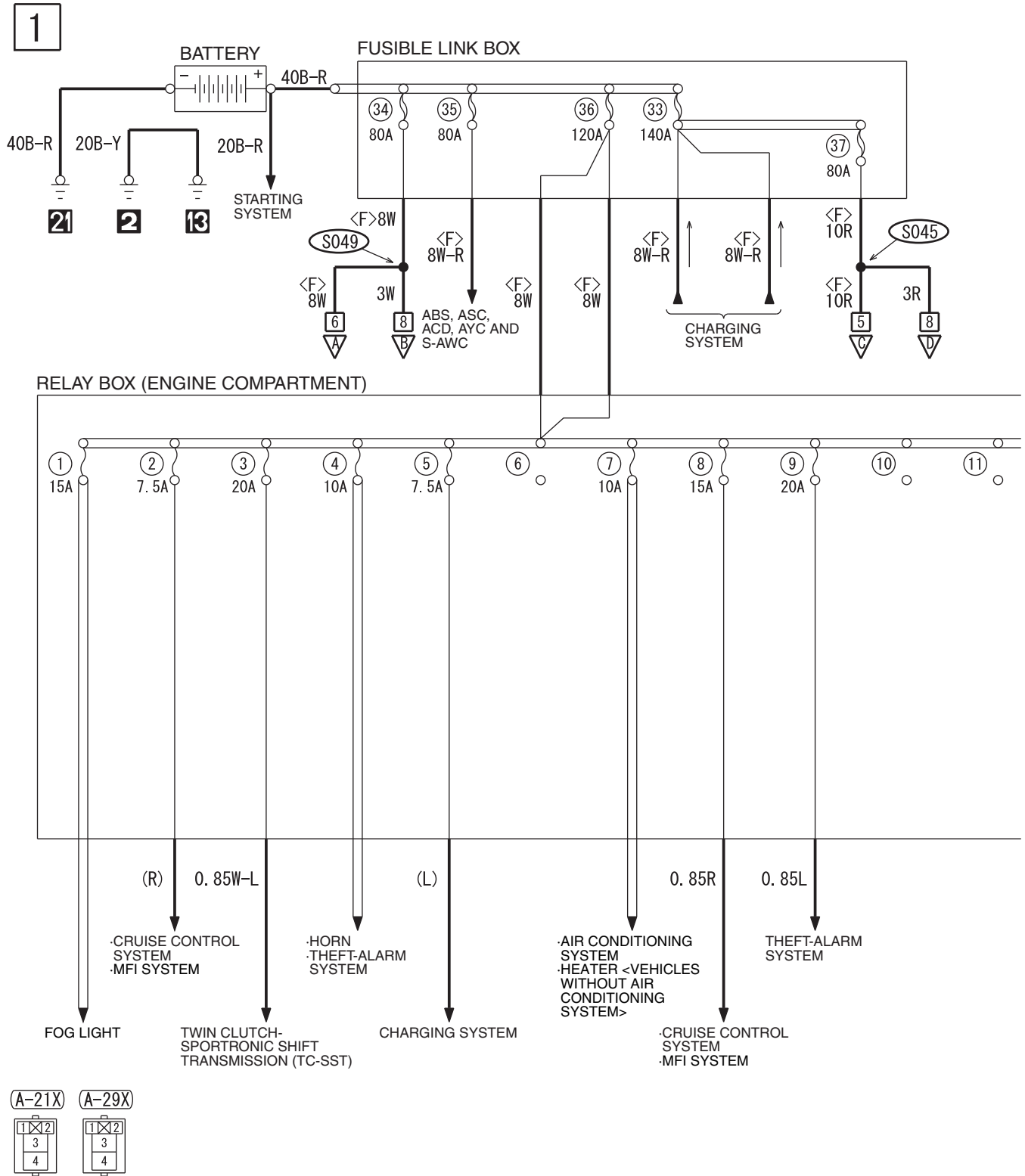

HAH01M02AA



2

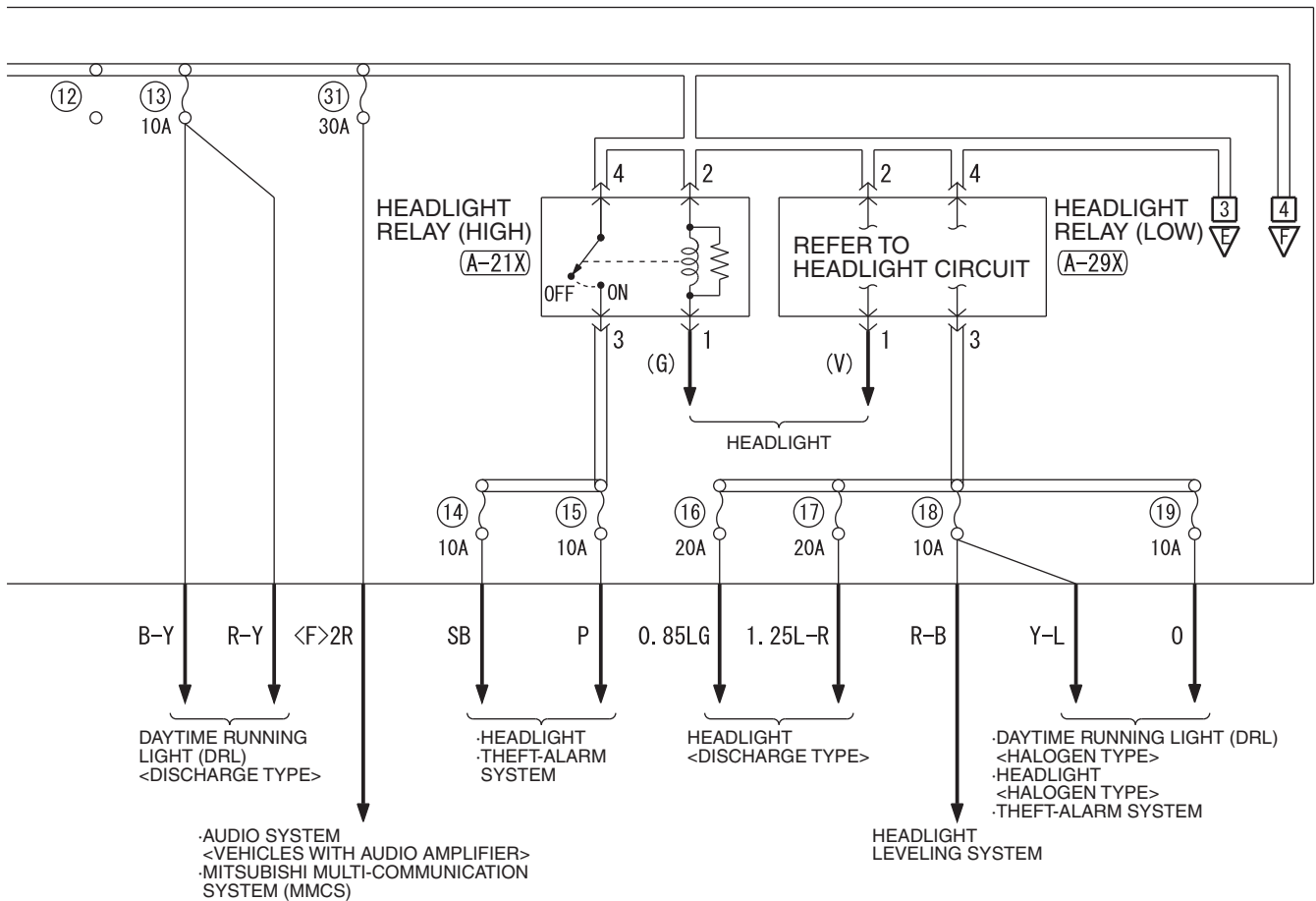

WIRE COLOR CODE

B : BLACK LG : LIGHT GREEN G : GREEN L : BLUE W : WHITE Y : YELLOW SB : SKY BLUE  
BR : BROWN O : ORANGE GR : GRAY R : RED P : PINK V : VIOLET PU : PURPLE SI : SILVER

HAH01M02AB

TSB Revision

POWER DISTRIBUTION SYSTEM (CONTINUED)

3

RELAY BOX (ENGINE COMPARTMENT)

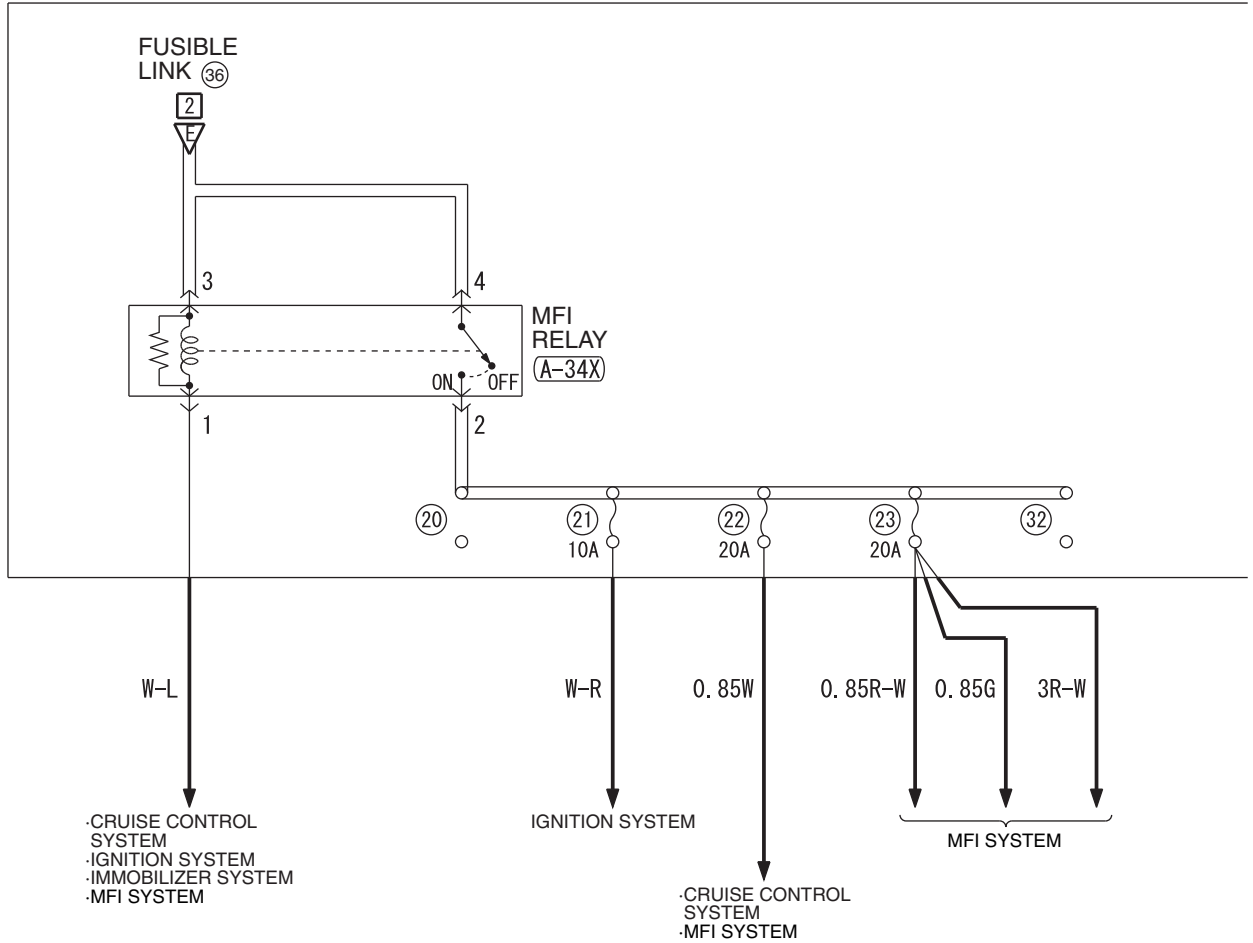

(A-34X)



4

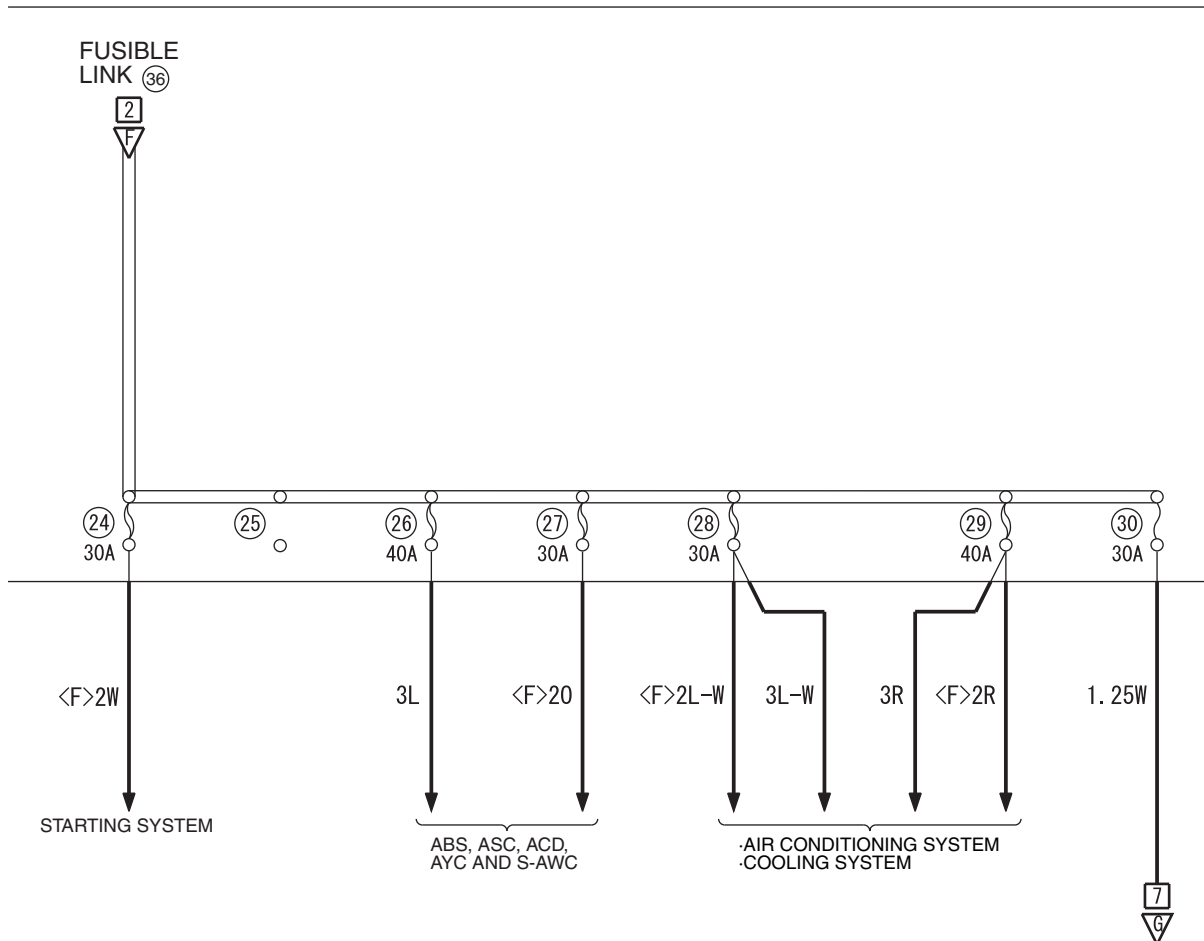

WIRE COLOR CODE

B: BLACK LG: LIGHT GREEN G: GREEN L: BLUE W: WHITE Y: YELLOW SB: SKY BLUE  
BR: BROWN O: ORANGE GR: GRAY R: RED P: PINK V: VIOLET PU: PURPLE SI: SILVER

HAH01M02BB

TSB Revision

POWER DISTRIBUTION SYSTEM (CONTINUED)

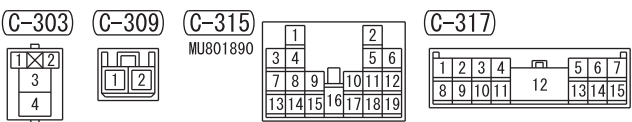
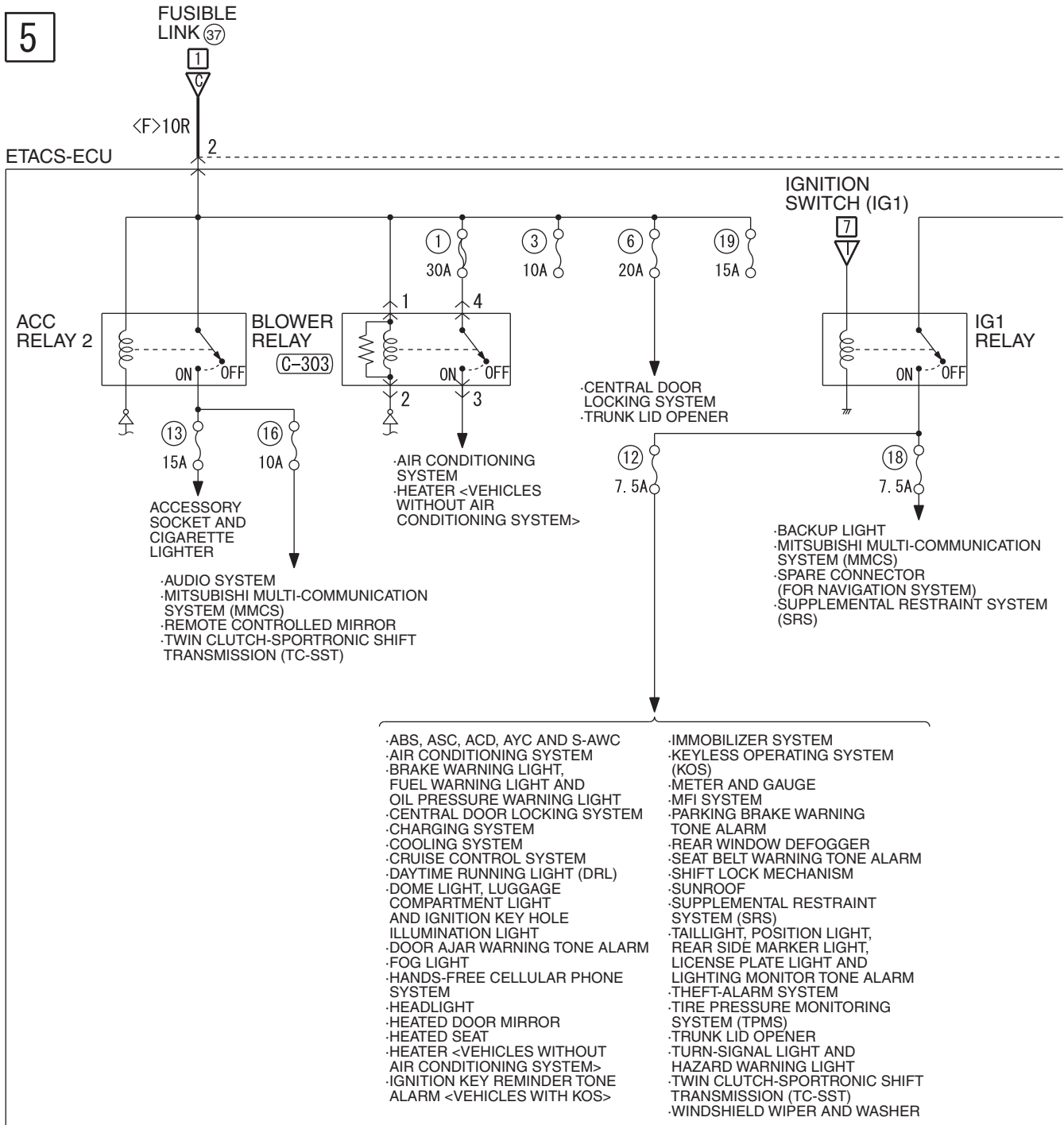

6

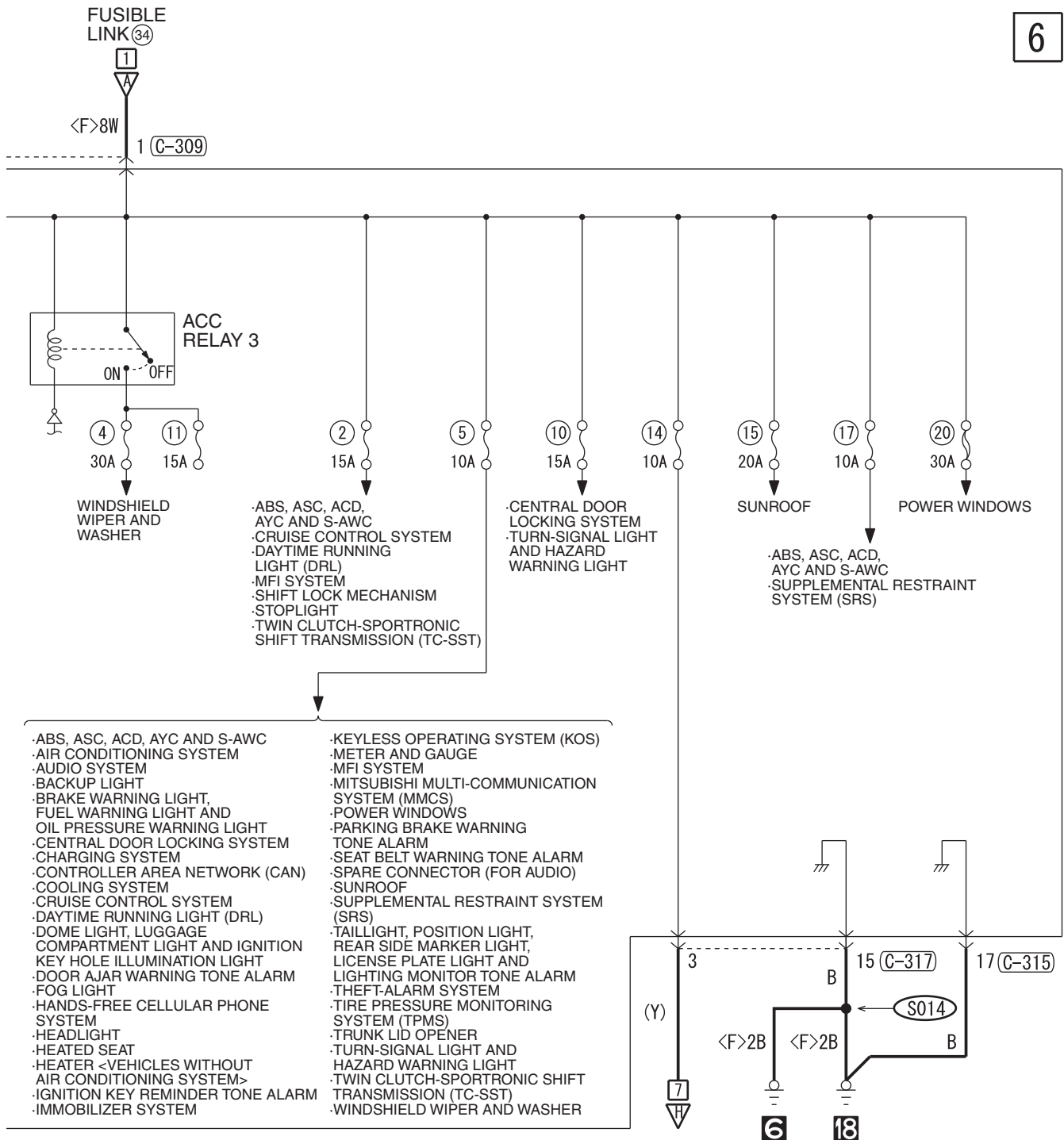

WIRE COLOR CODE

B : BLACK LG : LIGHT GREEN G : GREEN L : BLUE W : WHITE Y : YELLOW SB : SKY BLUE  
BR : BROWN O : ORANGE GR : GRAY R : RED P : PINK V : VIOLET PU : PURPLE SI : SILVER

HAH01M02CB

TSB Revision

POWER DISTRIBUTION SYSTEM (CONTINUED)

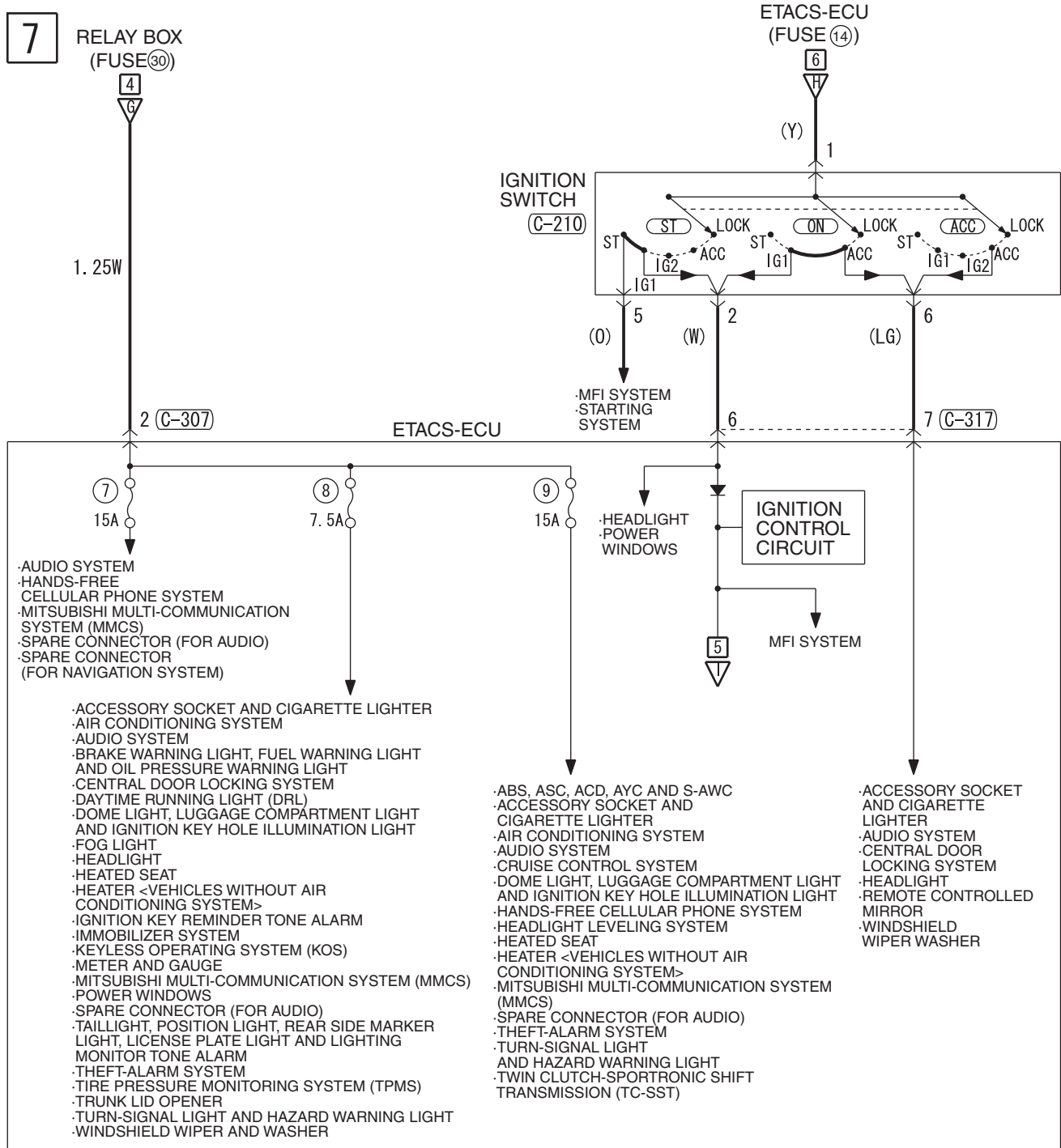

(C-102)

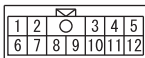

(C-132)



(C-210)



(C-306)



(C-307)



(C-308)



(C-317)

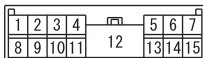

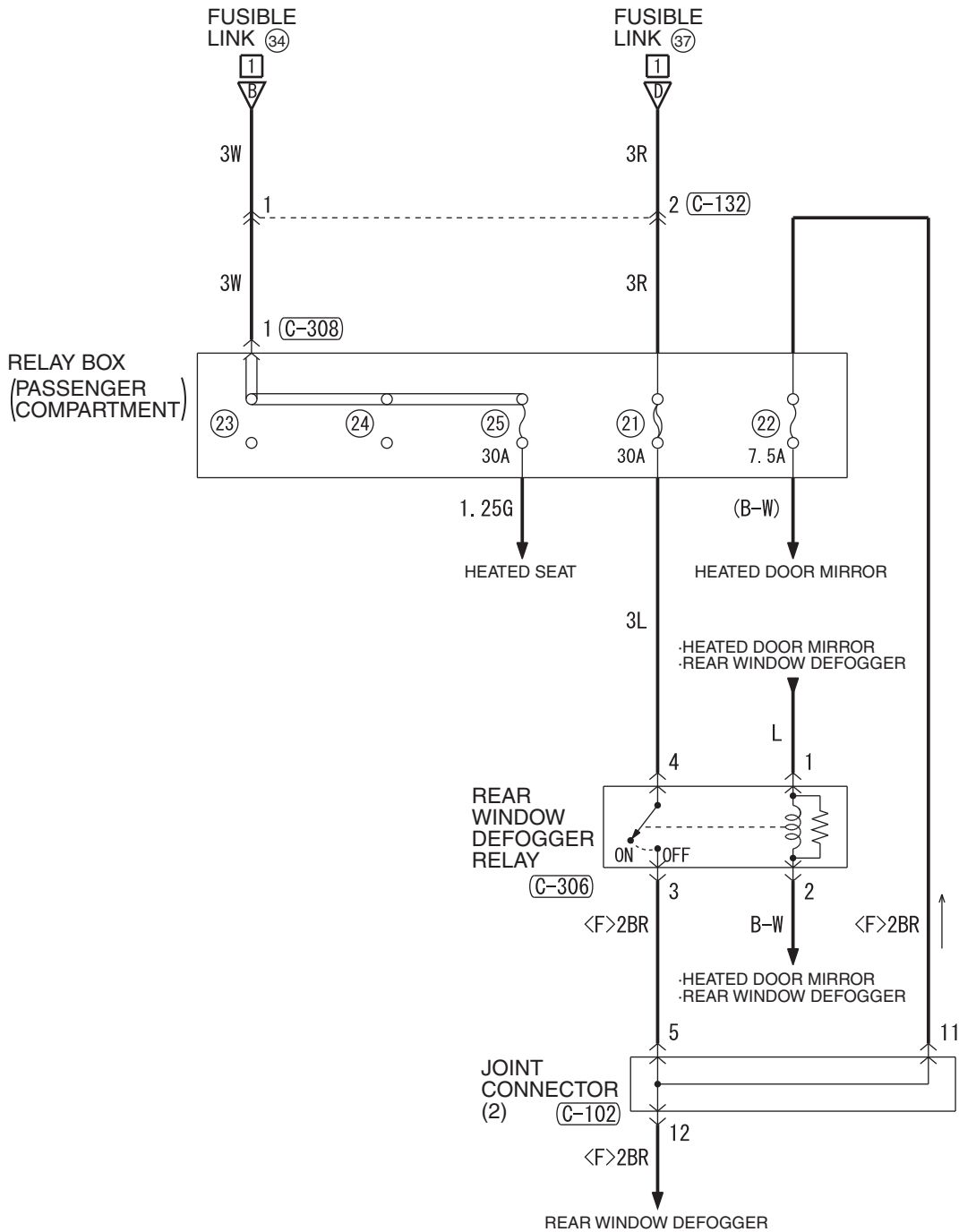

WIRE COLOR CODE  
 B: BLACK LG: LIGHT GREEN G: GREEN L: BLUE W: WHITE Y: YELLOW SB: SKY BLUE  
 BR: BROWN O: ORANGE GR: GRAY R: RED P: PINK V: VIOLET PU: PURPLE SI: SILVER

HAH01M02DB

# STARTING SYSTEM <M/T>

M1901000505558

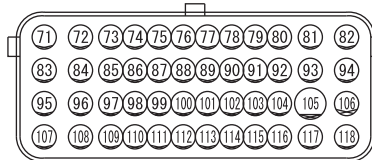
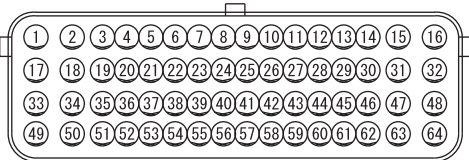
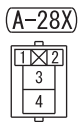
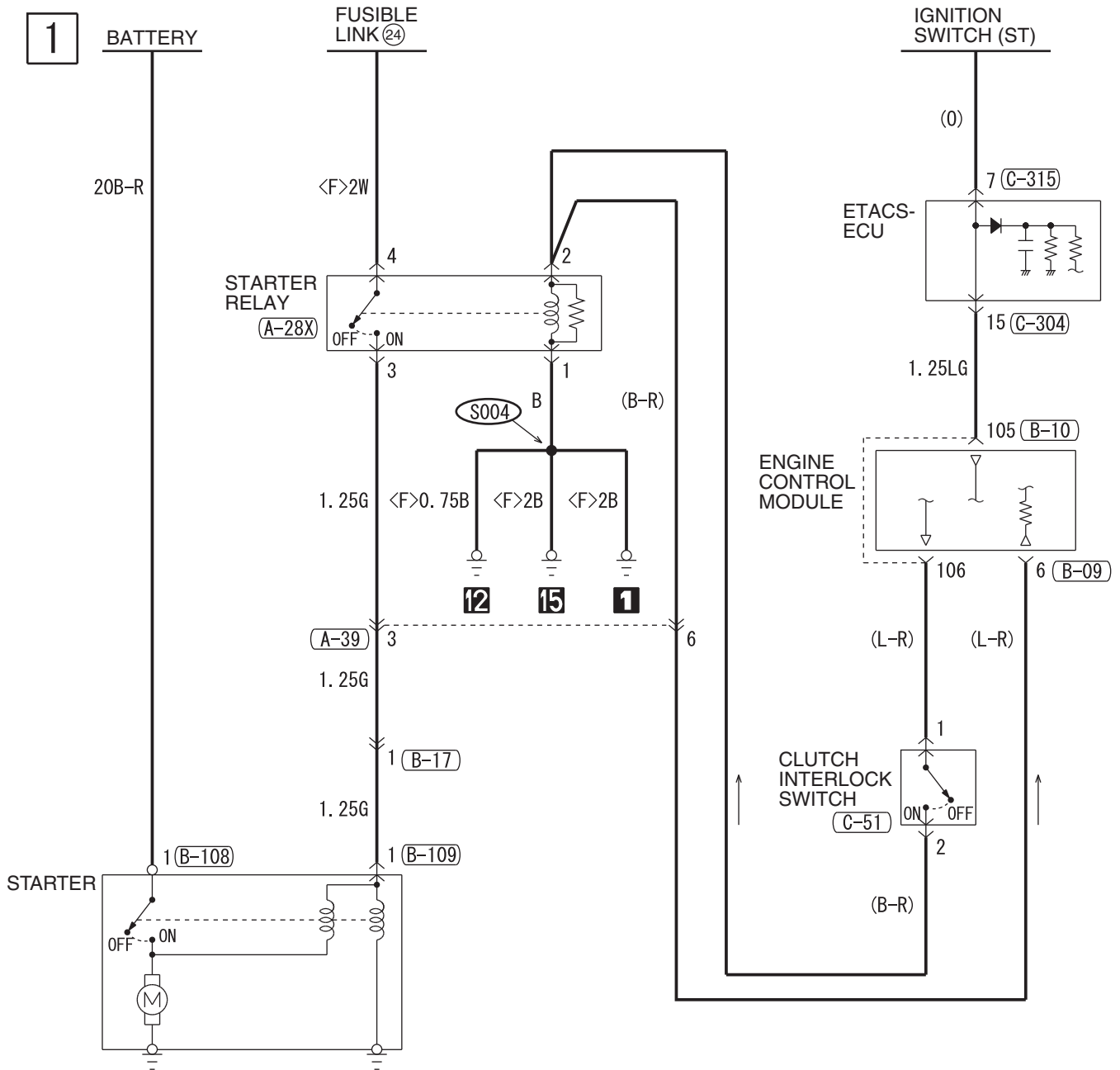

HAH02M02AA



NOTES

# STARTING SYSTEM <TC-SST>

M1901000505569

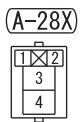
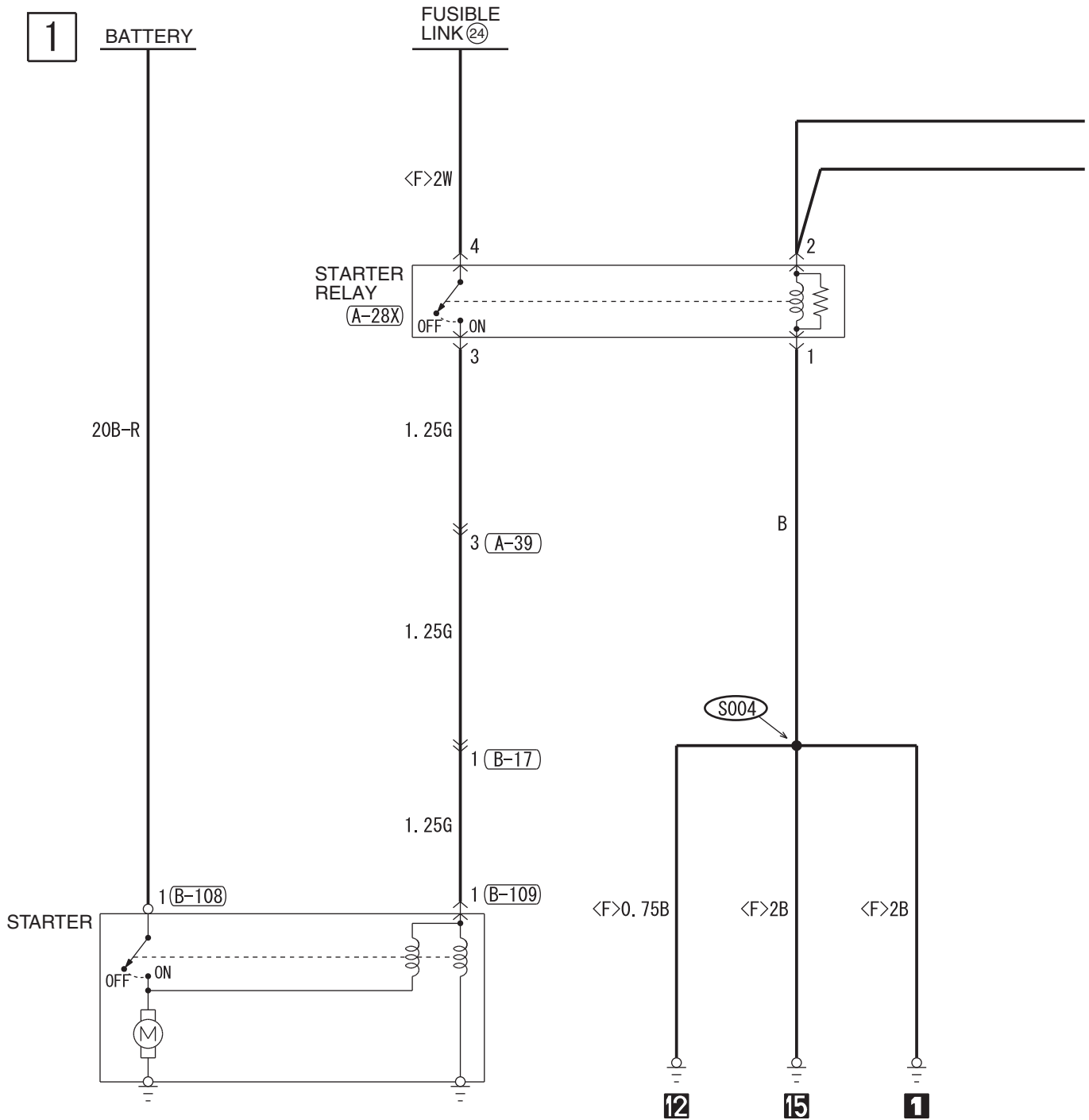

(B-09)

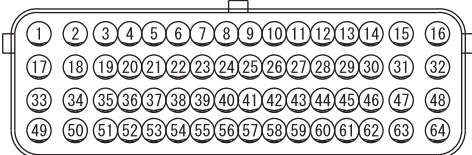

(B-10)

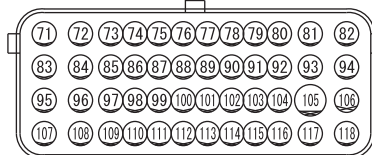

HAH02M03AA

TSB Revision

2

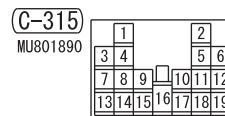
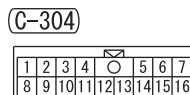
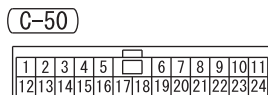
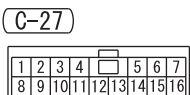
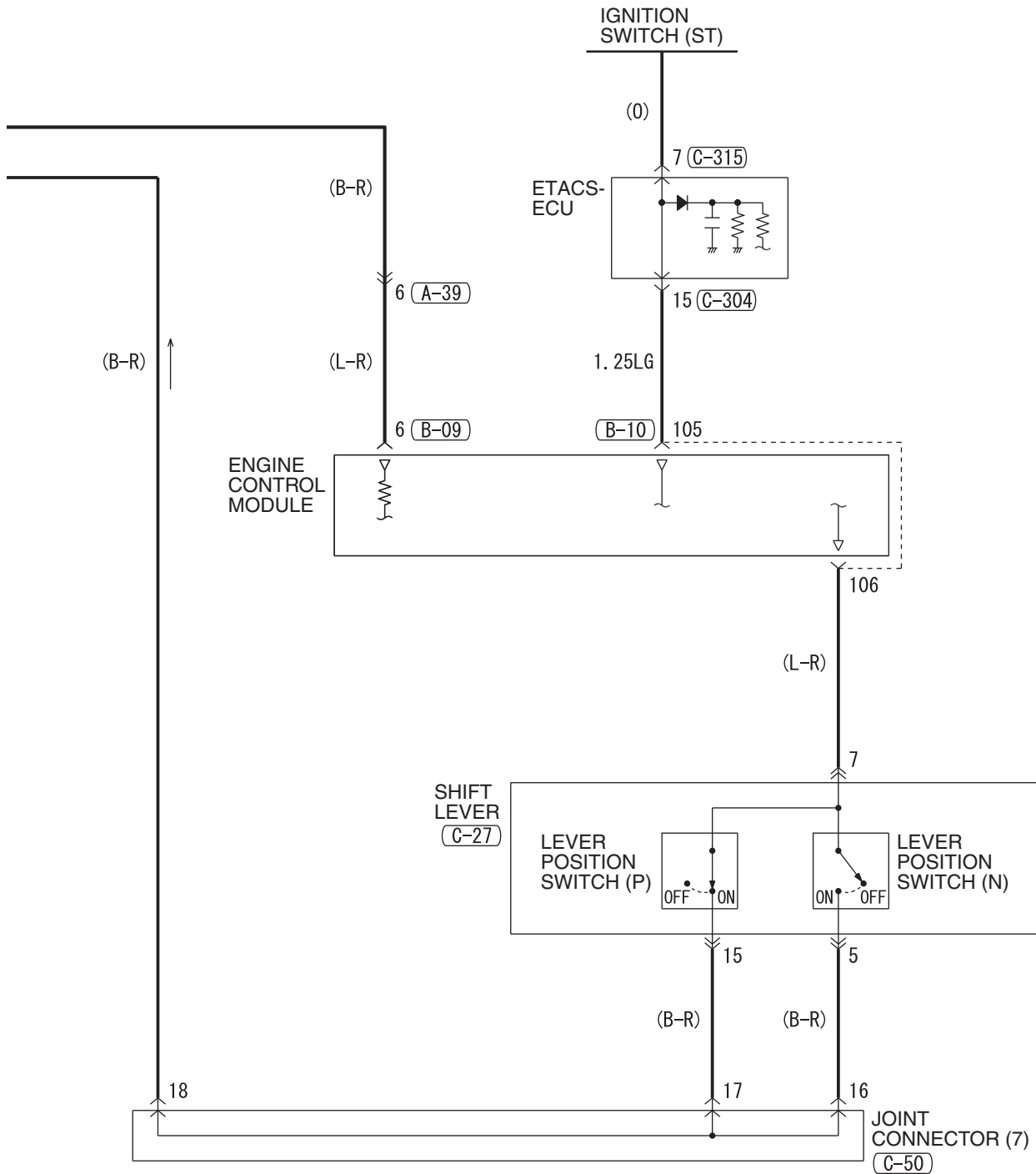

WIRE COLOR CODE  
 B: BLACK LG: LIGHT GREEN G: GREEN L: BLUE W: WHITE Y: YELLOW SB: SKY BLUE  
 BR: BROWN O: ORANGE GR: GRAY R: RED P: PINK V: VIOLET PU: PURPLE SI: SILVER

# IGNITION SYSTEM

M1901000605500

1

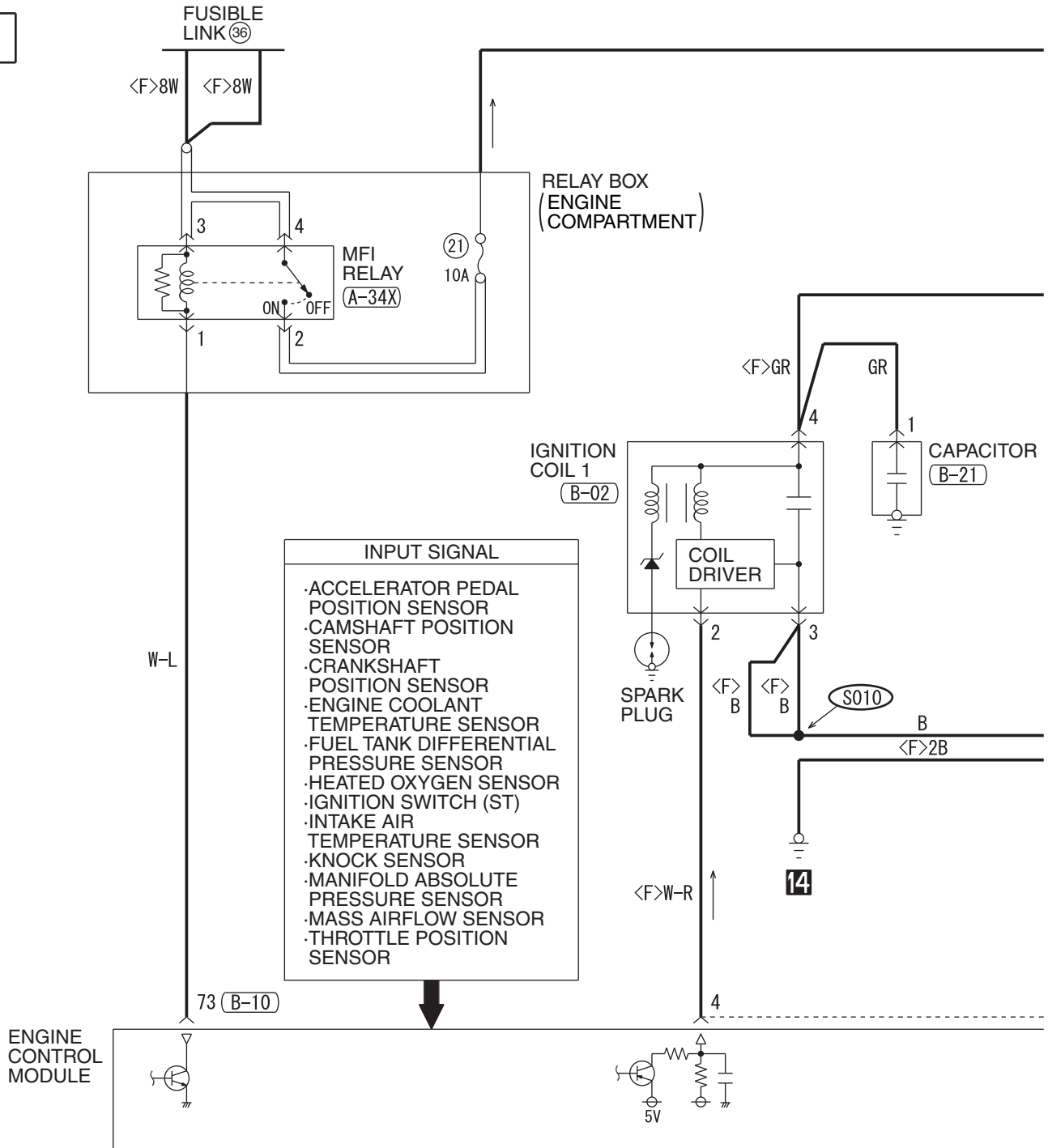

(A-34X)

(A-39)

(B-02)

(B-03)

(B-04)

(B-06)

(B-09)

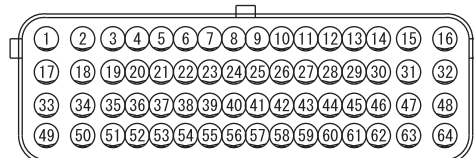

HAH03M02AA

TSB Revision

2

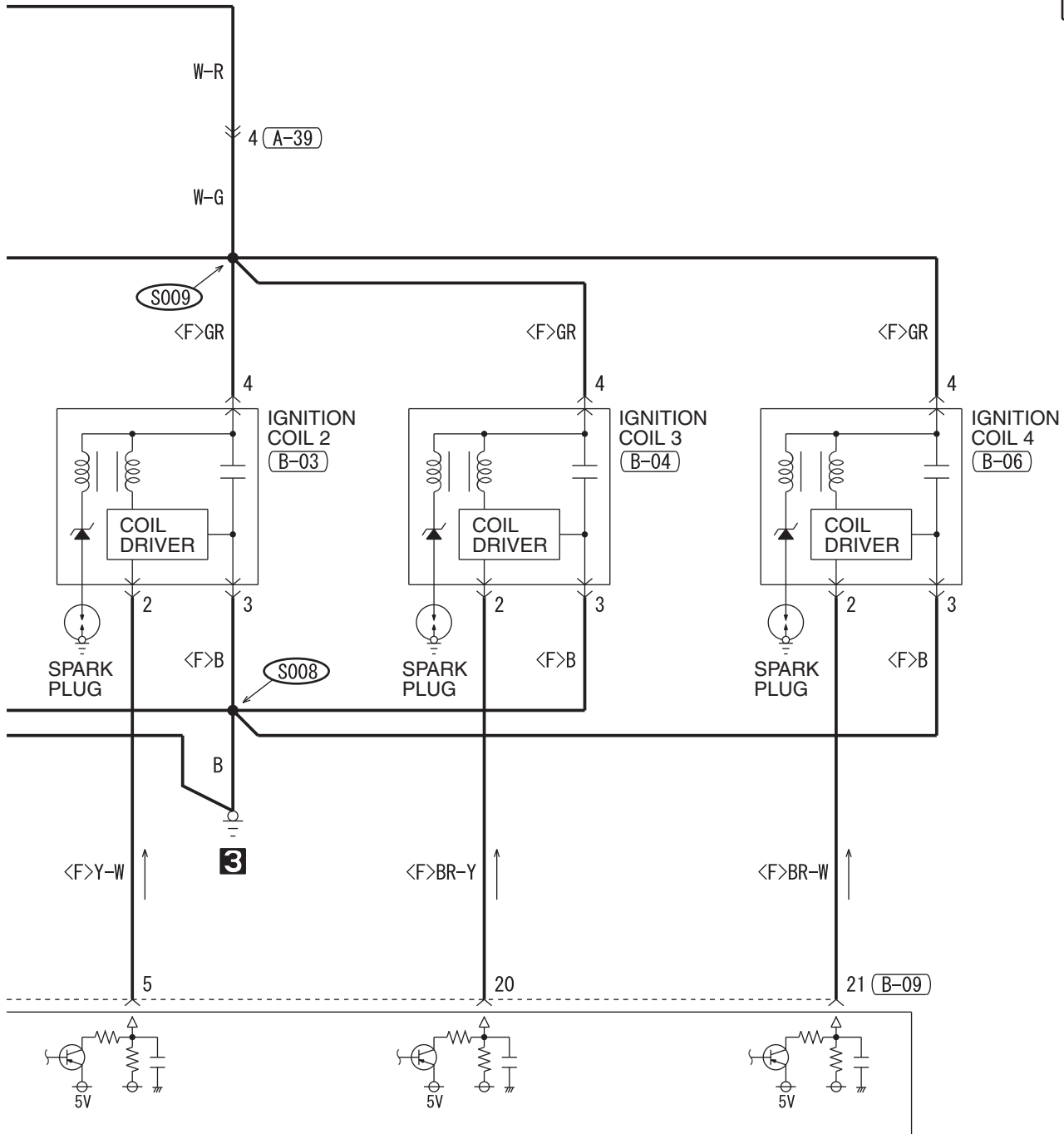

(B-10)

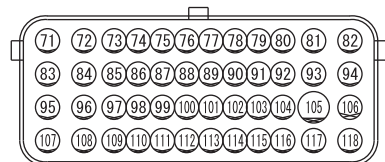

(B-21)

(MU801211)



WIRE COLOR CODE  
 B: BLACK LG: LIGHT GREEN G: GREEN L: BLUE W: WHITE  
 Y: YELLOW SB: SKY BLUE BR: BROWN O: ORANGE GR: GRAY  
 R: RED P: PINK V: VIOLET PU: PURPLE SI: SILVER

HAH03M02AB

TSB Revision

IGNITION SYSTEM (CONTINUED)

3

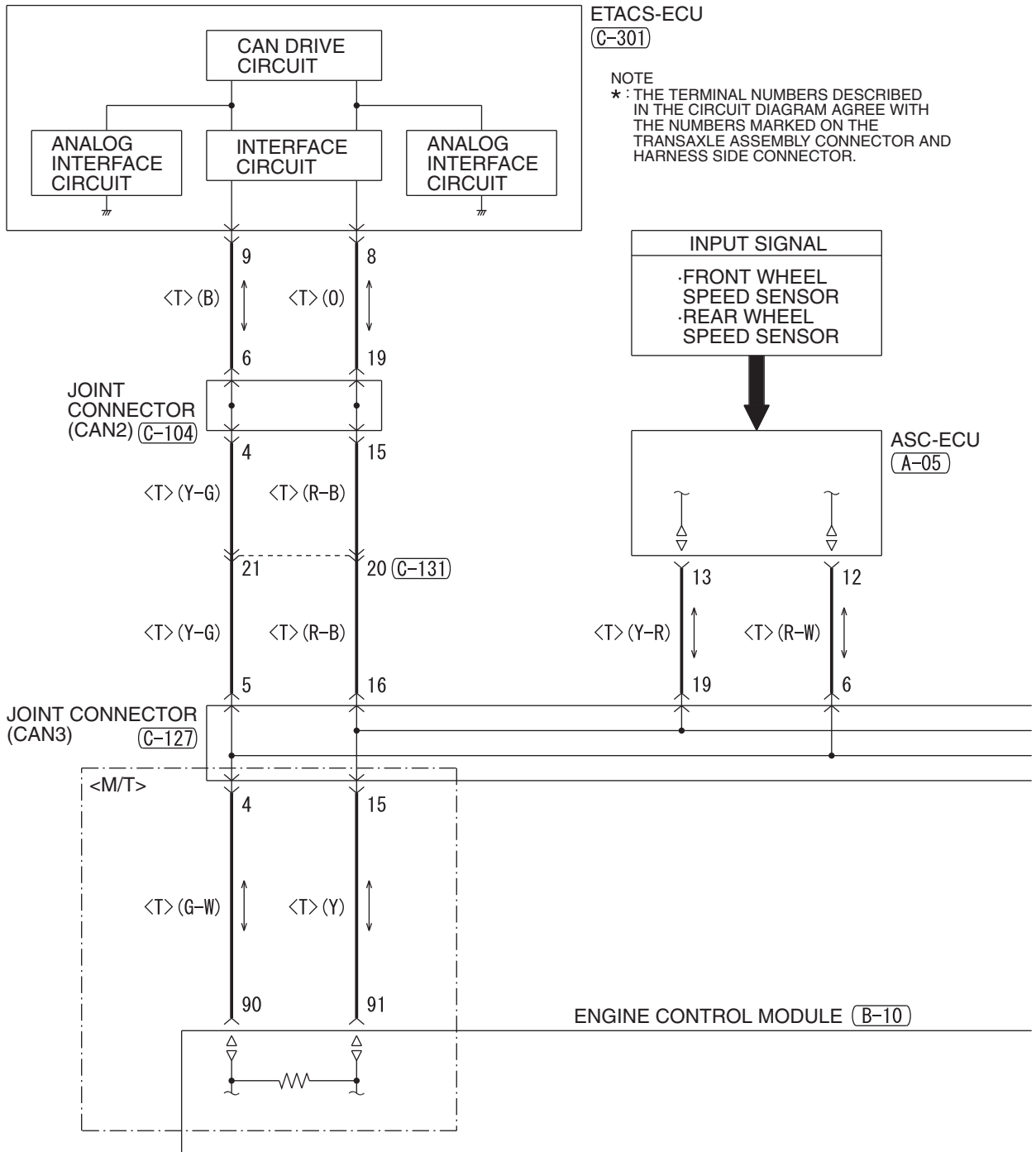

(A-05)

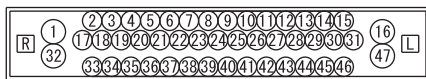

(A-13)

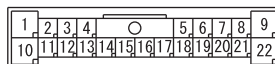

(A-14)

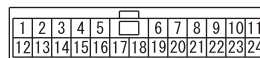

(C-127)

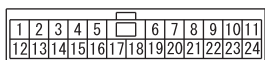

(C-131)

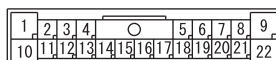

(C-301)

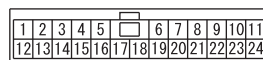

4

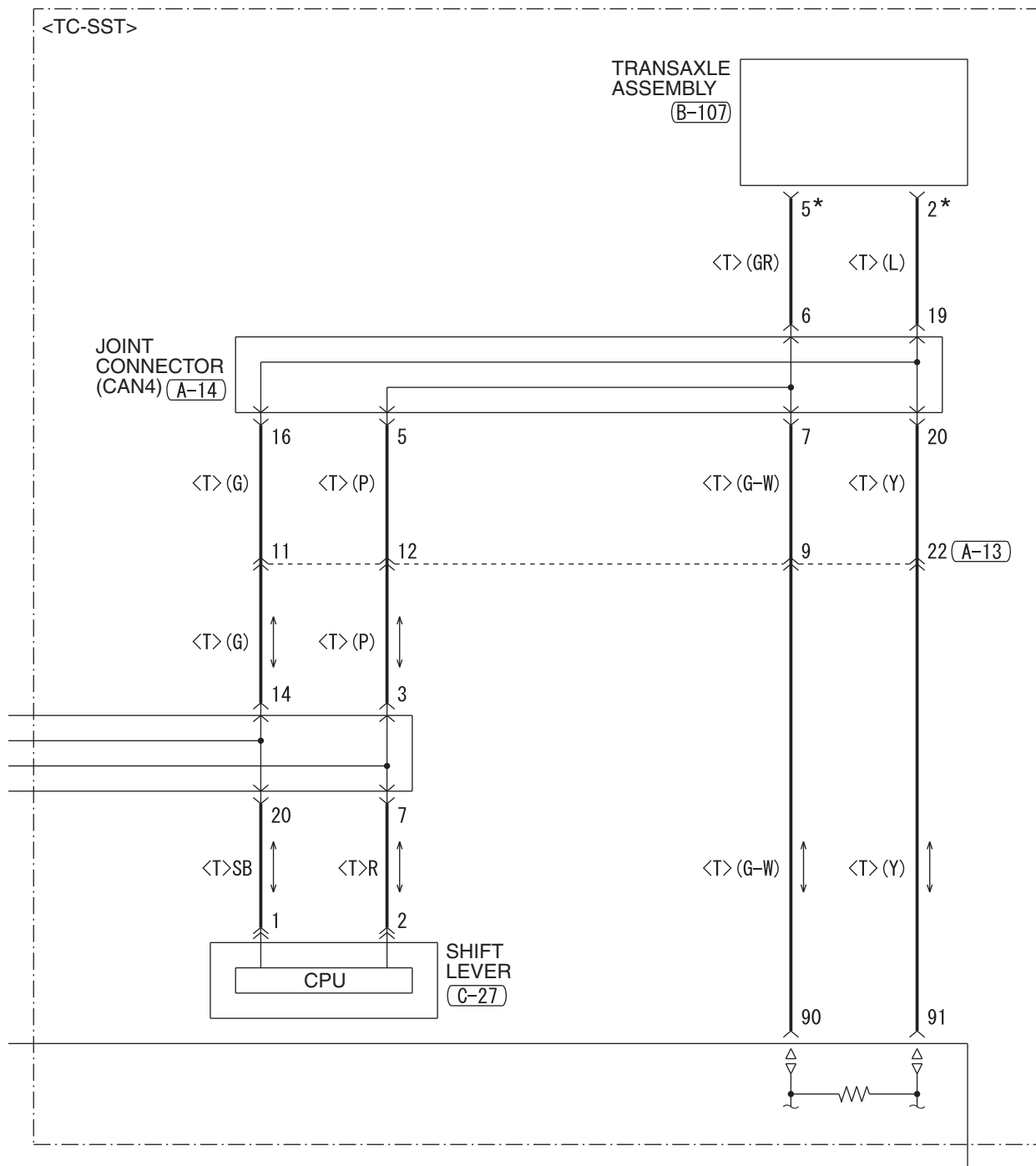

(B-10)

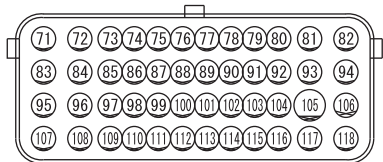

(B-107)\*



(C-27)

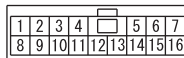

(C-104)

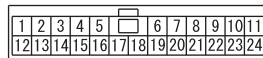

CHARGING SYSTEM <M/T>

M1901000705444

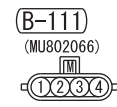
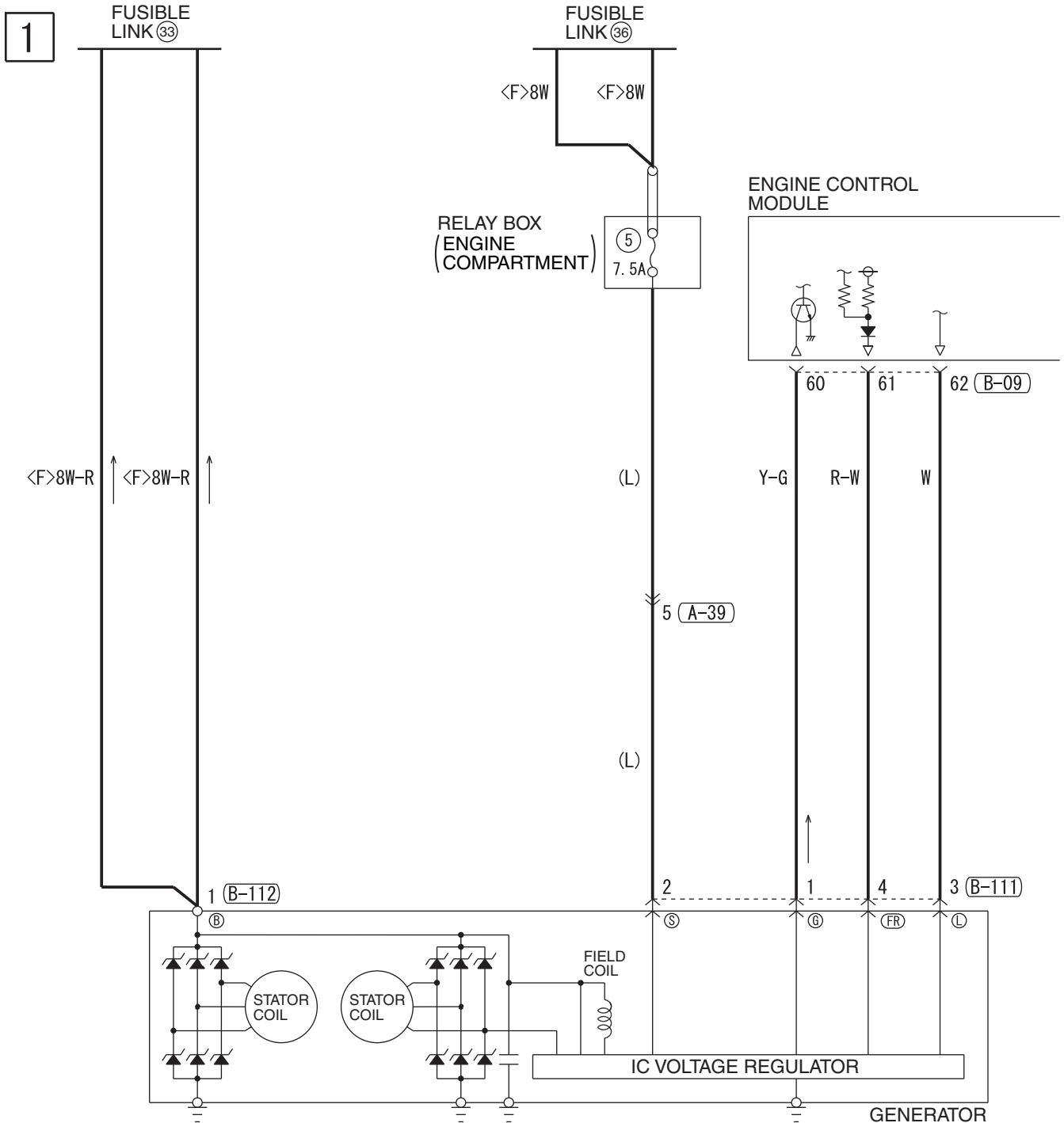

HAH04M02AA



2

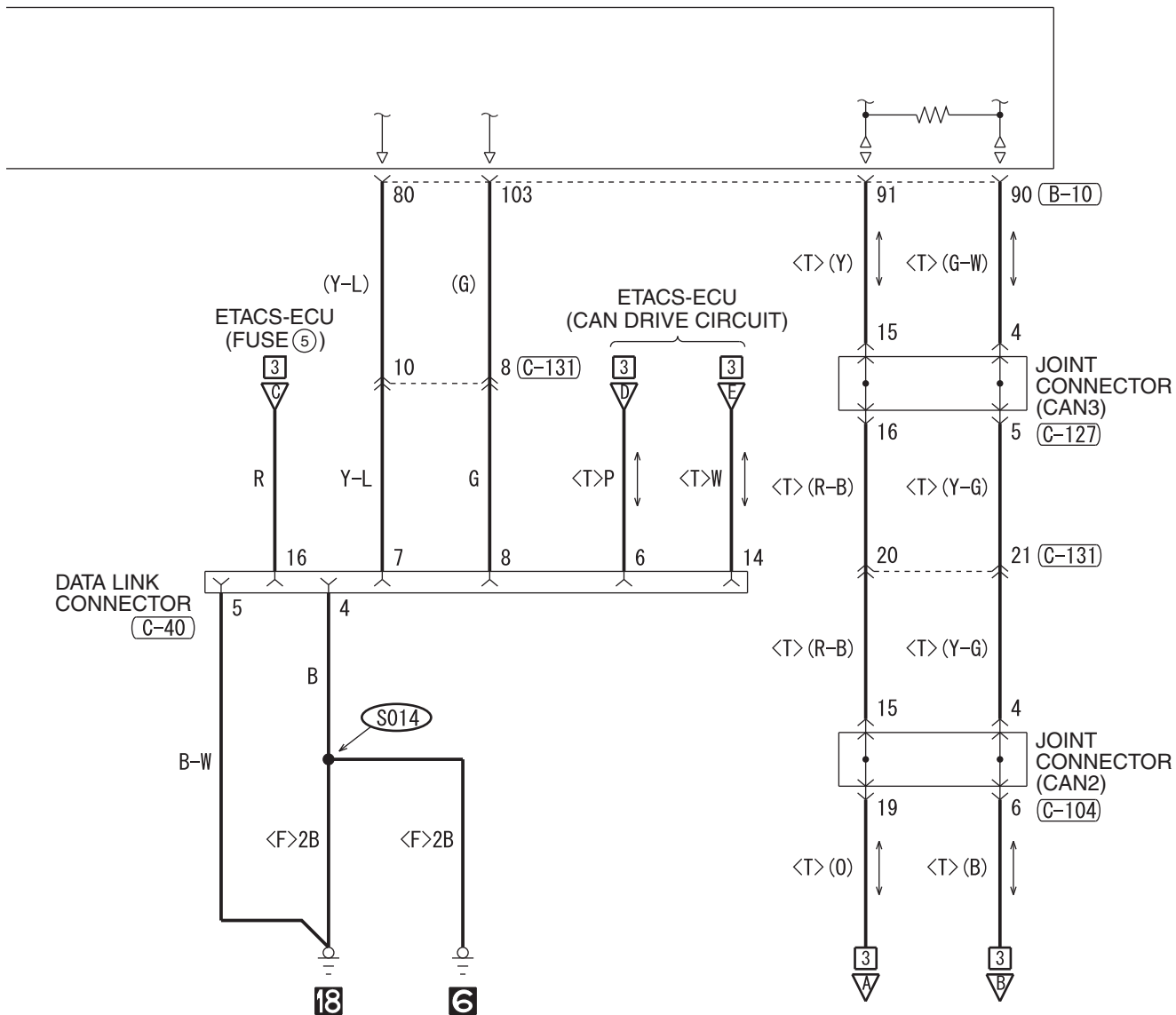

(C-40) FRONT SIDE



(C-104)

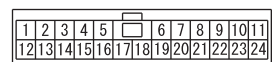

(C-127)

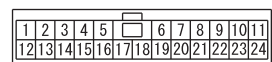

(C-131)

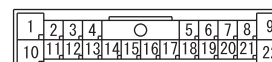

WIRE COLOR CODE

B : BLACK LG : LIGHT GREEN G : GREEN L : BLUE W : WHITE Y : YELLOW SB : SKY BLUE  
BR : BROWN O : ORANGE GR : GRAY R : RED P : PINK V : VIOLET PU : PURPLE SI : SILVER

HAH04M02AB

TSB Revision

CHARGING SYSTEM <M/T> (CONTINUED)

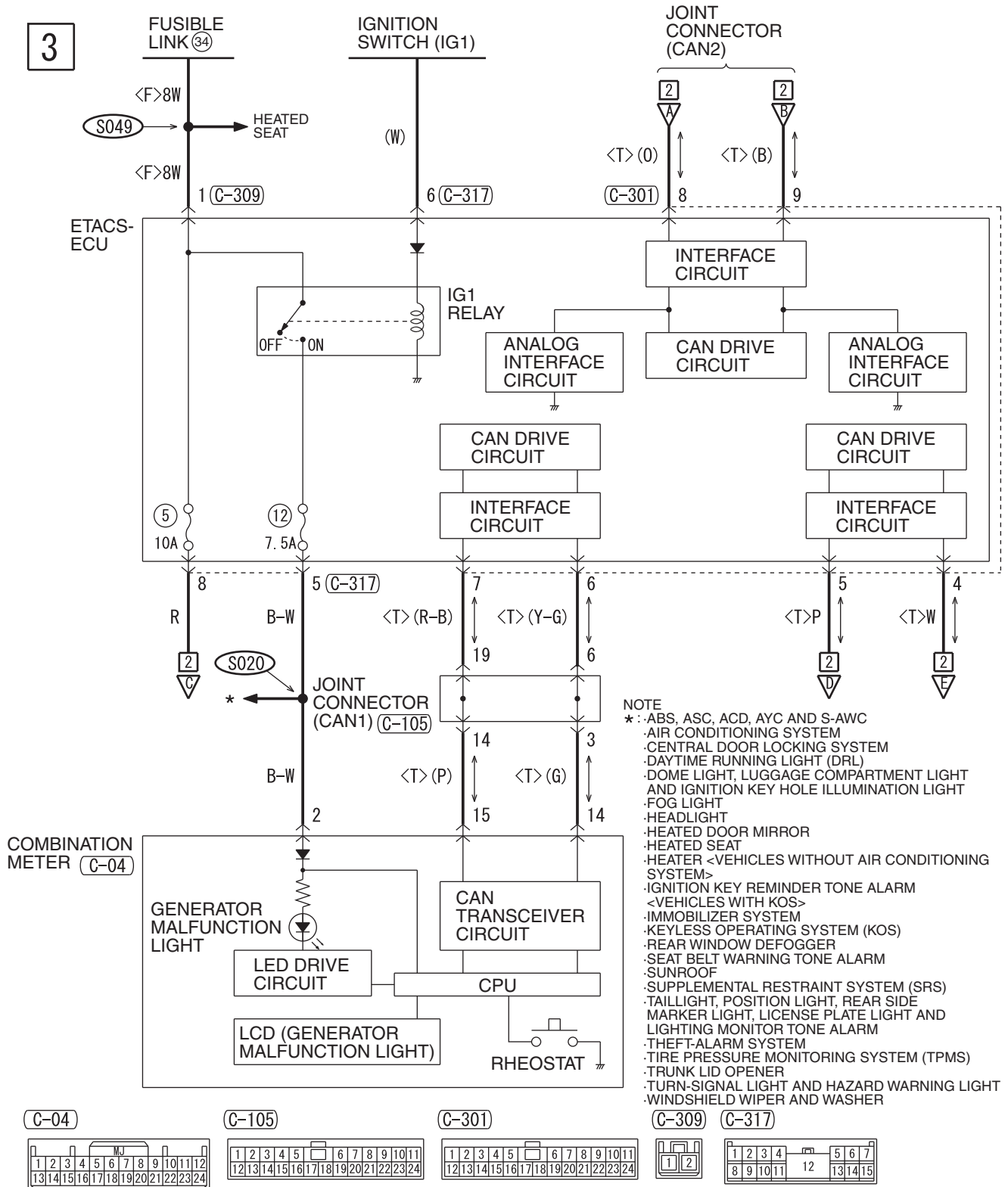

WIRE COLOR CODE

B : BLACK LG : LIGHT GREEN G : GREEN L : BLUE W : WHITE Y : YELLOW SB : SKY BLUE  
 BR : BROWN O : ORANGE GR : GRAY R : RED P : PINK V : VIOLET PU : PURPLE SI : SILVER

NOTES

# CHARGING SYSTEM <TC-SST>

M1901000705455

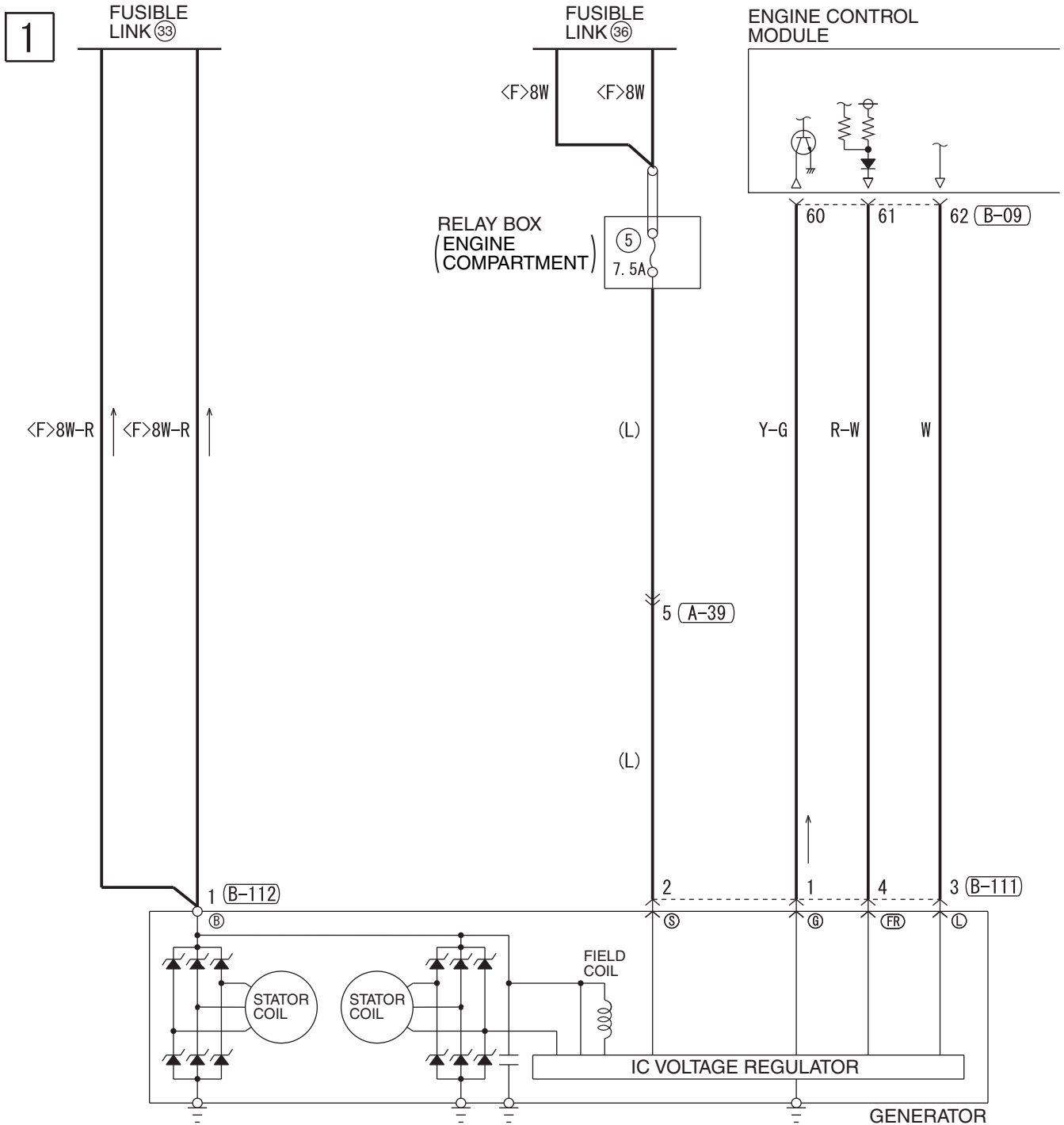

(A-13)

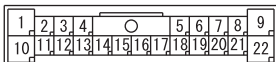

(A-14)

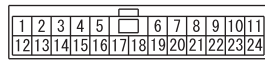

(A-39)



(B-09)

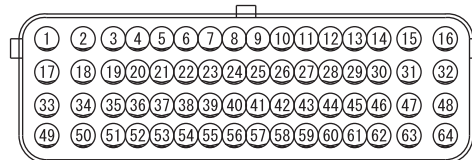

(C-127)

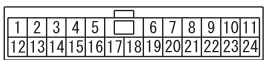

(C-131)

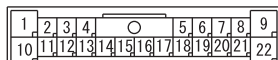

HAH04M03AA

2

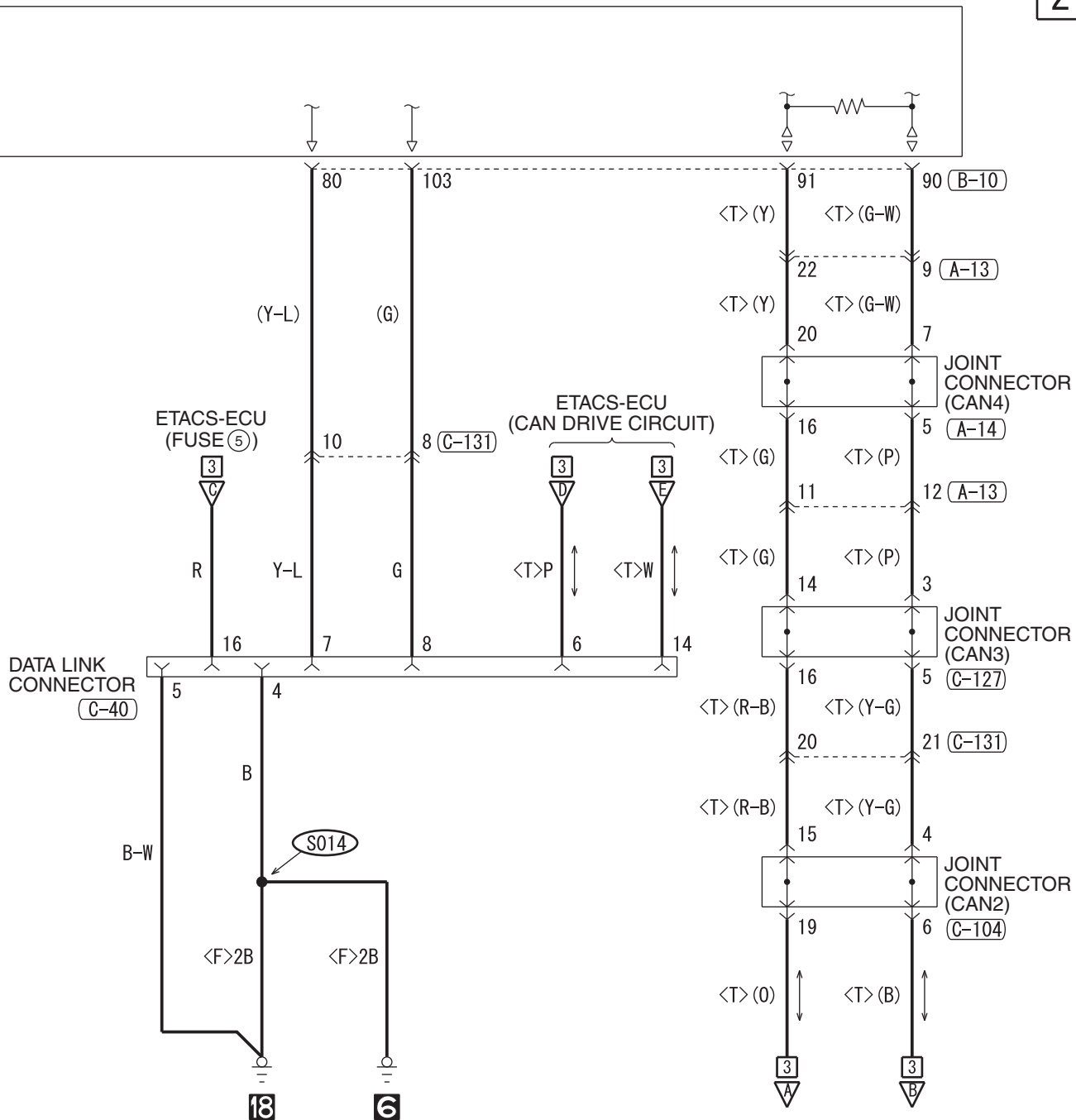

(B-10)

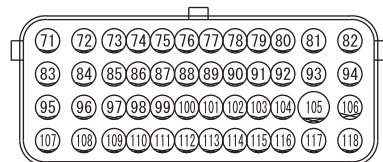

(B-111)

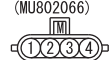

(B-112)



(C-40) FRONT SIDE

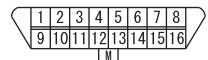

(C-104)

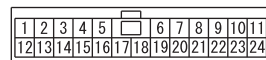

WIRE COLOR CODE

B : BLACK LG : LIGHT GREEN G : GREEN L : BLUE W : WHITE  
Y : YELLOW SB : SKY BLUE BR : BROWN O : ORANGE GR : GRAY  
R : RED P : PINK V : VIOLET PU : PURPLE SI : SILVER

HAH04M03AB

CHARGING SYSTEM <TC-SST> (CONTINUED)

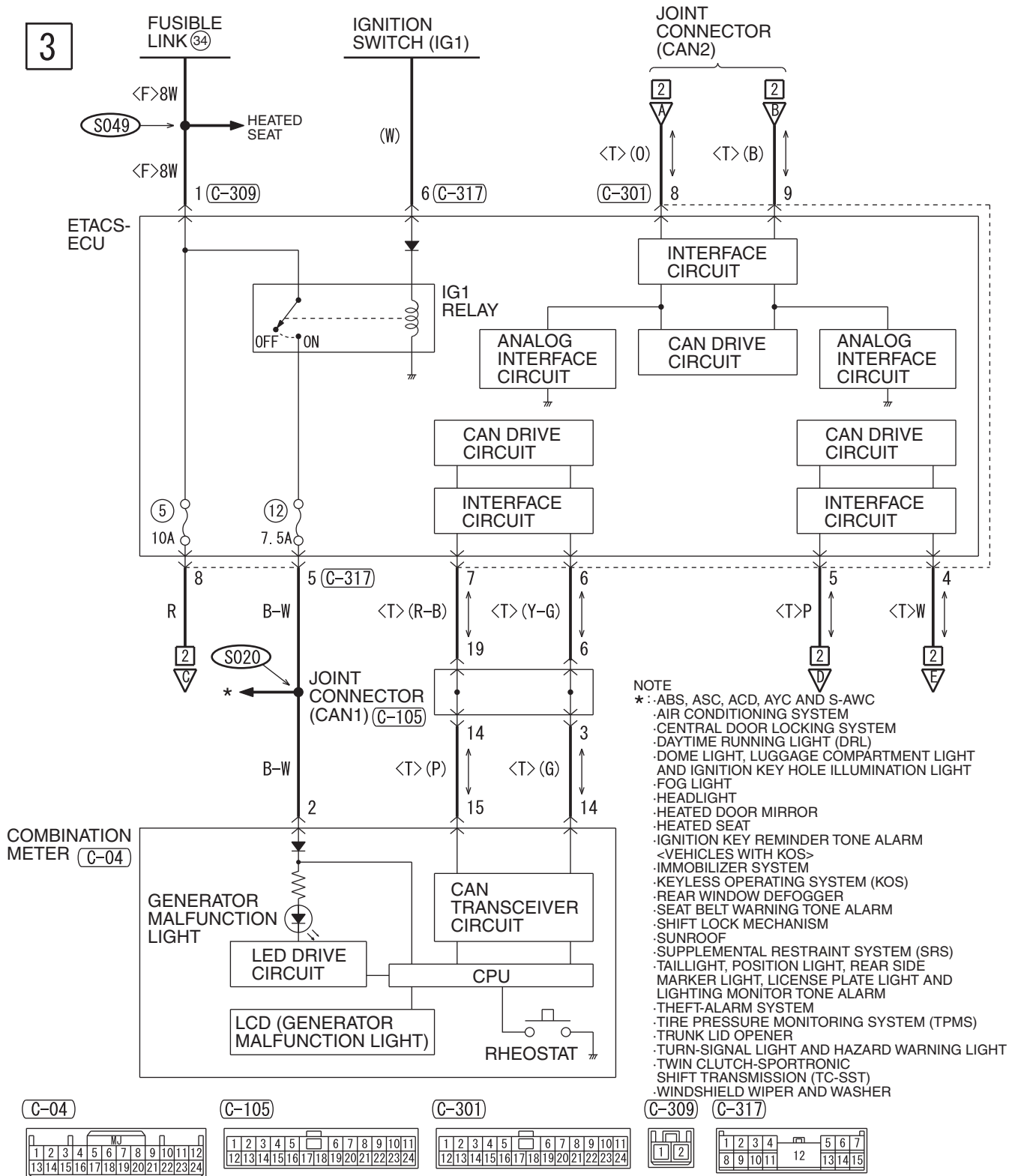

WIRE COLOR CODE  
 B : BLACK LG : LIGHT GREEN G : GREEN L : BLUE W : WHITE Y : YELLOW SB : SKY BLUE  
 BR : BROWN O : ORANGE GR : GRAY R : RED P : PINK V : VIOLET PU : PURPLE SI : SILVER

NOTES

MFI SYSTEM <M/T>

M1901000809636

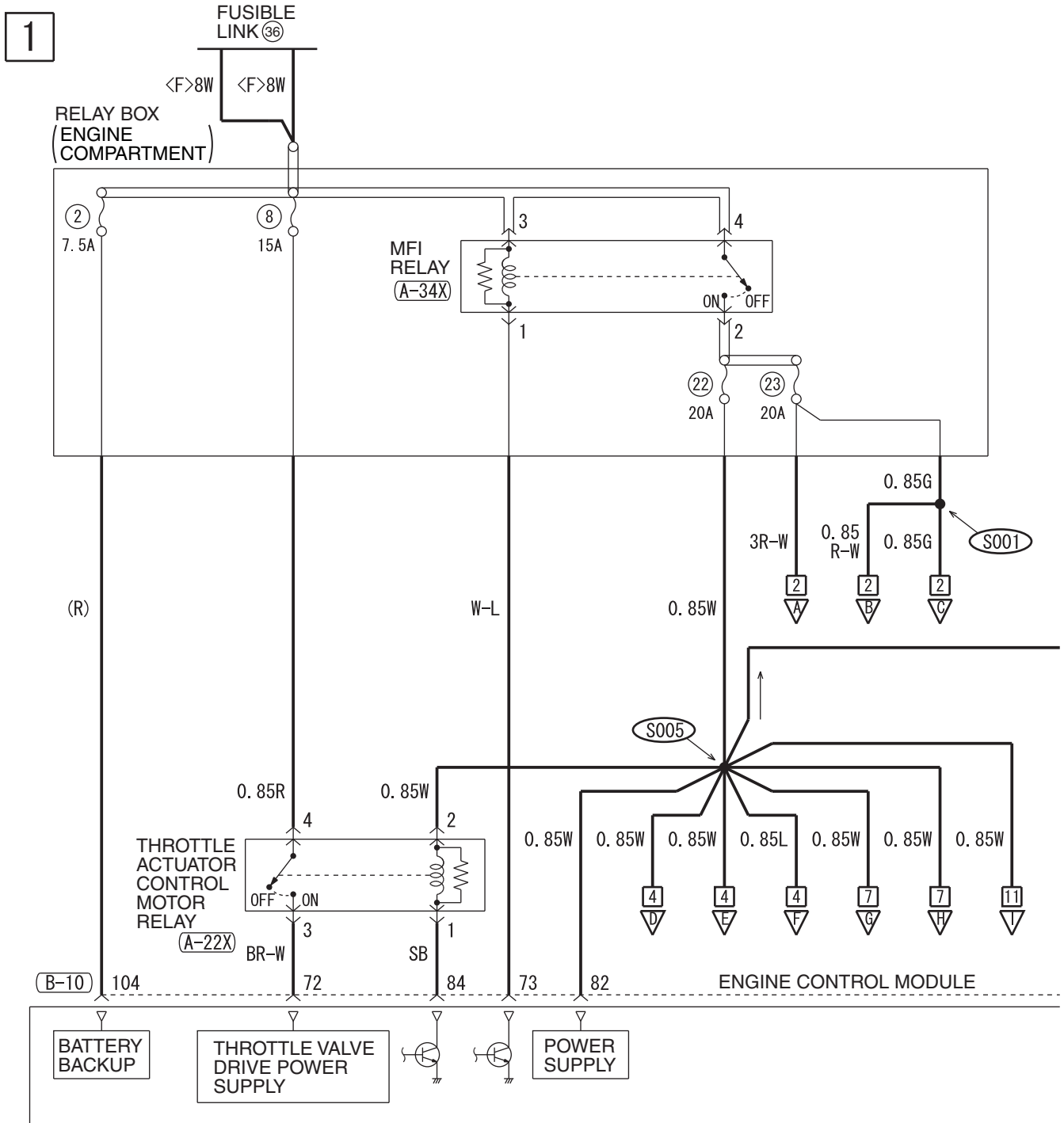

(A-13)

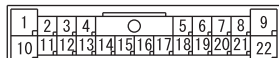

(A-22X)



(A-25X)



(A-27X)



(A-34X)



(A-58)



(B-09)

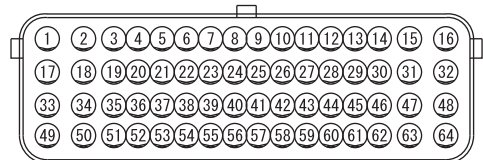

(C-317)

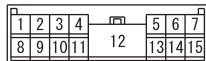

(D-22)



HAH05M02AA



2

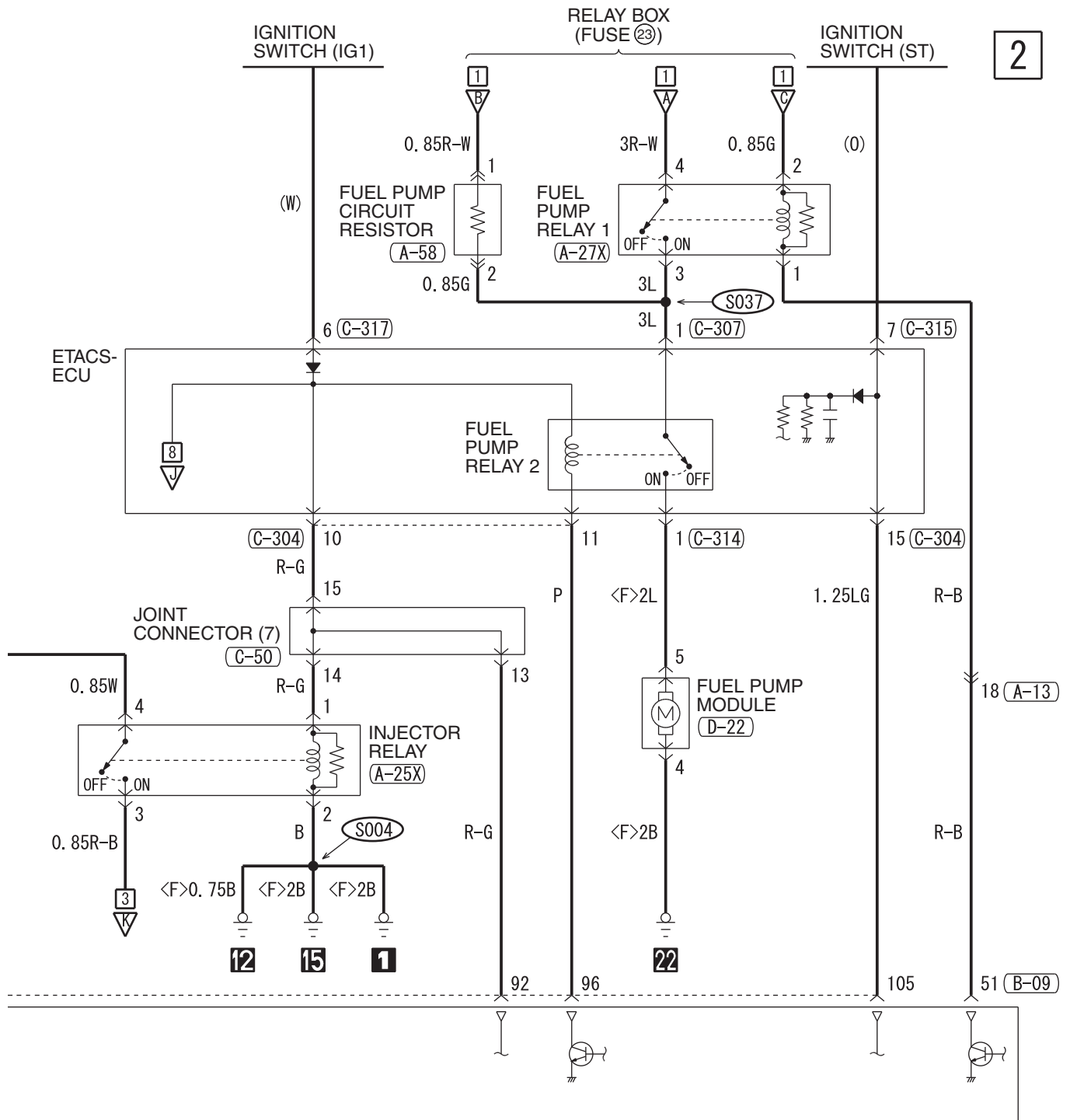

(B-10)

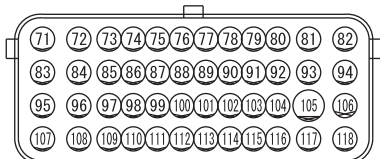

(C-50)



(C-304)

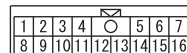

(C-307)



(C-314)



(C-315)



WIRE COLOR CODE

B : BLACK LG : LIGHT GREEN G : GREEN L : BLUE W : WHITE  
Y : YELLOW SB : SKY BLUE BR : BROWN O : ORANGE GR : GRAY  
R : RED P : PINK V : VIOLET PU : PURPLE SI : SILVER

HAH05M02AB

MFI SYSTEM <M/T> (CONTINUED)

3

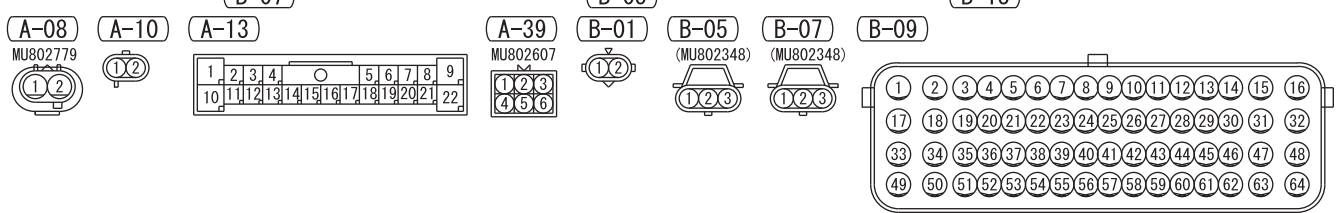
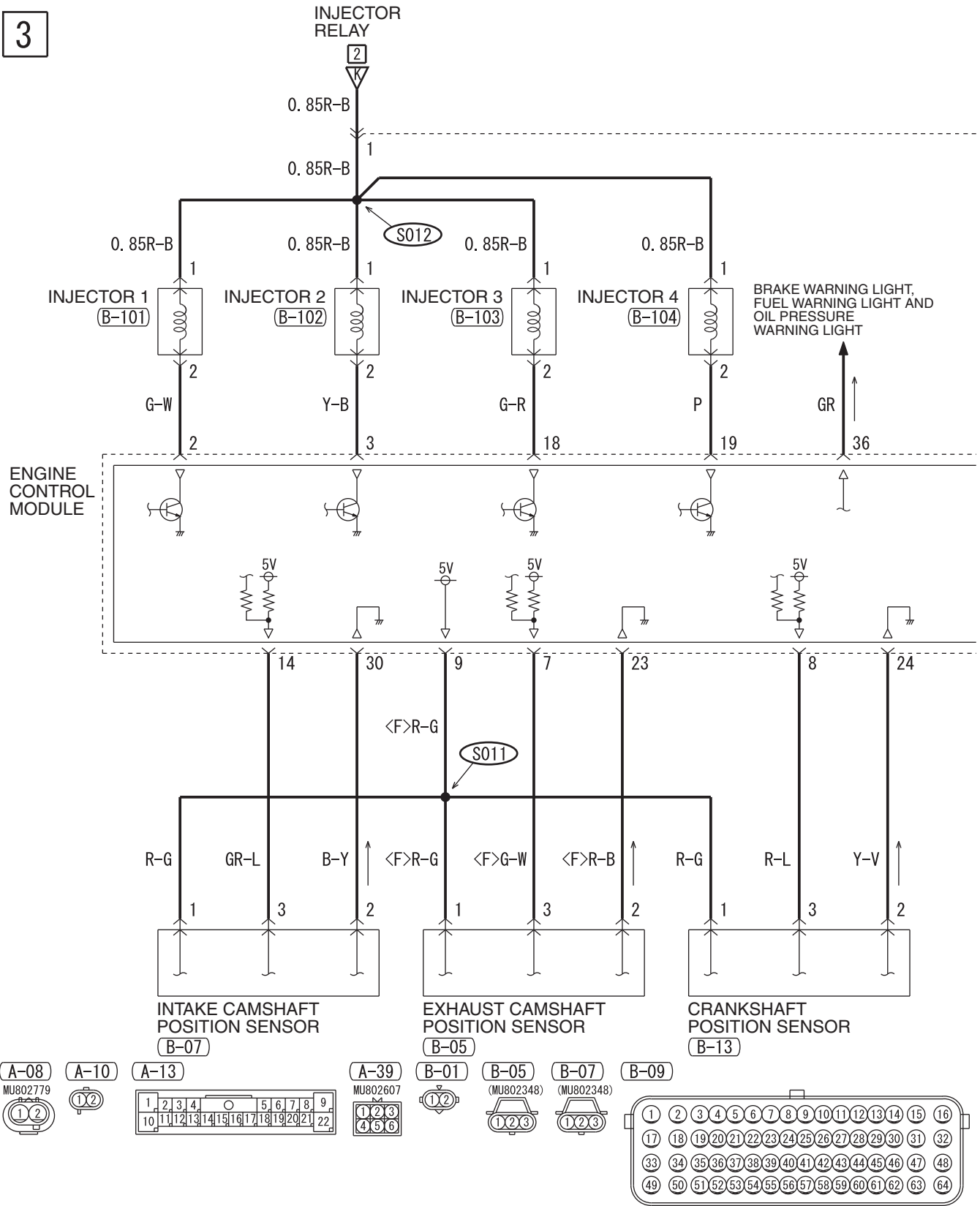

HAH05M02BA

4

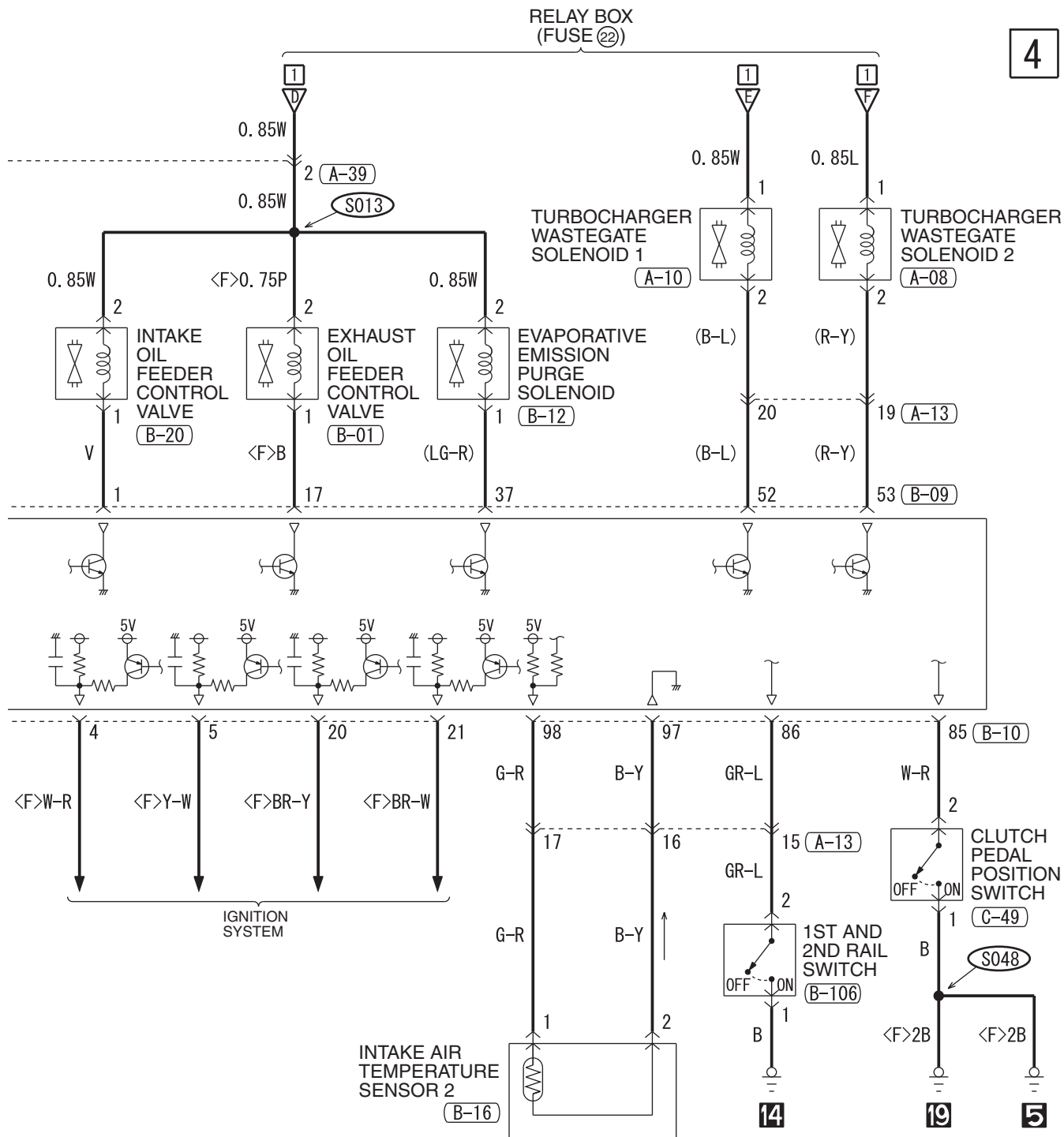

(B-10)

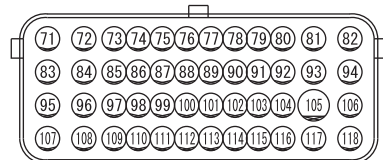

- (B-12) MU802779
- (B-13) (MU802348)
- (B-16) (MU802409)
- (B-20) (1X2)
- (B-101) (MU802062)
- (B-102) (MU802062)
- (B-103) (MU802062)
- (B-104) (MU802062)
- (B-106) MU802661
- (C-49) (1 12)

WIRE COLOR CODE  
 B : BLACK LG : LIGHT GREEN G : GREEN L : BLUE W : WHITE  
 Y : YELLOW SB : SKY BLUE BR : BROWN O : ORANGE GR : GRAY  
 R : RED P : PINK V : VIOLET PU : PURPLE SI : SILVER

HAH05M02BB

TSB Revision

MFI SYSTEM <M/T> (CONTINUED)

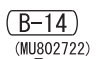
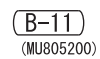
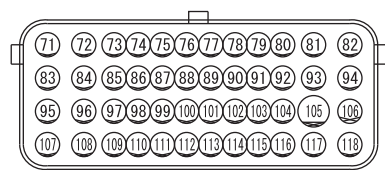
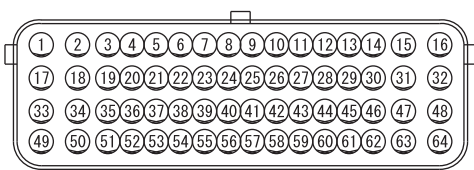
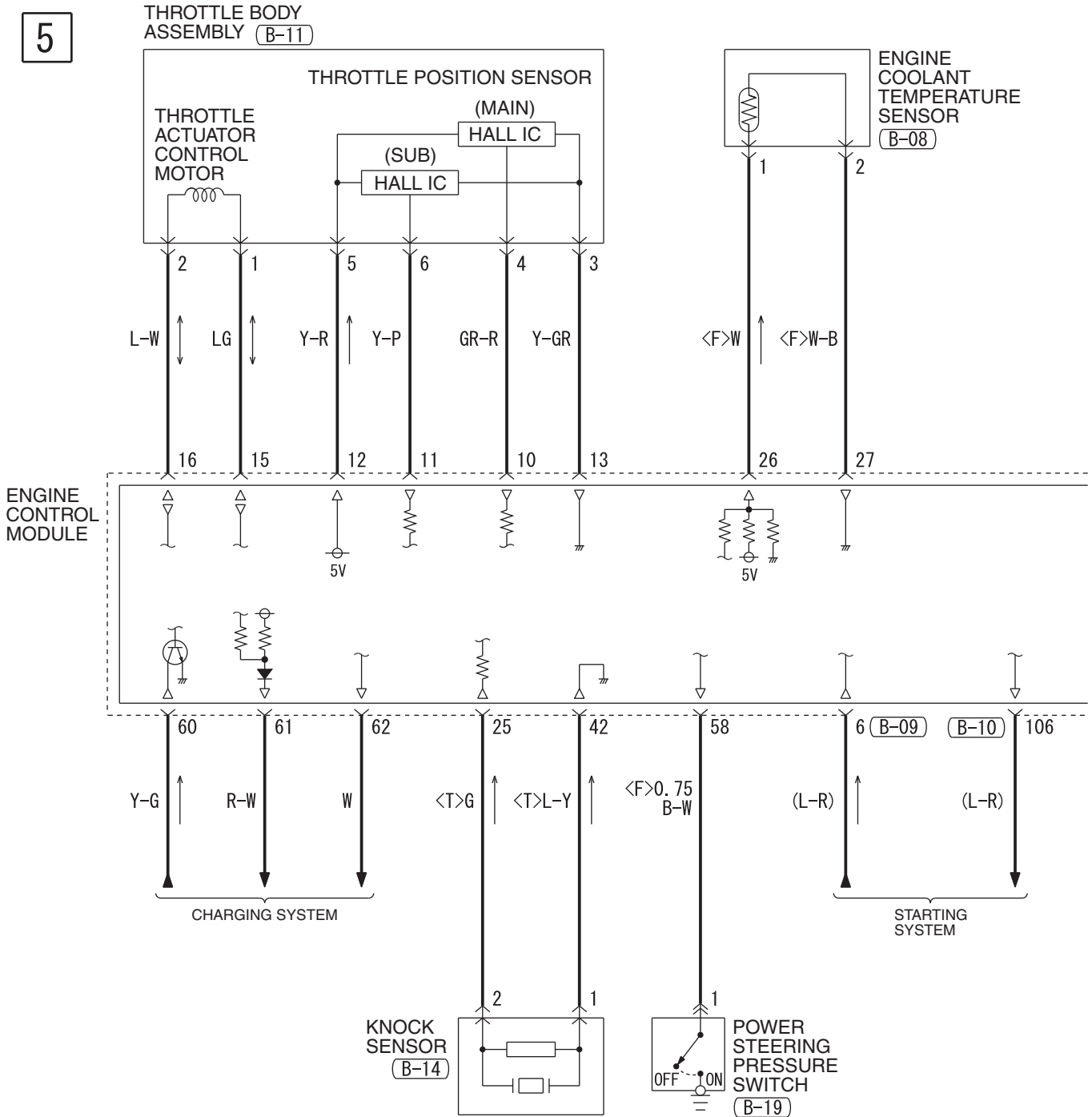

6

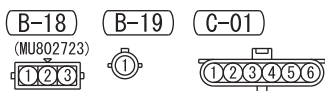
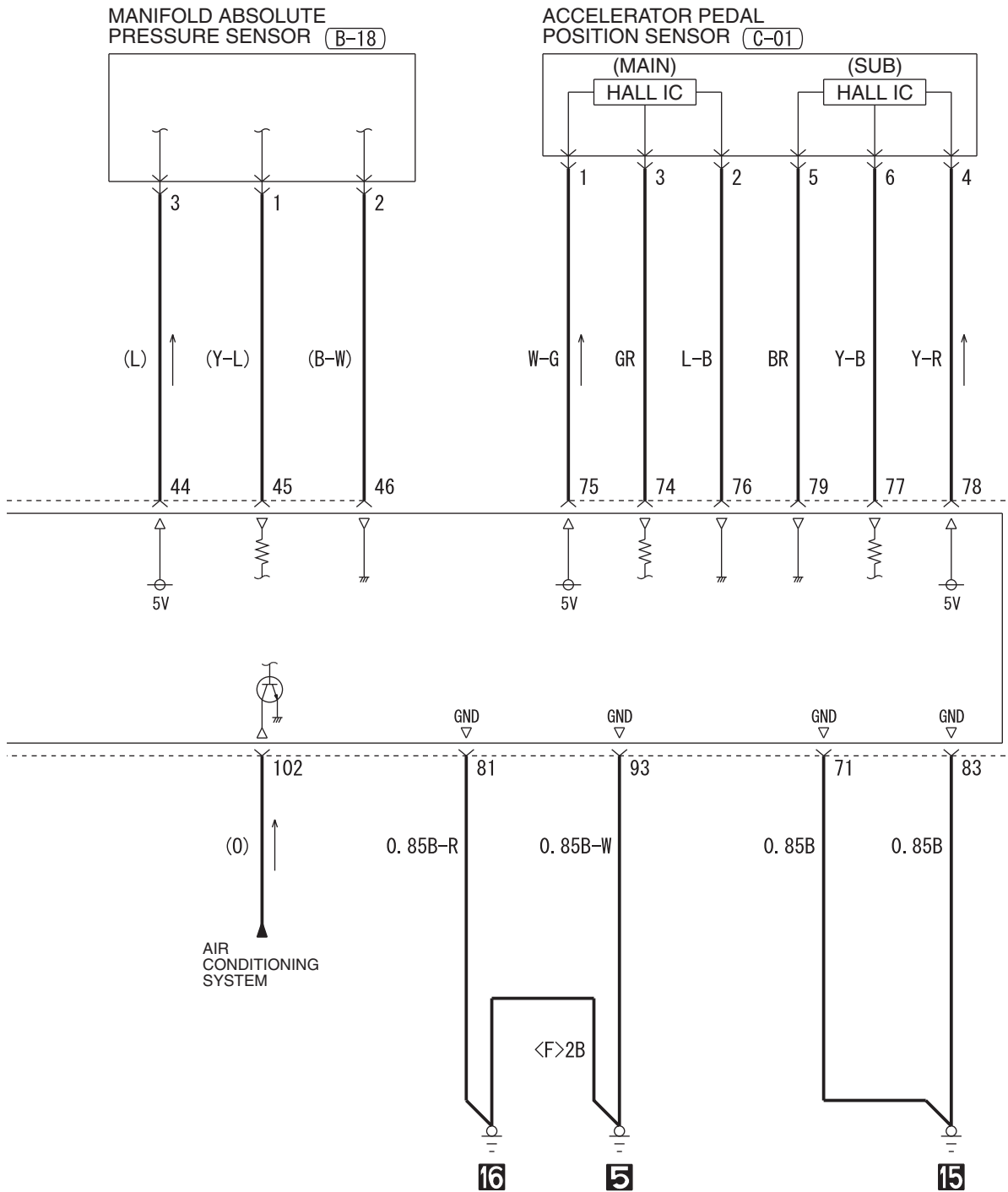

WIRE COLOR CODE  
 B: BLACK LG: LIGHT GREEN G: GREEN L: BLUE W: WHITE Y: YELLOW SB: SKY BLUE  
 BR: BROWN O: ORANGE GR: GRAY R: RED P: PINK V: VIOLET PU: PURPLE SI: SILVER

HAH05M02CB

TSB Revision

MFI SYSTEM <M/T> (CONTINUED)

7

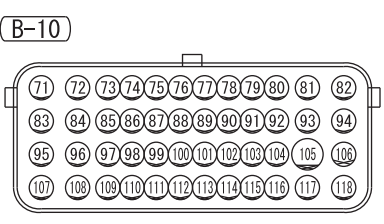
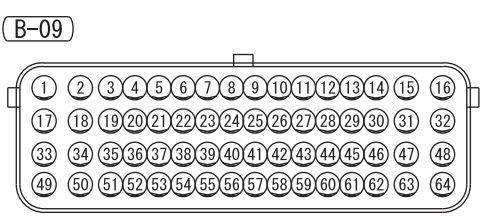
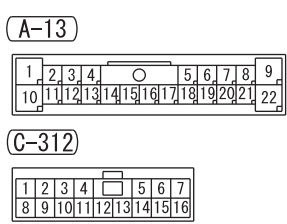
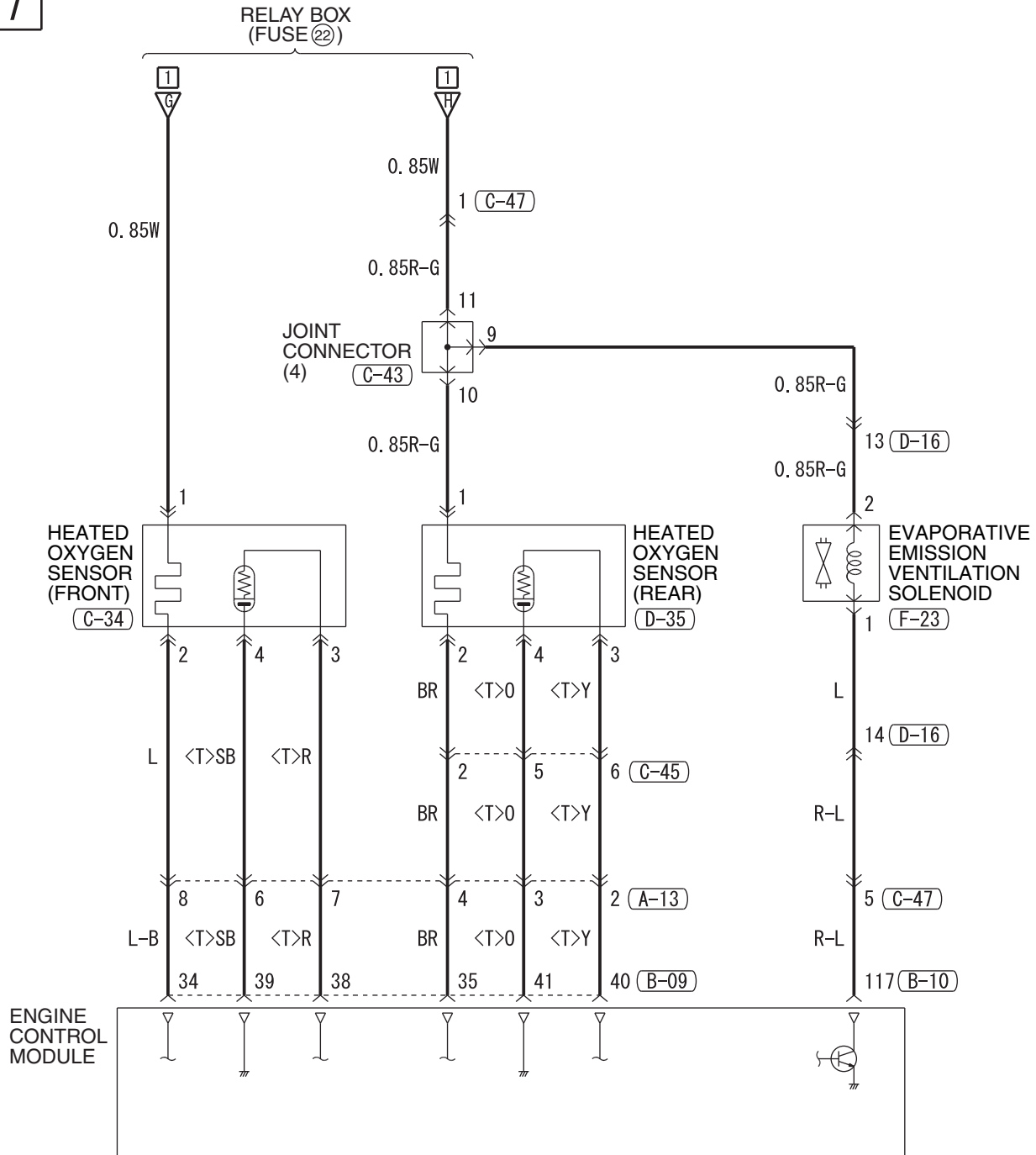

8

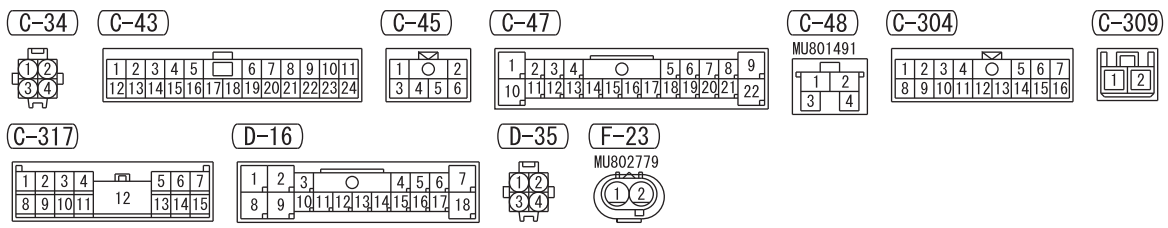
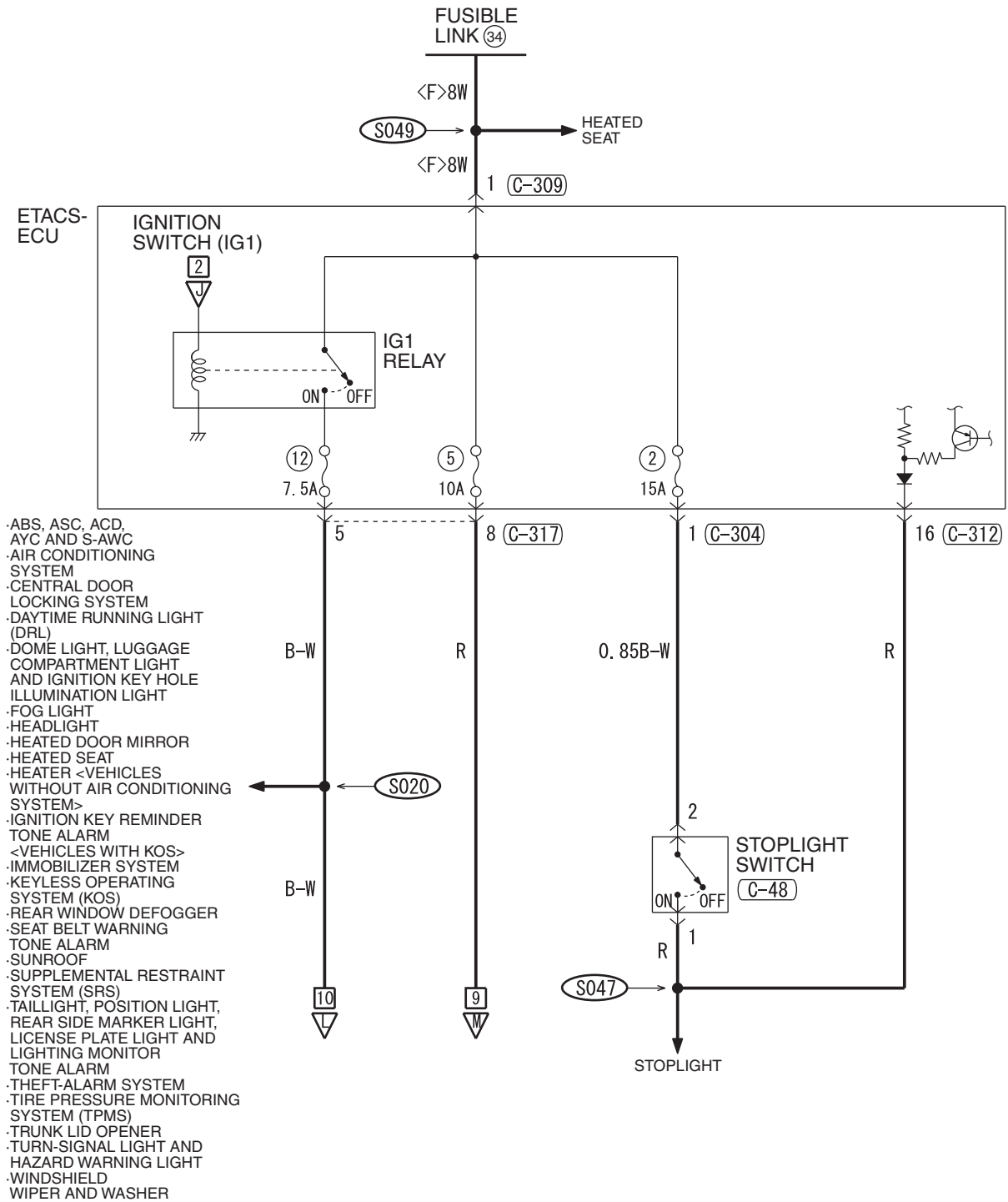

MFI SYSTEM <M/T> (CONTINUED)

9

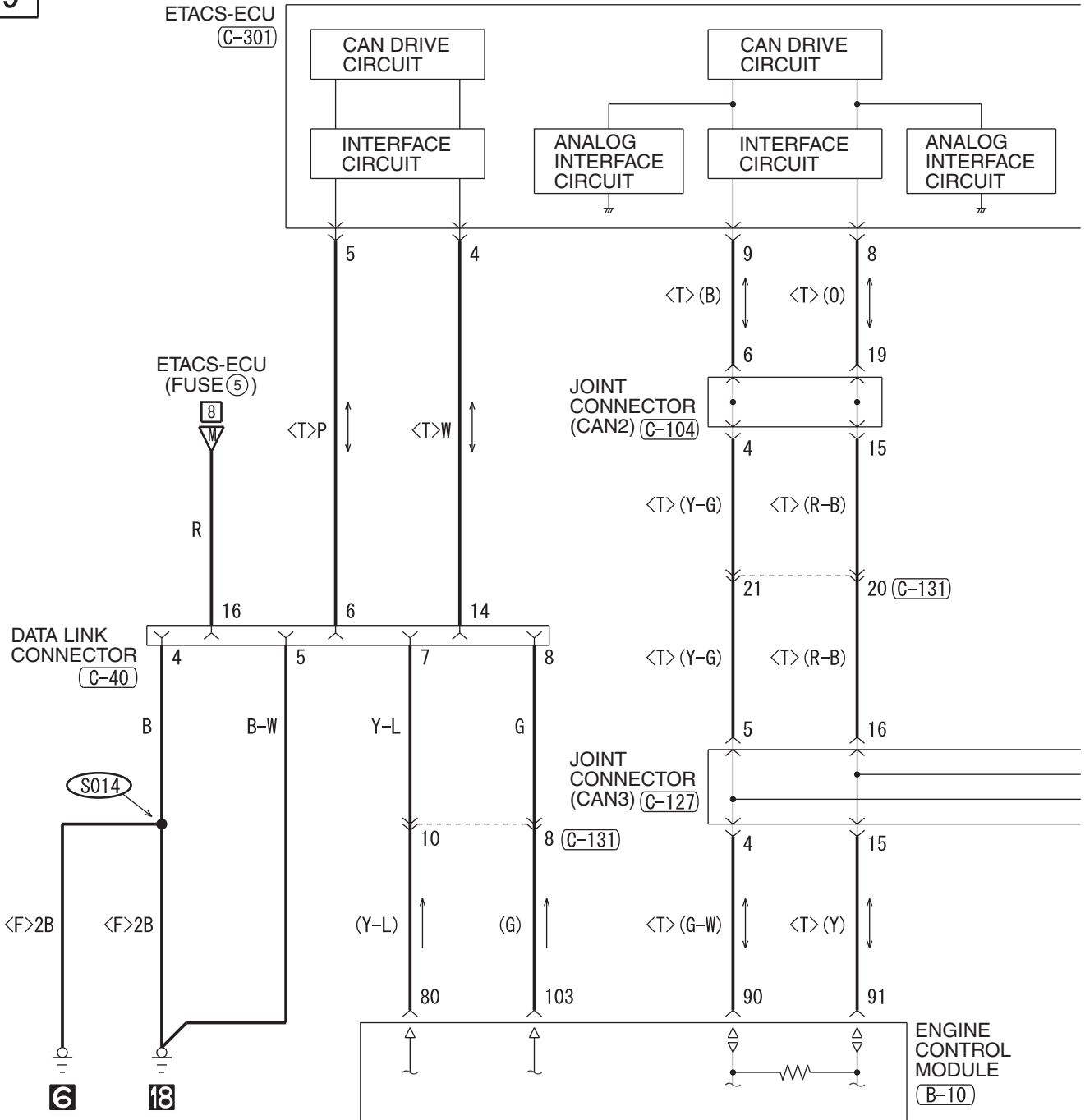

(A-05)

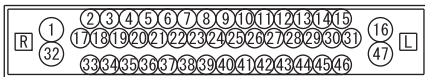

(B-10)

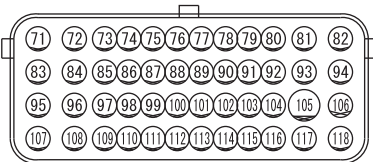

(C-04)

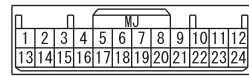

(C-22)

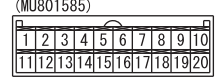

(C-131)

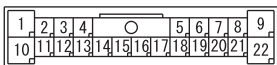

(C-301)

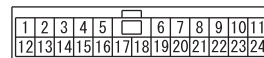



10

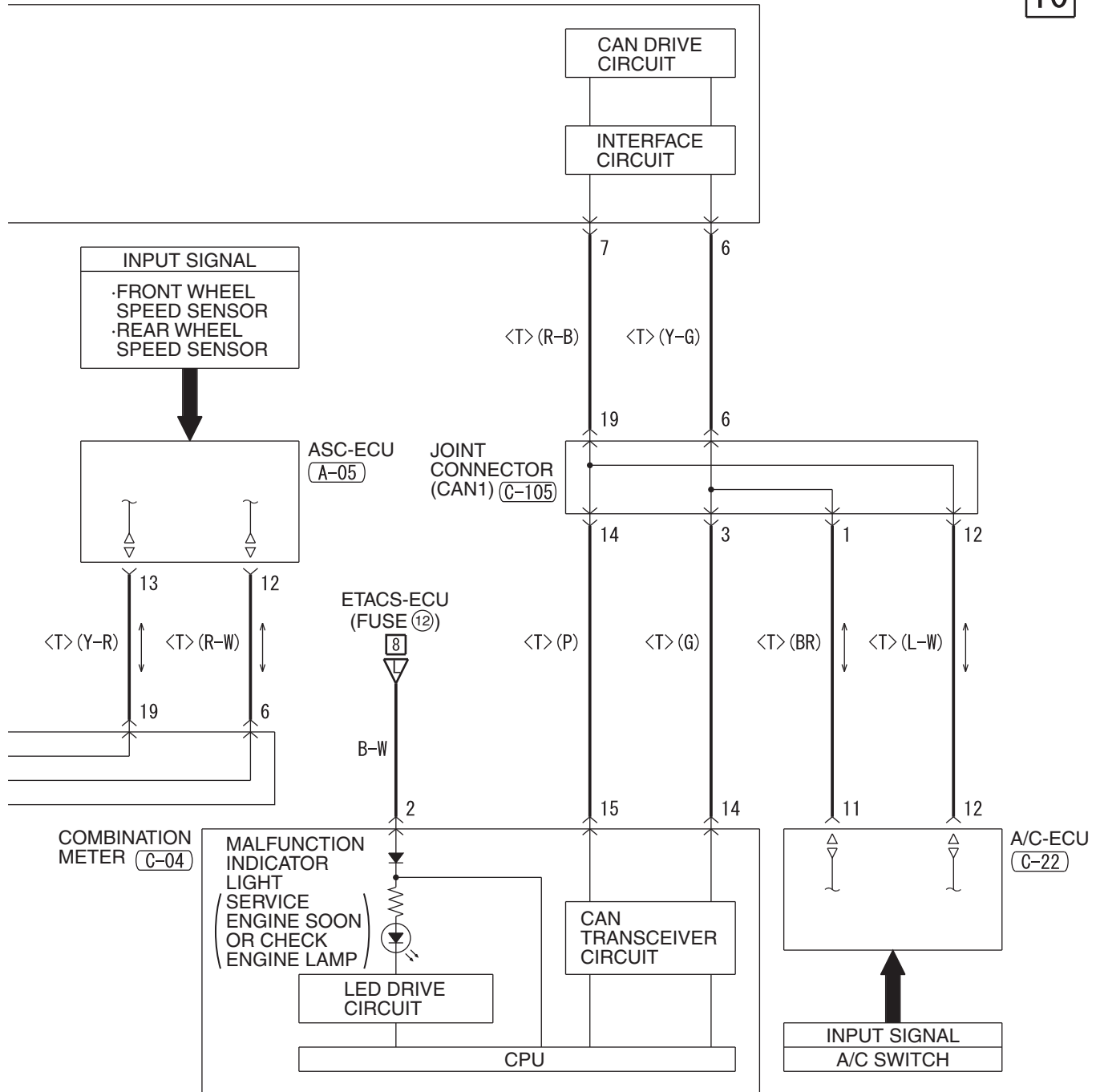

(C-40) FRONT SIDE

(C-104)

(C-105)

(C-127)

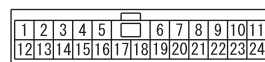
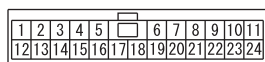
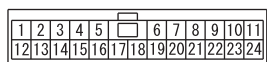
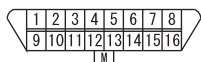

WIRE COLOR CODE

B: BLACK LG: LIGHT GREEN G: GREEN L: BLUE W: WHITE Y: YELLOW SB: SKY BLUE  
BR: BROWN O: ORANGE GR: GRAY R: RED P: PINK V: VIOLET PU: PURPLE SI: SILVER

HAH05M02EB

MFI SYSTEM <M/T> (CONTINUED)

11

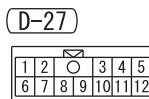
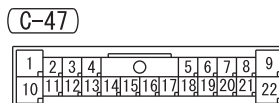
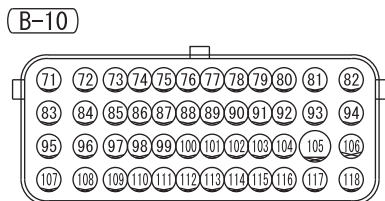
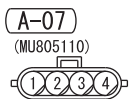
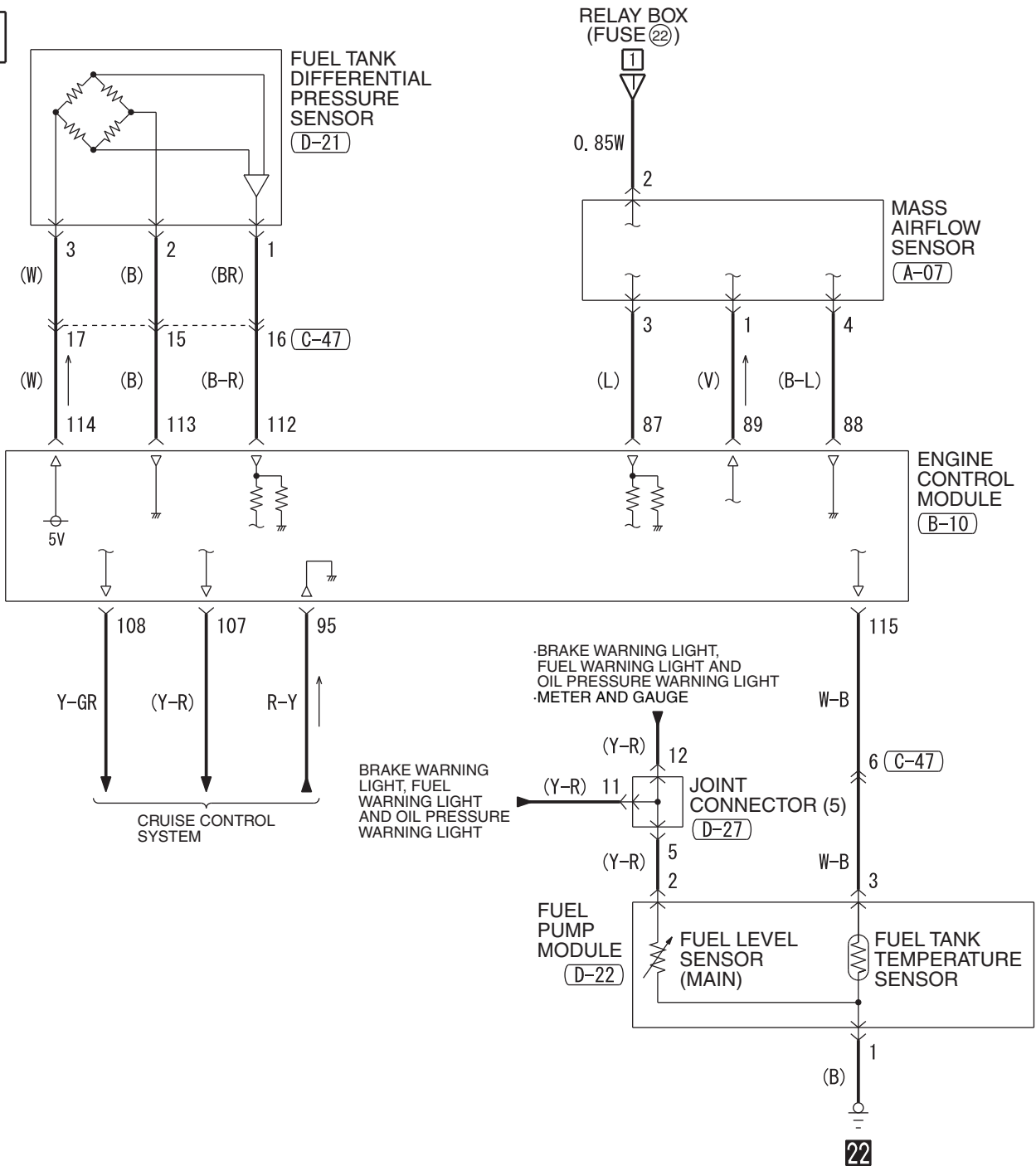

NOTES

MFI SYSTEM <TC-SST>

M1901000809647

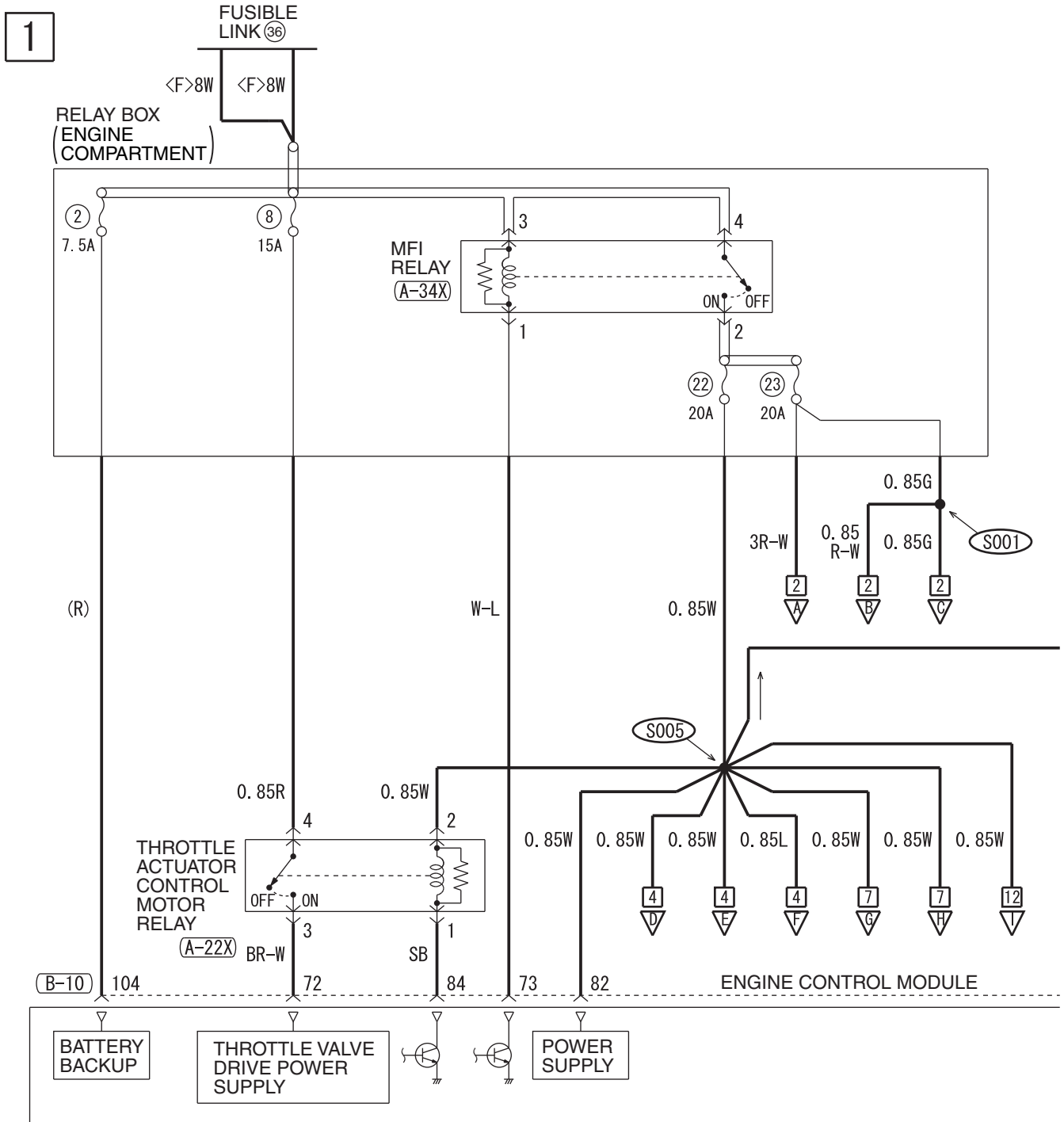

(A-13)

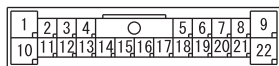

(A-22X)



(A-25X)



(A-27X)



(A-34X)



(A-58)



(B-09)

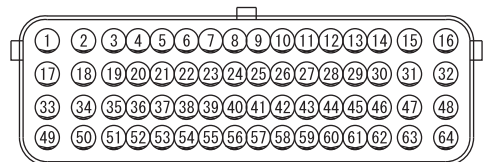

(C-317)

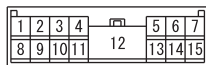

(D-22)



HAH05M03AA

2

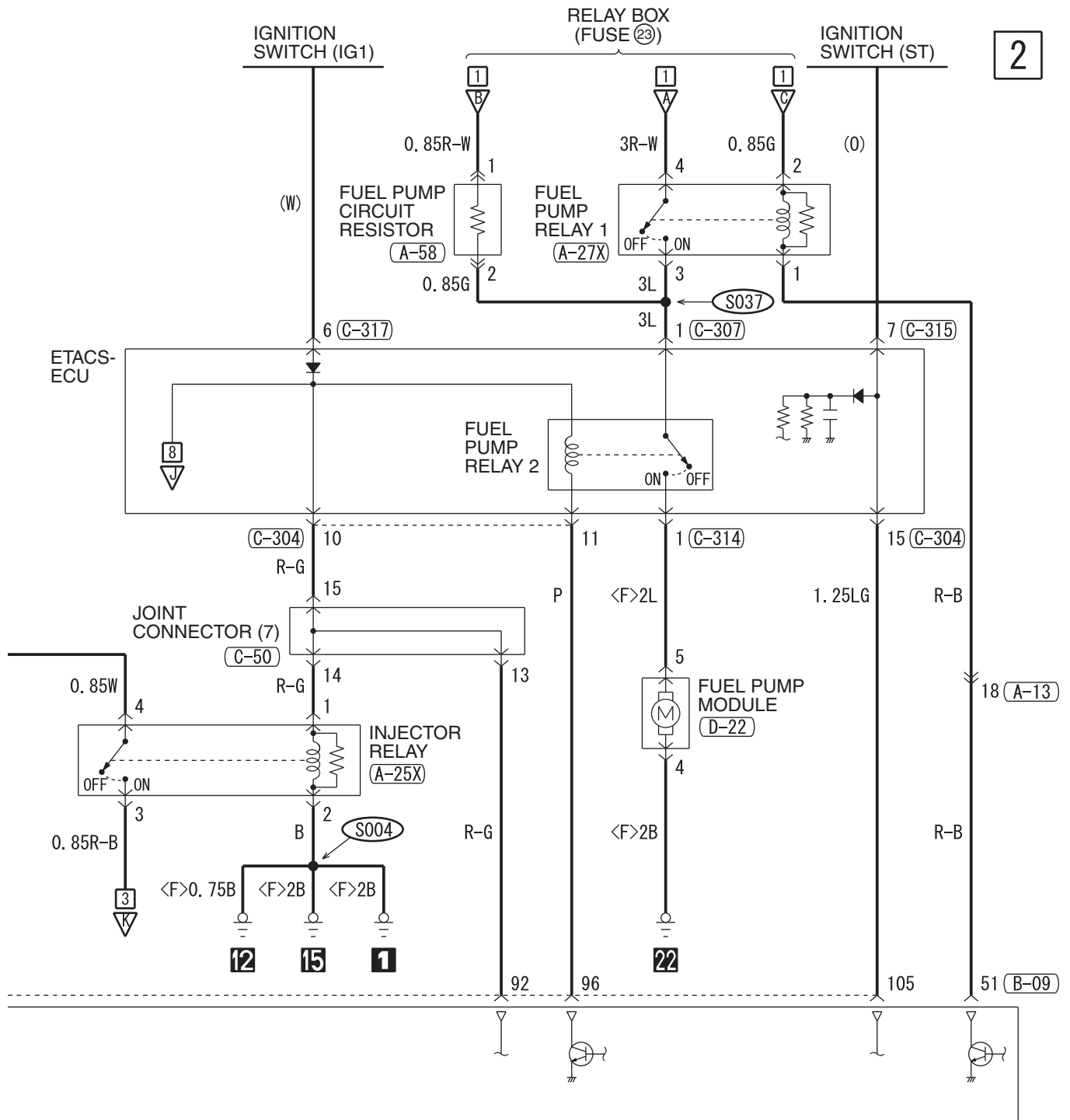

(B-10)

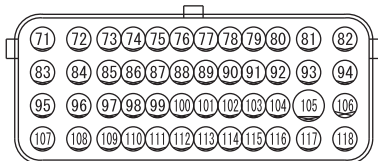

(C-50)



(C-304)

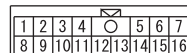

(C-307)



(C-314)



(C-315)

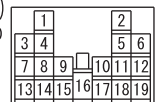

WIRE COLOR CODE

B : BLACK LG : LIGHT GREEN G : GREEN L : BLUE W : WHITE  
Y : YELLOW SB : SKY BLUE BR : BROWN O : ORANGE GR : GRAY  
R : RED P : PINK V : VIOLET PU : PURPLE SI : SILVER

HAH05M03AB

MFI SYSTEM <TC-SST> (CONTINUED)

3

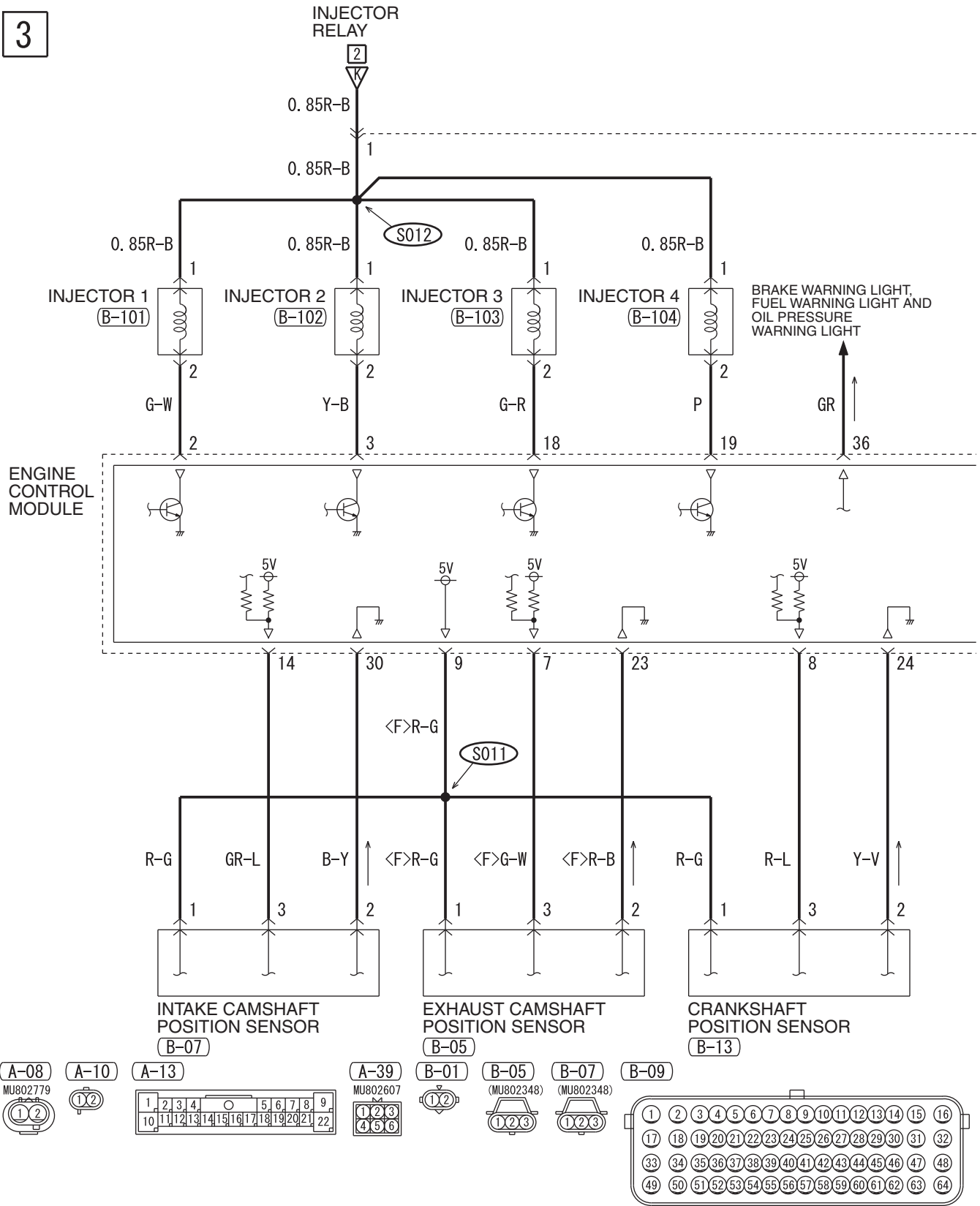

HAH05M03BA

4

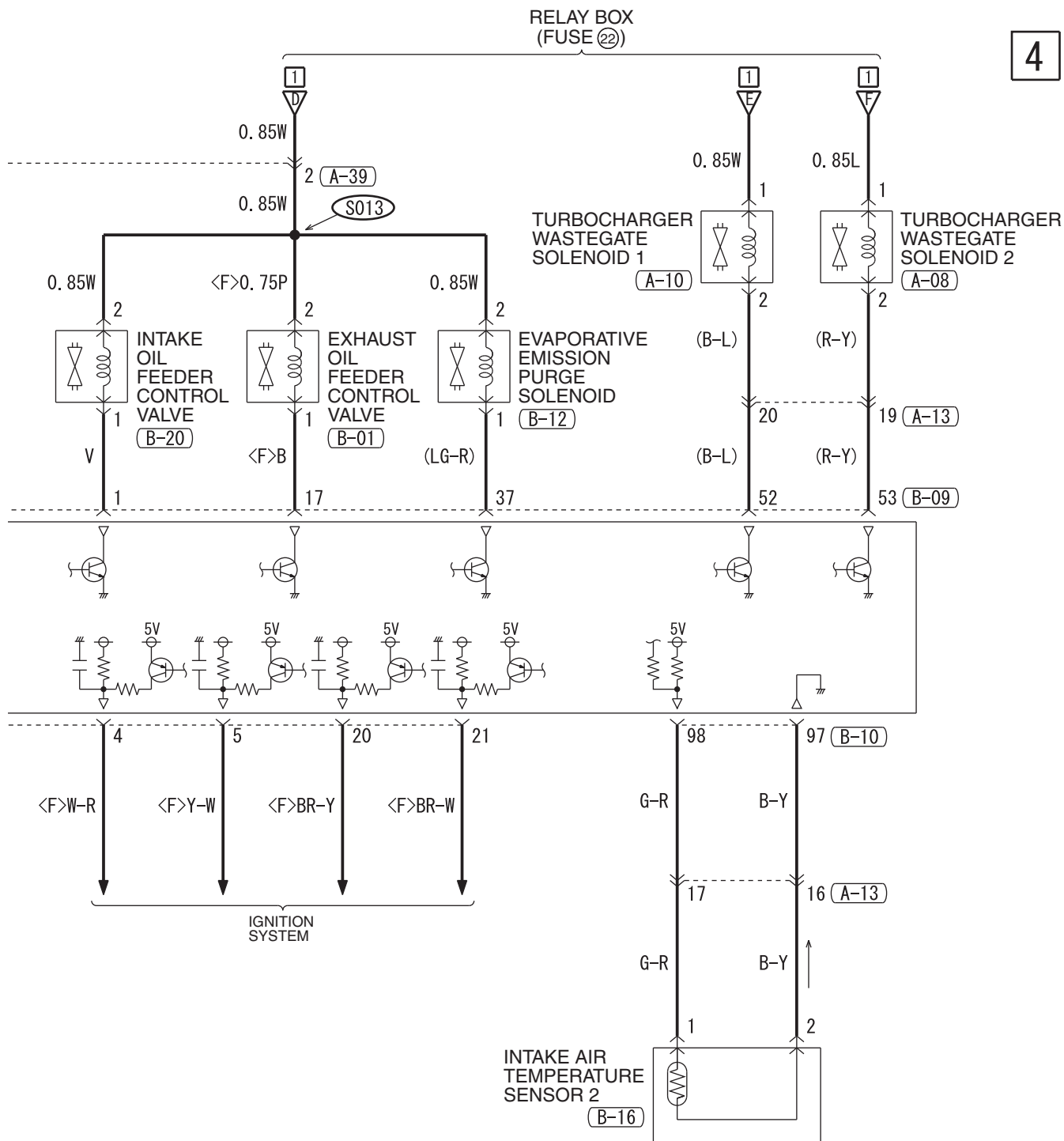

(B-10)

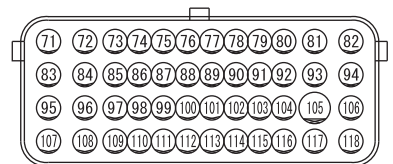

- (B-12) MU802779
- (B-13) (MU802348)
- (B-16) (MU802409)
- (B-20) (1X2)
- (B-101) (MU802062)
- (B-102) (MU802062)
- (B-103) (MU802062)
- (B-104) (MU802062)

**WIRE COLOR CODE**  
 B: BLACK LG: LIGHT GREEN G: GREEN L: BLUE W: WHITE  
 Y: YELLOW SB: SKY BLUE BR: BROWN O: ORANGE GR: GRAY  
 R: RED P: PINK V: VIOLET PU: PURPLE SI: SILVER

HAH05M03BB

**TSB Revision**

MFI SYSTEM <TC-SST> (CONTINUED)

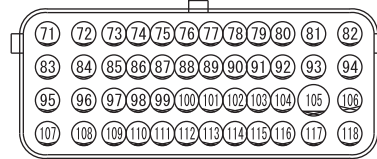
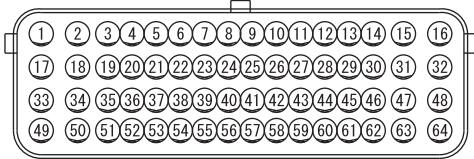
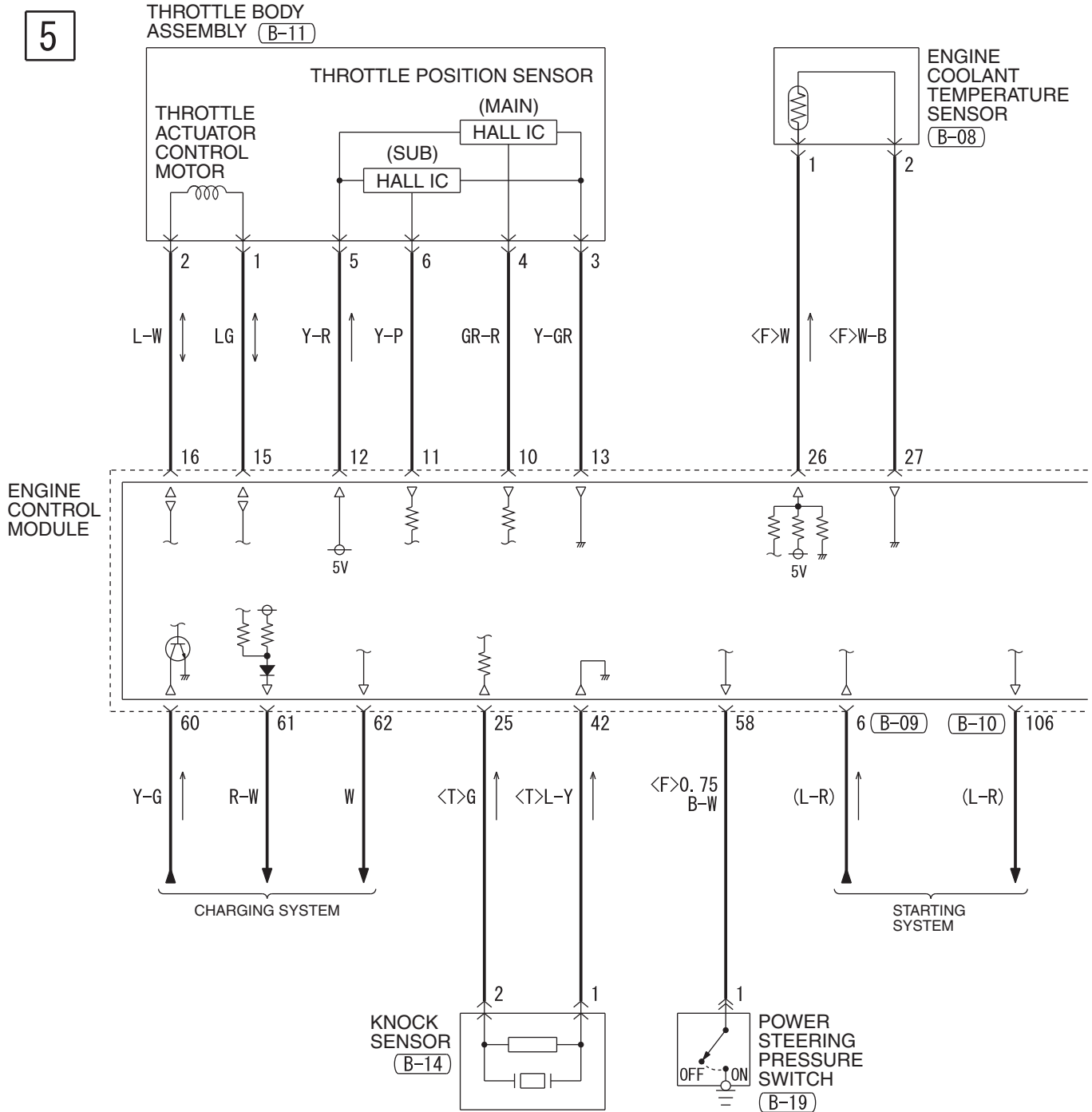



6

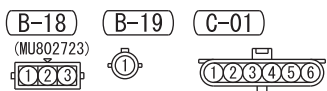
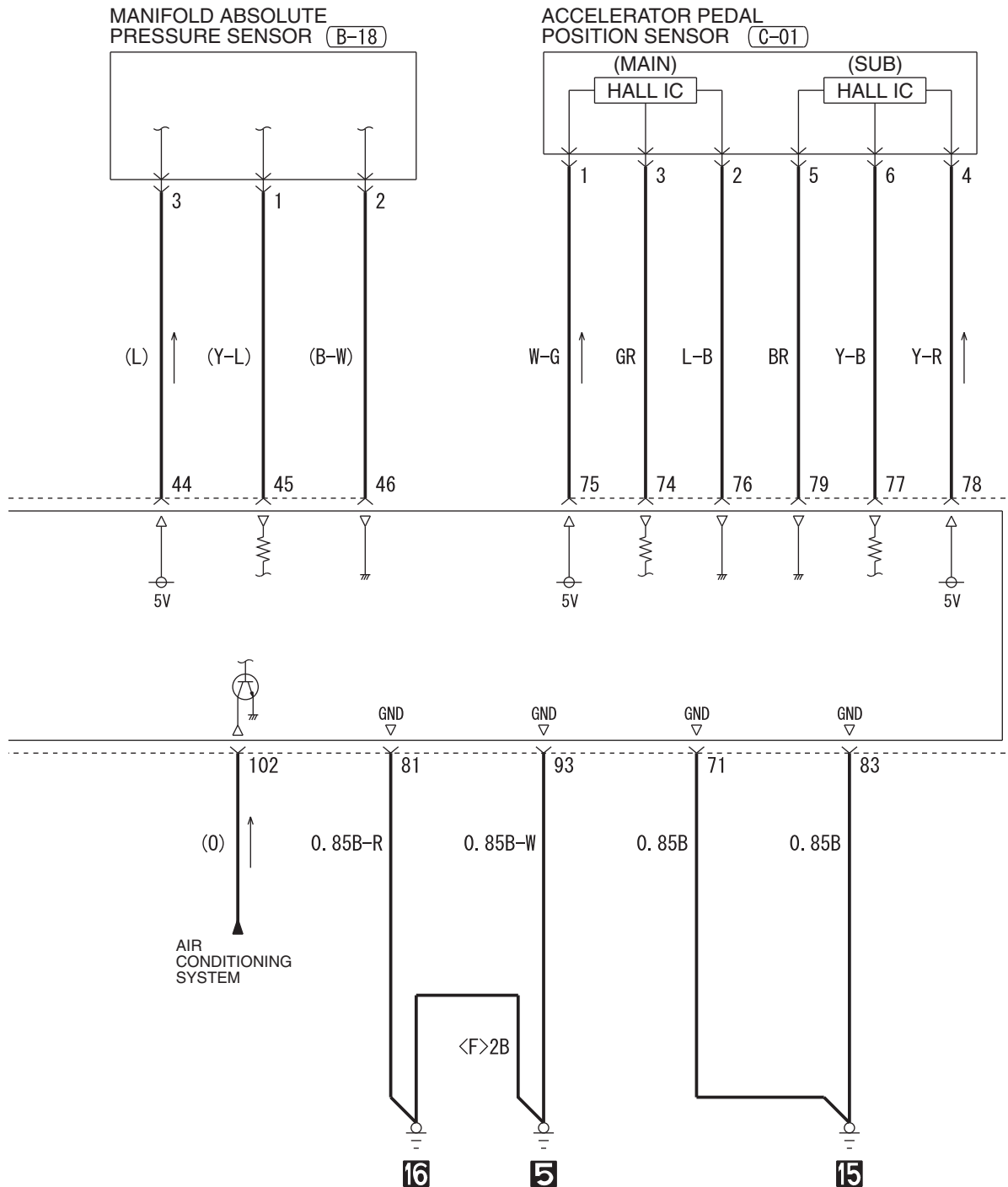

WIRE COLOR CODE  
 B: BLACK LG: LIGHT GREEN G: GREEN L: BLUE W: WHITE Y: YELLOW SB: SKY BLUE  
 BR: BROWN O: ORANGE GR: GRAY R: RED P: PINK V: VIOLET PU: PURPLE SI: SILVER

HAH05M03CB

MFI SYSTEM <TC-SST> (CONTINUED)

7

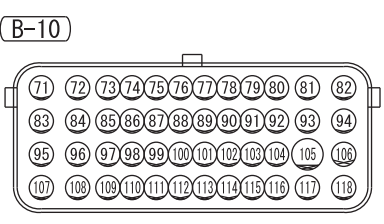
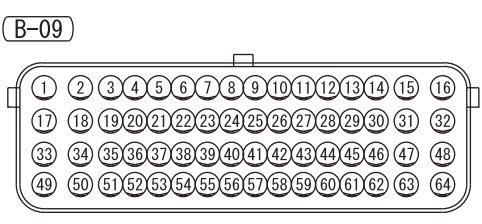
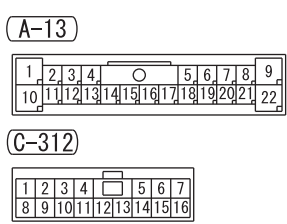
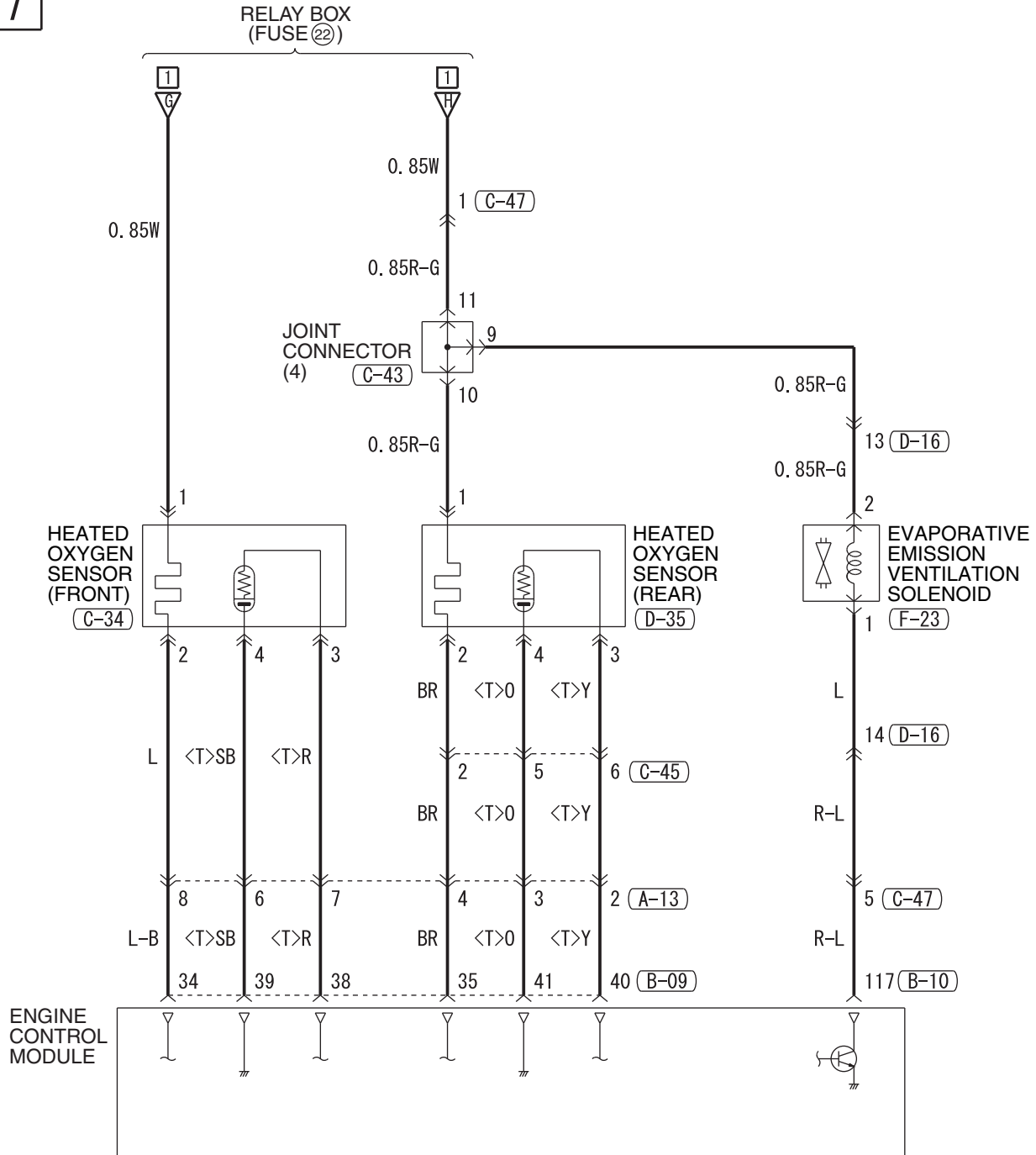

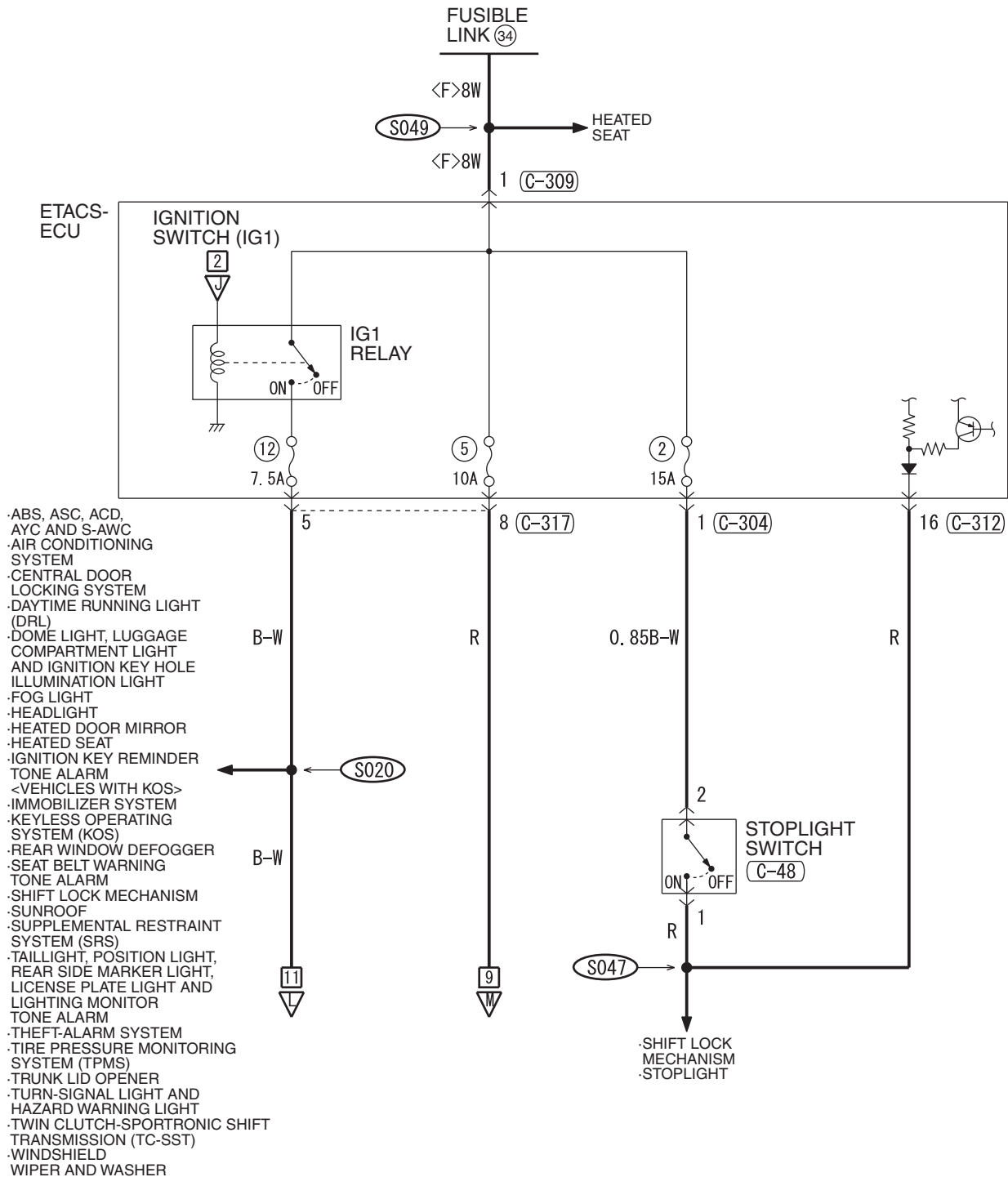

- ABS, ASC, ACD, AYC AND S-AWC
- AIR CONDITIONING SYSTEM
- CENTRAL DOOR LOCKING SYSTEM
- DAYTIME RUNNING LIGHT (DRL)
- DOME LIGHT, LUGGAGE COMPARTMENT LIGHT AND IGNITION KEY HOLE ILLUMINATION LIGHT
- FOG LIGHT
- HEADLIGHT
- HEATED DOOR MIRROR
- HEATED SEAT
- IGNITION KEY REMINDER TONE ALARM
- <VEHICLES WITH KOS> IMMOBILIZER SYSTEM
- KEYLESS OPERATING SYSTEM (KOS)
- REAR WINDOW DEFOGGER
- SEAT BELT WARNING TONE ALARM
- SHIFT LOCK MECHANISM
- SUNROOF
- SUPPLEMENTAL RESTRAINT SYSTEM (SRS)
- TAILLIGHT, POSITION LIGHT, REAR SIDE MARKER LIGHT, LICENSE PLATE LIGHT AND LIGHTING MONITOR TONE ALARM
- THEFT-ALARM SYSTEM
- TIRE PRESSURE MONITORING SYSTEM (TPMS)
- TRUNK LID OPENER
- TURN-SIGNAL LIGHT AND HAZARD WARNING LIGHT
- TWIN CLUTCH-SPORTRONIC SHIFT TRANSMISSION (TC-SST)
- WINDSHIELD WIPER AND WASHER

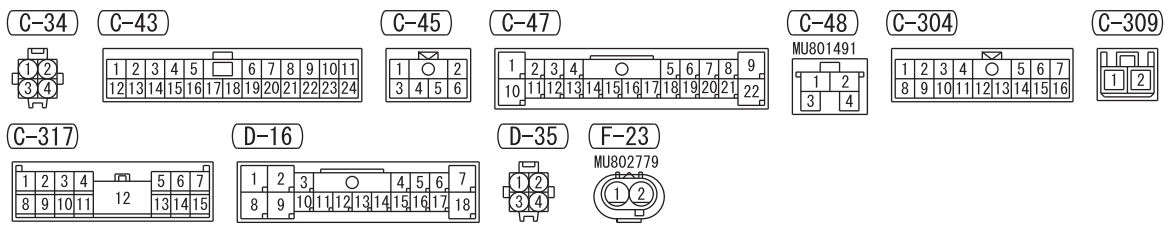

MFI SYSTEM <TC-SST> (CONTINUED)

9

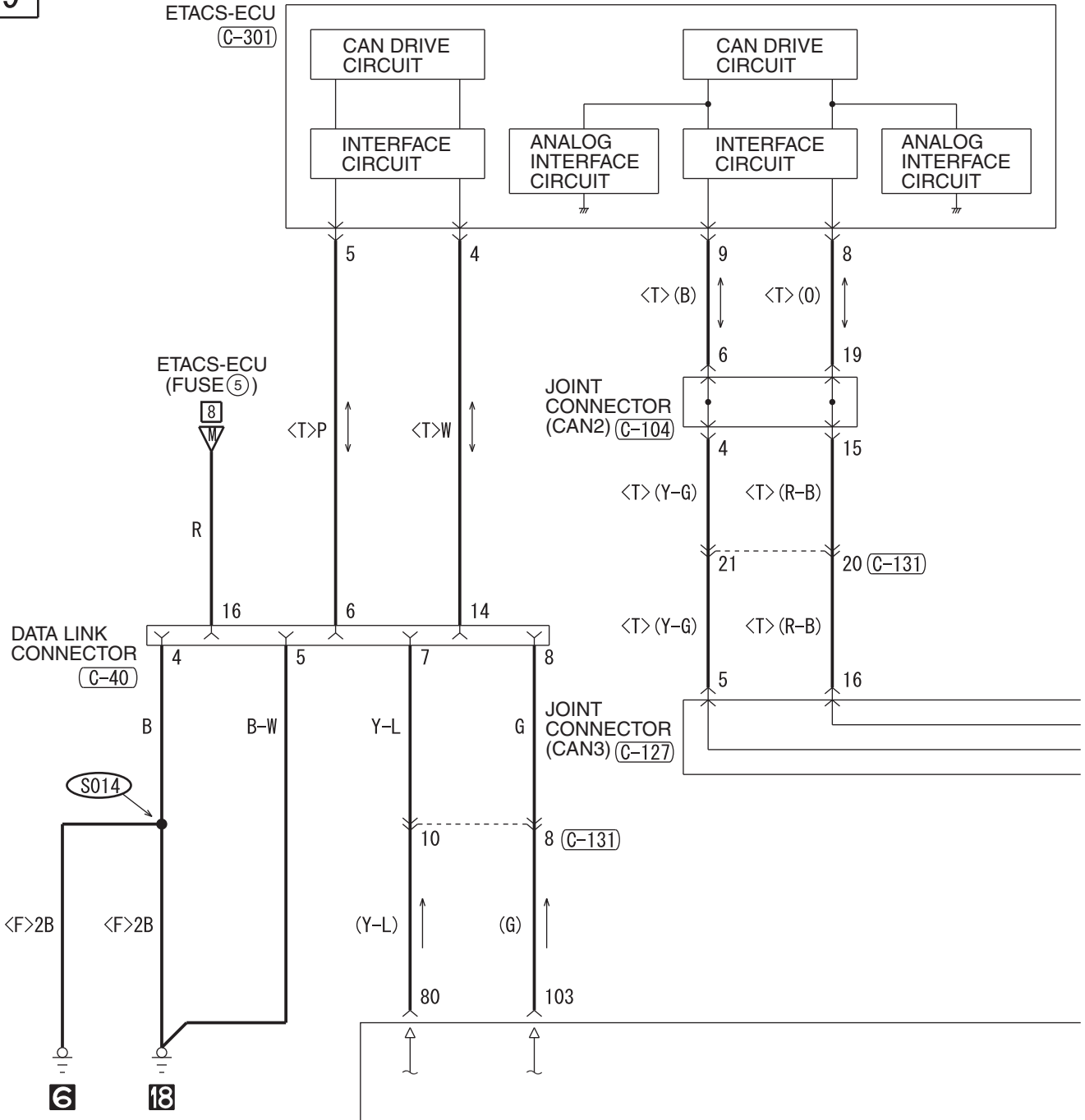

(A-05)

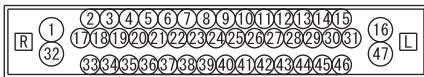

(A-13)

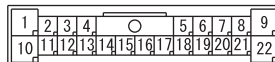

(A-14)

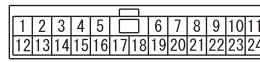

(C-127)

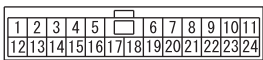

(C-131)

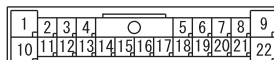

(C-301)

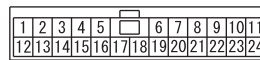

10

NOTE  
\* : THE TERMINAL NUMBERS DESCRIBED  
IN THE CIRCUIT DIAGRAM AGREE WITH  
THE NUMBERS MARKED ON THE  
TRANSAXLE ASSEMBLY CONNECTOR AND  
HARNESS SIDE CONNECTOR.

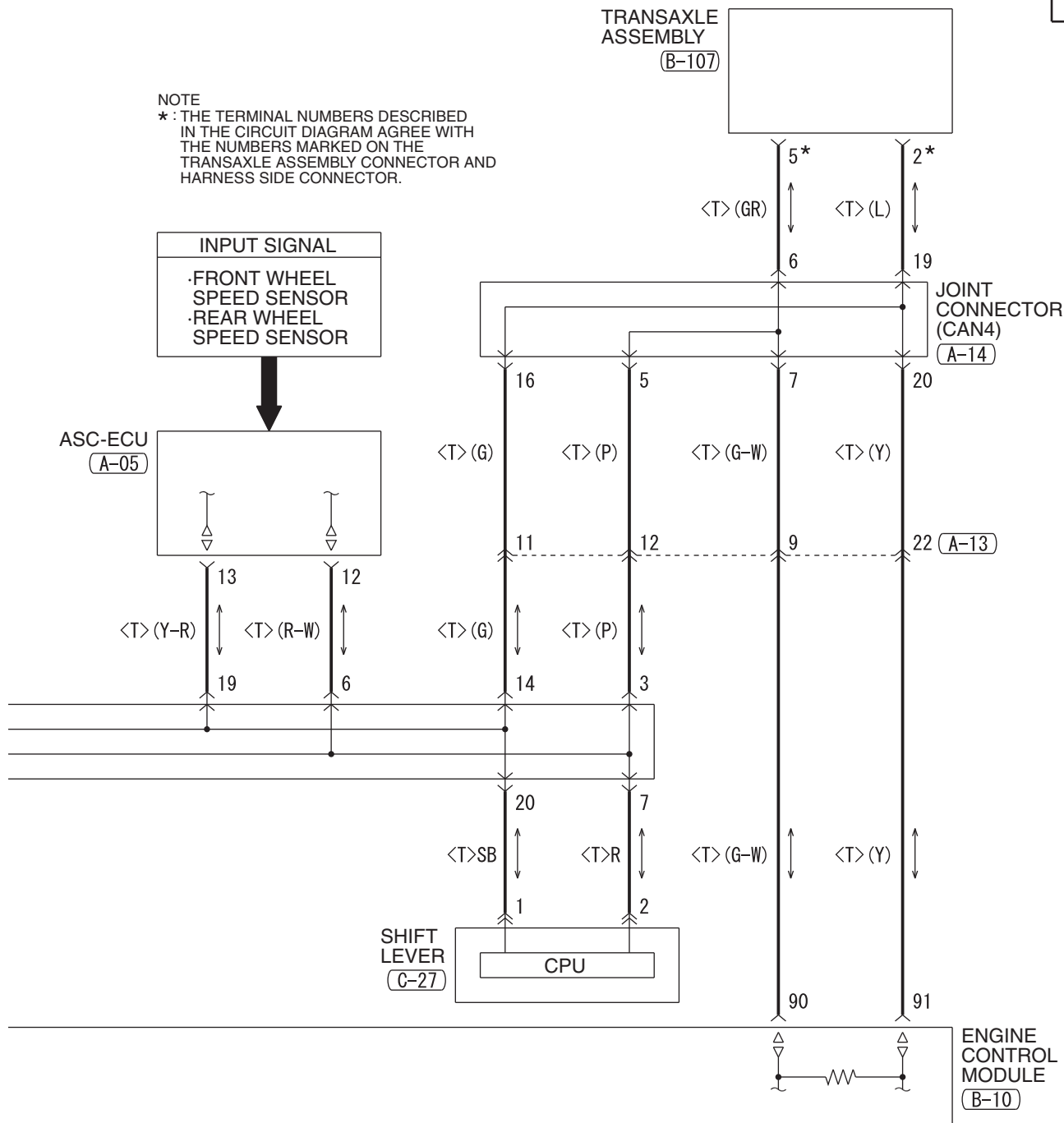

(B-10)

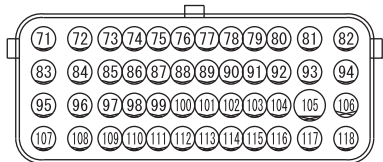

(B-107)\*



(C-27)

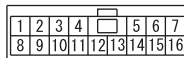

(C-40) FRONT SIDE



(C-104)

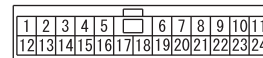

MFI SYSTEM <TC-SST> (CONTINUED)

11

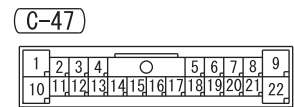
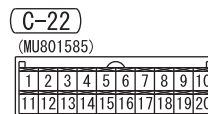
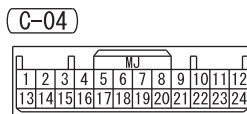
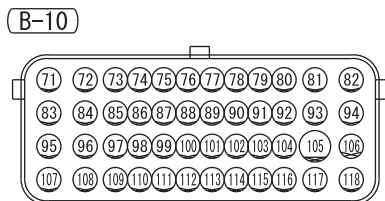
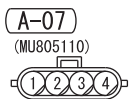
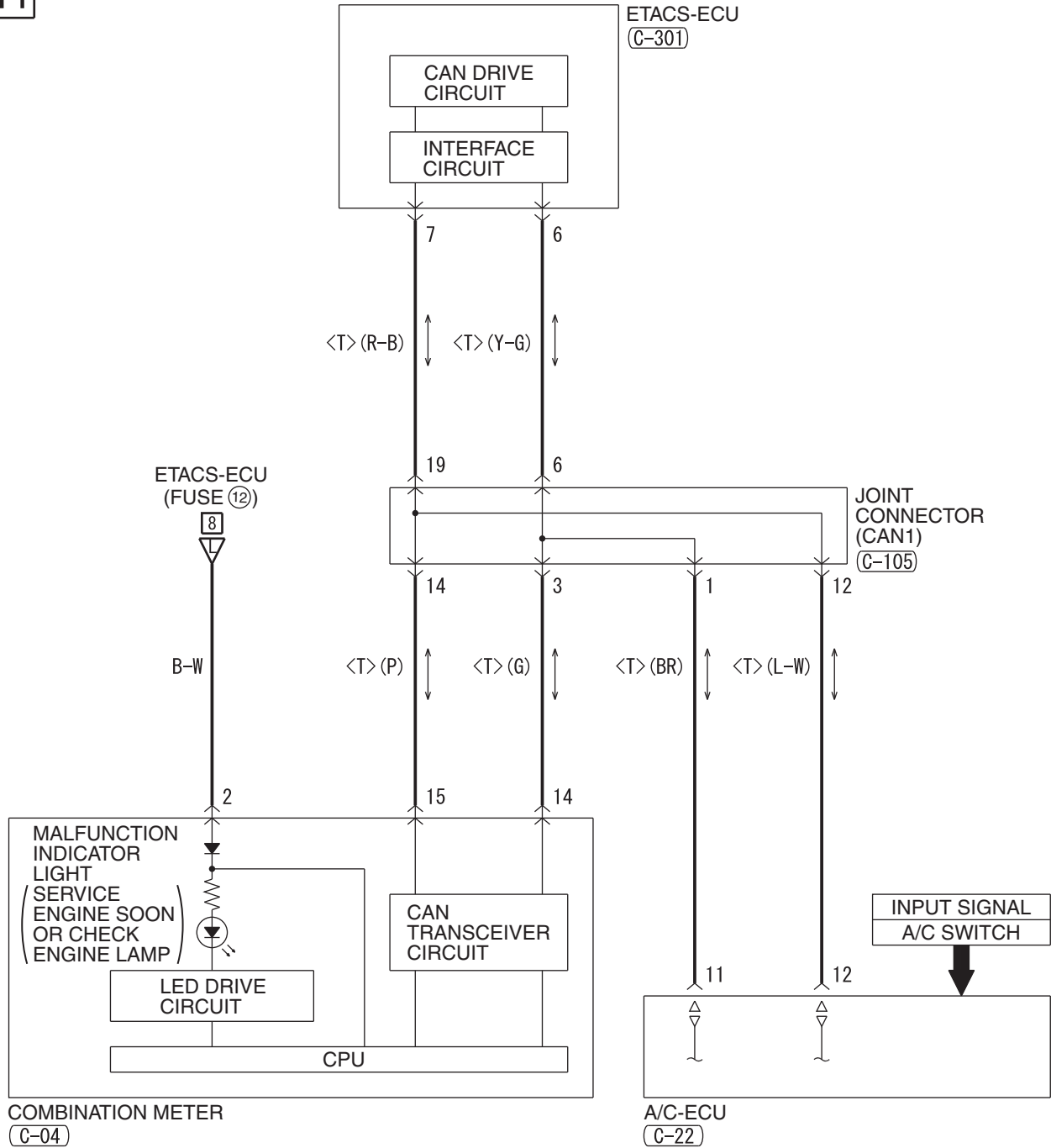

12

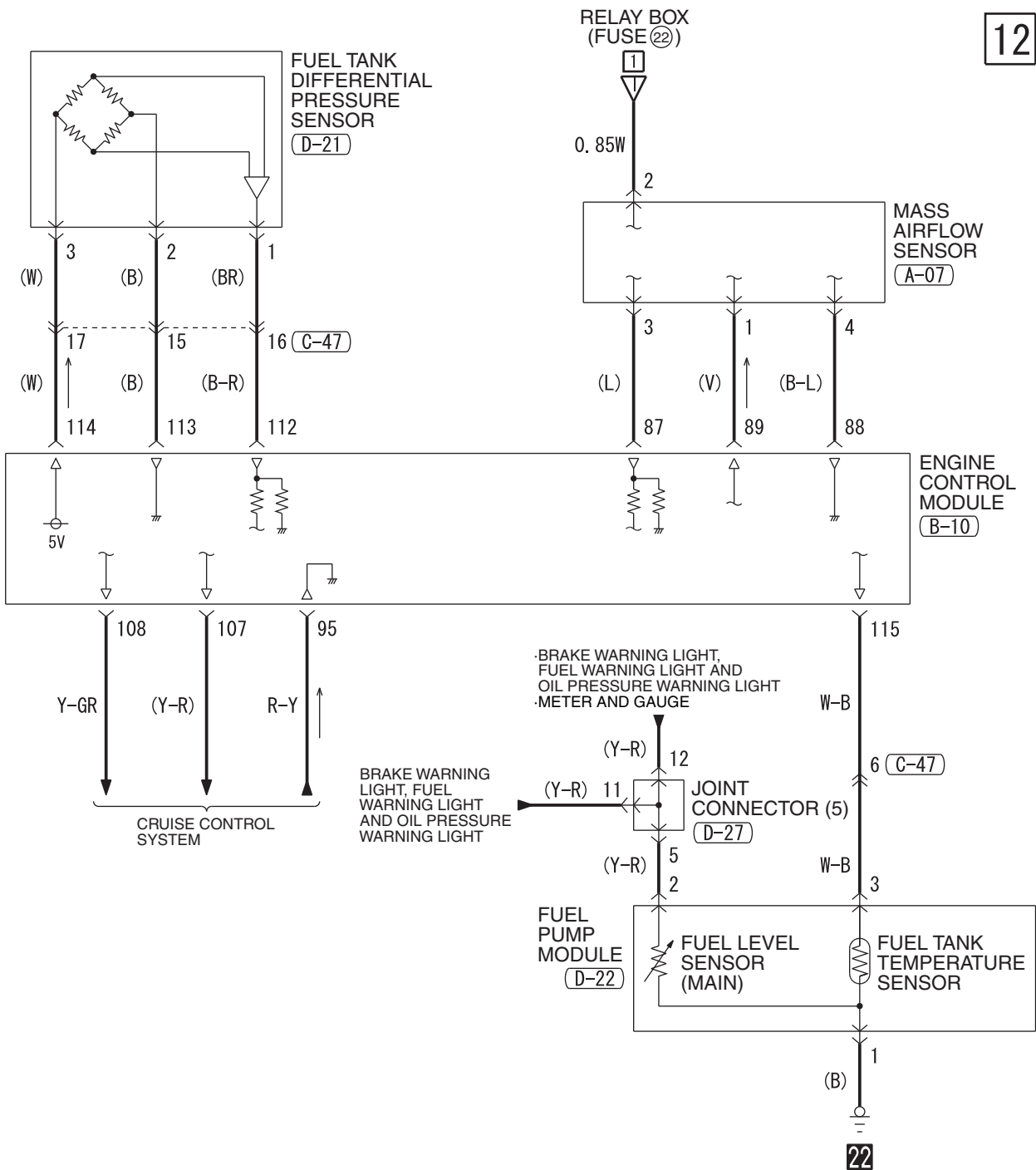

(C-105)



(C-301)



(D-21)



(D-22)



(D-27)

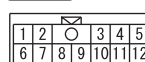

WIRE COLOR CODE

B: BLACK LG: LIGHT GREEN G: GREEN L: BLUE W: WHITE Y: YELLOW SB: SKY BLUE  
BR: BROWN O: ORANGE GR: GRAY R: RED P: PINK V: VIOLET PU: PURPLE SI: SILVER

# COOLING SYSTEM

M1901001004263

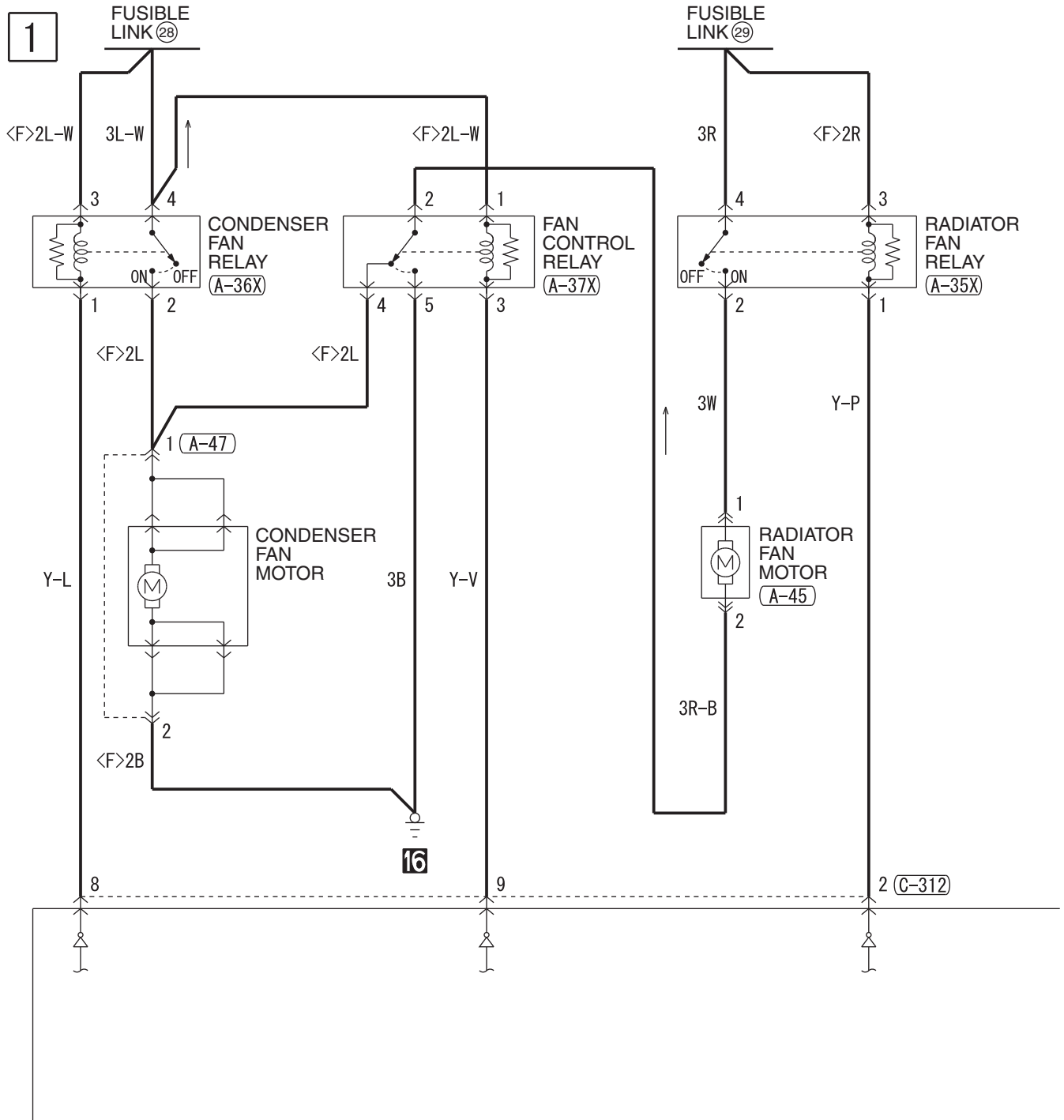

(A-05)

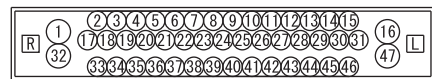

(A-13)

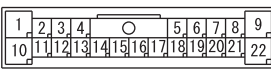

(A-14)

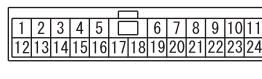

(A-35X)



(A-36X)



(A-37X)



(C-131)

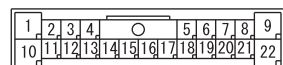

(C-301)

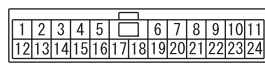

(C-312)

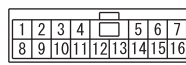

HAH06M02AA



2

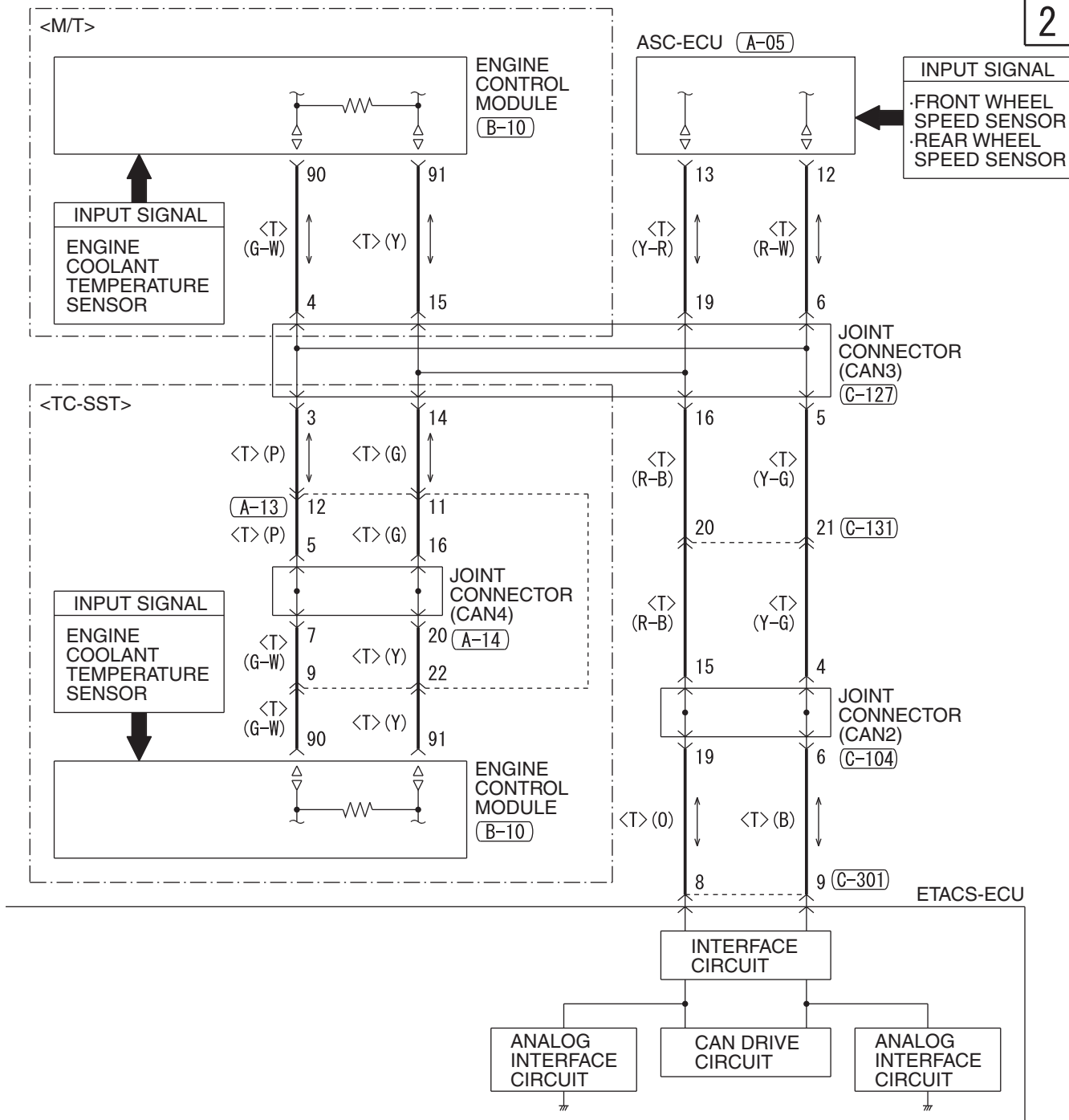

(A-45) (A-47) (B-10)

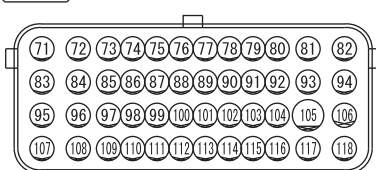

(C-104)



(C-127)



COOLING SYSTEM (CONTINUED)

3

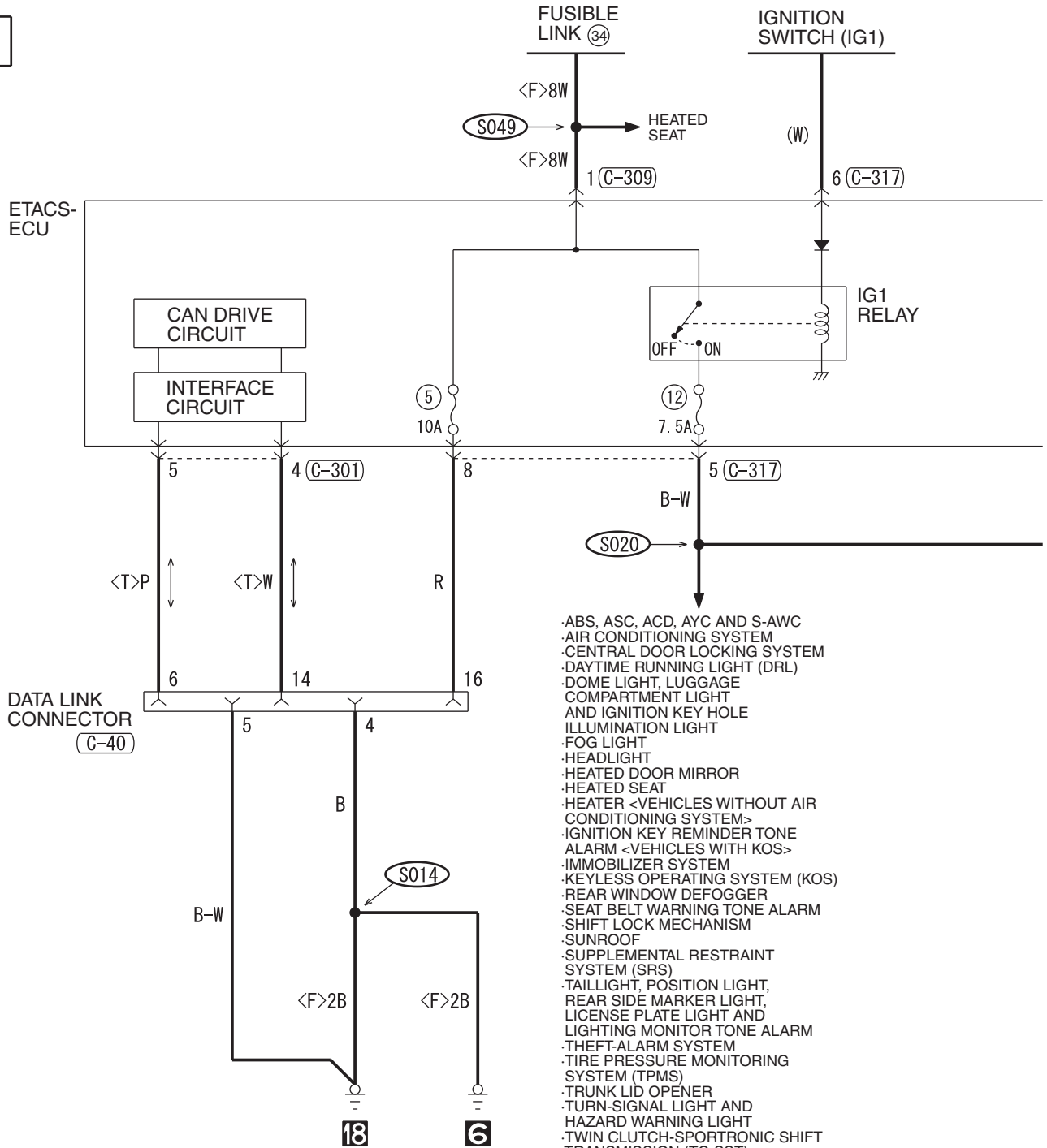

- ABS, ASC, ACD, AYC AND S-AWC
- AIR CONDITIONING SYSTEM
- CENTRAL DOOR LOCKING SYSTEM
- DAYTIME RUNNING LIGHT (DRL)
- DOME LIGHT, LUGGAGE COMPARTMENT LIGHT AND IGNITION KEY HOLE ILLUMINATION LIGHT
- FOG LIGHT
- HEADLIGHT
- HEATED DOOR MIRROR
- HEATED SEAT
- HEATER <VEHICLES WITHOUT AIR CONDITIONING SYSTEM>
- IGNITION KEY REMINDER TONE ALARM <VEHICLES WITH KOS>
- IMMOBILIZER SYSTEM
- KEYLESS OPERATING SYSTEM (KOS)
- REAR WINDOW DEFOGGER
- SEAT BELT WARNING TONE ALARM
- SHIFT LOCK MECHANISM
- SUNROOF
- SUPPLEMENTAL RESTRAINT SYSTEM (SRS)
- TAILLIGHT, POSITION LIGHT, REAR SIDE MARKER LIGHT, LICENSE PLATE LIGHT AND LIGHTING MONITOR TONE ALARM
- THEFT-ALARM SYSTEM
- TIRE PRESSURE MONITORING SYSTEM (TPMS)
- TRUNK LID OPENER
- TURN-SIGNAL LIGHT AND HAZARD WARNING LIGHT
- TWIN CLUTCH-SPORTRONIC SHIFT TRANSMISSION (TC-SST)
- WINDSHIELD WIPER AND WASHER

(C-04)

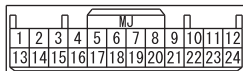

(C-22)

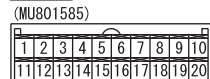

(C-40) FRONT SIDE

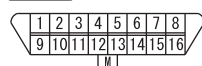

(C-105)

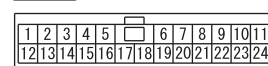

(C-301)

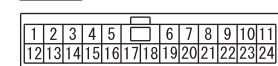

4

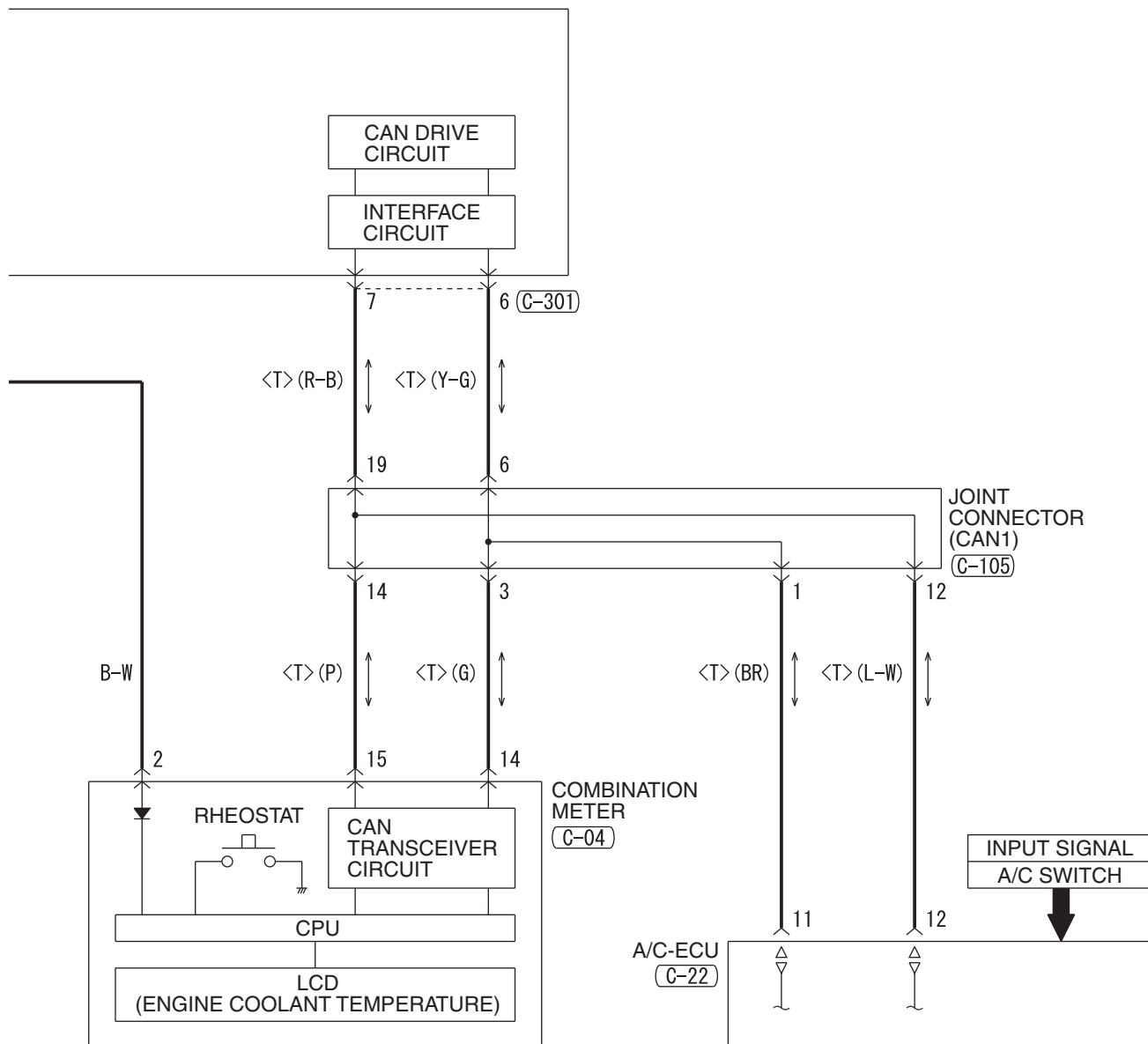

(C-309) (C-317)

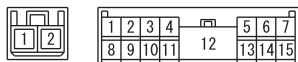

WIRE COLOR CODE

B: BLACK LG: LIGHT GREEN G: GREEN L: BLUE W: WHITE Y: YELLOW SB: SKY BLUE  
BR: BROWN O: ORANGE GR: GRAY R: RED P: PINK V: VIOLET PU: PURPLE SI: SILVER

HAH06M02BB

TSB Revision

# SHIFT LOCK MECHANISM

1

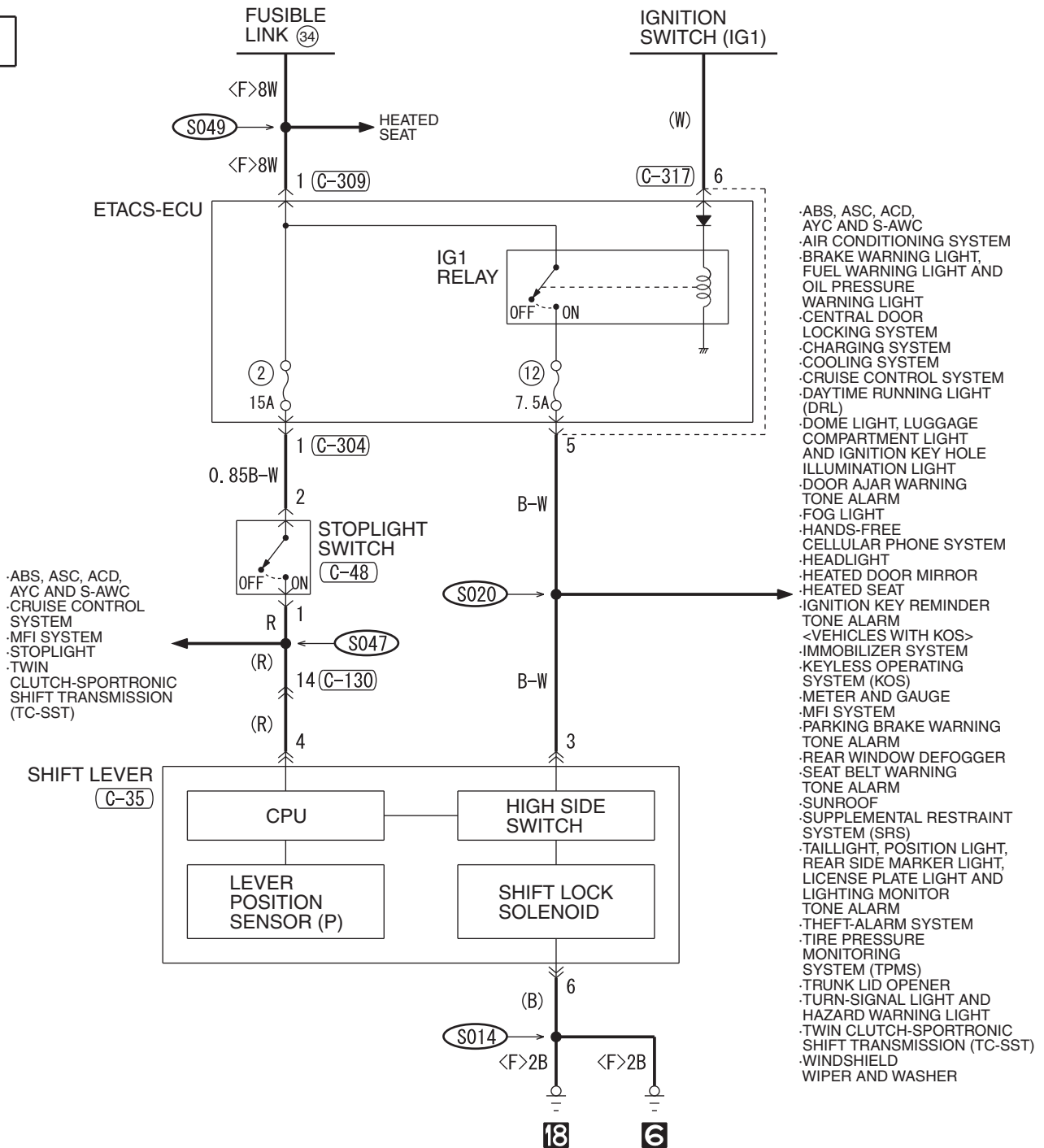

(C-35)

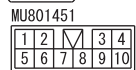

(C-48)



(C-130)

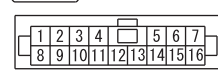

(C-304)

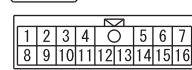

(C-309)



(C-317)



**WIRE COLOR CODE**

B : BLACK LG : LIGHT GREEN G : GREEN L : BLUE W : WHITE Y : YELLOW SB : SKY BLUE  
BR : BROWN O : ORANGE GR : GRAY R : RED P : PINK V : VIOLET PU : PURPLE SI : SILVER

NOTES

# TWIN CLUTCH-SPORTRONIC SHIFT TRANSMISSION (TC-SST)

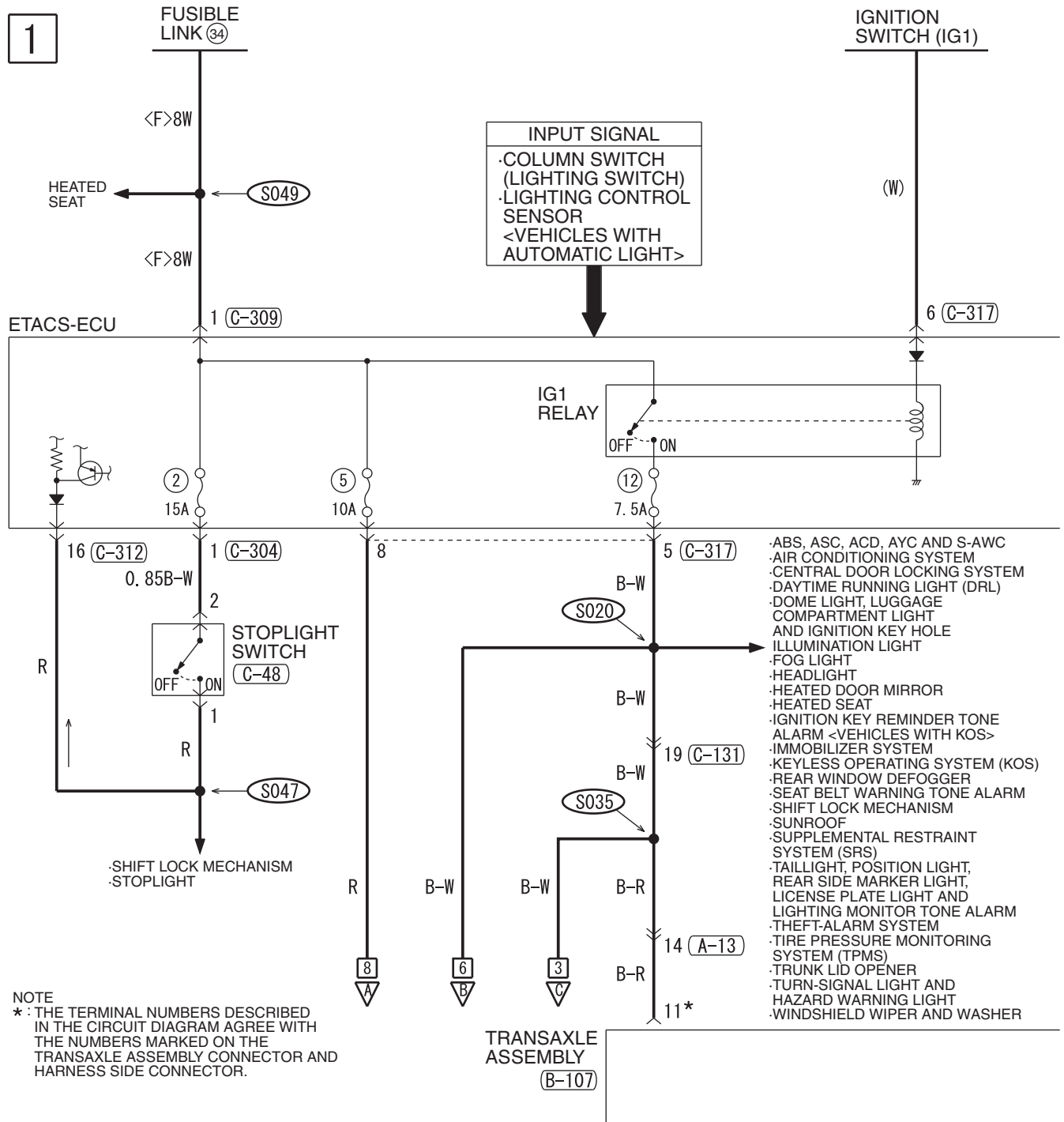

(A-13)

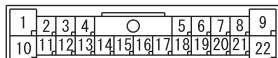

(B-107)\*



(C-48)



(C-131)

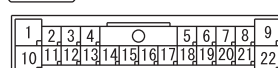

(C-304)

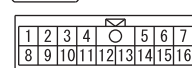

(C-307)



(C-309)



**2**

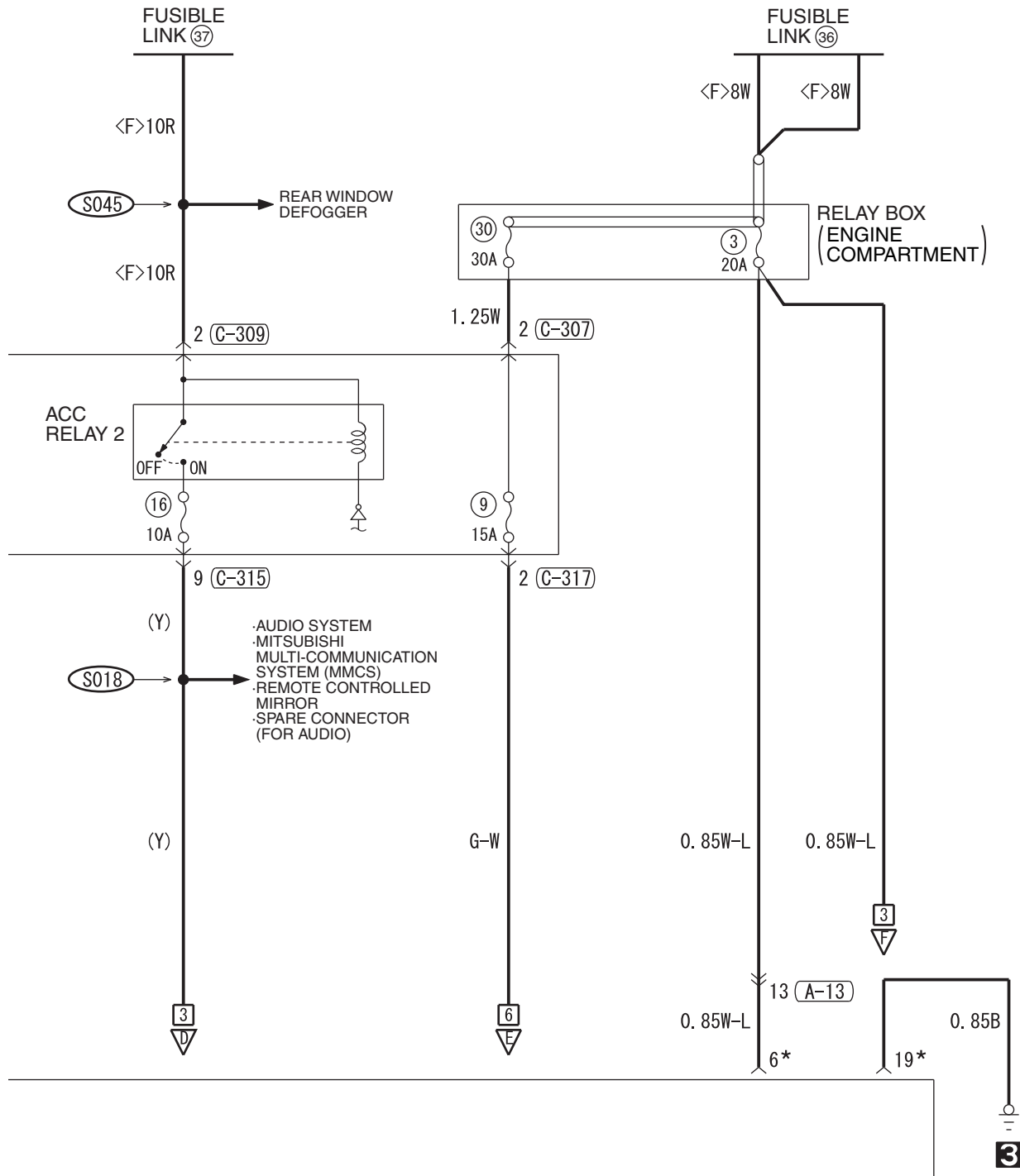

(C-312)

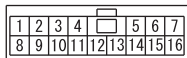

(C-315)

MU801890

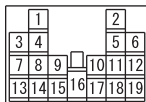

(C-317)

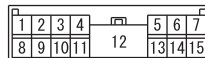

**WIRE COLOR CODE**

B : BLACK LG : LIGHT GREEN G : GREEN L : BLUE W : WHITE Y : YELLOW SB : SKY BLUE  
 BR : BROWN O : ORANGE GR : GRAY R : RED P : PINK V : VIOLET PU : PURPLE SI : SILVER

HAH07M05AB

TWIN CLUTCH-SPORTRONIC SHIFT TRANSMISSION (TC-SST) (CONTINUED)

3

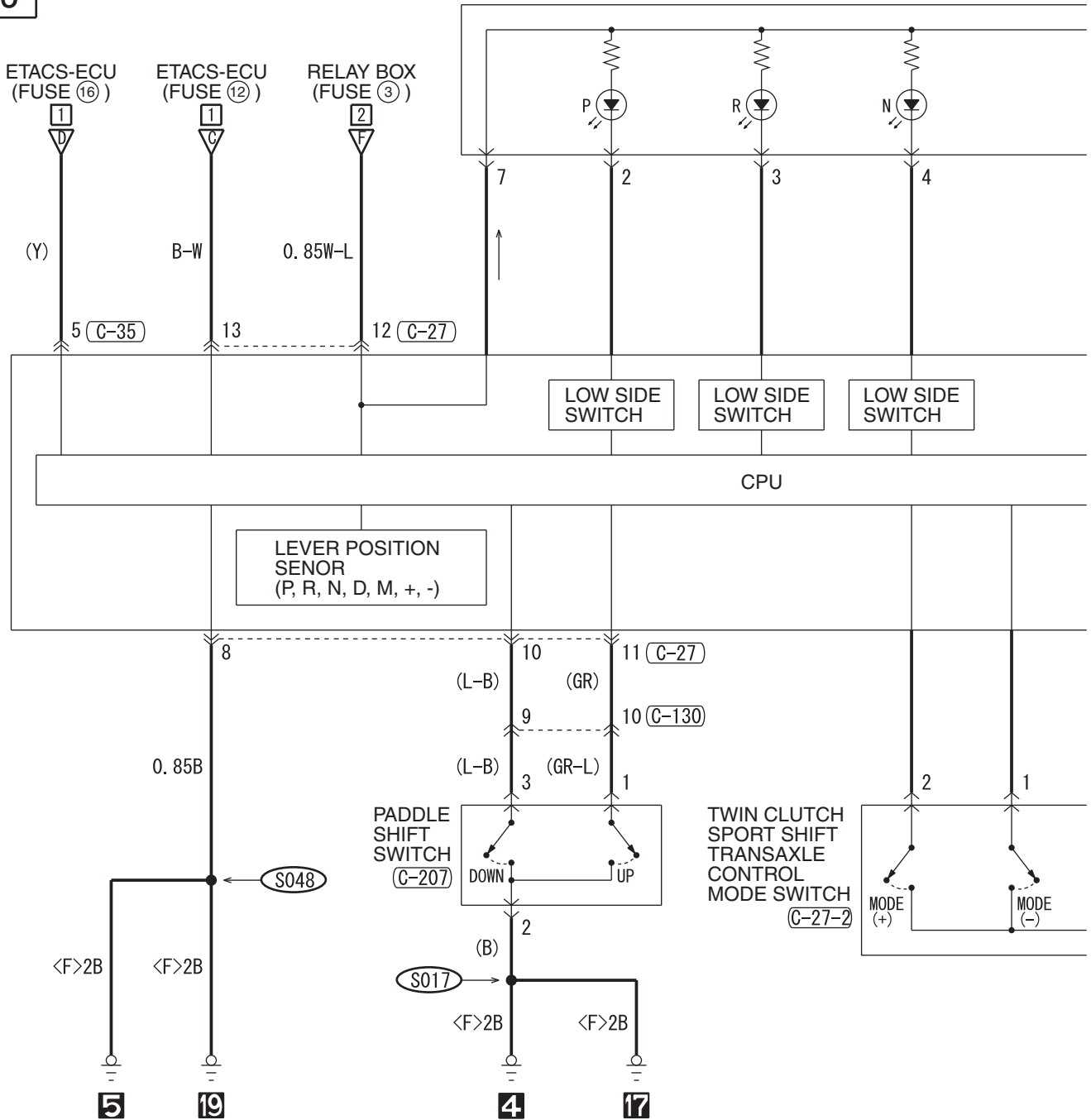

(C-27)

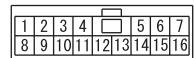

(C-27-1)

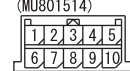

(C-27-2)

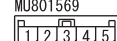

(C-35)



(C-101)

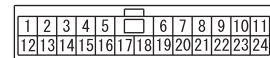

(C-130)

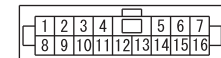

(C-207)





4

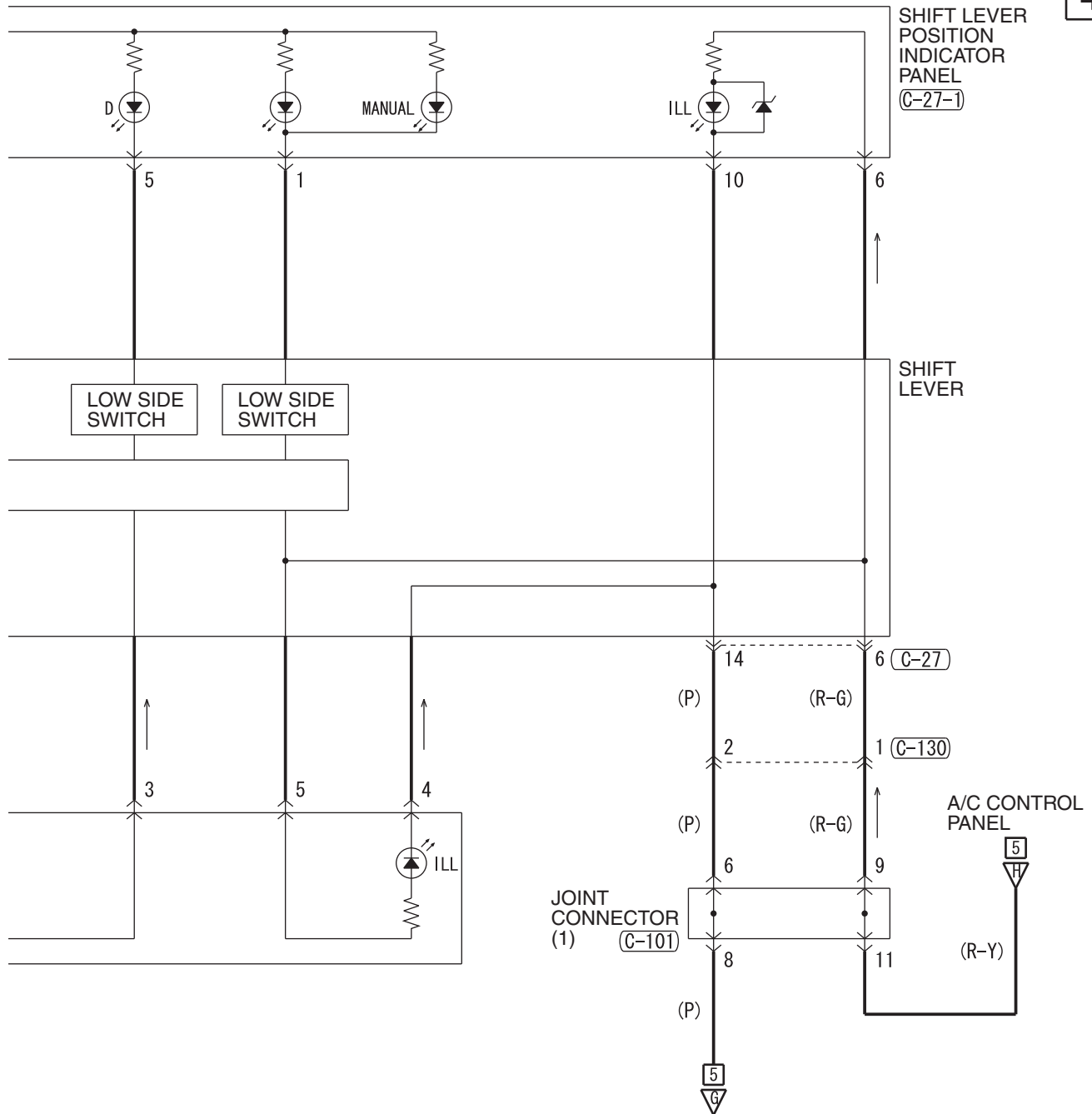

WIRE COLOR CODE

B: BLACK LG: LIGHT GREEN G: GREEN L: BLUE W: WHITE Y: YELLOW SB: SKY BLUE  
BR: BROWN O: ORANGE GR: GRAY R: RED P: PINK V: VIOLET PU: PURPLE SI: SILVER

HAH07M05BB

TSB Revision

TWIN CLUTCH-SPORTRONIC SHIFT TRANSMISSION (TC-SST) (CONTINUED)

5

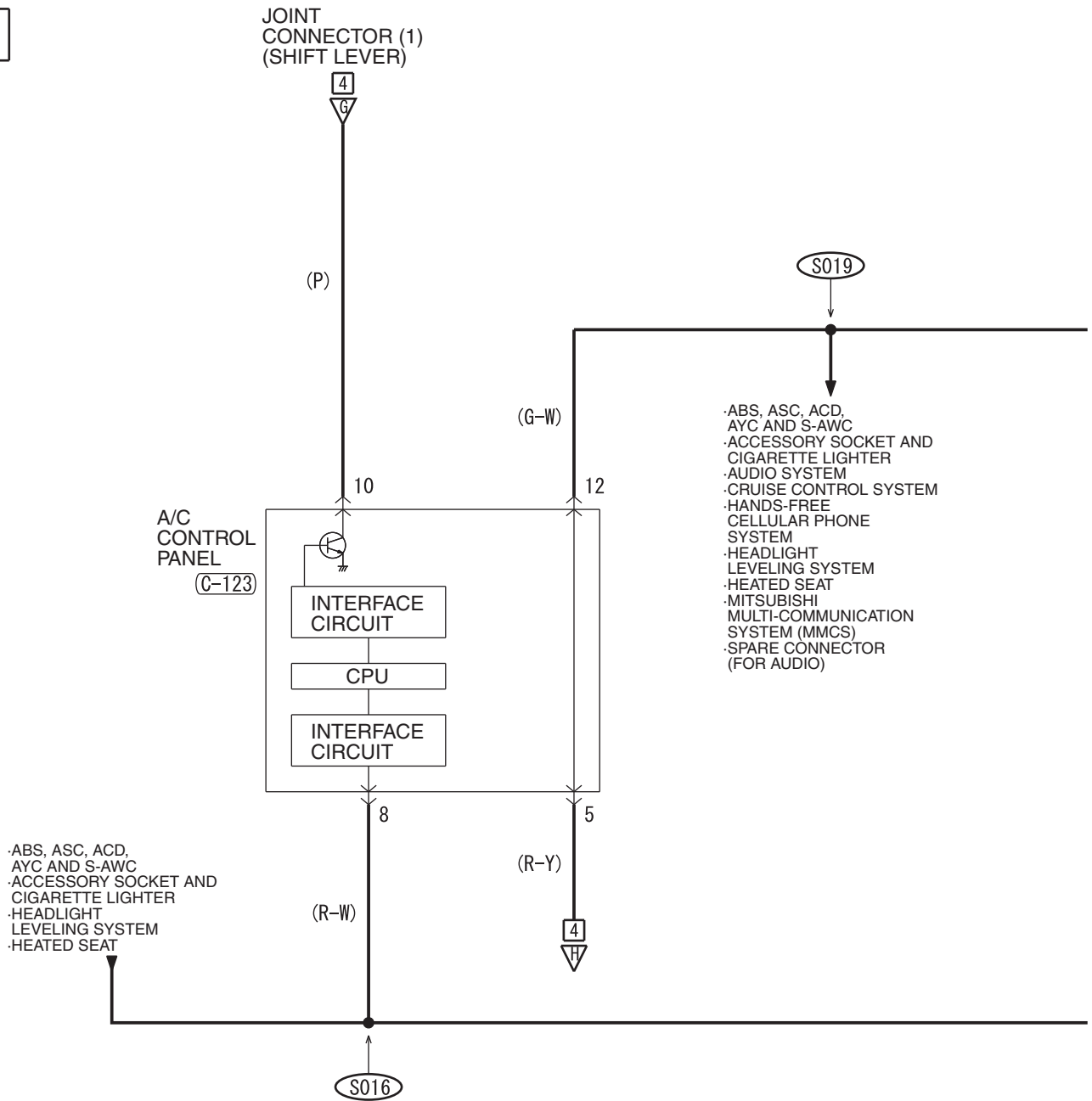

(C-04)

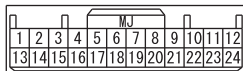

(C-103)

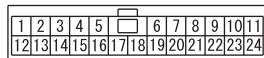

(C-105)

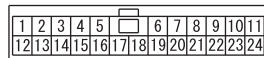

(C-123)

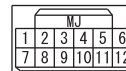

6

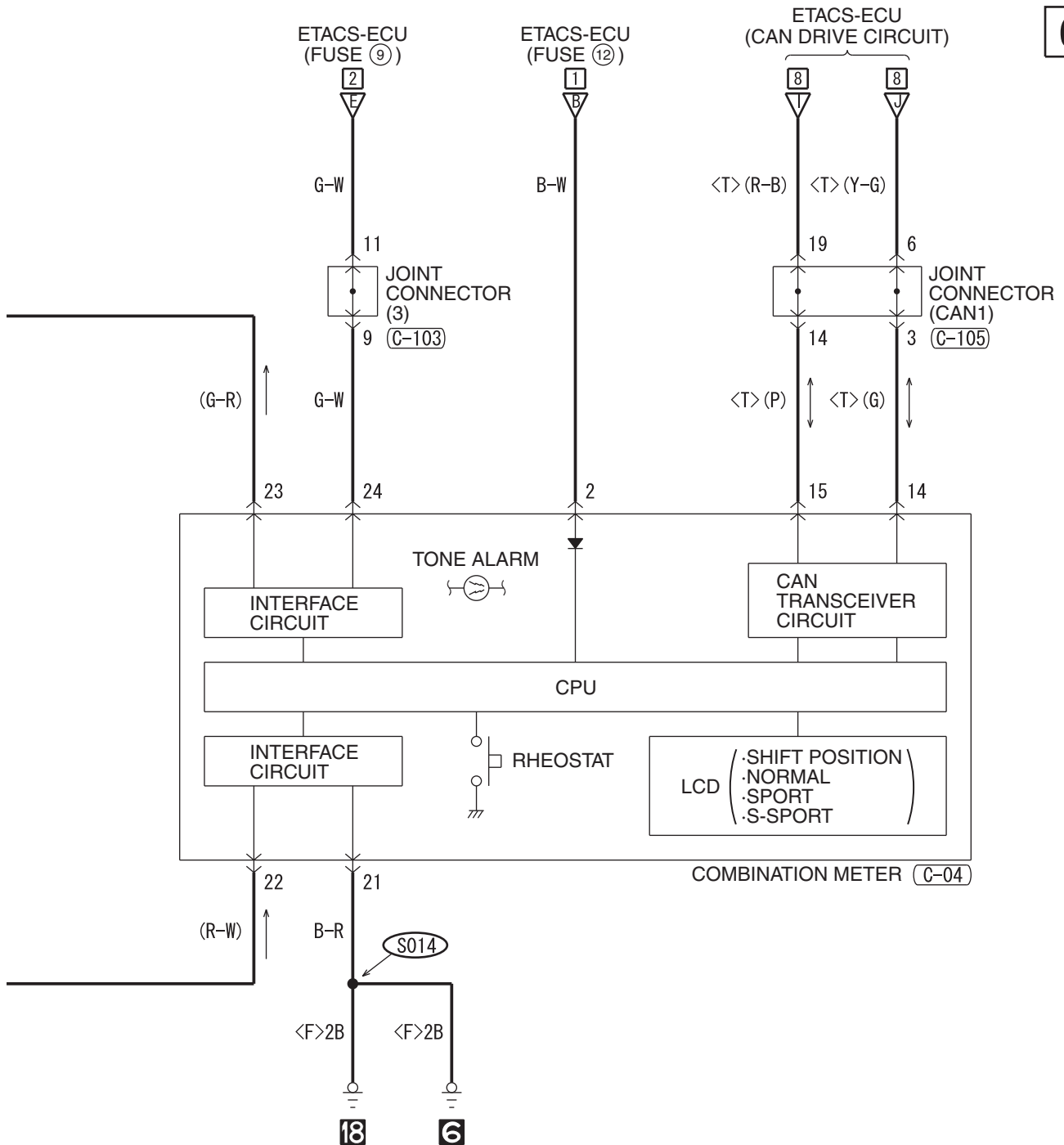

**WIRE COLOR CODE**  
 B: BLACK LG: LIGHT GREEN G: GREEN L: BLUE W: WHITE Y: YELLOW SB: SKY BLUE  
 BR: BROWN O: ORANGE GR: GRAY R: RED P: PINK V: VIOLET PU: PURPLE SI: SILVER

HAH07M05CB

**TSB Revision**

TWIN CLUTCH-SPORTRONIC SHIFT TRANSMISSION (TC-SST) (CONTINUED)

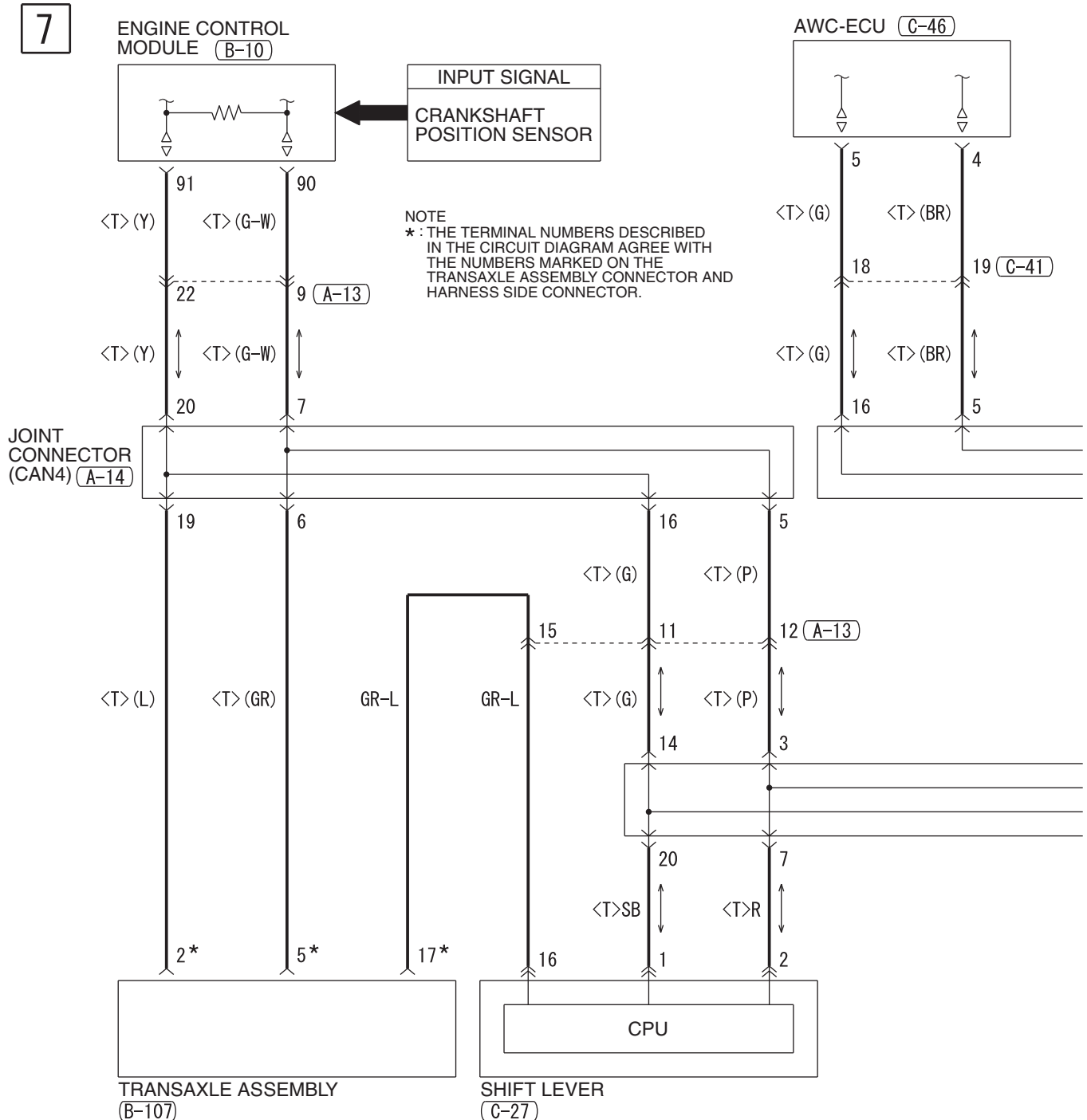

(A-05)

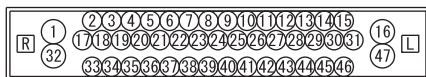

(A-13)

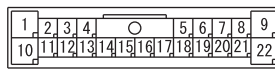

(A-14)

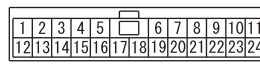

(C-46)

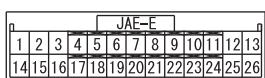

(C-104)

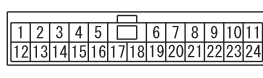

(C-127)

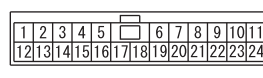

(C-131)

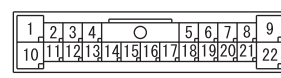

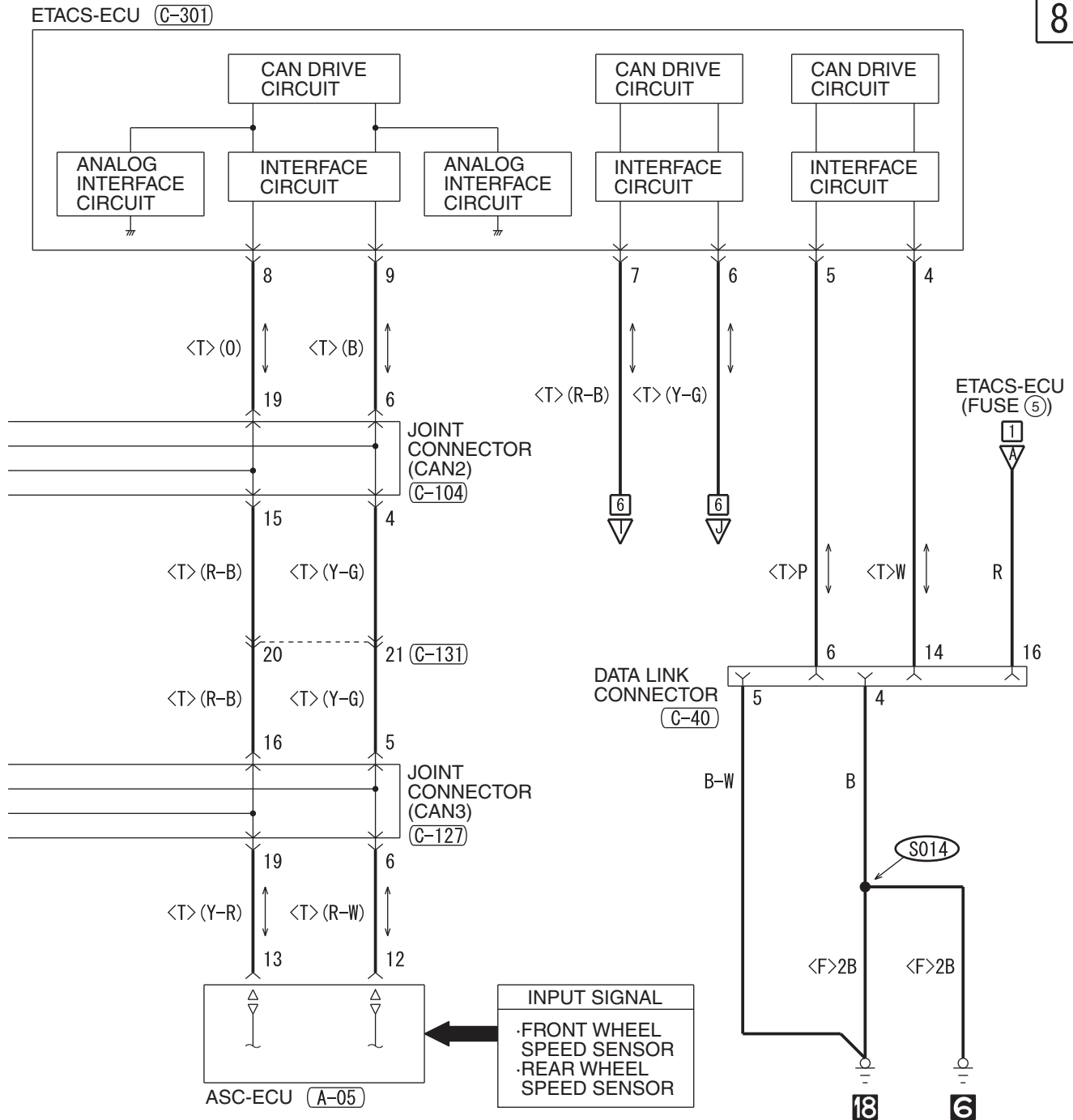

**(B-10)**

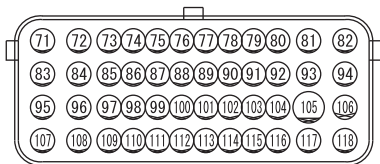

**(B-107)\***



**(C-27)**

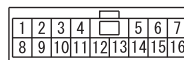

**(C-40) FRONT SIDE**



**(C-41)**

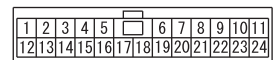

**(C-301)**

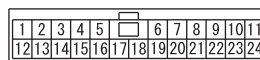

# HEADLIGHT <HALOGEN TYPE>

1

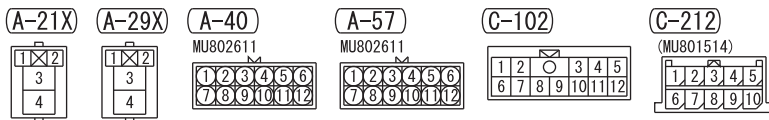
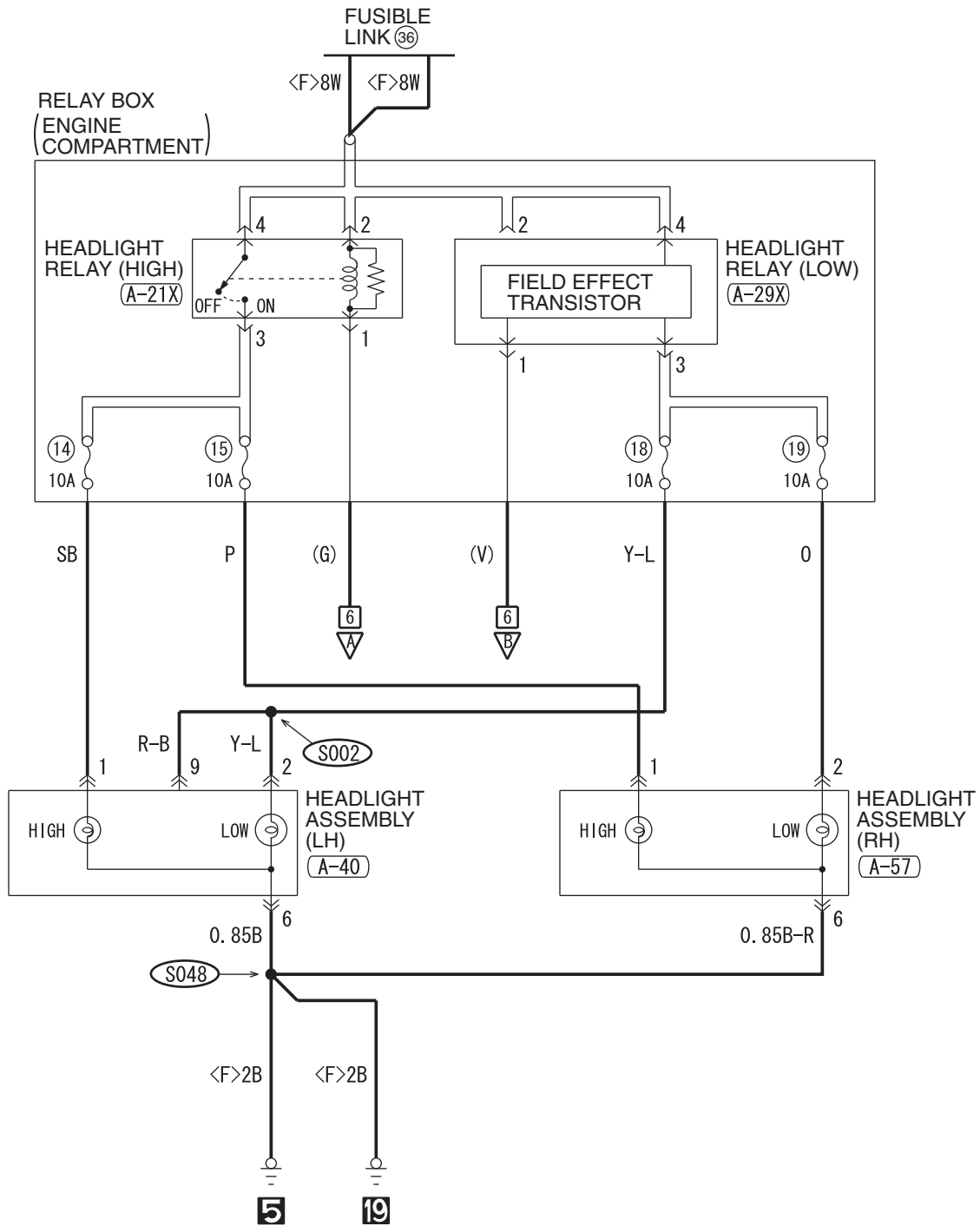

2

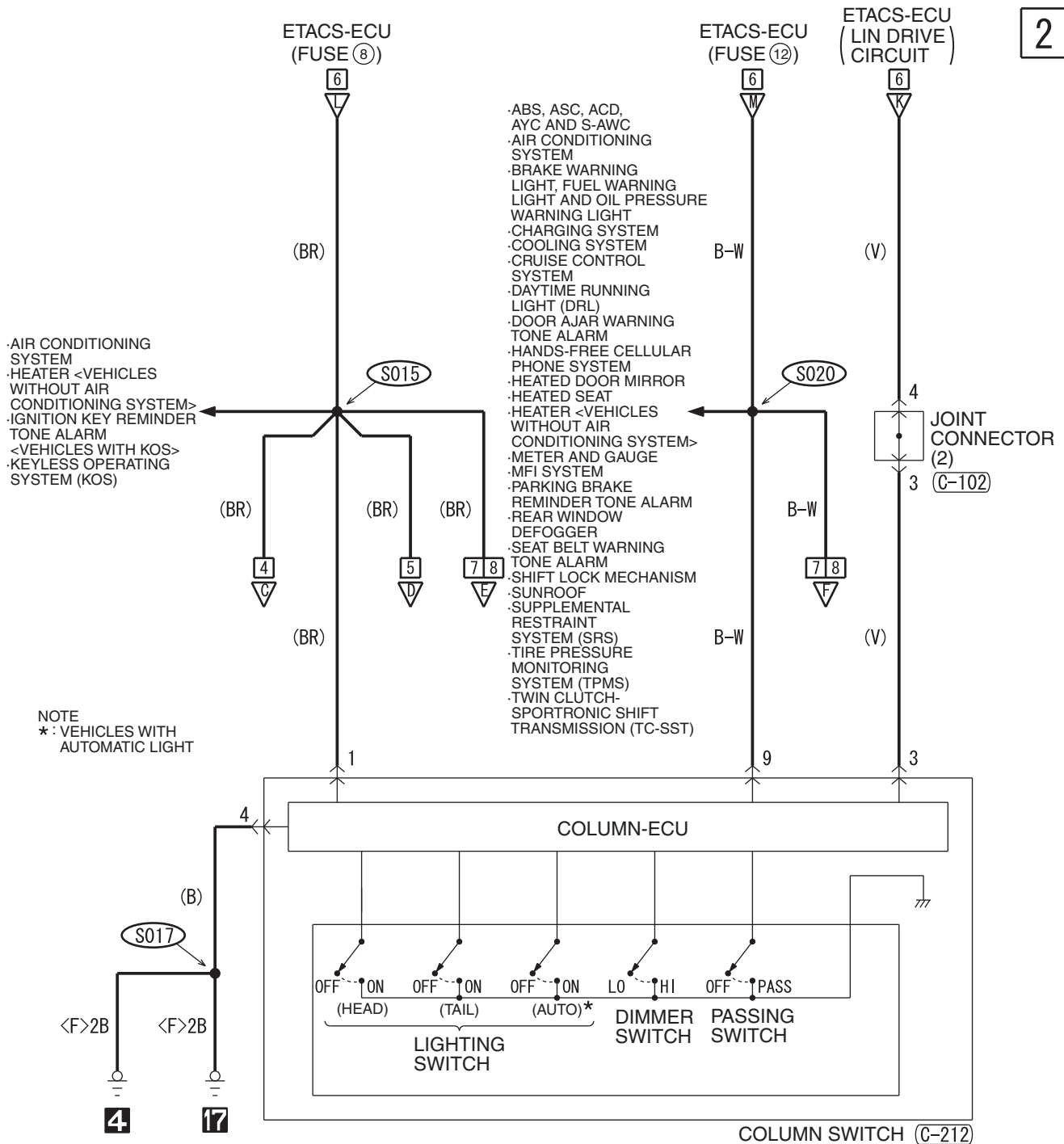

**WIRE COLOR CODE**  
 B : BLACK   LG : LIGHT GREEN   G : GREEN   L : BLUE   W : WHITE   Y : YELLOW   SB : SKY BLUE  
 BR : BROWN   O : ORANGE   GR : GRAY   R : RED   P : PINK   V : VIOLET   PU : PURPLE   SI : SILVER

HAH08M10AB

HEADLIGHT <HALOGEN TYPE> (CONTINUED)

3

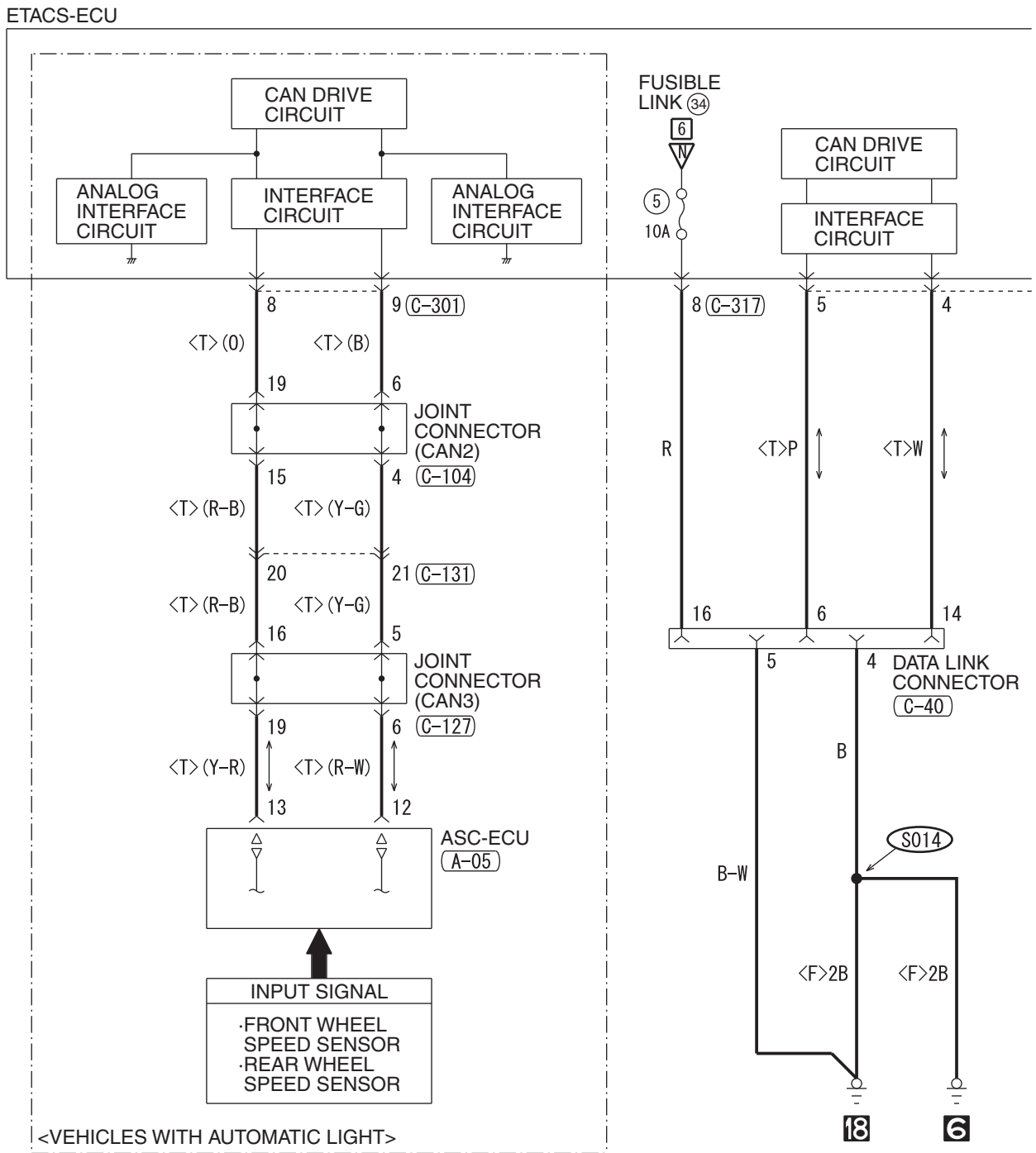

(A-05)

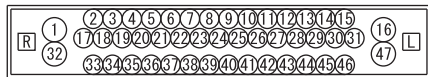

(C-04)

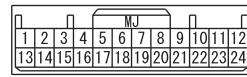

(C-40) FRONT SIDE

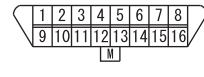

(C-104)

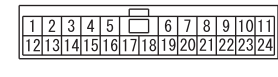

(C-317)

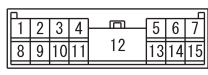



4

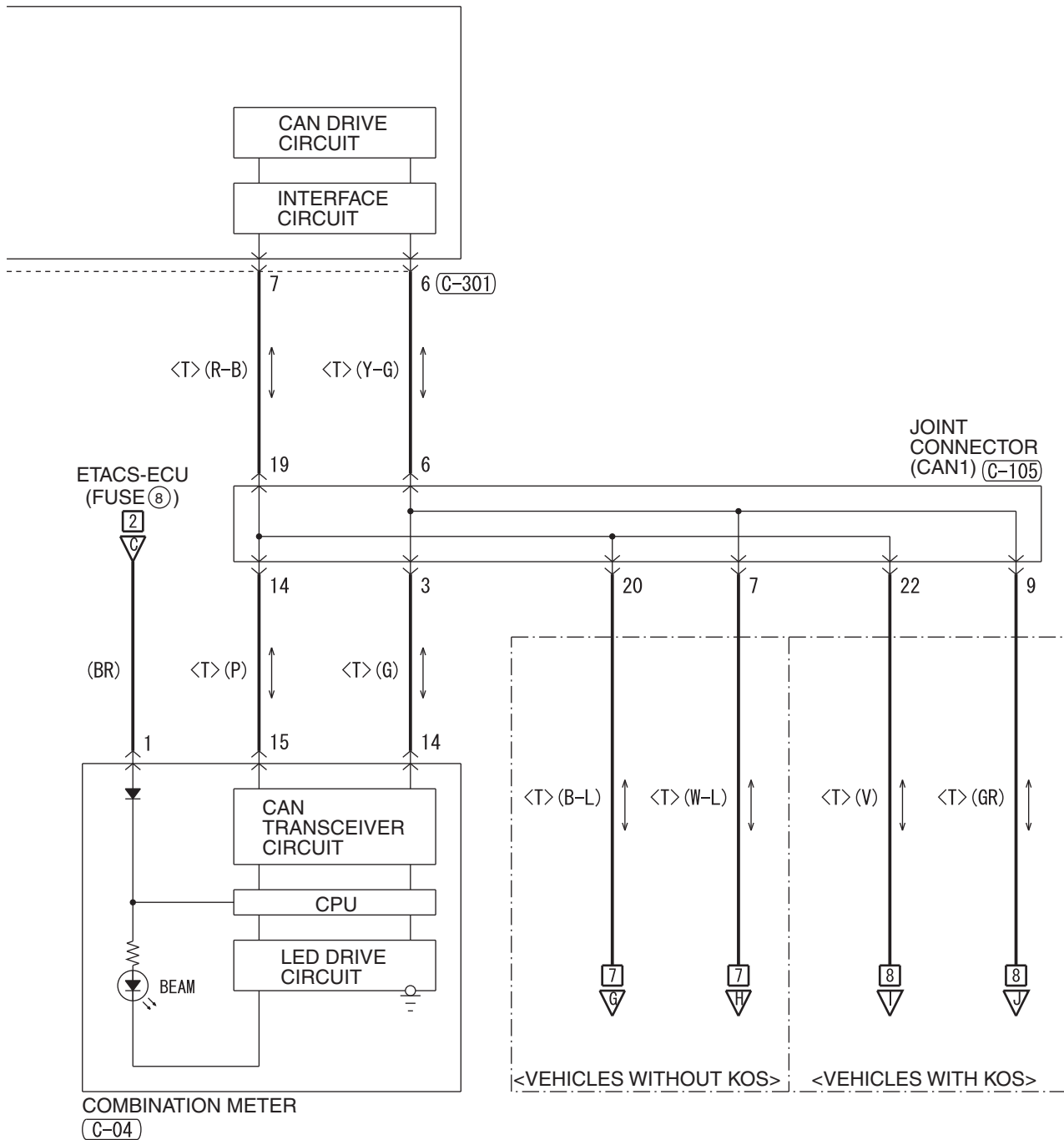

(C-105)

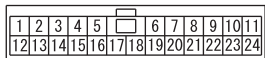

(C-127)

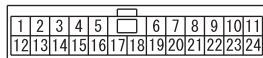

(C-131)

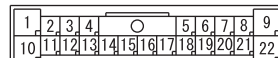

(C-301)

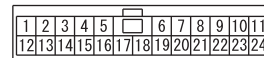

WIRE COLOR CODE

B : BLACK LG : LIGHT GREEN G : GREEN L : BLUE W : WHITE Y : YELLOW SB : SKY BLUE  
BR : BROWN O : ORANGE GR : GRAY R : RED P : PINK V : VIOLET PU : PURPLE SI : SILVER

HAH08M10BB

HEADLIGHT <HALOGEN TYPE> (CONTINUED)

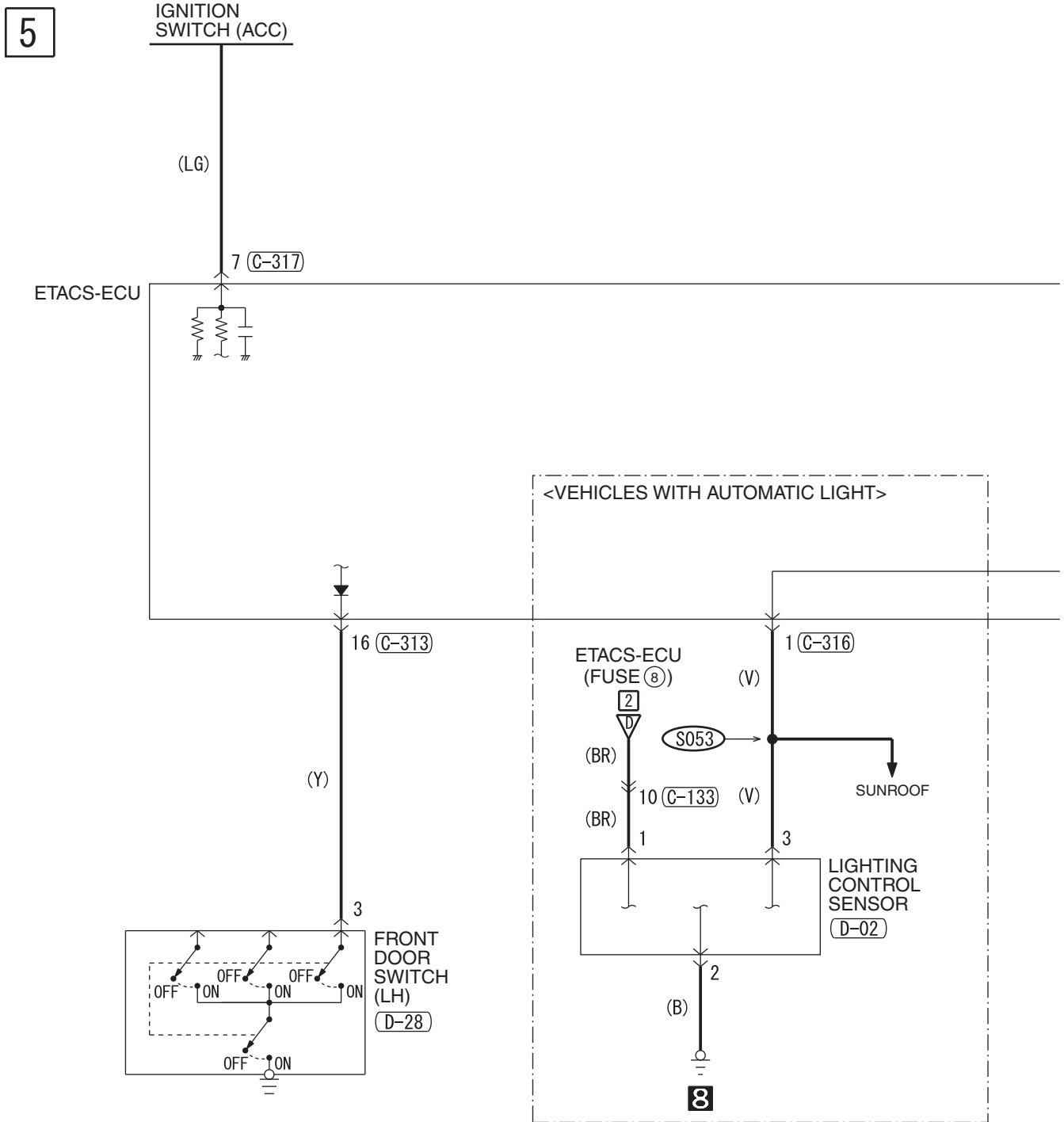

(C-133)

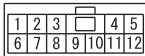

(C-301)

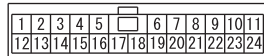

(C-307)



(C-309)



(C-312)

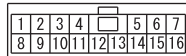

(C-313)

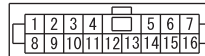

(C-316)



**6**

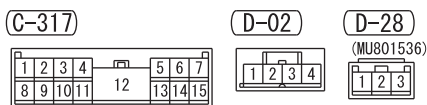
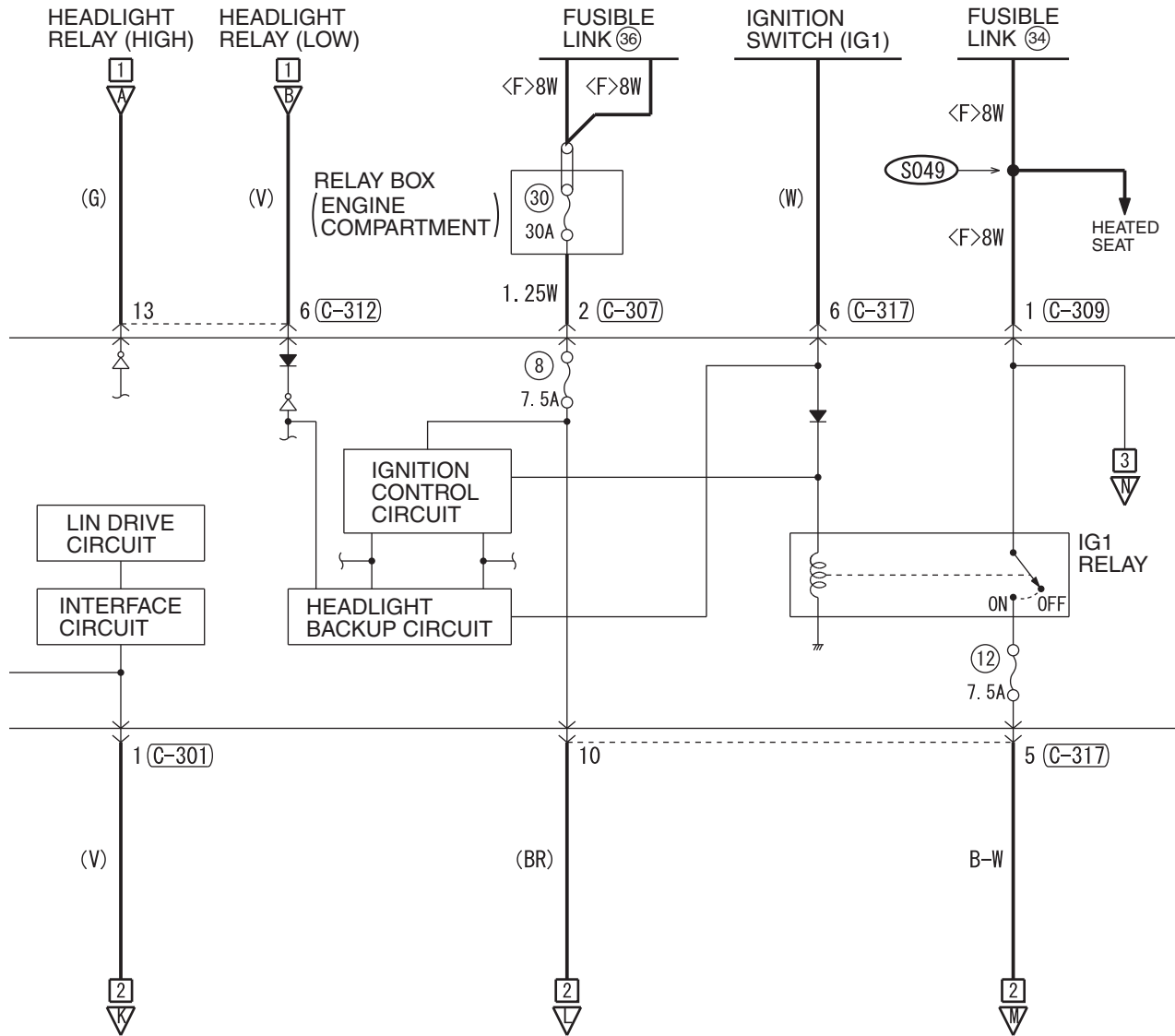

**WIRE COLOR CODE**  
 B: BLACK LG: LIGHT GREEN G: GREEN L: BLUE W: WHITE Y: YELLOW SB: SKY BLUE  
 BR: BROWN O: ORANGE GR: GRAY R: RED P: PINK V: VIOLET PU: PURPLE SI: SILVER

HAH08M10CB

**TSB Revision**

HEADLIGHT <HALOGEN TYPE> (CONTINUED)

7

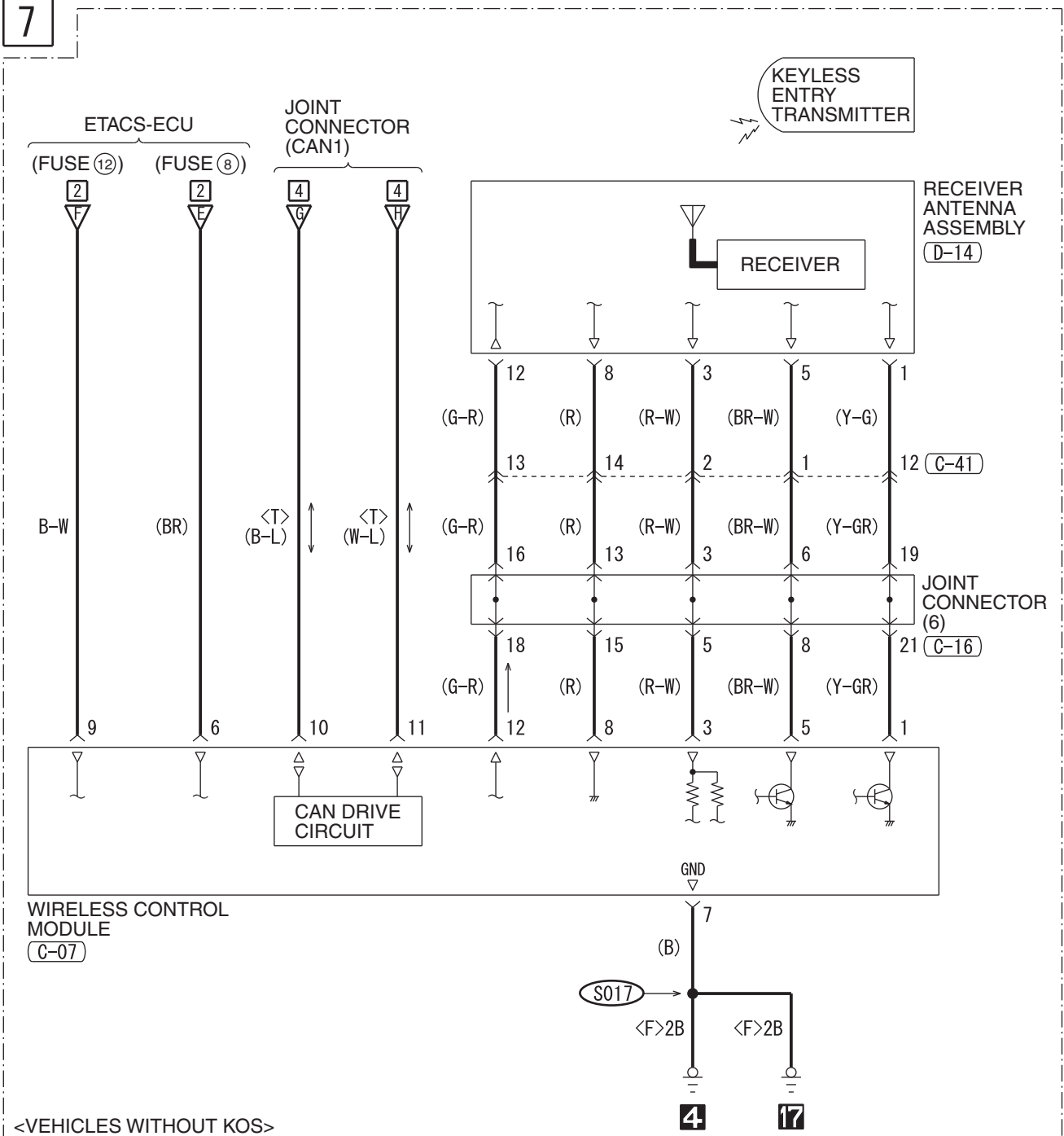

(C-05)

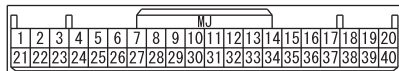

(C-07)

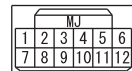

(C-16)

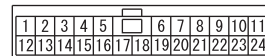

(C-41)

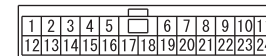

(D-14)

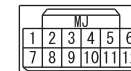

8

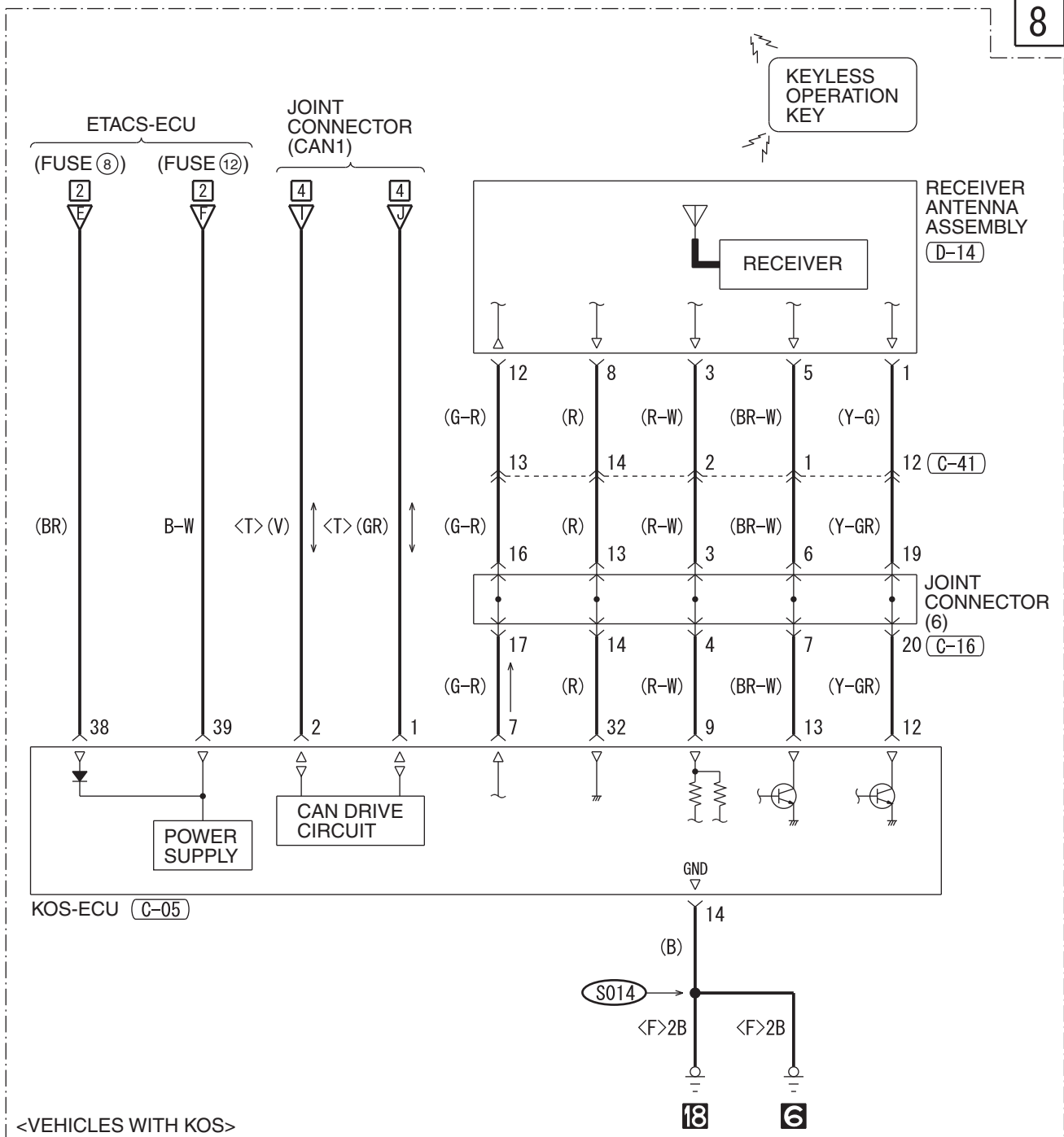

WIRE COLOR CODE

B: BLACK LG: LIGHT GREEN G: GREEN L: BLUE W: WHITE Y: YELLOW SB: SKY BLUE  
BR: BROWN O: ORANGE GR: GRAY R: RED P: PINK V: VIOLET PU: PURPLE SI: SILVER

HAH08M10DB

TSB Revision

# HEADLIGHT <DISCHARGE TYPE>

1

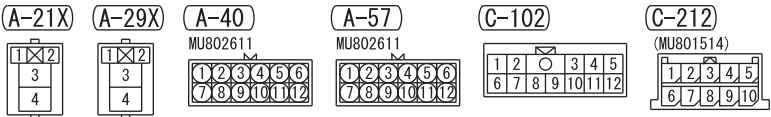
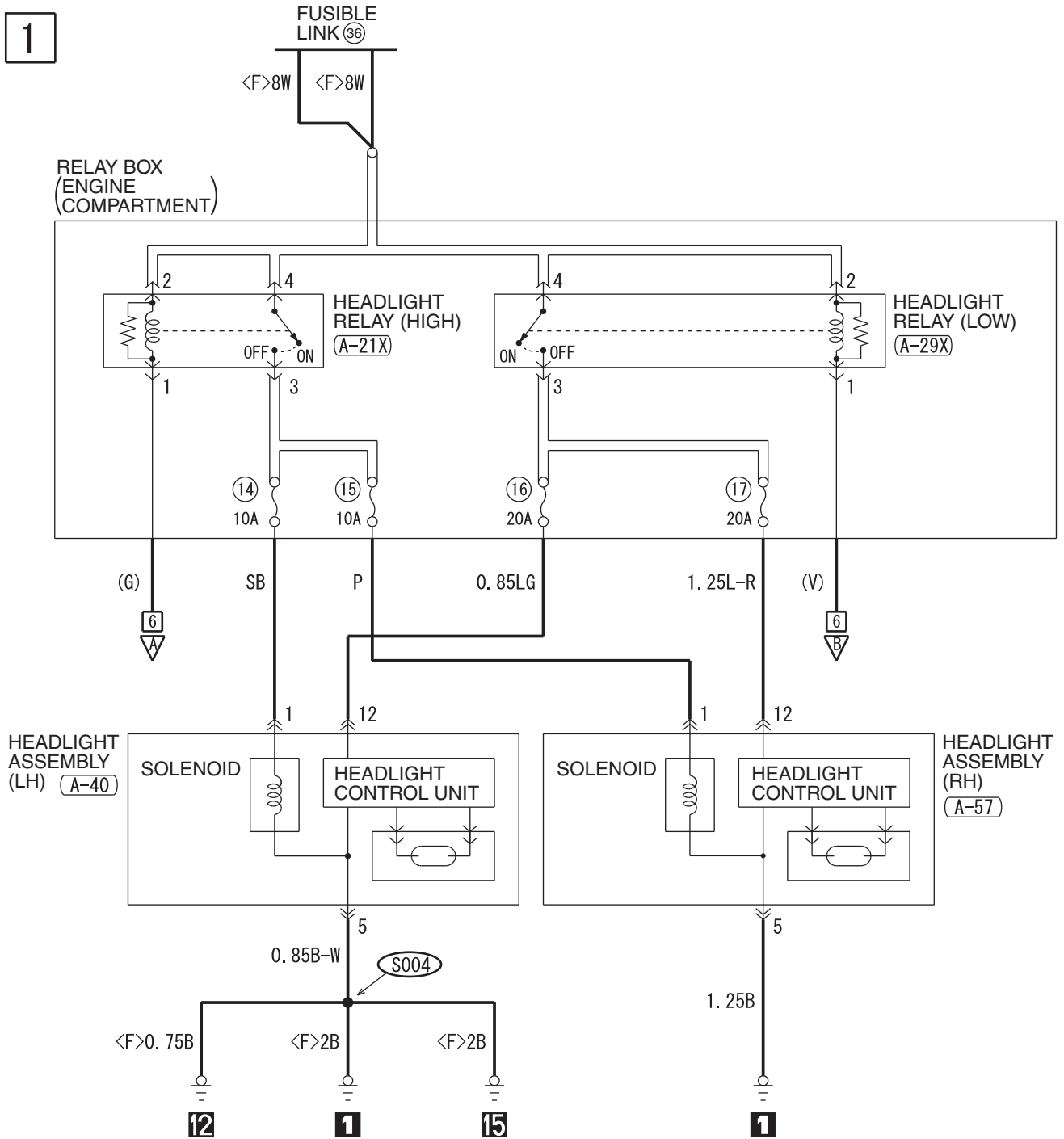

**2**

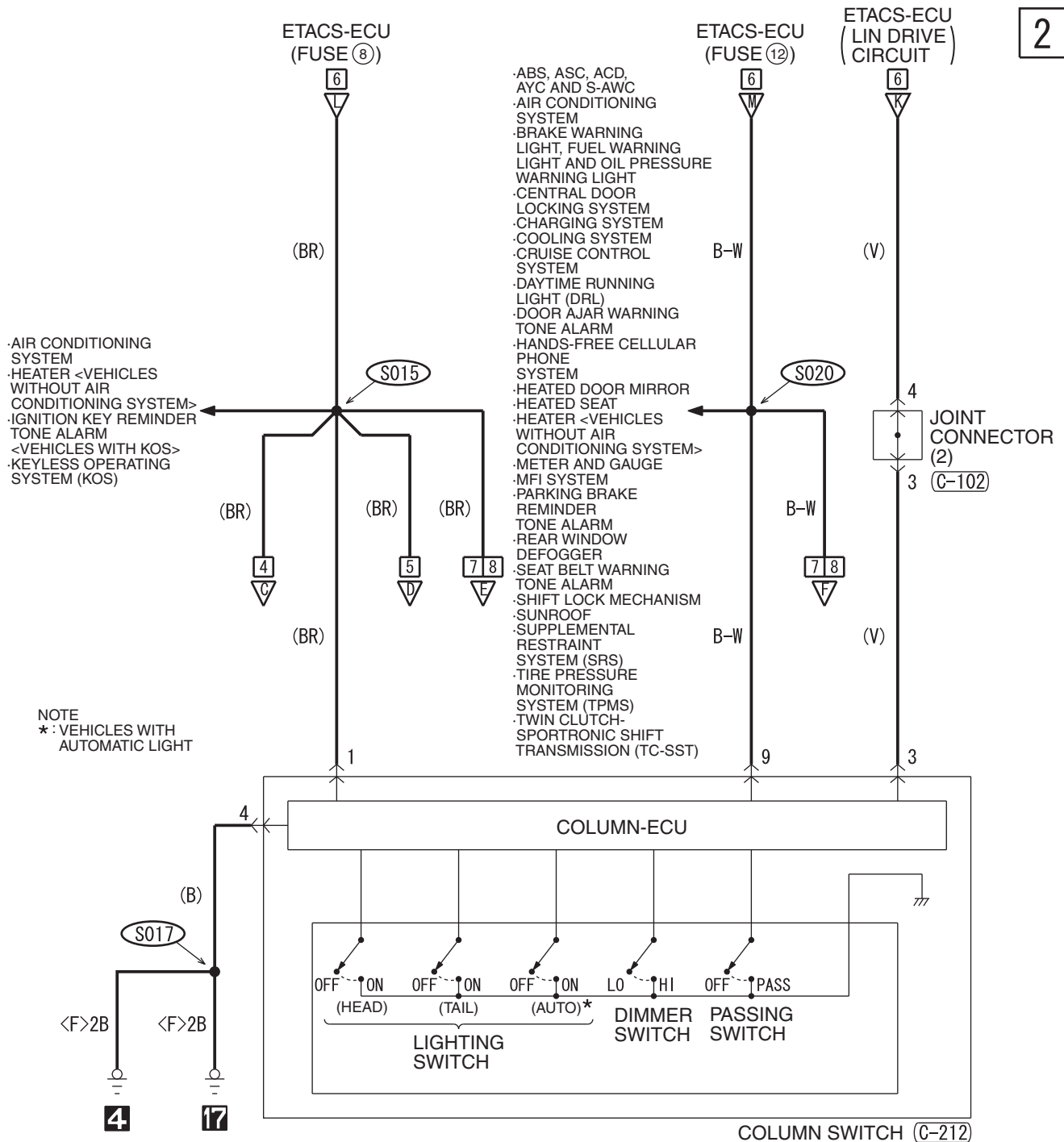

HEADLIGHT <DISCHARGE TYPE> (CONTINUED)

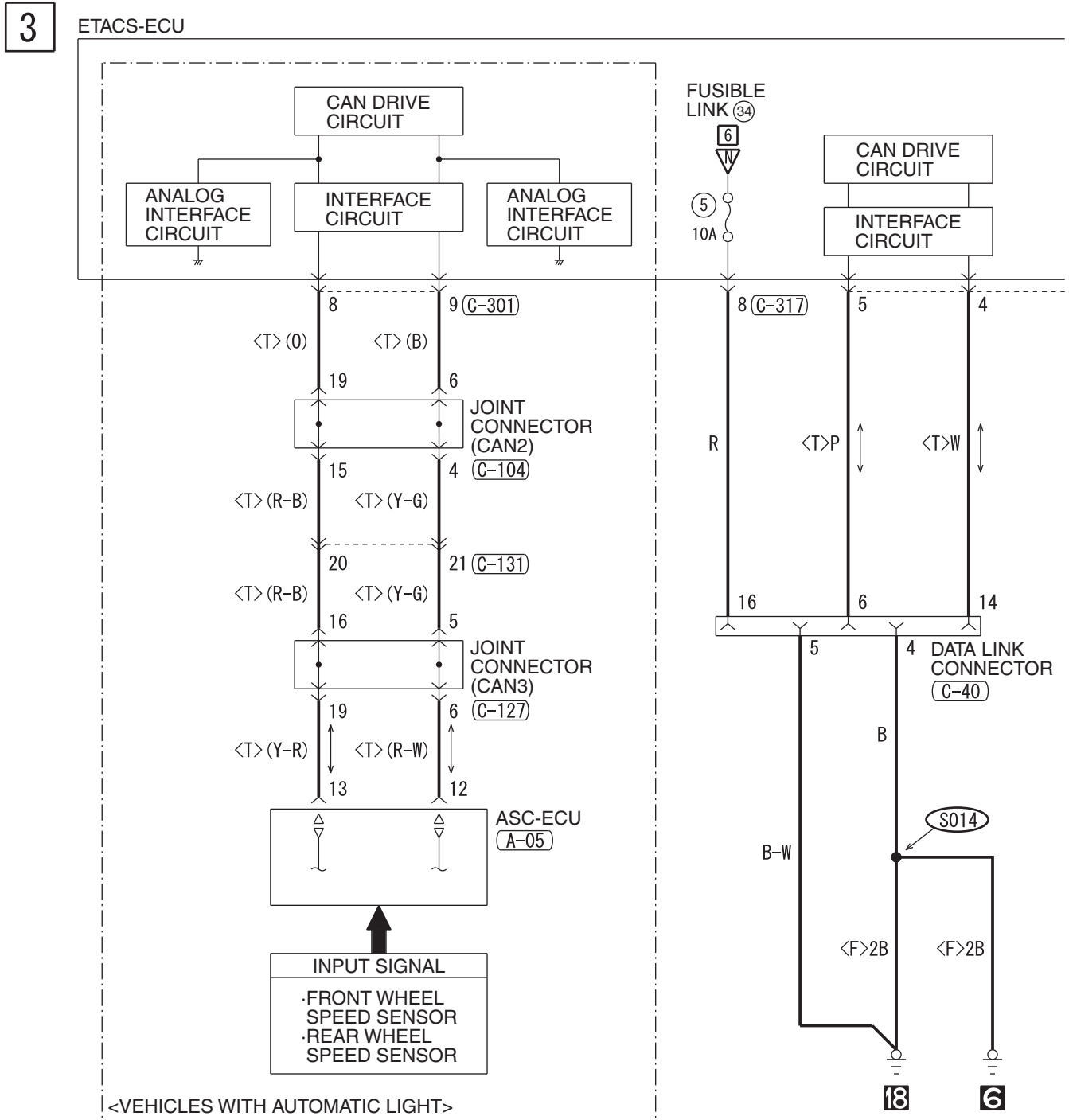

(A-05)

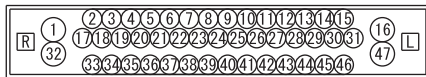

(C-04)

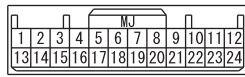

(C-40) FRONT SIDE

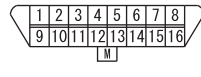

(C-104)

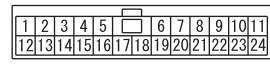

(C-317)

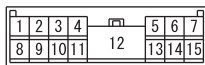



4

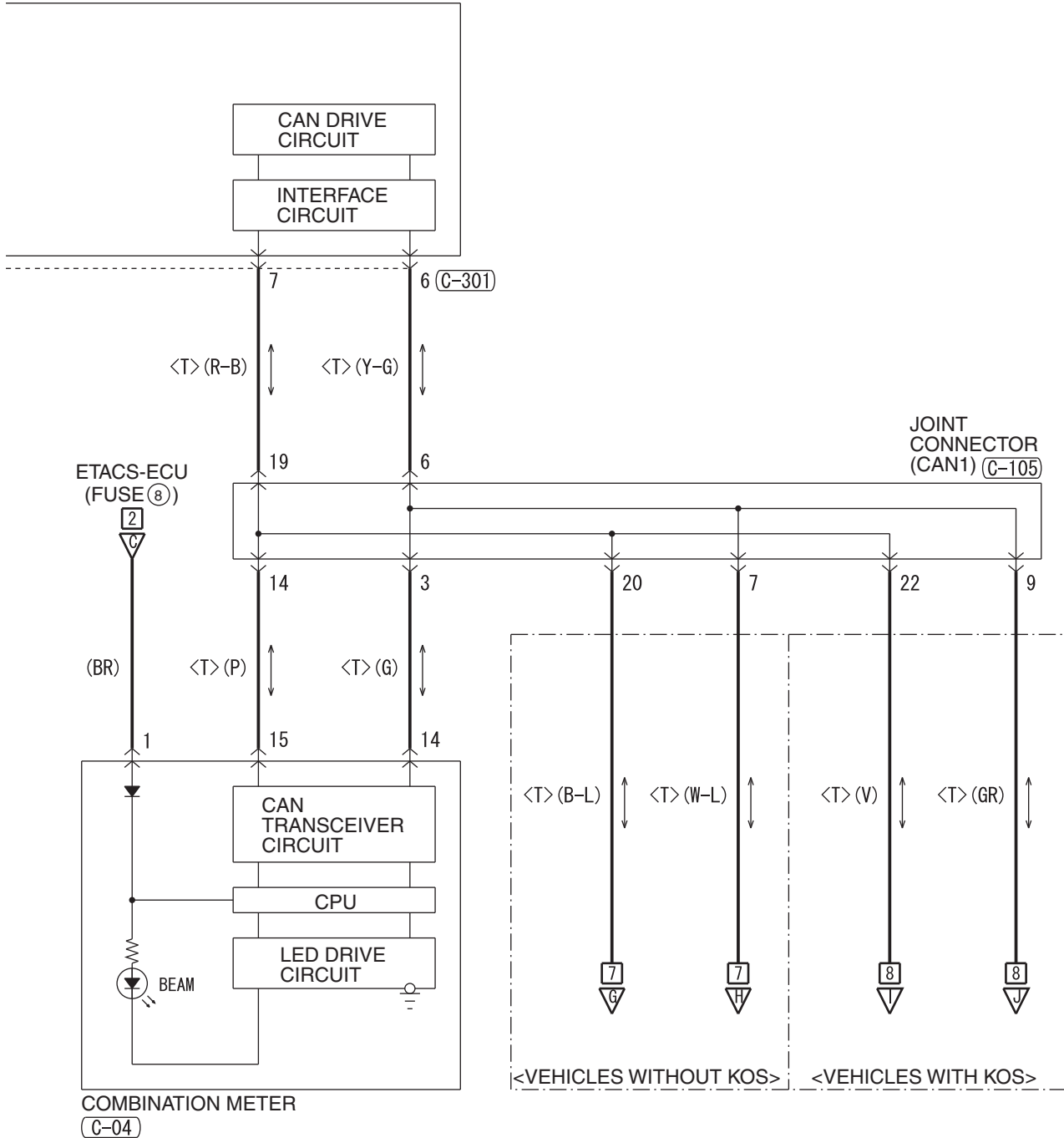

(C-105)

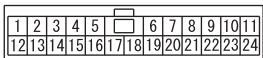

(C-127)

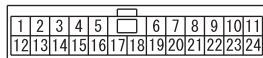

(C-131)

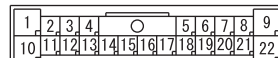

(C-301)

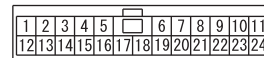

WIRE COLOR CODE

B : BLACK LG : LIGHT GREEN G : GREEN L : BLUE W : WHITE Y : YELLOW SB : SKY BLUE  
BR : BROWN O : ORANGE GR : GRAY R : RED P : PINK V : VIOLET PU : PURPLE SI : SILVER

HAH08M11BB

HEADLIGHT <DISCHARGE TYPE> (CONTINUED)

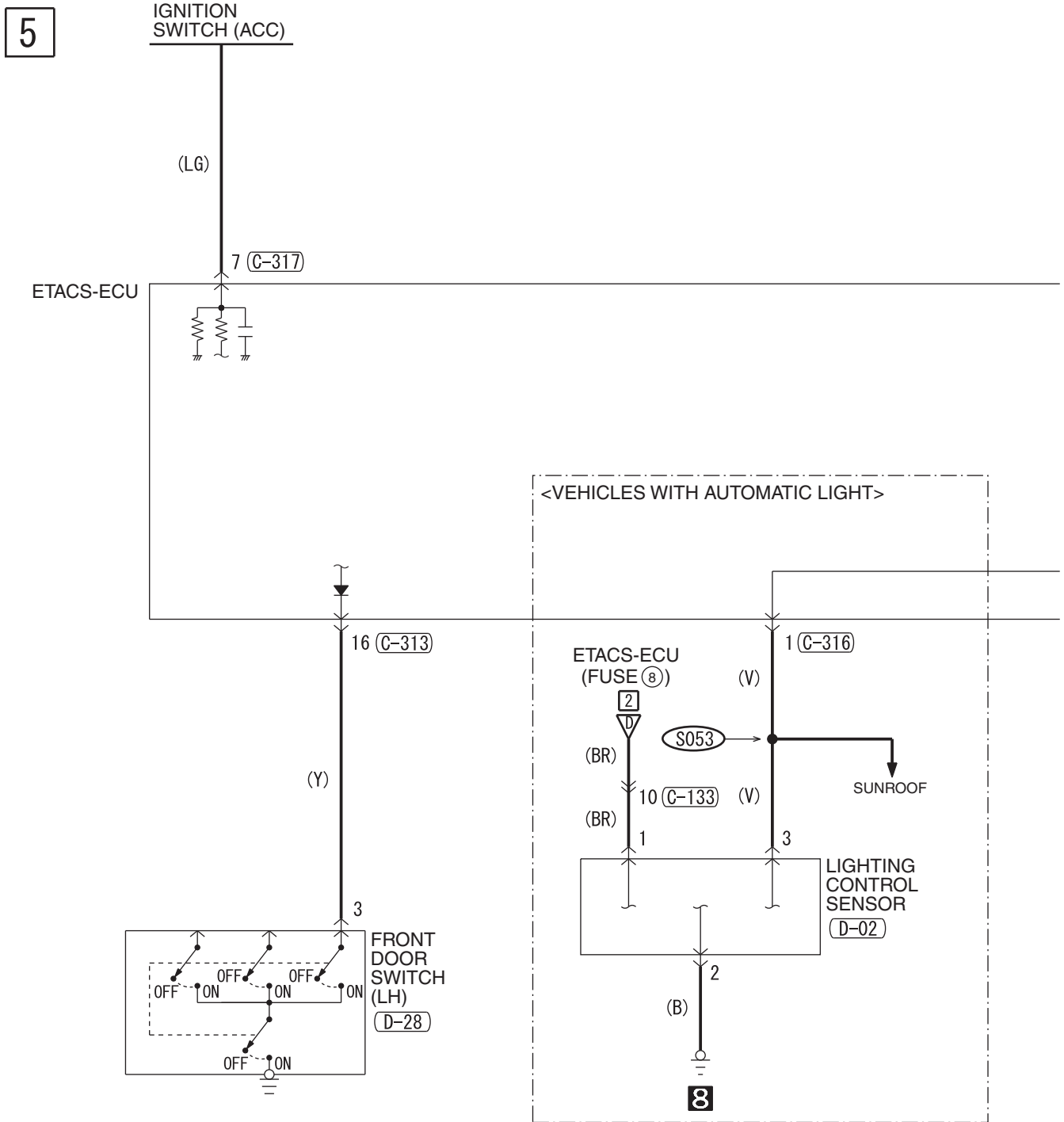

(C-133)

(C-301)

(C-307)

(C-309)

(C-312)

(C-313)

(C-316)

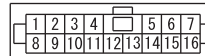
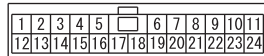
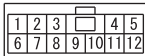

6

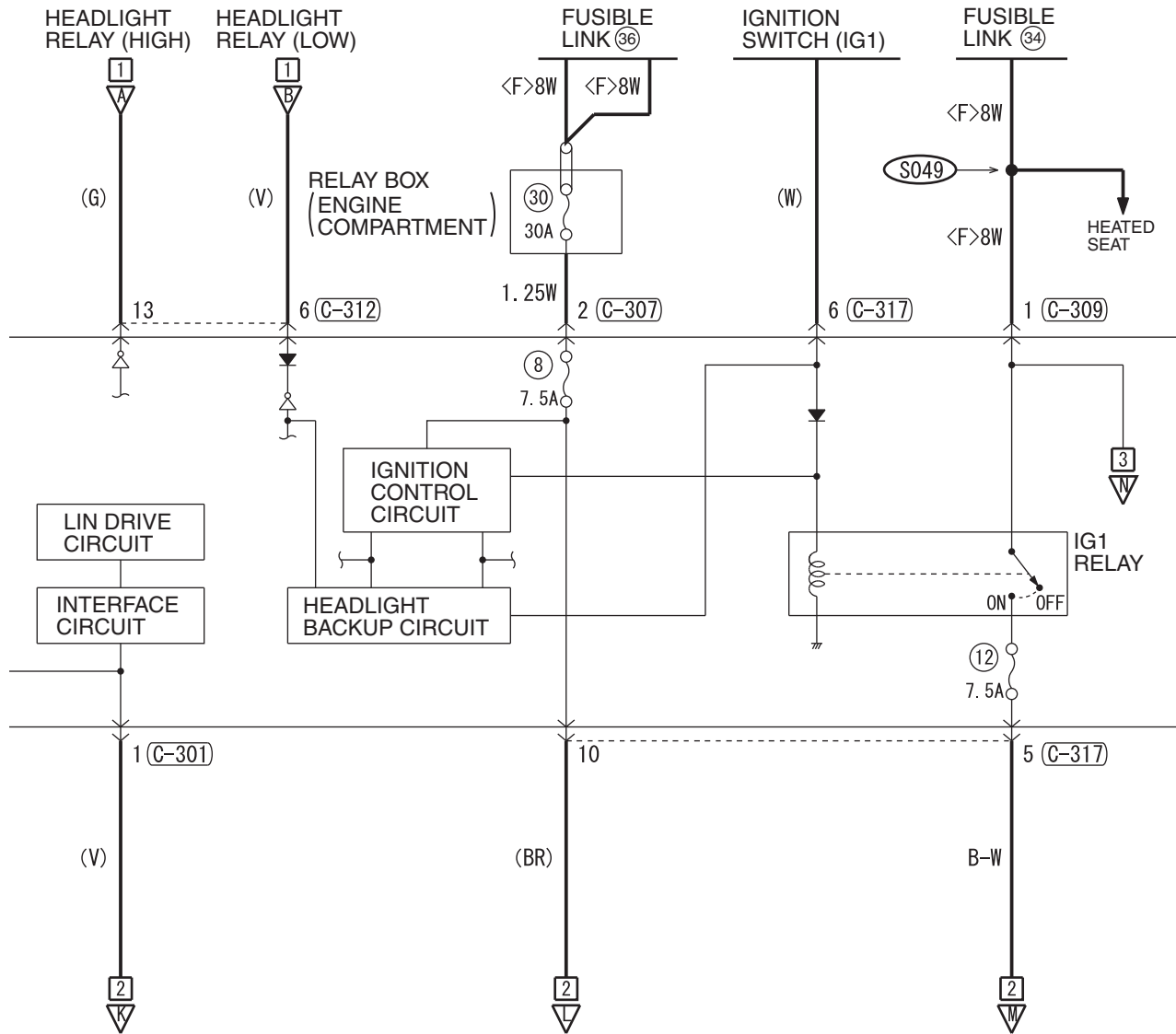

(C-317)



(D-02)



(D-28)



WIRE COLOR CODE  
 B: BLACK LG: LIGHT GREEN G: GREEN L: BLUE W: WHITE Y: YELLOW SB: SKY BLUE  
 BR: BROWN O: ORANGE GR: GRAY R: RED P: PINK V: VIOLET PU: PURPLE SI: SILVER

HAH08M11CB

TSB Revision

HEADLIGHT <DISCHARGE TYPE> (CONTINUED)

7

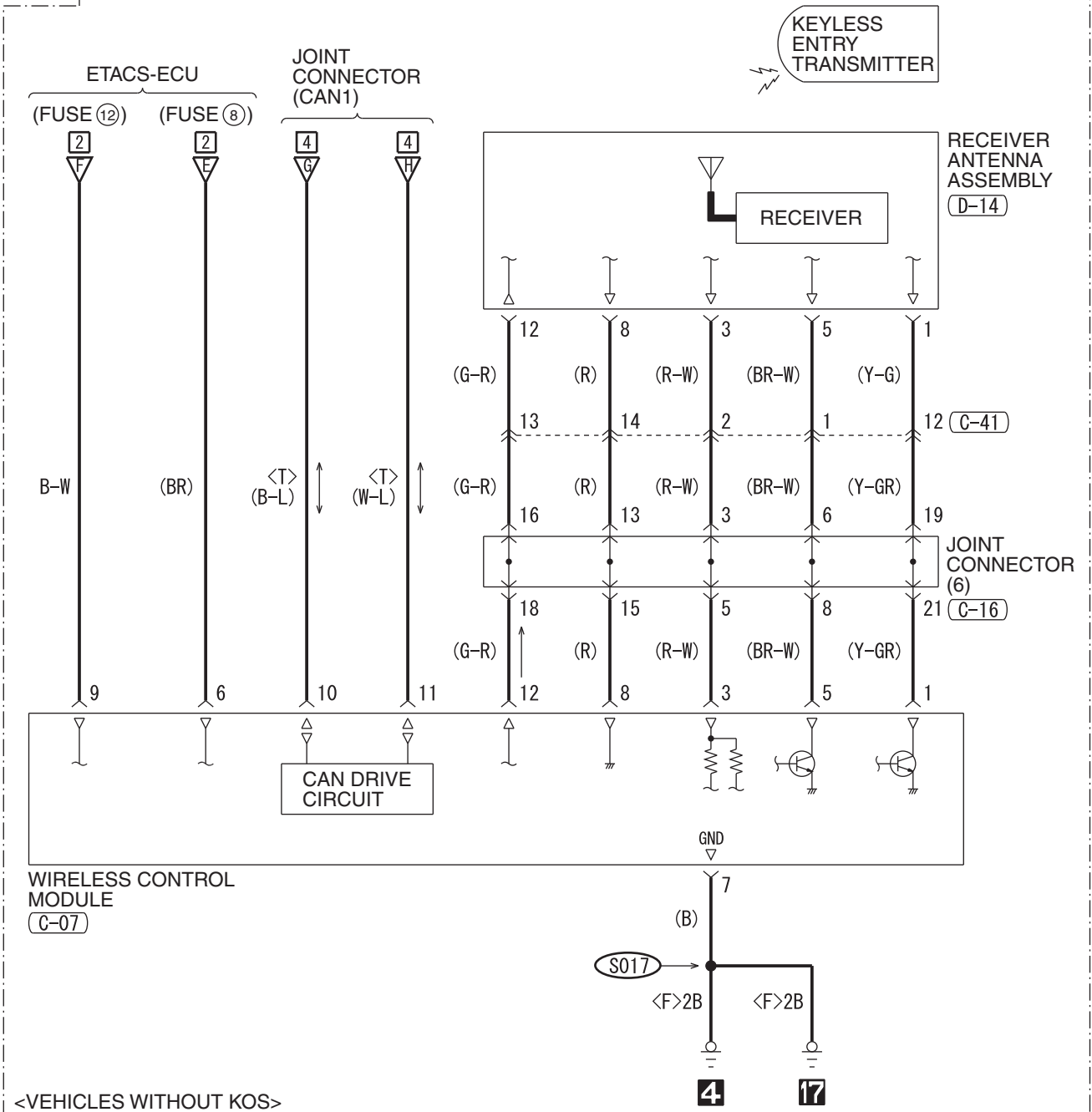

<VEHICLES WITHOUT KOS>

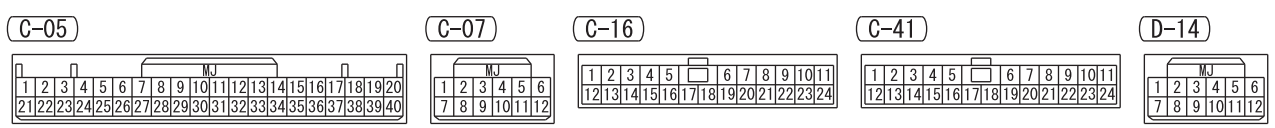

8

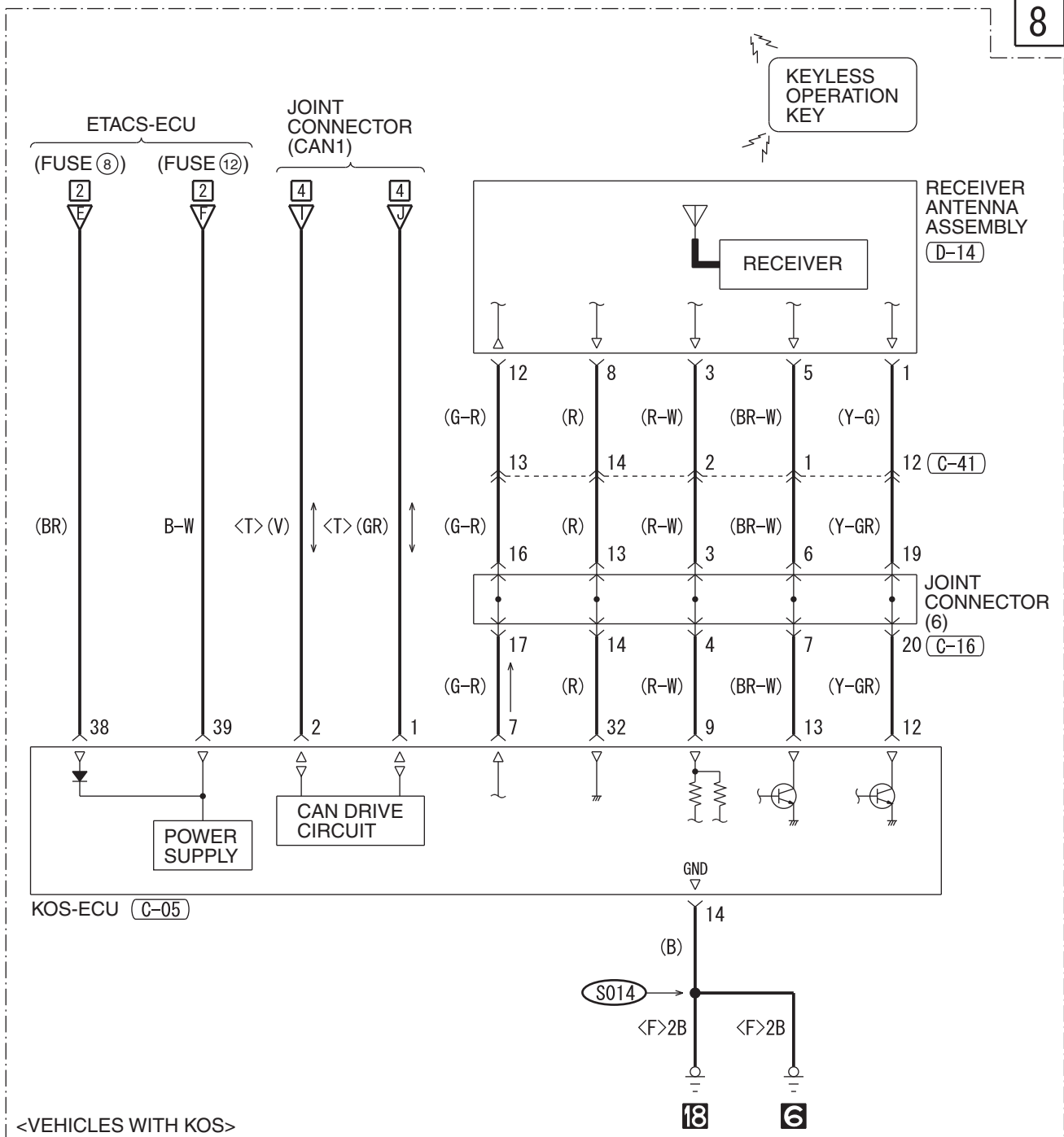

WIRE COLOR CODE

B: BLACK LG: LIGHT GREEN G: GREEN L: BLUE W: WHITE Y: YELLOW SB: SKY BLUE  
BR: BROWN O: ORANGE GR: GRAY R: RED P: PINK V: VIOLET PU: PURPLE SI: SILVER

HAH08M11DB

TSB Revision

# HEADLIGHT LEVELING SYSTEM

M1901012501263

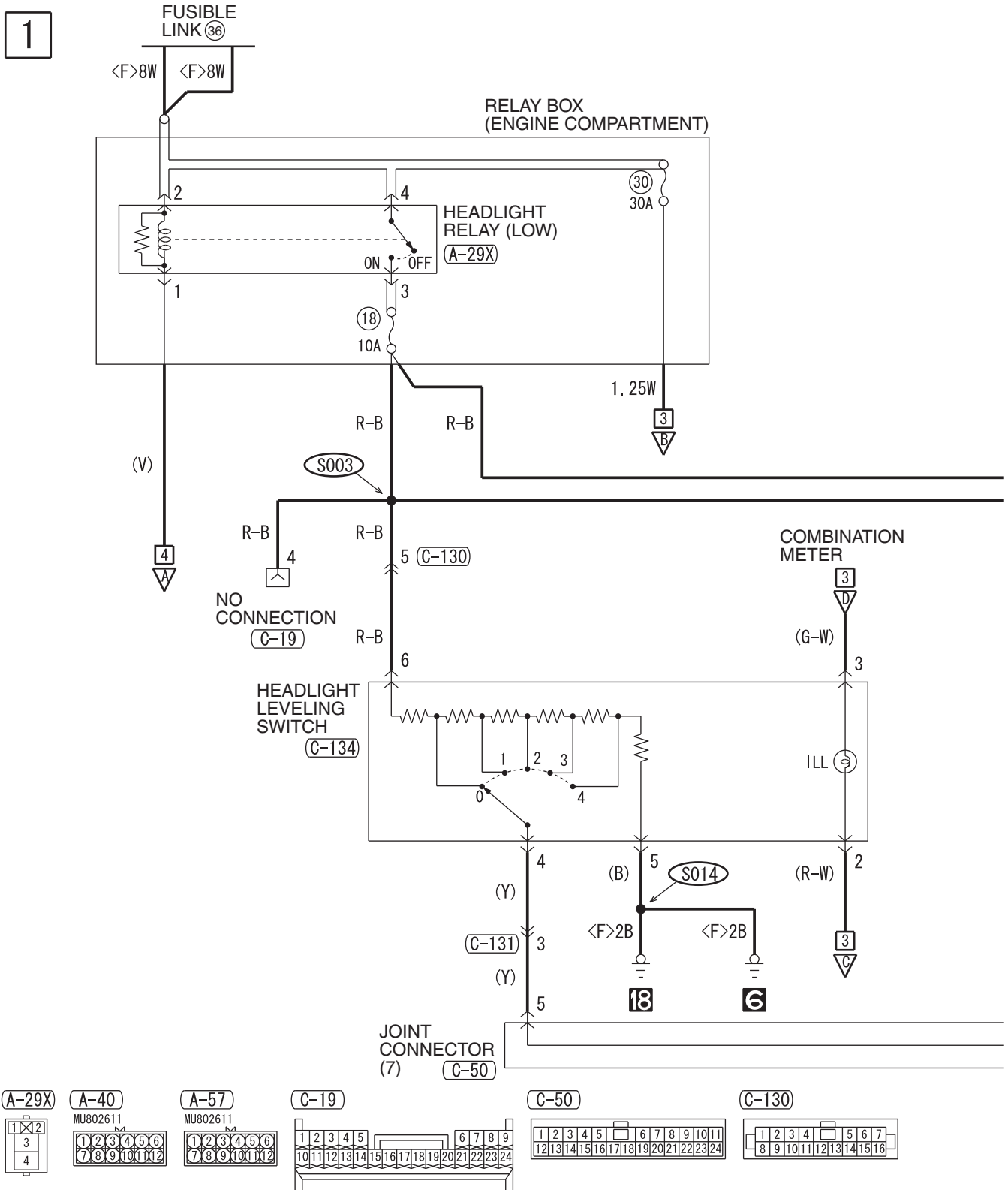

HAH08M12AA

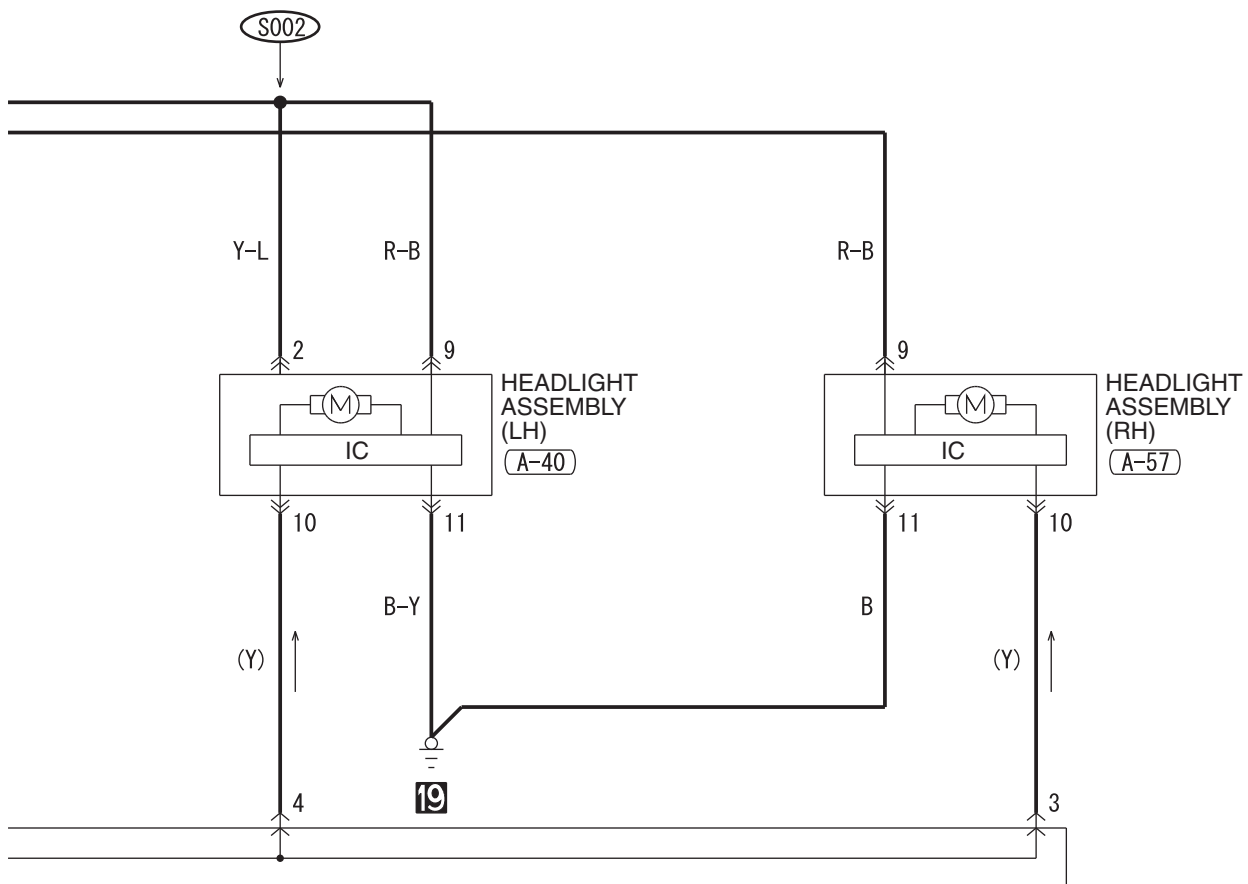

(C-131)

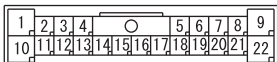

(C-134)

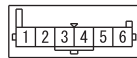

WIRE COLOR CODE

B: BLACK LG: LIGHT GREEN G: GREEN L: BLUE W: WHITE Y: YELLOW SB: SKY BLUE  
BR: BROWN O: ORANGE GR: GRAY R: RED P: PINK V: VIOLET PU: PURPLE SI: SILVER

HAH08M12AB

HEADLIGHT LEVELING SYSTEM (CONTINUED)

3

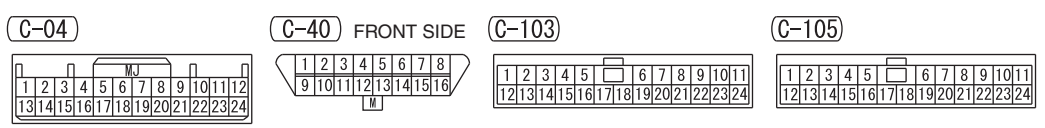
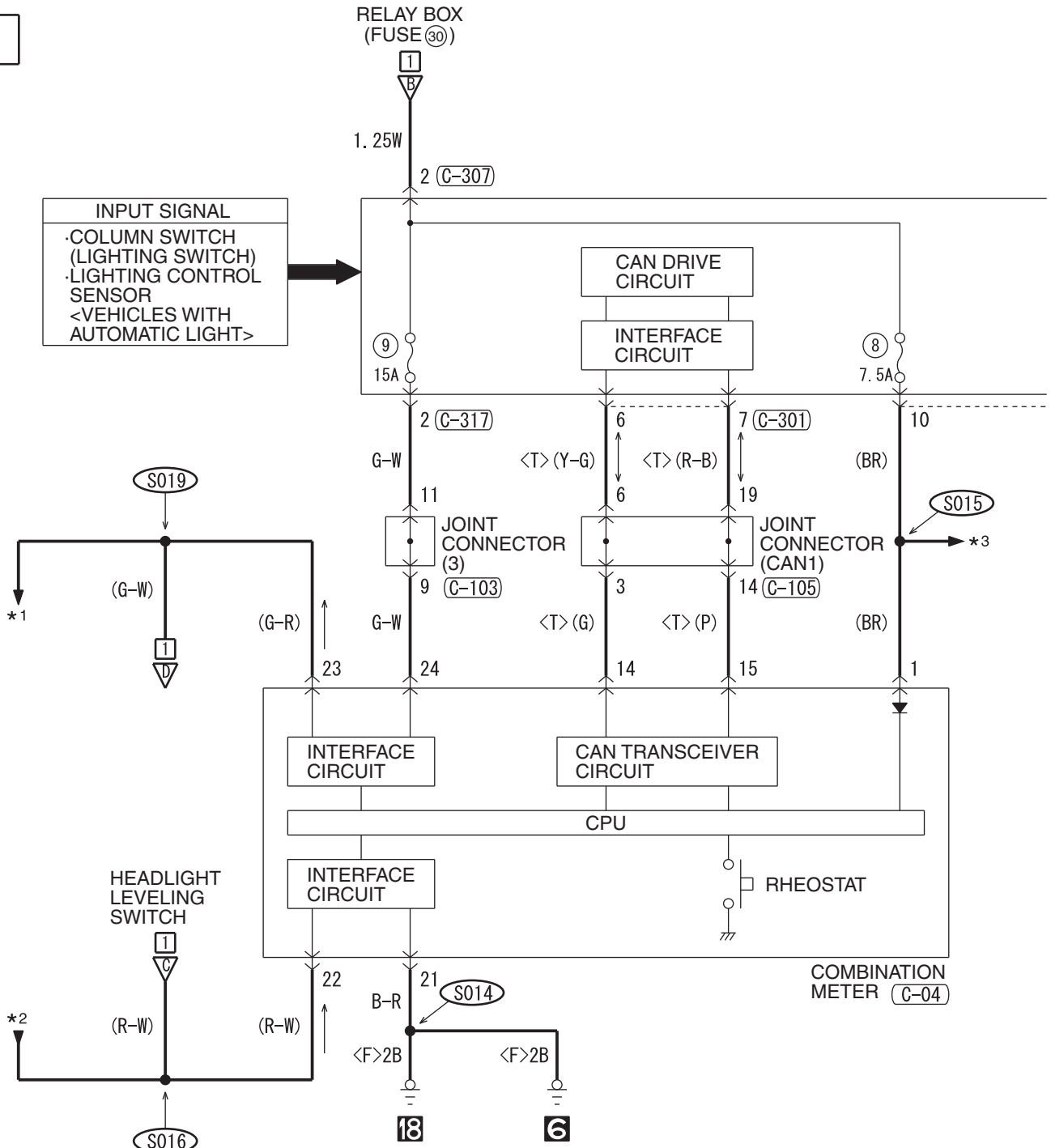



4

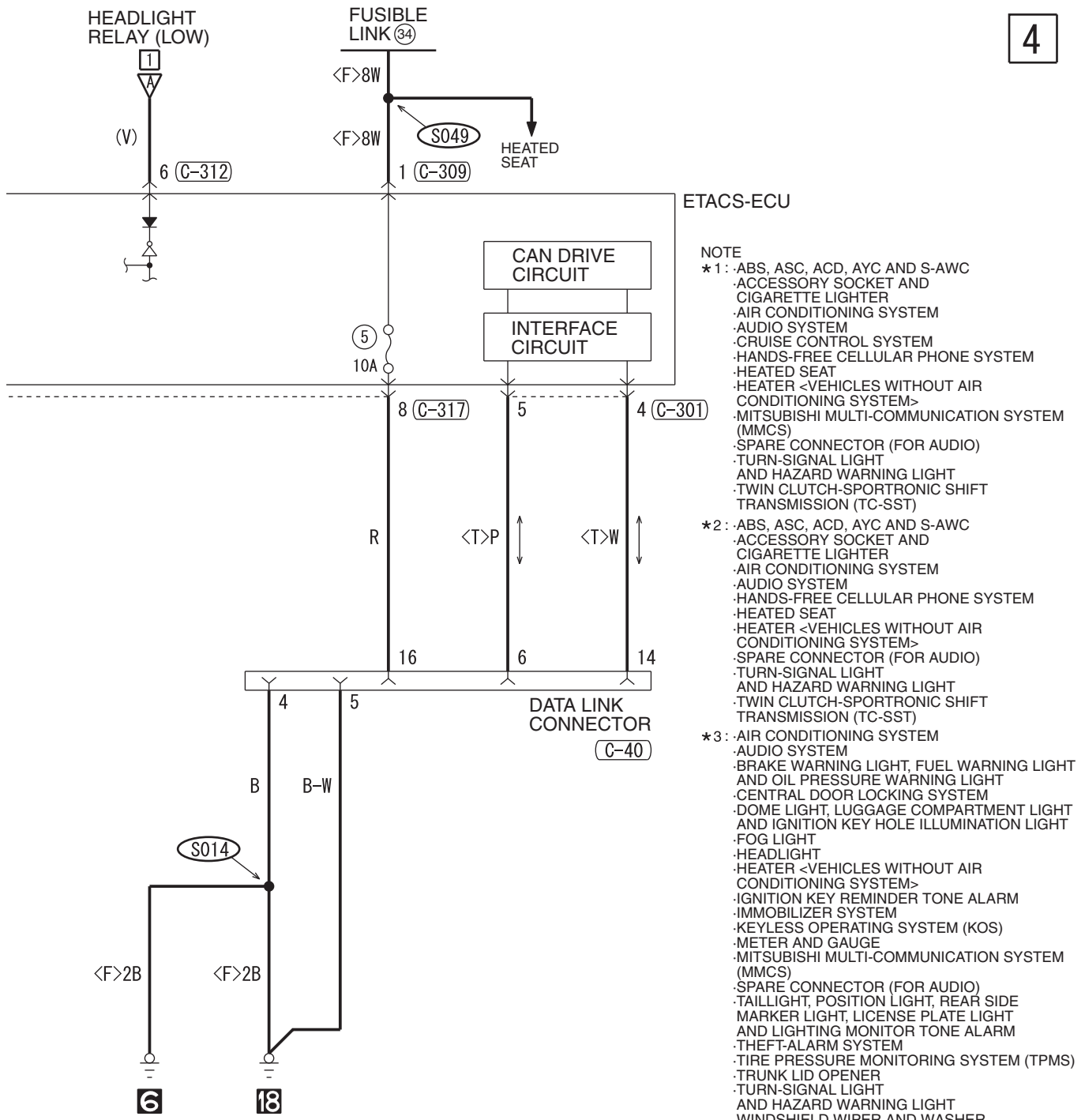

(C-301)

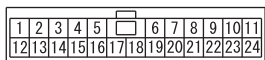

(C-307)



(C-309)



(C-312)

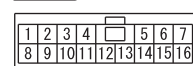

(C-317)

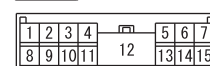

WIRE COLOR CODE

B : BLACK LG : LIGHT GREEN G : GREEN L : BLUE W : WHITE Y : YELLOW SB : SKY BLUE  
BR : BROWN O : ORANGE GR : GRAY R : RED P : PINK V : VIOLET PU : PURPLE SI : SILVER

HAH08M12BB

# DAYTIME RUNNING LIGHT (DRL) <HALOGEN TYPE>

M1901030700550

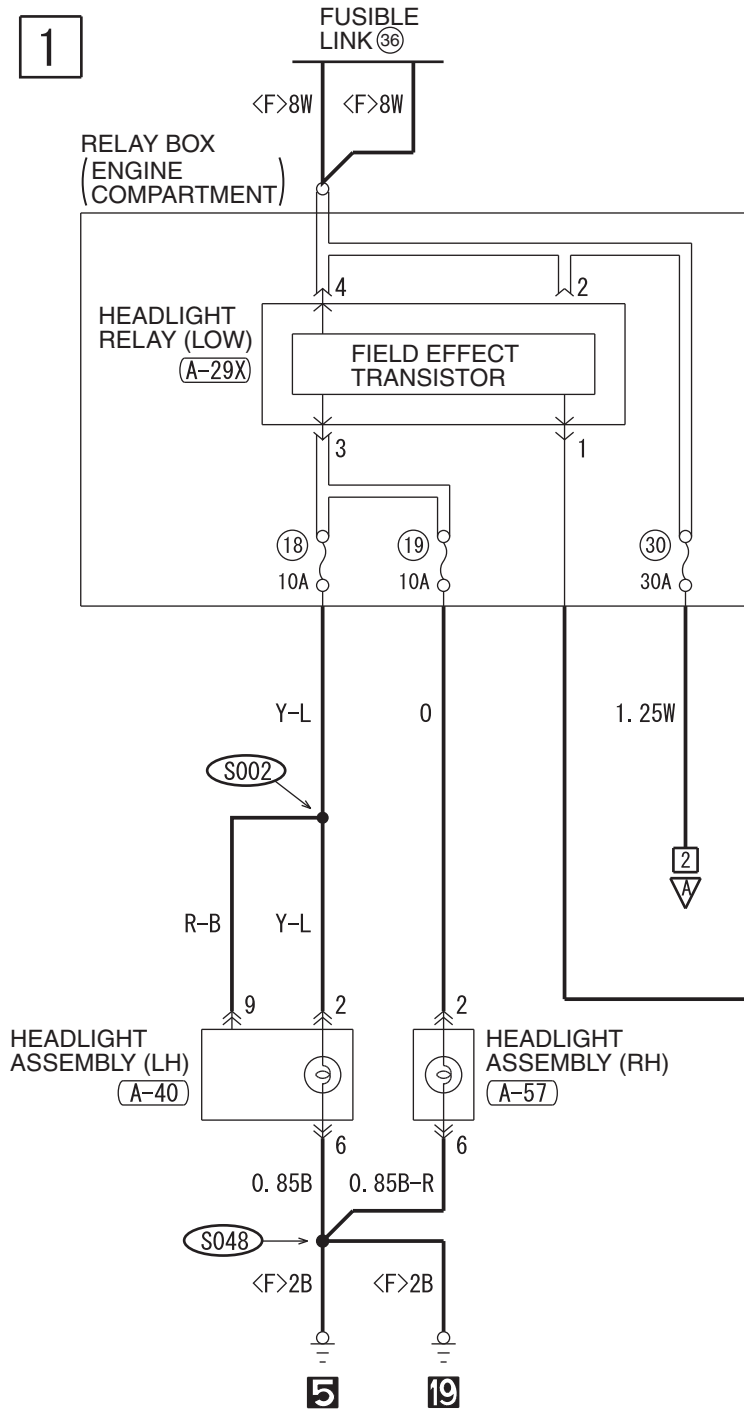

NOTE

- \*1: VEHICLES WITH AUTOMATIC LIGHT
- \*2: AIR CONDITIONING SYSTEM
- AUDIO SYSTEM
- BRAKE WARNING LIGHT, FUEL WARNING LIGHT AND OIL PRESSURE WARNING LIGHT
- CENTRAL DOOR LOCKING SYSTEM
- DOME LIGHT, LUGGAGE COMPARTMENT LIGHT AND IGNITION KEY HOLE ILLUMINATION LIGHT
- FOG LIGHT
- HEADLIGHT
- HEATED SEAT
- HEATER <VEHICLES WITHOUT AIR CONDITIONING SYSTEM>
- IGNITION KEY REMINDER TONE ALARM
- IMMOBILIZER SYSTEM
- KEYLESS OPERATING SYSTEM (KOS)
- METER AND GAUGE
- MITSUBISHI MULTI-COMMUNICATION SYSTEM (MMCS)
- SPARE CONNECTOR (FOR AUDIO)
- TAILLIGHT, POSITION LIGHT, REAR SIDE MARKER LIGHT, LICENSE PLATE LIGHT AND LIGHTING MONITOR TONE ALARM
- THEFT-ALARM SYSTEM
- TIRE PRESSURE MONITORING SYSTEM (TPMS)
- TRUNK LID OPENER
- TURN-SIGNAL LIGHT AND HAZARD WARNING LIGHT
- WINDSHIELD WIPER AND WASHER
- \*3: -ABS, ASC, ACD, AYC AND S-AWC
- AIR CONDITIONING SYSTEM
- CENTRAL DOOR LOCKING SYSTEM
- DOME LIGHT, LUGGAGE COMPARTMENT LIGHT AND IGNITION KEY HOLE ILLUMINATION LIGHT
- HEATED DOOR MIRROR
- HEATED SEAT
- HEATER <VEHICLES WITHOUT AIR CONDITIONING SYSTEM>
- IGNITION KEY REMINDER TONE ALARM <VEHICLES WITH KOS>
- IMMOBILIZER SYSTEM
- KEYLESS OPERATING SYSTEM (KOS)
- REAR WINDOW DEFOGGER
- SEAT BELT WARNING TONE ALARM
- SHIFT LOCK MECHANISM
- SUNROOF
- SUPPLEMENTAL RESTRAINT SYSTEM (SRS)
- THEFT-ALARM SYSTEM
- TIRE PRESSURE MONITORING SYSTEM (TPMS)
- TRUNK LID OPENER
- TWIN CLUTCH-SPORTRONIC SHIFT TRANSMISSION (TC-SST)

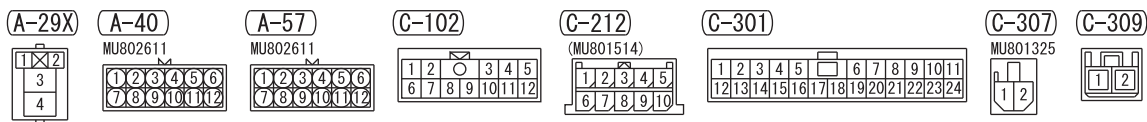

2

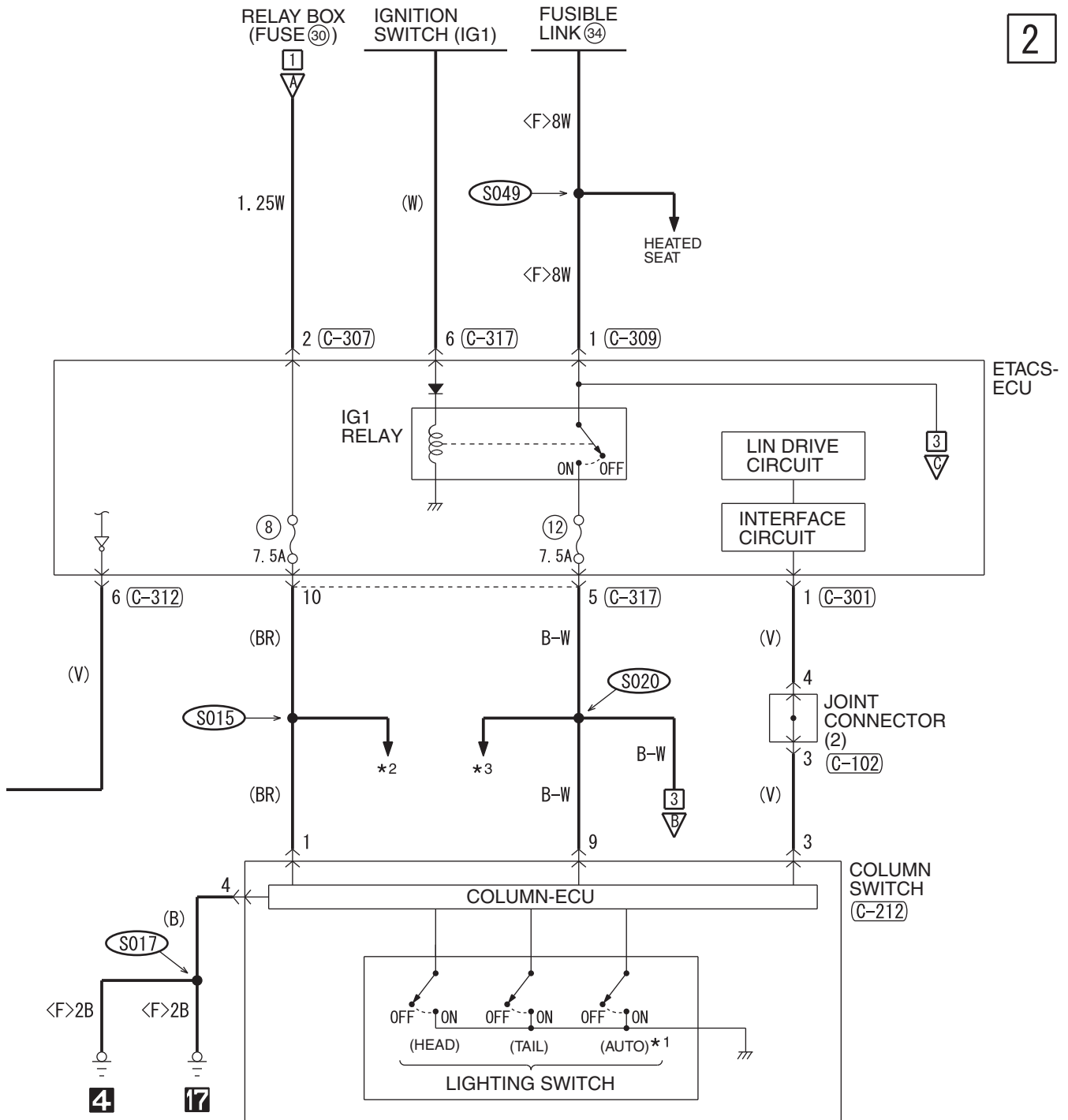

(C-312)

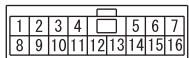

(C-317)

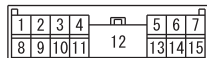

WIRE COLOR CODE

B: BLACK LG: LIGHT GREEN G: GREEN L: BLUE W: WHITE Y: YELLOW SB: SKY BLUE  
BR: BROWN O: ORANGE GR: GRAY R: RED P: PINK V: VIOLET PU: PURPLE SI: SILVER

HAH08M13AB

DAYTIME RUNNING LIGHT (DRL) <HALOGEN TYPE> (CONTINUED)

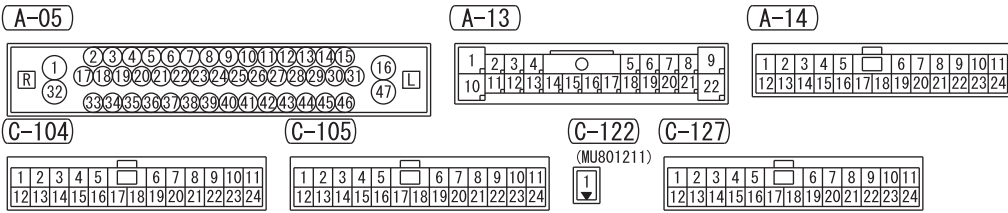
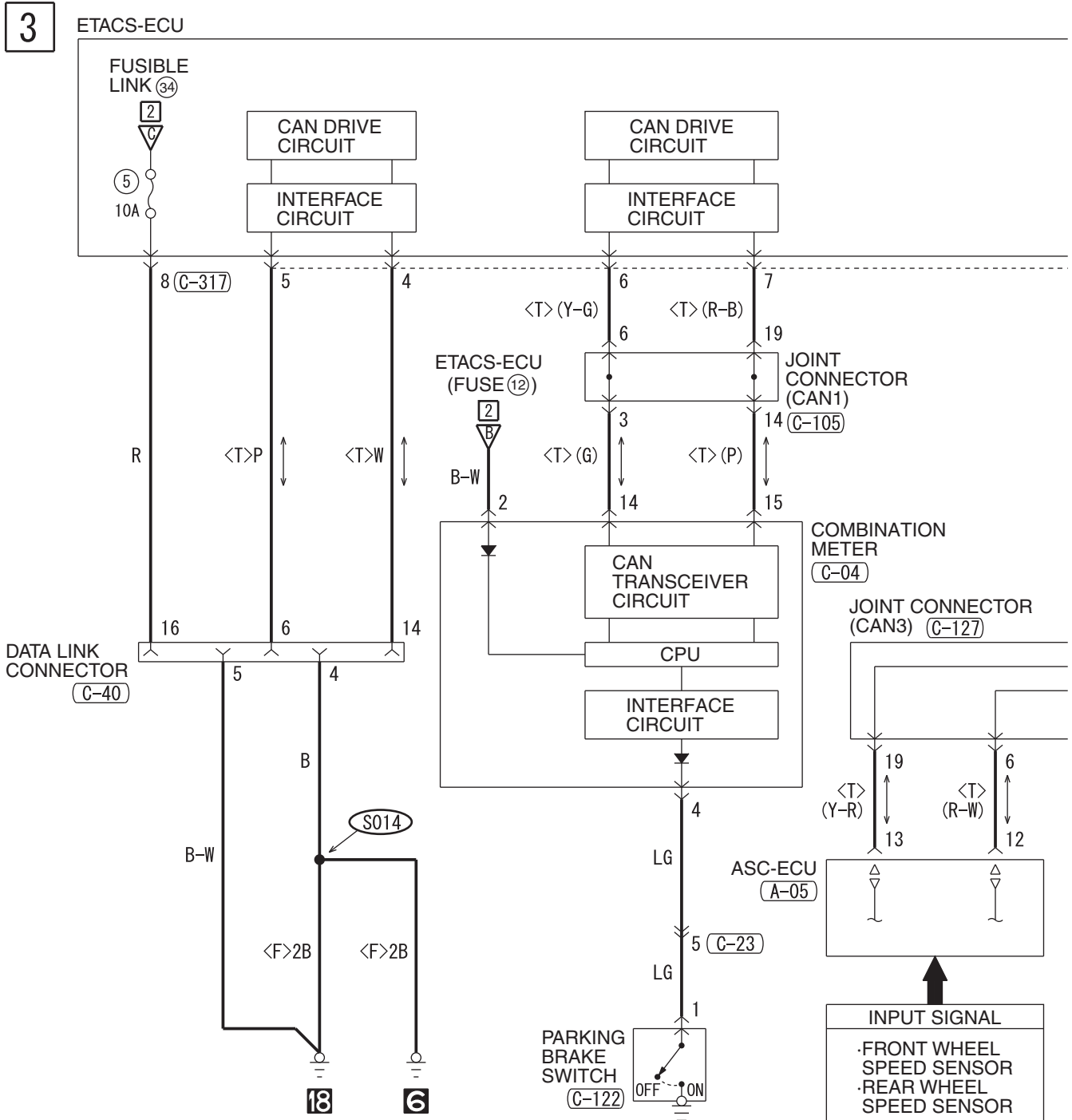

4

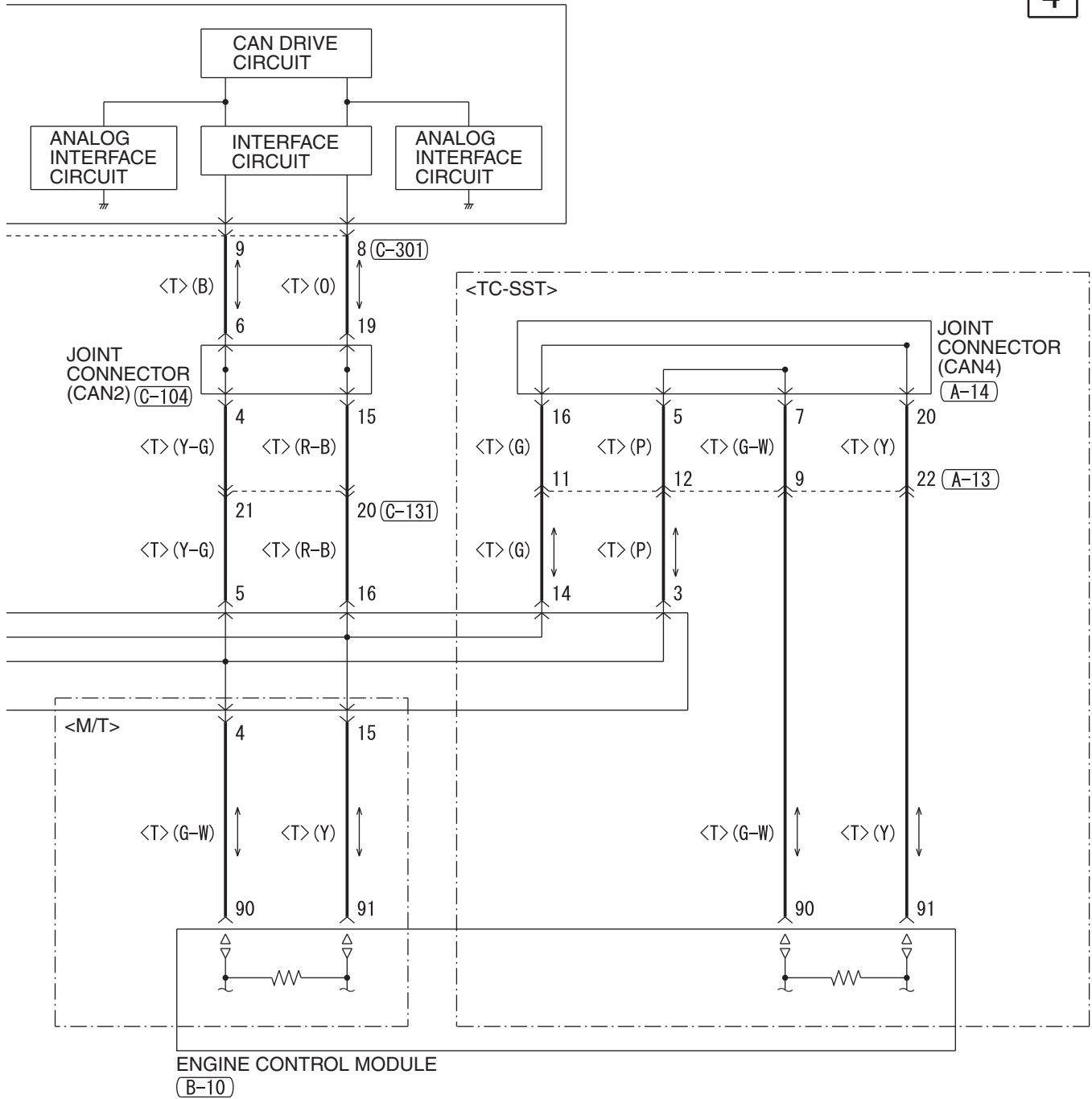

(B-10)

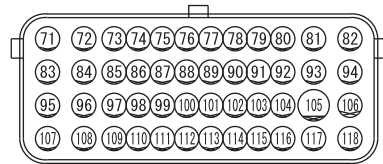

(C-04)

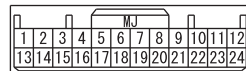

(C-23)

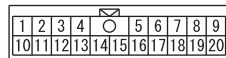

(C-40) FRONT SIDE

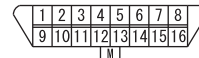

(C-131)

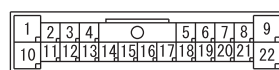

(C-301)

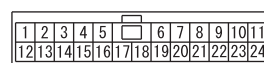

(C-317)

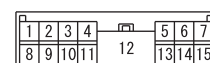

DAYTIME RUNNING LIGHT (DRL) <DISCHARGE TYPE>

M1901030700561

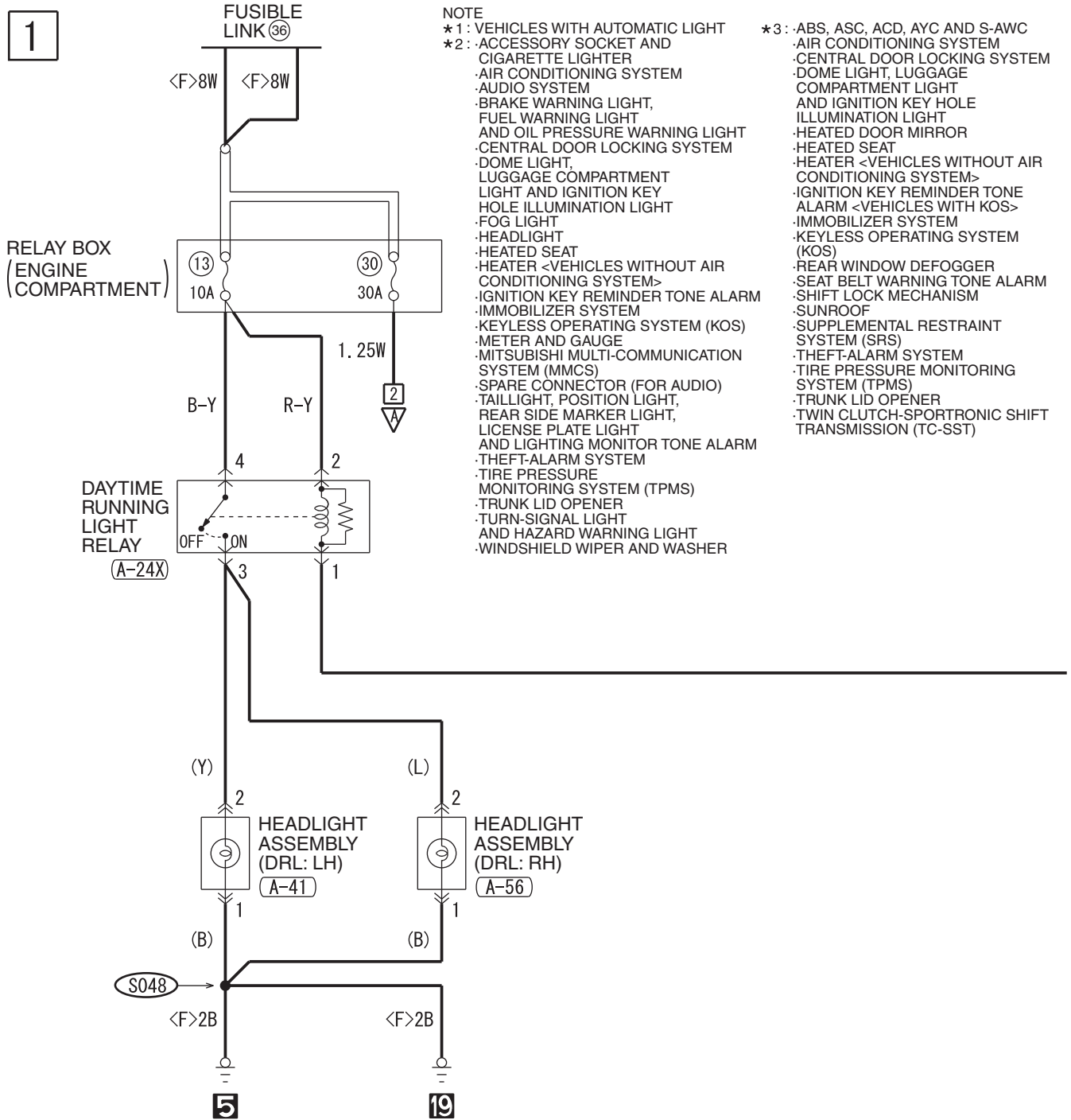

NOTE

- \*1: VEHICLES WITH AUTOMATIC LIGHT
  - \*2: ACCESSORY SOCKET AND CIGARETTE LIGHTER
  - \*3: ABS, ASC, ACD, AYC AND S-AWC
- AIR CONDITIONING SYSTEM
  - CENTRAL DOOR LOCKING SYSTEM
  - DOME LIGHT, LUGGAGE COMPARTMENT LIGHT AND IGNITION KEY HOLE ILLUMINATION LIGHT
  - HEATED DOOR MIRROR
  - HEATED SEAT
  - HEATER <VEHICLES WITHOUT AIR CONDITIONING SYSTEM>
  - IGNITION KEY REMINDER TONE ALARM <VEHICLES WITH KOS>
  - IMMOBILIZER SYSTEM
  - KEYLESS OPERATING SYSTEM (KOS)
  - REAR WINDOW DEFOGGER
  - SEAT BELT WARNING TONE ALARM
  - SHIFT LOCK MECHANISM
  - SUNROOF
  - SUPPLEMENTAL RESTRAINT SYSTEM (SRS)
  - THEFT-ALARM SYSTEM
  - TIRE PRESSURE MONITORING SYSTEM (TPMS)
  - TRUNK LID OPENER
  - TWIN CLUTCH-SPORTRONIC SHIFT TRANSMISSION (TC-SST)
- BRAKE WARNING LIGHT, FUEL WARNING LIGHT AND OIL PRESSURE WARNING LIGHT
  - CENTRAL DOOR LOCKING SYSTEM
  - DOME LIGHT, LUGGAGE COMPARTMENT LIGHT AND IGNITION KEY HOLE ILLUMINATION LIGHT
  - FOG LIGHT
  - HEADLIGHT
  - HEATED SEAT
  - HEATER <VEHICLES WITHOUT AIR CONDITIONING SYSTEM>
  - IGNITION KEY REMINDER TONE ALARM
  - IMMOBILIZER SYSTEM
  - KEYLESS OPERATING SYSTEM (KOS)
  - METER AND GAUGE
  - MITSUBISHI MULTI-COMMUNICATION SYSTEM (MMCS)
  - SPARE CONNECTOR (FOR AUDIO)
  - TAILLIGHT, POSITION LIGHT, REAR SIDE MARKER LIGHT, LICENSE PLATE LIGHT AND LIGHTING MONITOR TONE ALARM
  - THEFT-ALARM SYSTEM
  - TIRE PRESSURE MONITORING SYSTEM (TPMS)
  - TRUNK LID OPENER
  - TURN-SIGNAL LIGHT AND HAZARD WARNING LIGHT
  - WINDSHIELD WIPER AND WASHER

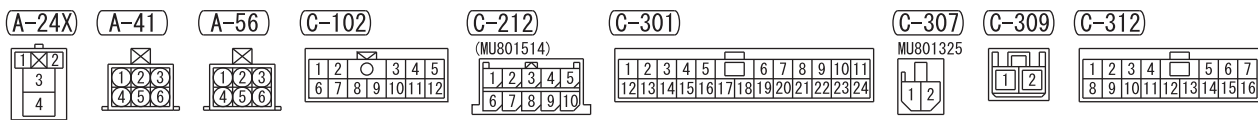

2

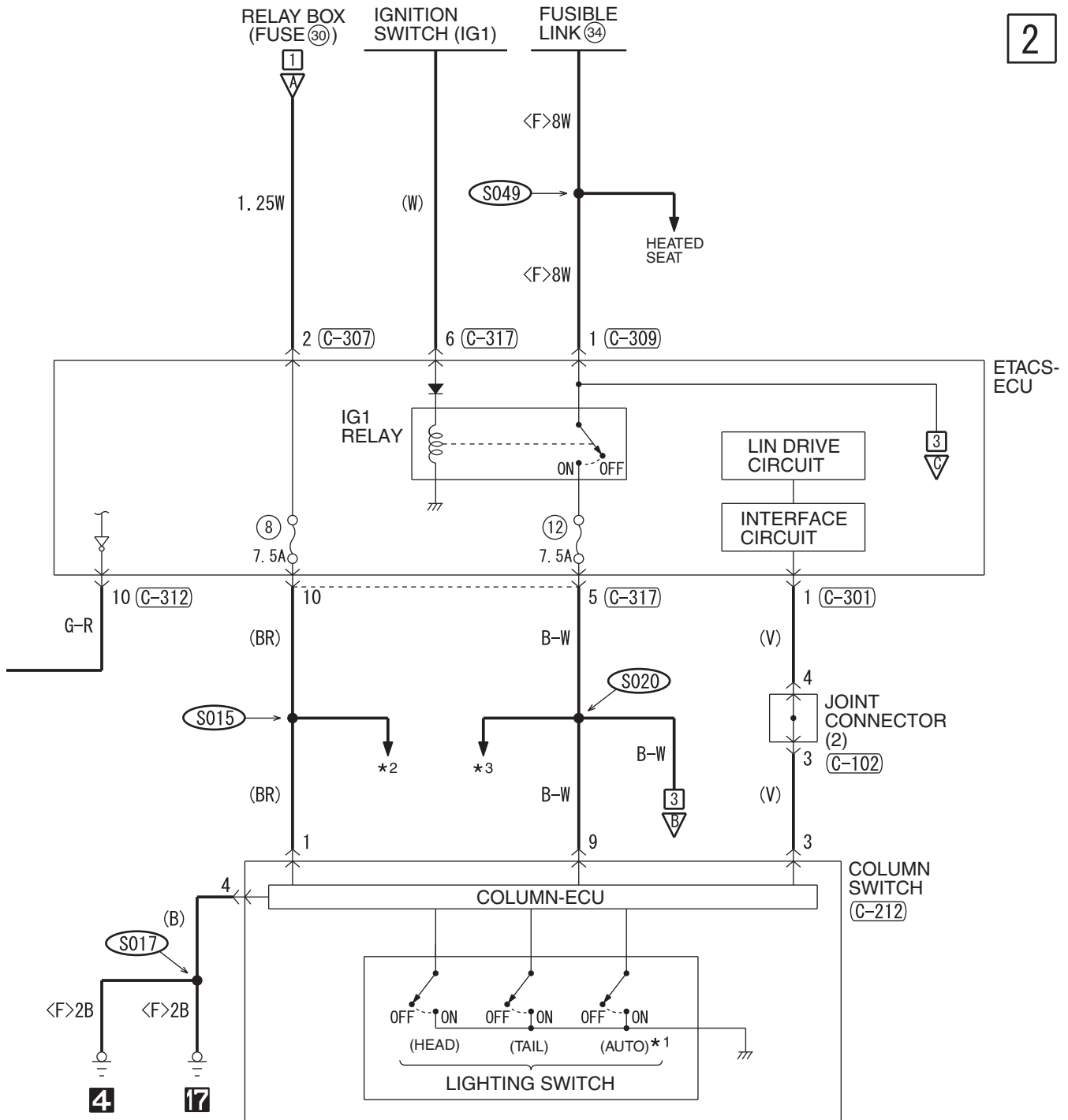

(C-317)

1	2	3	4	5	6	7	
8	9	10	11	12	13	14	15

**WIRE COLOR CODE**

B: BLACK LG: LIGHT GREEN G: GREEN L: BLUE W: WHITE Y: YELLOW SB: SKY BLUE  
 BR: BROWN O: ORANGE GR: GRAY R: RED P: PINK V: VIOLET PU: PURPLE SI: SILVER

HAH08M14AB

DAYTIME RUNNING LIGHT (DRL) <DISCHARGE TYPE> (CONTINUED)

3

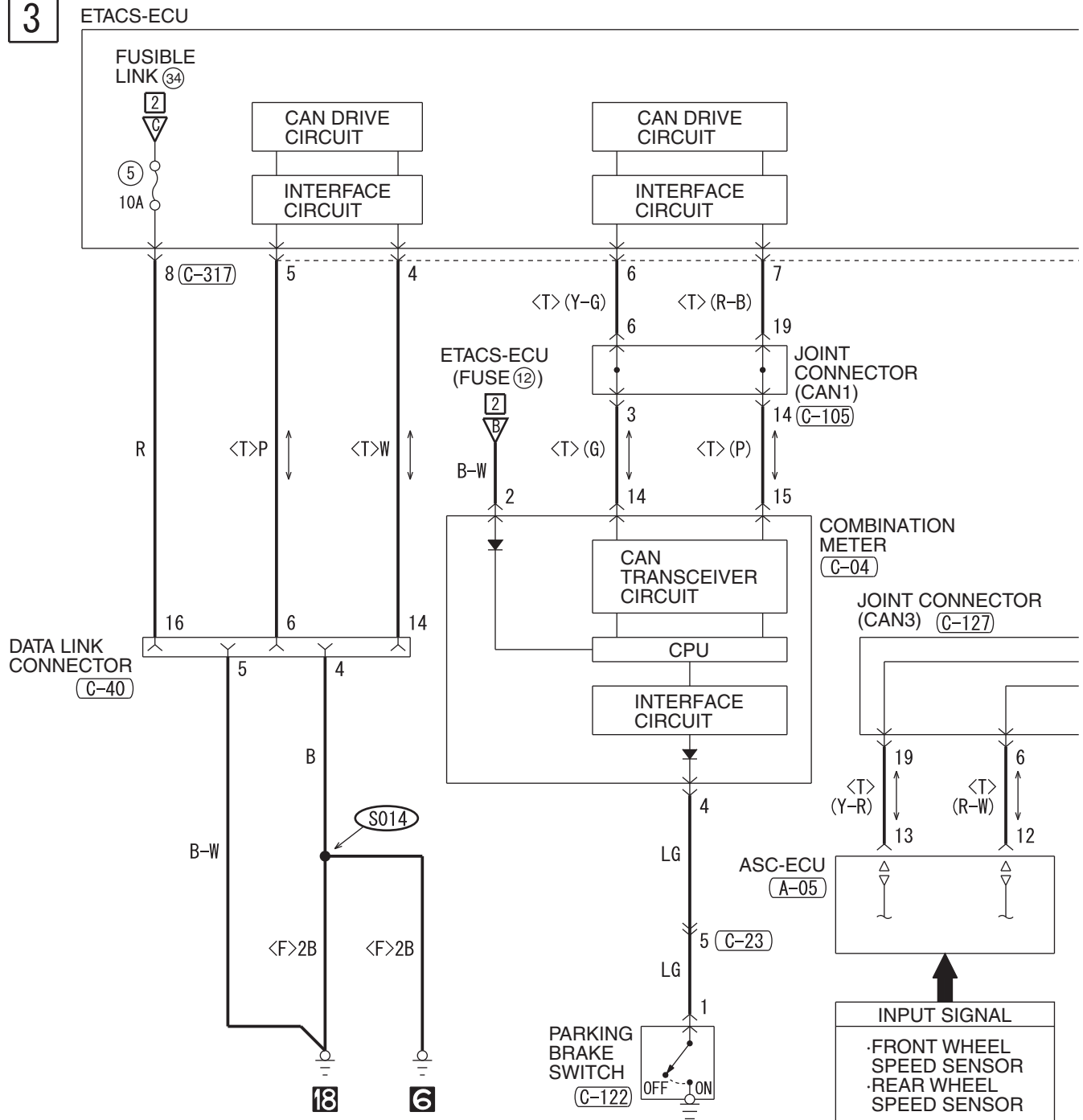

(A-05)

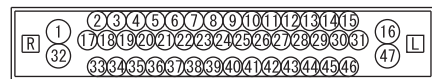

(A-13)

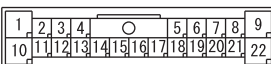

(A-14)

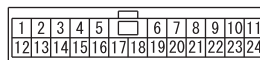

(C-104)

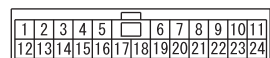

(C-105)

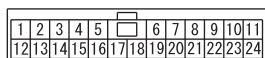

(C-122)



(C-127)





4

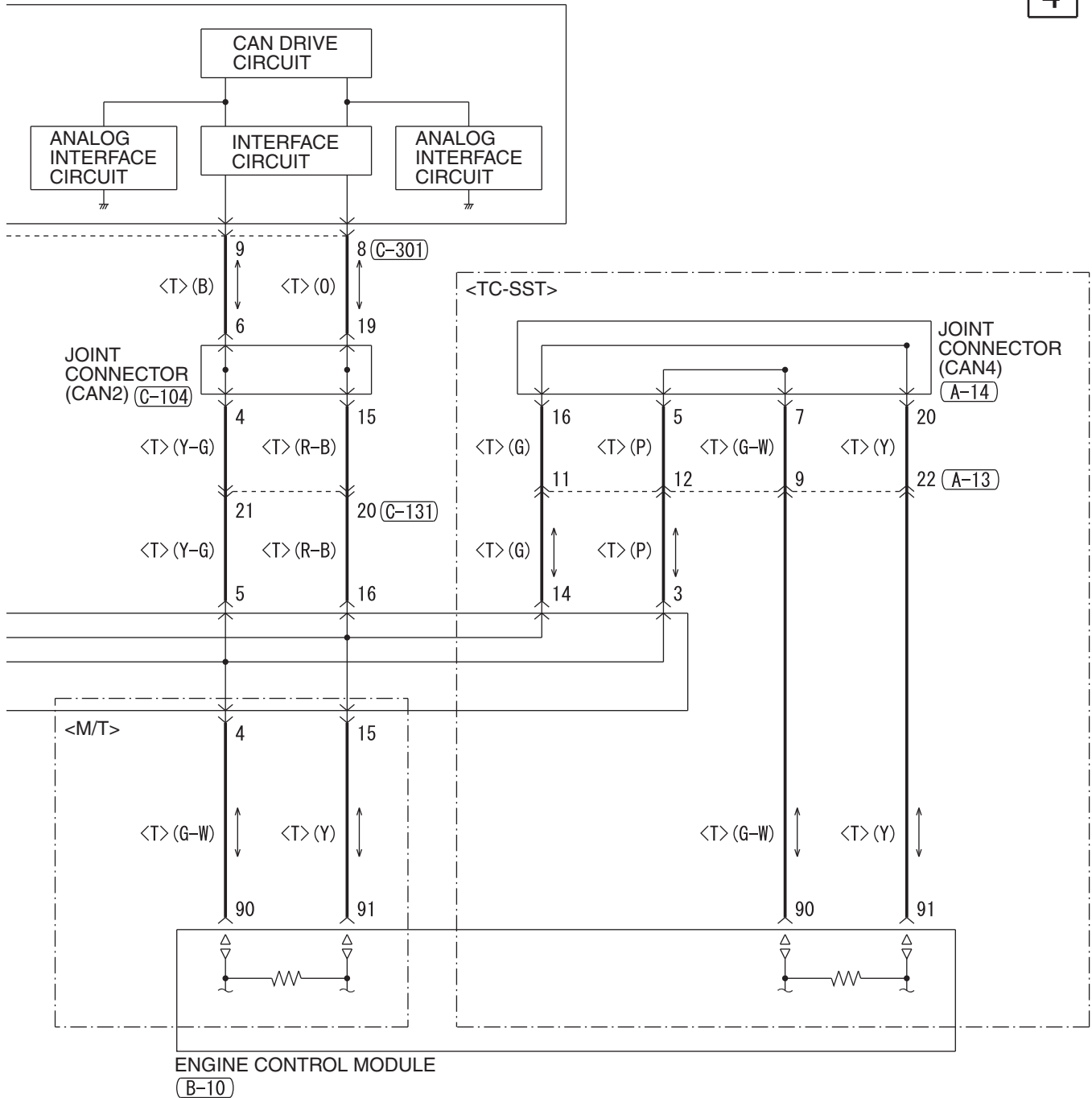

(B-10)

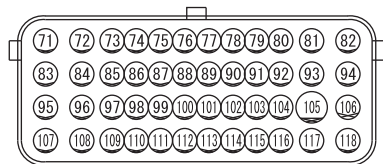

(C-04)

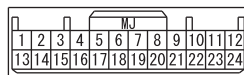

(C-23)

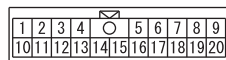

(C-40) FRONT SIDE



(C-131)

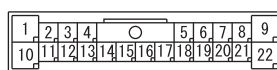

(C-301)

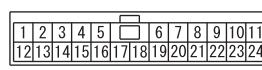

(C-317)

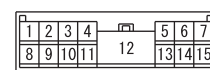

# FOG LIGHT

1

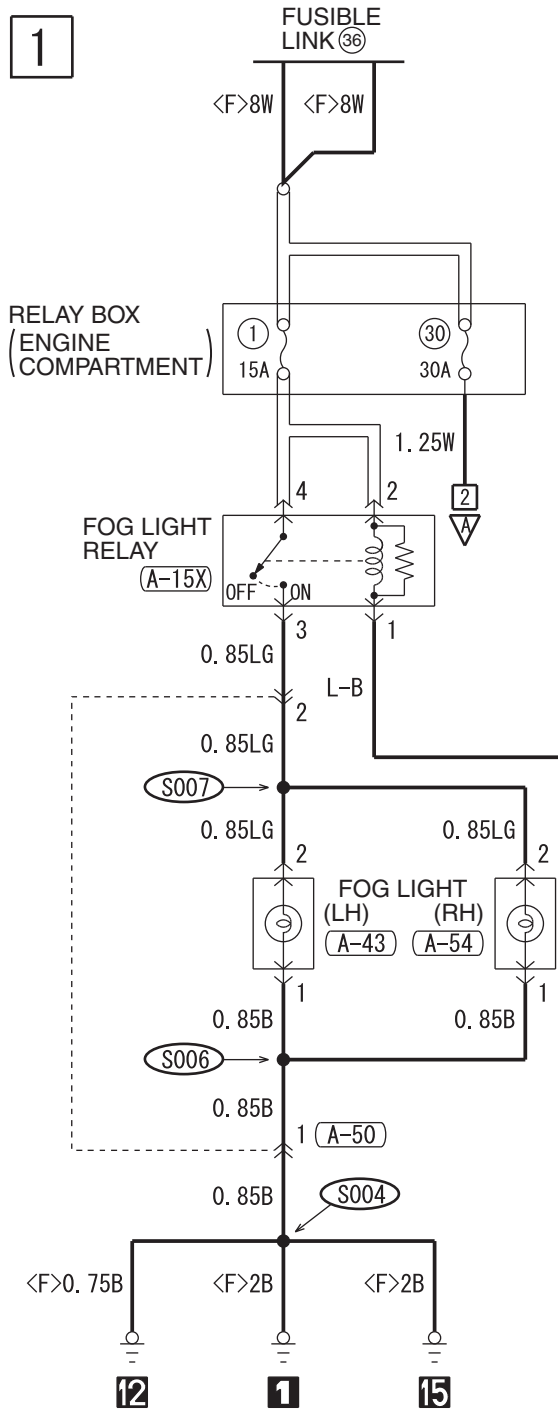

NOTE

- \*1: VEHICLES WITH AUTOMATIC LIGHT
  - \*2: ABS, ASC, ACD, AYC AND S-AWC
- AIR CONDITIONING SYSTEM
  - BRAKE WARNING LIGHT, FUEL PRESSURE WARNING LIGHT AND OIL PRESSURE WARNING LIGHT
  - CENTRAL DOOR LOCKING SYSTEM
  - CHARGING SYSTEM
  - COOLING SYSTEM
  - CRUISE CONTROL SYSTEM
  - DOME LIGHT, LUGGAGE COMPARTMENT LIGHT AND IGNITION KEY HOLE ILLUMINATION LIGHT
  - DOOR AJAR WARNING TONE ALARM
  - HANDS-FREE CELLULAR PHONE SYSTEM
  - HEATED DOOR MIRROR
  - HEATED SEAT
  - HEATER <VEHICLES WITHOUT AIR CONDITIONING SYSTEM>
  - IGNITION KEY REMINDER TONE ALARM <VEHICLES WITH KOS>
  - IMMOBILIZER SYSTEM
  - KEYLESS OPERATING SYSTEM (KOS)
  - METER AND GAUGE
  - MFI SYSTEM
  - PARKING BRAKE REMINDER TONE ALARM
  - REAR WINDOW DEFOGGER
  - SEAT BELT WARNING TONE ALARM
  - SHIFT LOCK MECHANISM
  - SUNROOF
  - SUPPLEMENTAL RESTRAINT SYSTEM (SRS)
  - THEFT-ALARM SYSTEM
  - TIRE PRESSURE MONITORING SYSTEM (TPMS)
  - TRUNK LID OPENER
  - TWIN CLUTCH-SPORTRONIC SHIFT TRANSMISSION (TC-SST)

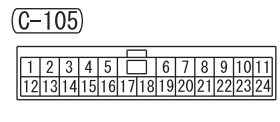
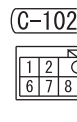
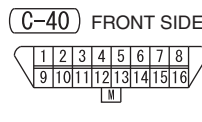
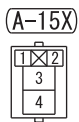
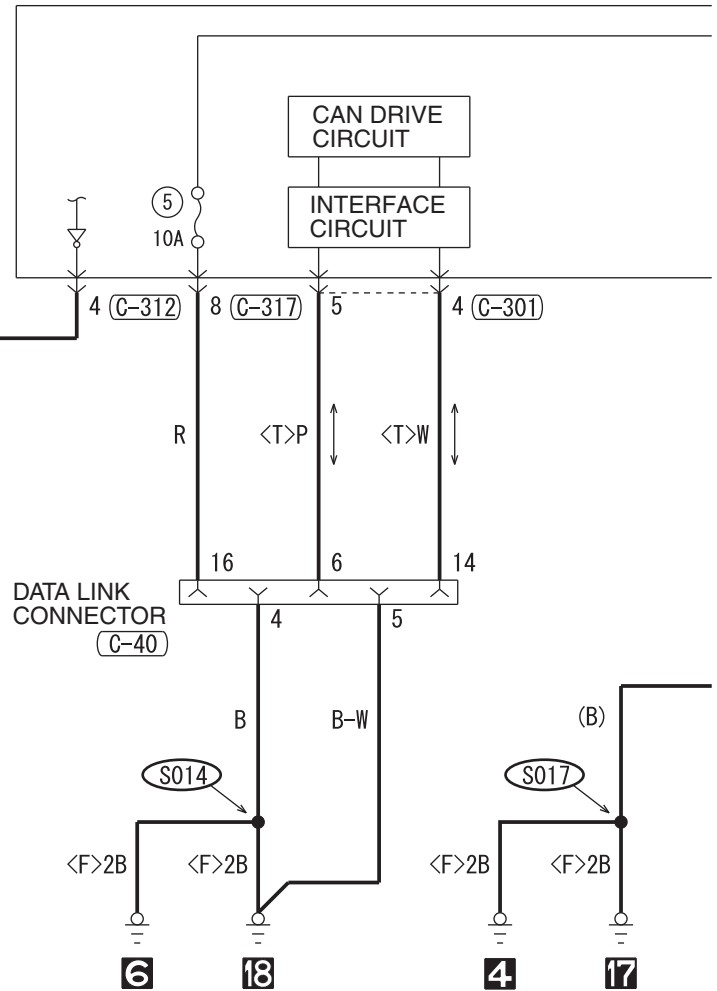

2

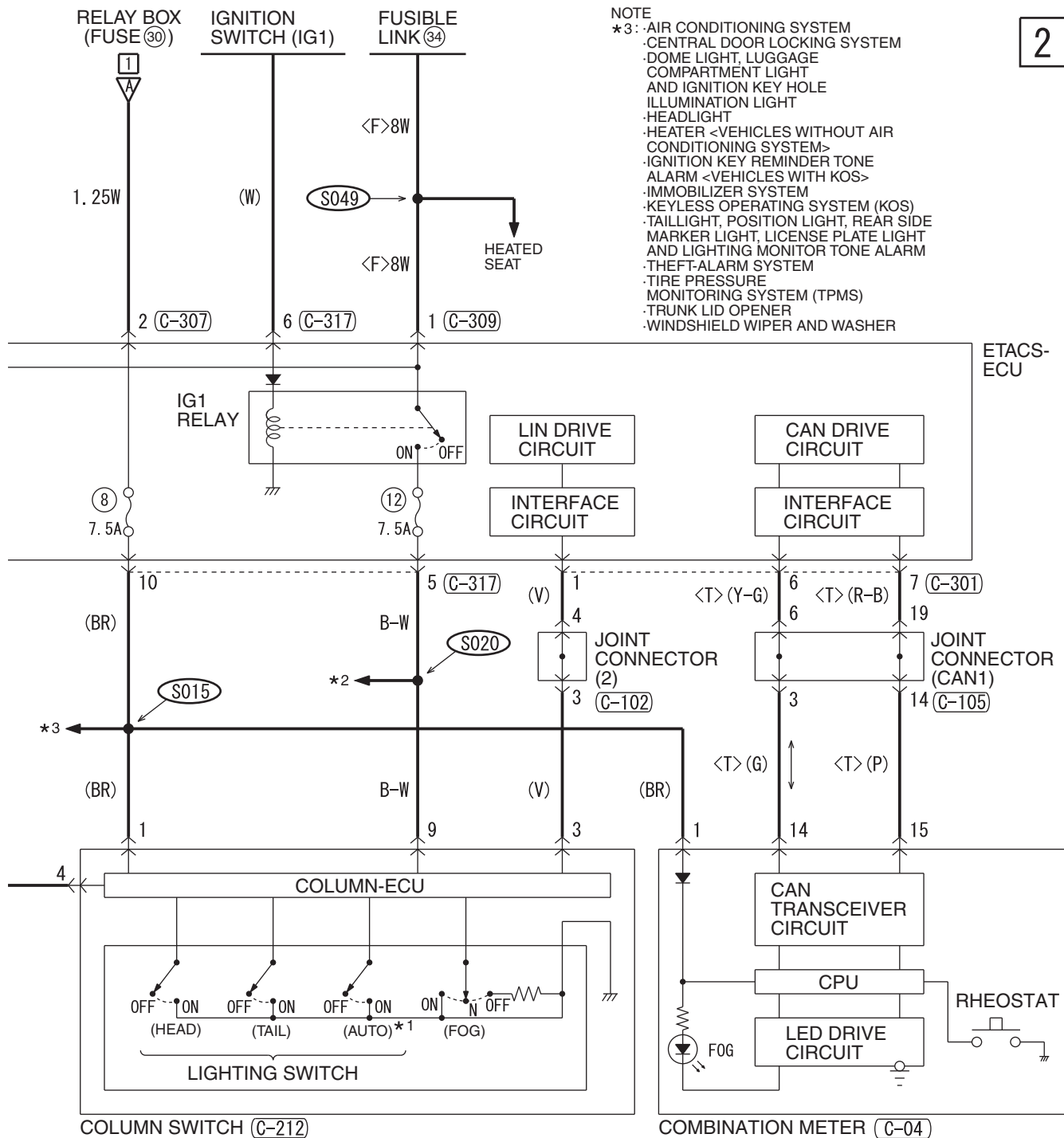

NOTE  
\*3: AIR CONDITIONING SYSTEM  
CENTRAL DOOR LOCKING SYSTEM  
DOME LIGHT, LUGGAGE  
COMPARTMENT LIGHT  
AND IGNITION KEY HOLE  
ILLUMINATION LIGHT  
HEADLIGHT  
HEATER <VEHICLES WITHOUT AIR  
CONDITIONING SYSTEM>  
IGNITION KEY REMINDER TONE  
ALARM <VEHICLES WITH KOS>  
IMMOBILIZER SYSTEM  
KEYLESS OPERATING SYSTEM (KOS)  
TAILLIGHT, POSITION LIGHT, REAR SIDE  
MARKER LIGHT, LICENSE PLATE LIGHT  
AND LIGHTING MONITOR TONE ALARM  
THEFT-ALARM SYSTEM  
TIRE PRESSURE  
MONITORING SYSTEM (TPMS)  
TRUNK LID OPENER  
WINDSHIELD WIPER AND WASHER

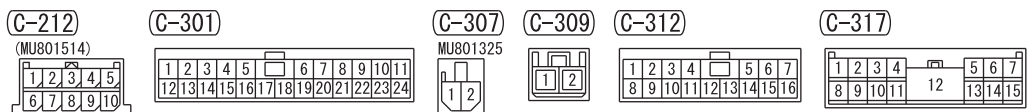

WIRE COLOR CODE  
B: BLACK LG: LIGHT GREEN G: GREEN L: BLUE W: WHITE Y: YELLOW SB: SKY BLUE  
BR: BROWN O: ORANGE GR: GRAY R: RED P: PINK V: VIOLET PU: PURPLE SI: SILVER

# TAILLIGHT, POSITION LIGHT, LICENSE PLATE LIGHT AND LIGHTING MONITOR TONE ALARM

1

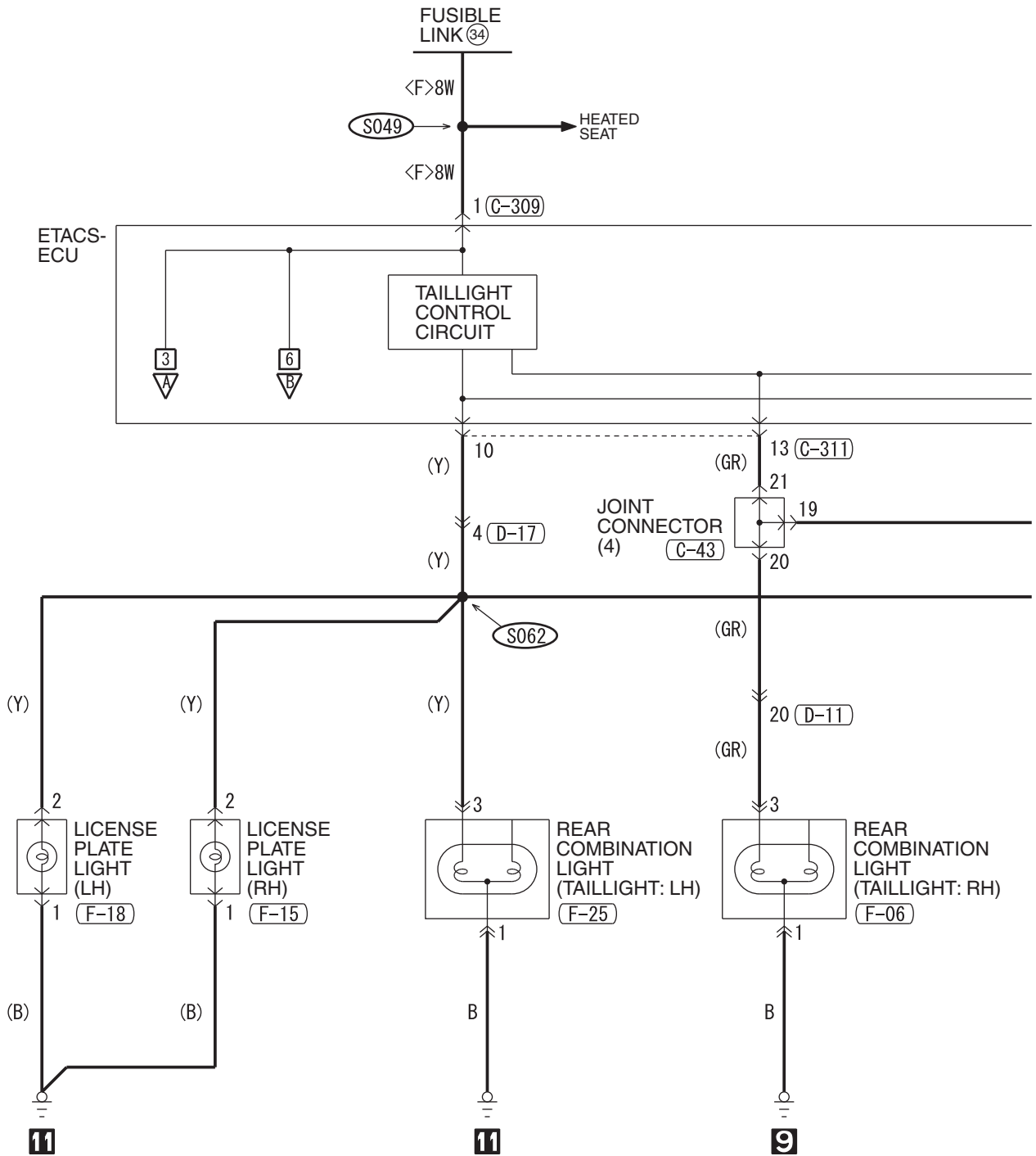

(A-40)

MU802611



(A-57)

MU802611



(C-43)

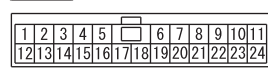

(C-211)

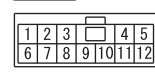

(C-304)

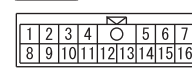

(C-309)



(C-311)

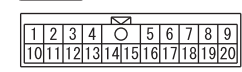

(F-25)



(F-27)

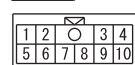

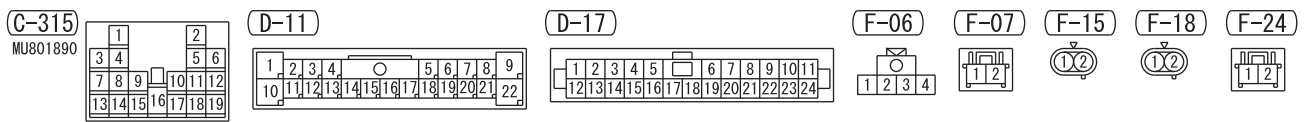
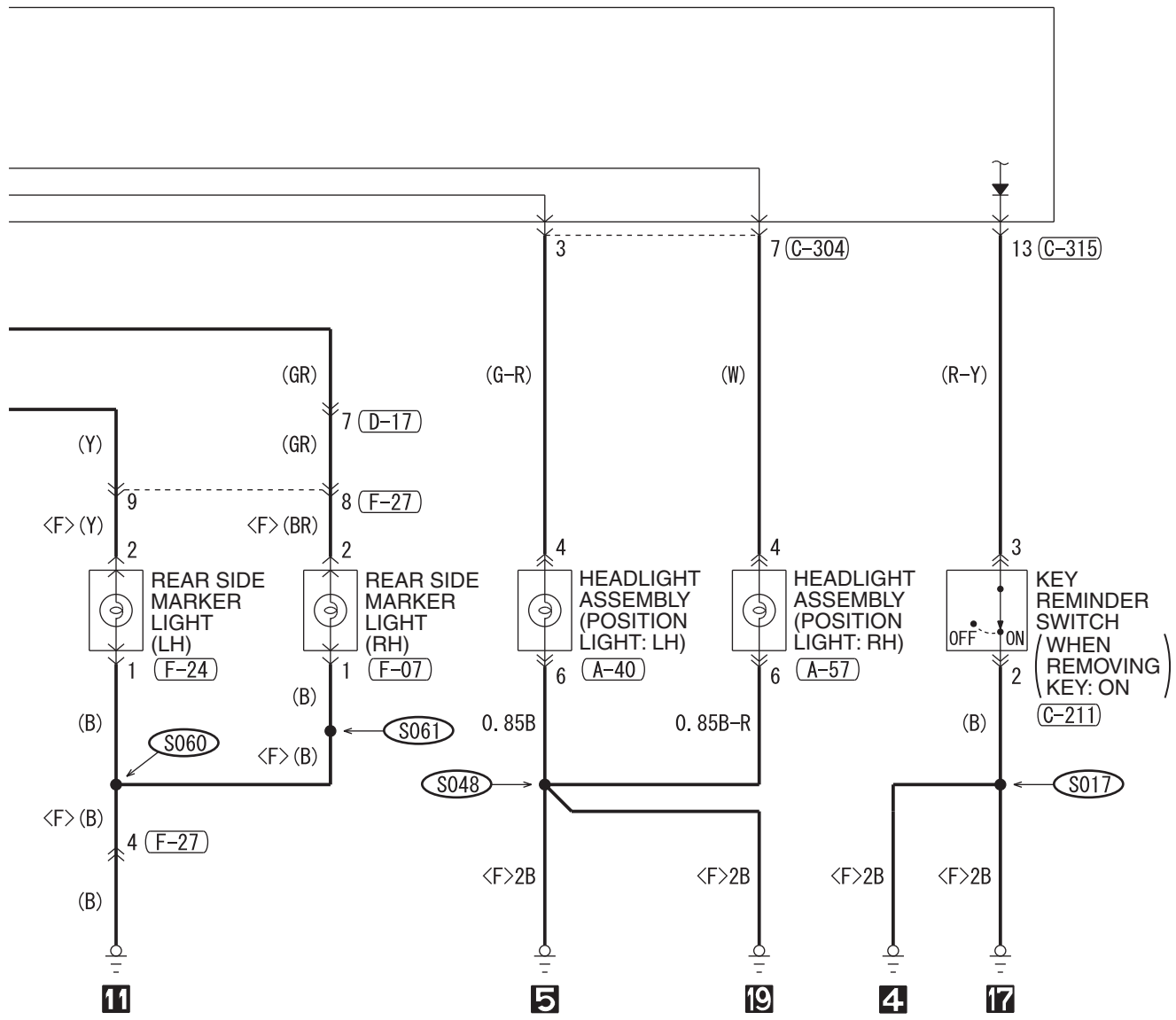

WIRE COLOR CODE  
 B : BLACK LG : LIGHT GREEN G : GREEN L : BLUE W : WHITE Y : YELLOW SB : SKY BLUE  
 BR : BROWN O : ORANGE GR : GRAY R : RED P : PINK V : VIOLET PU : PURPLE SI : SILVER

HAH08M16AB

TAILLIGHT, POSITION LIGHT, LICENSE PLATE LIGHT AND LIGHTING MONITOR TONE ALARM (CONTINUED)

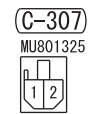
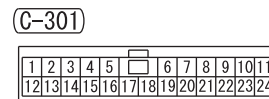
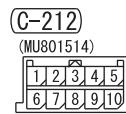
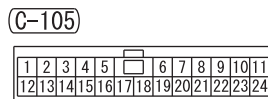
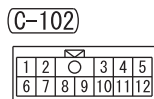
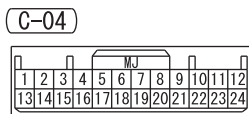
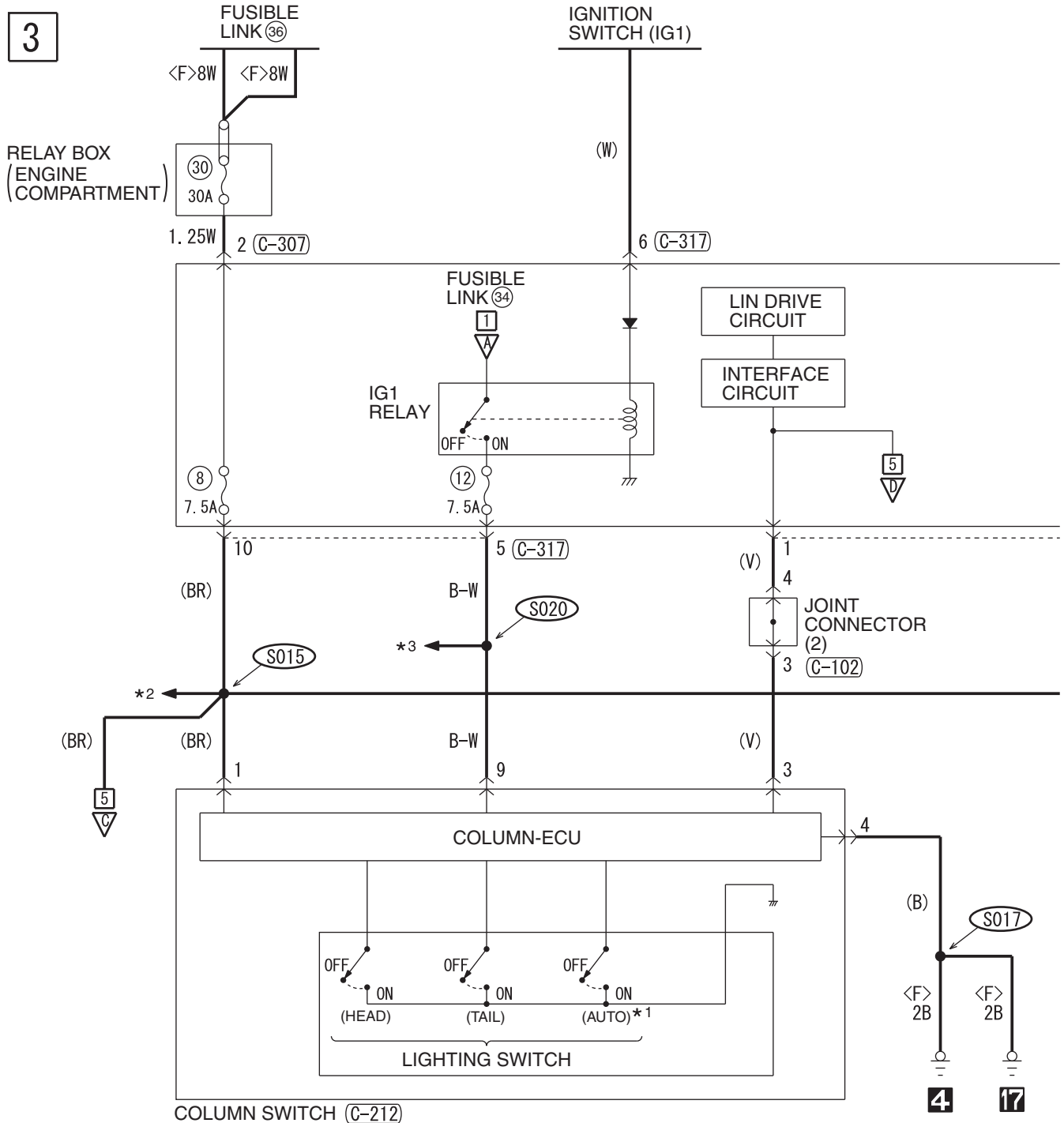

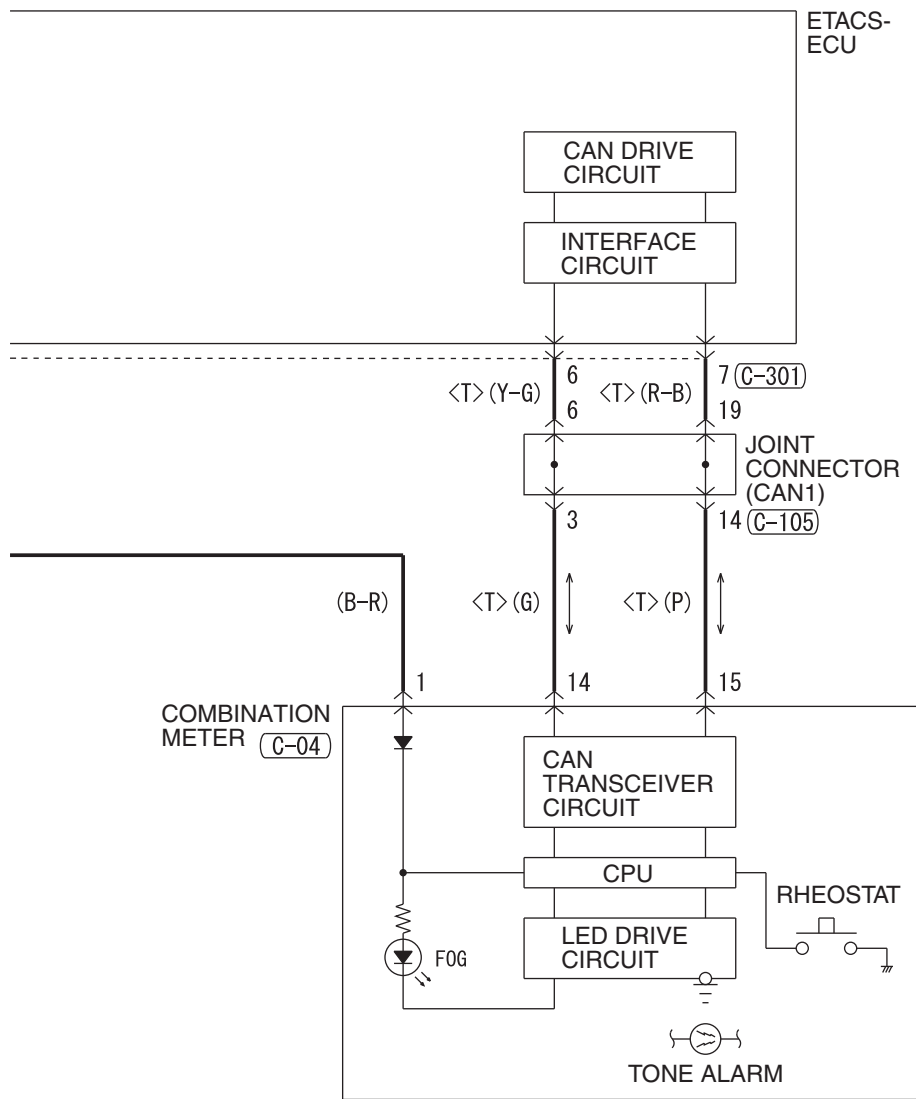

NOTE

- \*1 : VEHICLES WITH AUTOMATIC LIGHT
- \*2 : AIR CONDITIONING SYSTEM  
 .CENTRAL DOOR LOCKING SYSTEM  
 .DOME LIGHT, LUGGAGE COMPARTMENT LIGHT AND IGNITION KEY HOLE ILLUMINATION LIGHT  
 .HEATER <VEHICLES WITHOUT AIR CONDITIONING SYSTEM>  
 .IGNITION KEY REMINDER TONE ALARM  
 <VEHICLES WITH KOS>  
 .IMMOBILIZER SYSTEM  
 .KEYLESS OPERATING SYSTEM (KOS)  
 .THEFT-ALARM SYSTEM  
 .TIRE PRESSURE MONITORING SYSTEM (TPMS)  
 .TRUNK LID OPENER
- \*3 : ABS, ASC, ACD, AYC AND S-AWC  
 .AIR CONDITIONING SYSTEM  
 .BRAKE WARNING LIGHT, FUEL WARNING LIGHT AND OIL PRESSURE WARNING LIGHT  
 .CENTRAL DOOR LOCKING SYSTEM  
 .CHARGING SYSTEM  
 .COOLING SYSTEM  
 .CRUISE CONTROL SYSTEM  
 .DOME LIGHT, LUGGAGE COMPARTMENT LIGHT AND IGNITION KEY HOLE ILLUMINATION LIGHT  
 .DOOR AJAR WARNING TONE ALARM  
 .HANDS-FREE CELLULAR PHONE SYSTEM  
 .HEATED DOOR MIRROR  
 .HEATED SEAT  
 .HEATER <VEHICLES WITHOUT AIR CONDITIONING SYSTEM>  
 .IGNITION KEY REMINDER TONE ALARM <VEHICLES WITH KOS>  
 .IMMOBILIZER SYSTEM  
 .KEYLESS OPERATING SYSTEM (KOS)  
 .METER AND GAUGE  
 .MFI SYSTEM  
 .PARKING BRAKE REMINDER TONE ALARM  
 .REAR WINDOW DEFOGGER  
 .SEAT BELT WARNING TONE ALARM  
 .SHIFT LOCK MECHANISM  
 .SUNROOF  
 .SUPPLEMENTAL RESTRAINT SYSTEM (SRS)  
 .THEFT-ALARM SYSTEM  
 .TIRE PRESSURE MONITORING SYSTEM (TPMS)  
 .TRUNK LID OPENER  
 .TWIN CLUTCH-SPORTRONIC SHIFT TRANSMISSION (TC-SST)

(C-317)

1	2	3	4	5	6	7	
8	9	10	11	12	13	14	15

WIRE COLOR CODE

B : BLACK LG : LIGHT GREEN G : GREEN L : BLUE W : WHITE Y : YELLOW SB : SKY BLUE  
 BR : BROWN O : ORANGE GR : GRAY R : RED P : PINK V : VIOLET PU : PURPLE SI : SILVER

TAILLIGHT, POSITION LIGHT, LICENSE PLATE LIGHT AND LIGHTING MONITOR TONE ALARM (CONTINUED)

5

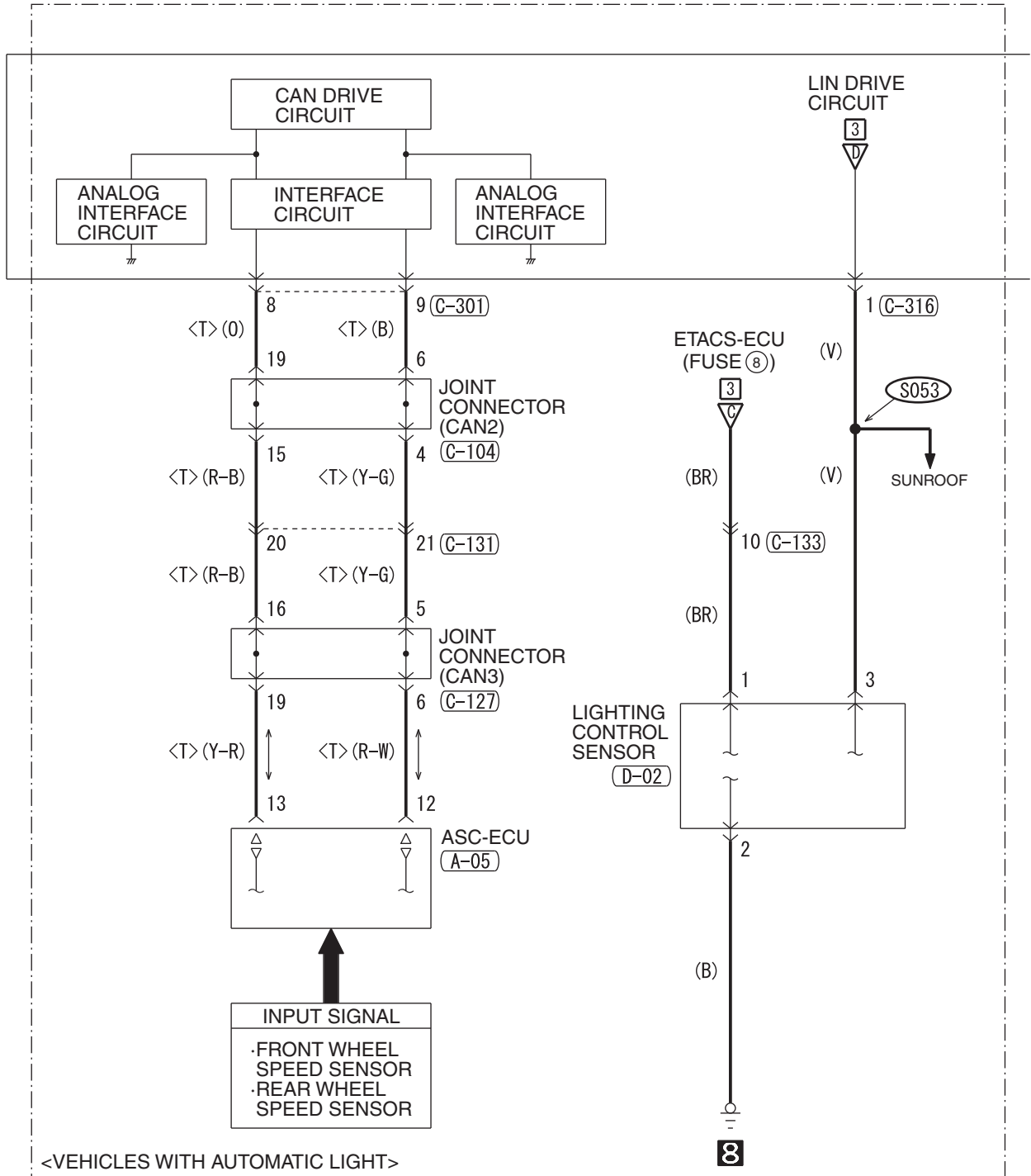

(A-05)

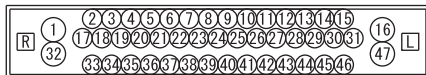

(C-40) FRONT SIDE (C-104)

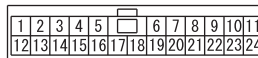
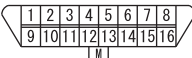

(C-127)

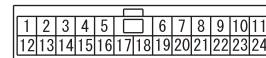

(D-02)



(D-28)





6

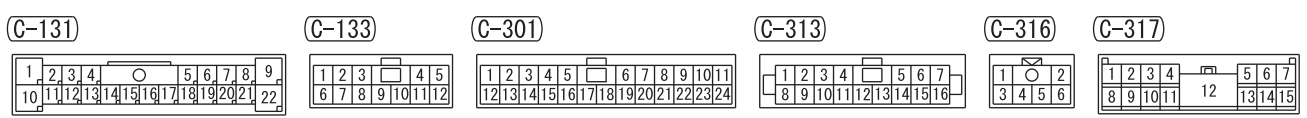
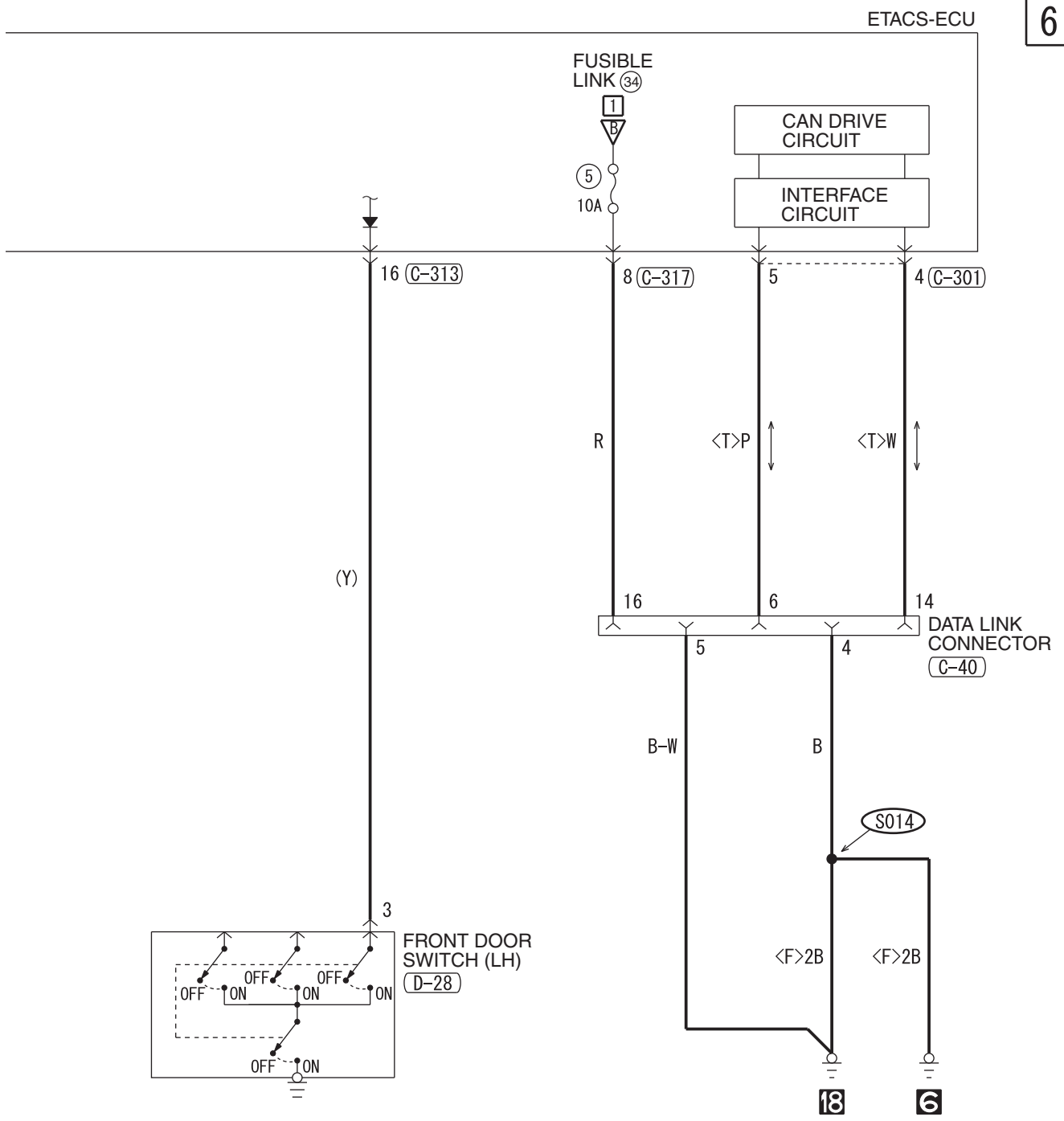

WIRE COLOR CODE  
 B: BLACK LG: LIGHT GREEN G: GREEN L: BLUE W: WHITE Y: YELLOW SB: SKY BLUE  
 BR: BROWN O: ORANGE GR: GRAY R: RED P: PINK V: VIOLET PU: PURPLE SI: SILVER

HAH08M16CB

TSB Revision

# DOME LIGHT, LUGGAGE COMPARTMENT LIGHT AND IGNITION KEY HOLE ILLUMINATION LIGHT

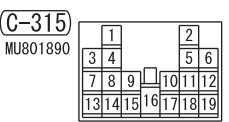
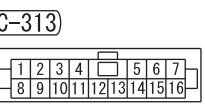
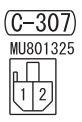
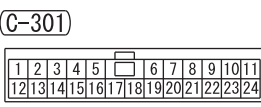
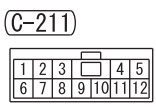
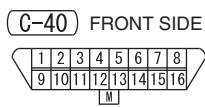
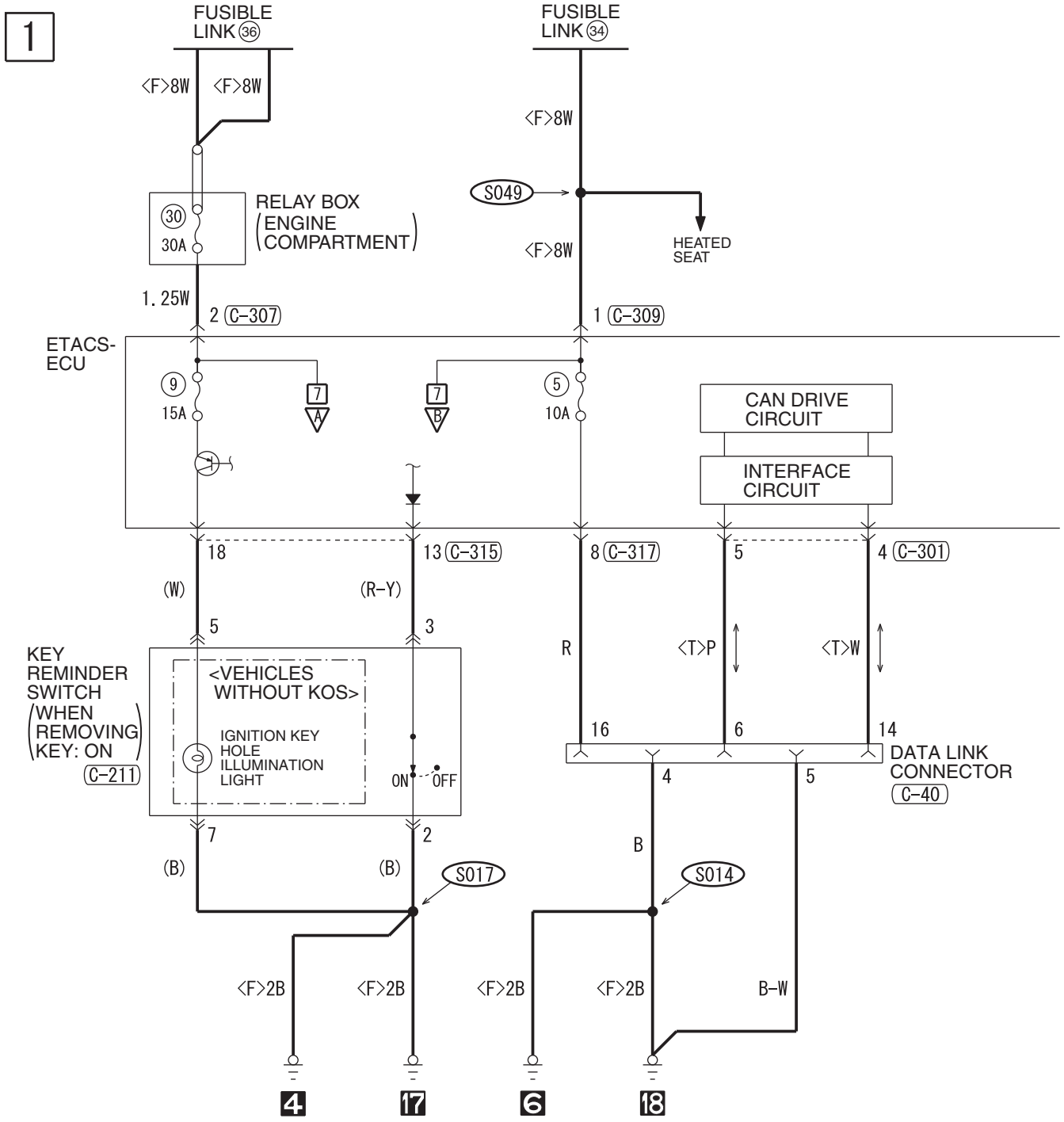

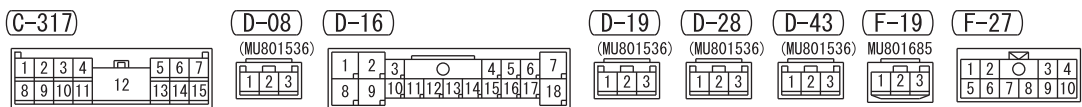
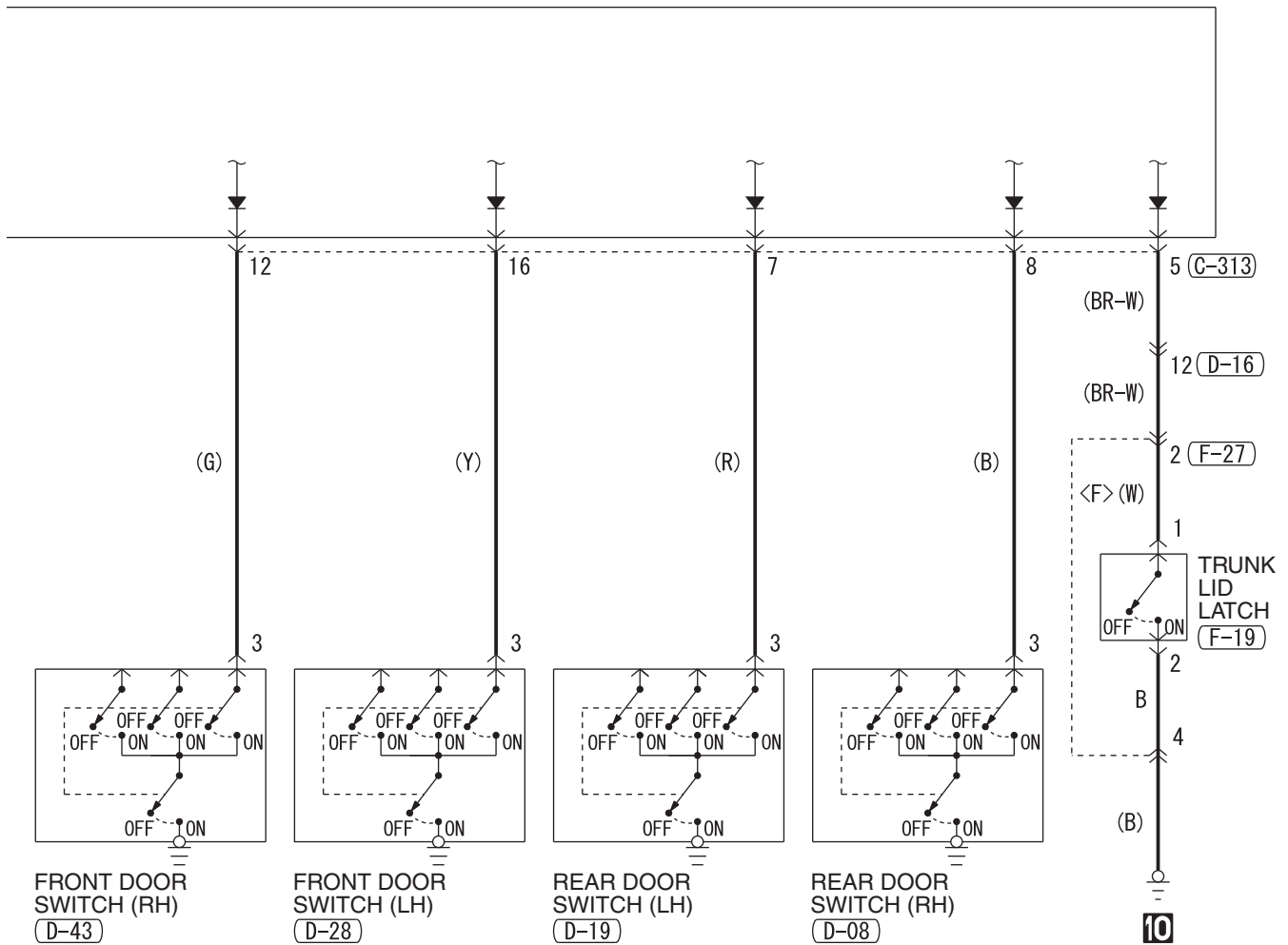

WIRE COLOR CODE  
 B: BLACK LG: LIGHT GREEN G: GREEN L: BLUE W: WHITE Y: YELLOW SB: SKY BLUE  
 BR: BROWN O: ORANGE GR: GRAY R: RED P: PINK V: VIOLET PU: PURPLE SI: SILVER

HAH08M17AB

DOME LIGHT, LUGGAGE COMPARTMENT LIGHT AND IGNITION KEY HOLE ILLUMINATION LIGHT (CONTINUED)

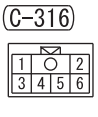
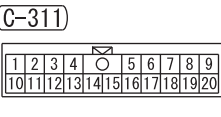
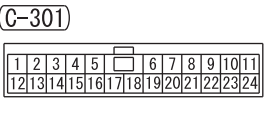
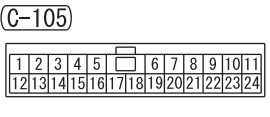
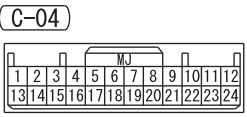
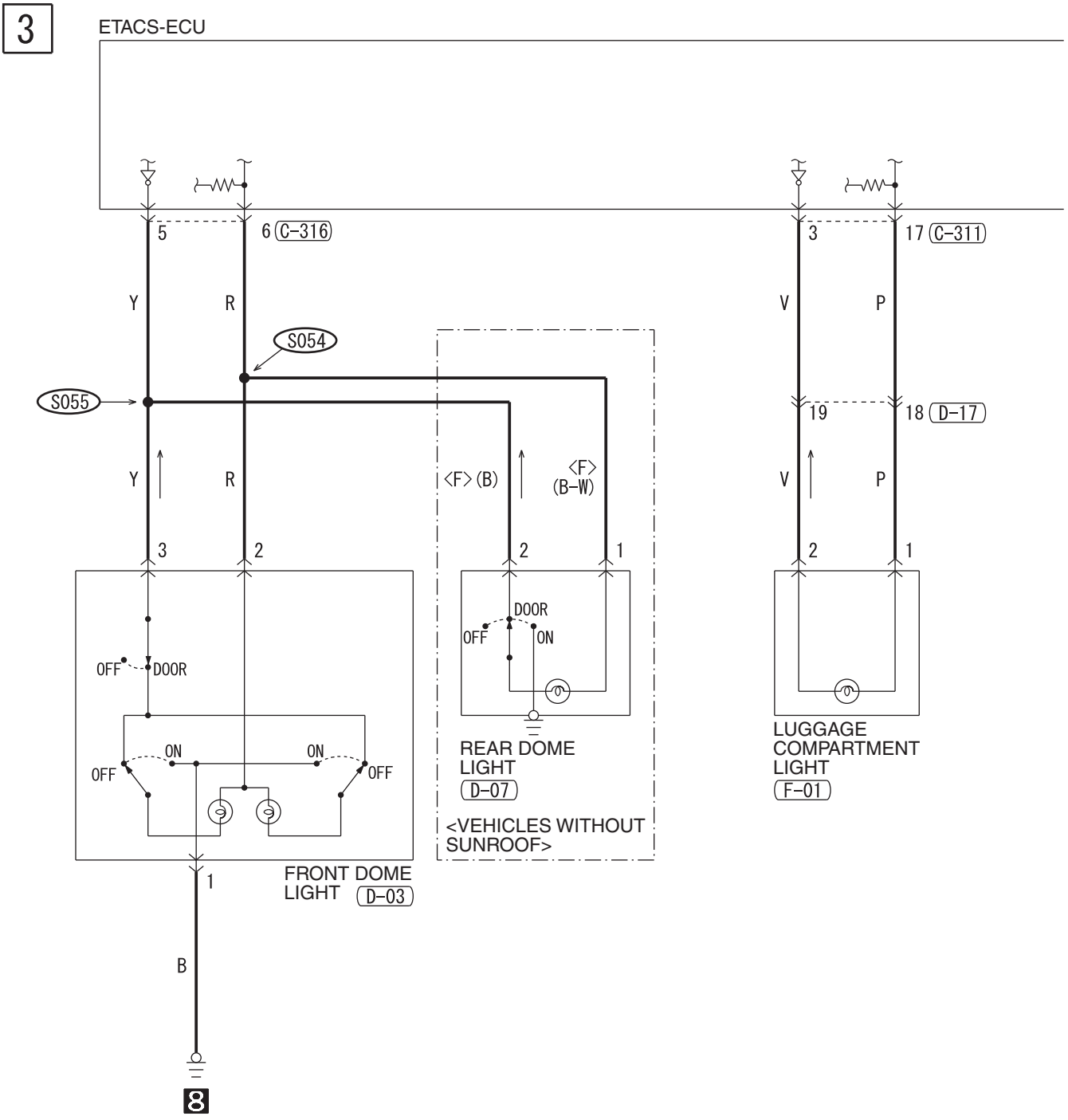

4

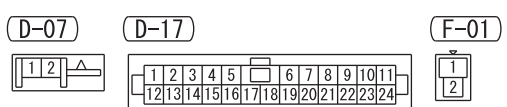
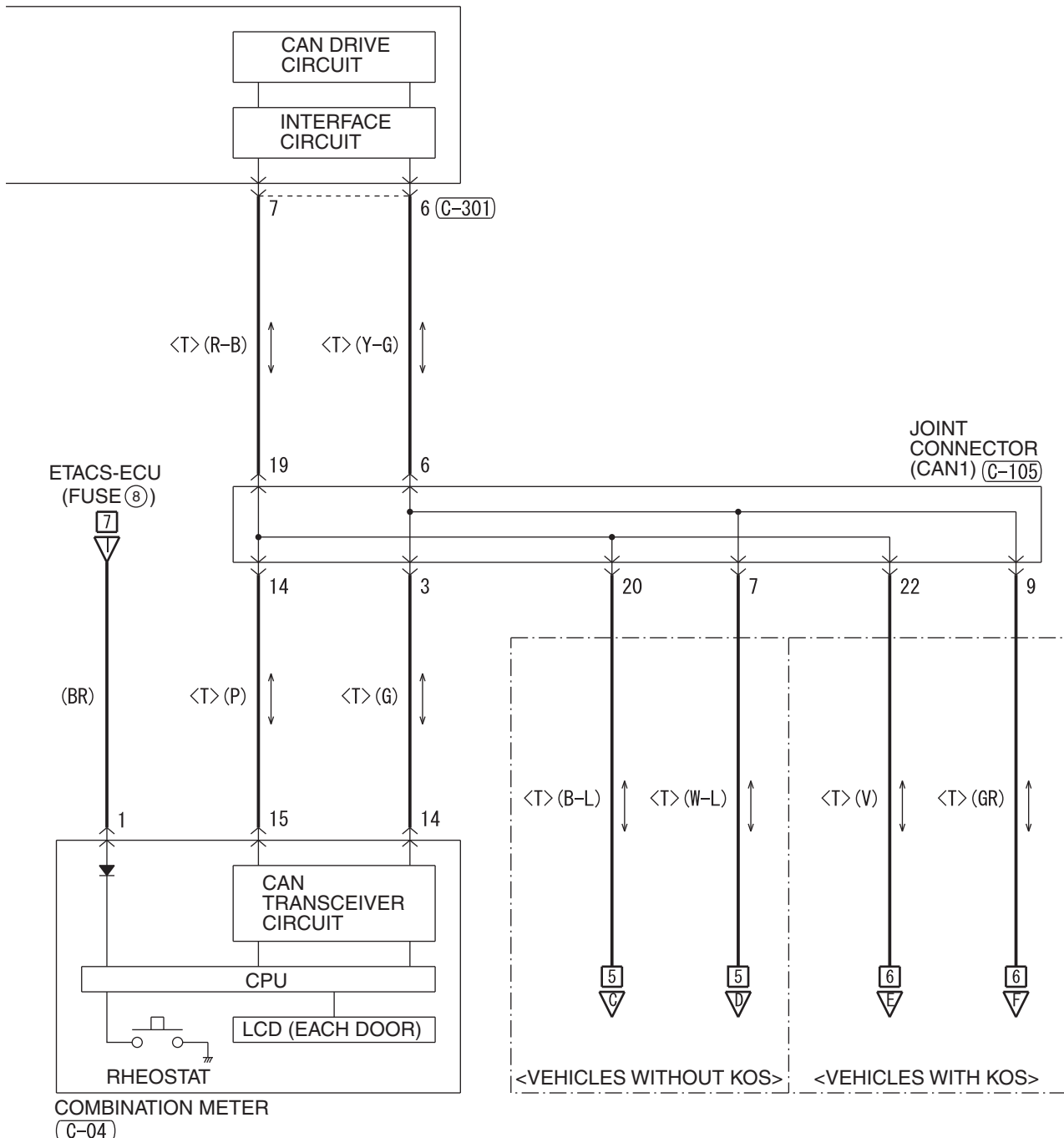

WIRE COLOR CODE  
 B: BLACK LG: LIGHT GREEN G: GREEN L: BLUE W: WHITE Y: YELLOW SB: SKY BLUE  
 BR: BROWN O: ORANGE GR: GRAY R: RED P: PINK V: VIOLET PU: PURPLE SI: SILVER

HAH08M17BB

TSB Revision

DOME LIGHT, LUGGAGE COMPARTMENT LIGHT AND IGNITION KEY HOLE ILLUMINATION LIGHT (CONTINUED)

5

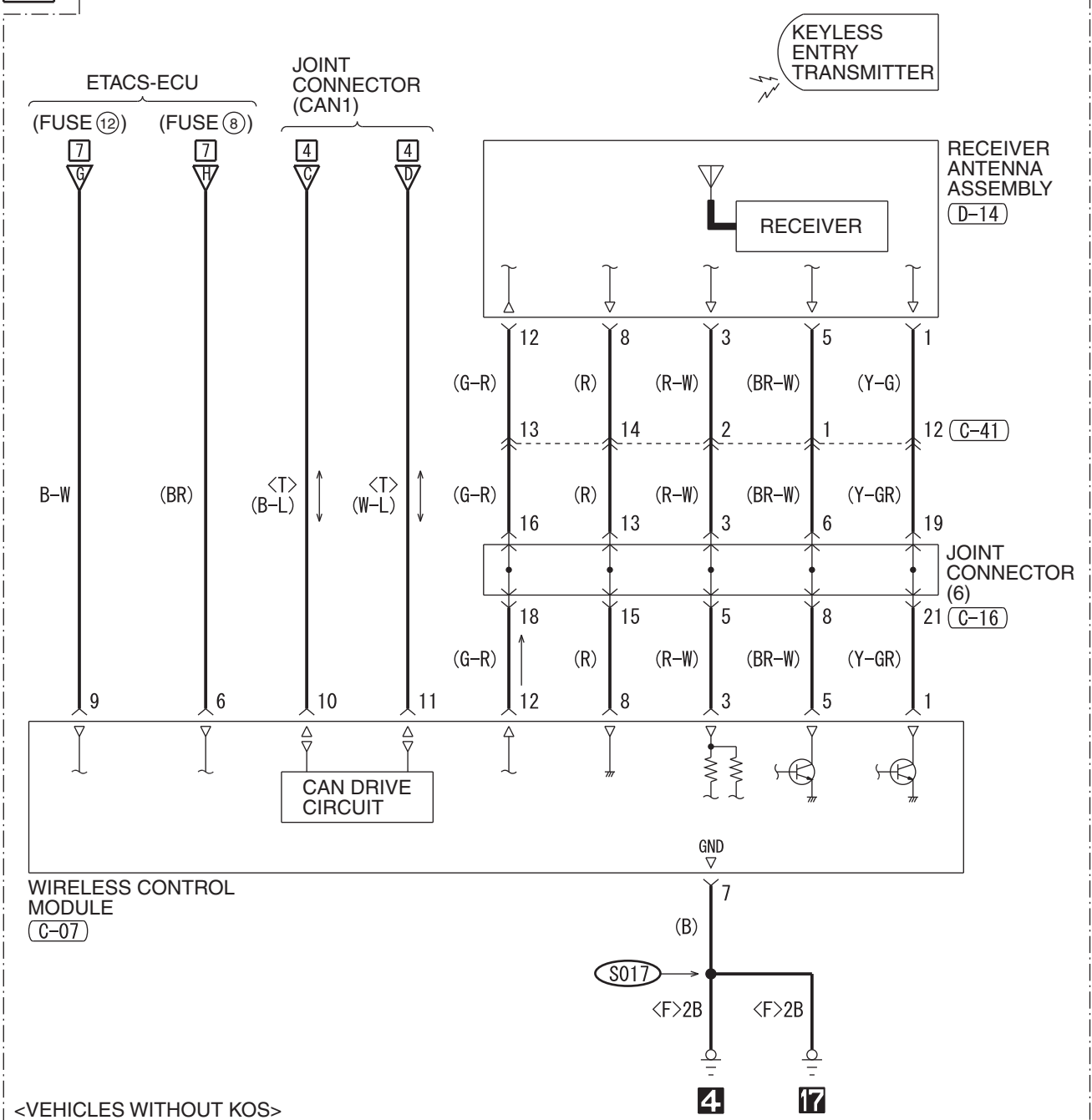

(C-05)

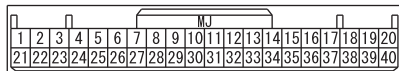

(C-07)

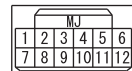

(C-16)

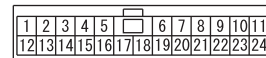

(C-41)

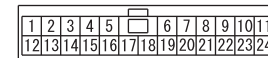

(D-14)

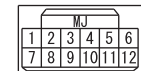

6

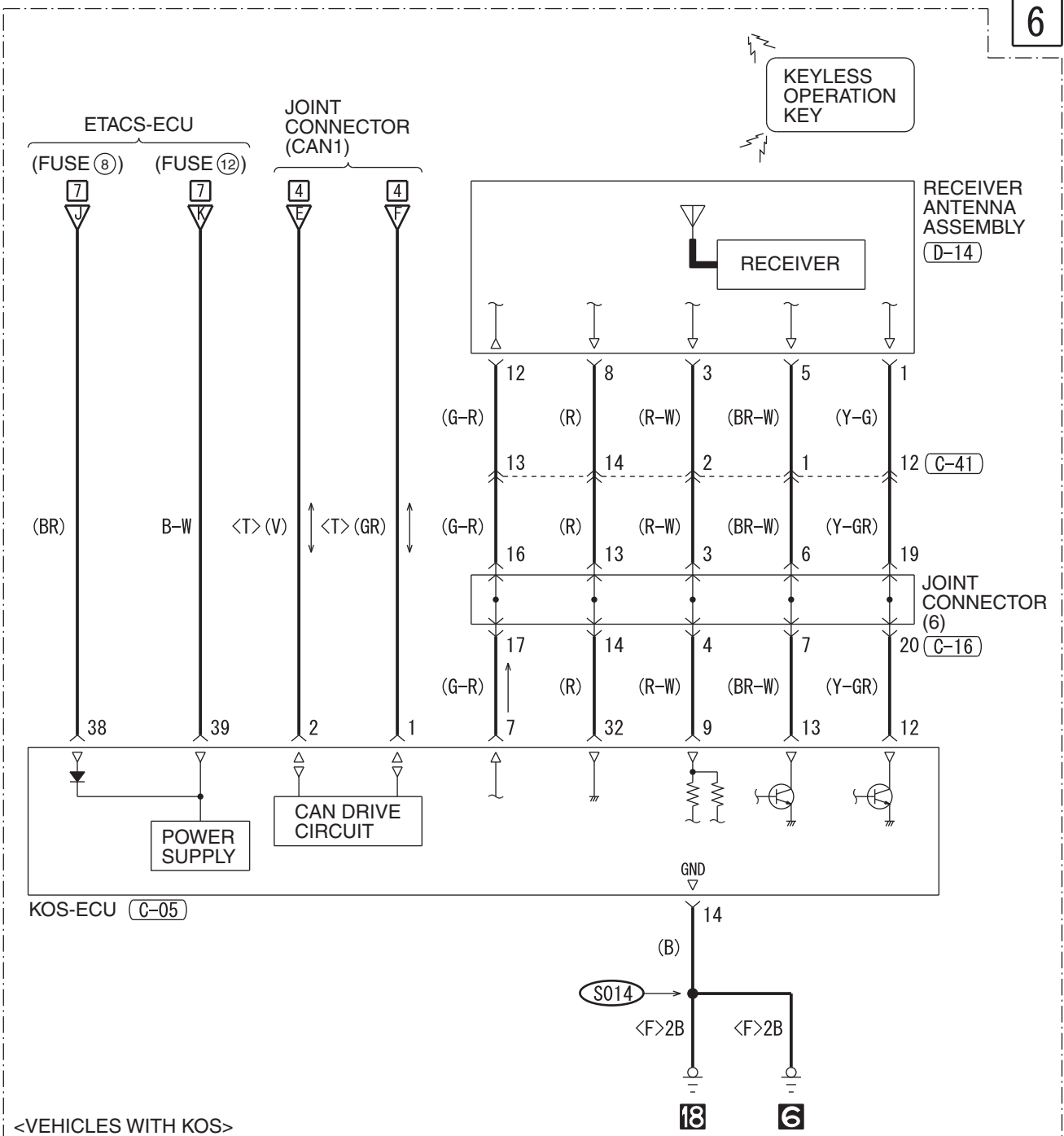

WIRE COLOR CODE  
 B: BLACK LG: LIGHT GREEN G: GREEN L: BLUE W: WHITE Y: YELLOW SB: SKY BLUE  
 BR: BROWN O: ORANGE GR: GRAY R: RED P: PINK V: VIOLET PU: PURPLE SI: SILVER

HAH08M17CB

TSB Revision

DOME LIGHT, LUGGAGE COMPARTMENT LIGHT AND IGNITION KEY HOLE ILLUMINATION LIGHT (CONTINUED)

7

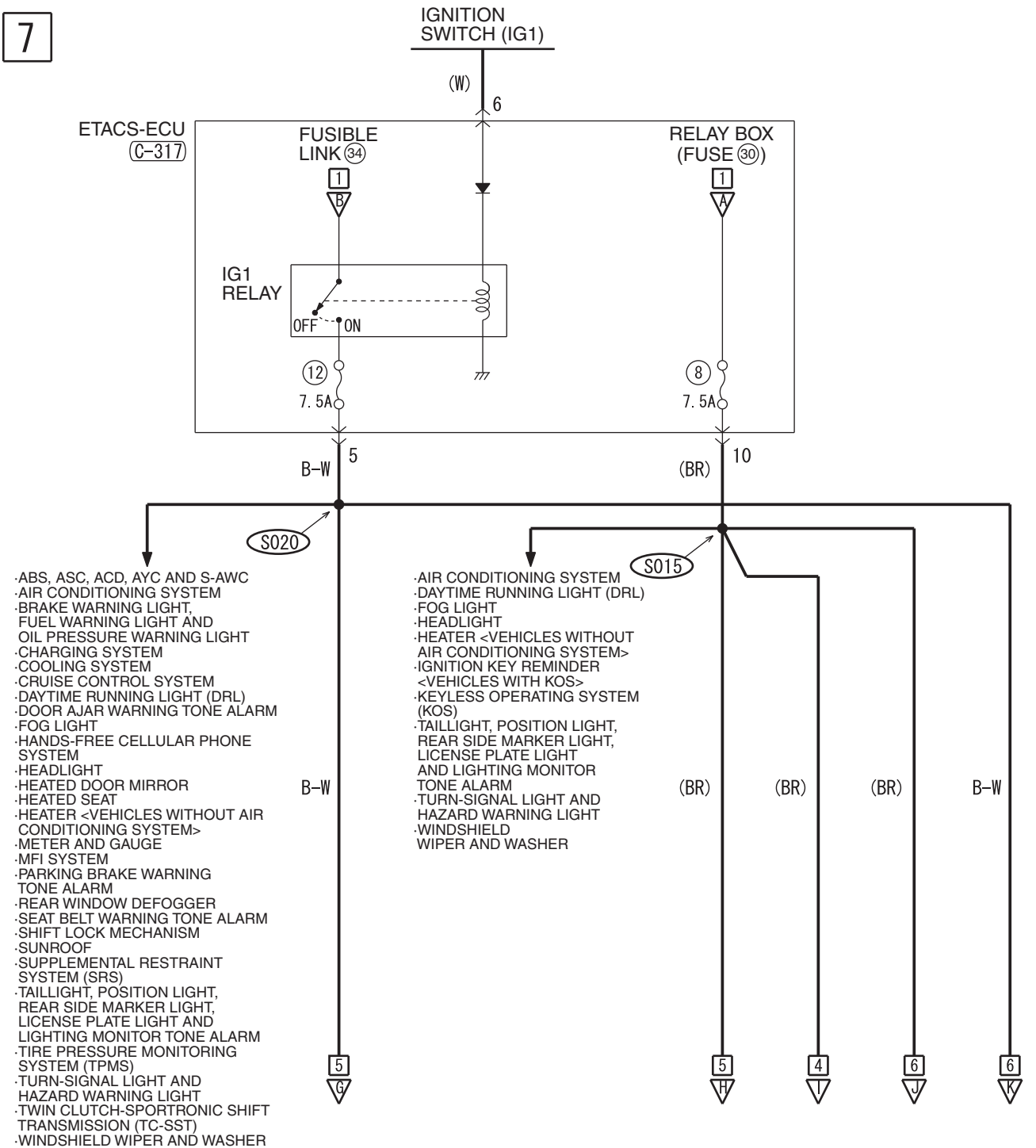

(C-317)

1	2	3	4	5	6	7	
8	9	10	11	12	13	14	15

WIRE COLOR CODE

B: BLACK LG: LIGHT GREEN G: GREEN L: BLUE W: WHITE Y: YELLOW SB: SKY BLUE  
BR: BROWN O: ORANGE GR: GRAY R: RED P: PINK V: VIOLET PU: PURPLE SI: SILVER



NOTES

# TURN-SIGNAL LIGHT AND HAZARD WARNING LIGHT

M1901002904021

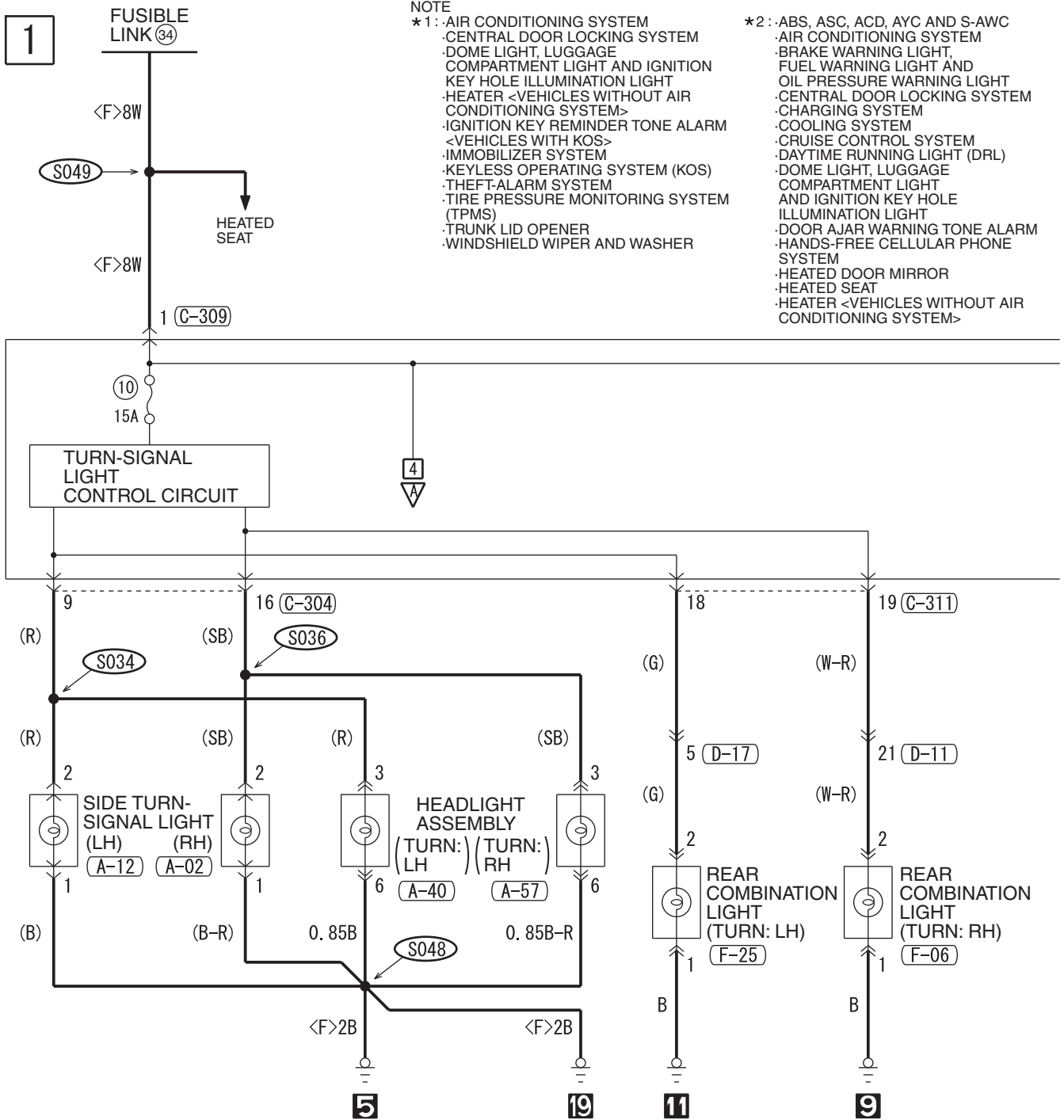

NOTE

- \*1: -AIR CONDITIONING SYSTEM  
 -CENTRAL DOOR LOCKING SYSTEM  
 -DOME LIGHT, LUGGAGE COMPARTMENT LIGHT AND IGNITION KEY HOLE ILLUMINATION LIGHT  
 -HEATER <VEHICLES WITHOUT AIR CONDITIONING SYSTEM>  
 -IGNITION KEY REMINDER TONE ALARM <VEHICLES WITH KOS>  
 -IMMOBILIZER SYSTEM  
 -KEYLESS OPERATING SYSTEM (KOS)  
 -THEFT-ALARM SYSTEM  
 -TIRE PRESSURE MONITORING SYSTEM (TPMS)  
 -TRUNK LID OPENER  
 -WINDSHIELD WIPER AND WASHER

- \*2: -ABS, ASC, ACD, AYC AND S-AWC  
 -AIR CONDITIONING SYSTEM  
 -BRAKE WARNING LIGHT, FUEL WARNING LIGHT AND OIL PRESSURE WARNING LIGHT  
 -CENTRAL DOOR LOCKING SYSTEM  
 -CHARGING SYSTEM  
 -COOLING SYSTEM  
 -CRUISE CONTROL SYSTEM  
 -DAYTIME RUNNING LIGHT (DRL)  
 -DOME LIGHT, LUGGAGE COMPARTMENT LIGHT AND IGNITION KEY HOLE ILLUMINATION LIGHT  
 -DOOR AJAR WARNING TONE ALARM  
 -HANDS-FREE CELLULAR PHONE SYSTEM  
 -HEATED DOOR MIRROR  
 -HEATED SEAT  
 -HEATER <VEHICLES WITHOUT AIR CONDITIONING SYSTEM>

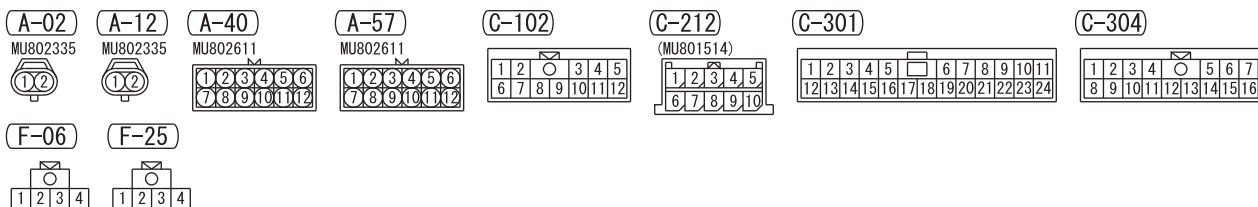

HAH09M04AA

2

- IGNITION KEY REMINDER TONE ALARM <VEHICLES WITH KOS>
- IMMOBILIZER SYSTEM
- KEYLESS OPERATING SYSTEM (KOS)
- METER AND GAUGE
- MFI SYSTEM
- PARKING BRAKE REMINDER TONE ALARM
- REAR WINDOW DEFOGGER
- SEAT BELT WARNING TONE ALARM
- SHIFT LOCK MECHANISM
- SUNROOF
- SUPPLEMENTAL RESTRAINT SYSTEM (SRS)
- THEFT-ALARM SYSTEM
- TIRE PRESSURE MONITORING SYSTEM (TPMS)
- TRUNK LID OPENER
- TWIN CLUTCH-SPORTRONIC SHIFT TRANSMISSION (TC-SST)

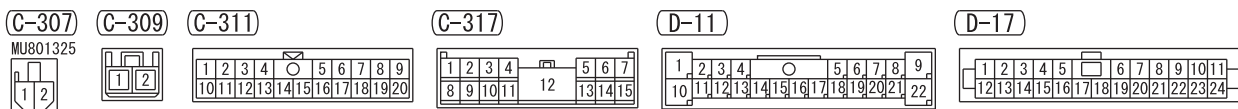
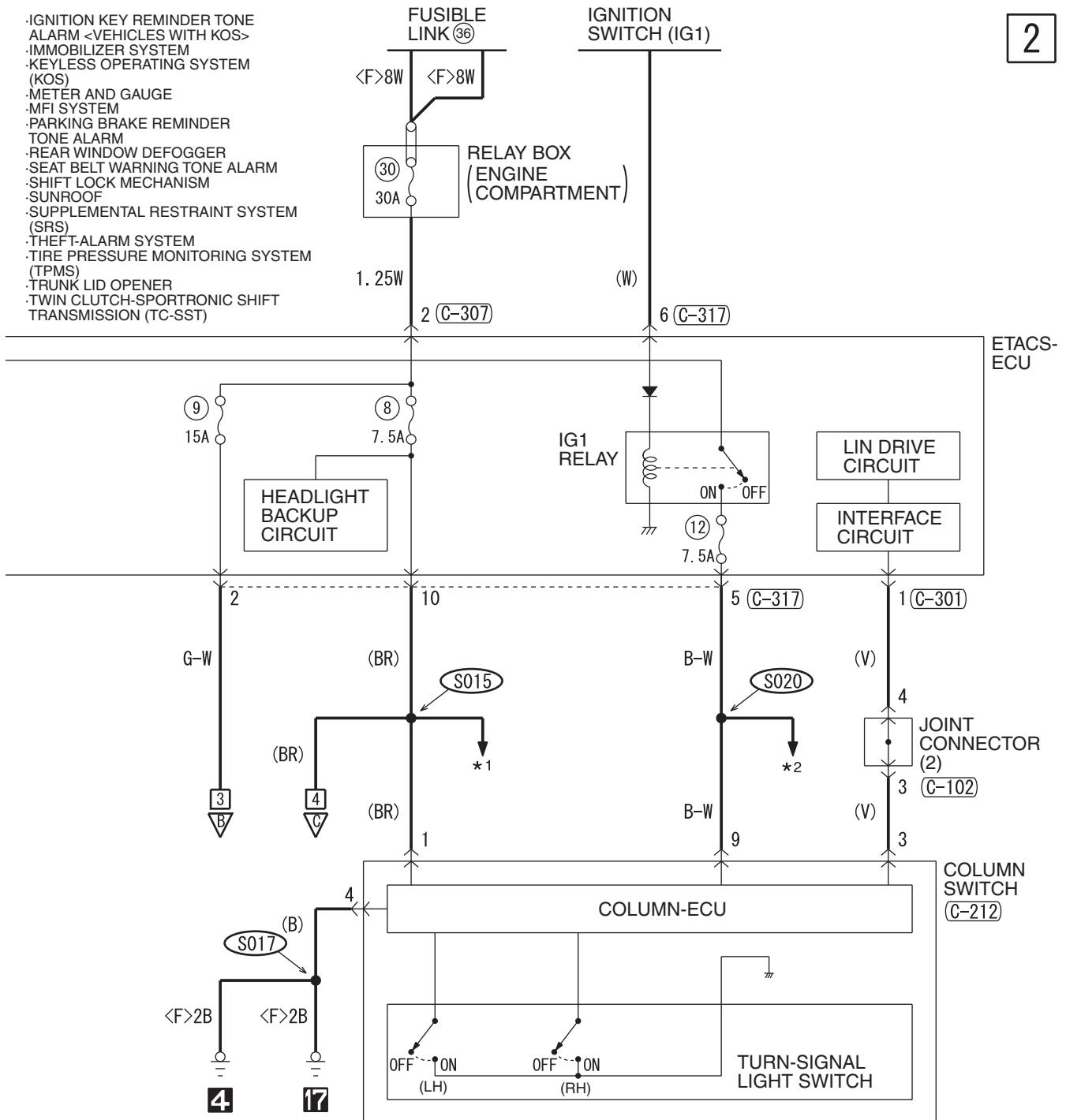

WIRE COLOR CODE  
 B: BLACK LG: LIGHT GREEN G: GREEN L: BLUE W: WHITE Y: YELLOW SB: SKY BLUE  
 BR: BROWN O: ORANGE GR: GRAY R: RED P: PINK V: VIOLET PU: PURPLE SI: SILVER

HAH09M04AB

TURN-SIGNAL LIGHT AND HAZARD WARNING LIGHT (CONTINUED)

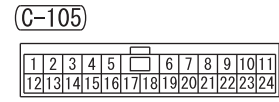
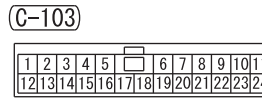
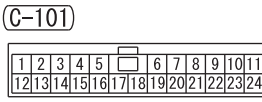
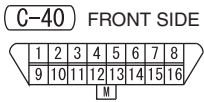
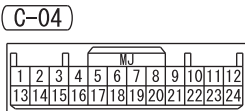
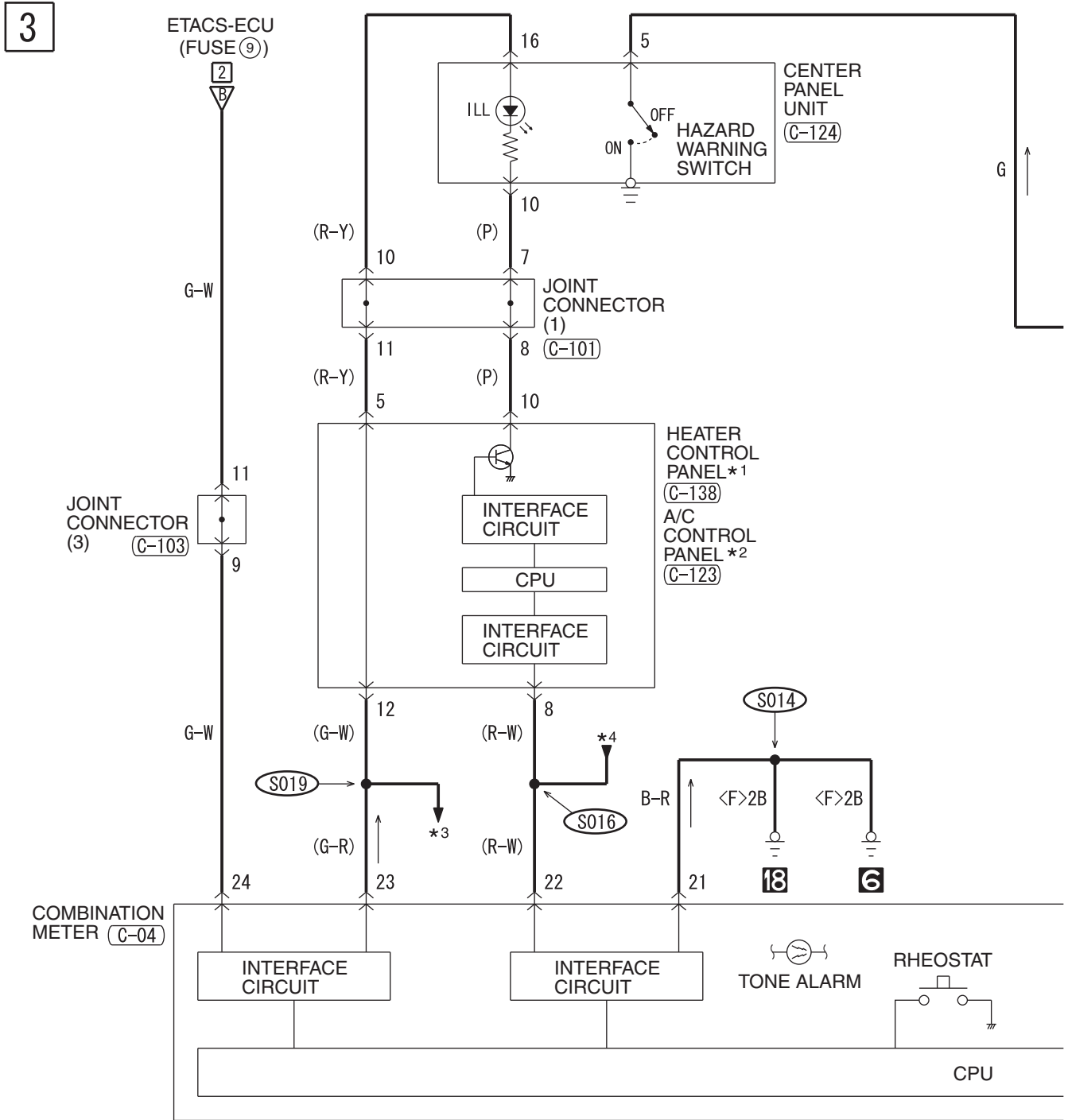

4

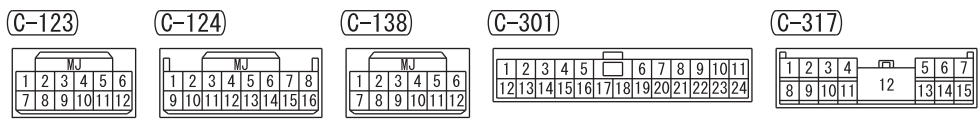
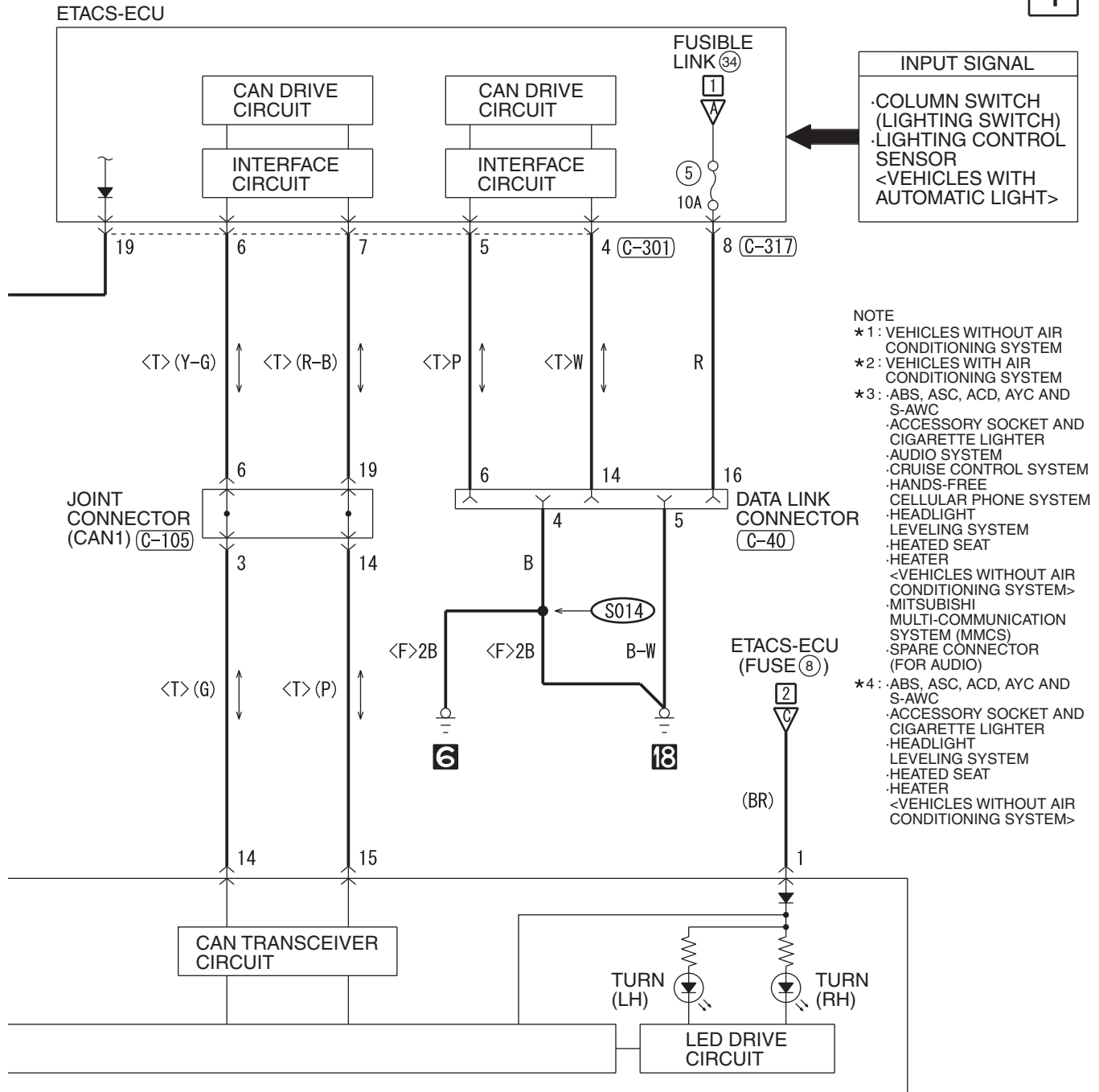

WIRE COLOR CODE  
 B: BLACK LG: LIGHT GREEN G: GREEN L: BLUE W: WHITE Y: YELLOW SB: SKY BLUE  
 BR: BROWN O: ORANGE GR: GRAY R: RED P: PINK V: VIOLET PU: PURPLE SI: SILVER

HAH09M04BB

BACKUP LIGHT <M/T>

M1901003104749

1

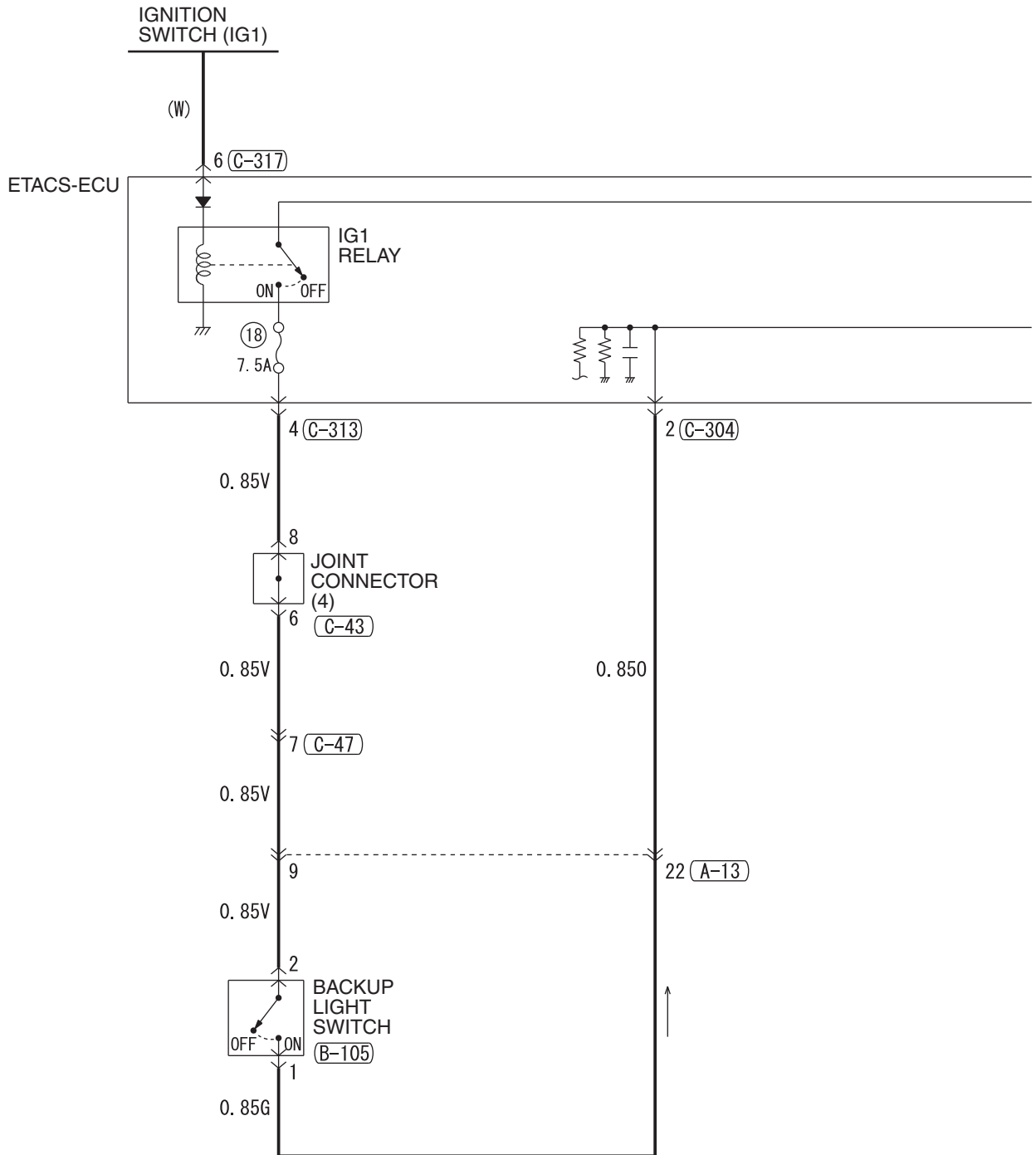

(A-13)

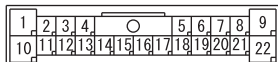

(B-105)



(C-40) FRONT SIDE



(C-43)

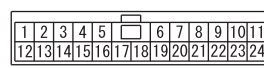

(C-47)

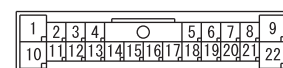

(D-17)

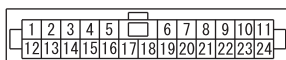

(F-08)



(F-22)



(F-27)

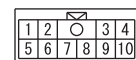

HAH09M06AA

TSB Revision

2

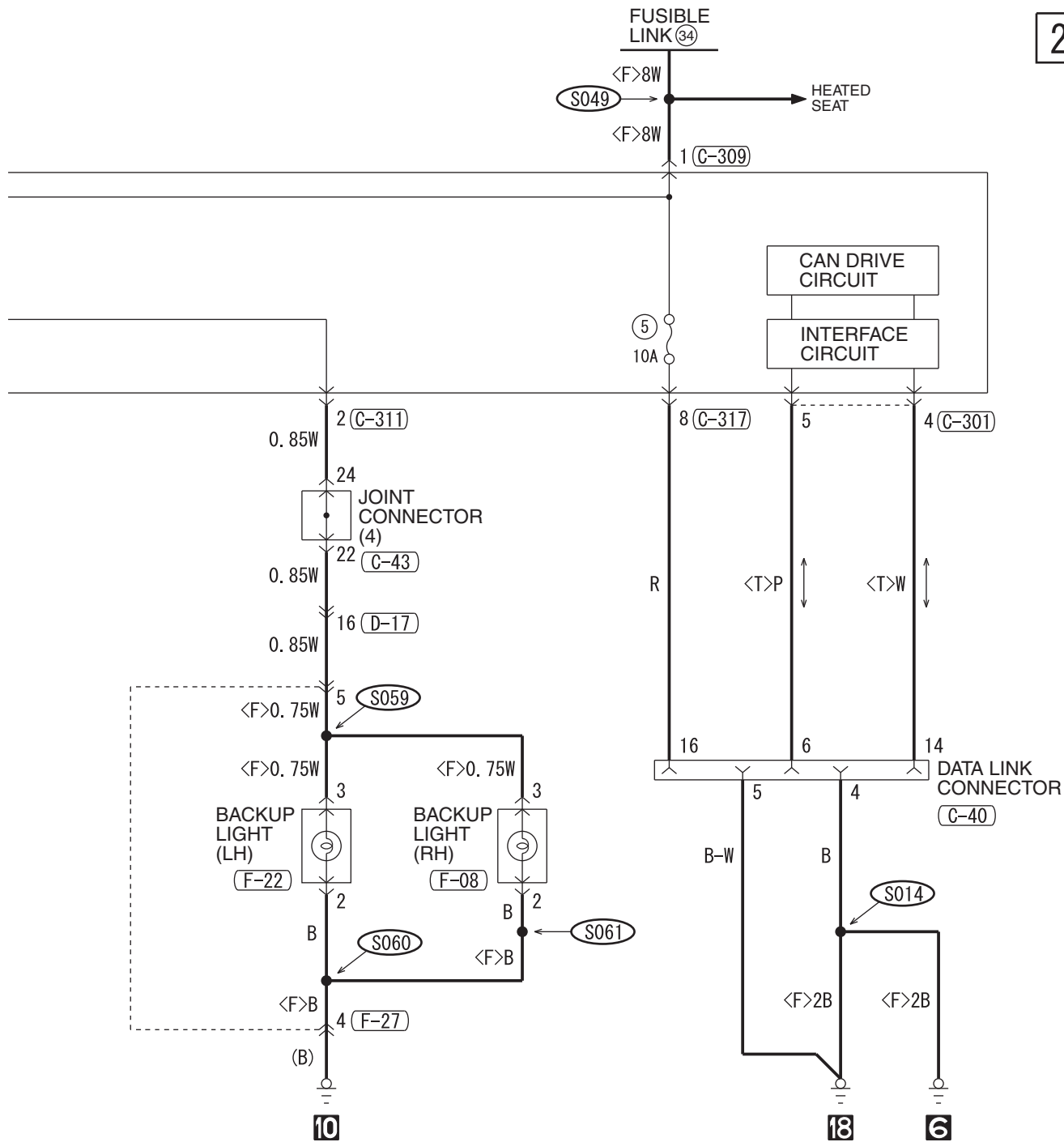

(C-301)

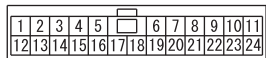

(C-304)

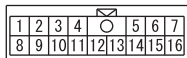

(C-309)



(C-311)

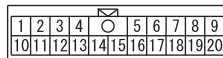

(C-313)

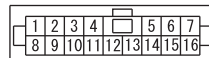

(C-317)

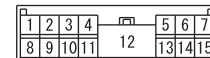

WIRE COLOR CODE

B: BLACK LG: LIGHT GREEN G: GREEN L: BLUE W: WHITE Y: YELLOW SB: SKY BLUE  
 BR: BROWN O: ORANGE GR: GRAY R: RED P: PINK V: VIOLET PU: PURPLE SI: SILVER

TSB Revision

BACKUP LIGHT <TC-SST>

M1901003104750

1

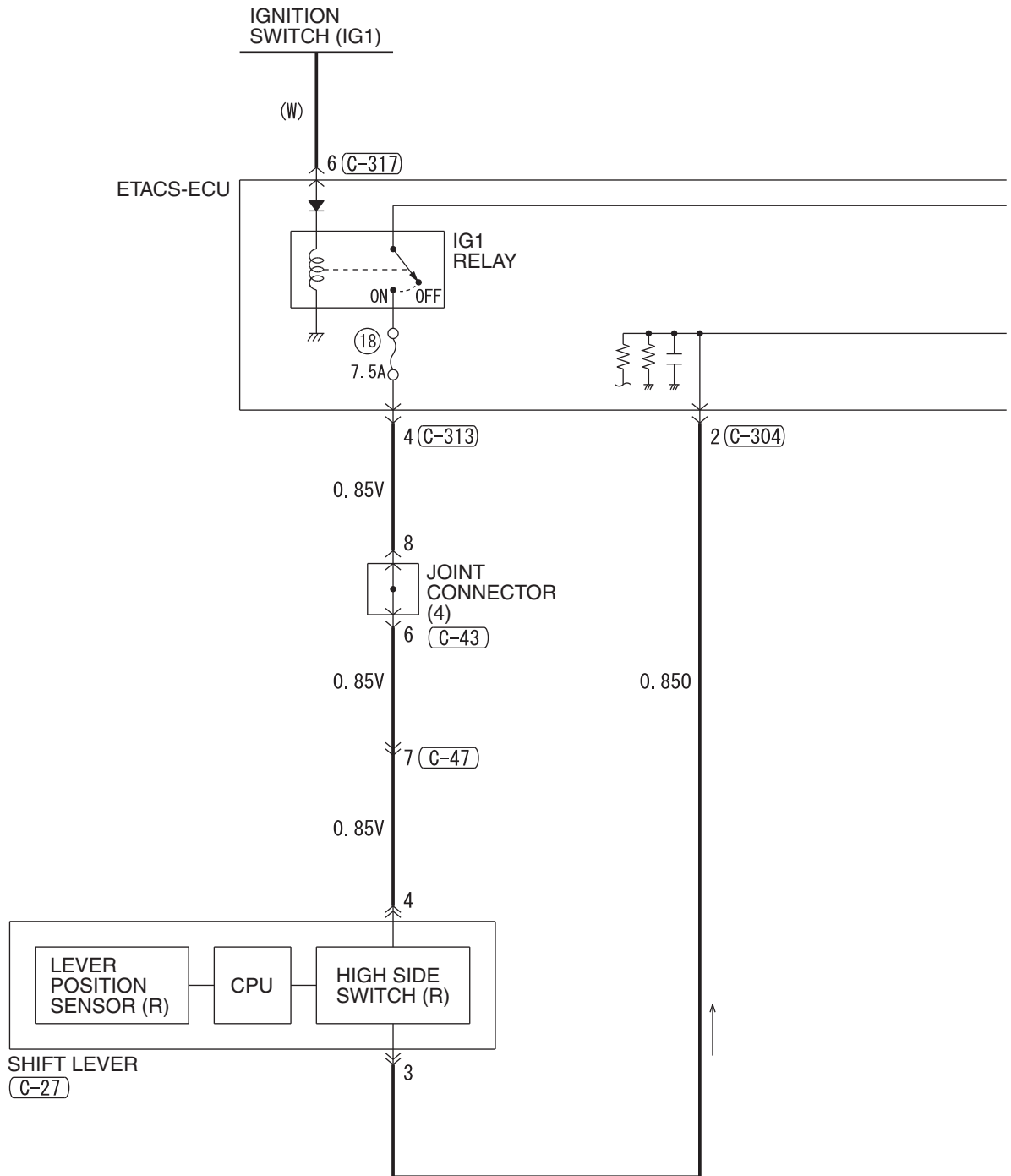

(C-27)

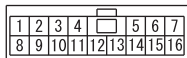

(C-40) FRONT SIDE

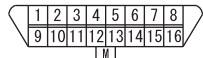

(C-43)

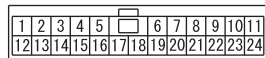

(C-47)

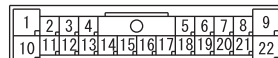

(C-301)

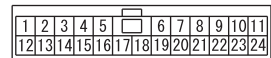

(F-08)



(F-22)



(F-27)

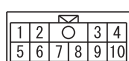

HAH09M07AA



2

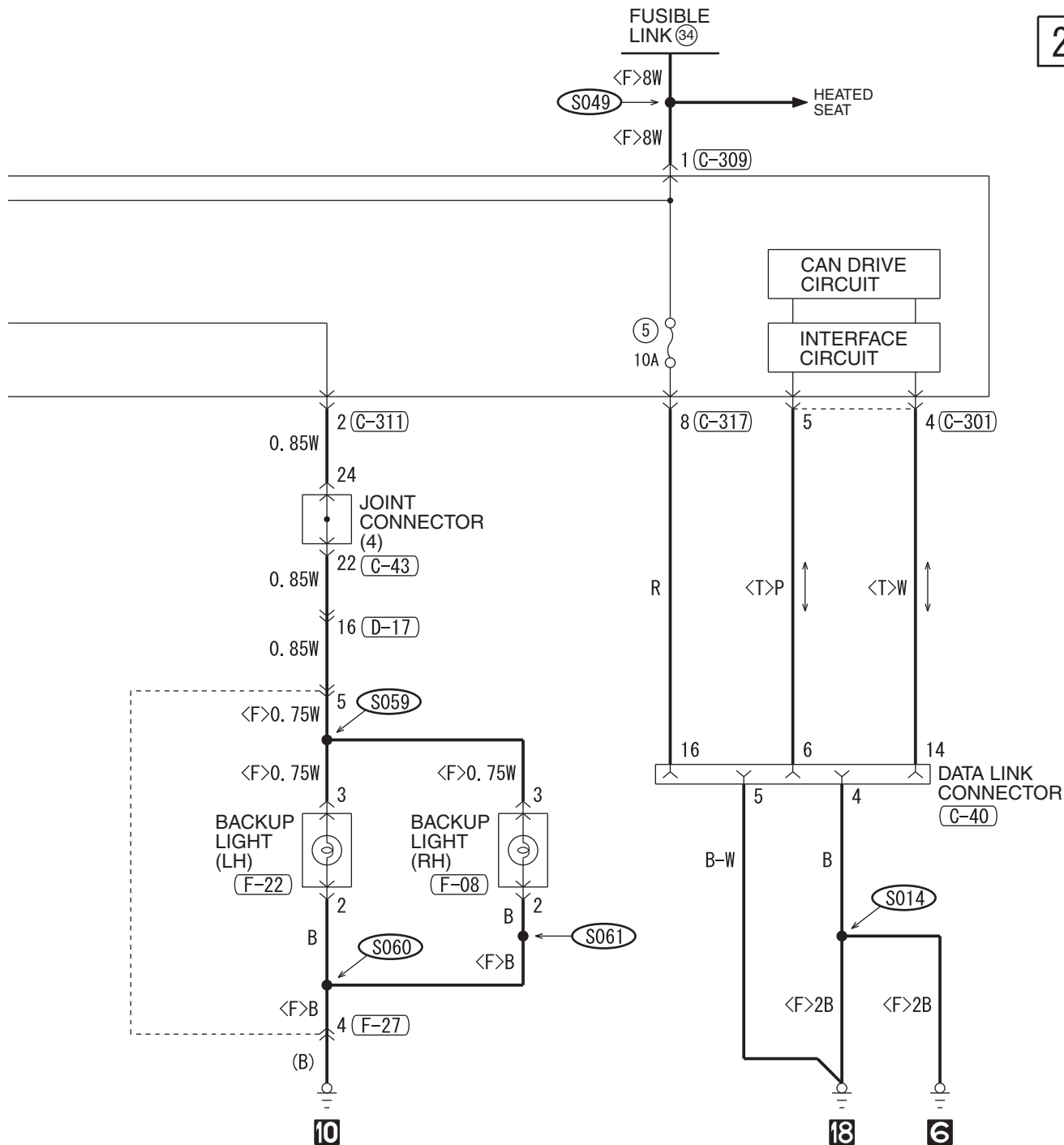

(C-304)

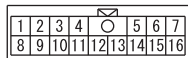

(C-309)



(C-311)

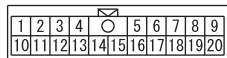

(C-313)

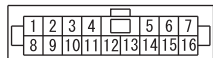

(C-317)

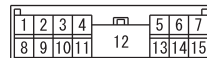

(D-17)

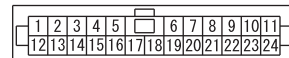

WIRE COLOR CODE

B : BLACK LG : LIGHT GREEN G : GREEN L : BLUE W : WHITE Y : YELLOW SB : SKY BLUE  
 BR : BROWN O : ORANGE GR : GRAY R : RED P : PINK V : VIOLET PU : PURPLE SI : SILVER

HAH09M07AB

# STOPLIGHT

1

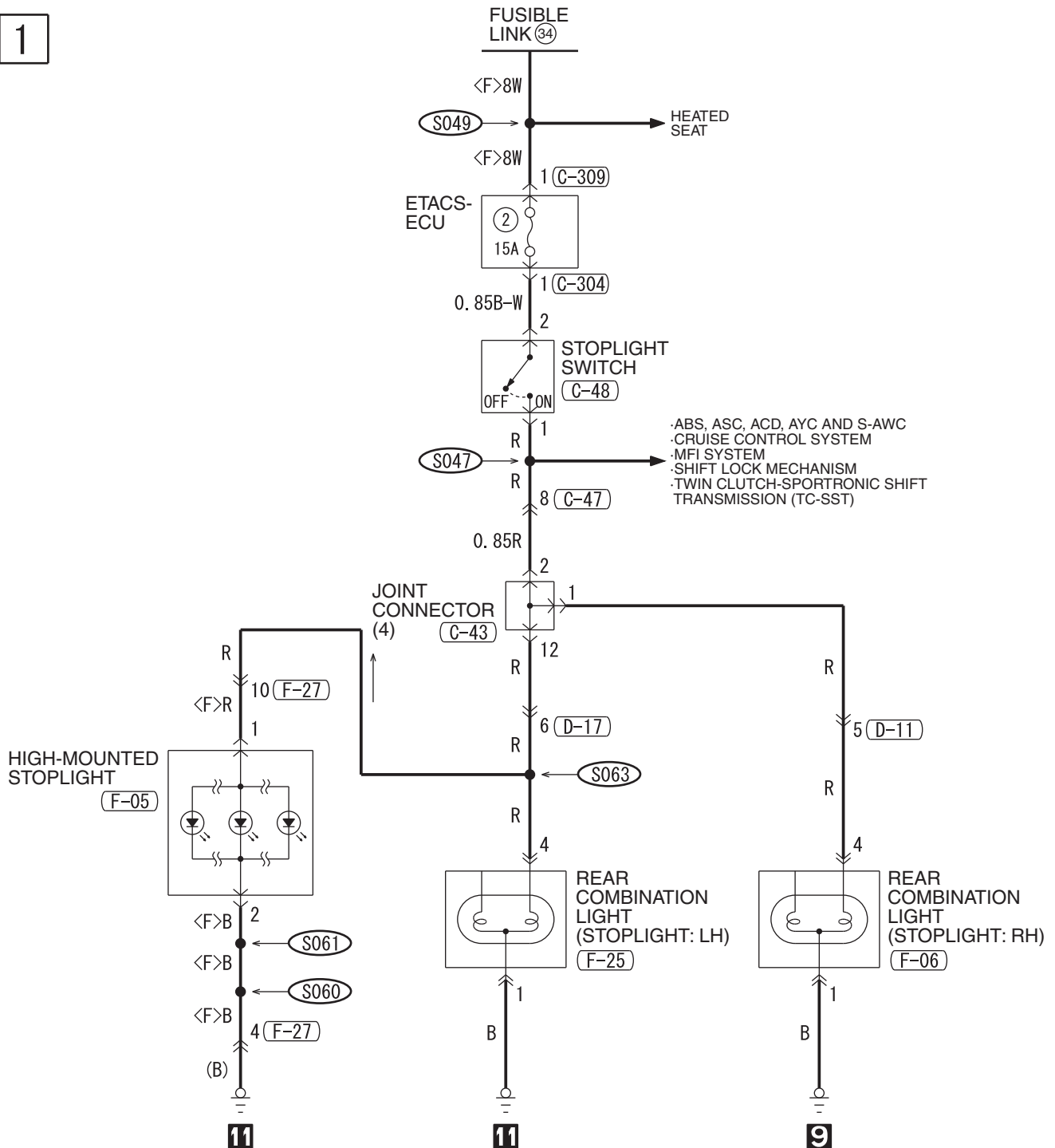

C-43

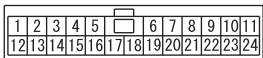

C-47

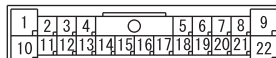

C-48



C-304

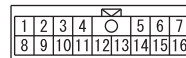

C-309



D-11

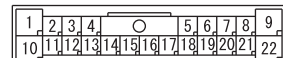

D-17

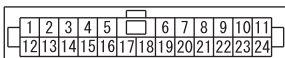

F-05



F-06



F-25



F-27

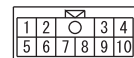

HORN

1

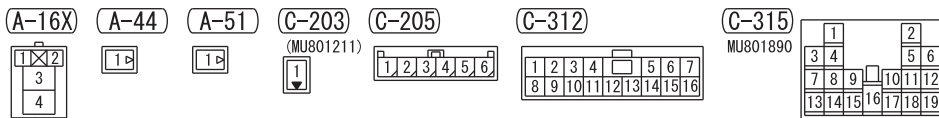
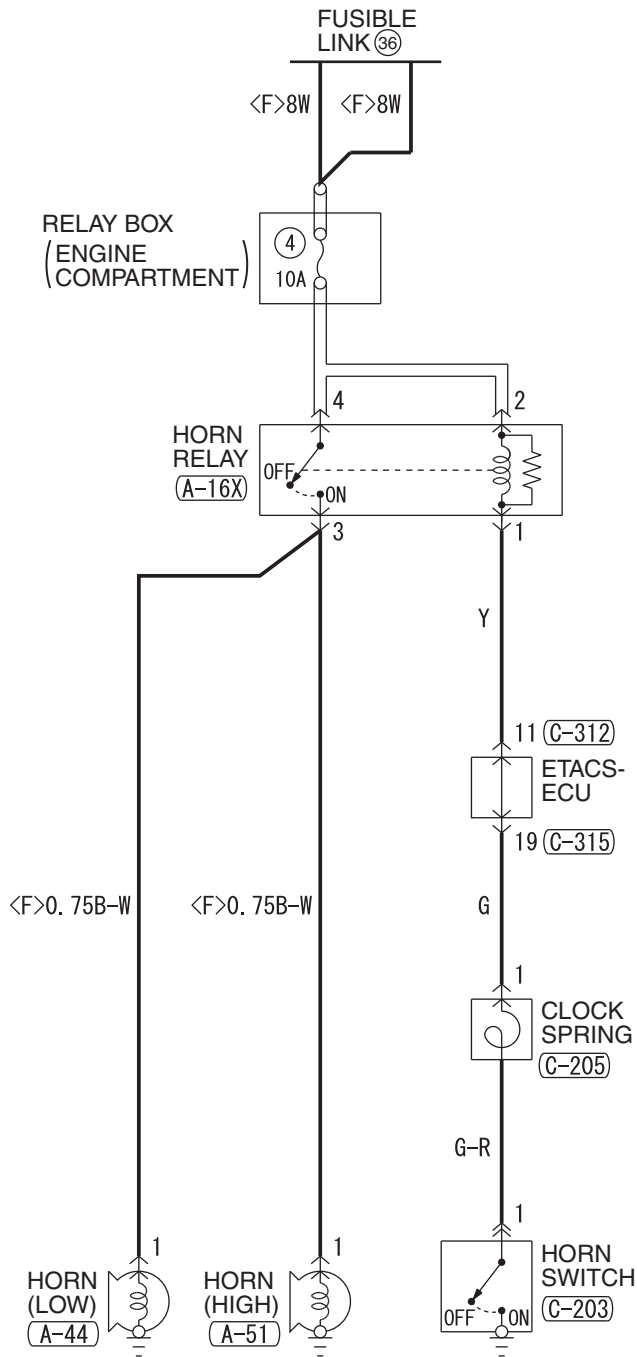

WIRE COLOR CODE  
 B: BLACK LG: LIGHT GREEN G: GREEN L: BLUE W: WHITE Y: YELLOW SB: SKY BLUE  
 BR: BROWN O: ORANGE GR: GRAY R: RED P: PINK V: VIOLET PU: PURPLE SI: SILVER

METER AND GAUGE <M/T>

M1901003505988

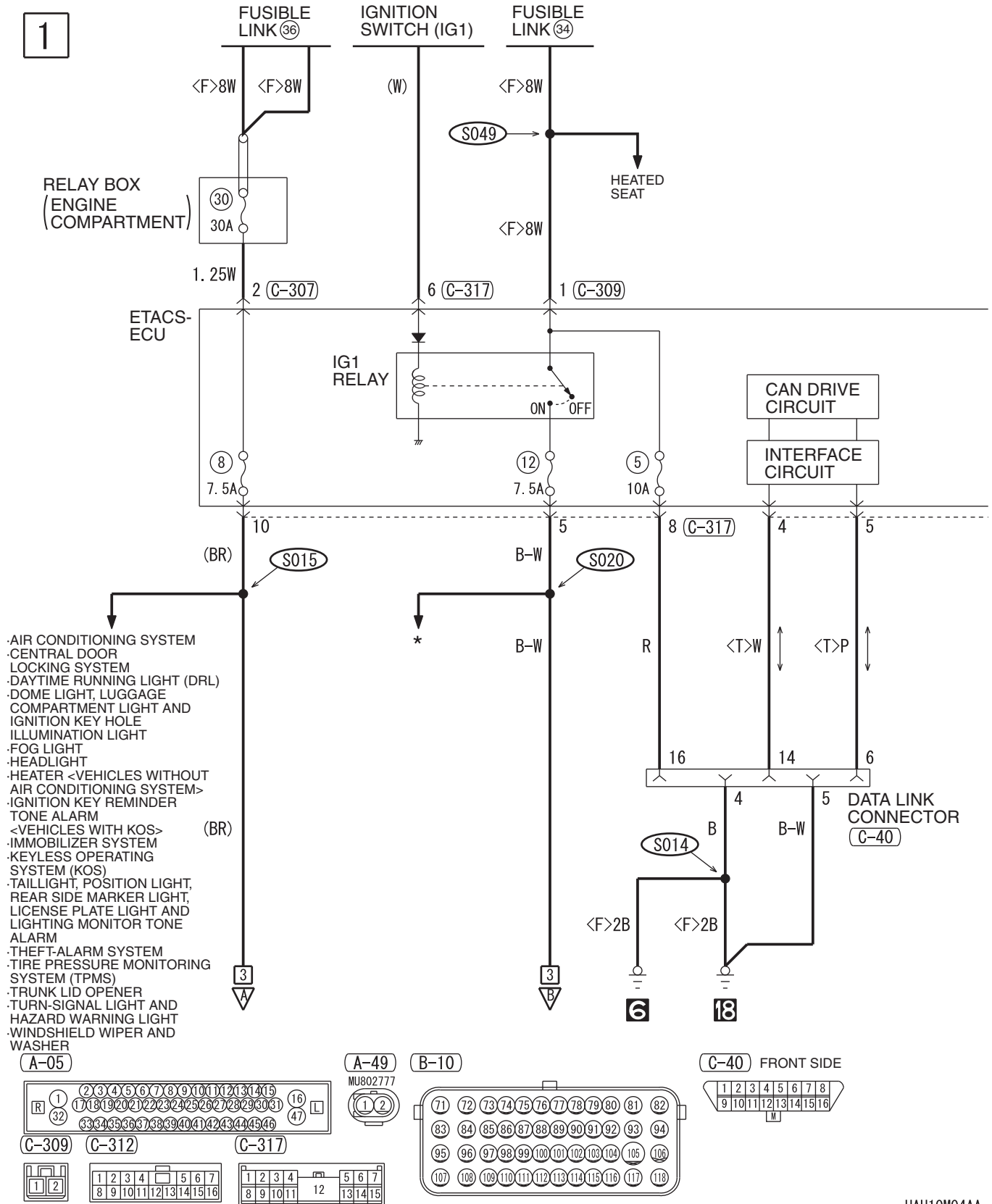

HAH10M04AA

2

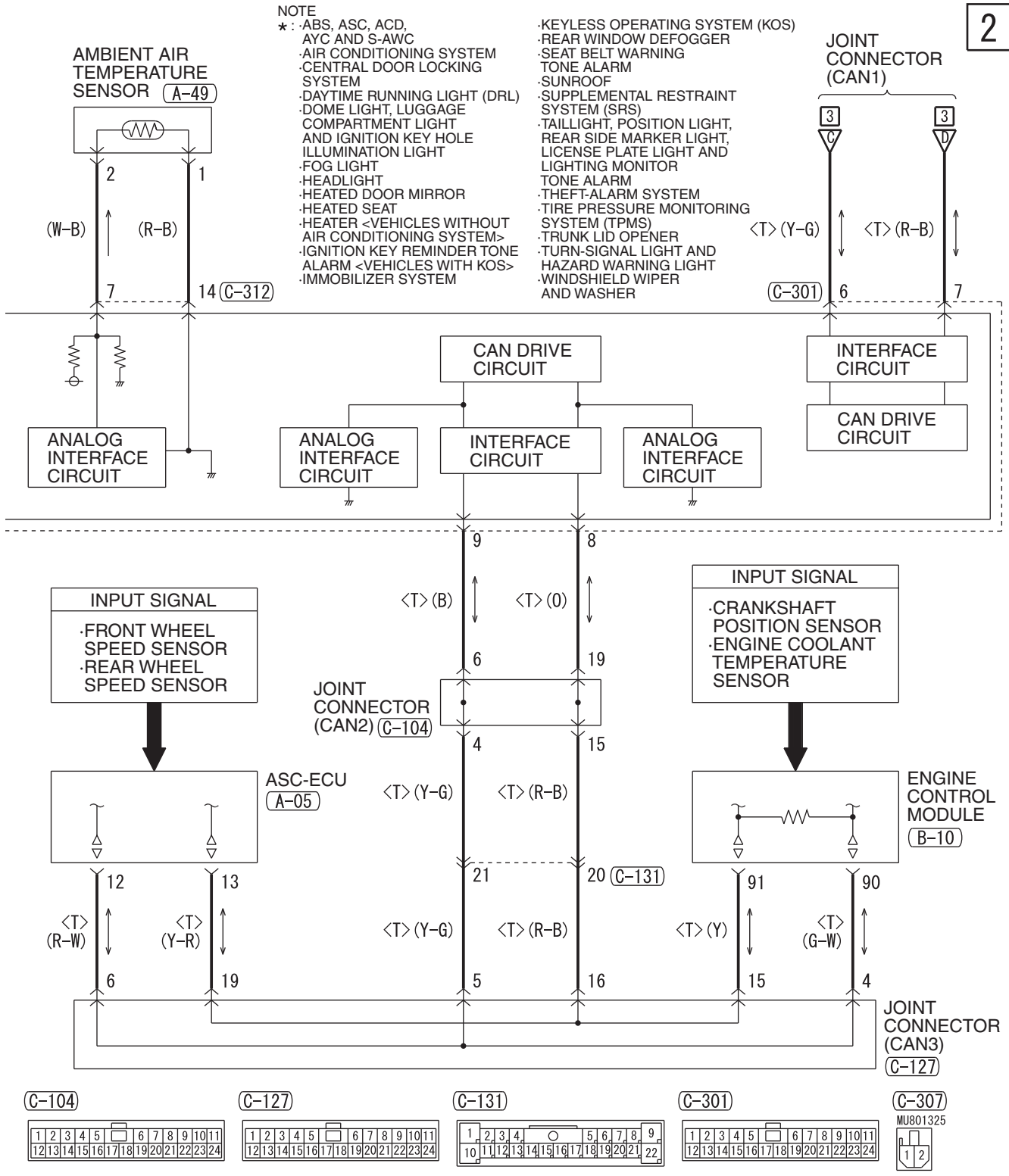

WIRE COLOR CODE  
B : BLACK LG : LIGHT GREEN G : GREEN L : BLUE W : WHITE Y : YELLOW SB : SKY BLUE  
BR : BROWN O : ORANGE GR : GRAY R : RED P : PINK V : VIOLET PU : PURPLE SI : SILVER

METER AND GAUGE <M/T> (CONTINUED)

3

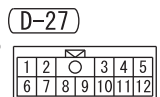
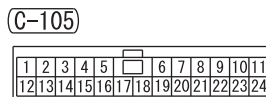
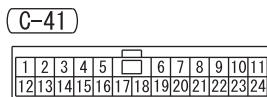
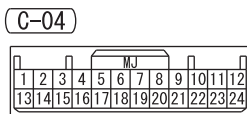
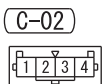
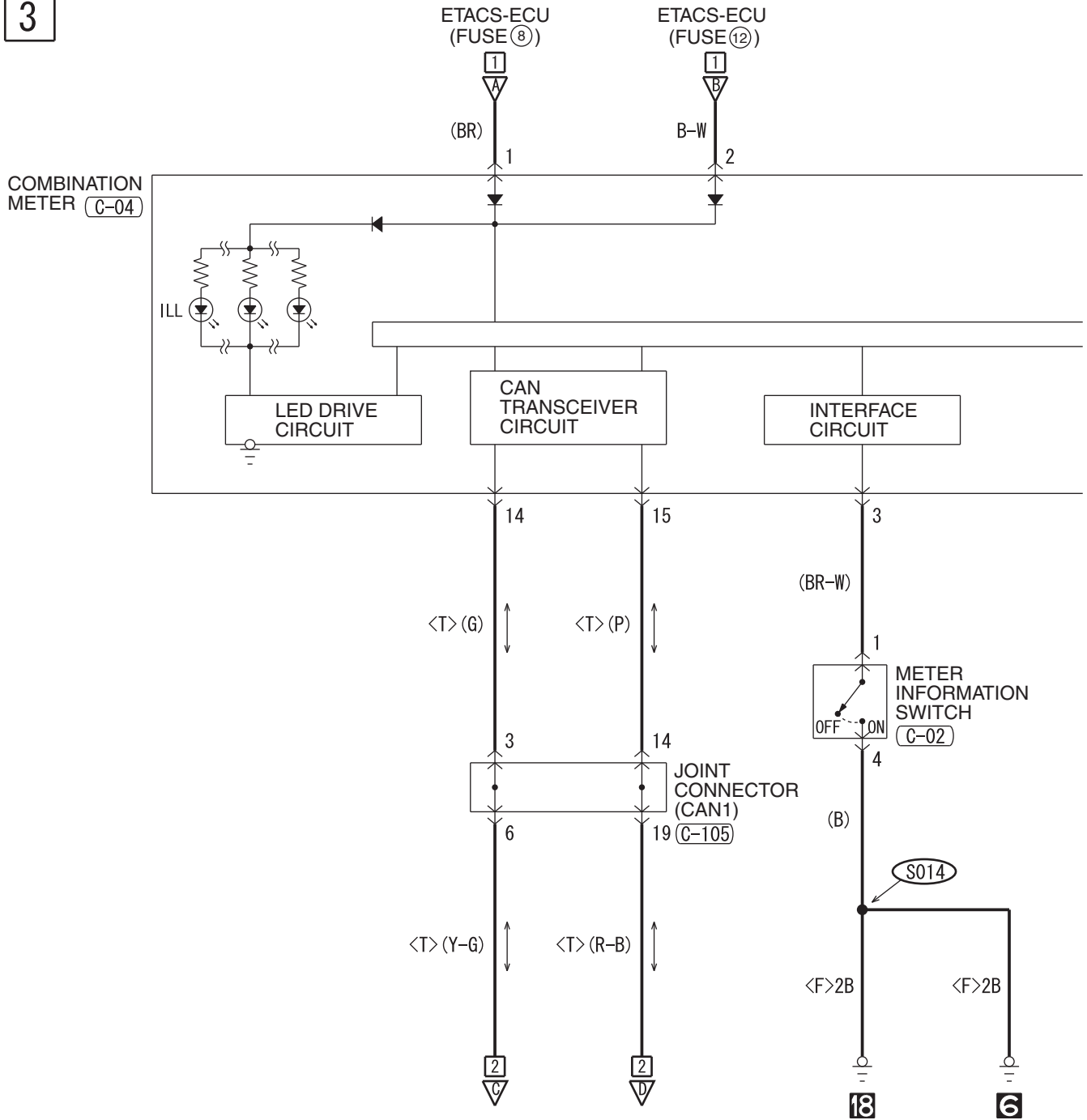

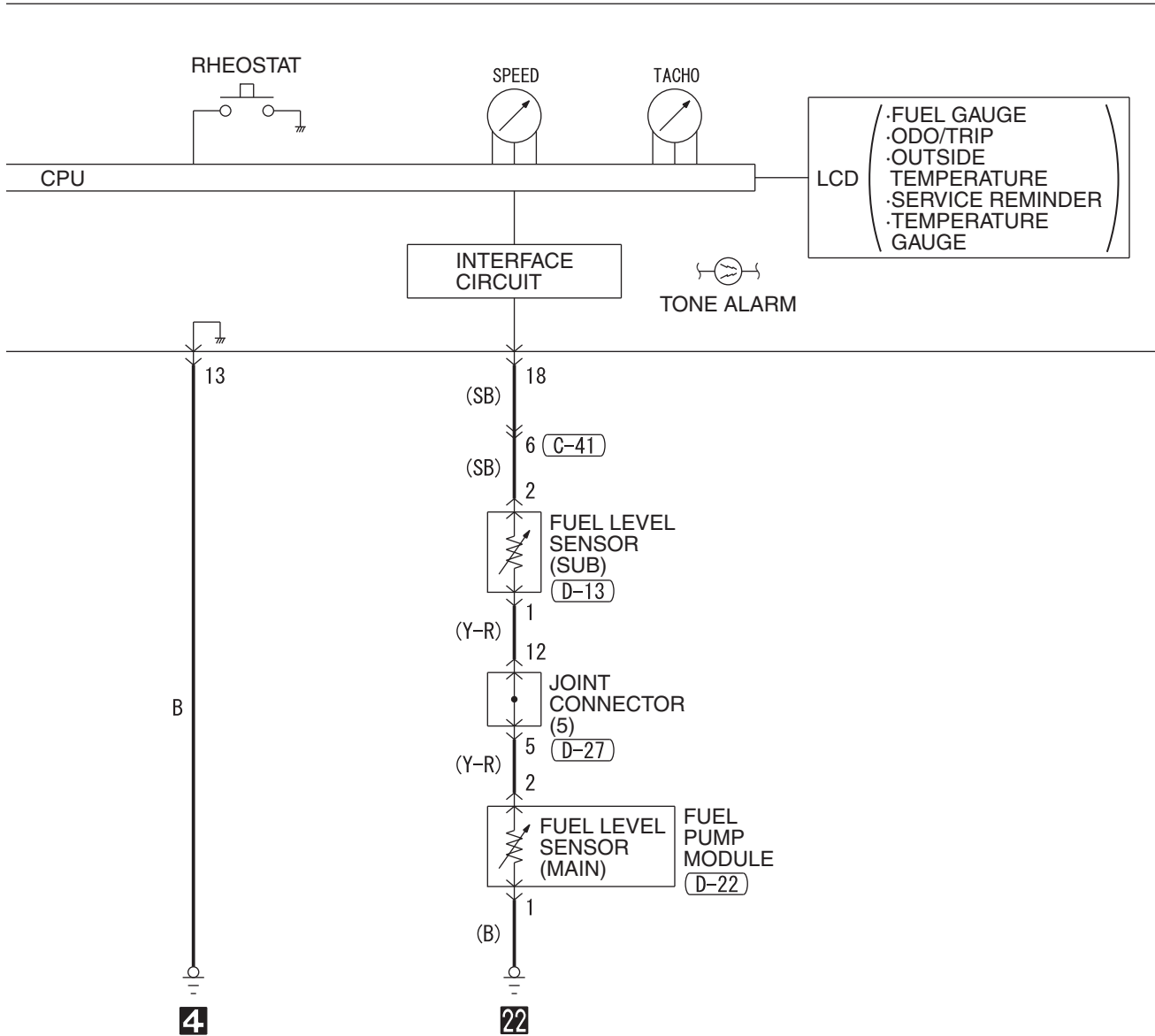

WIRE COLOR CODE

B: BLACK LG: LIGHT GREEN G: GREEN L: BLUE W: WHITE Y: YELLOW SB: SKY BLUE  
BR: BROWN O: ORANGE GR: GRAY R: RED P: PINK V: VIOLET PU: PURPLE SI: SILVER

HAH10M04BB

METER AND GAUGE <TC-SST>

M1901003505999

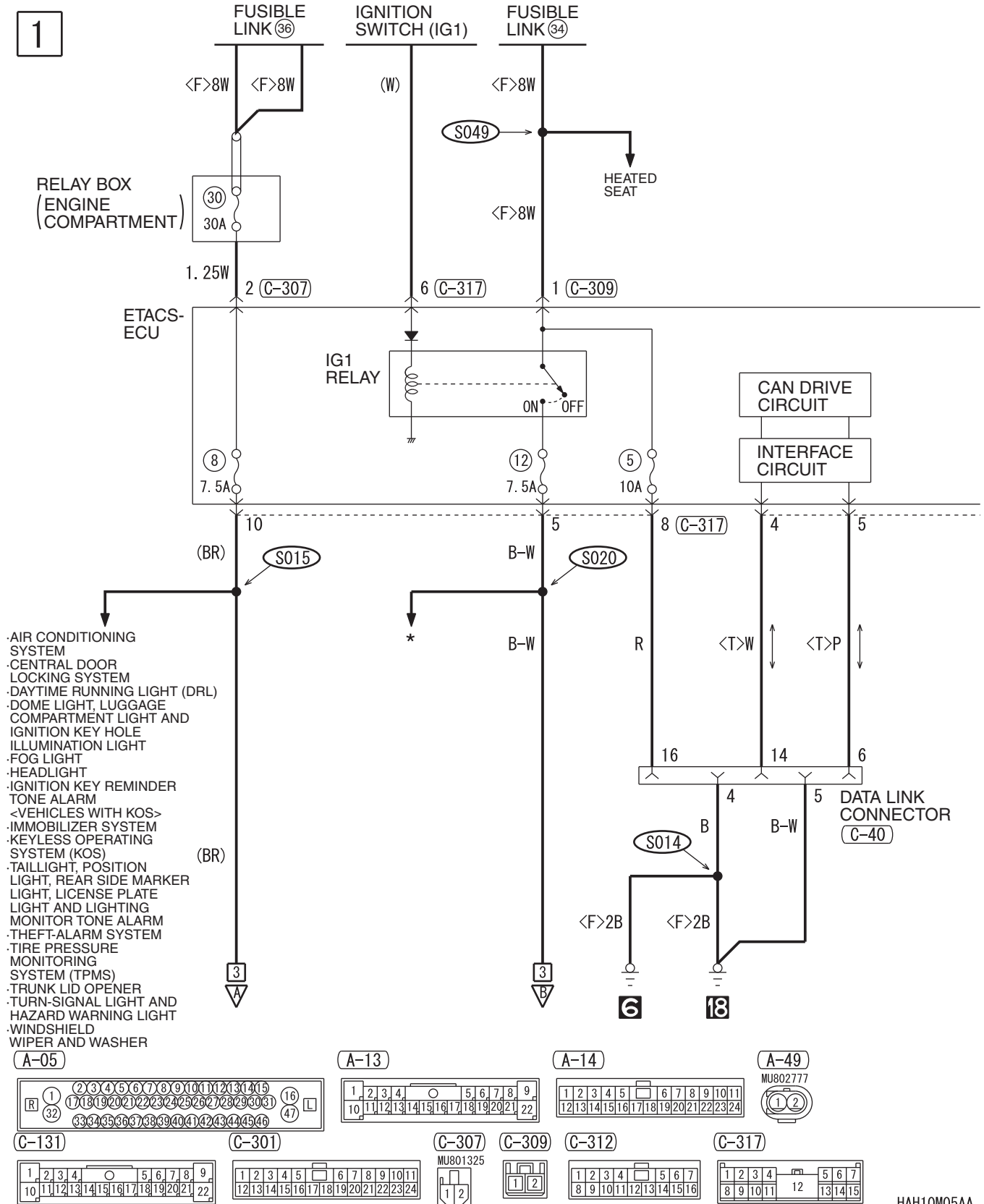



**2**

**NOTE**

- \* : ·ABS, ASC, ACD, AYC AND S-AWC
- AIR CONDITIONING SYSTEM
- CENTRAL DOOR LOCKING SYSTEM
- DAYTIME RUNNING LIGHT (DRL)
- DOME LIGHT, LUGGAGE COMPARTMENT LIGHT AND IGNITION KEY HOLE ILLUMINATION LIGHT
- FOG LIGHT
- HEADLIGHT
- HEATED DOOR MIRROR
- HEATED SEAT
- IGNITION KEY REMINDER TONE ALARM <VEHICLES WITH KOS>
- IMMOBILIZER SYSTEM
- KEYLESS OPERATING SYSTEM (KOS)
- REAR WINDOW DEFOGGER
- SEAT BELT WARNING TONE ALARM
- SHIFT LOCK MECHANISM
- SUNROOF
- SUPPLEMENTAL RESTRAINT SYSTEM (SRS)
- TAILLIGHT, POSITION LIGHT, REAR SIDE MARKER LIGHT, LICENSE PLATE LIGHT AND LIGHTING MONITOR
- TONE ALARM
- THEFT-ALARM SYSTEM
- TIRE PRESSURE MONITORING SYSTEM (TPMS)
- TRUNK LID OPENER
- TURN-SIGNAL LIGHT AND HAZARD WARNING LIGHT
- TWIN CLUTCH-SPORTRONIC SHIFT TRANSMISSION (TC-SST)
- WINDSHIELD WIPER AND WASHER

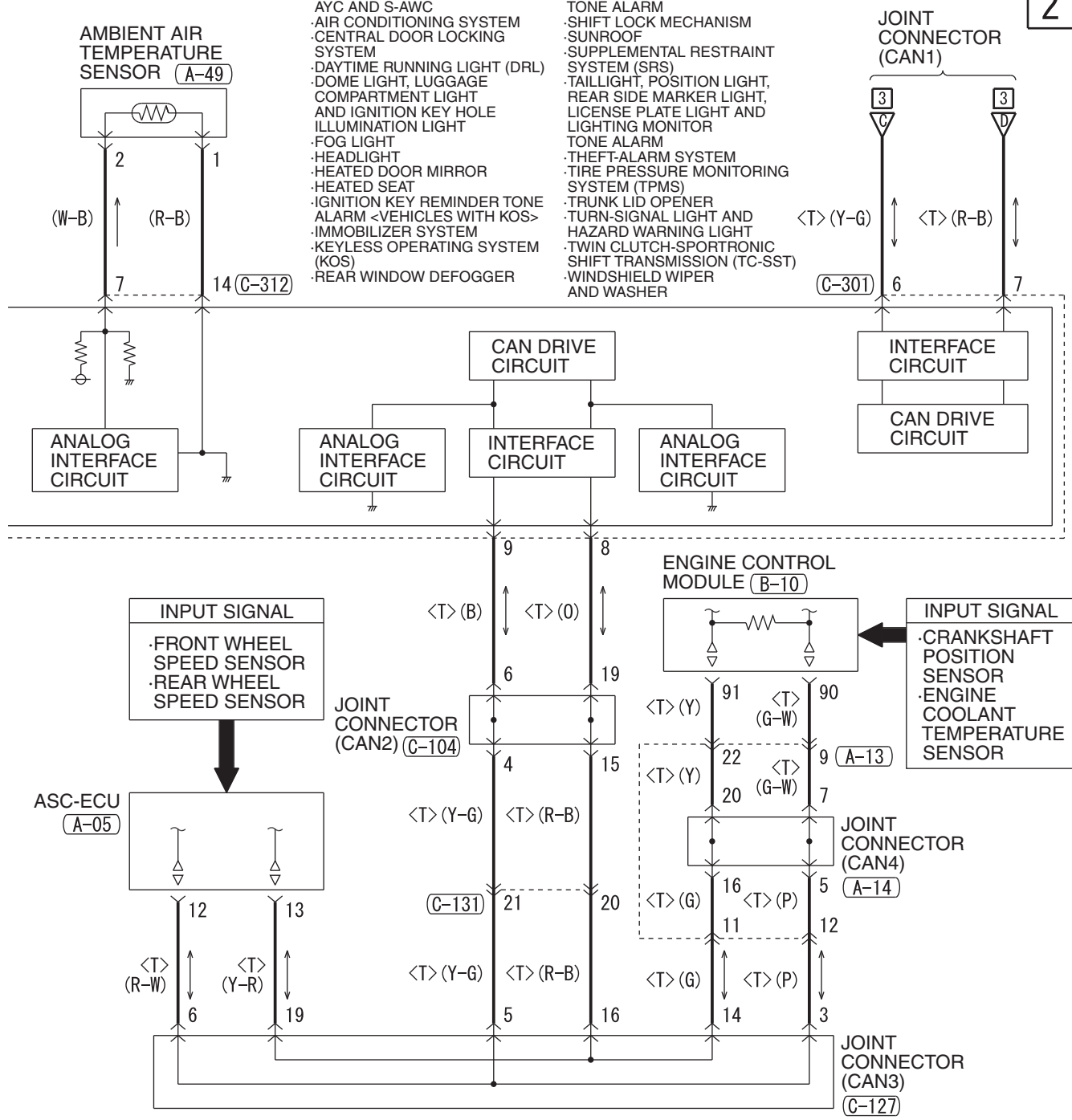

(B-10)

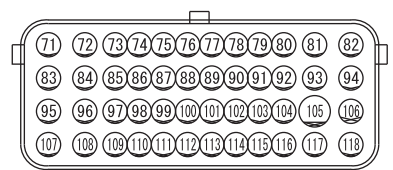

(C-40) FRONT SIDE

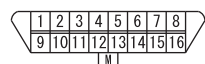

(C-104)

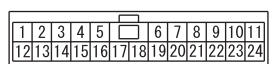

(C-127)

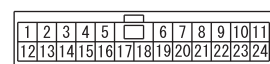

**WIRE COLOR CODE**  
 B : BLACK   LG : LIGHT GREEN   G : GREEN   L : BLUE   W : WHITE  
 Y : YELLOW   SB : SKY BLUE   BR : BROWN   O : ORANGE   GR : GRAY  
 R : RED   P : PINK   V : VIOLET   PU : PURPLE   SI : SILVER

HAH10M05AB

METER AND GAUGE <TC-SST> (CONTINUED)

3

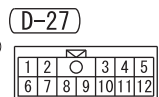
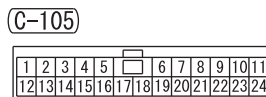
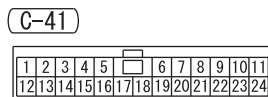
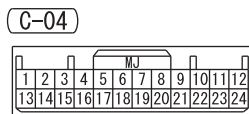
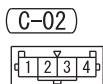
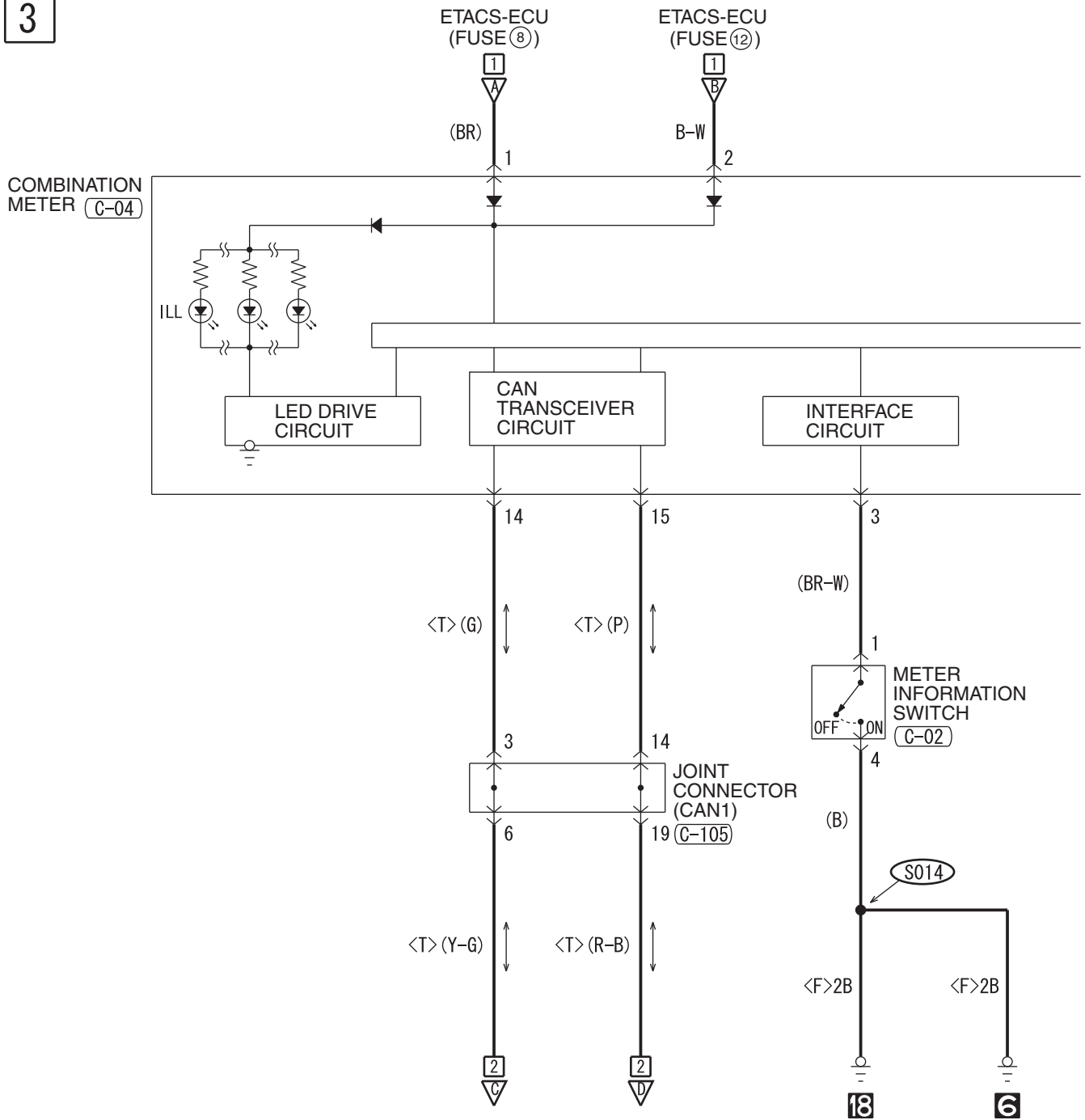

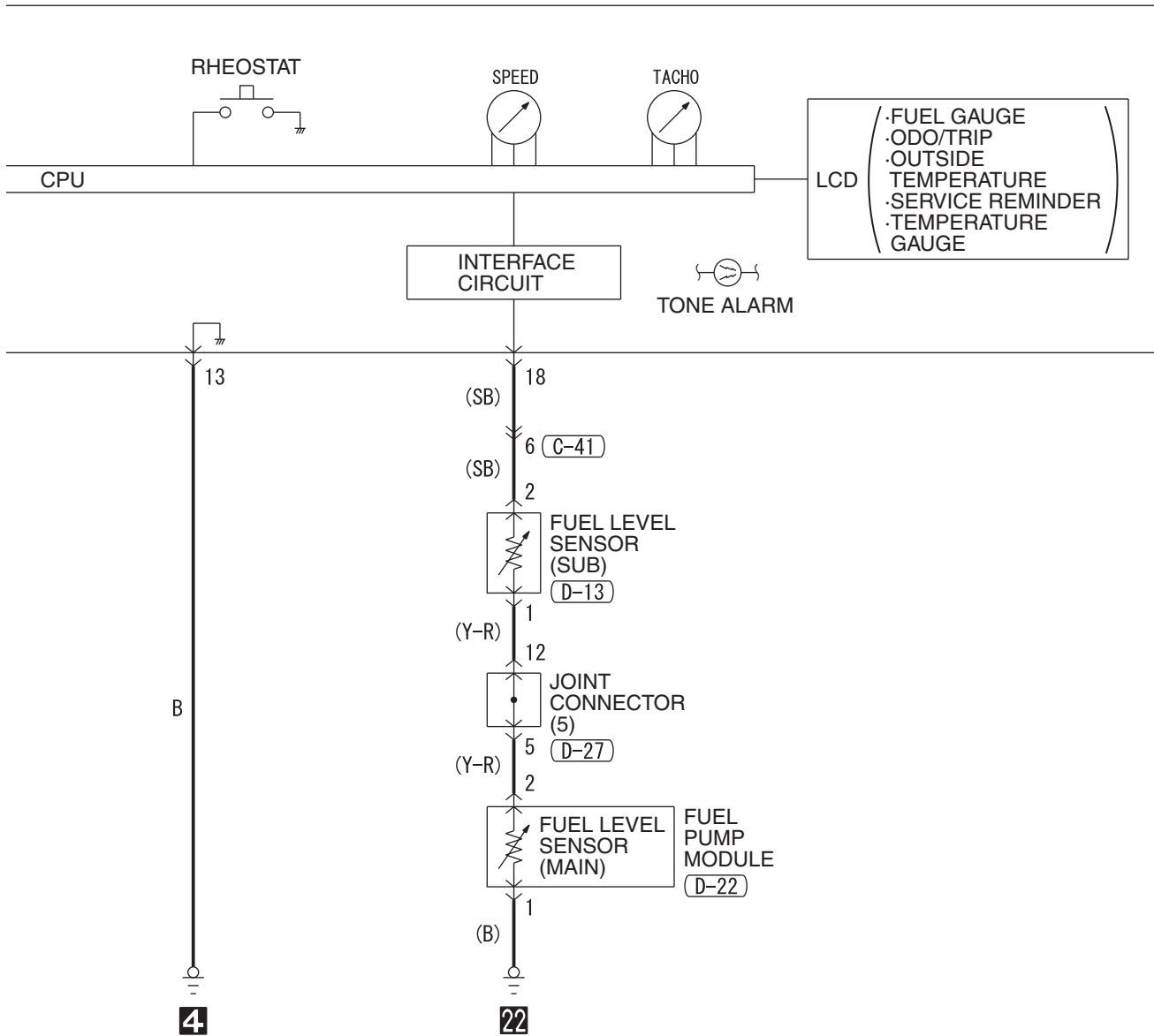

WIRE COLOR CODE

B: BLACK LG: LIGHT GREEN G: GREEN L: BLUE W: WHITE Y: YELLOW SB: SKY BLUE  
BR: BROWN O: ORANGE GR: GRAY R: RED P: PINK V: VIOLET PU: PURPLE SI: SILVER

HAH10M05BB

# BRAKE WARNING LIGHT, FUEL WARNING LIGHT AND OIL PRESSURE WARNING LIGHT <M/T>

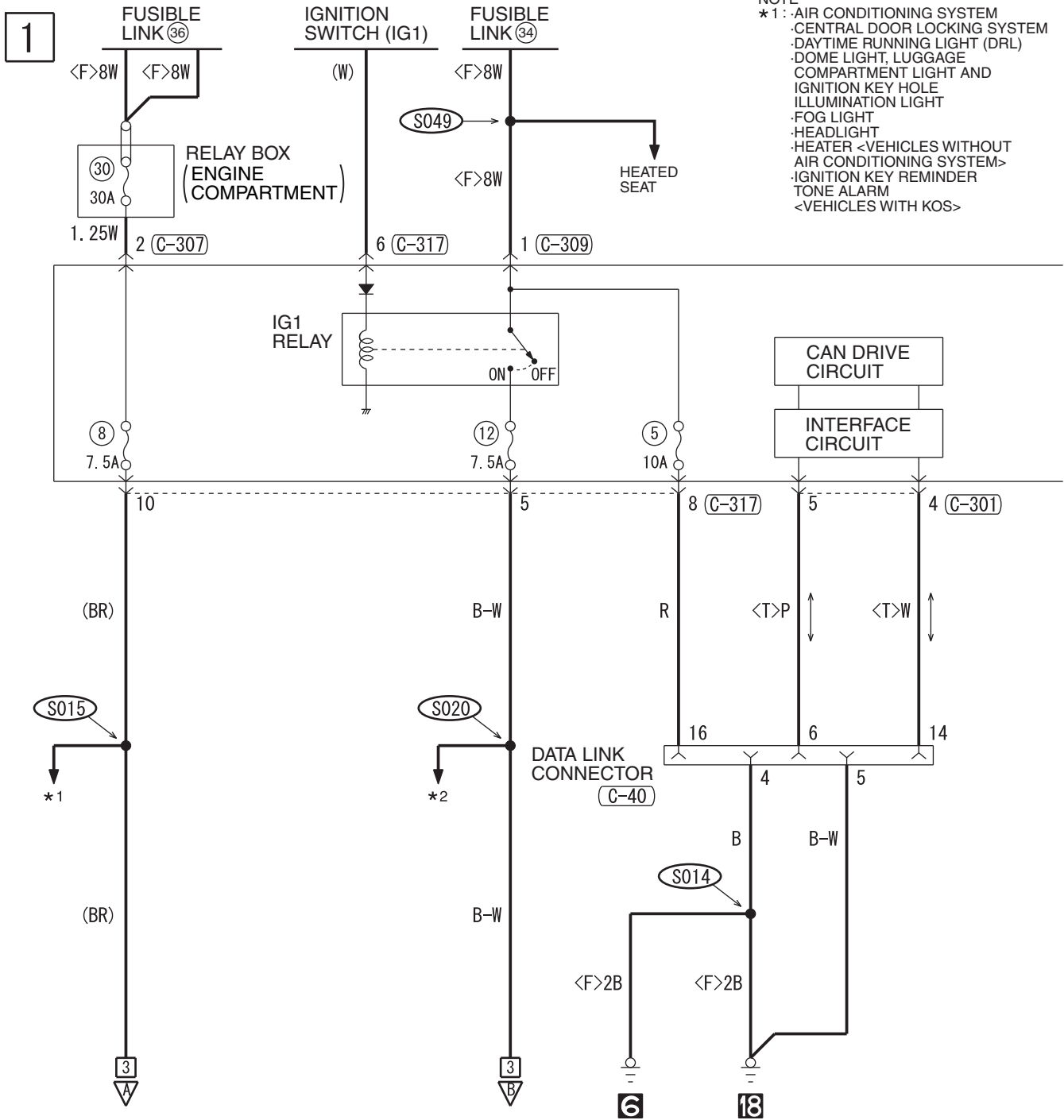

NOTE

- \* 1 : -AIR CONDITIONING SYSTEM
- CENTRAL DOOR LOCKING SYSTEM
- DAYTIME RUNNING LIGHT (DRL)
- DOME LIGHT, LUGGAGE COMPARTMENT LIGHT AND IGNITION KEY HOLE ILLUMINATION LIGHT
- FOG LIGHT
- HEADLIGHT
- HEATER <VEHICLES WITHOUT AIR CONDITIONING SYSTEM>
- IGNITION KEY REMINDER TONE ALARM
- <VEHICLES WITH KOS>

(A-09)

(B-09)

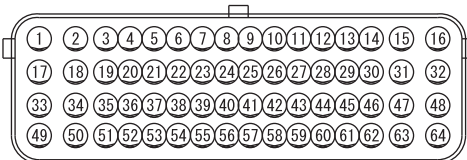

(B-10)

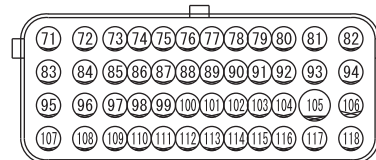

(B-15)



**2**

- IMMOBILIZER SYSTEM
- KEYLESS OPERATING SYSTEM (KOS)
- TAILLIGHT, POSITION LIGHT, REAR SIDE MARKER LIGHT, LICENSE PLATE LIGHT AND LIGHTING MONITOR TONE ALARM
- THEFT-ALARM SYSTEM
- TIRE PRESSURE MONITORING SYSTEM (TPMS)
- TRUNK LID OPENER
- TURN-SIGNAL LIGHT AND HAZARD WARNING LIGHT
- WINDSHIELD WIPER AND WASHER

- \*2 :
- ABS, ASC, ACD, AYC AND S-AWC
  - AIR CONDITIONING SYSTEM
  - CENTRAL DOOR LOCKING SYSTEM
  - DAYTIME RUNNING LIGHT (DRL)
  - DOME LIGHT, LUGGAGE COMPARTMENT LIGHT AND IGNITION KEY HOLE ILLUMINATION LIGHT
  - FOG LIGHT
  - HEADLIGHT
  - HEATED DOOR MIRROR
  - HEATED SEAT
  - HEATER <VEHICLES WITHOUT AIR CONDITIONING SYSTEM>
  - IGNITION KEY REMINDER TONE ALARM <VEHICLES WITH KOS>
  - IMMOBILIZER SYSTEM

- KEYLESS OPERATING SYSTEM (KOS)
- REAR WINDOW DEFOGGER
- SEAT BELT WARNING TONE ALARM
- SUNROOF
- SUPPLEMENTAL RESTRAINT SYSTEM (SRS)
- TAILLIGHT, POSITION LIGHT, REAR SIDE MARKER LIGHT, LICENSE PLATE LIGHT AND LIGHTING MONITOR TONE ALARM
- THEFT-ALARM SYSTEM
- TIRE PRESSURE MONITORING SYSTEM (TPMS)
- TRUNK LID OPENER
- TURN-SIGNAL LIGHT AND HAZARD WARNING LIGHT
- WINDSHIELD WIPER AND WASHER

ETACS-ECU

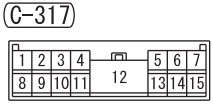
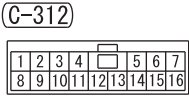
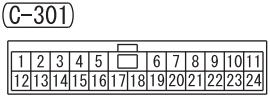
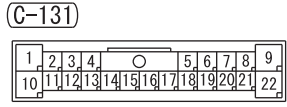
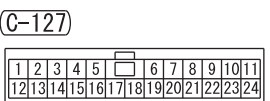
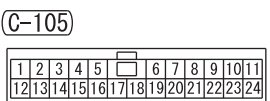
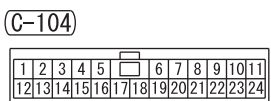
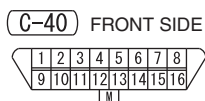
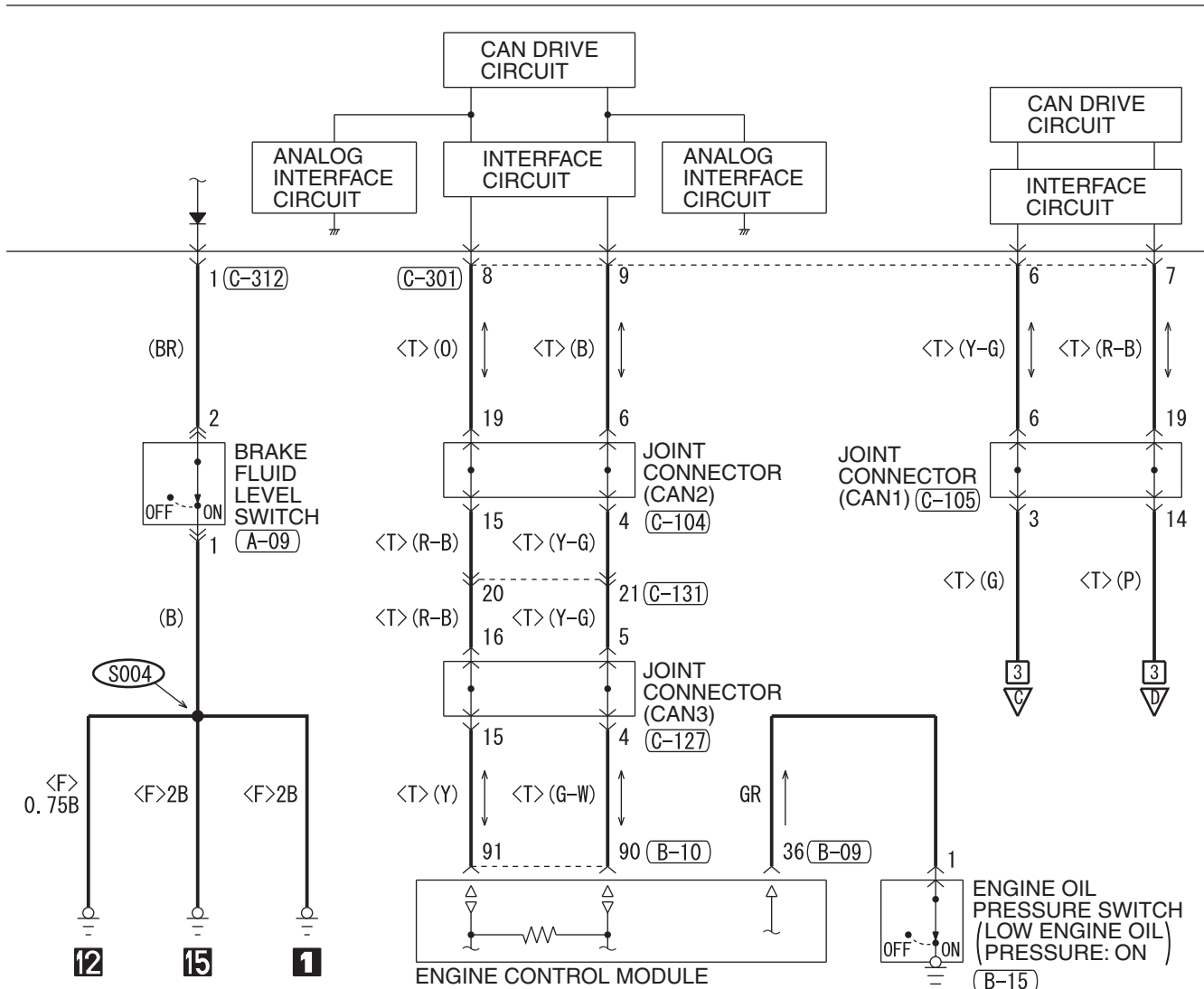

HAH10M06AB

BRAKE WARNING LIGHT, FUEL WARNING LIGHT AND OIL PRESSURE WARNING LIGHT <M/T> (CONTINUED)

3

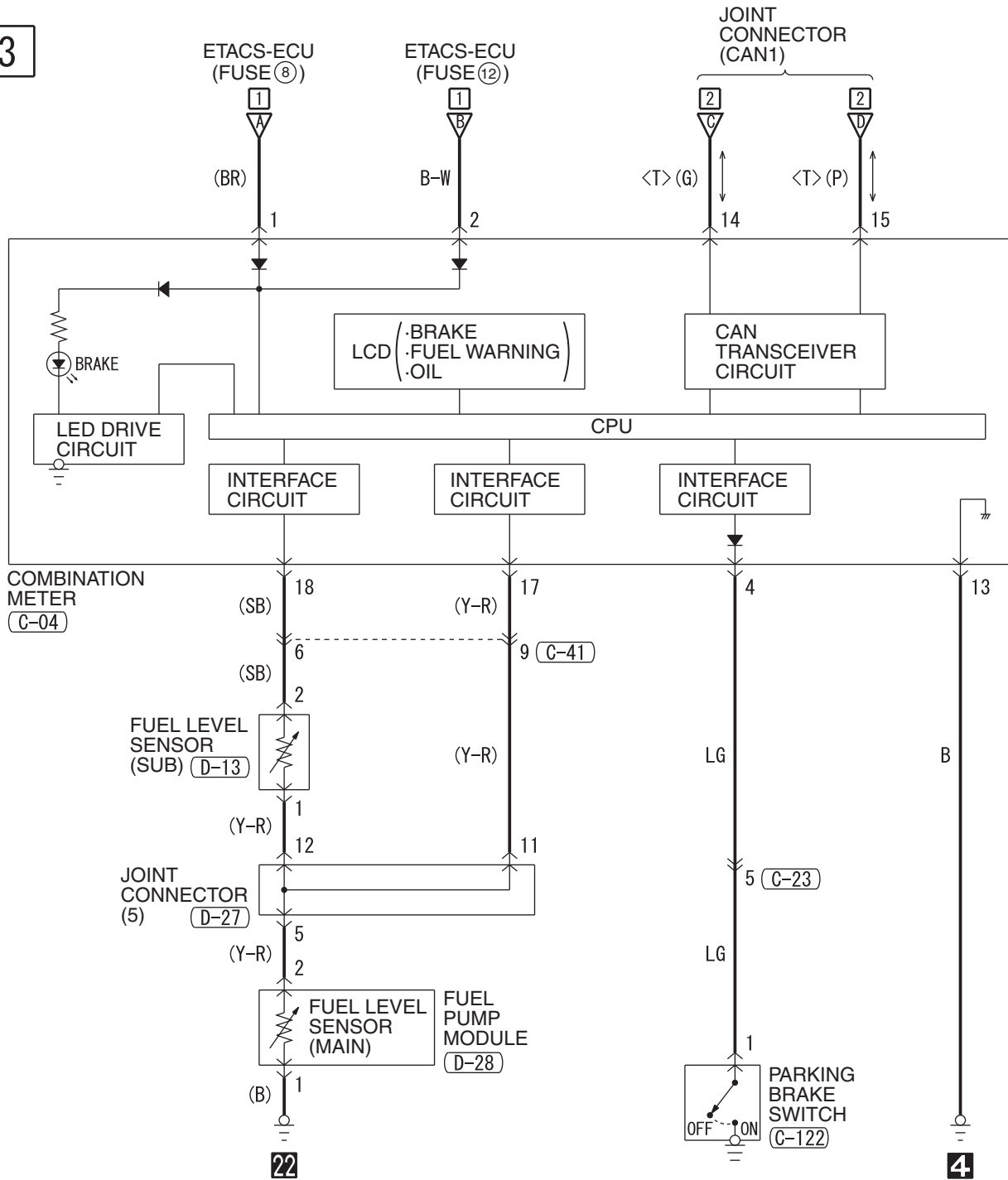

(C-04)

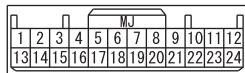

(C-23)

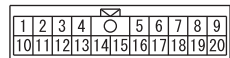

(C-41)

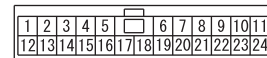

(C-122)



(D-13)



(D-27)

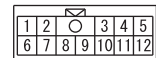

(D-28)



WIRE COLOR CODE  
 B: BLACK LG: LIGHT GREEN G: GREEN L: BLUE W: WHITE Y: YELLOW SB: SKY BLUE  
 BR: BROWN O: ORANGE GR: GRAY R: RED P: PINK V: VIOLET PU: PURPLE SI: SILVER

NOTES

# BRAKE WARNING LIGHT, FUEL WARNING LIGHT AND OIL PRESSURE WARNING LIGHT <TC-SST>

M1901020000453

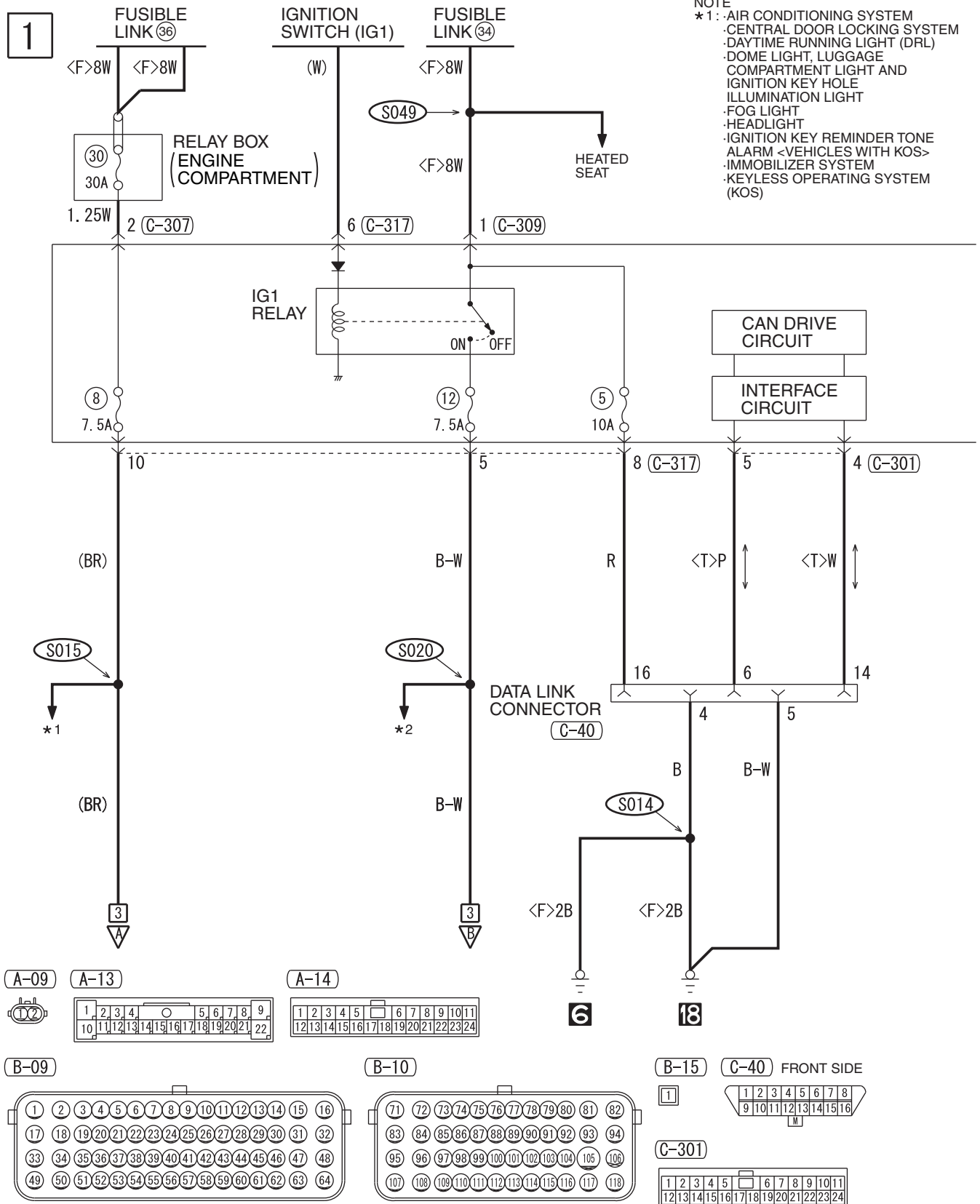



**2**

- TAILLIGHT, POSITION LIGHT, REAR SIDE MARKER LIGHT, LICENSE PLATE LIGHT AND LIGHTING MONITOR TONE ALARM
- THEFT-ALARM SYSTEM
- TIRE PRESSURE MONITORING SYSTEM (TPMS)
- TRUNK LID OPENER
- TURN-SIGNAL LIGHT AND HAZARD WARNING LIGHT
- WINDSHIELD WIPER AND WASHER

- \*2 : -ABS, ASC, ACD, AYC AND S-AWC
- AIR CONDITIONING SYSTEM
  - CENTRAL DOOR LOCKING SYSTEM
  - DAYTIME RUNNING LIGHT (DRL)
  - DOME LIGHT, LUGGAGE COMPARTMENT LIGHT AND IGNITION KEY HOLE ILLUMINATION LIGHT
  - FOG LIGHT
  - HEADLIGHT
  - HEATED DOOR MIRROR
  - HEATED SEAT
  - IGNITION KEY REMINDER TONE ALARM <VEHICLES WITH KOS>
  - IMMOBILIZER SYSTEM
  - KEYLESS OPERATING SYSTEM (KOS)
  - REAR WINDOW DEFOGGER

- SEAT BELT WARNING TONE ALARM
- SHIFT LOCK MECHANISM
- SUNROOF
- SUPPLEMENTAL RESTRAINT SYSTEM (SRS)
- TAILLIGHT, POSITION LIGHT, REAR SIDE MARKER LIGHT, LICENSE PLATE LIGHT AND LIGHTING MONITOR TONE ALARM
- THEFT-ALARM SYSTEM
- TIRE PRESSURE MONITORING SYSTEM (TPMS)
- TRUNK LID OPENER
- TURN-SIGNAL LIGHT AND HAZARD WARNING LIGHT
- TWIN CLUTCH-SPORTRONIC SHIFT TRANSMISSION (TC-SST)
- WINDSHIELD WIPER AND WASHER

ETACS-ECU

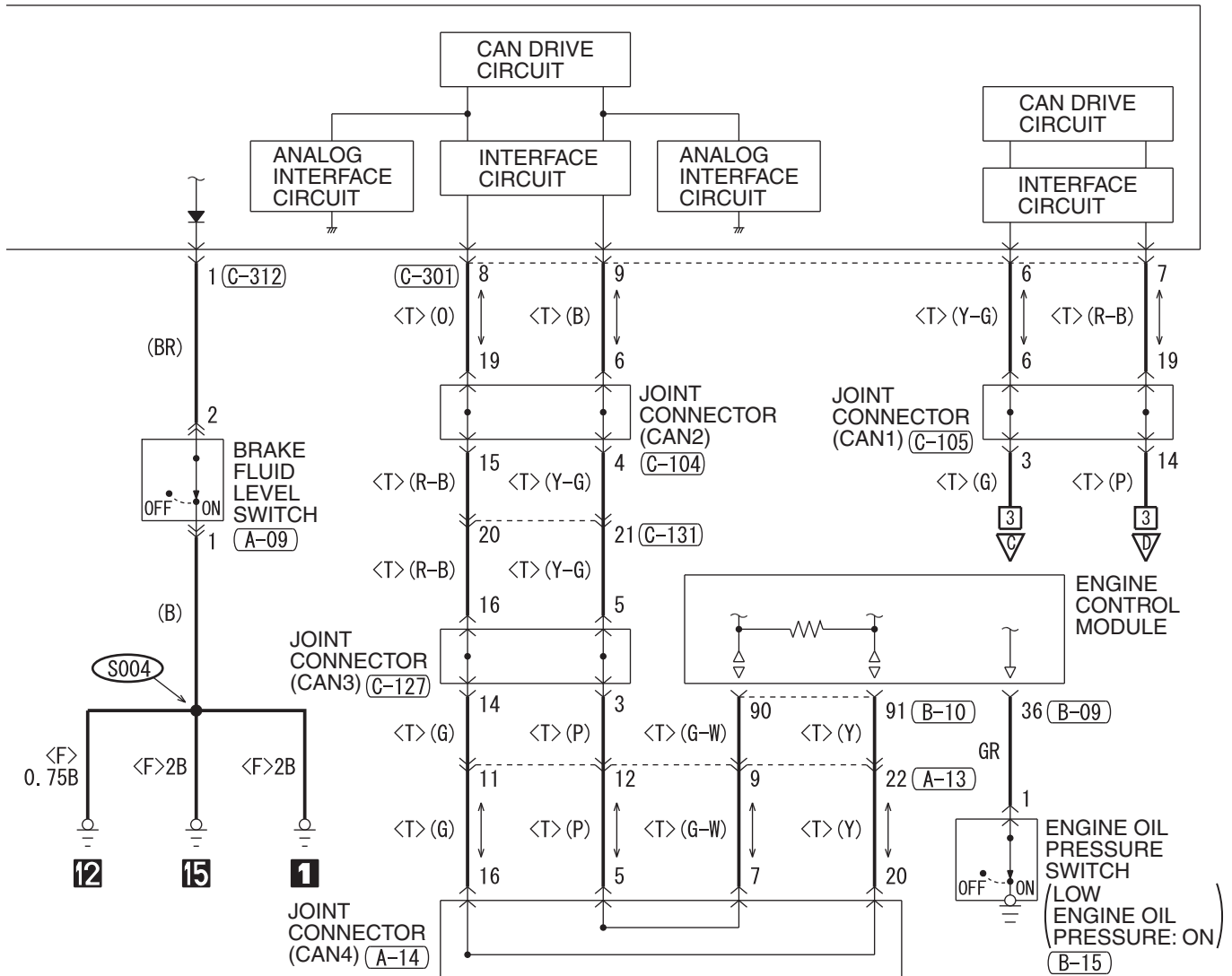

(C-104)

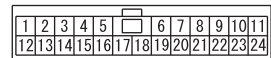

(C-105)

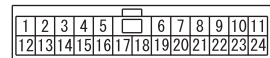

(C-127)

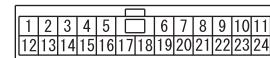

(C-131)

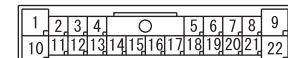

(C-307)



(C-309)



(C-312)

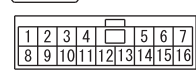

(C-317)

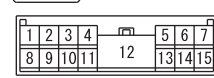

BRAKE WARNING LIGHT, FUEL WARNING LIGHT AND OIL PRESSURE WARNING LIGHT <TC-SST>  
(CONTINUED)

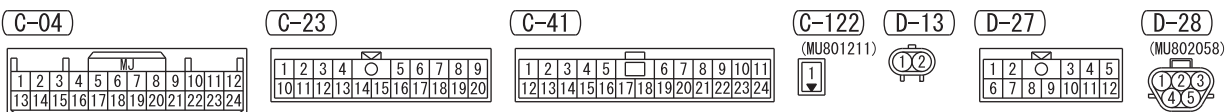
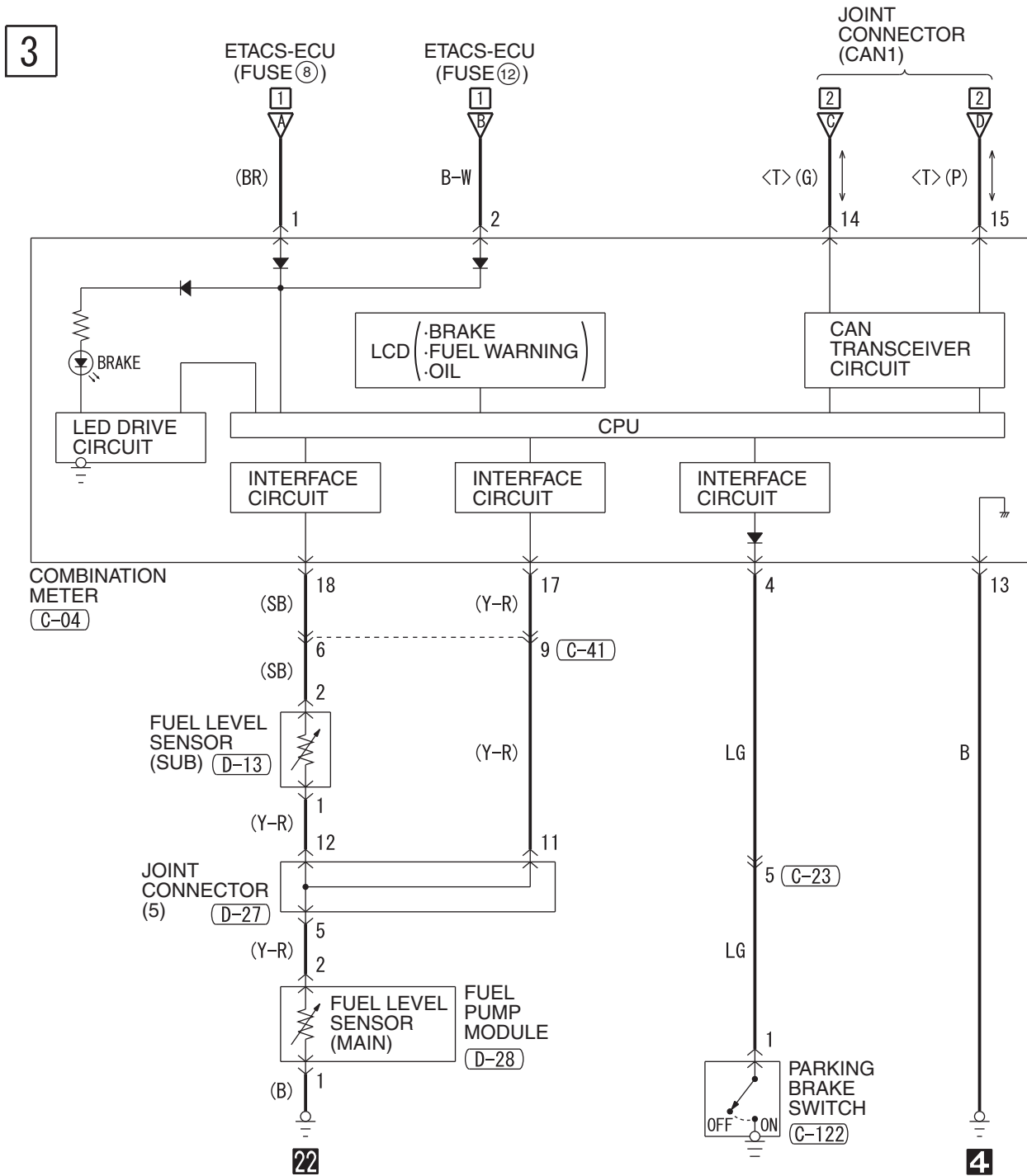

WIRE COLOR CODE  
 B : BLACK LG : LIGHT GREEN G : GREEN L : BLUE W : WHITE Y : YELLOW SB : SKY BLUE  
 BR : BROWN O : ORANGE GR : GRAY R : RED P : PINK V : VIOLET PU : PURPLE SI : SILVER

NOTES

# POWER WINDOWS

M1901004604844

1

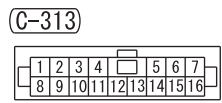
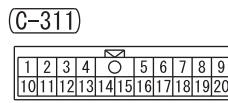
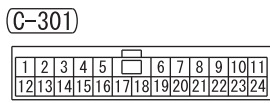
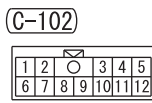
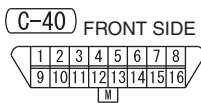
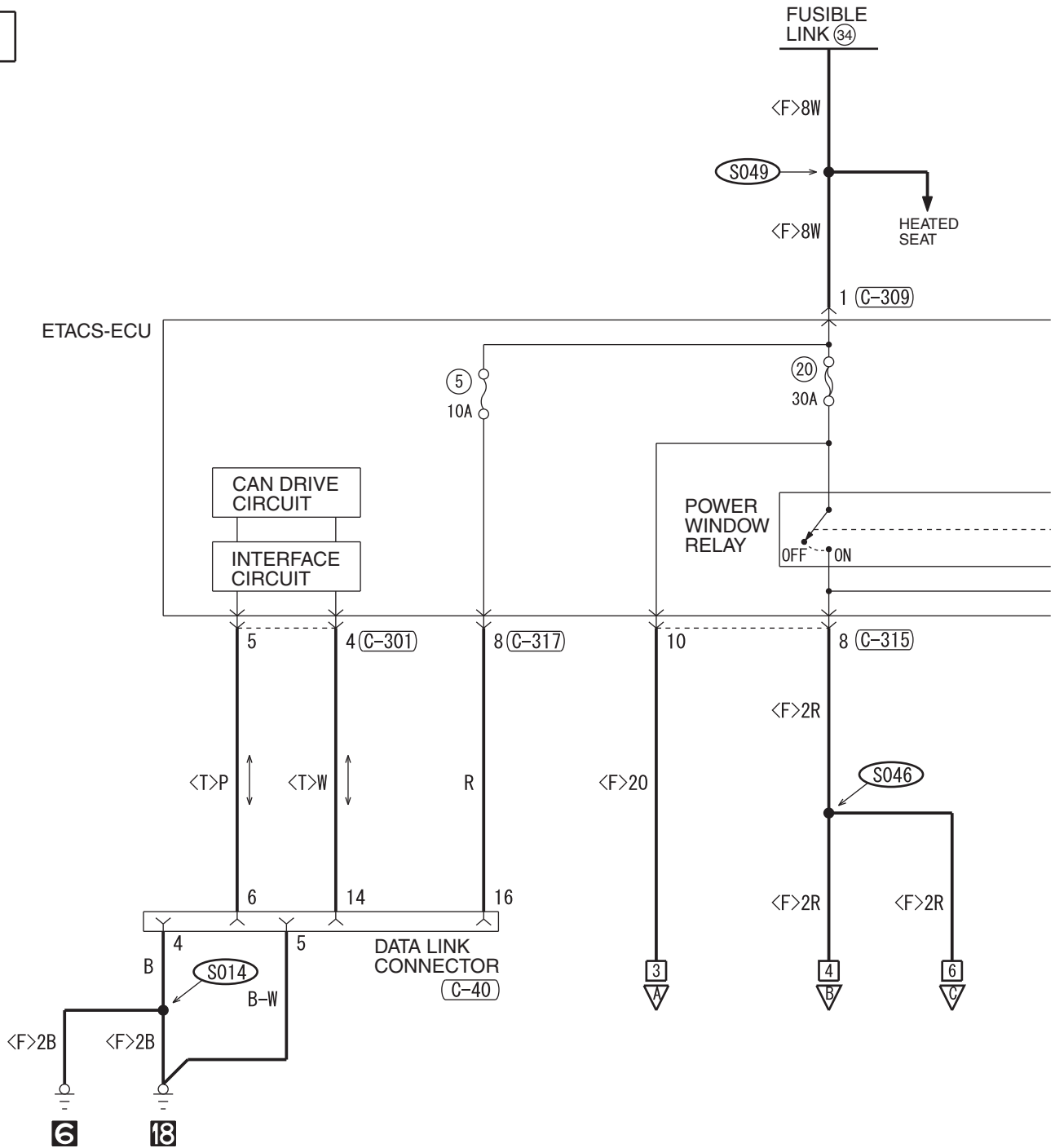

HAH11M04AA

2

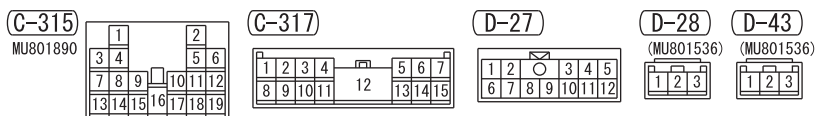
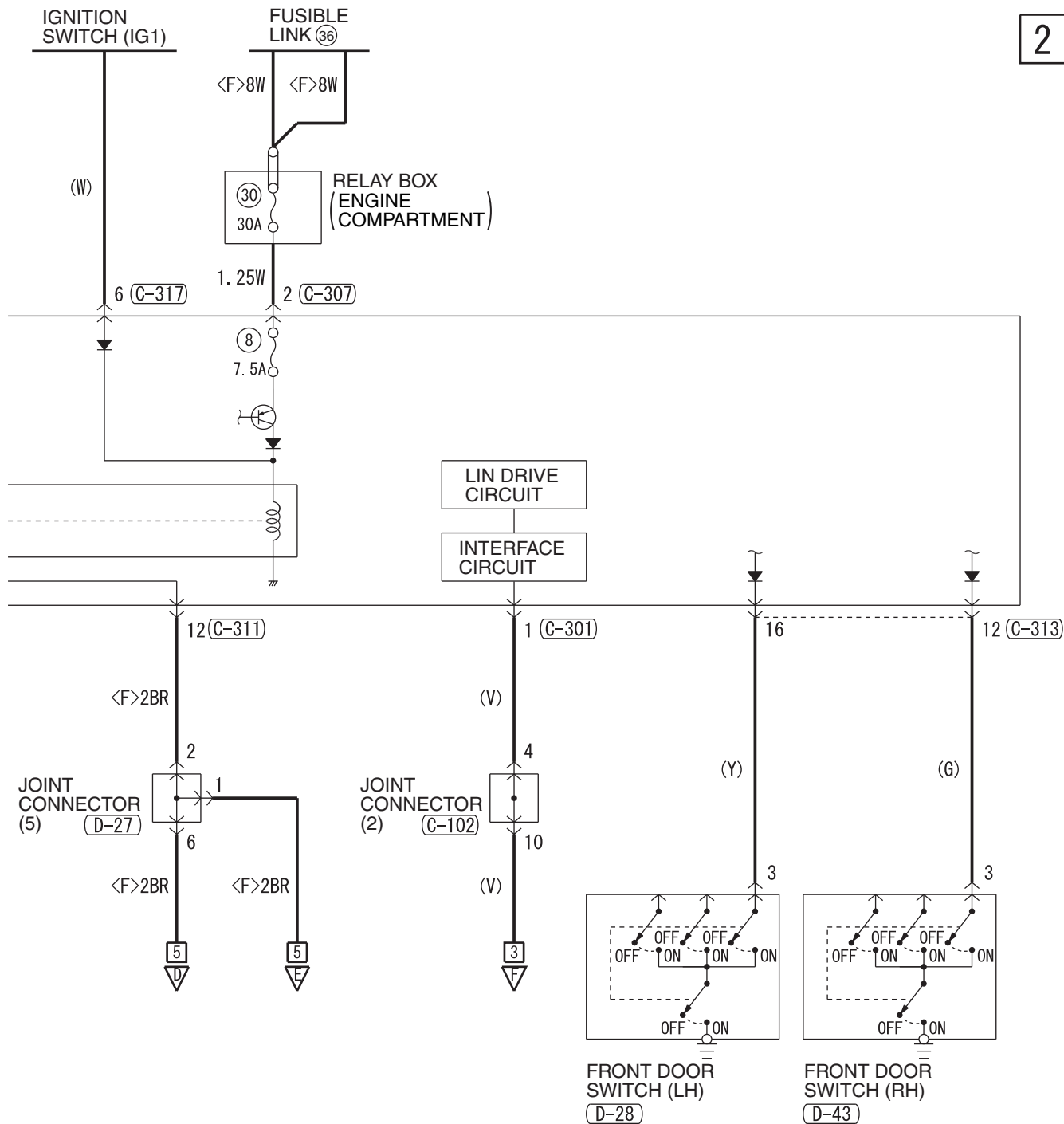

**WIRE COLOR CODE**  
 B : BLACK LG : LIGHT GREEN G : GREEN L : BLUE W : WHITE Y : YELLOW SB : SKY BLUE  
 BR : BROWN O : ORANGE GR : GRAY R : RED P : PINK V : VIOLET PU : PURPLE SI : SILVER

HAH11M04AB

POWER WINDOWS (CONTINUED)

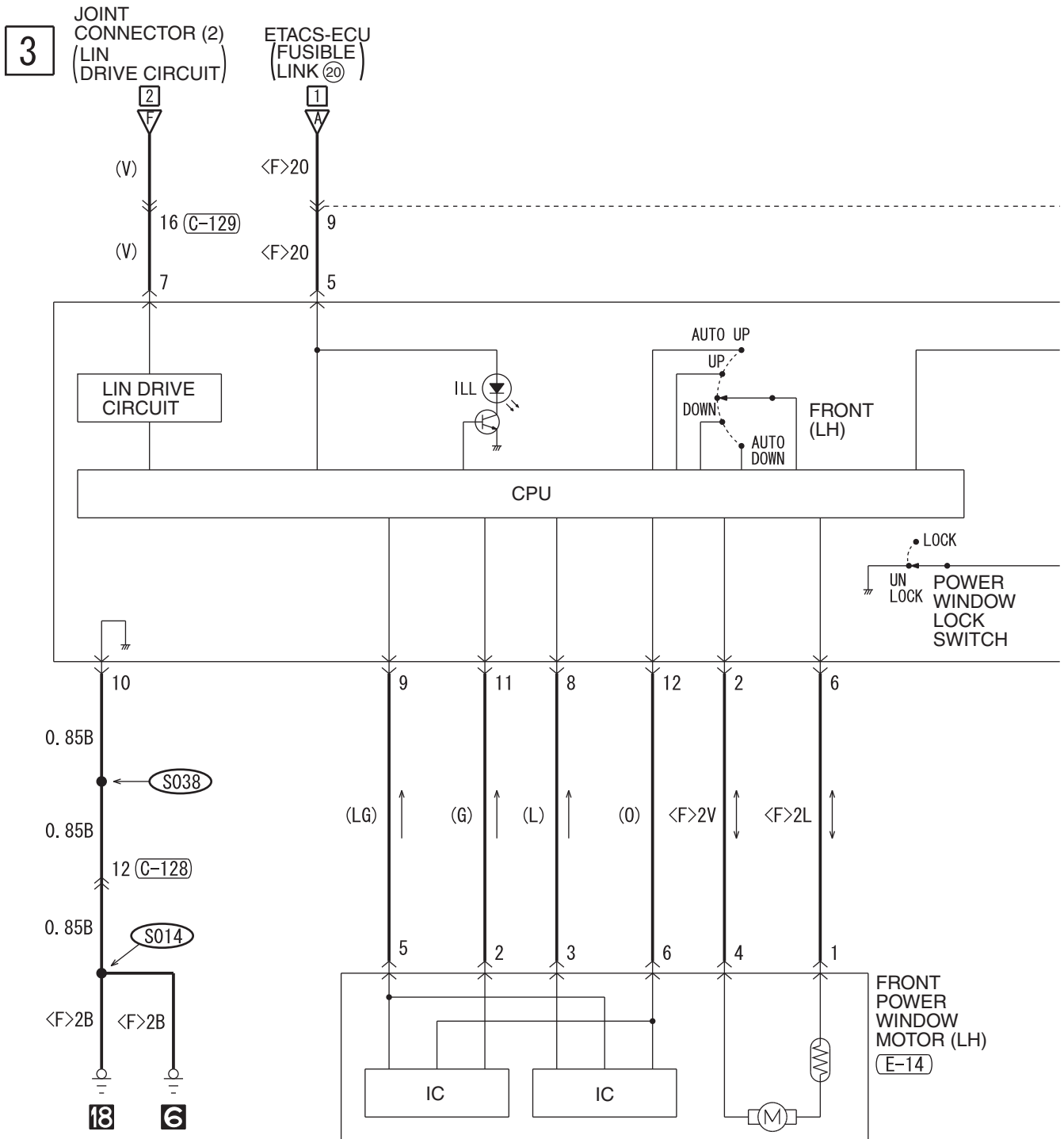

(C-128)

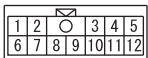

(C-129)

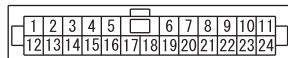

(E-14)



(E-15)

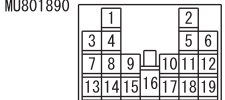

4

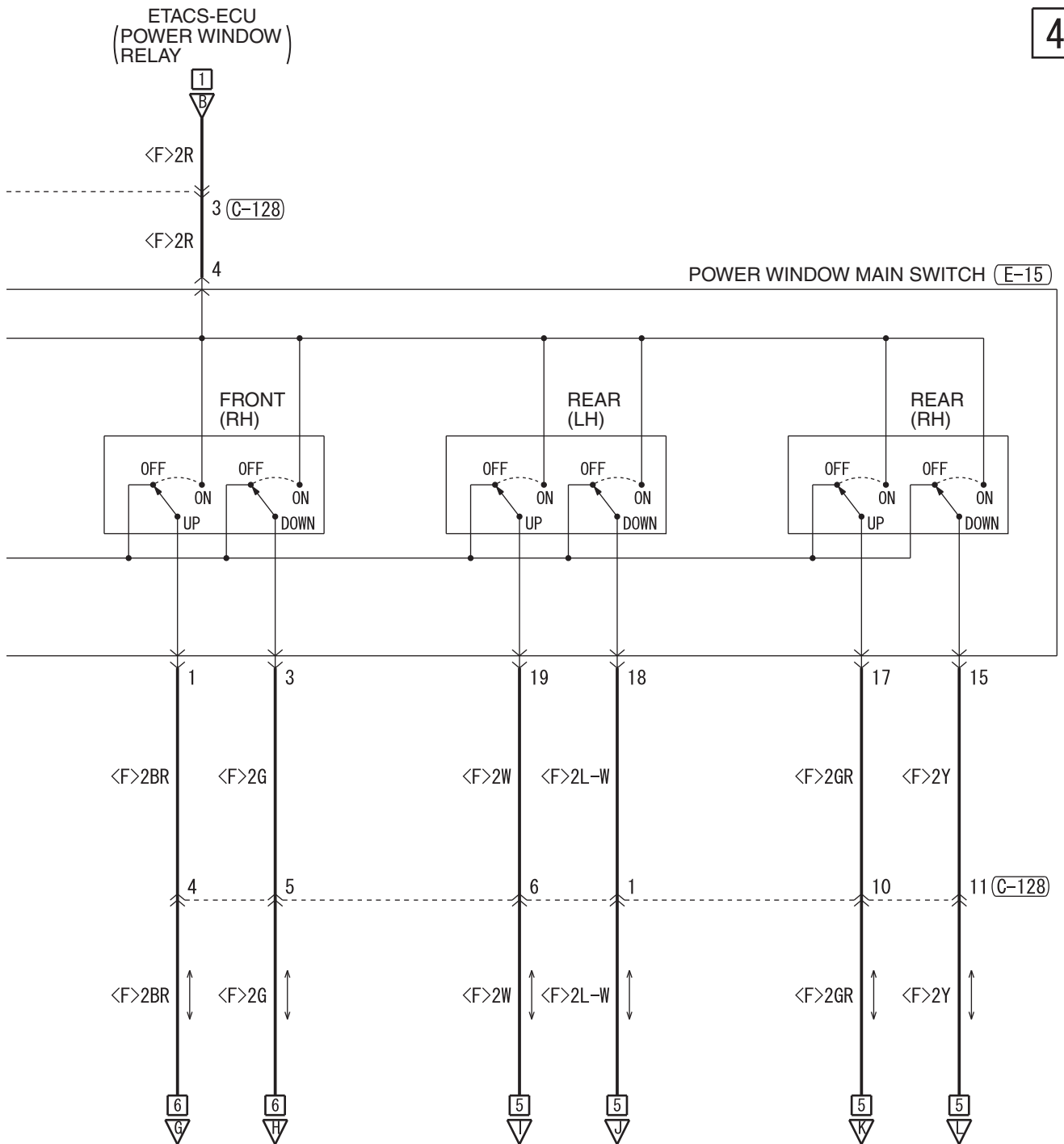

WIRE COLOR CODE

B: BLACK LG: LIGHT GREEN G: GREEN L: BLUE W: WHITE Y: YELLOW SB: SKY BLUE  
BR: BROWN O: ORANGE GR: GRAY R: RED P: PINK V: VIOLET PU: PURPLE SI: SILVER

HAH11M04BB

TSB Revision

POWER WINDOWS (CONTINUED)

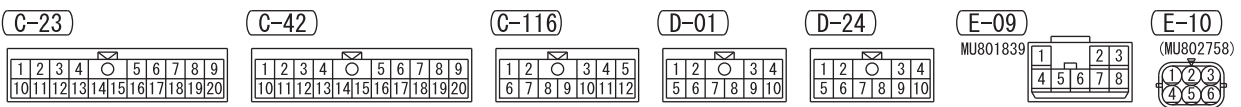
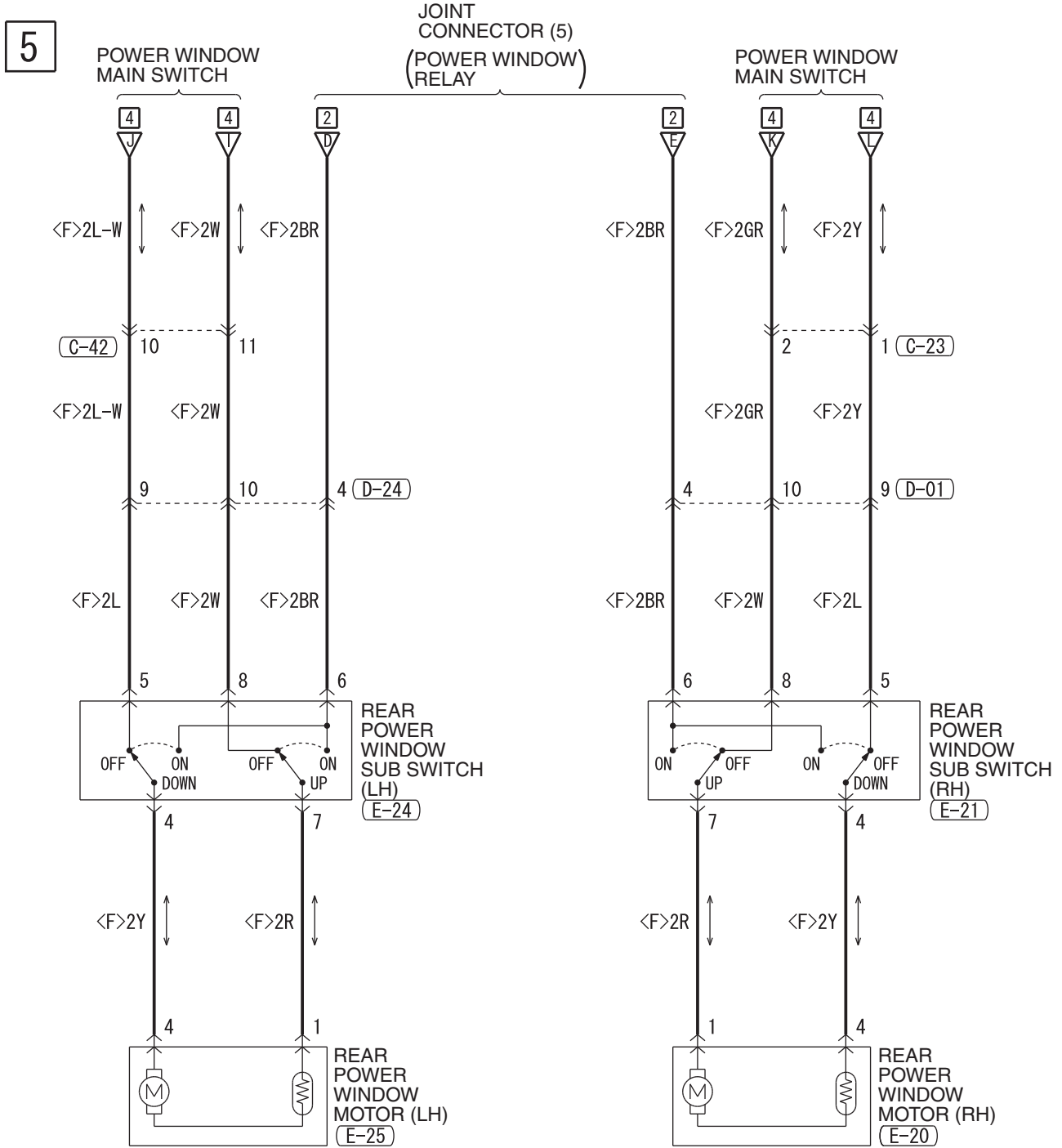



6

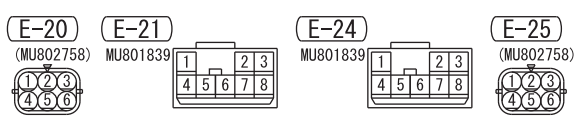
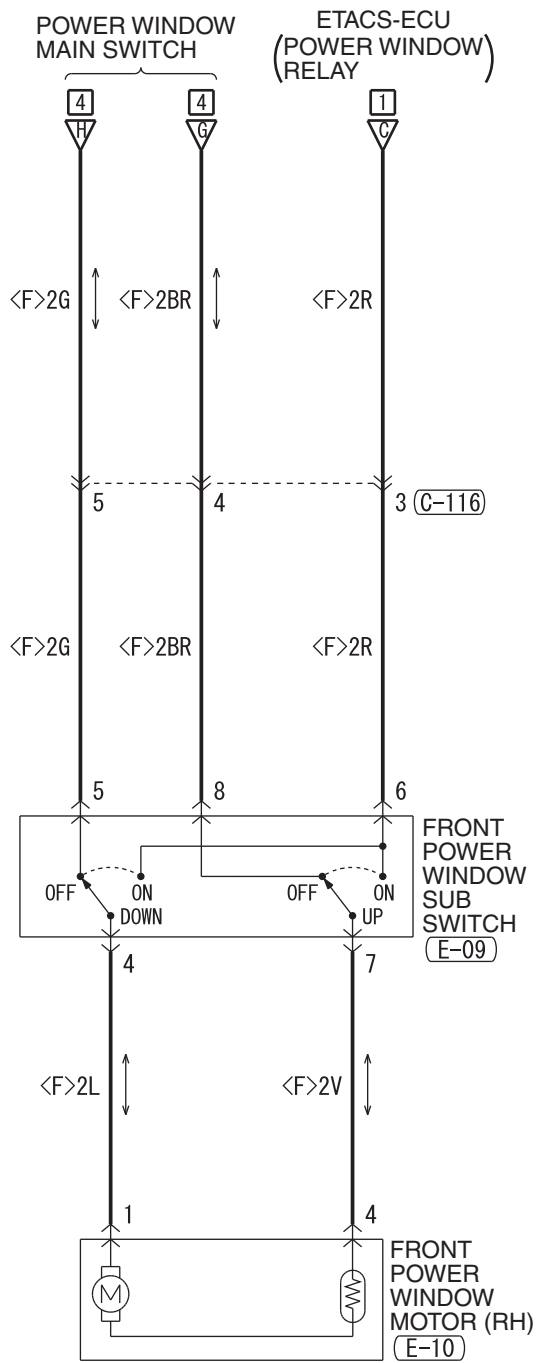

WIRE COLOR CODE  
 B: BLACK LG: LIGHT GREEN G: GREEN L: BLUE W: WHITE Y: YELLOW SB: SKY BLUE  
 BR: BROWN O: ORANGE GR: GRAY R: RED P: PINK V: VIOLET PU: PURPLE SI: SILVER

HAH11M04CB

TSB Revision

# CENTRAL DOOR LOCKING SYSTEM

M1901004707420

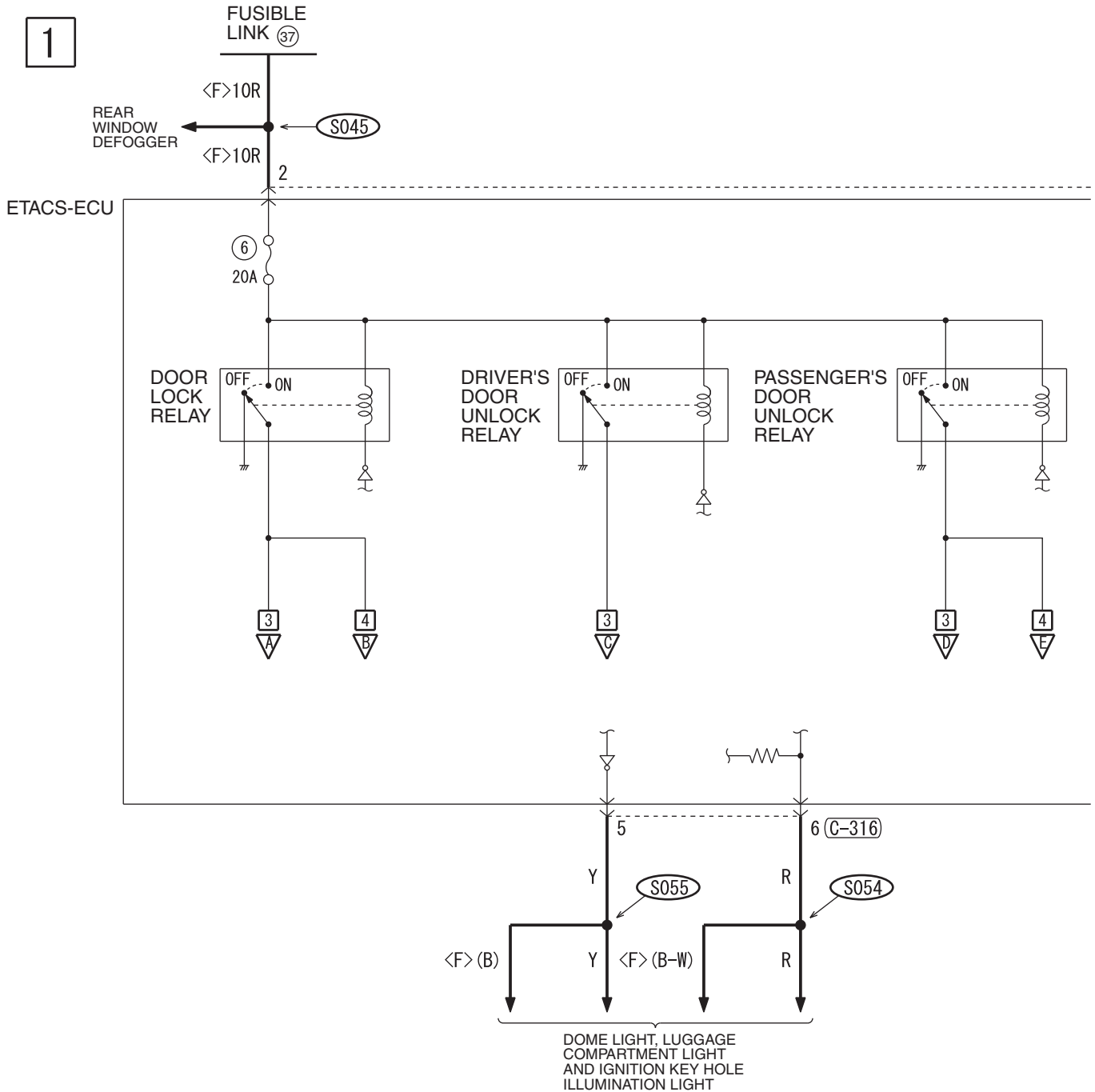

(C-40) FRONT SIDE

(C-301)

(C-304)

(C-309)

(C-311)

(C-316)

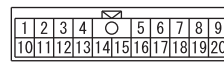
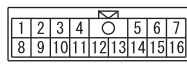
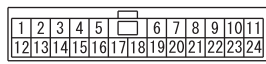
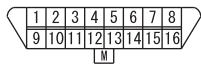

2

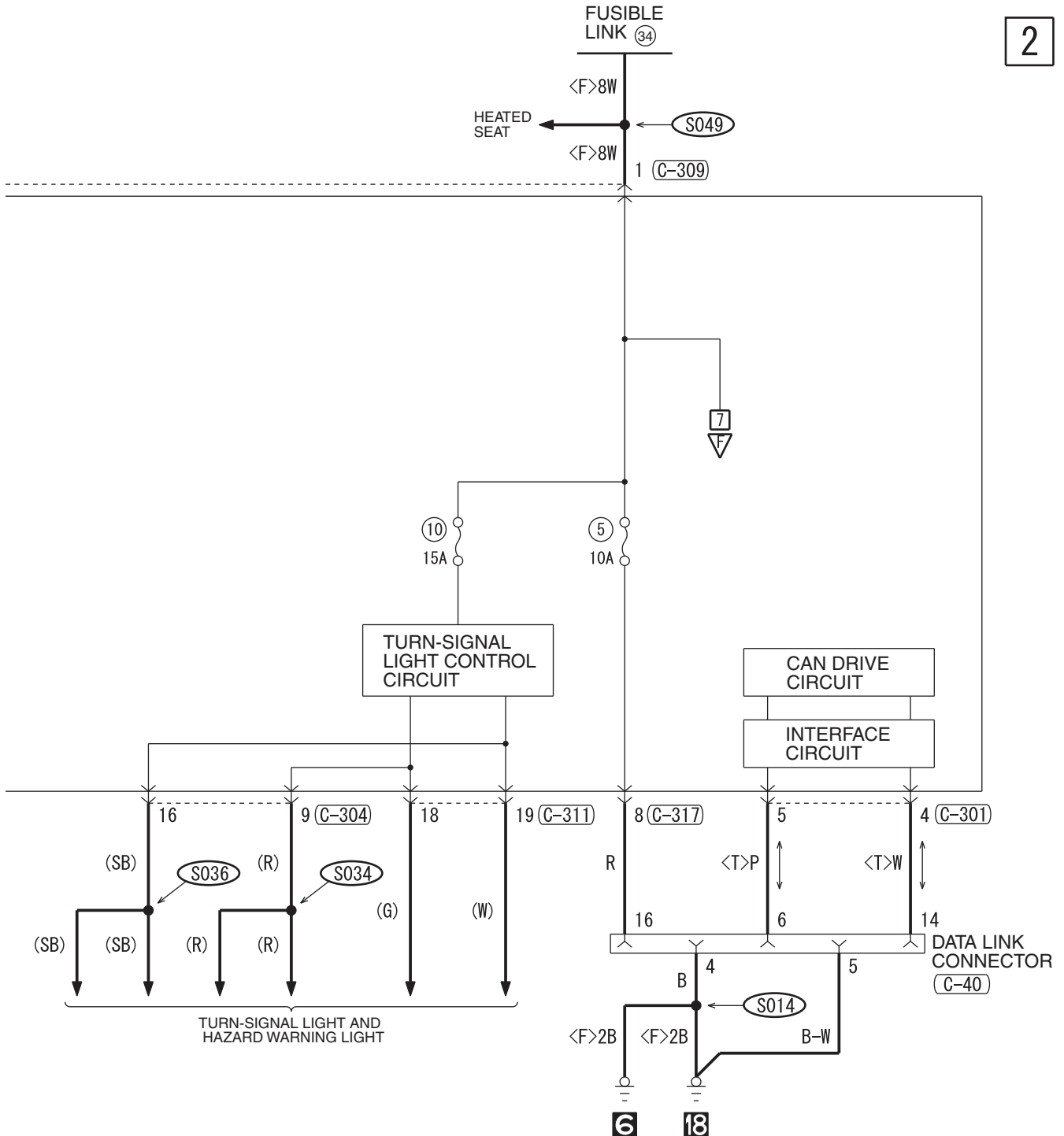

(C-317)

1	2	3	4	5	6	7	
8	9	10	11	12	13	14	15

WIRE COLOR CODE

B : BLACK LG : LIGHT GREEN G : GREEN L : BLUE W : WHITE Y : YELLOW SB : SKY BLUE  
BR : BROWN O : ORANGE GR : GRAY R : RED P : PINK V : VIOLET PU : PURPLE SI : SILVER

HAH11M05AB

TSB Revision

CENTRAL DOOR LOCKING SYSTEM (CONTINUED)

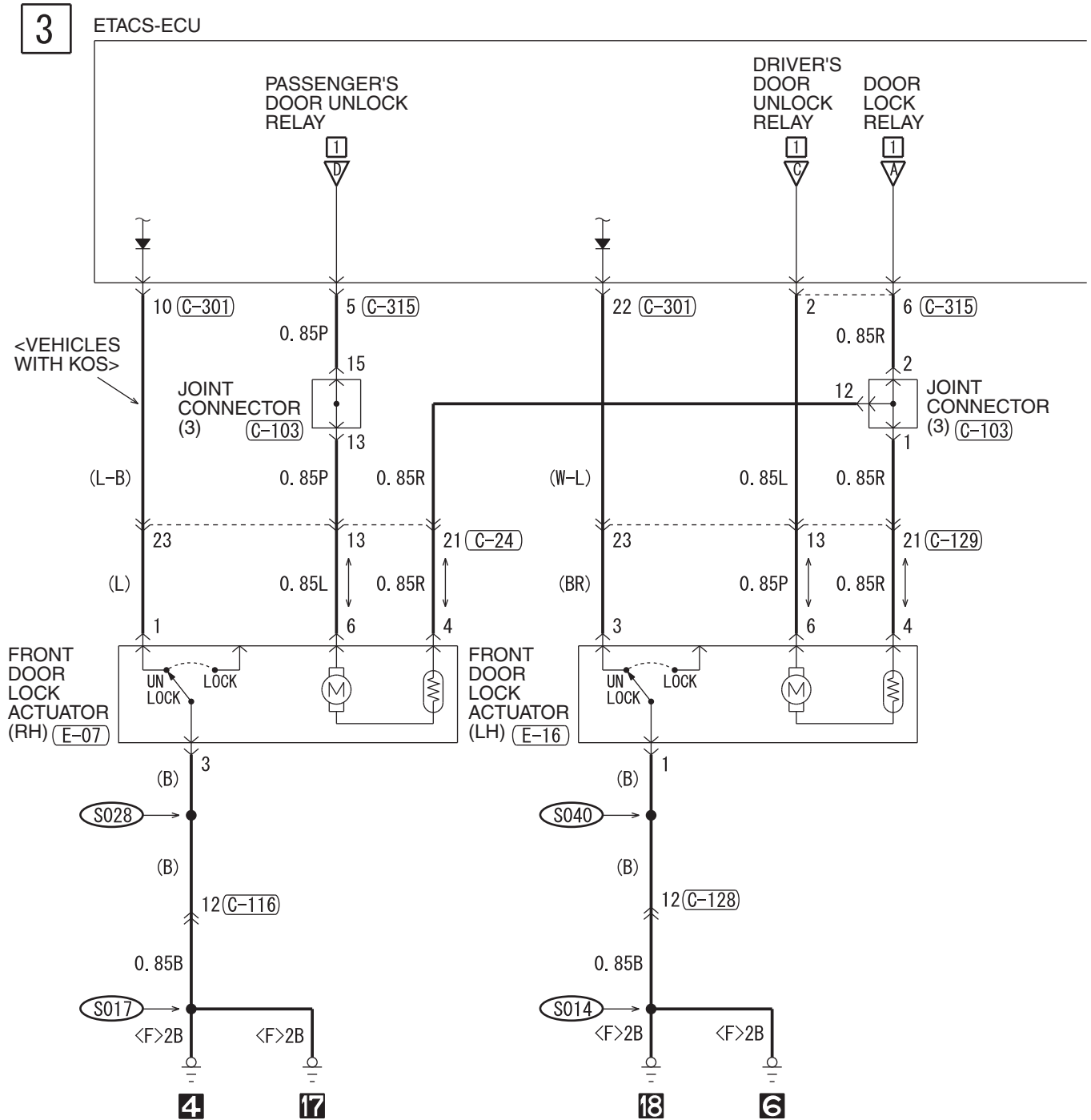

C-24

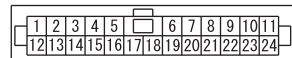

C-43

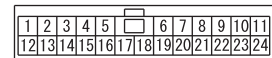

C-103

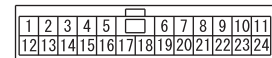

C-116

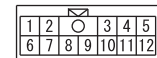

C-128

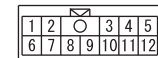

D-24

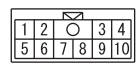

E-07



E-16



E-19



E-26



4

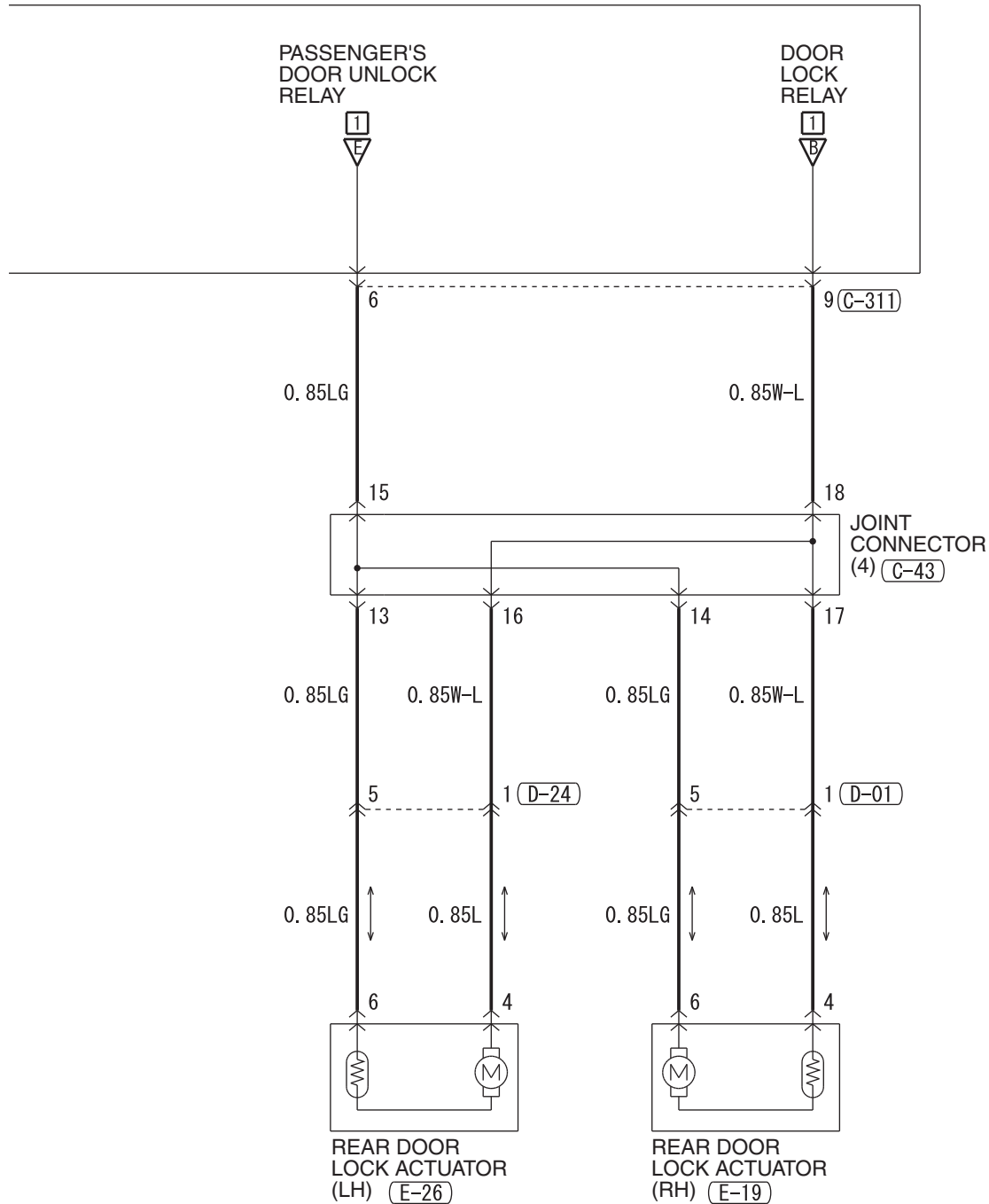

(C-129)

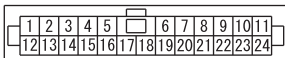

(C-301)

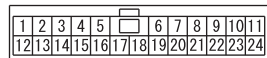

(C-311)

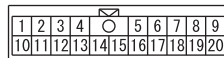

(C-315)

MU801890

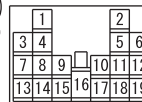

(D-01)

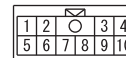

WIRE COLOR CODE

B: BLACK LG: LIGHT GREEN G: GREEN L: BLUE W: WHITE Y: YELLOW SB: SKY BLUE  
BR: BROWN O: ORANGE GR: GRAY R: RED P: PINK V: VIOLET PU: PURPLE SI: SILVER

HAH11M05BB

TSB Revision

CENTRAL DOOR LOCKING SYSTEM (CONTINUED)

5

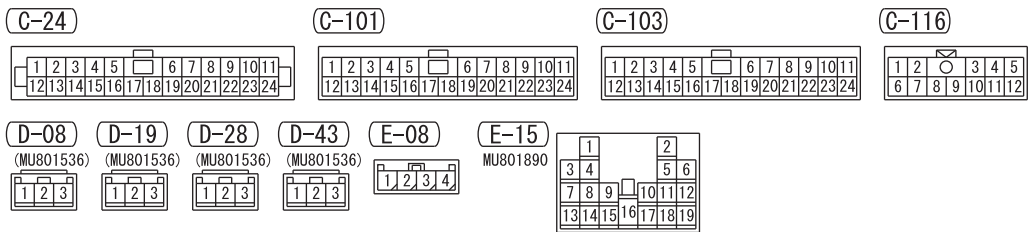
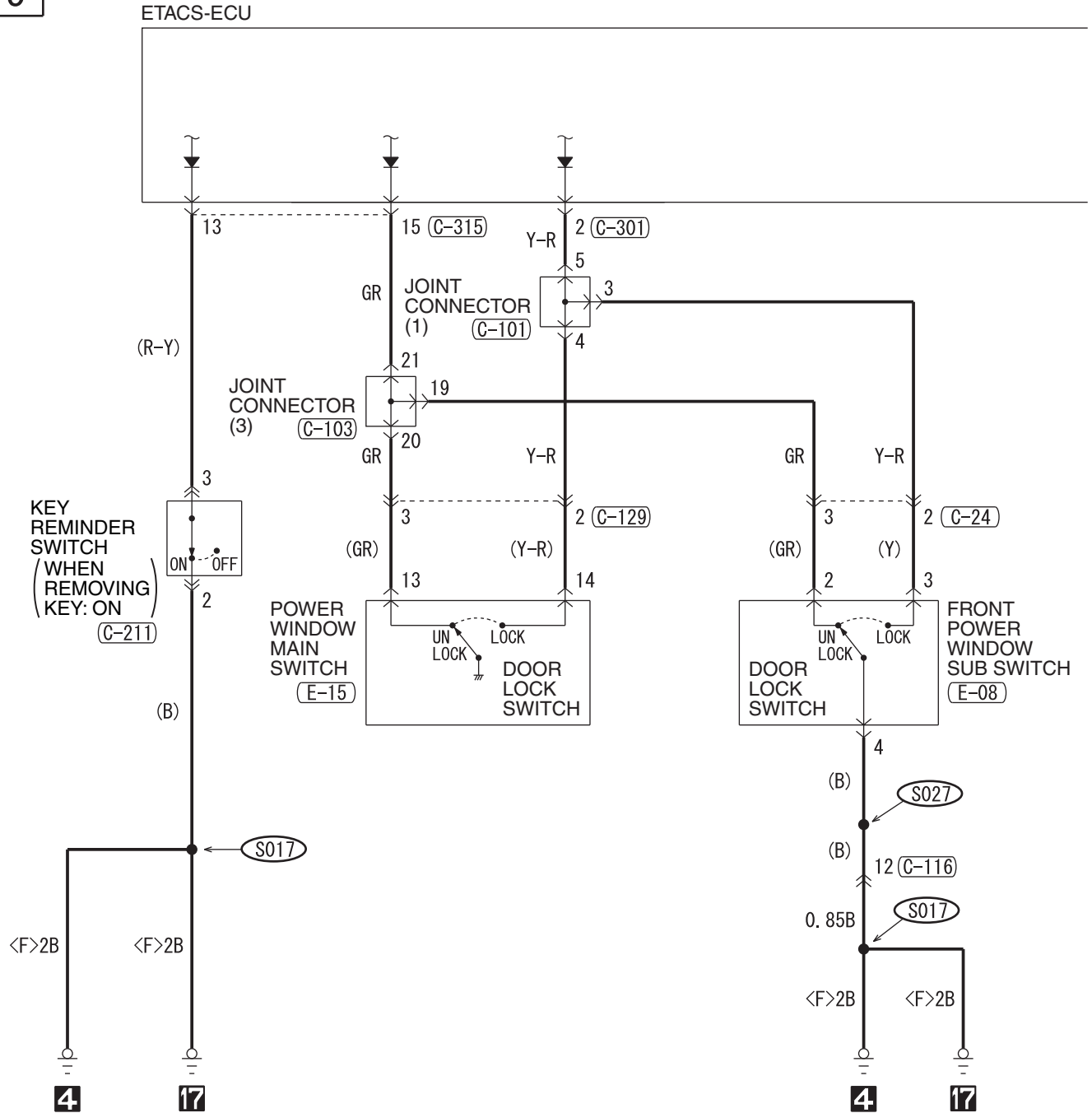

6

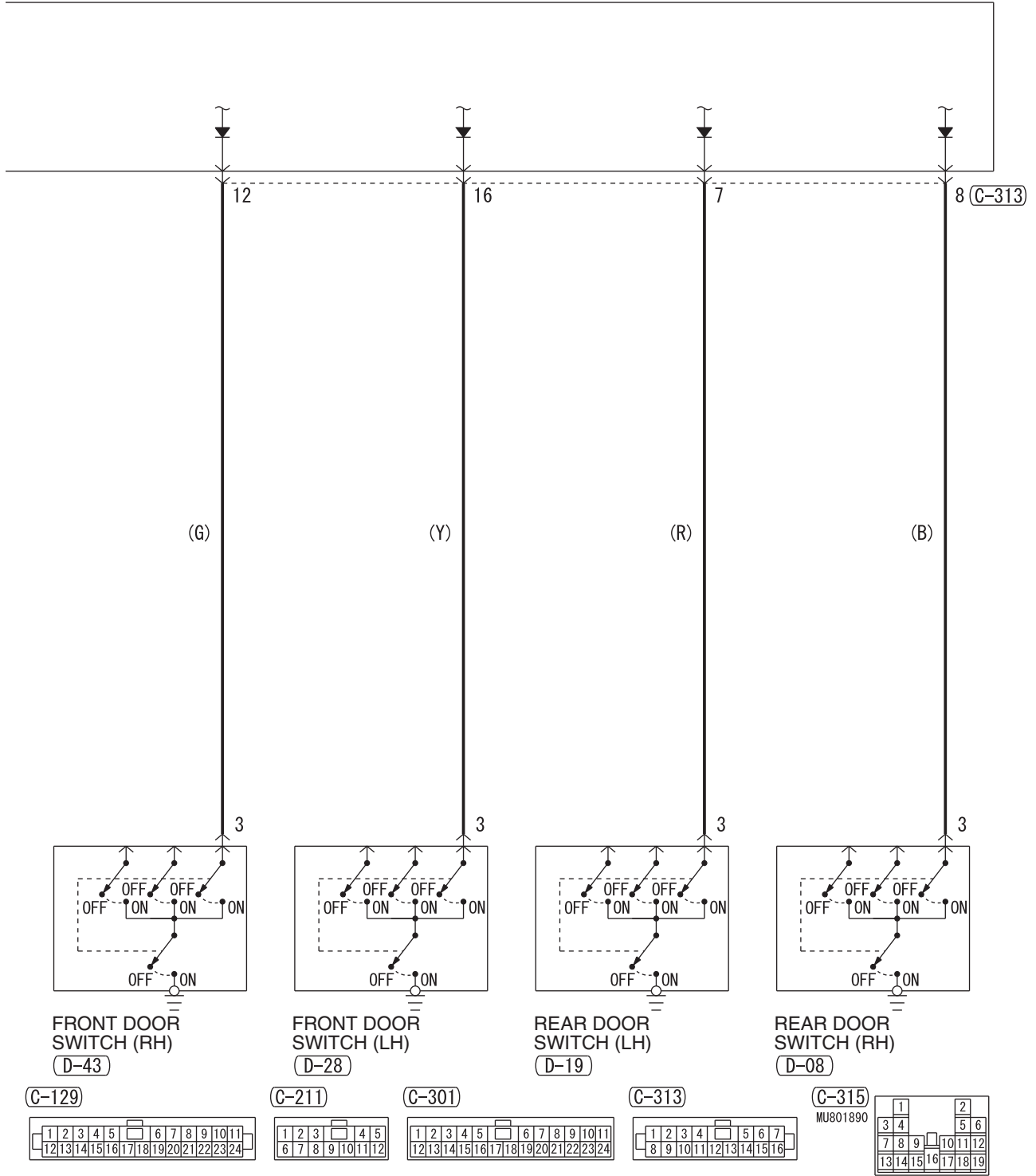

WIRE COLOR CODE  
 B : BLACK LG : LIGHT GREEN G : GREEN L : BLUE W : WHITE Y : YELLOW SB : SKY BLUE  
 BR : BROWN O : ORANGE GR : GRAY R : RED P : PINK V : VIOLET PU : PURPLE SI : SILVER

HAH11M05CB

TSB Revision

CENTRAL DOOR LOCKING SYSTEM (CONTINUED)

7

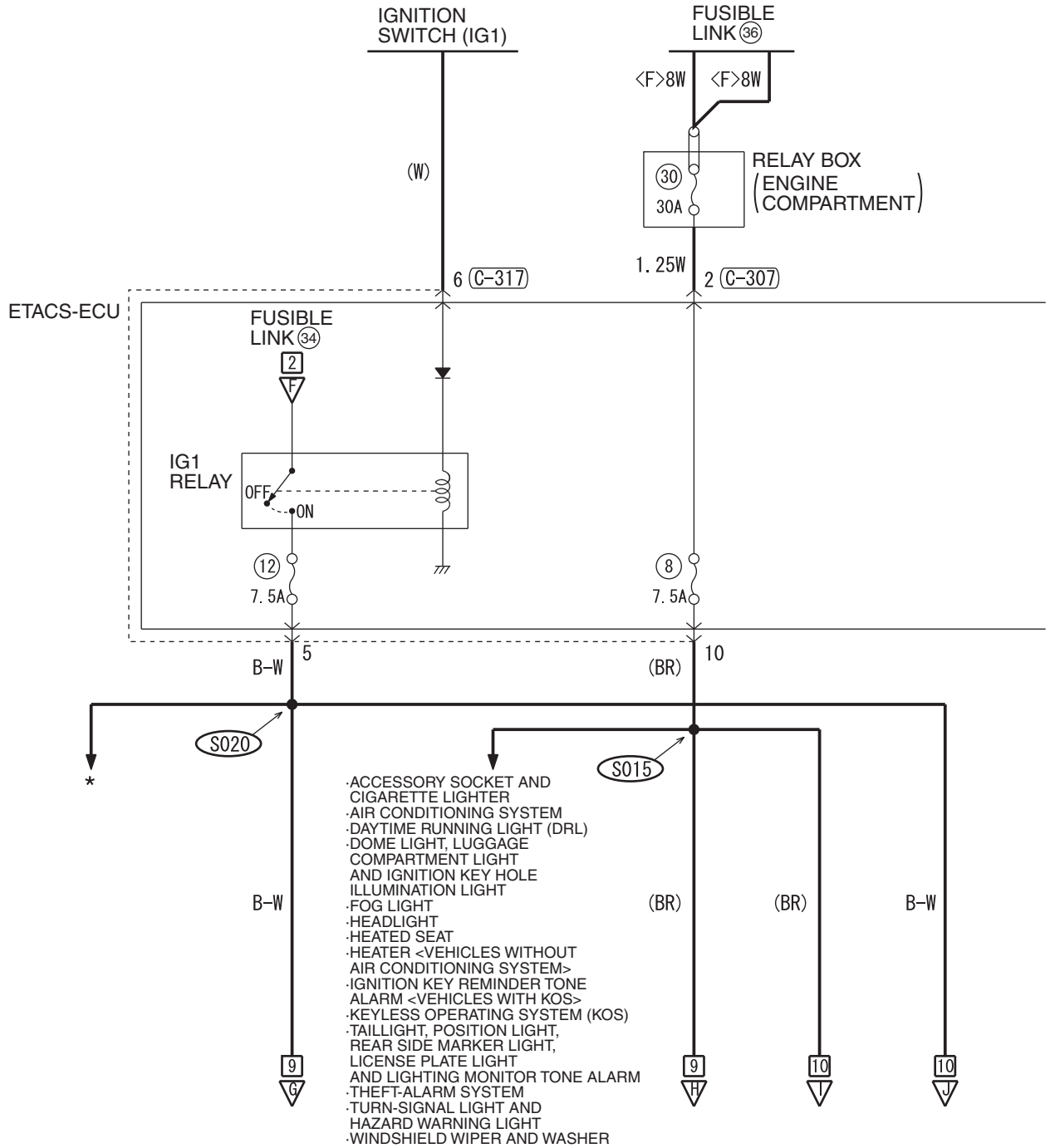

(C-105)

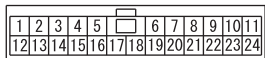

(C-301)

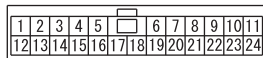

(C-307)



(C-317)

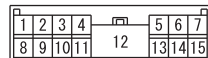



**NOTE**

- \* : ABS, ASC, ACD, AYC AND S-AWC
- AIR CONDITIONING SYSTEM
- BRAKE WARNING LIGHT
- FUEL WARNING LIGHT AND OIL PRESSURE WARNING LIGHT
- CHARGING SYSTEM
- COOLING SYSTEM
- CRUISE CONTROL SYSTEM
- DAYTIME RUNNING LIGHT (DRL)
- DOOR AJAR WARNING TONE ALARM
- FOG LIGHT
- HANDS-FREE CELLULAR PHONE SYSTEM
- HEADLIGHT
- HEATED DOOR MIRROR
- HEATED SEAT
- HEATER <VEHICLES WITHOUT AIR CONDITIONING SYSTEM>
- METER AND GAUGE
- MFI SYSTEM
- PARKING BRAKE WARNING TONE ALARM
- REAR WINDOW DEFOGGER
- SEAT BELT WARNING TONE ALARM
- SHIFT LOCK MECHANISM
- SUNROOF
- SUPPLEMENTAL RESTRAINT SYSTEM (SRS)
- TAILLIGHT, POSITION LIGHT, REAR SIDE MARKER LIGHT, LICENSE PLATE LIGHT AND LIGHTING MONITOR TONE ALARM
- TIRE PRESSURE MONITORING SYSTEM (TPMS)
- TURN-SIGNAL LIGHT AND HAZARD WARNING LIGHT
- TWIN CLUTCH-SPORTRONIC SHIFT TRANSMISSION (TC-SST)
- WINDSHIELD WIPER AND WASHER

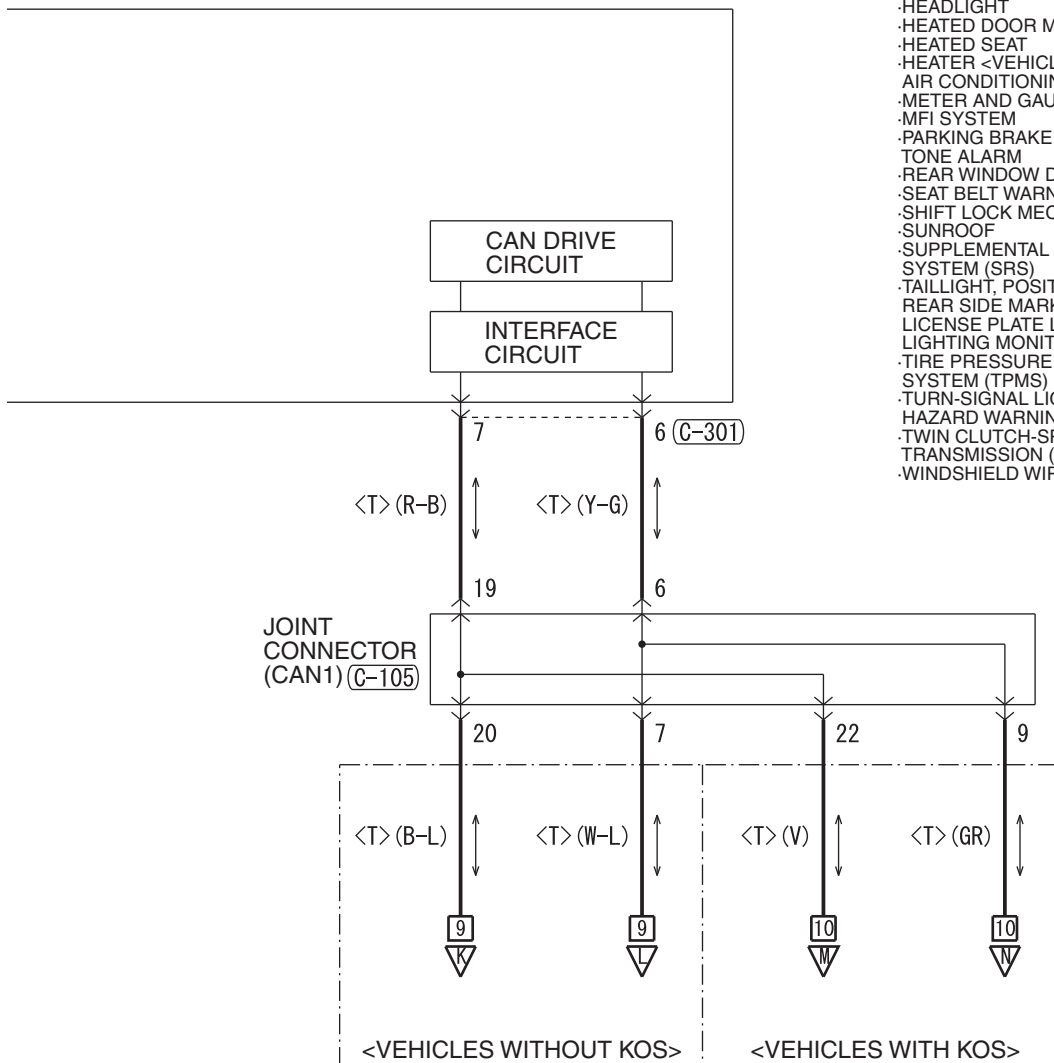

**WIRE COLOR CODE**

B : BLACK   LG : LIGHT GREEN   G : GREEN   L : BLUE   W : WHITE   Y : YELLOW   SB : SKY BLUE  
BR : BROWN   O : ORANGE   GR : GRAY   R : RED   P : PINK   V : VIOLET   PU : PURPLE   SI : SILVER

HAH11M05DB

CENTRAL DOOR LOCKING SYSTEM (CONTINUED)

9

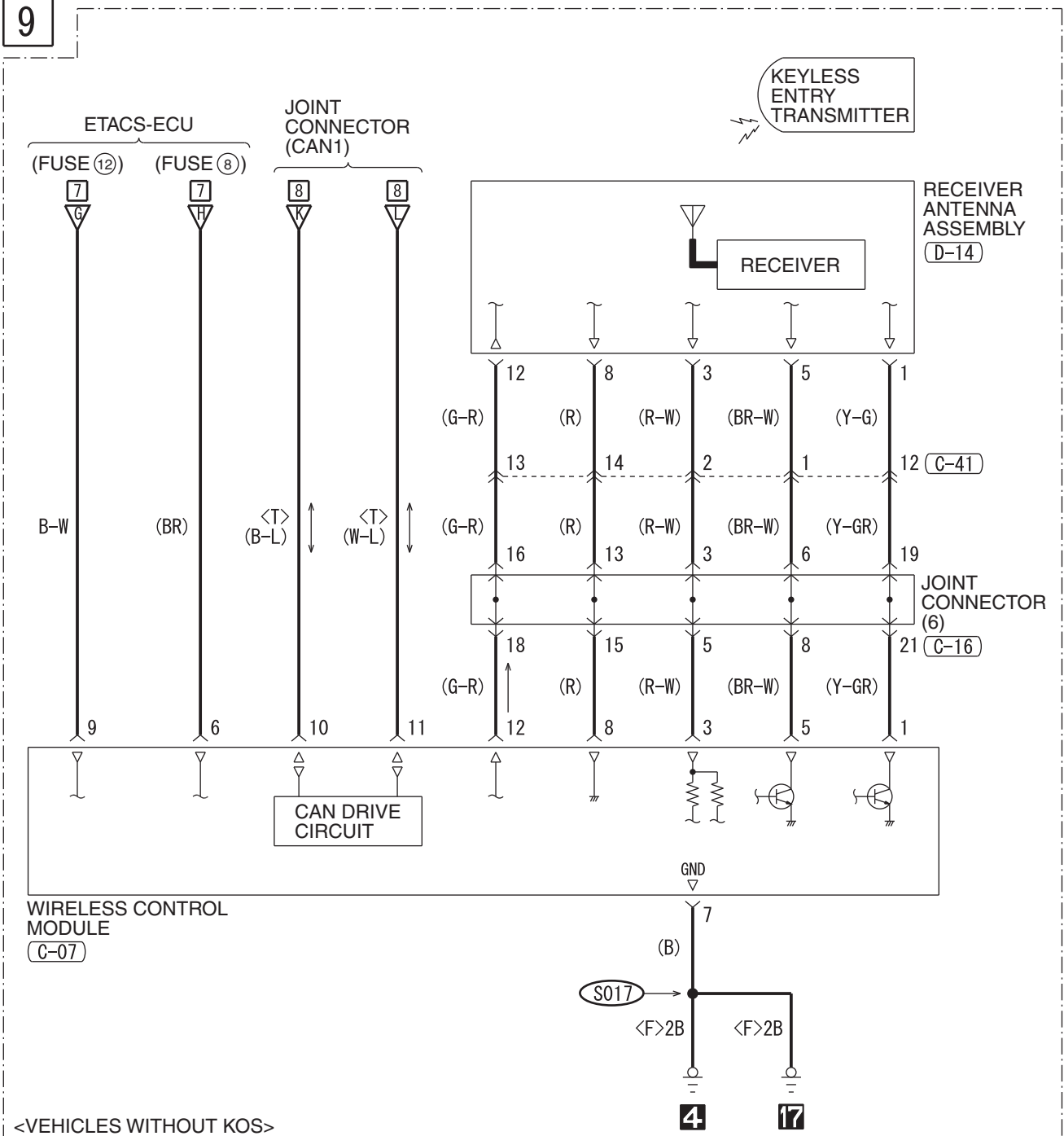

<VEHICLES WITHOUT KOS>

(C-05)

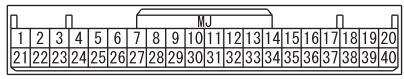

(C-07)

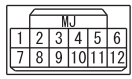

(C-16)

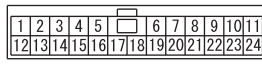

(C-41)

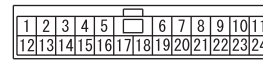

(D-14)

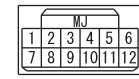

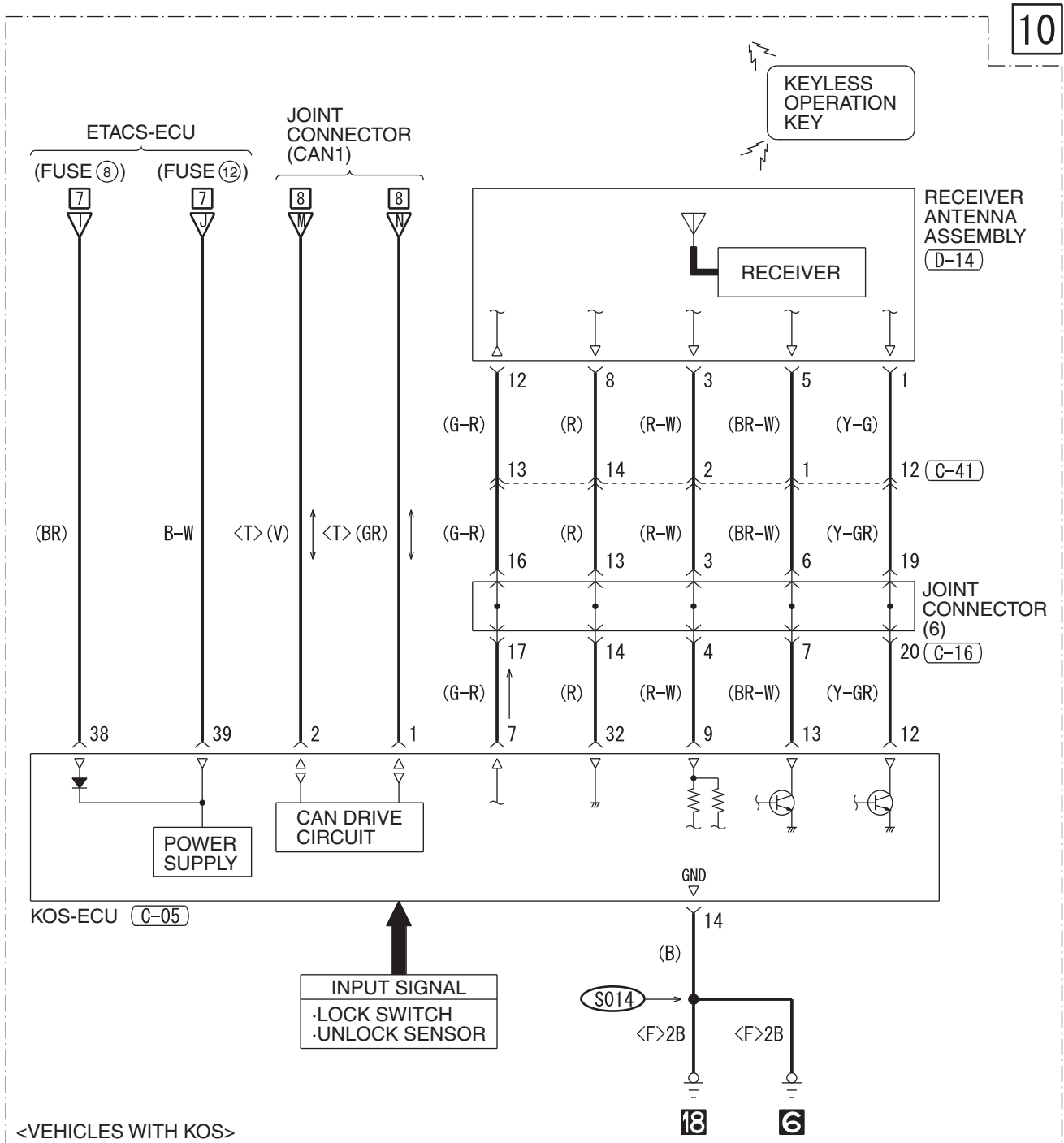

**WIRE COLOR CODE**  
 B: BLACK LG: LIGHT GREEN G: GREEN L: BLUE W: WHITE Y: YELLOW SB: SKY BLUE  
 BR: BROWN O: ORANGE GR: GRAY R: RED P: PINK V: VIOLET PU: PURPLE SI: SILVER

HAH11M05EB

**TSB Revision**

CENTRAL DOOR LOCKING SYSTEM (CONTINUED)

11

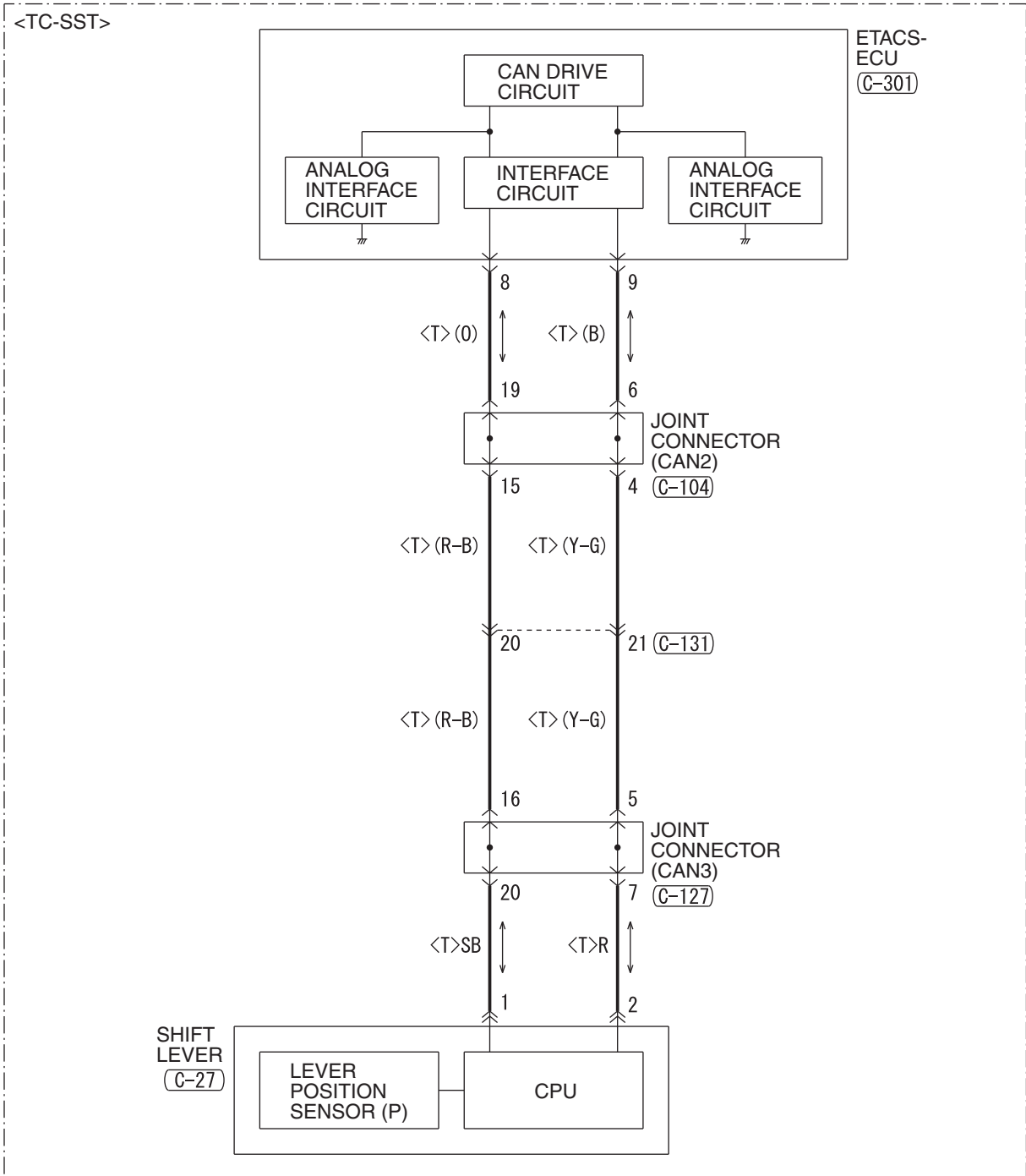

(C-27)

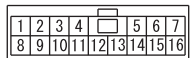

(C-104)

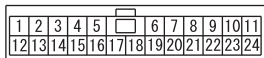

(C-127)

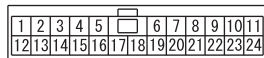

(C-131)

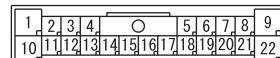

(C-301)

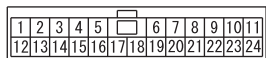

WIRE COLOR CODE

B: BLACK LG: LIGHT GREEN G: GREEN L: BLUE W: WHITE  
Y: YELLOW SB: SKY BLUE BR: BROWN O: ORANGE GR: GRAY  
R: RED P: PINK V: VIOLET PU: PURPLE SI: SILVER

HAH11M05FA

NOTES

# KEYLESS OPERATING SYSTEM (KOS)

M1901025501188

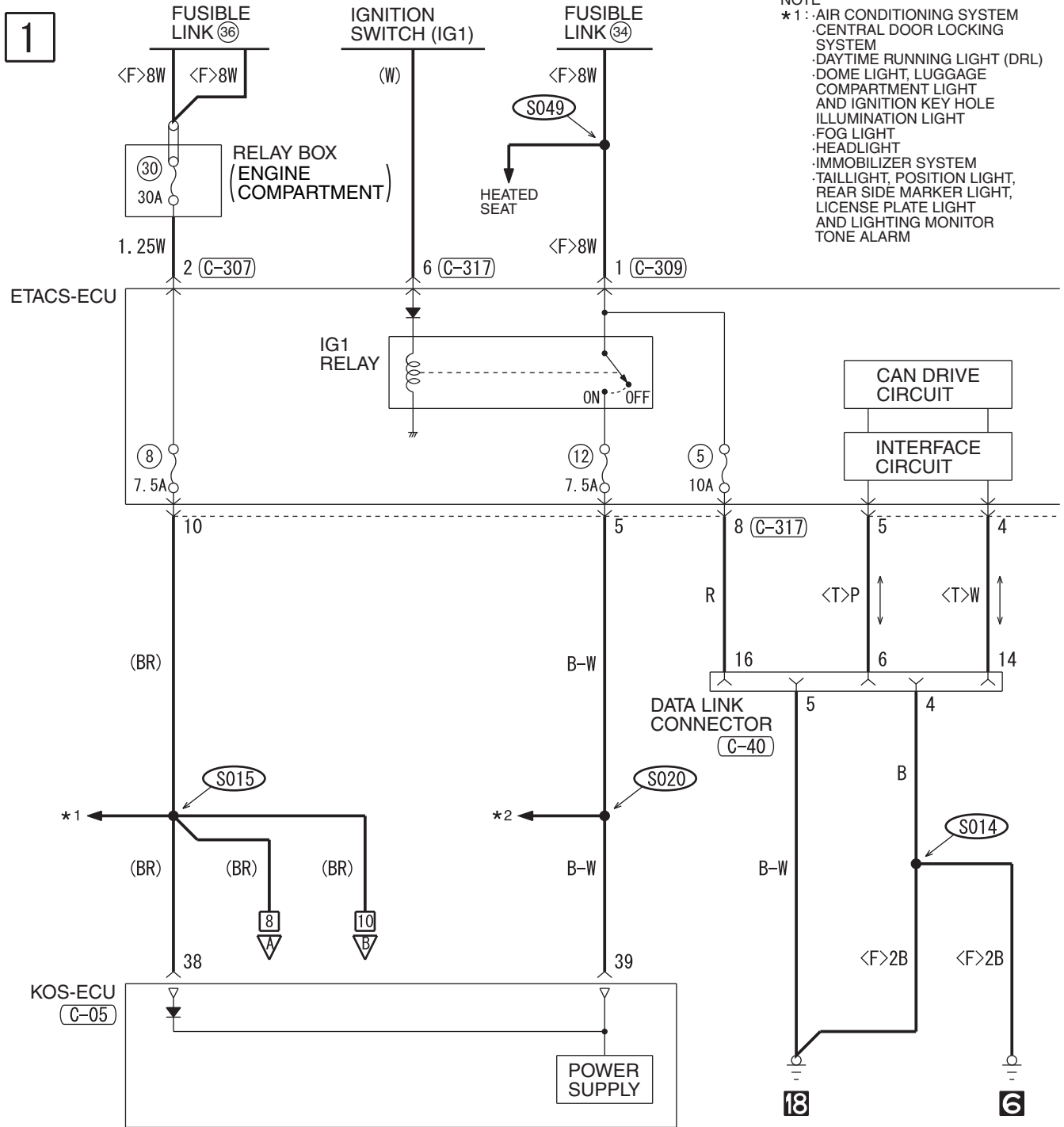

**NOTE**

- \*1 : AIR CONDITIONING SYSTEM
- CENTRAL DOOR LOCKING SYSTEM
- DAYTIME RUNNING LIGHT (DRL)
- DOME LIGHT, LUGGAGE COMPARTMENT LIGHT AND IGNITION KEY HOLE ILLUMINATION LIGHT
- FOG LIGHT
- HEADLIGHT
- IMMOBILIZER SYSTEM
- TAILLIGHT, POSITION LIGHT, REAR SIDE MARKER LIGHT, LICENSE PLATE LIGHT AND LIGHTING MONITOR TONE ALARM

(A-05)

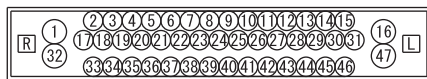

(A-13)

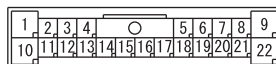

(A-14)

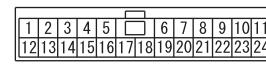

(C-104)

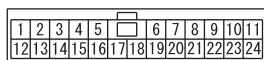

(C-127)

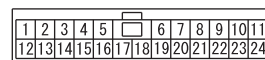

(C-131)

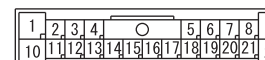

(C-301)

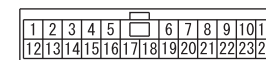

(C-307)



MU801325

HAH11M06AA

**2**

- THEFT-ALARM SYSTEM
- TIRE PRESSURE MONITORING SYSTEM (TPMS)
- TRUNK LID OPENER
- TURN-SIGNAL LIGHT
- AND HAZARD WARNING LIGHT
- WINDSHIELD WIPER AND WASHER

- \*2:
- ABS, ASC, ACD, AYC AND S-AWC
  - AIR CONDITIONING SYSTEM
  - BRAKE WARNING LIGHT
  - FUEL WARNING LIGHT AND OIL PRESSURE WARNING LIGHT
  - CENTRAL DOOR LOCKING SYSTEM
  - CHARGING SYSTEM
  - COOLING SYSTEM
  - CRUISE CONTROL SYSTEM
  - DAYTIME RUNNING LIGHT (DRL)
  - DOME LIGHT, LUGGAGE COMPARTMENT LIGHT AND IGNITION KEY HOLE ILLUMINATION LIGHT
  - DOOR AJAR WARNING TONE ALARM
  - FOG LIGHT
  - HANDS-FREE CELLULAR PHONE SYSTEM

- HEADLIGHT
- HEATED DOOR MIRROR
- HEATED SEAT
- IMMOBILIZER SYSTEM
- METER AND GAUGE
- MFI SYSTEM
- PARKING BRAKE REMINDER TONE ALARM
- REAR WINDOW DEFOGGER
- SEAT BELT WARNING TONE ALARM
- SHIFT LOCK MECHANISM
- SUNROOF
- SUPPLEMENTAL RESTRAINT SYSTEM (SRS)

- TAILLIGHT, POSITION LIGHT, REAR SIDE MARKER LIGHT, LICENSE PLATE LIGHT AND LIGHTING MONITOR TONE ALARM
- THEFT-ALARM SYSTEM
- TIRE PRESSURE MONITORING SYSTEM (TPMS)
- TRUNK LID OPENER
- TURN-SIGNAL LIGHT AND HAZARD WARNING LIGHT
- TWIN CLUTCH-SPORTRONIC SHIFT TRANSMISSION (TC-SST)
- WINDSHIELD WIPER AND WASHER

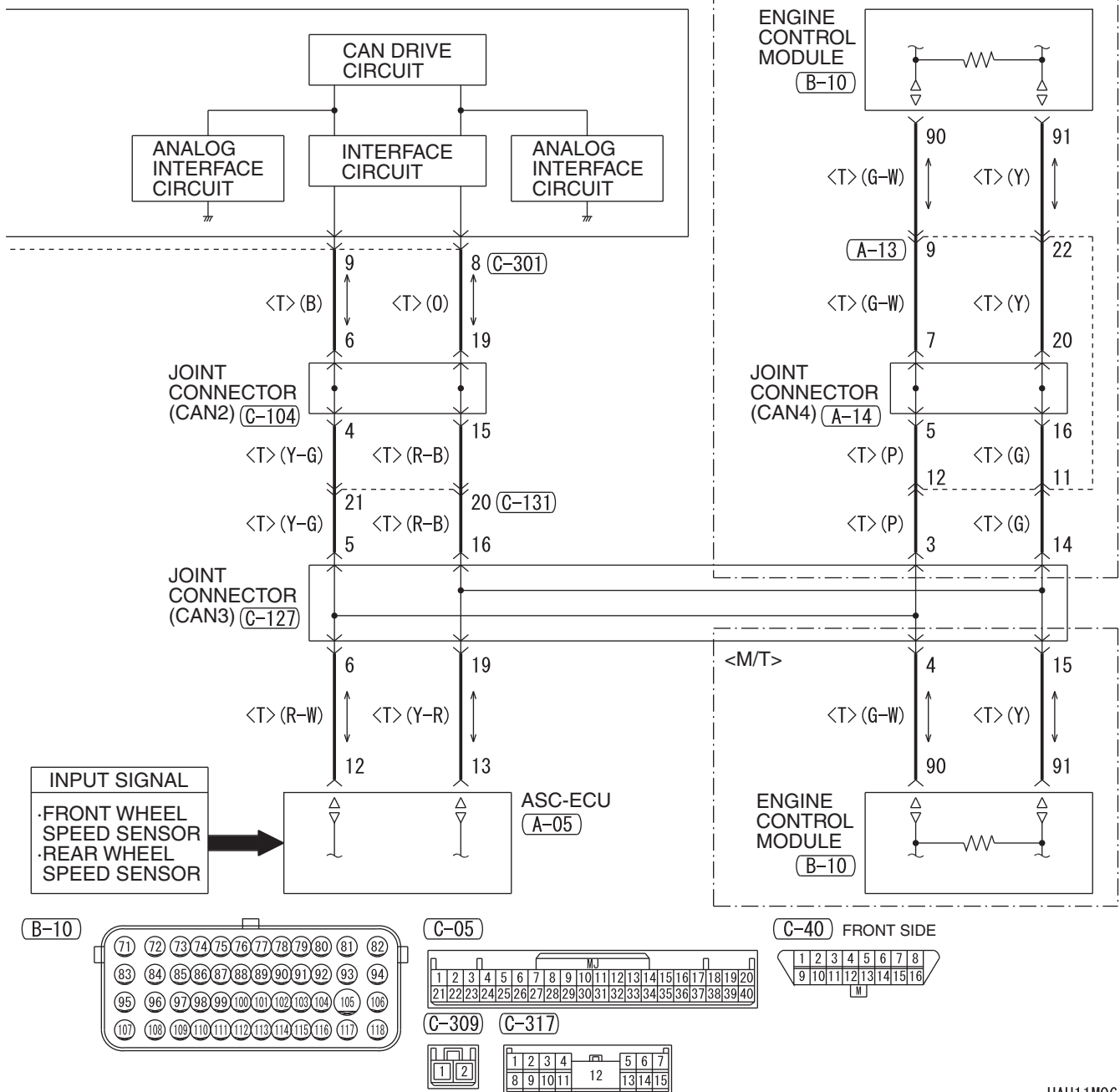

KEYLESS OPERATING SYSTEM (KOS) (CONTINUED)

3

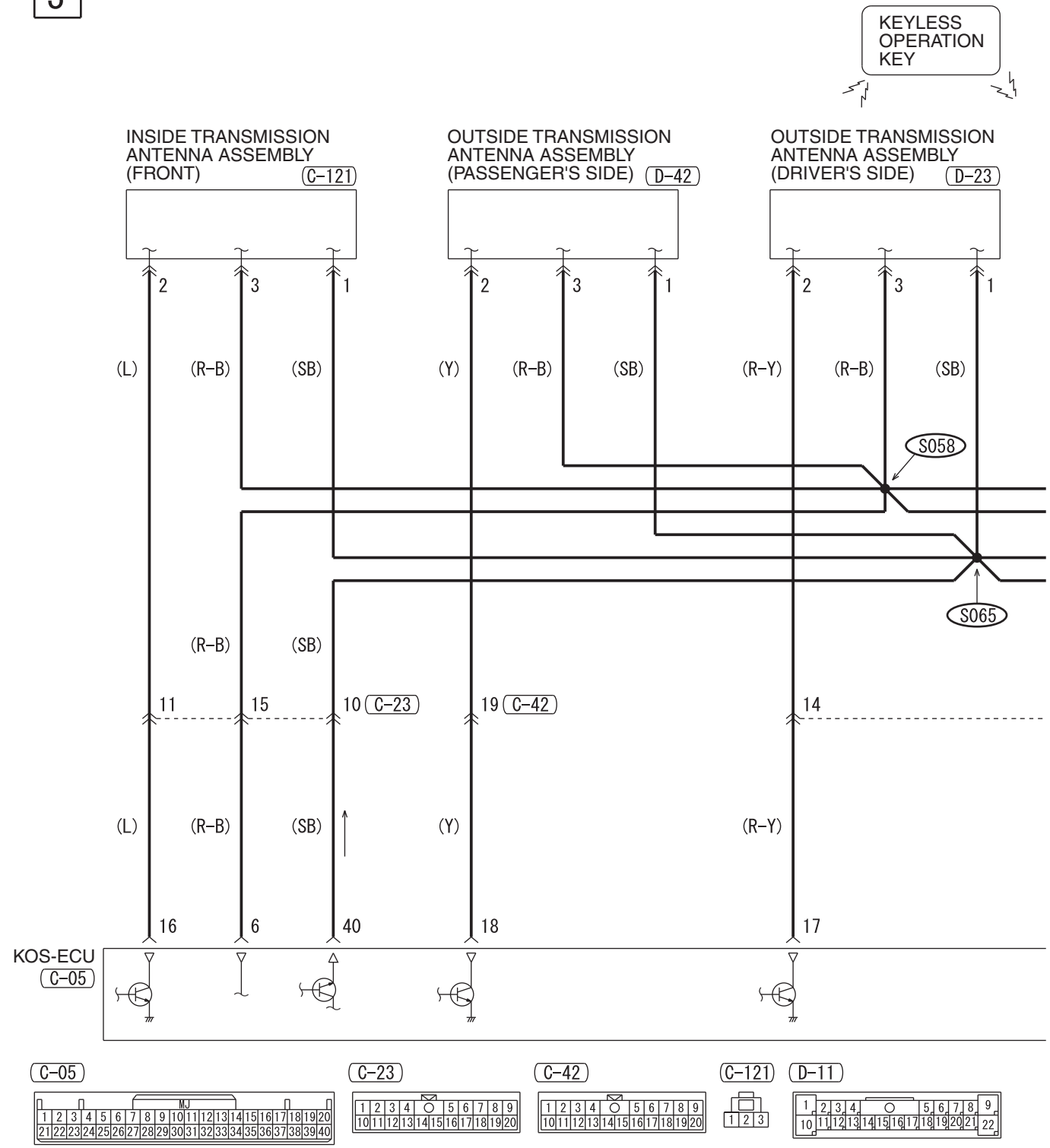



4

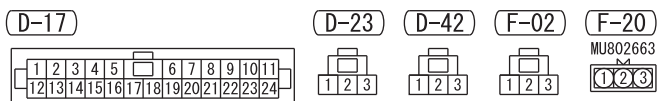
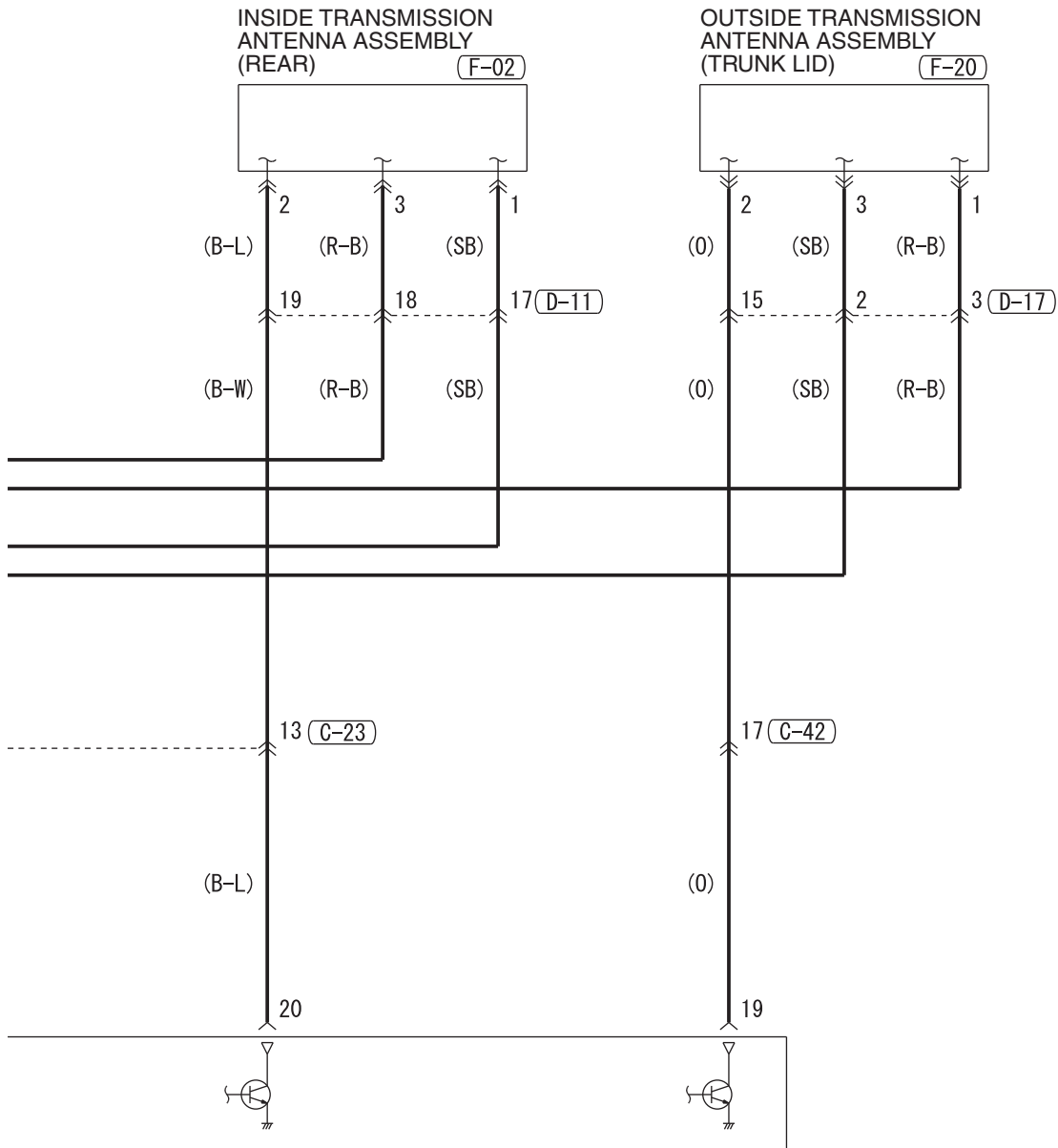

WIRE COLOR CODE  
 B : BLACK LG : LIGHT GREEN G : GREEN L : BLUE W : WHITE Y : YELLOW SB : SKY BLUE  
 BR : BROWN O : ORANGE GR : GRAY R : RED P : PINK V : VIOLET PU : PURPLE SI : SILVER

HAH11M06BB

KEYLESS OPERATING SYSTEM (KOS) (CONTINUED)

5

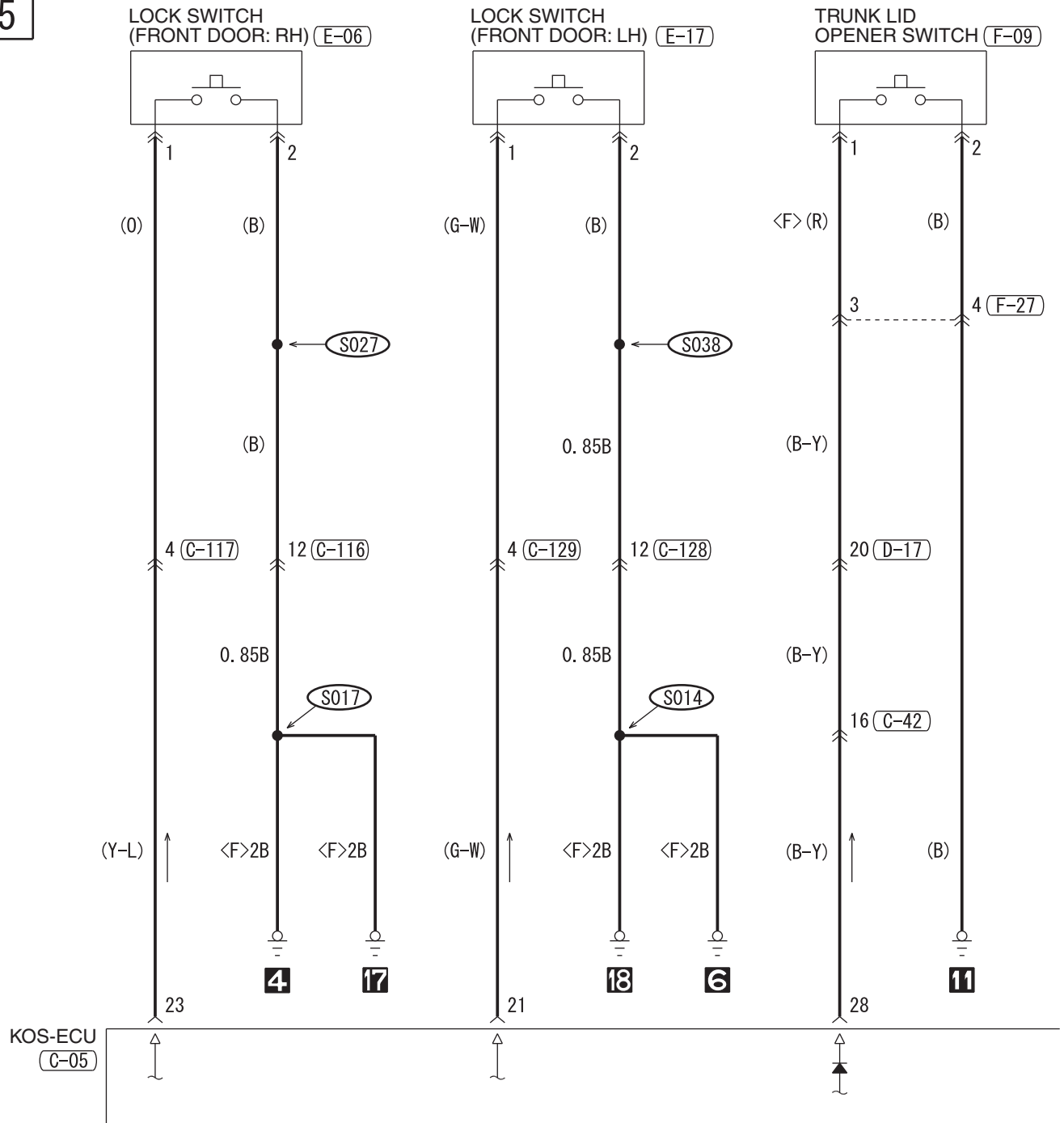

(C-05)

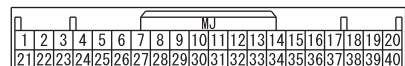

(C-42)

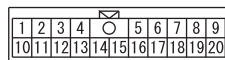

(C-101)

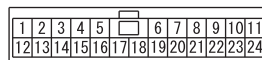

(C-116)

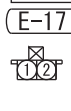
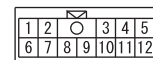

(E-18)



(F-27)

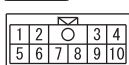



KEYLESS OPERATING SYSTEM (KOS) (CONTINUED)

7

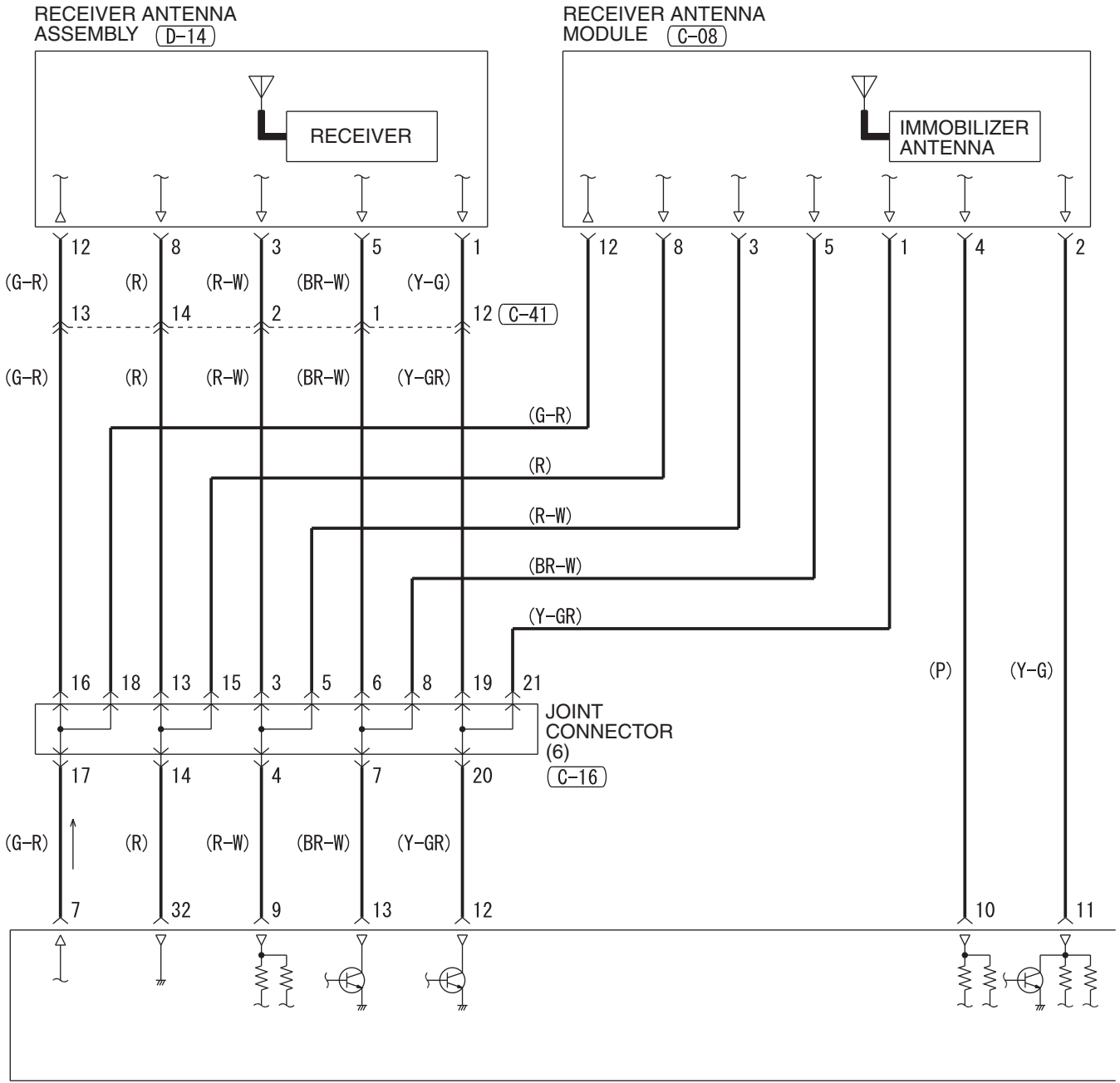

KOS-ECU (C-05)

(C-04)

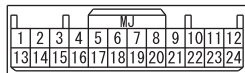

(C-05)

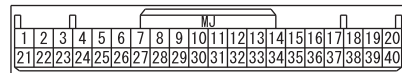

(C-08)

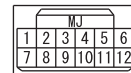

(C-16)

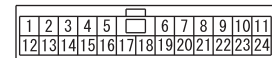

(D-14)

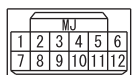

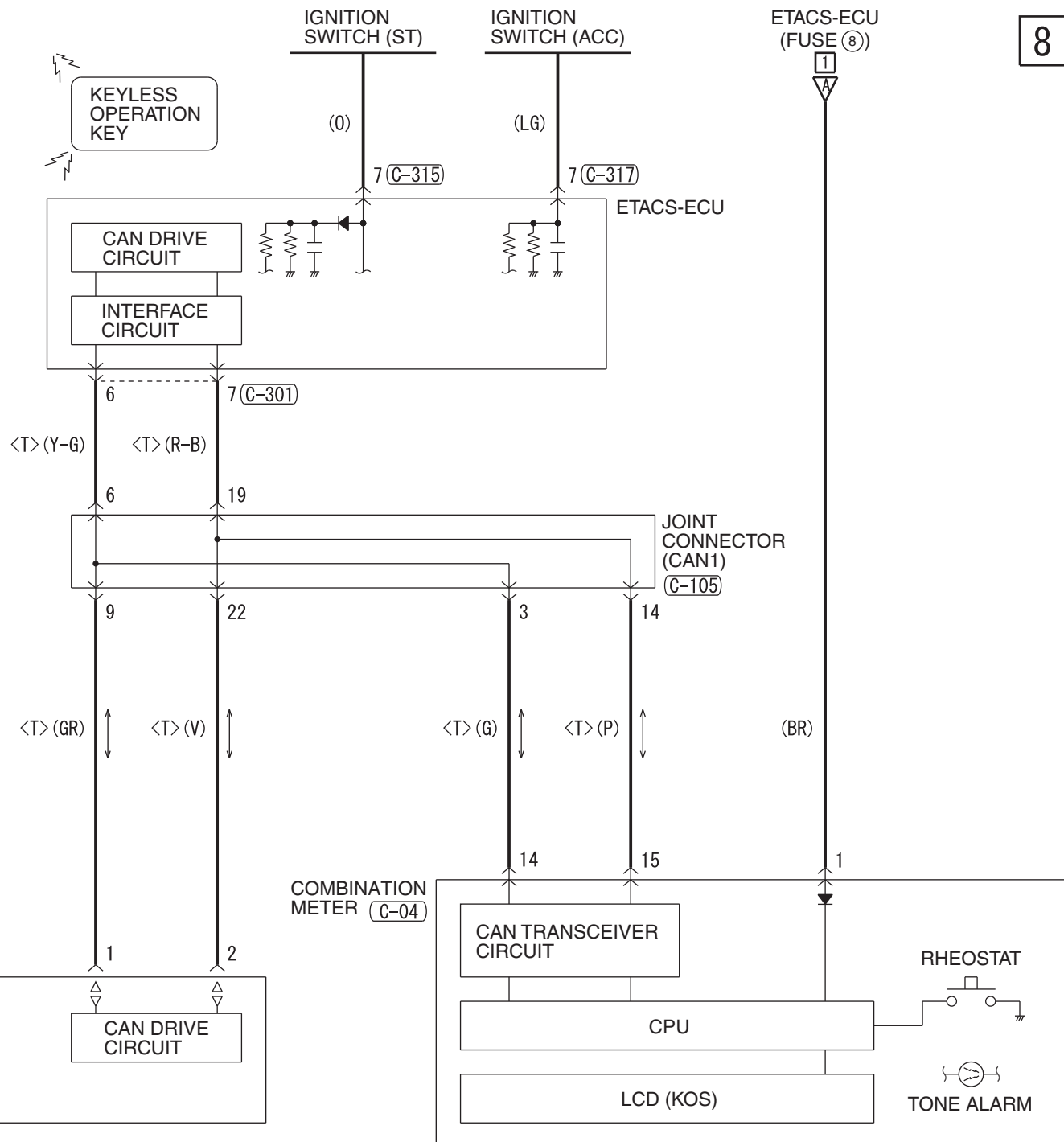

8

(C-41)

1	2	3	4	5	6	7	8	9	10	11		
12	13	14	15	16	17	18	19	20	21	22	23	24

(C-105)

1	2	3	4	5	6	7	8	9	10	11		
12	13	14	15	16	17	18	19	20	21	22	23	24

(C-301)

1	2	3	4	5	6	7	8	9	10	11		
12	13	14	15	16	17	18	19	20	21	22	23	24

(C-315)

MU801890

1	2
3	4
5	6
7	8
9	10
11	12
13	14
15	16
17	18
19	

(C-317)

1	2	3	4	5	6	7
8	9	10	11	12		

WIRE COLOR CODE

B: BLACK LG: LIGHT GREEN G: GREEN L: BLUE W: WHITE Y: YELLOW SB: SKY BLUE  
BR: BROWN O: ORANGE GR: GRAY R: RED P: PINK V: VIOLET PU: PURPLE SI: SILVER

HAH11M06DB

KEYLESS OPERATING SYSTEM (KOS) (CONTINUED)

9

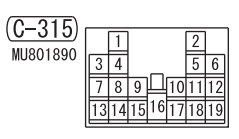
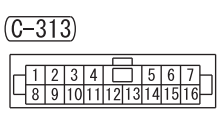
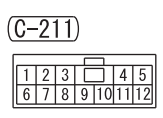
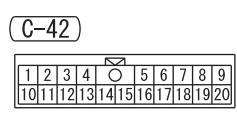
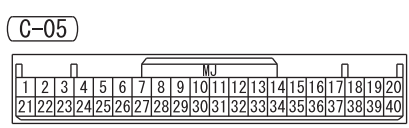
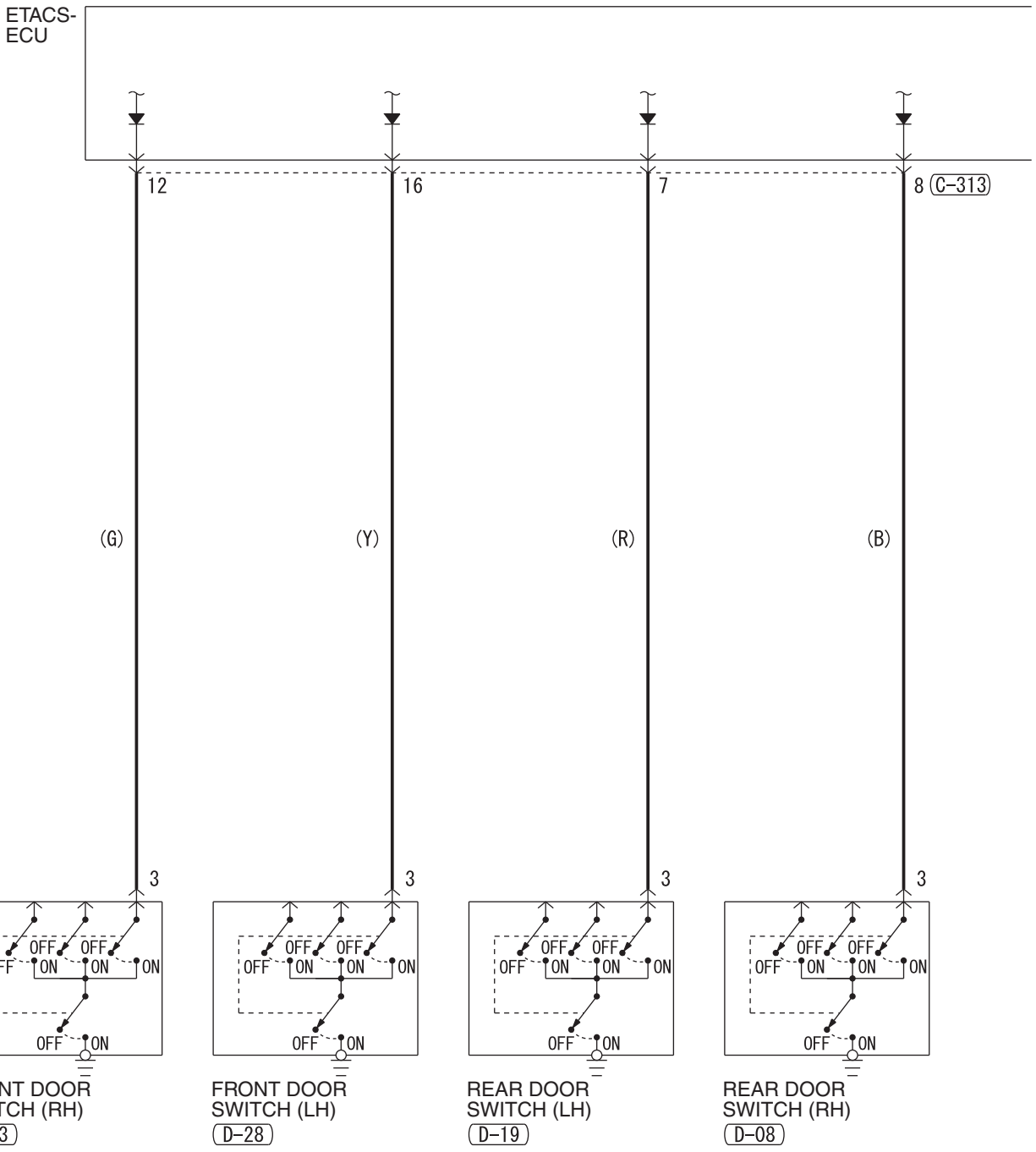

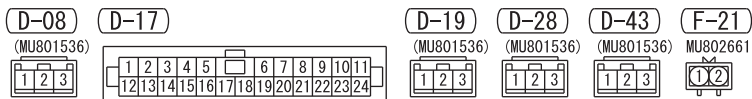
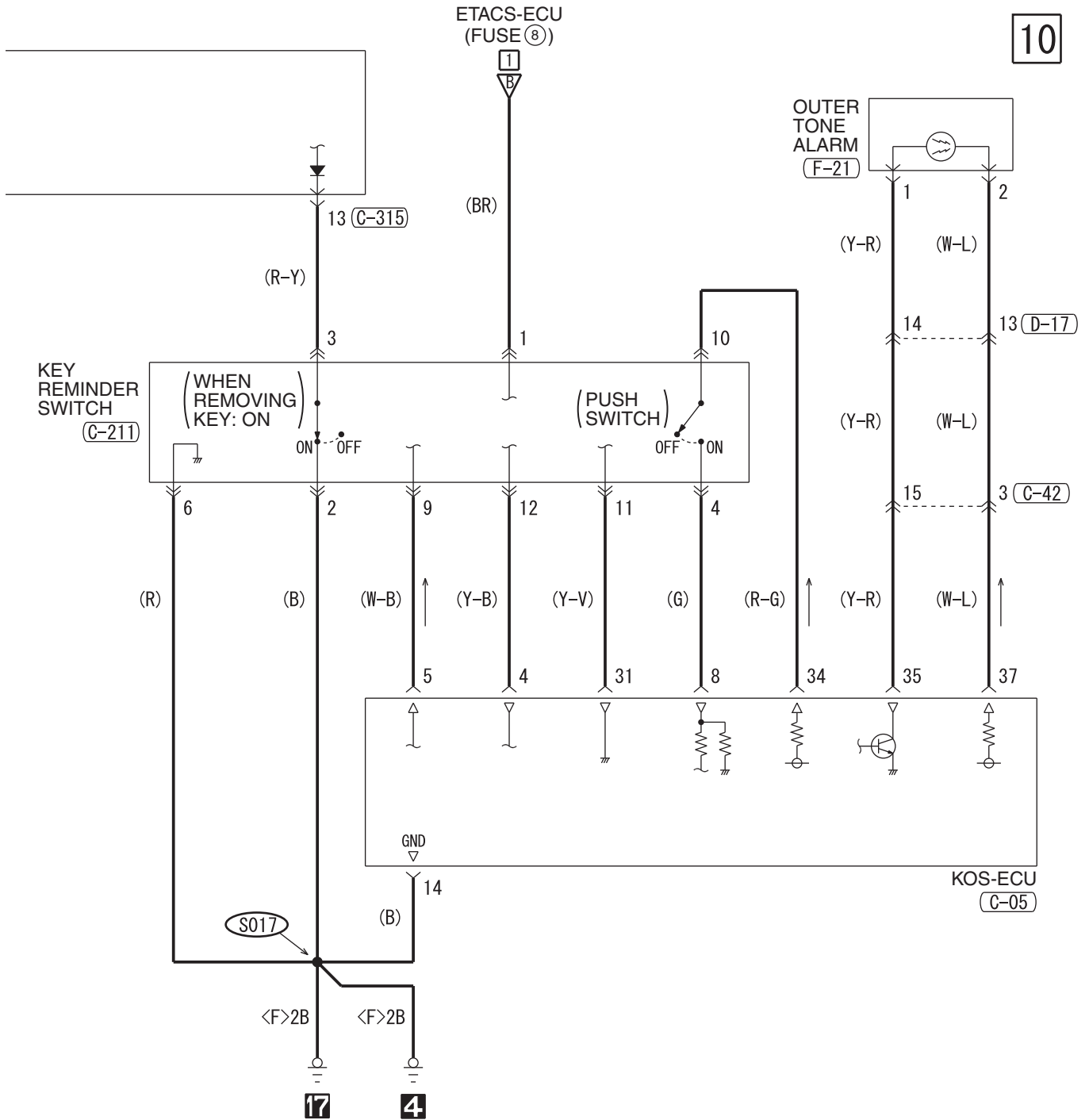

WIRE COLOR CODE  
 B: BLACK LG: LIGHT GREEN G: GREEN L: BLUE W: WHITE Y: YELLOW SB: SKY BLUE  
 BR: BROWN O: ORANGE GR: GRAY R: RED P: PINK V: VIOLET PU: PURPLE SI: SILVER

HAH11M06EB

# TRUNK LID OPENER

M1901005000553

1

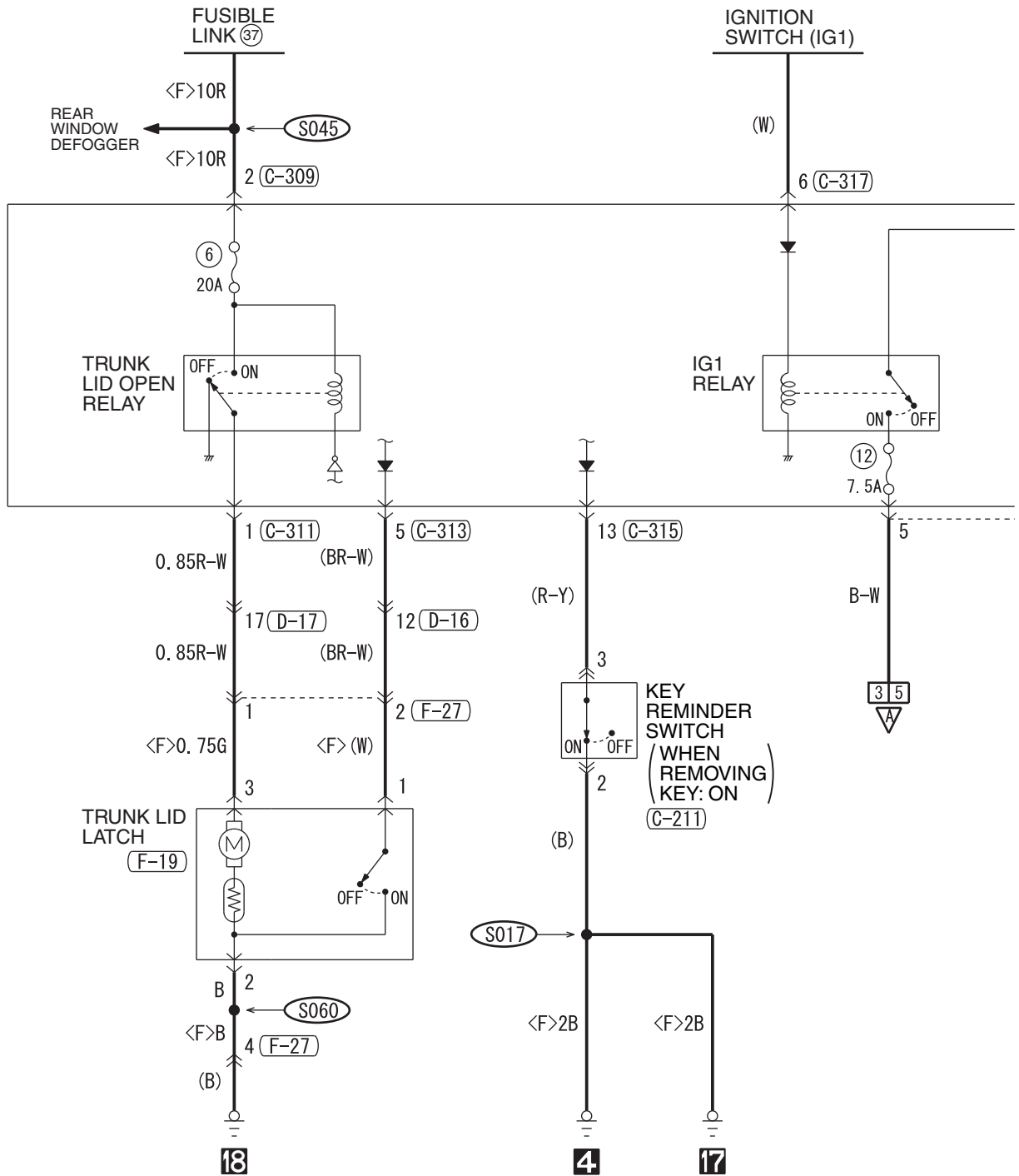

(A-05)

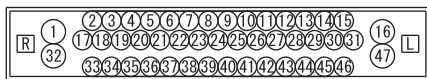

(C-40) FRONT SIDE

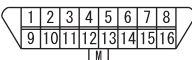

(C-104)

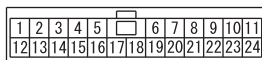

(C-127)

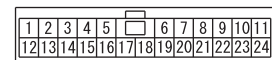

(C-315)

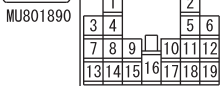

(C-317)

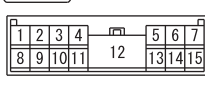

(D-16)

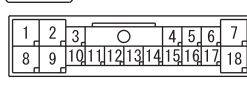

(D-17)

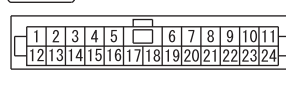

(F-19)



HAH11M07AA



2

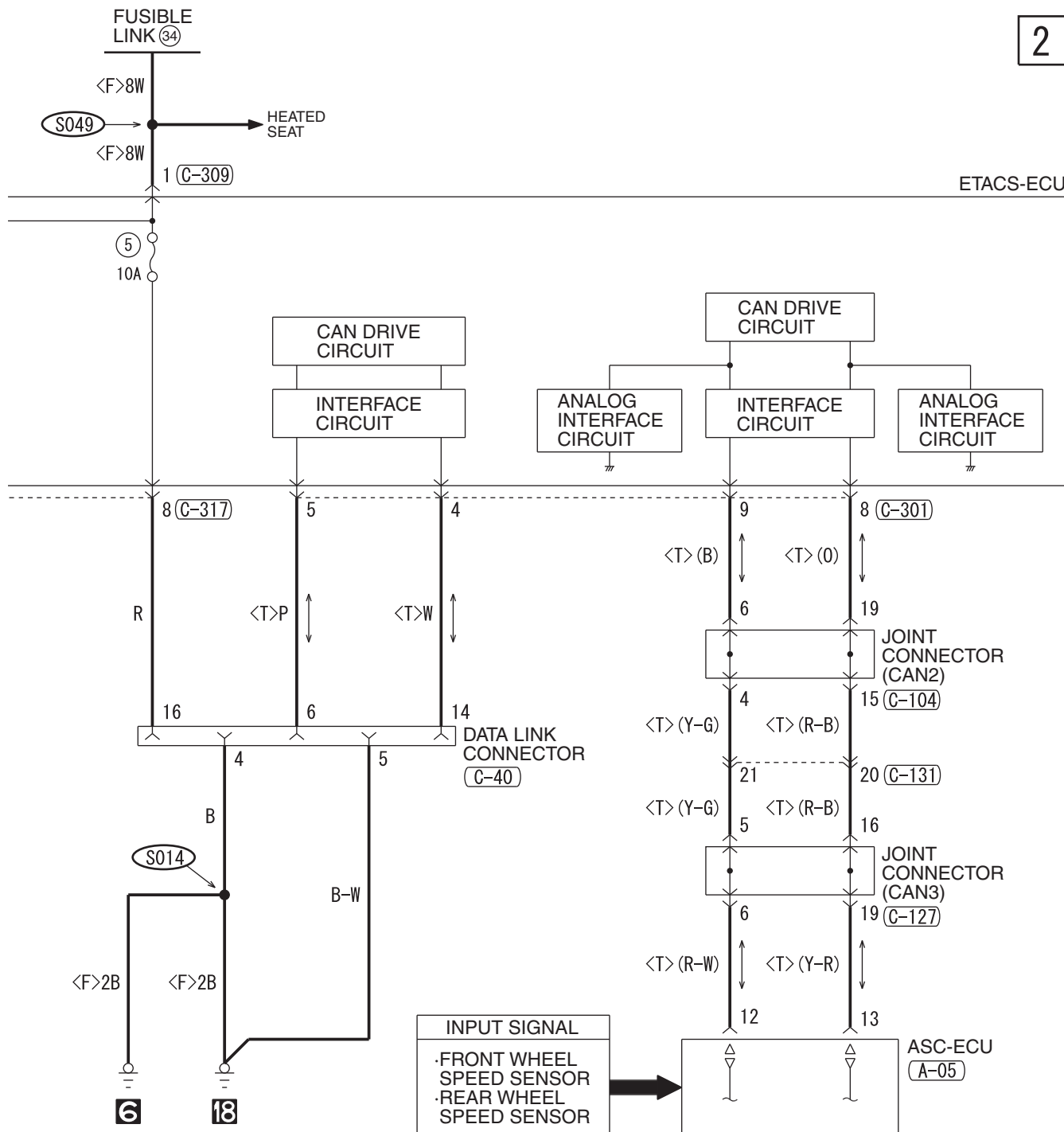

(C-131)

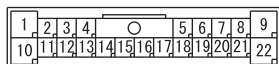

(C-211)

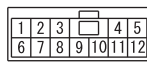

(C-301)

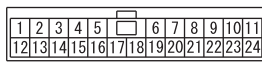

(C-309)



(C-311)

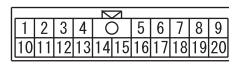

(C-313)

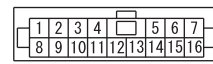

(F-27)

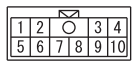

WIRE COLOR CODE

B: BLACK LG: LIGHT GREEN G: GREEN L: BLUE W: WHITE  
Y: YELLOW SB: SKY BLUE BR: BROWN O: ORANGE GR: GRAY  
R: RED P: PINK V: VIOLET PU: PURPLE SI: SILVER

HAH11M07AB

TRUNK LID OPENER (CONTINUED)

3

- ABS, ASC, ACD, AYC AND S-AWC
- AIR CONDITIONING SYSTEM
- BRAKE WARNING LIGHT, FUEL WARNING LIGHT AND OIL PRESSURE WARNING LIGHT
- CENTRAL DOOR LOCKING SYSTEM
- CHARGING SYSTEM
- COOLING SYSTEM
- CRUISE CONTROL SYSTEM
- DAYTIME RUNNING LIGHT (DRL)
- DOME LIGHT, LUGGAGE COMPARTMENT LIGHT AND IGNITION KEY HOLE ILLUMINATION LIGHT
- DOOR AJAR WARNING TONE ALARM
- FOG LIGHT
- HANDS-FREE CELLULAR PHONE SYSTEM
- HEADLIGHT
- HEATED DOOR MIRROR
- HEATED SEAT
- HEATER <VEHICLES WITHOUT AIR CONDITIONING SYSTEM>
- IGNITION KEY REMINDER TONE ALARM
- <VEHICLES WITH KOS>
- IMMOBILIZER SYSTEM
- KEYLESS OPERATING SYSTEM (KOS)
- METER AND GAUGE
- MFI SYSTEM
- PARKING BRAKE WARNING TONE ALARM
- REAR WINDOW DEFOGGER
- SEAT BELT WARNING TONE ALARM
- SHIFT LOCK MECHANISM
- SUNROOF
- SUPPLEMENTAL RESTRAINT SYSTEM (SRS)
- TAILLIGHT, POSITION LIGHT, REAR SIDE MARKER LIGHT, LICENSE PLATE LIGHT AND LIGHTING MONITOR TONE ALARM
- THEFT-ALARM SYSTEM
- TIRE PRESSURE MONITORING SYSTEM (TPMS)
- TRUNK LID OPENER
- TURN-SIGNAL LIGHT AND HAZARD WARNING LIGHT
- TWIN CLUTCH-SPORTRONIC SHIFT TRANSMISSION (TC-SST)
- WINDSHIELD WIPER AND WASHER

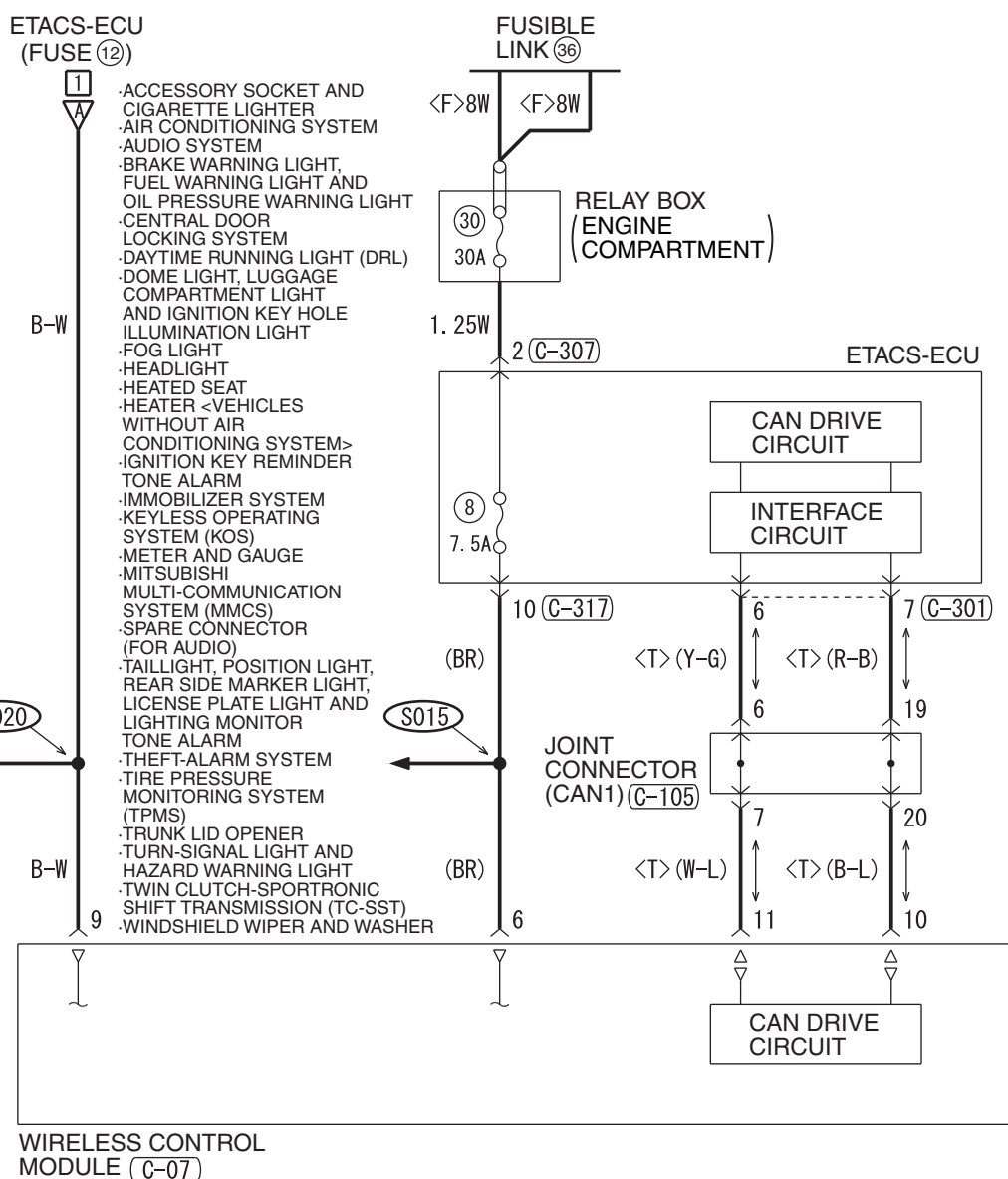

<VEHICLES WITHOUT KOS>

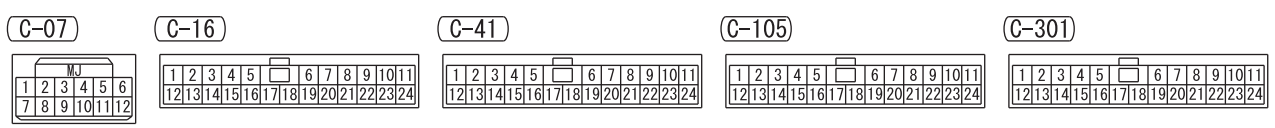

4

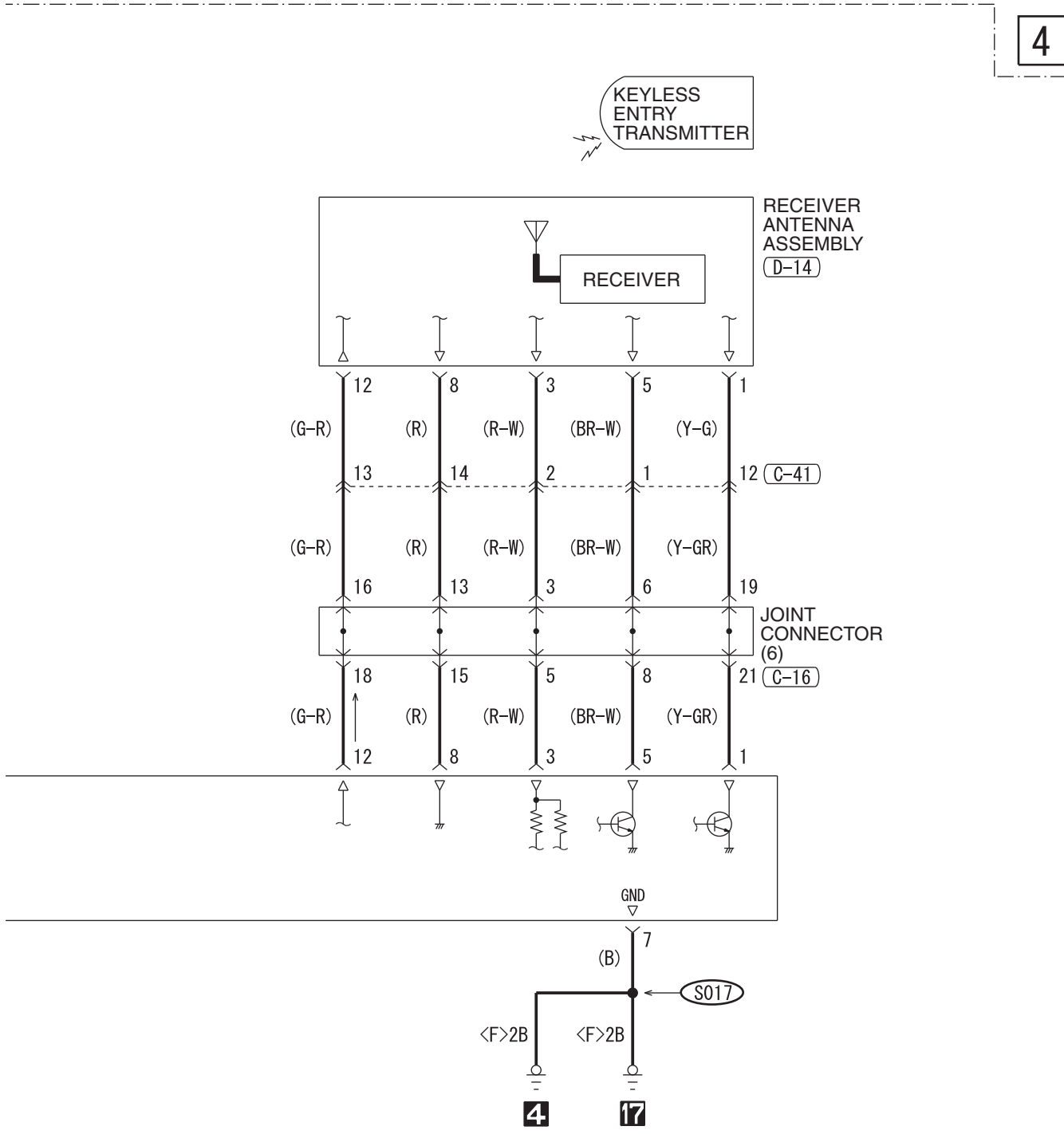

(C-307)

(C-317)

(D-14)

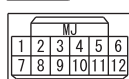
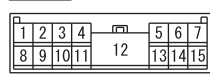

WIRE COLOR CODE

B: BLACK LG: LIGHT GREEN G: GREEN L: BLUE W: WHITE Y: YELLOW SB: SKY BLUE  
BR: BROWN O: ORANGE GR: GRAY R: RED P: PINK V: VIOLET PU: PURPLE SI: SILVER

HAH11M07BB

TSB Revision

TRUNK LID OPENER (CONTINUED)

5

- ABS, ASC, ACD, AYC AND S-AWC
- AIR CONDITIONING SYSTEM
- BRAKE WARNING LIGHT, FUEL WARNING LIGHT AND OIL PRESSURE WARNING LIGHT
- CENTRAL DOOR LOCKING SYSTEM
- CHARGING SYSTEM
- COOLING SYSTEM
- CRUISE CONTROL SYSTEM
- DAYTIME RUNNING LIGHT (DRL)
- DOME LIGHT, LUGGAGE COMPARTMENT LIGHT AND IGNITION KEY HOLE ILLUMINATION LIGHT
- DOOR AJAR WARNING TONE ALARM
- FOG LIGHT
- HANDS-FREE CELLULAR PHONE SYSTEM
- HEADLIGHT
- HEATED DOOR MIRROR
- HEATED SEAT
- IMMOBILIZER SYSTEM
- METER AND GAUGE
- MFI SYSTEM
- PARKING BRAKE WARNING TONE ALARM
- REAR WINDOW DEFOGGER
- SEAT BELT WARNING TONE ALARM
- SHIFT LOCK MECHANISM
- SUNROOF
- SUPPLEMENTAL RESTRAINT SYSTEM (SRS)
- TAILLIGHT, POSITION LIGHT, REAR SIDE MARKER LIGHT, LICENSE PLATE LIGHT AND LIGHTING MONITOR TONE ALARM
- THEFT-ALARM SYSTEM
- TIRE PRESSURE MONITORING SYSTEM (TPMS)
- TRUNK LID OPENER
- TURN-SIGNAL LIGHT AND HAZARD WARNING LIGHT
- TWIN CLUTCH-SPORTRONIC SHIFT TRANSMISSION (TC-SST)
- WINDSHIELD WIPER AND WASHER

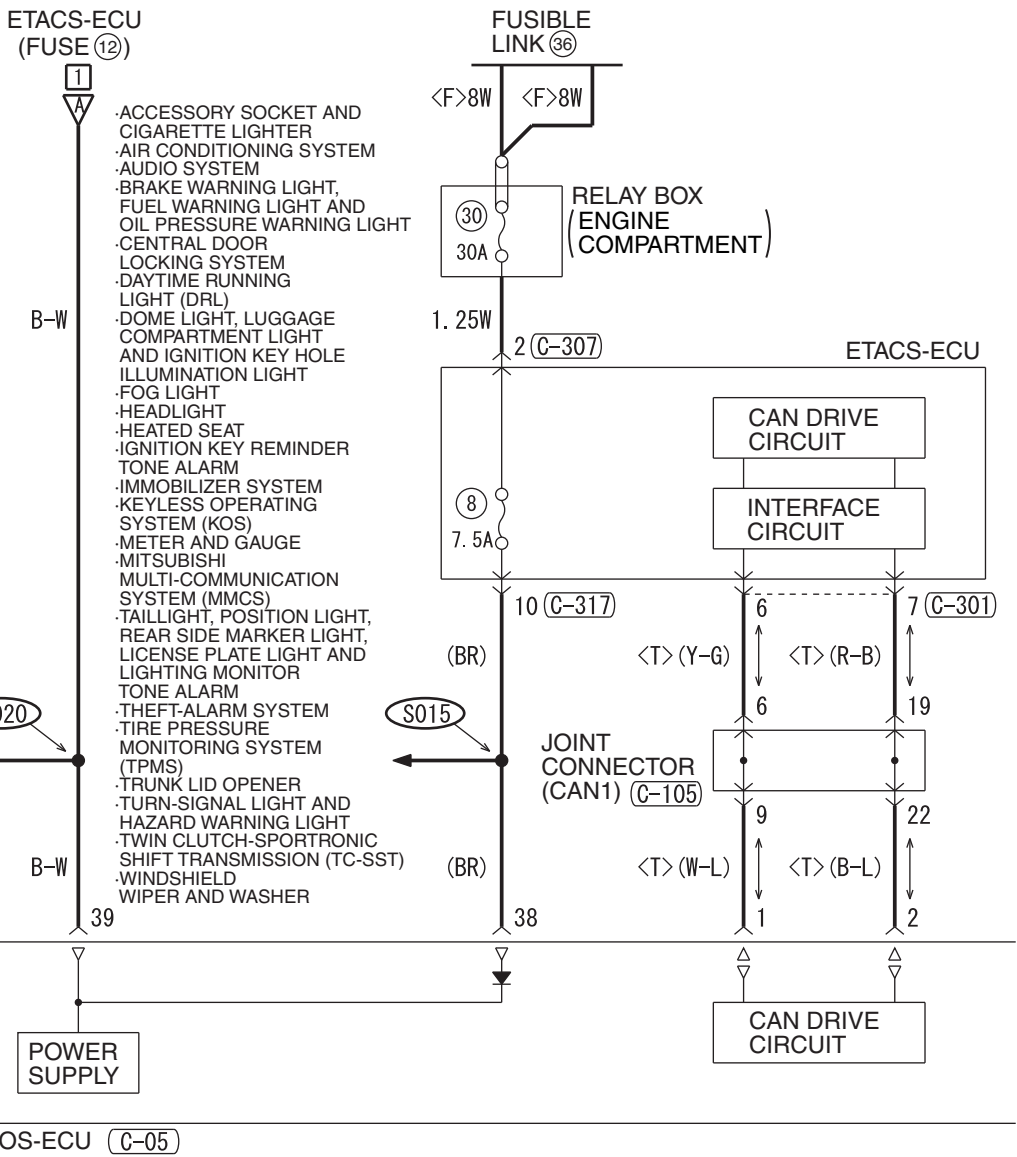

<VEHICLES WITH KOS>

(C-05)

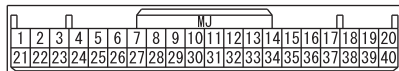

(C-16)

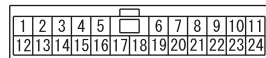

(C-41)

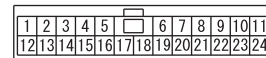

(C-42)

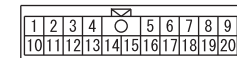

(F-09)



(F-27)

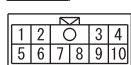

6

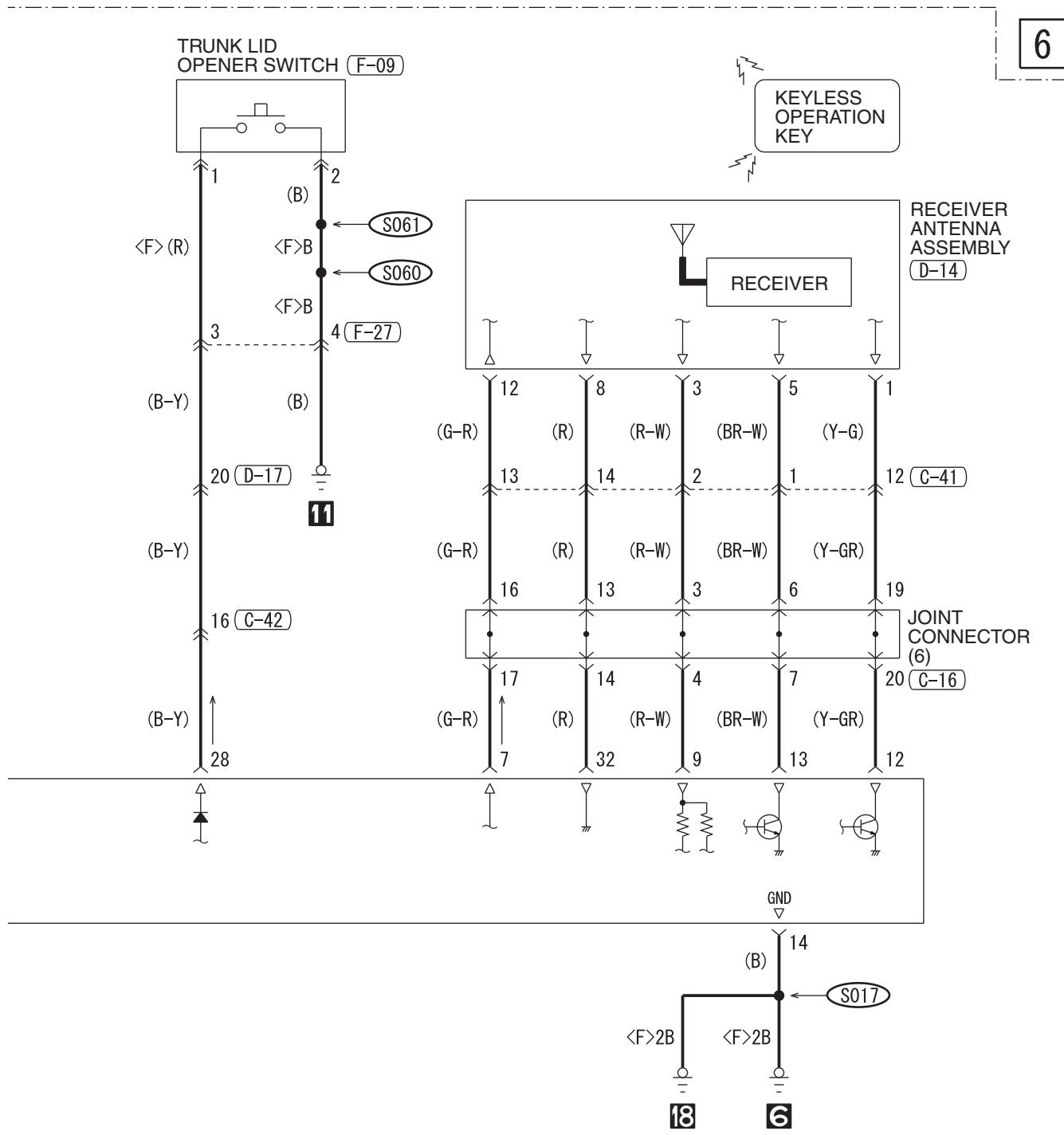

(C-105)

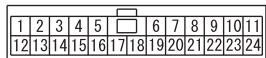

(C-301)

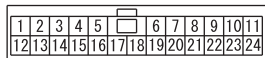

(C-307)



(C-317)

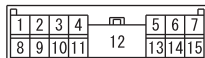

(D-14)

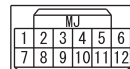

(D-17)

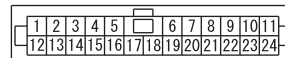

WIRE COLOR CODE

B: BLACK LG: LIGHT GREEN G: GREEN L: BLUE W: WHITE Y: YELLOW SB: SKY BLUE  
BR: BROWN O: ORANGE GR: GRAY R: RED P: PINK V: VIOLET PU: PURPLE SI: SILVER

HAH11M07CB

# HEATER <VEHICLES WITHOUT AIR CONDITIONING SYSTEM>

M1901013301057

1

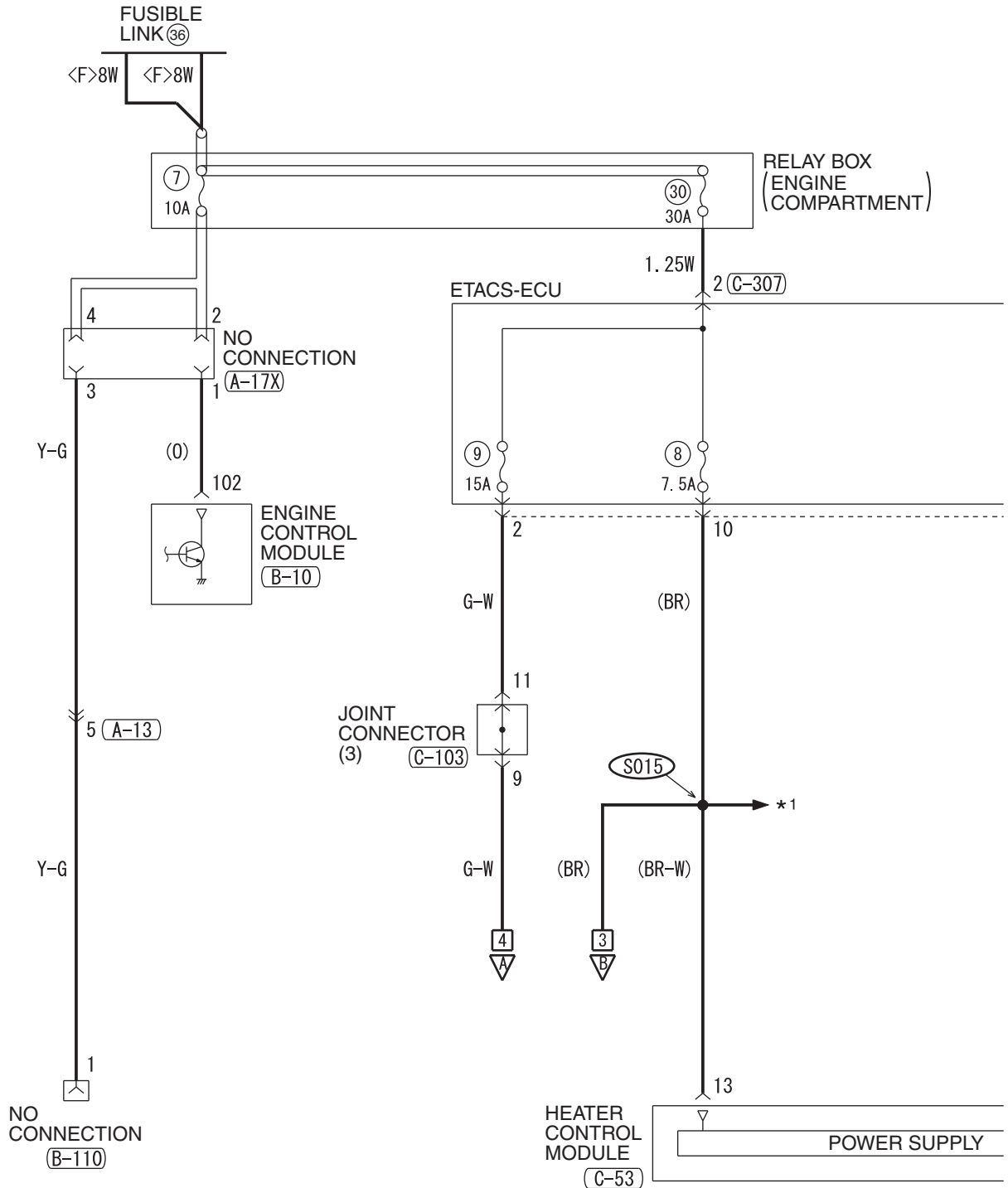

(A-13)

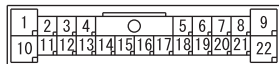

(A-17X) (B-10)

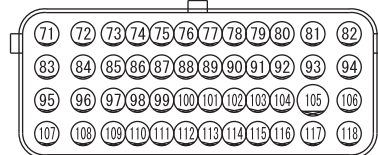

(B-110) (C-40) FRONT SIDE



(C-53)

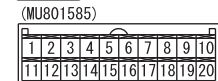

HAH12M03AA

TSB Revision

2

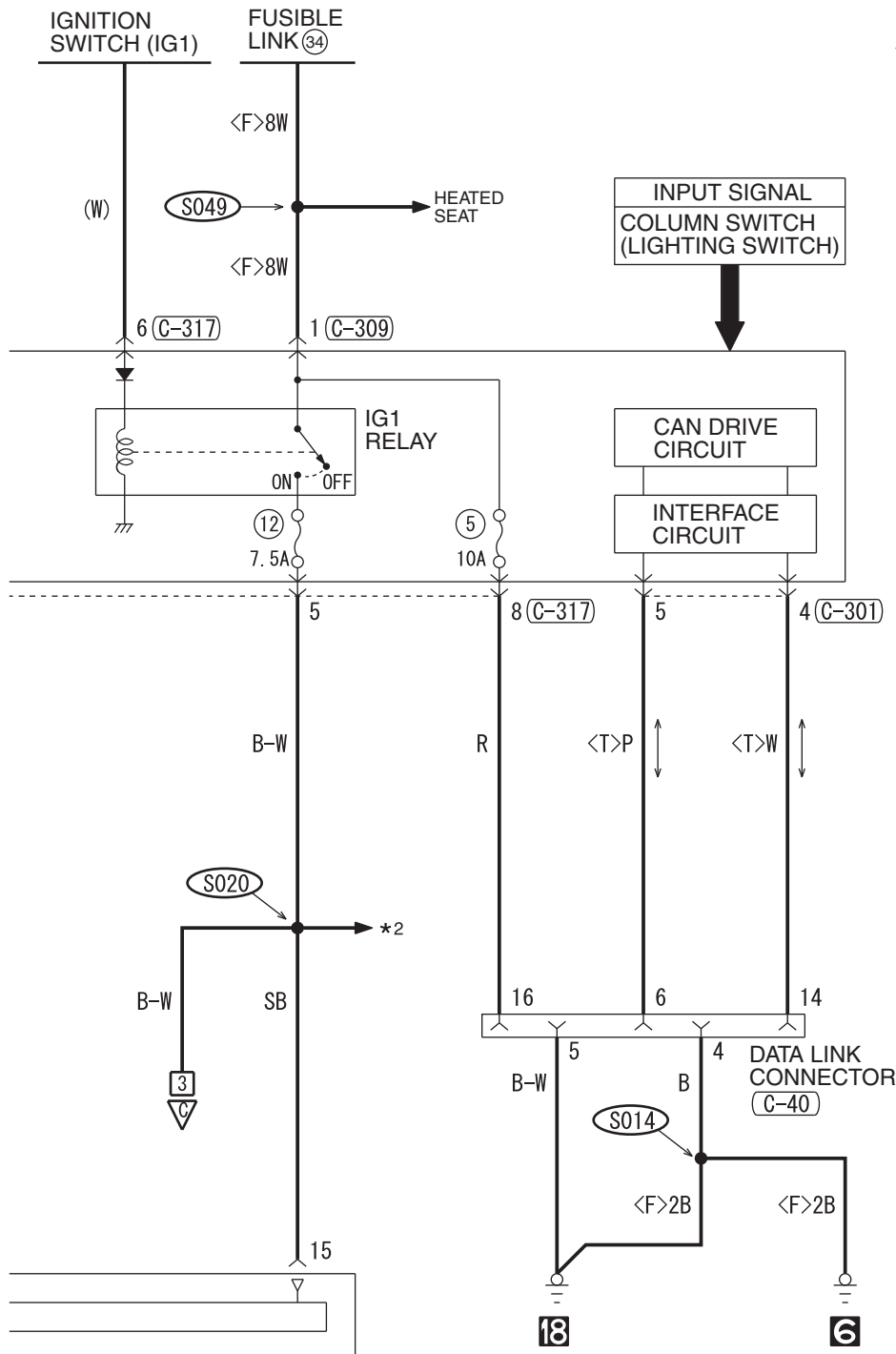

**NOTE**

- \*1 : AUDIO SYSTEM
- BRAKE WARNING LIGHT,
- FUEL WARNING LIGHT AND
- OIL PRESSURE WARNING LIGHT
- CENTRAL DOOR LOCKING SYSTEM
- DAYTIME RUNNING LIGHT (DRL)
- DOME LIGHT, LUGGAGE
- COMPARTMENT LIGHT
- AND IGNITION KEY HOLE
- ILLUMINATION LIGHT
- FOG LIGHT
- HEADLIGHT
- IGNITION KEY REMINDER TONE
- ALARM
- IMMOBILIZER SYSTEM
- METER AND GAUGE
- MITSUBISHI MULTI-COMMUNICATION
- SYSTEM (MMCS)
- SPARE CONNECTOR (FOR AUDIO)
- TAILLIGHT, POSITION LIGHT,
- REAR SIDE MARKER LIGHT,
- LICENSE PLATE LIGHT
- AND LIGHTING MONITOR TONE ALARM
- THEFT-ALARM SYSTEM
- TIRE PRESSURE MONITORING
- SYSTEM (TPMS)
- TRUNK LID OPENER
- TURN-SIGNAL LIGHT
- AND HAZARD WARNING LIGHT
- WINDSHIELD WIPER AND WASHER
- \*2 : ABS, ASC, ACD, AYC AND S-AWC
- BRAKE WARNING LIGHT,
- FUEL WARNING LIGHT AND
- OIL PRESSURE WARNING LIGHT
- CENTRAL DOOR LOCKING SYSTEM
- CHARGING SYSTEM
- COOLING SYSTEM
- CRUISE CONTROL SYSTEM
- DAYTIME RUNNING LIGHT (DRL)
- DOME LIGHT, LUGGAGE
- COMPARTMENT LIGHT
- AND IGNITION KEY HOLE
- ILLUMINATION LIGHT
- DOOR AJAR WARNING TONE ALARM
- FOG LIGHT
- HANDS-FREE
- CELLULAR PHONE SYSTEM
- HEADLIGHT
- HEATED DOOR MIRROR
- HEATED SEAT
- IMMOBILIZER SYSTEM
- METER AND GAUGE
- MFI SYSTEM
- PARKING BRAKE WARNING
- TONE ALARM
- REAR WINDOW DEFOGGER
- SEAT BELT WARNING TONE ALARM
- SUNROOF
- SUPPLEMENTAL RESTRAINT
- SYSTEM (SRS)
- TAILLIGHT, POSITION LIGHT,
- REAR SIDE MARKER LIGHT,
- LICENSE PLATE LIGHT
- AND LIGHTING MONITOR TONE ALARM
- THEFT-ALARM SYSTEM
- TIRE PRESSURE MONITORING
- SYSTEM (TPMS)
- TRUNK LID OPENER
- TURN-SIGNAL LIGHT AND
- HAZARD WARNING LIGHT
- WINDSHIELD WIPER AND WASHER

(C-103)

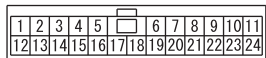

(C-301)

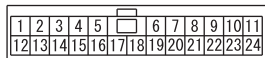

(C-307)



(C-309)



(C-317)

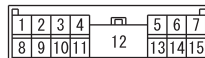

**WIRE COLOR CODE**

B : BLACK LG : LIGHT GREEN G : GREEN L : BLUE W : WHITE Y : YELLOW SB : SKY BLUE  
 BR : BROWN O : ORANGE GR : GRAY R : RED P : PINK V : VIOLET PU : PURPLE SI : SILVER

HEATER <VEHICLES WITHOUT AIR CONDITIONING SYSTEM> (CONTINUED)

3

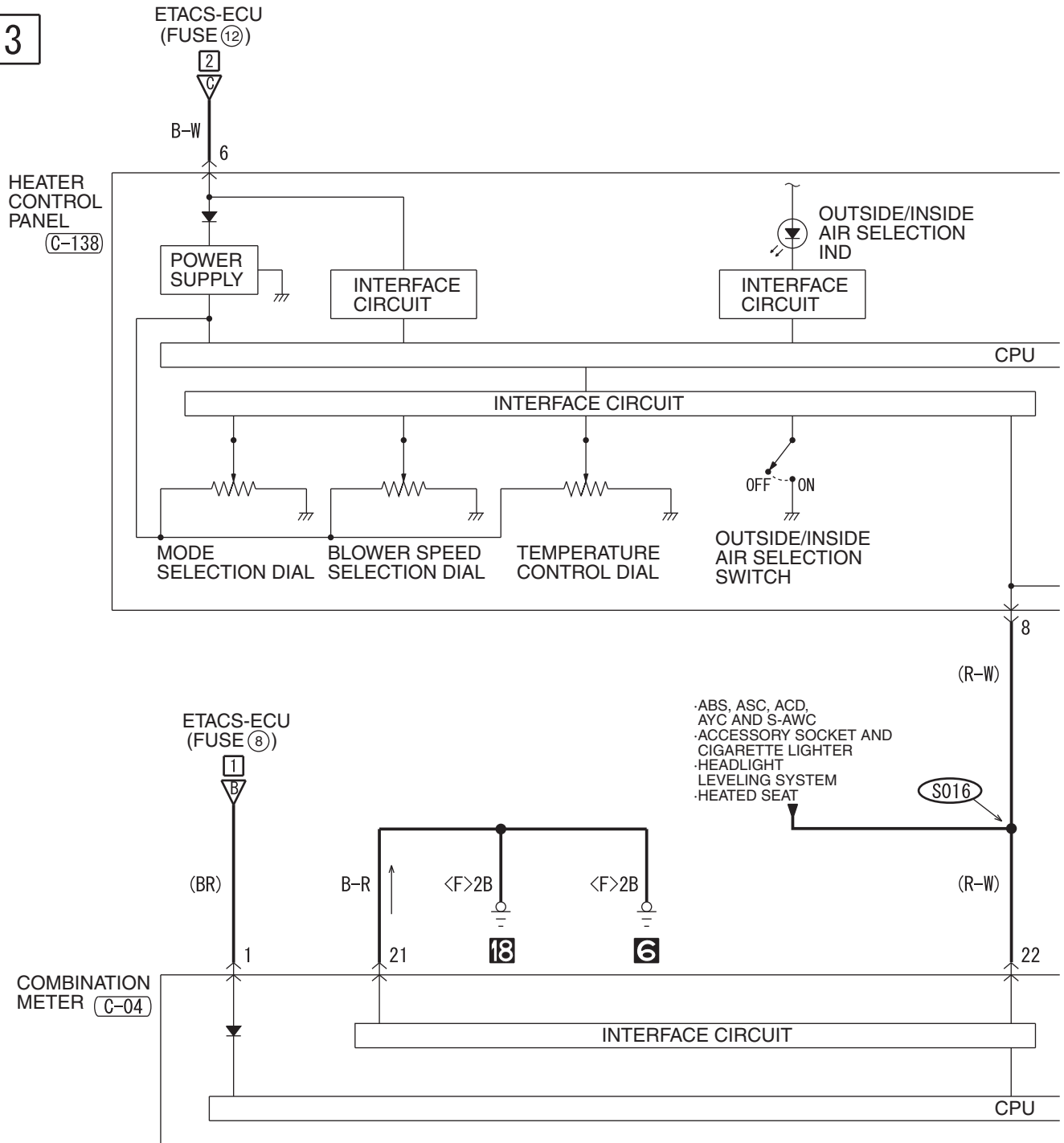

(C-04)

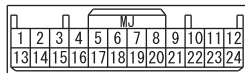

(C-138)

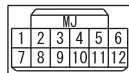



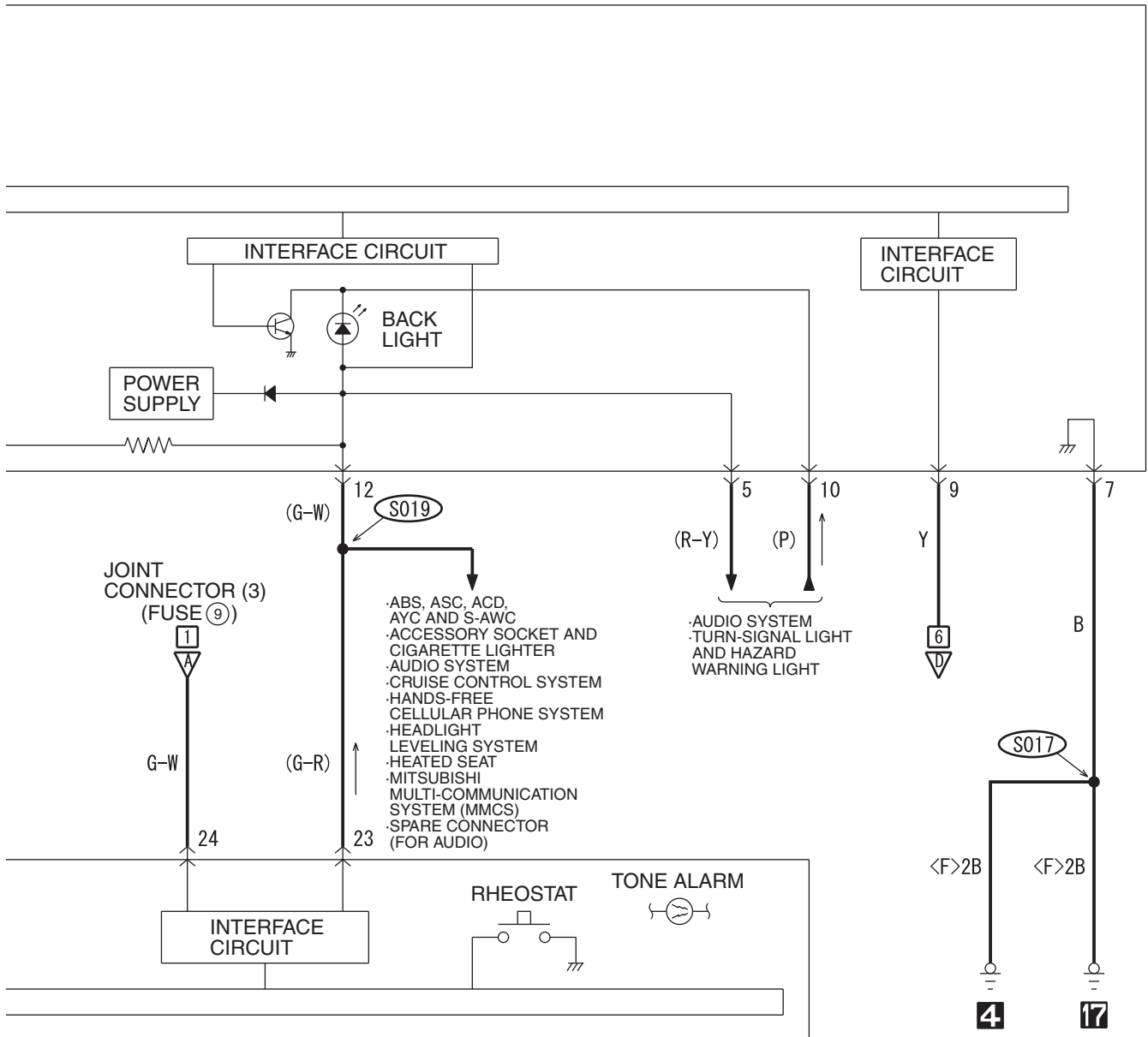

WIRE COLOR CODE

B : BLACK LG : LIGHT GREEN G : GREEN L : BLUE W : WHITE Y : YELLOW SB : SKY BLUE  
 BR : BROWN O : ORANGE GR : GRAY R : RED P : PINK V : VIOLET PU : PURPLE SI : SILVER

HAH12M03BB

HEATER <VEHICLES WITHOUT AIR CONDITIONING SYSTEM> (CONTINUED)

5

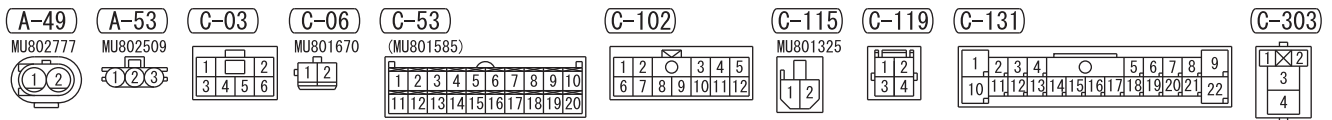
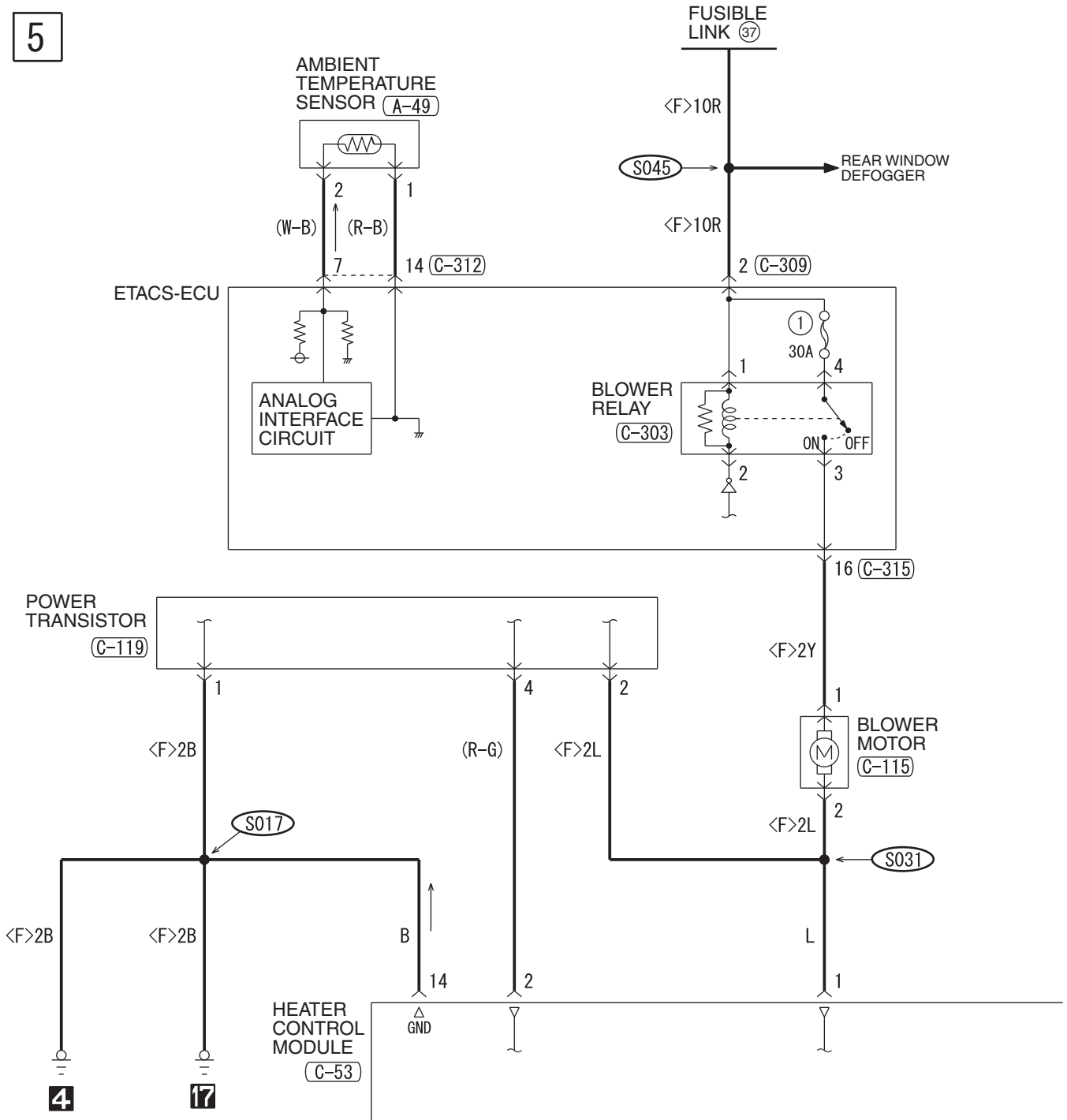

6

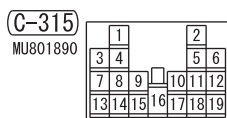
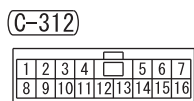
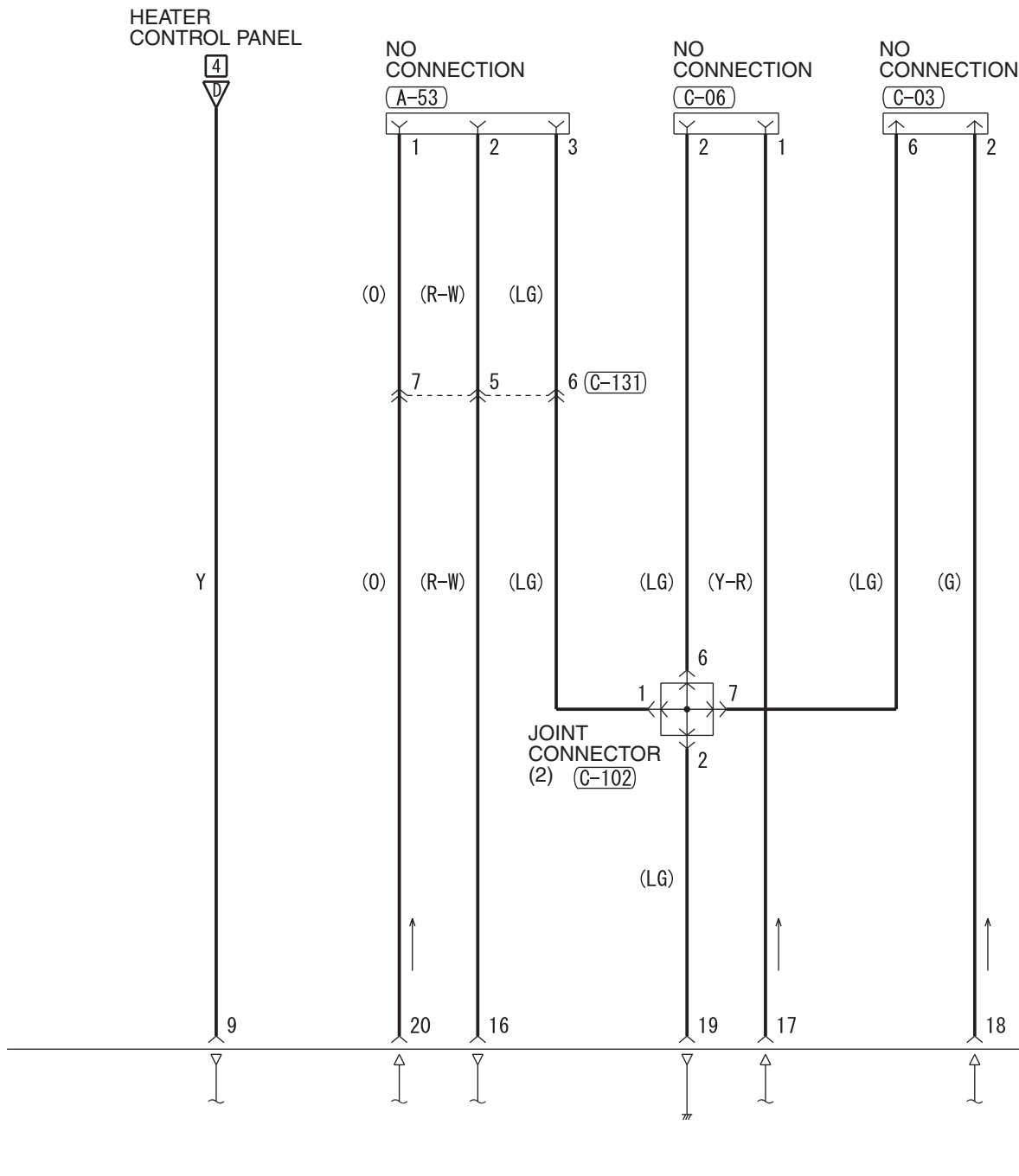

**WIRE COLOR CODE**  
 B : BLACK LG : LIGHT GREEN G : GREEN L : BLUE W : WHITE Y : YELLOW SB : SKY BLUE  
 BR : BROWN O : ORANGE GR : GRAY R : RED P : PINK V : VIOLET PU : PURPLE SI : SILVER

HAH12M03CB

HEATER <VEHICLES WITHOUT AIR CONDITIONING SYSTEM> (CONTINUED)

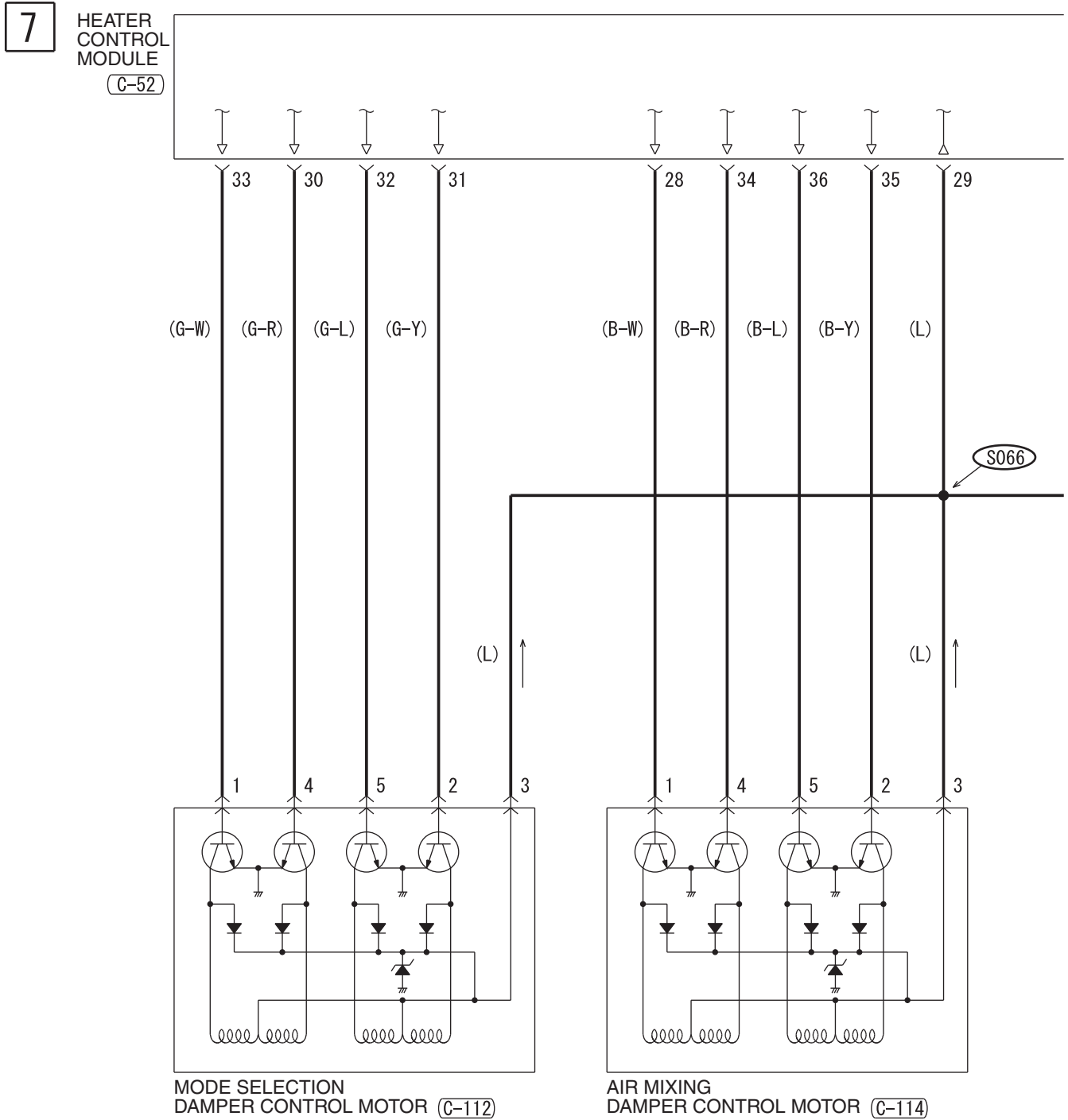

(C-52)  
(MU801584)

21	22	23	24	25	26	27	28
29	30	31	32	33	34	35	36

(C-111)

1	2	3	4	5
---	---	---	---	---

(C-112)

1	2	3	4	5
---	---	---	---	---

(C-113)

1
2

(C-114)

1	2	3	4	5
---	---	---	---	---

8

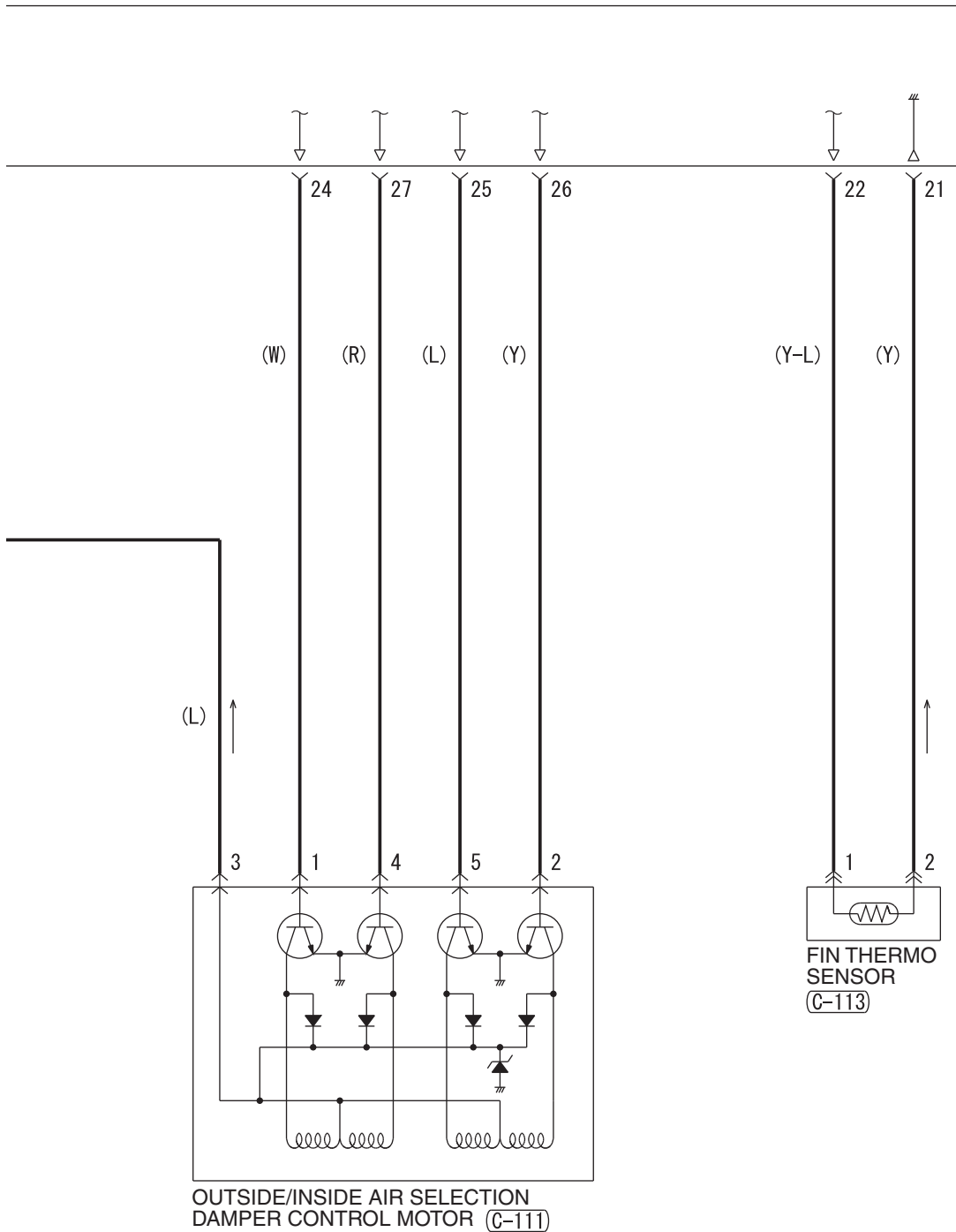

WIRE COLOR CODE

B: BLACK LG: LIGHT GREEN G: GREEN L: BLUE W: WHITE Y: YELLOW SB: SKY BLUE  
 BR: BROWN O: ORANGE GR: GRAY R: RED P: PINK V: VIOLET PU: PURPLE SI: SILVER

HAH12M03DB

TSB Revision

HEATER <VEHICLES WITHOUT AIR CONDITIONING SYSTEM> (CONTINUED)

9

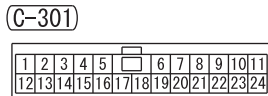
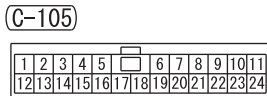
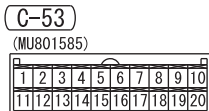
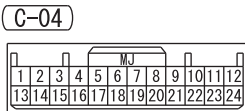
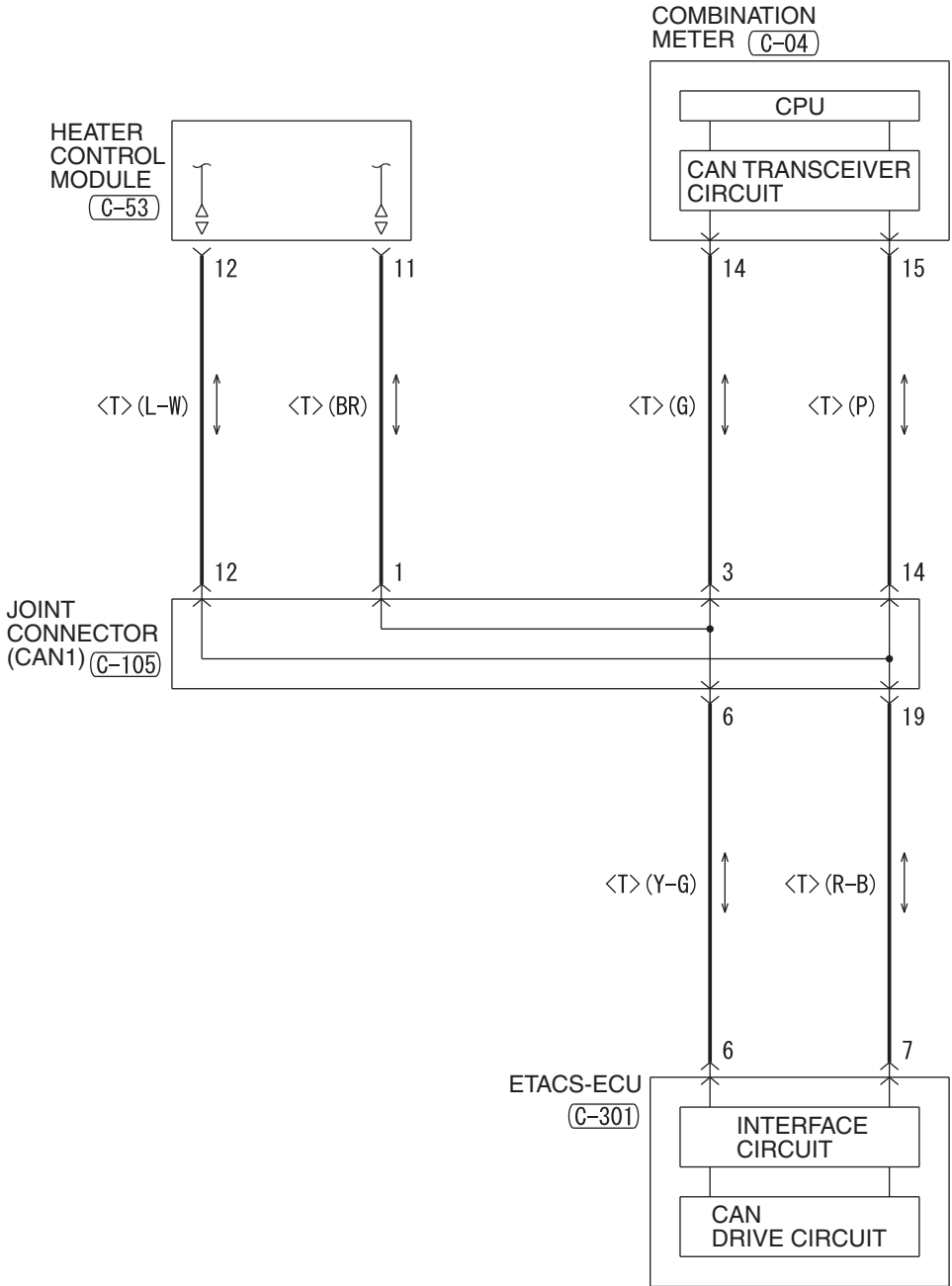

WIRE COLOR CODE  
 B: BLACK LG: LIGHT GREEN G: GREEN L: BLUE W: WHITE Y: YELLOW SB: SKY BLUE  
 BR: BROWN O: ORANGE GR: GRAY R: RED P: PINK V: VIOLET PU: PURPLE SI: SILVER

HAH12M03EA

NOTES

# AIR CONDITIONING SYSTEM

M1901032100617

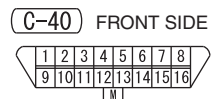
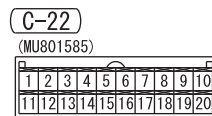
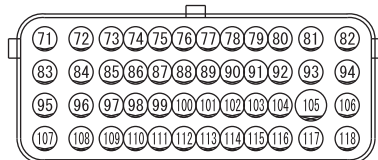
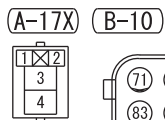
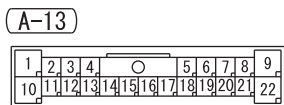
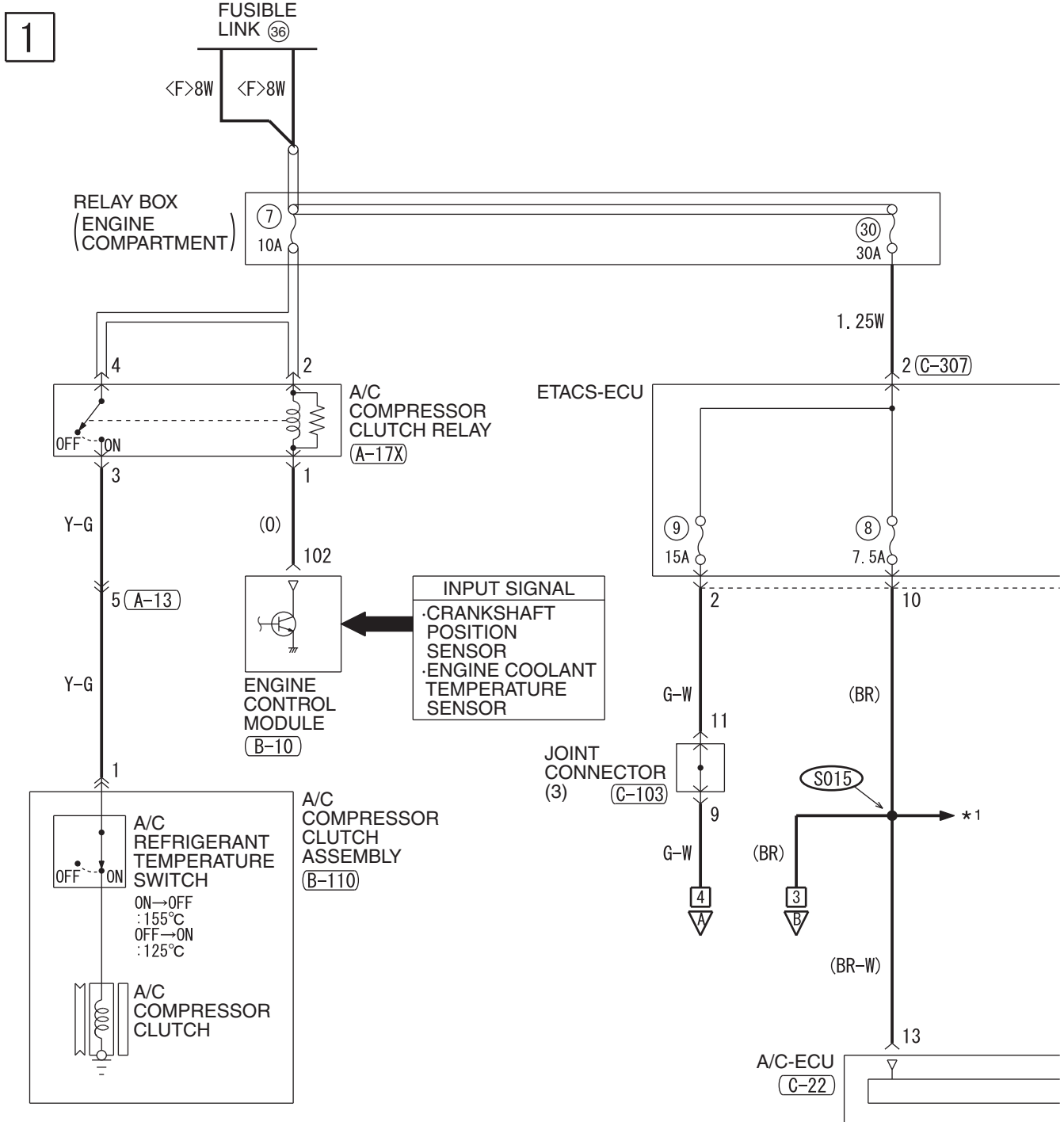

HAH12M04AA



2

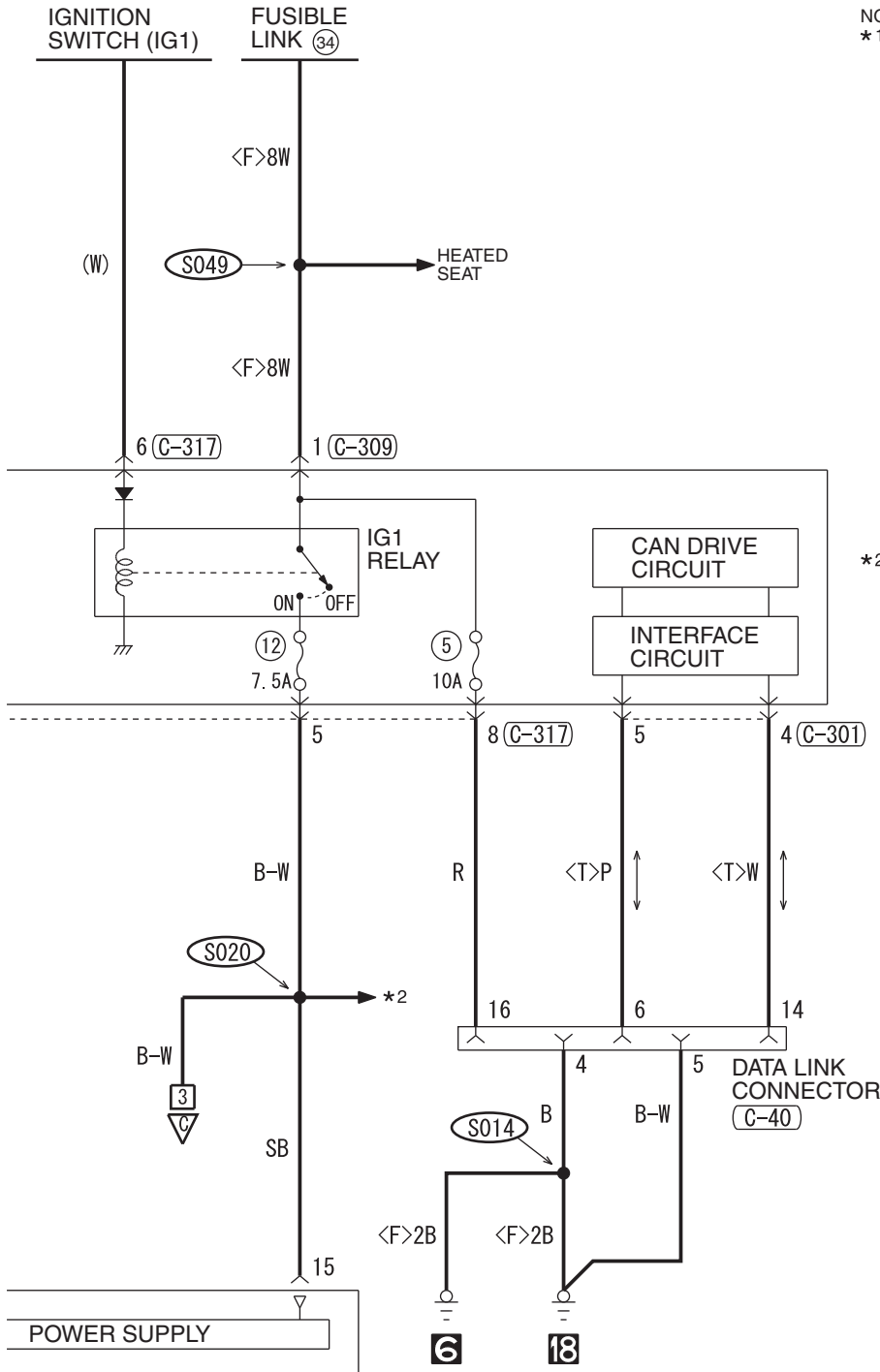

- NOTE
- \*1 :
    - AUDIO SYSTEM
    - BRAKE WARNING LIGHT, FUEL WARNING LIGHT AND OIL PRESSURE WARNING LIGHT
    - CENTRAL DOOR LOCKING SYSTEM
    - DAYTIME RUNNING LIGHT (DRL)
    - DOME LIGHT, LUGGAGE COMPARTMENT LIGHT AND IGNITION KEY HOLE ILLUMINATION LIGHT
    - FOG LIGHT
    - HEADLIGHT
    - IGNITION KEY REMINDER TONE ALARM
    - IMMOBILIZER SYSTEM
    - KEYLESS OPERATING SYSTEM (KOS)
    - METER AND GAUGE
    - MITSUBISHI MULTI-COMMUNICATION SYSTEM (MMCS)
    - SPARE CONNECTOR (FOR AUDIO)
    - TAILLIGHT, POSITION LIGHT, REAR SIDE MARKER LIGHT, LICENSE PLATE LIGHT AND LIGHTING MONITOR TONE ALARM
    - THEFT-ALARM SYSTEM
    - TIRE PRESSURE MONITORING SYSTEM (TPMS)
    - TRUNK LID OPENER
    - TURN-SIGNAL LIGHT AND HAZARD WARNING LIGHT
    - WINDSHIELD WIPER AND WASHER
  - \*2 :
    - ABS, ASC, ACD, AYC AND S-AWC
    - BRAKE WARNING LIGHT, FUEL WARNING LIGHT AND OIL PRESSURE WARNING LIGHT
    - CENTRAL DOOR LOCKING SYSTEM
    - CHARGING SYSTEM
    - COOLING SYSTEM
    - CRUISE CONTROL SYSTEM
    - DAYTIME RUNNING LIGHT (DRL)
    - DOME LIGHT, LUGGAGE COMPARTMENT LIGHT AND IGNITION KEY HOLE ILLUMINATION LIGHT
    - DOOR AJAR WARNING TONE ALARM
    - FOG LIGHT
    - HANDS-FREE CELLULAR PHONE SYSTEM
    - HEADLIGHT
    - HEATED DOOR MIRROR
    - HEATED SEAT
    - IGNITION KEY REMINDER TONE ALARM <VEHICLES WITH KOS>
    - IMMOBILIZER SYSTEM
    - KEYLESS OPERATING SYSTEM (KOS)
    - METER AND GAUGE
    - MFI SYSTEM
    - PARKING BRAKE WARNING TONE ALARM
    - REAR WINDOW DEFOGGER
    - SEAT BELT WARNING TONE ALARM
    - SHIFT LOCK MECHANISM
    - SUNROOF
    - SUPPLEMENTAL RESTRAINT SYSTEM (SRS)
    - TAILLIGHT, POSITION LIGHT, REAR SIDE MARKER LIGHT, LICENSE PLATE LIGHT AND LIGHTING MONITOR TONE ALARM
    - THEFT-ALARM SYSTEM
    - TIRE PRESSURE MONITORING SYSTEM (TPMS)
    - TRUNK LID OPENER
    - TURN-SIGNAL LIGHT AND HAZARD WARNING LIGHT
    - TWIN CLUTCH-SPORTRONIC SHIFT TRANSMISSION (TC-SST)
    - WINDSHIELD WIPER AND WASHER

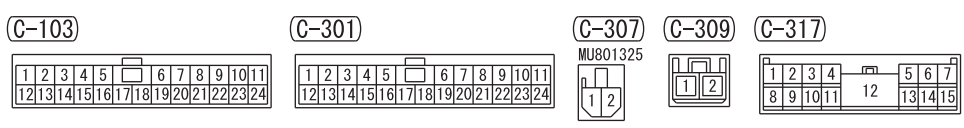

WIRE COLOR CODE  
 B : BLACK LG : LIGHT GREEN G : GREEN L : BLUE W : WHITE Y : YELLOW SB : SKY BLUE  
 BR : BROWN O : ORANGE GR : GRAY R : RED P : PINK V : VIOLET PU : PURPLE SI : SILVER

AIR CONDITIONING SYSTEM (CONTINUED)

3

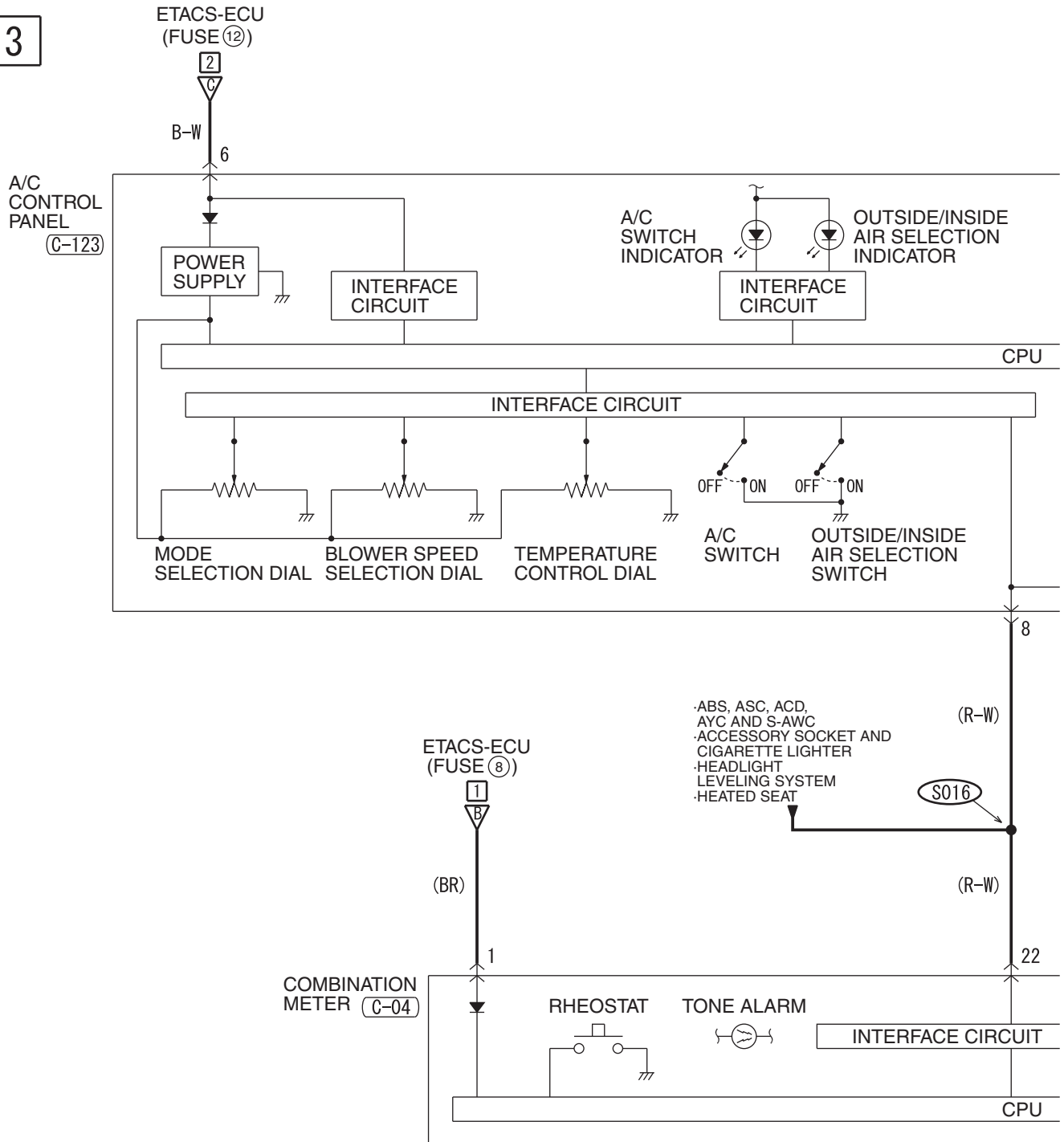

(C-04)

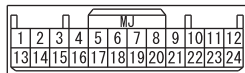

(C-123)

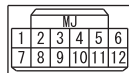

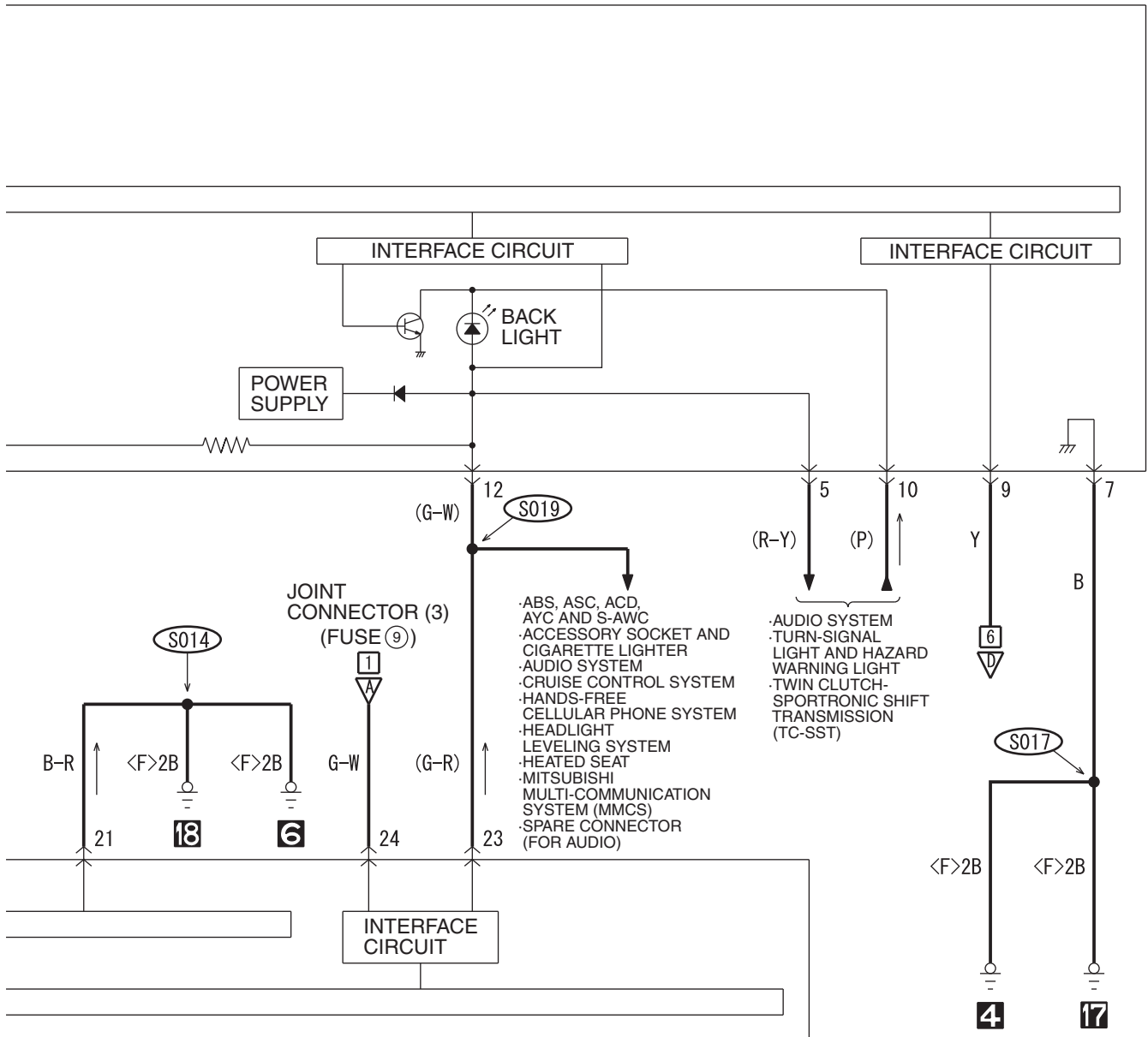

WIRE COLOR CODE

B: BLACK LG: LIGHT GREEN G: GREEN L: BLUE W: WHITE Y: YELLOW SB: SKY BLUE  
BR: BROWN O: ORANGE GR: GRAY R: RED P: PINK V: VIOLET PU: PURPLE SI: SILVER

HAH12M04BB

AIR CONDITIONING SYSTEM (CONTINUED)

5

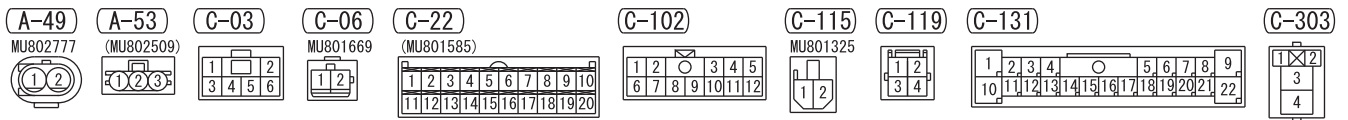
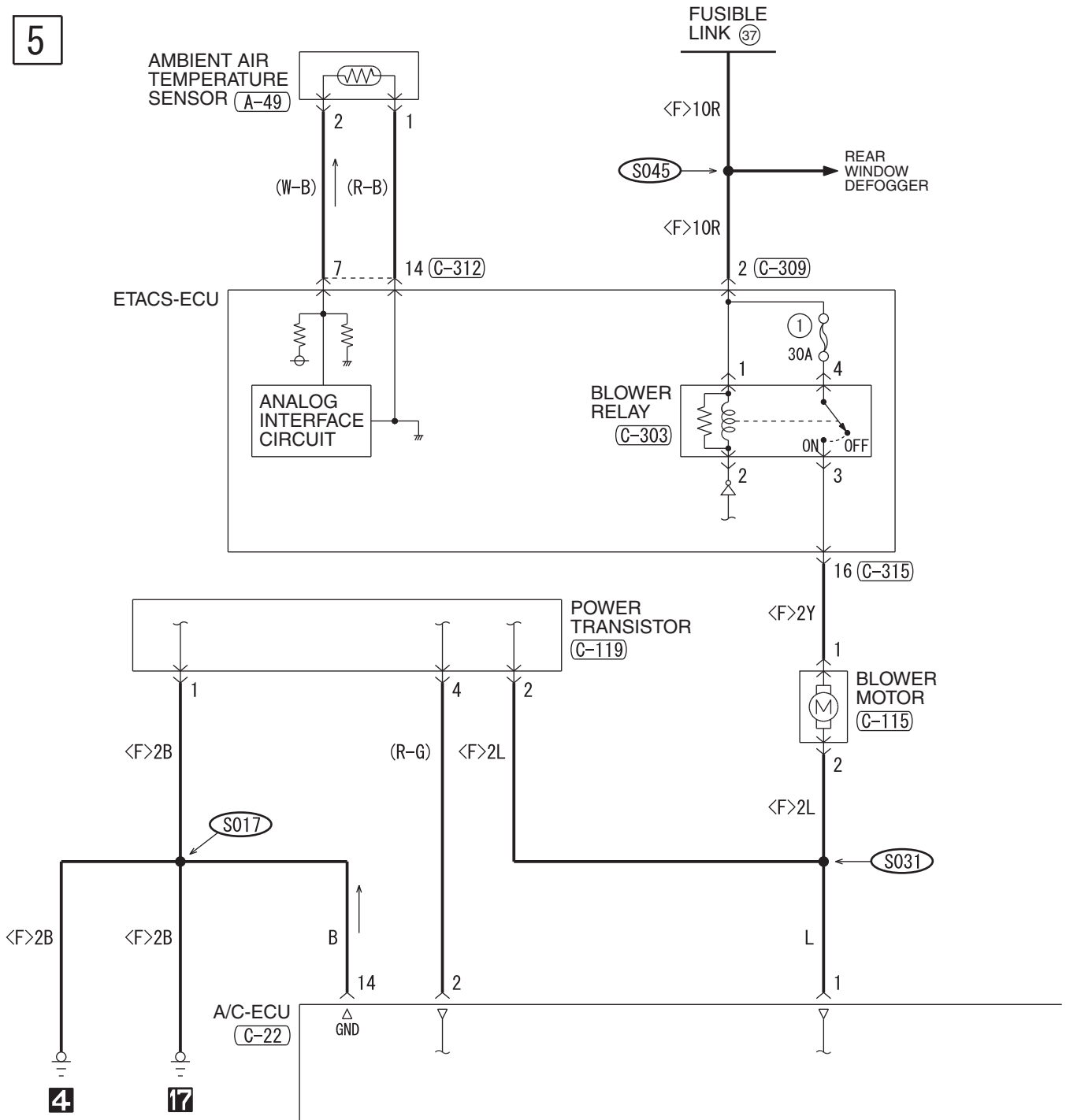

6

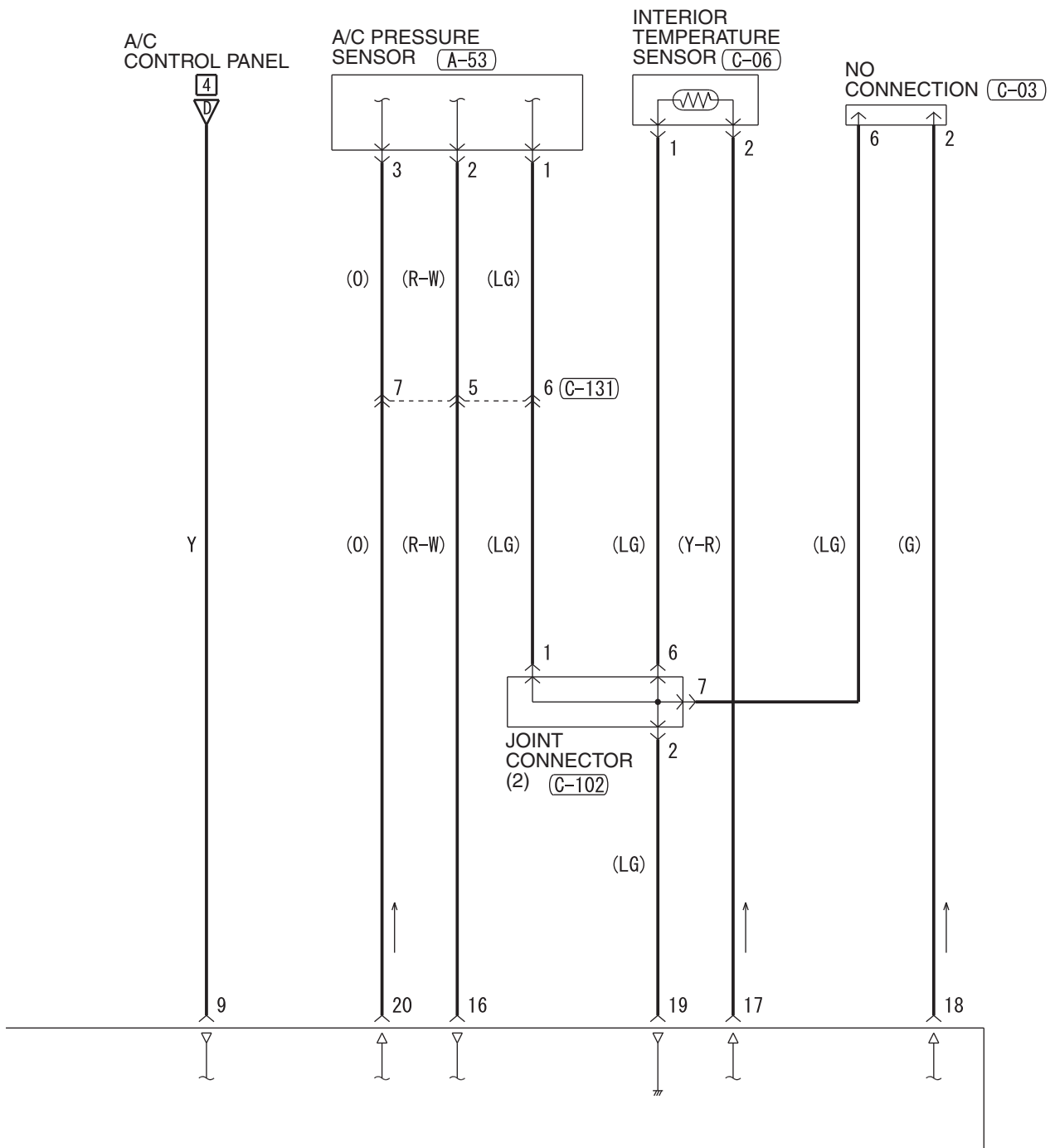

(C-309) (C-312) (C-315) MU801890

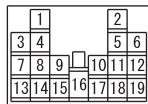
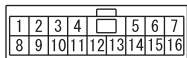

WIRE COLOR CODE

B: BLACK LG: LIGHT GREEN G: GREEN L: BLUE W: WHITE Y: YELLOW SB: SKY BLUE  
BR: BROWN O: ORANGE GR: GRAY R: RED P: PINK V: VIOLET PU: PURPLE SI: SILVER

HAH12M04CB

AIR CONDITIONING SYSTEM (CONTINUED)

7

A/C-ECU  
(C-20)

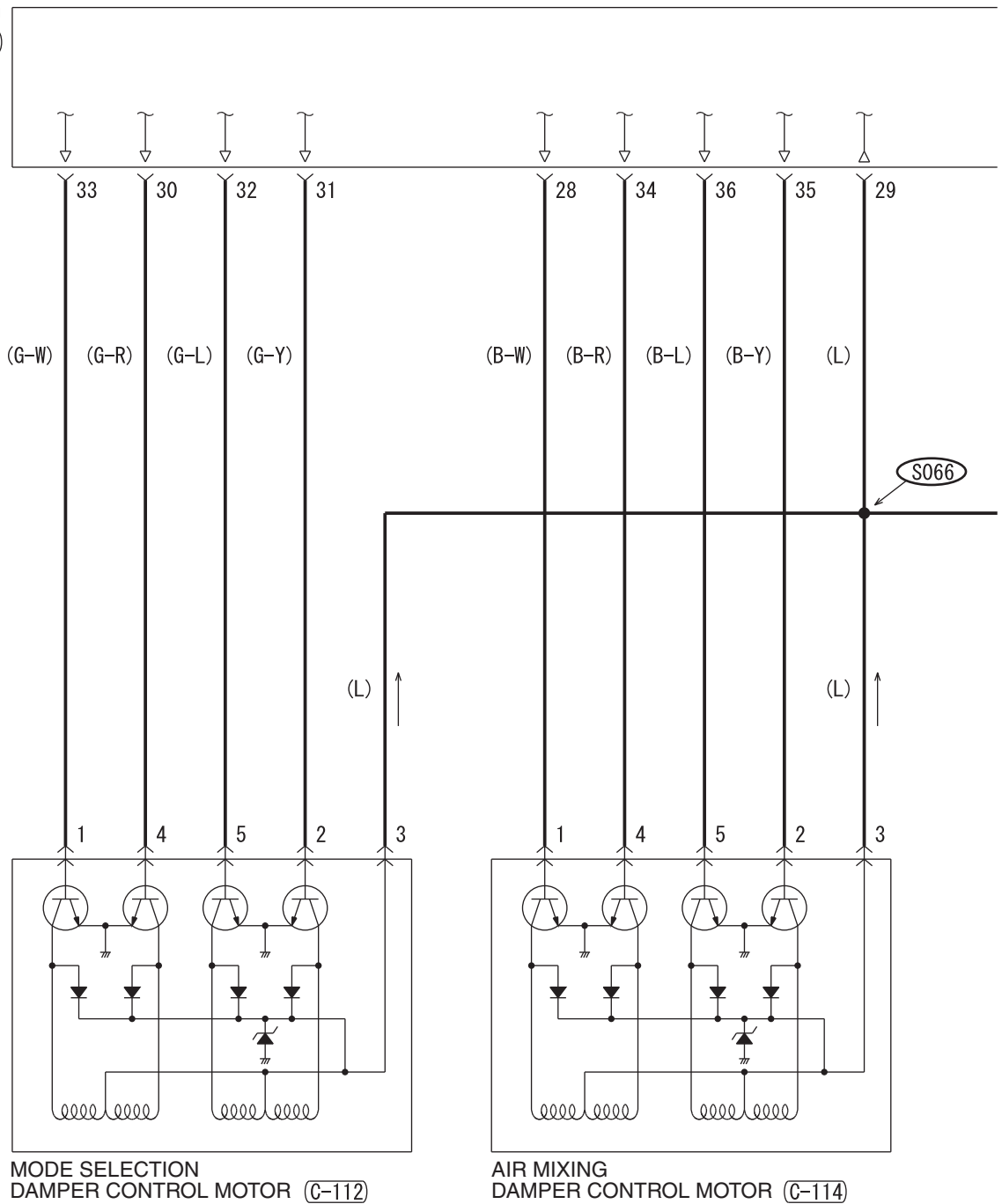

(C-20)

(MU801584)

21	22	23	24	25	26	27	28
29	30	31	32	33	34	35	36

(C-111)

1	2	3	4	5
---	---	---	---	---

(C-112)

1	2	3	4	5
---	---	---	---	---

(C-113)

1
2

(C-114)

1	2	3	4	5
---	---	---	---	---

8

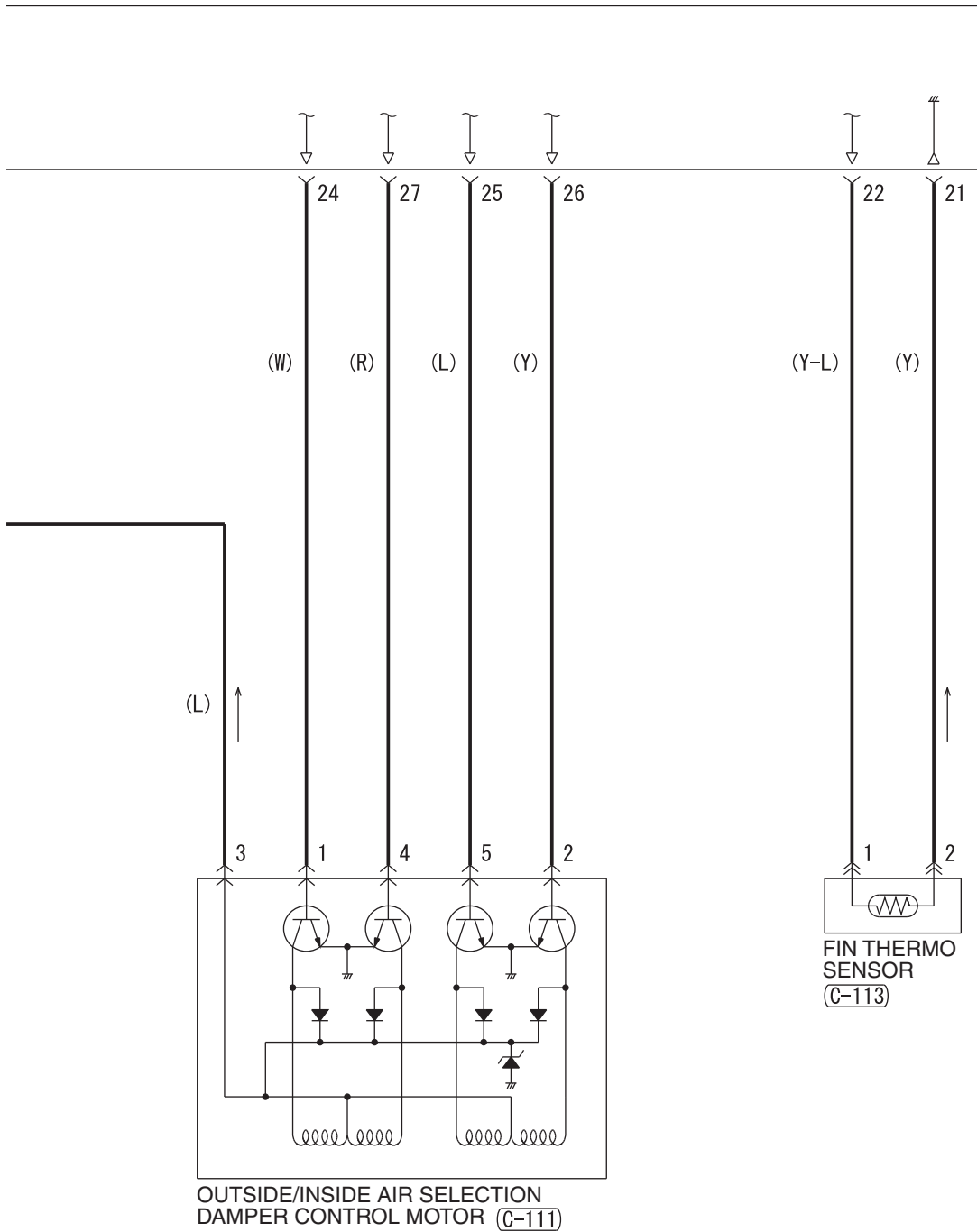

WIRE COLOR CODE  
 B: BLACK LG: LIGHT GREEN G: GREEN L: BLUE W: WHITE Y: YELLOW SB: SKY BLUE  
 BR: BROWN O: ORANGE GR: GRAY R: RED P: PINK V: VIOLET PU: PURPLE SI: SILVER

HAH12M04DB

TSB Revision

AIR CONDITIONING SYSTEM (CONTINUED)

9

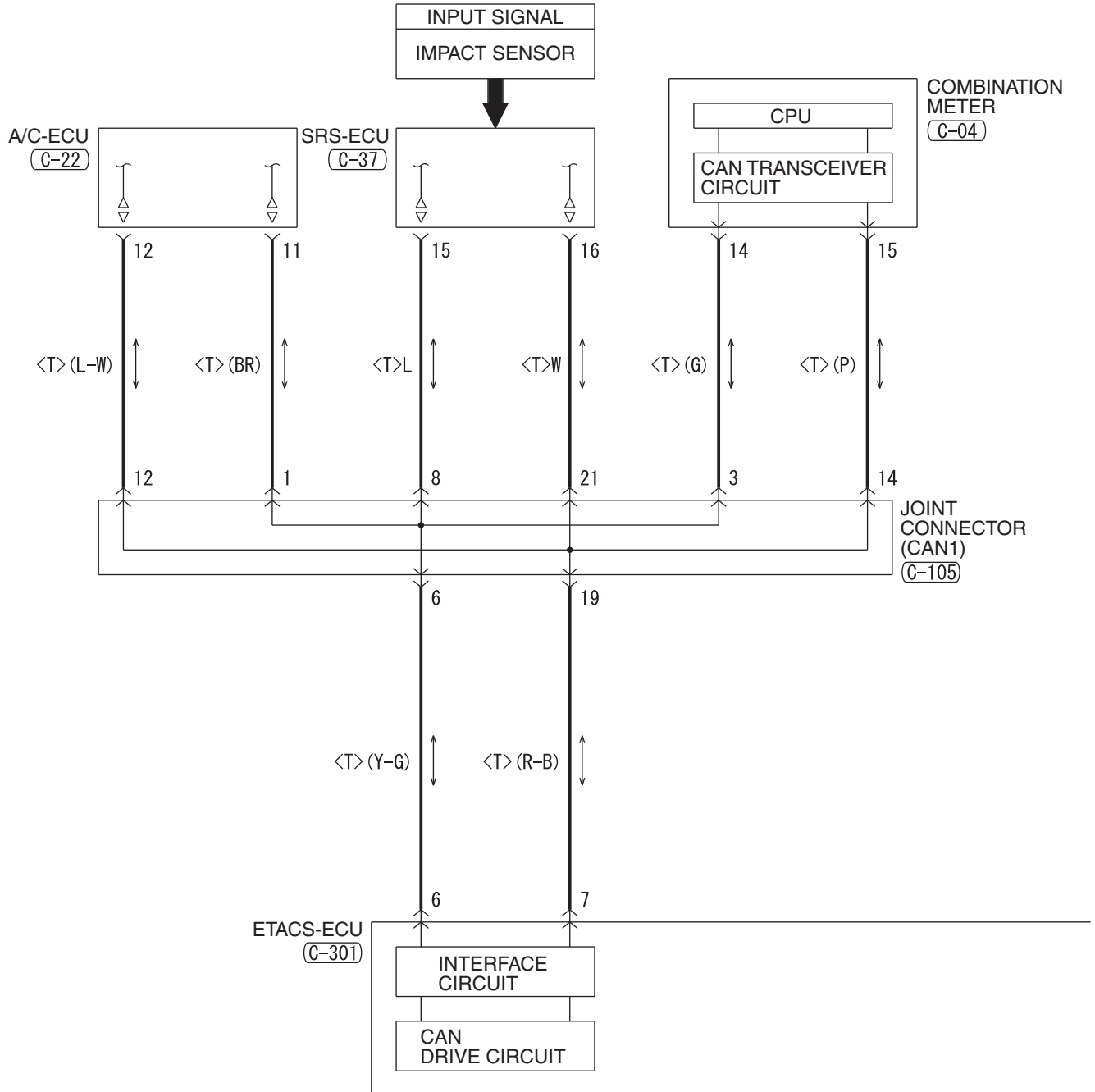

(A-05)

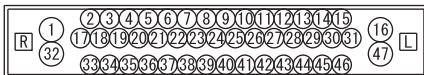

(C-04)

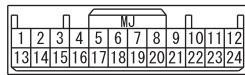

(C-22)

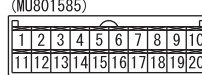

(C-37)

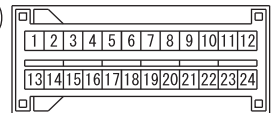

(C-301)

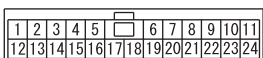



10

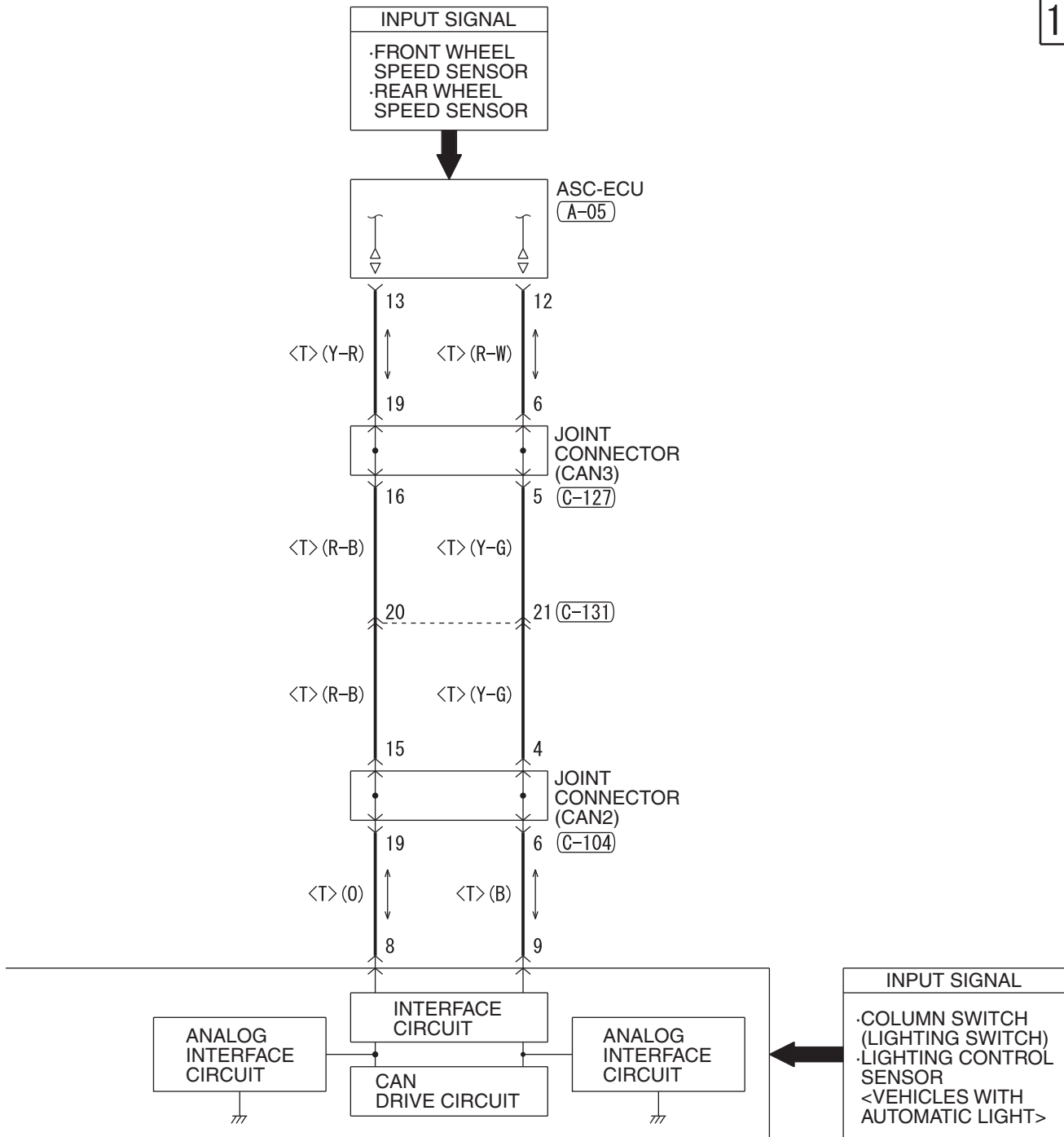

(C-104)

(C-105)

(C-127)

(C-131)

1	2	3	4	5	6	7	8	9	10	11		
12	13	14	15	16	17	18	19	20	21	22	23	24

1	2	3	4	5	6	7	8	9	10	11		
12	13	14	15	16	17	18	19	20	21	22	23	24

1	2	3	4	5	6	7	8	9	10	11		
12	13	14	15	16	17	18	19	20	21	22	23	24

1	2	3	4	5	6	7	8	9				
10	11	12	13	14	15	16	17	18	19	20	21	22

**WIRE COLOR CODE**

B : BLACK LG : LIGHT GREEN G : GREEN L : BLUE W : WHITE Y : YELLOW SB : SKY BLUE  
BR : BROWN O : ORANGE GR : GRAY R : RED P : PINK V : VIOLET PU : PURPLE SI : SILVER

HAH12M04EB

AIR CONDITIONING SYSTEM (CONTINUED)

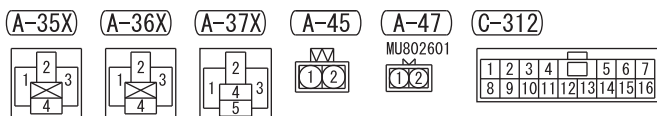
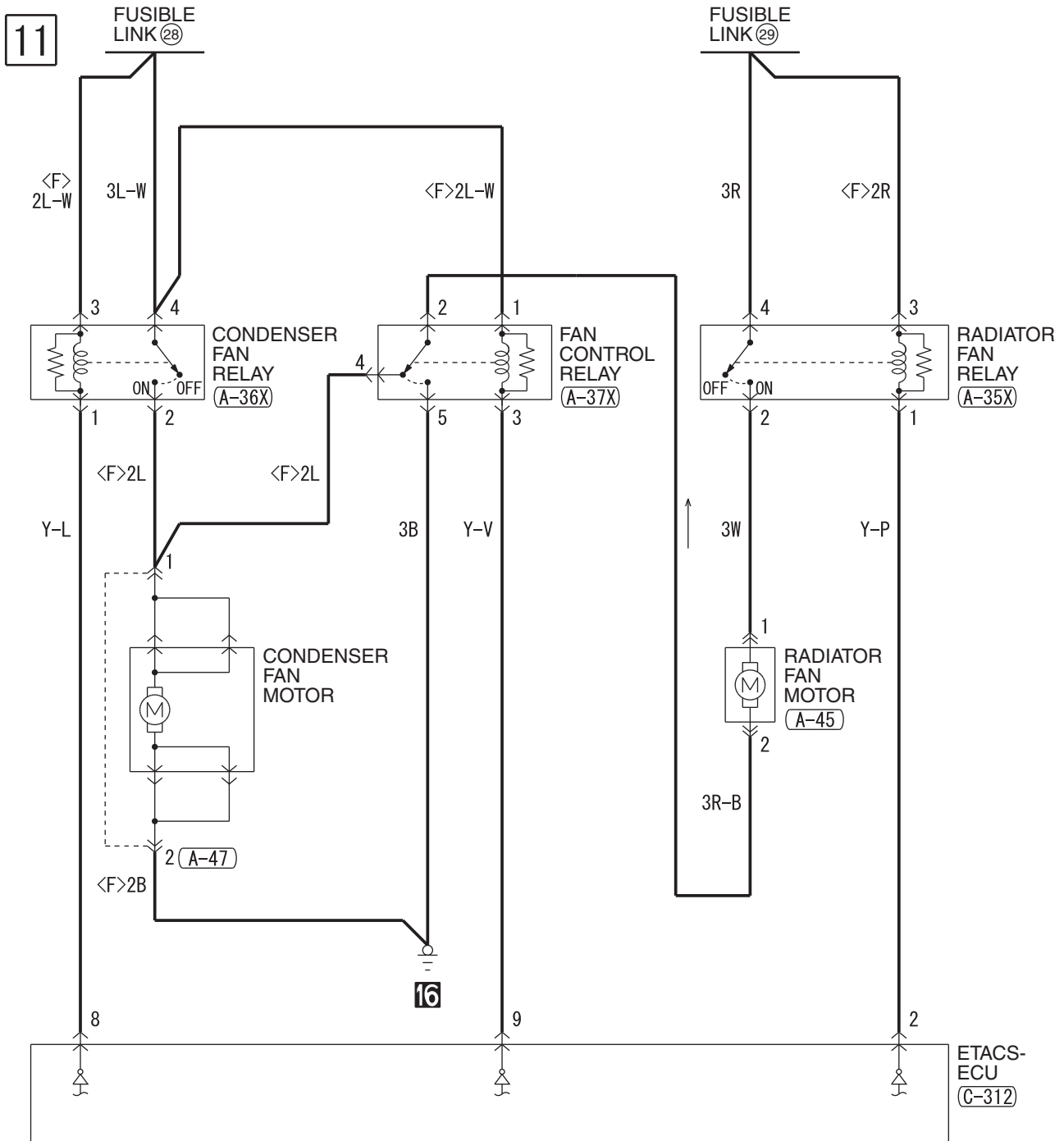

WIRE COLOR CODE  
 B: BLACK LG: LIGHT GREEN G: GREEN L: BLUE W: WHITE Y: YELLOW SB: SKY BLUE  
 BR: BROWN O: ORANGE GR: GRAY R: RED P: PINK V: VIOLET PU: PURPLE SI: SILVER

NOTES

# WINDSHIELD WIPER AND WASHER

M1901006104997

1

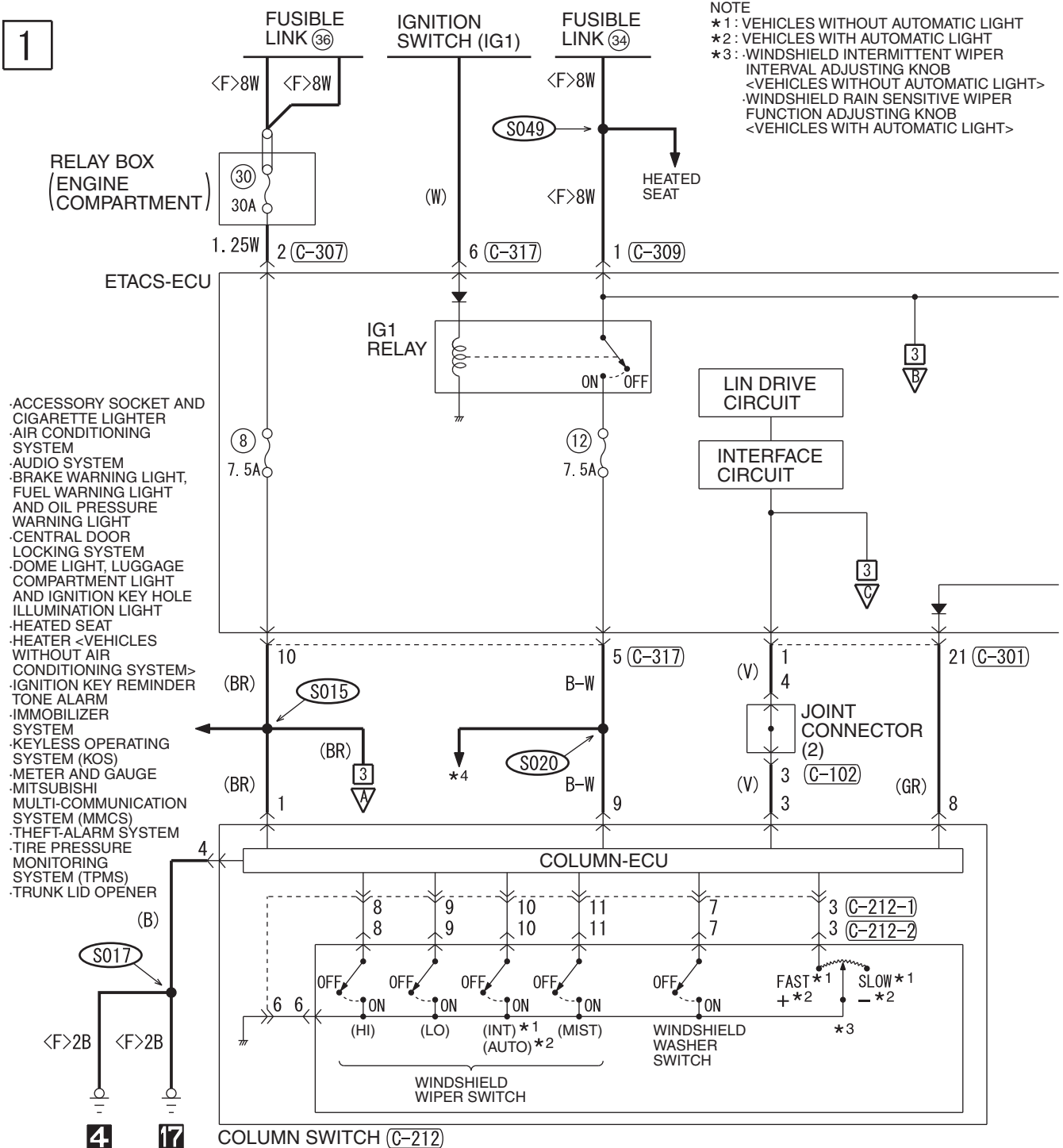

- ★4 : ·ABS, ASC, ACD, AYC AND S-AWC  
·AIR CONDITIONING SYSTEM  
·BRAKE WARNING LIGHT,  
FUEL WARNING LIGHT  
AND OIL PRESSURE  
WARNING LIGHT  
·CENTRAL DOOR LOCKING  
SYSTEM  
·CHARGING SYSTEM  
·COOLING SYSTEM  
·CRUISE CONTROL SYSTEM  
·DAYTIME RUNNING LIGHT (DRL)  
·DOME LIGHT, LUGGAGE  
COMPARTMENT LIGHT  
AND IGNITION KEY HOLE  
ILLUMINATION LIGHT

- DOOR AJAR WARNING TONE  
ALARM  
·HANDS-FREE  
CELLULAR PHONE SYSTEM  
·HEATED DOOR MIRROR  
·HEATED SEAT  
·HEATER <VEHICLES WITHOUT  
AIR CONDITIONING SYSTEM>  
·IGNITION KEY REMINDER TONE  
ALARM <VEHICLES WITH KOS>  
·IMMOBILIZER SYSTEM  
·KEYLESS OPERATING SYSTEM  
(KOS)  
·METER AND GAUGE  
·MFI SYSTEM  
·PARKING BRAKE  
WARNING TONE ALARM

- REAR WINDOW DEFOGGER  
·SEAT BELT WARNING  
TONE ALARM  
·SHIFT LOCK MECHANISM  
·SPARE CONNECTOR  
(FOR AUDIO)  
·SUNROOF  
·SUPPLEMENTAL RESTRAINT  
SYSTEM (SRS)  
·THEFT-ALARM SYSTEM  
·TIRE PRESSURE MONITORING  
SYSTEM (TPMS)  
·TRUNK LID OPENER  
·TWIN CLUTCH-SPORTRONIC SHIFT  
TRANSMISSION (TC-SST)

IGNITION SWITCH (ACC)

**2**

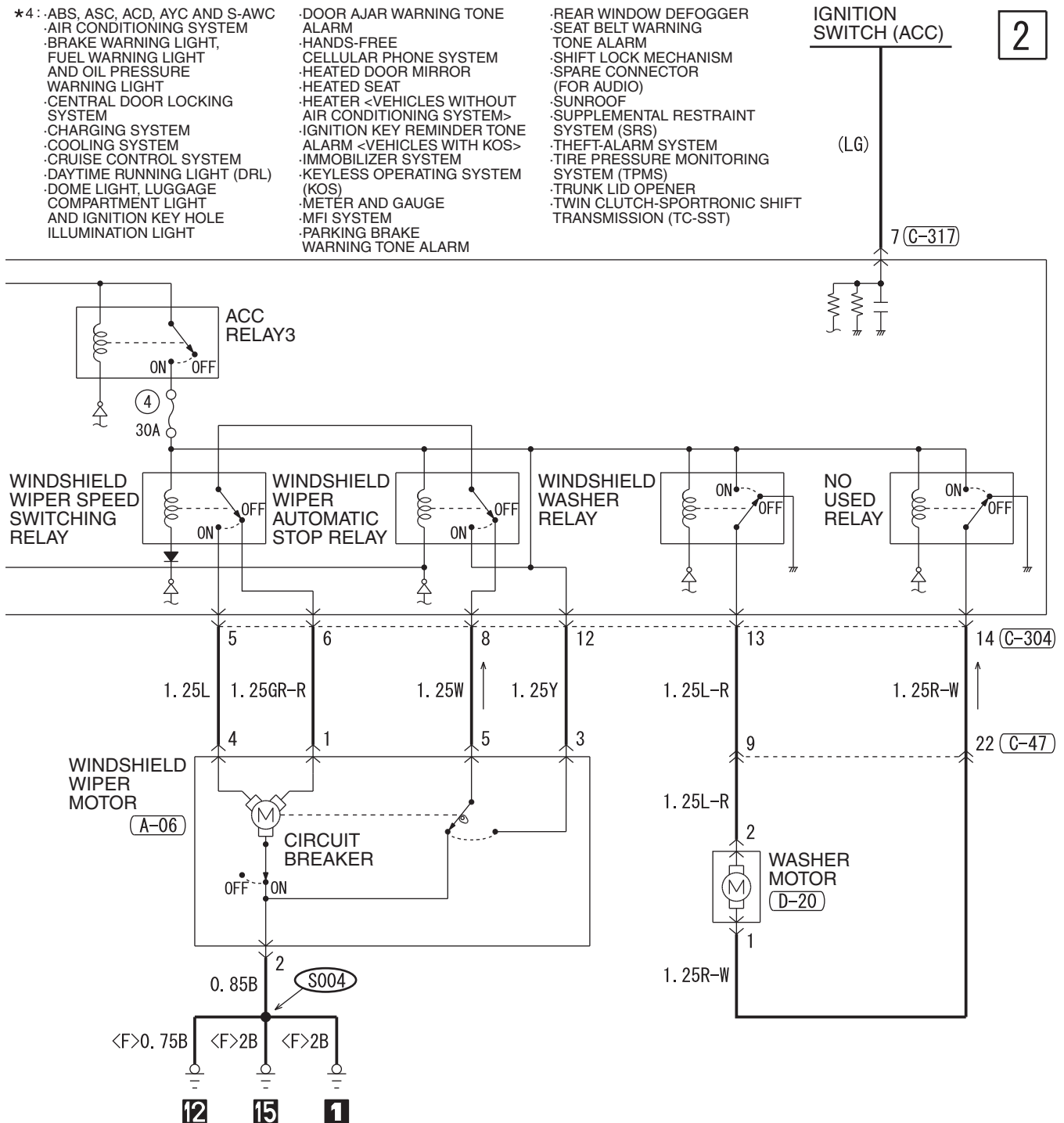

(C-212-2)

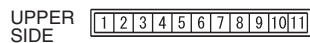

(C-301)

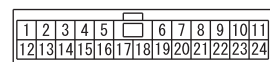

(C-304)

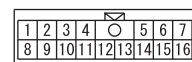

(C-307)



(C-309)



(C-317)

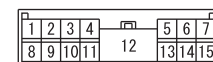

(D-20)



**WIRE COLOR CODE**

B : BLACK LG : LIGHT GREEN G : GREEN L : BLUE W : WHITE Y : YELLOW SB : SKY BLUE  
BR : BROWN O : ORANGE GR : GRAY R : RED P : PINK V : VIOLET PU : PURPLE SI : SILVER

HAH13M03AB

WINDSHIELD WIPER AND WASHER (CONTINUED)

3

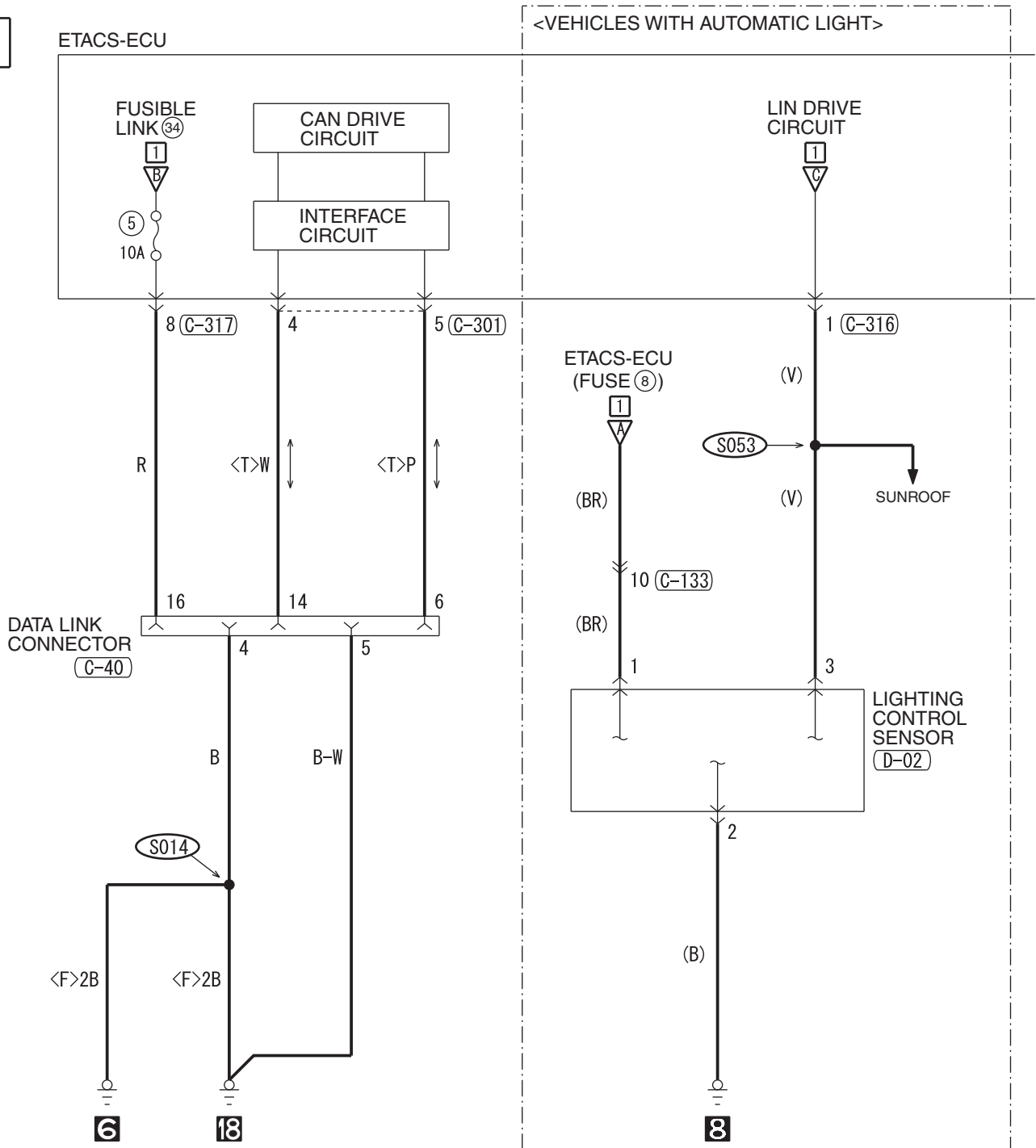

(A-05)

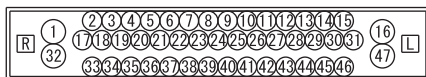

(C-40) FRONT SIDE

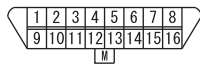

(C-104)

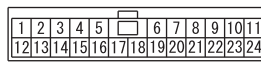

(C-127)

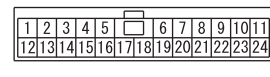

4

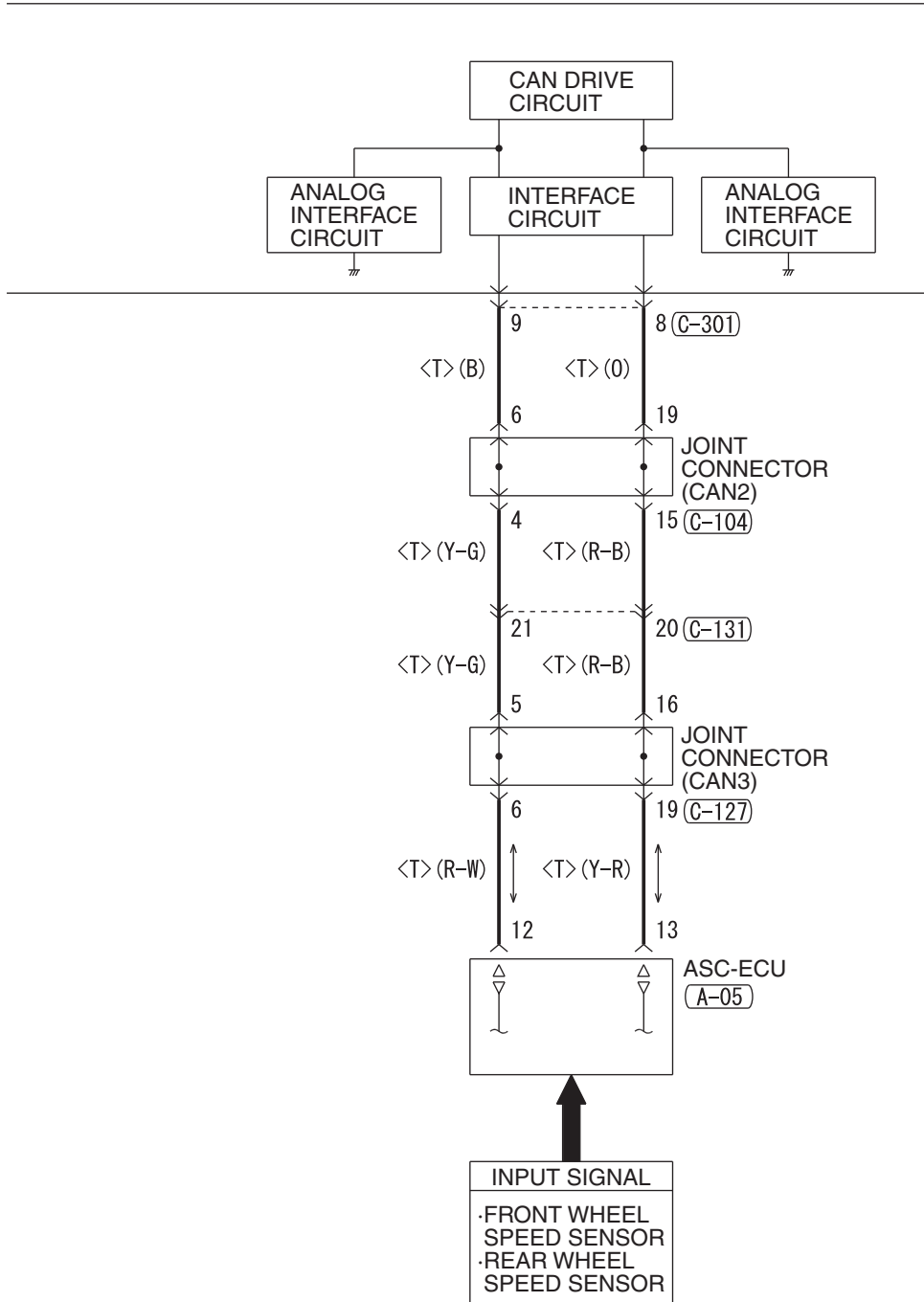

(C-131)

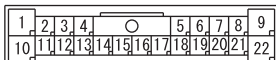

(C-133)

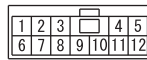

(C-301)

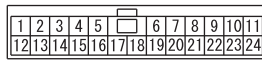

(C-316)



(C-317)



(D-02)



WIRE COLOR CODE

B : BLACK LG : LIGHT GREEN G : GREEN L : BLUE W : WHITE Y : YELLOW SB : SKY BLUE  
BR : BROWN O : ORANGE GR : GRAY R : RED P : PINK V : VIOLET PU : PURPLE SI : SILVER

HAH13M03BB

TSB Revision

# REMOTE CONTROLLED MIRROR

M1901006503130

1

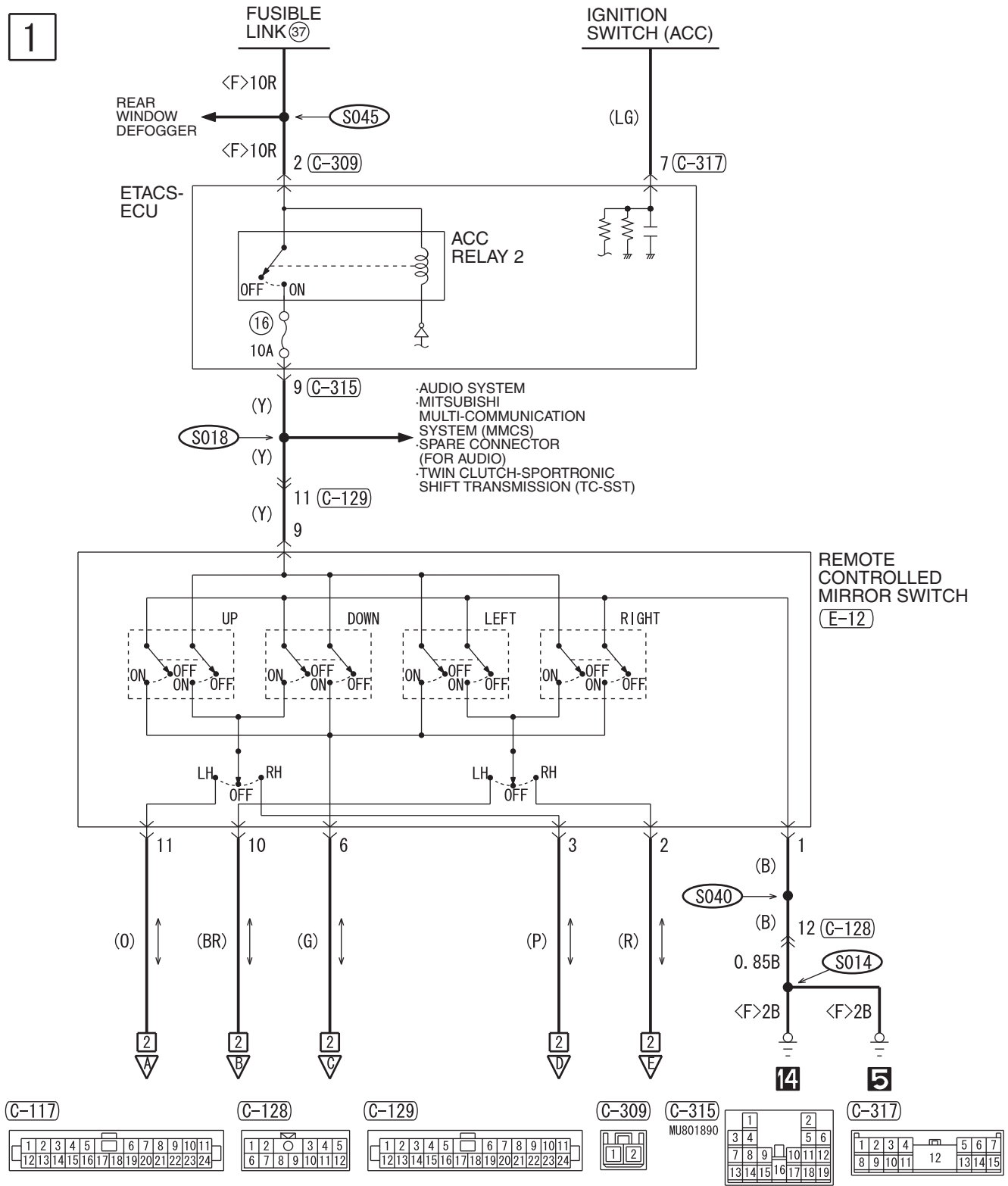



2

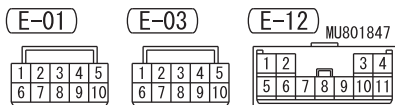
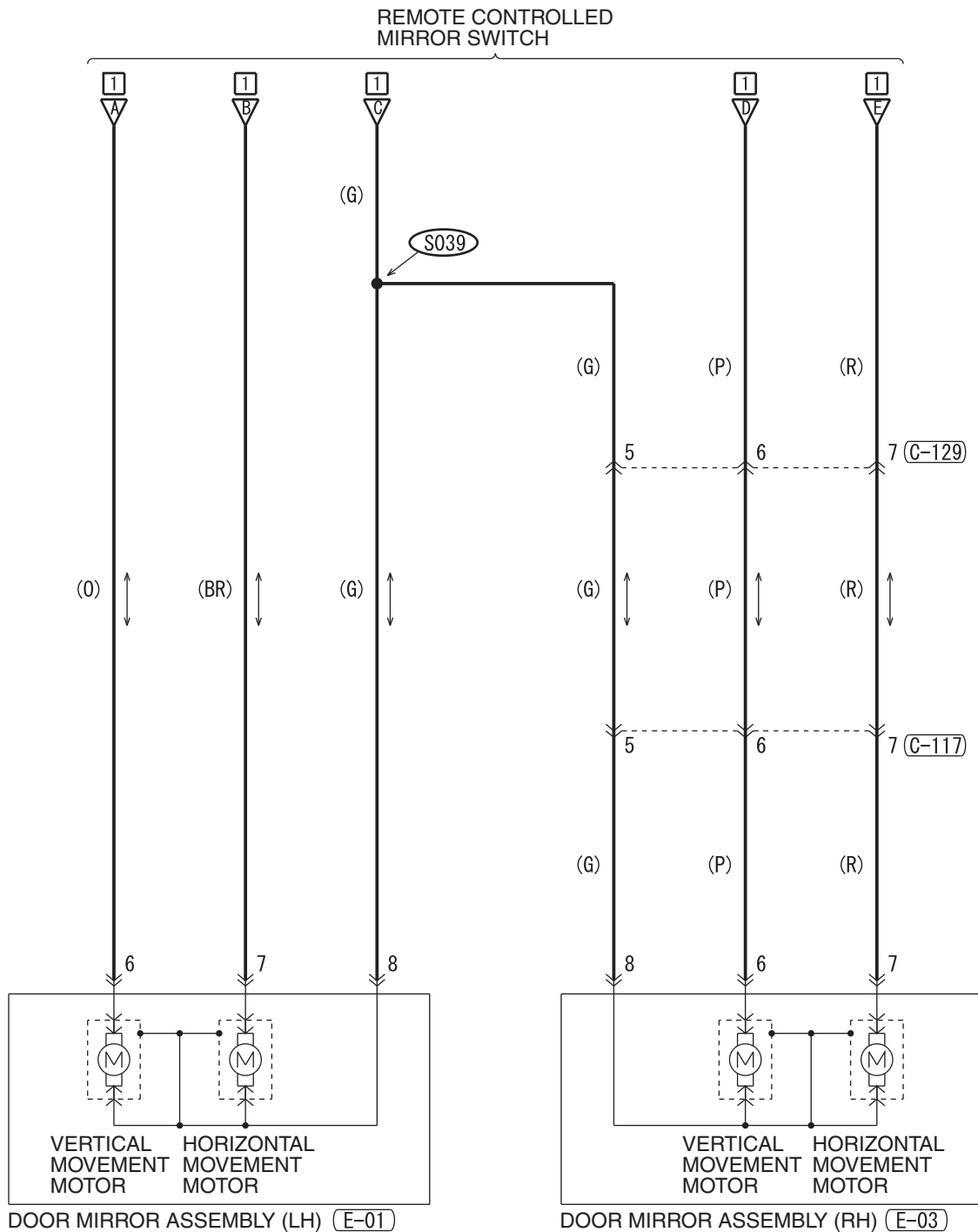

WIRE COLOR CODE  
 B : BLACK    LG : LIGHT GREEN    G : GREEN    L : BLUE    W : WHITE    Y : YELLOW    SB : SKY BLUE  
 BR : BROWN    O : ORANGE    GR : GRAY    R : RED    P : PINK    V : VIOLET    PU : PURPLE    SI : SILVER

HAH13M04AB

# REAR WINDOW DEFOGGER

M1901006402721

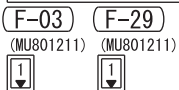
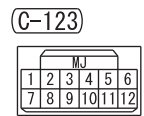
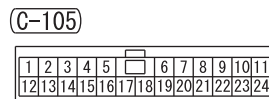
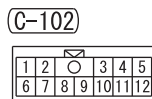
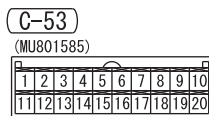
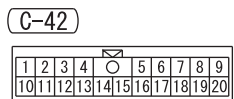
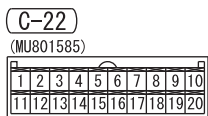
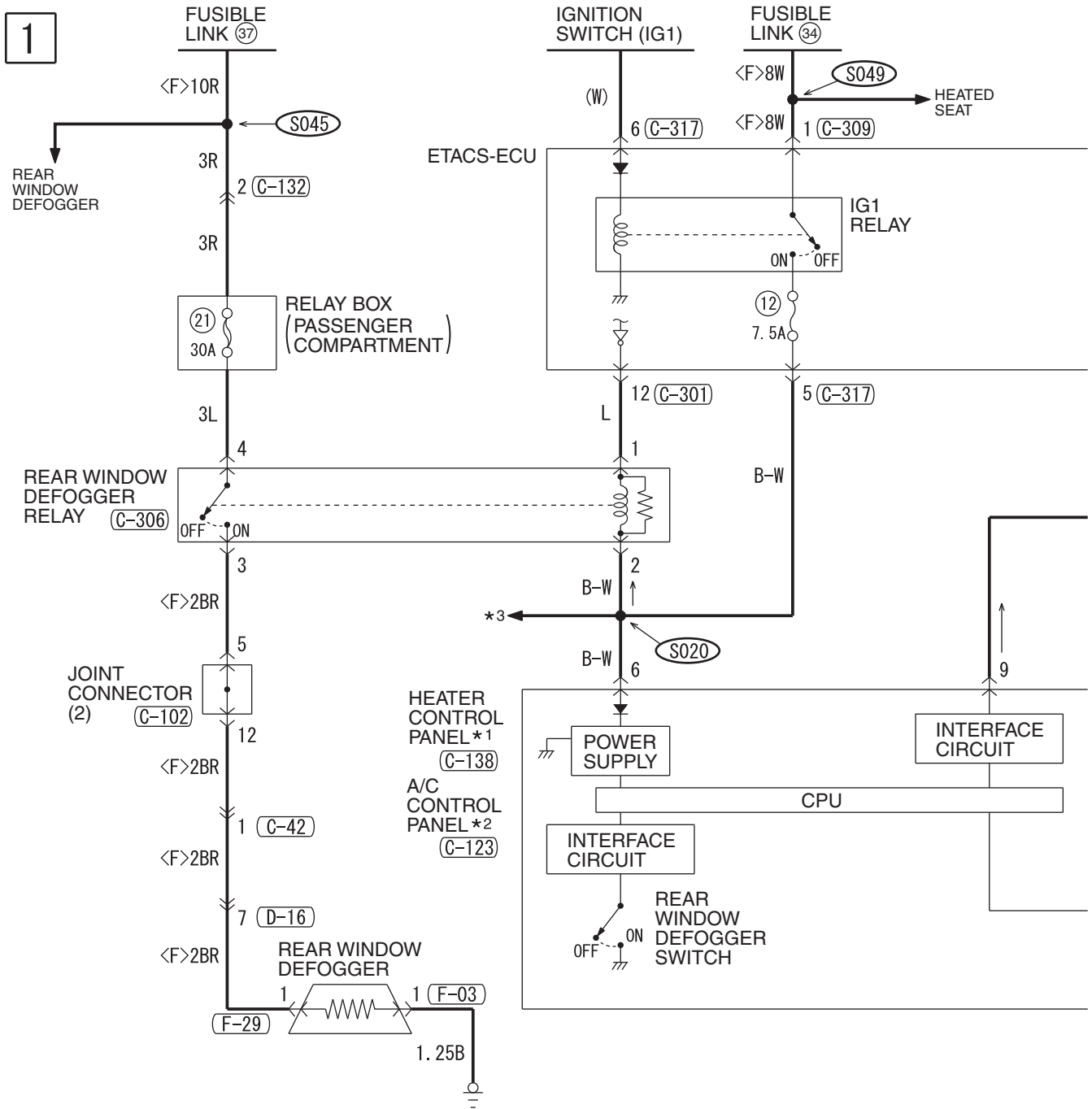

HAH13M05AA

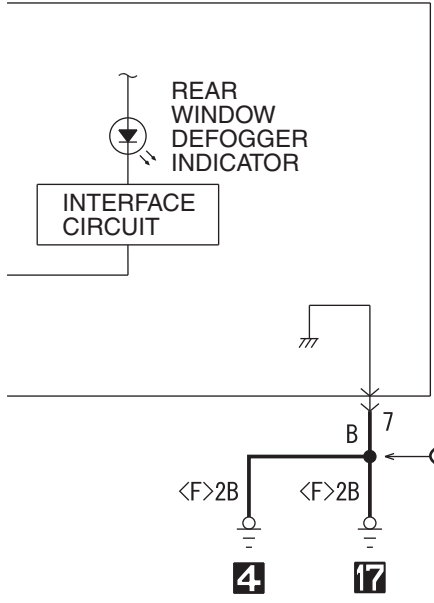
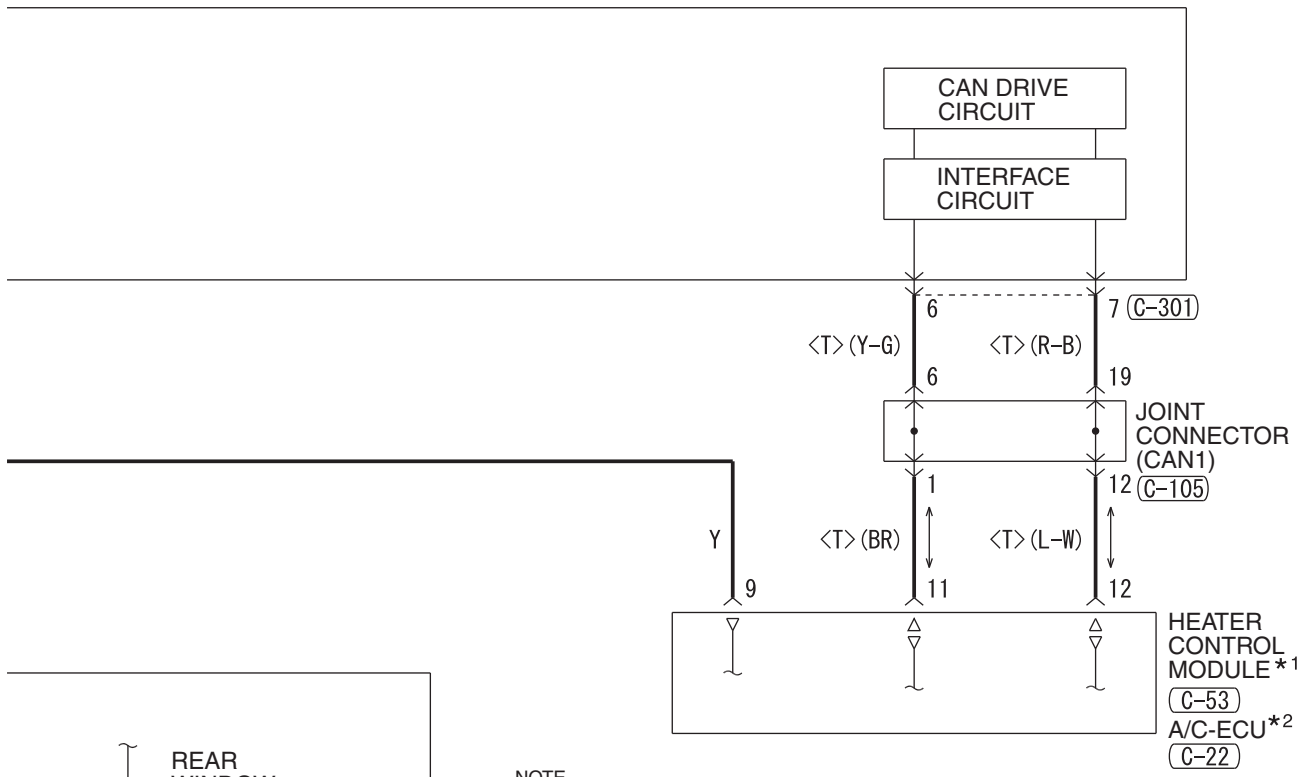

- NOTE**
- \*1: VEHICLES WITHOUT AIR CONDITIONING SYSTEM
  - \*2: VEHICLES WITH AIR CONDITIONING SYSTEM
  - \*3: ABS, ASC, ACD, AYC AND S-AWC
- AIR CONDITIONING SYSTEM
  - BRAKE WARNING LIGHT, FUEL WARNING LIGHT AND OIL PRESSURE WARNING LIGHT
  - CENTRAL DOOR LOCKING SYSTEM
  - CHARGING SYSTEM
  - COOLING SYSTEM
  - CRUISE CONTROL SYSTEM
  - DAYTIME RUNNING LIGHT (DRL)
  - DOME LIGHT, LUGGAGE COMPARTMENT LIGHT AND IGNITION KEY HOLE ILLUMINATION LIGHT
  - DOOR AJAR WARNING TONE ALARM
  - FOG LIGHT
  - HANDS-FREE CELLULAR PHONE SYSTEM
  - HEADLIGHT
  - HEATED DOOR MIRROR
  - HEATED SEAT
  - HEATER <VEHICLES WITHOUT AIR CONDITIONING SYSTEM>
  - IGNITION KEY REMINDER TONE ALARM <VEHICLES WITH KOS>
  - IMMOBILIZER SYSTEM
  - KEYLESS OPERATING SYSTEM (KOS)
  - METER AND GAUGE
  - MFI SYSTEM
  - PARKING BRAKE WARNING TONE ALARM
  - SEAT BELT WARNING TONE ALARM
  - SHIFT LOCK MECHANISM
  - SUNROOF
  - SUPPLEMENTAL RESTRAINT SYSTEM (SRS)
  - TAILLIGHT, POSITION LIGHT, REAR SIDE MARKER LIGHT, LICENSE PLATE LIGHT AND LIGHTING MONITOR TONE ALARM
  - THEFT-ALARM SYSTEM
  - TIRE PRESSURE MONITORING SYSTEM (TPMS)
  - TRUNK LID OPENER
  - TURN-SIGNAL LIGHT AND HAZARD WARNING LIGHT
  - TWIN CLUTCH-SPORTRONIC SHIFT TRANSMISSION (TC-SST)
  - WINDSHIELD WIPER AND WASHER

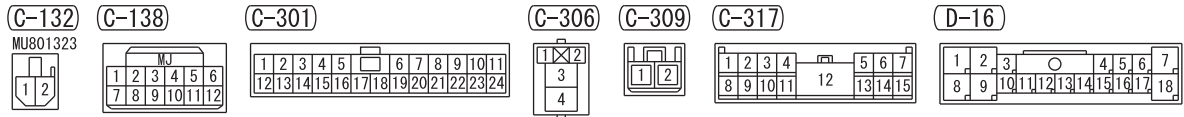

**WIRE COLOR CODE**  
 B : BLACK LG : LIGHT GREEN G : GREEN L : BLUE W : WHITE Y : YELLOW SB : SKY BLUE  
 BR : BROWN O : ORANGE GR : GRAY R : RED P : PINK V : VIOLET PU : PURPLE SI : SILVER

# HEATED DOOR MIRROR

M1901018300361

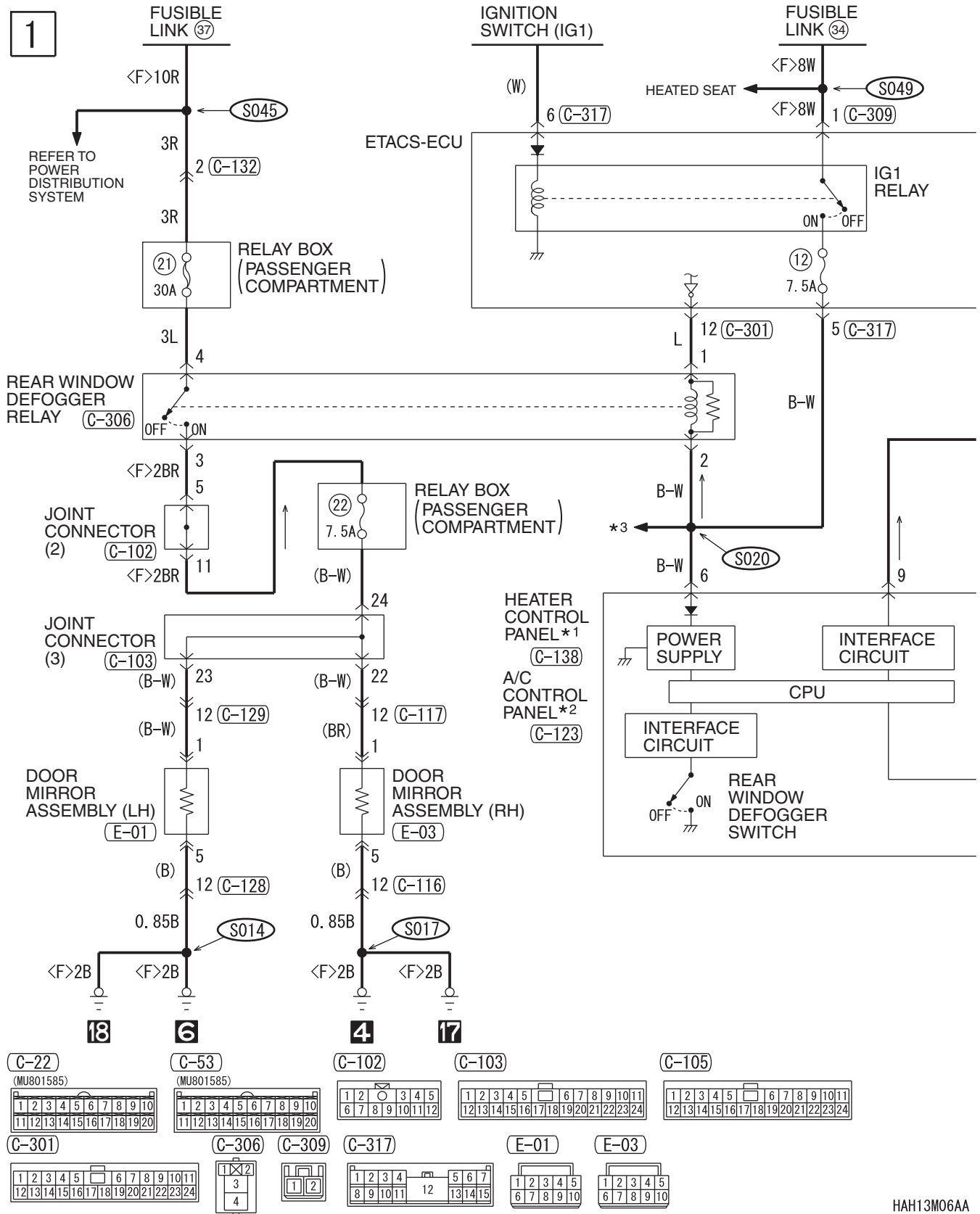

HAH13M06AA

2

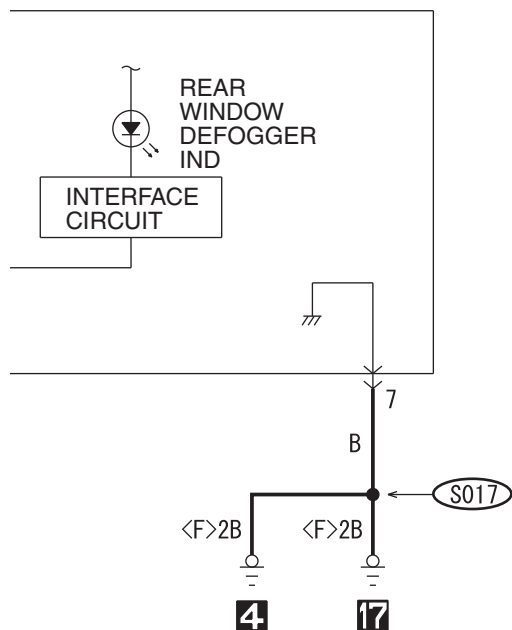
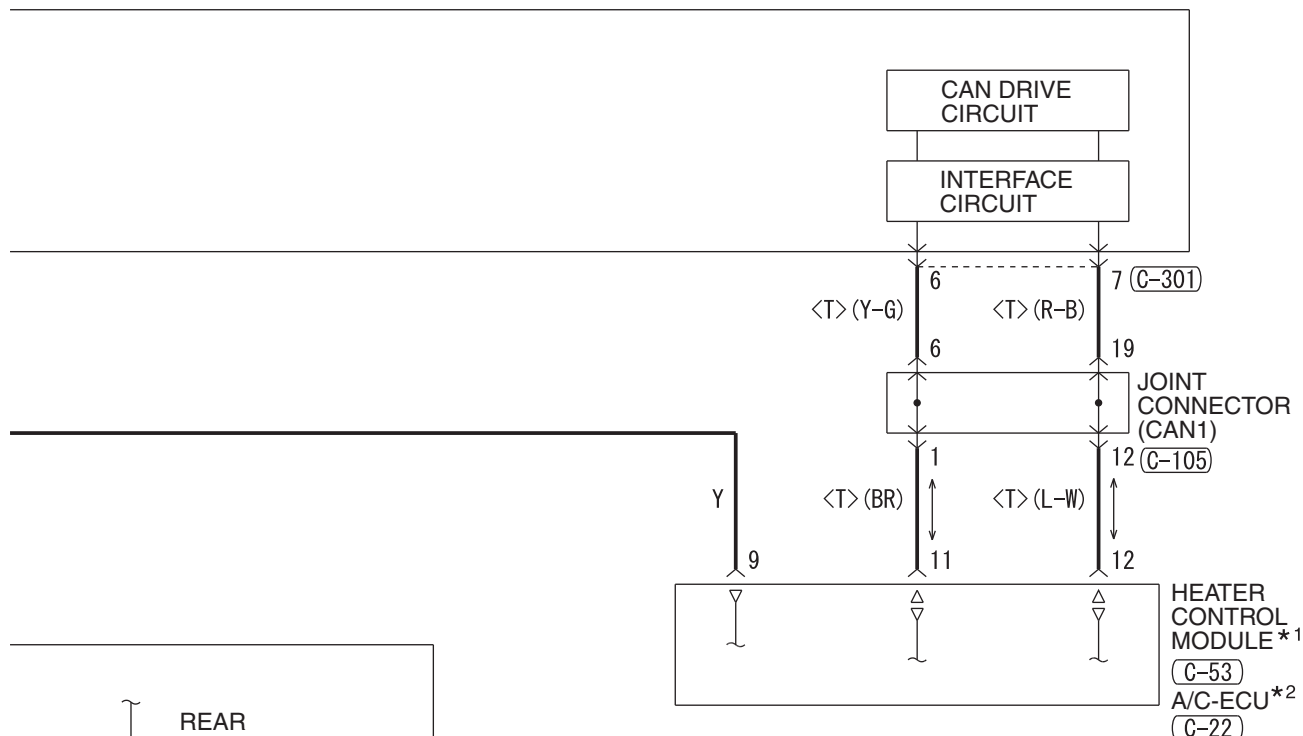

NOTE

- \* 1 : VEHICLES WITHOUT AIR CONDITIONING SYSTEM
- \* 2 : VEHICLES WITH AIR CONDITIONING SYSTEM
- \* 3 : -ABS, ASC, ACD, AYC AND S-AWC  
-AIR CONDITIONING SYSTEM  
-BRAKE WARNING LIGHT, FUEL WARNING LIGHT AND OIL PRESSURE WARNING LIGHT  
-CENTRAL DOOR LOCKING SYSTEM  
-CHARGING SYSTEM  
-COOLING SYSTEM  
-CRUISE CONTROL SYSTEM  
-DAYTIME RUNNING LIGHT (DRL)  
-DOME LIGHT, LUGGAGE COMPARTMENT LIGHT AND IGNITION KEY HOLE ILLUMINATION LIGHT  
-DOOR AJAR WARNING TONE ALARM  
-FOG LIGHT  
-HANDS-FREE CELLULAR PHONE SYSTEM  
-HEADLIGHT  
-HEATED SEAT  
-HEATER <VEHICLES WITHOUT AIR CONDITIONING SYSTEM>
- IGNITION KEY REMINDER TONE ALARM <VEHICLES WITH KOS>
- IMMOBILIZER SYSTEM
- KEYLESS OPERATING SYSTEM (KOS)
- METER AND GAUGE
- MFI SYSTEM
- PARKING BRAKE WARNING TONE ALARM
- SEAT BELT WARNING TONE ALARM
- SHIFT LOCK MECHANISM
- SUNROOF
- SUPPLEMENTAL RESTRAINT SYSTEM (SRS)
- TAILLIGHT, POSITION LIGHT, REAR SIDE MARKER LIGHT, LICENSE PLATE LIGHT AND LIGHTING MONITOR TONE ALARM
- THEFT-ALARM SYSTEM
- TIRE PRESSURE MONITORING SYSTEM (TPMS)
- TRUNK LID OPENER
- TURN-SIGNAL LIGHT AND HAZARD WARNING LIGHT
- TWIN CLUTCH-SPORTTRONIC SHIFT TRANSMISSION (TC-SST)
- WINDSHIELD WIPER AND WASHER

(C-116)

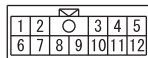

(C-117)

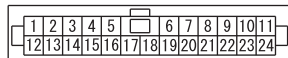

(C-123)

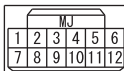

(C-128)

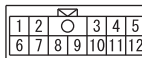

(C-129)

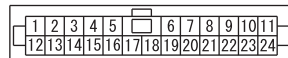

(C-132)



(C-138)

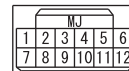

WIRE COLOR CODE

B : BLACK LG : LIGHT GREEN G : GREEN L : BLUE W : WHITE Y : YELLOW SB : SKY BLUE  
BR : BROWN O : ORANGE GR : GRAY R : RED P : PINK V : VIOLET PU : PURPLE SI : SILVER

HAH13M06AB

# AUDIO SYSTEM <VEHICLES WITHOUT AUDIO AMPLIFIER>

M1901015605614

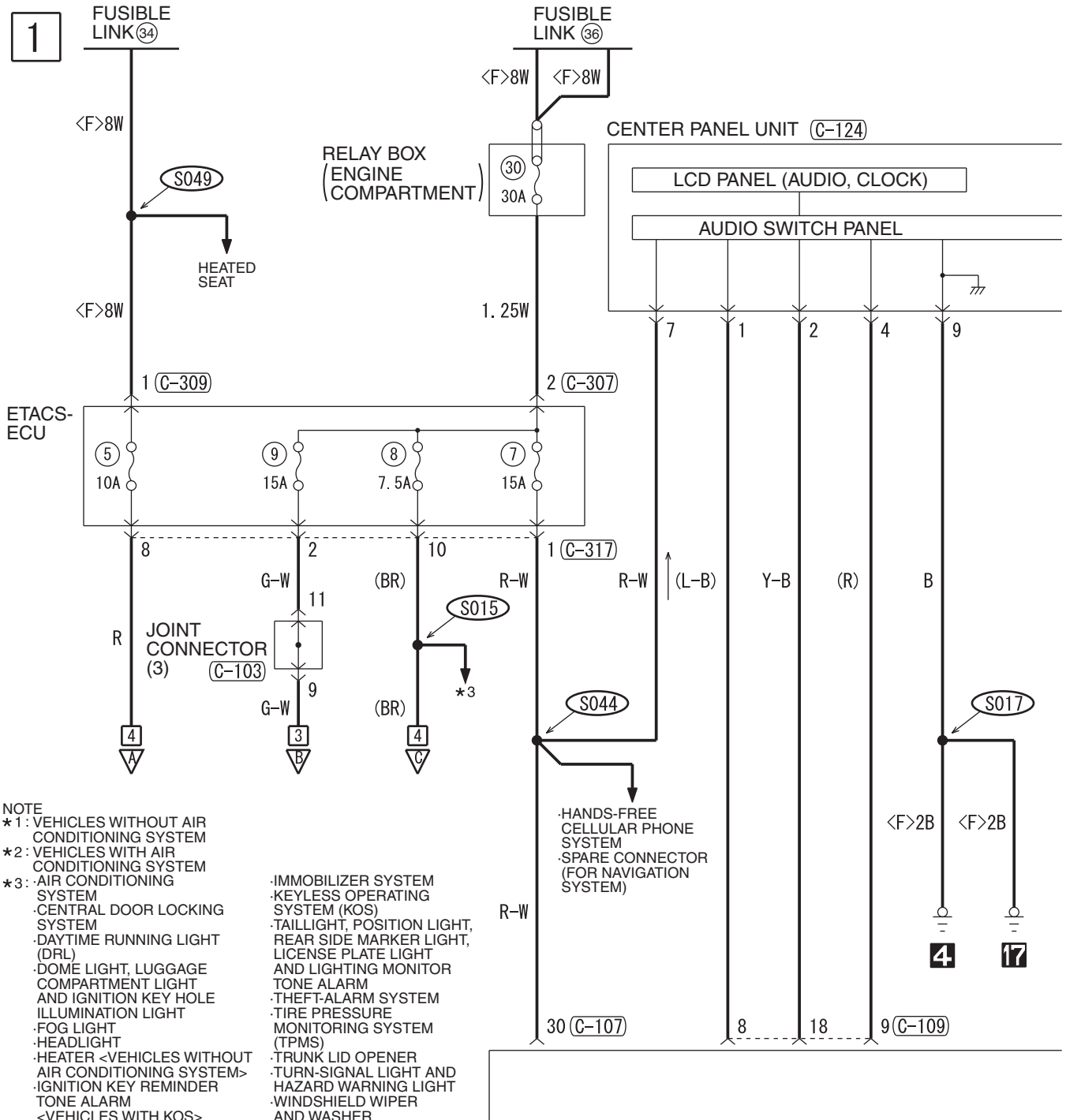

(C-101)

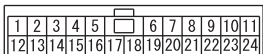

(C-103)



(C-107)

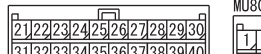

(C-109)

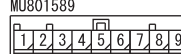

(C-118)



(C-123)

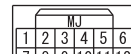

2

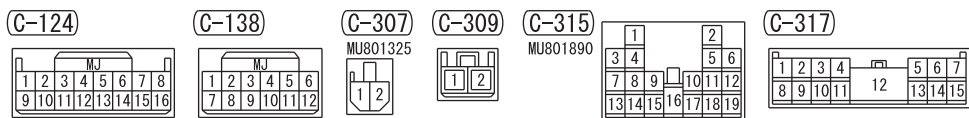
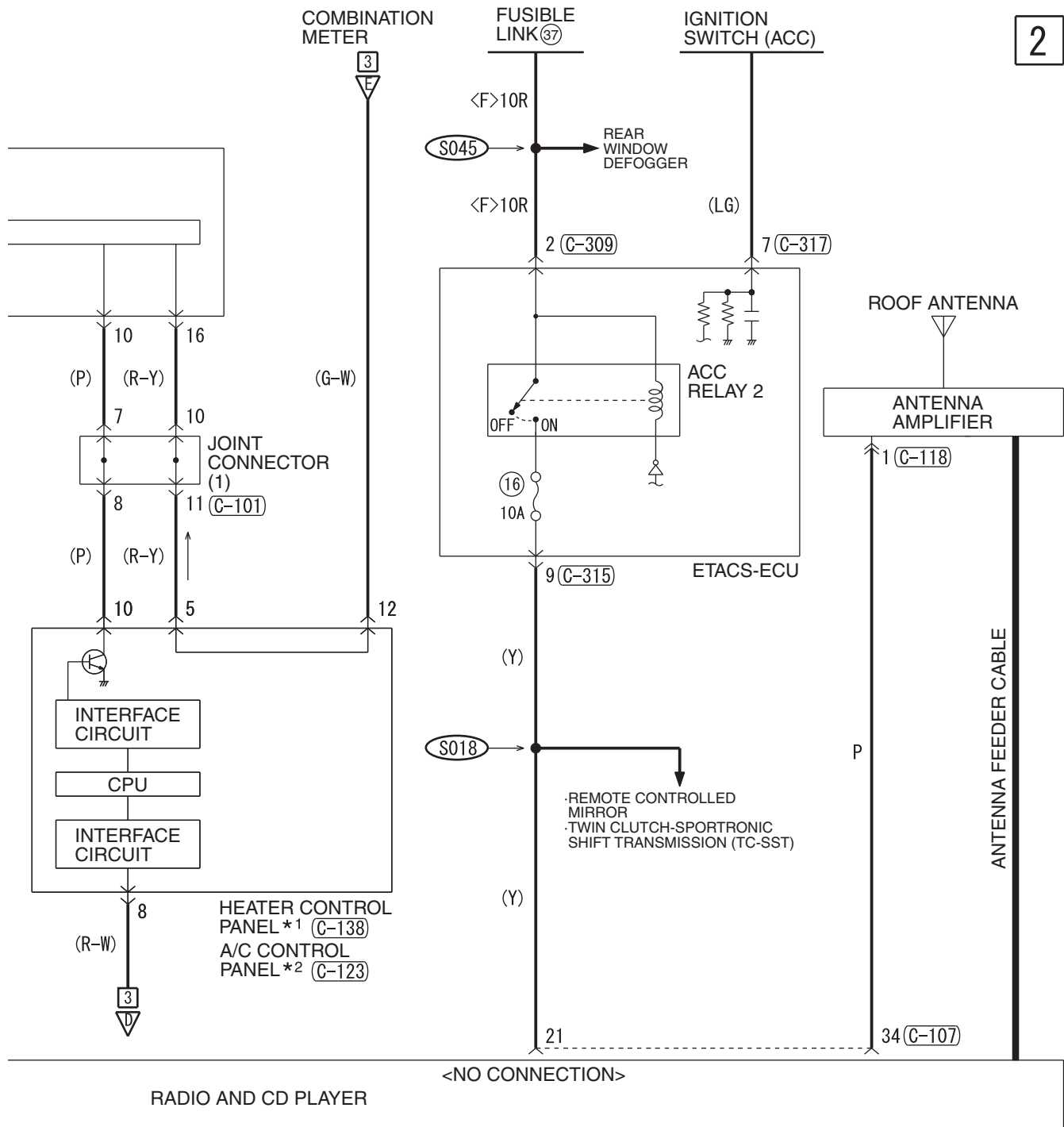

**WIRE COLOR CODE**  
 B : BLACK LG : LIGHT GREEN G : GREEN L : BLUE W : WHITE Y : YELLOW SB : SKY BLUE  
 BR : BROWN O : ORANGE GR : GRAY R : RED P : PINK V : VIOLET PU : PURPLE SI : SILVER

HAH14M04AB

AUDIO SYSTEM <VEHICLES WITHOUT AUDIO AMPLIFIER> (CONTINUED)

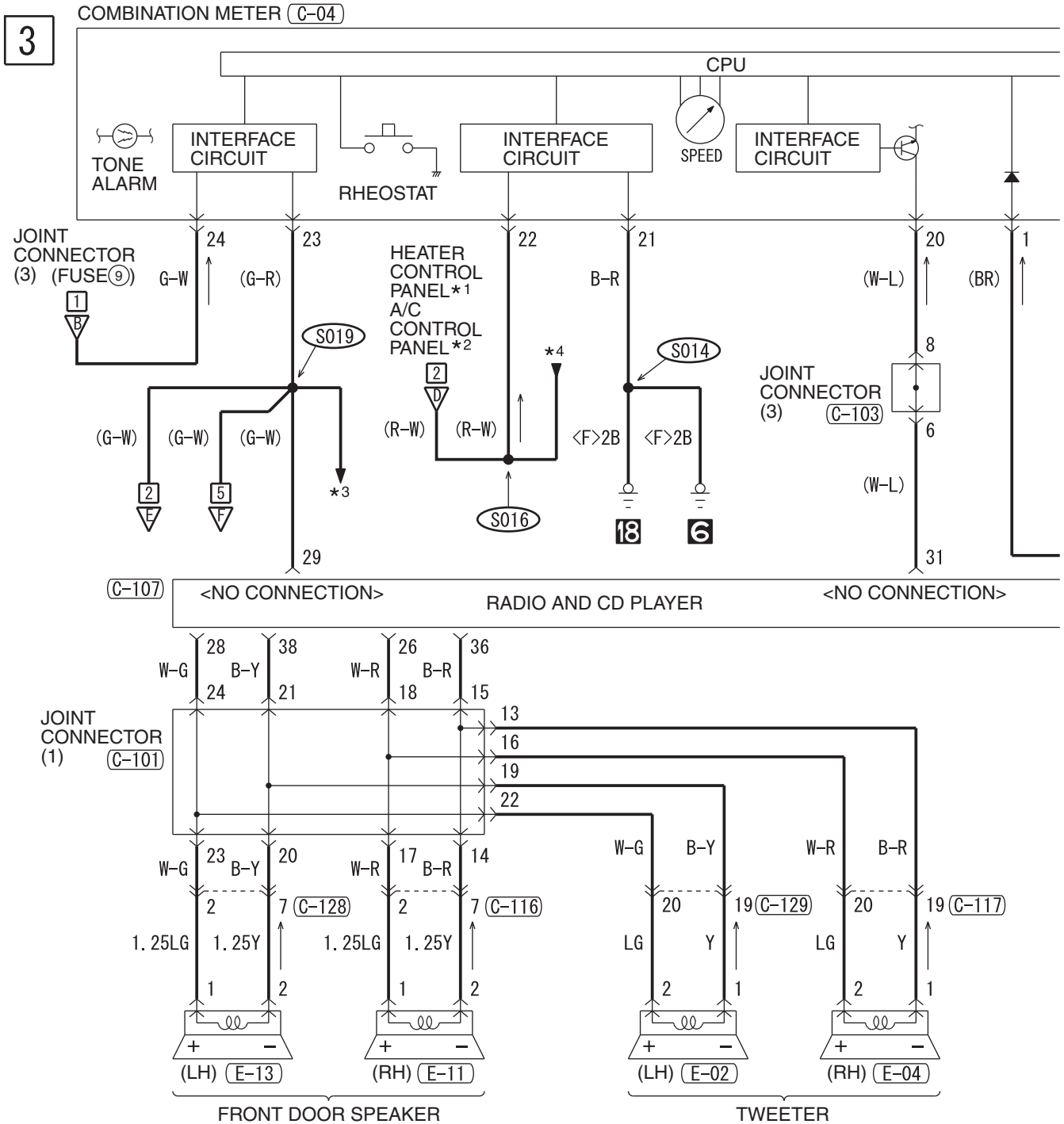

C-04

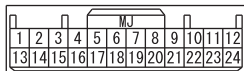

C-23

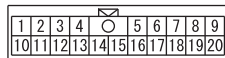

C-40 FRONT SIDE

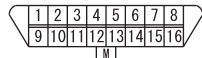

C-42

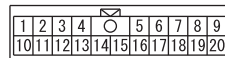

C-101

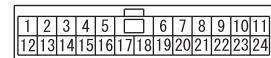

C-128

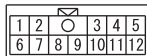

C-129

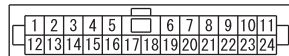

C-301

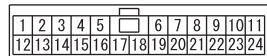

D-01

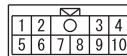

D-24

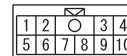

E-02 E-04





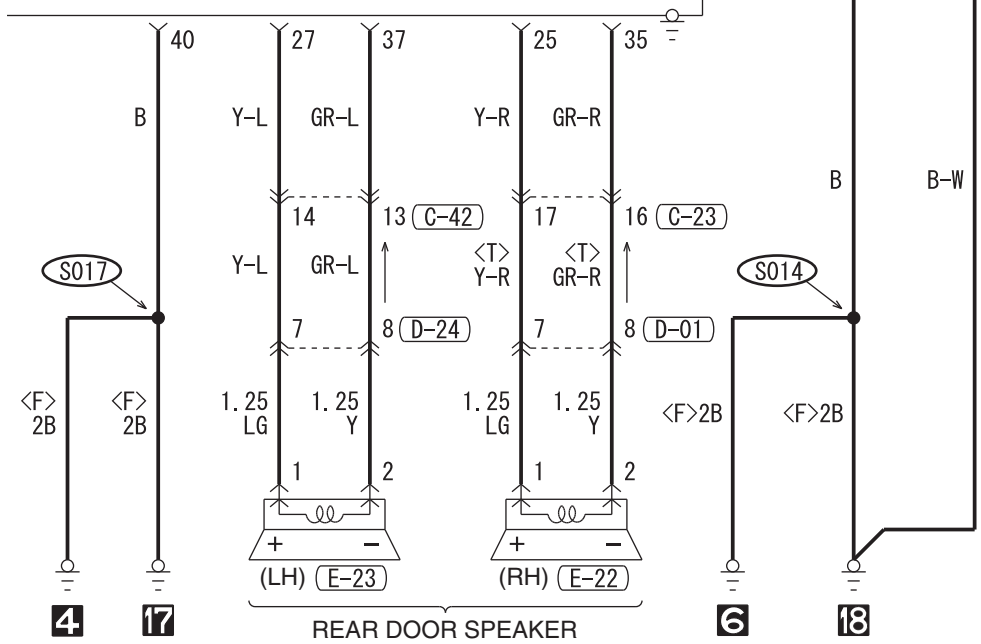
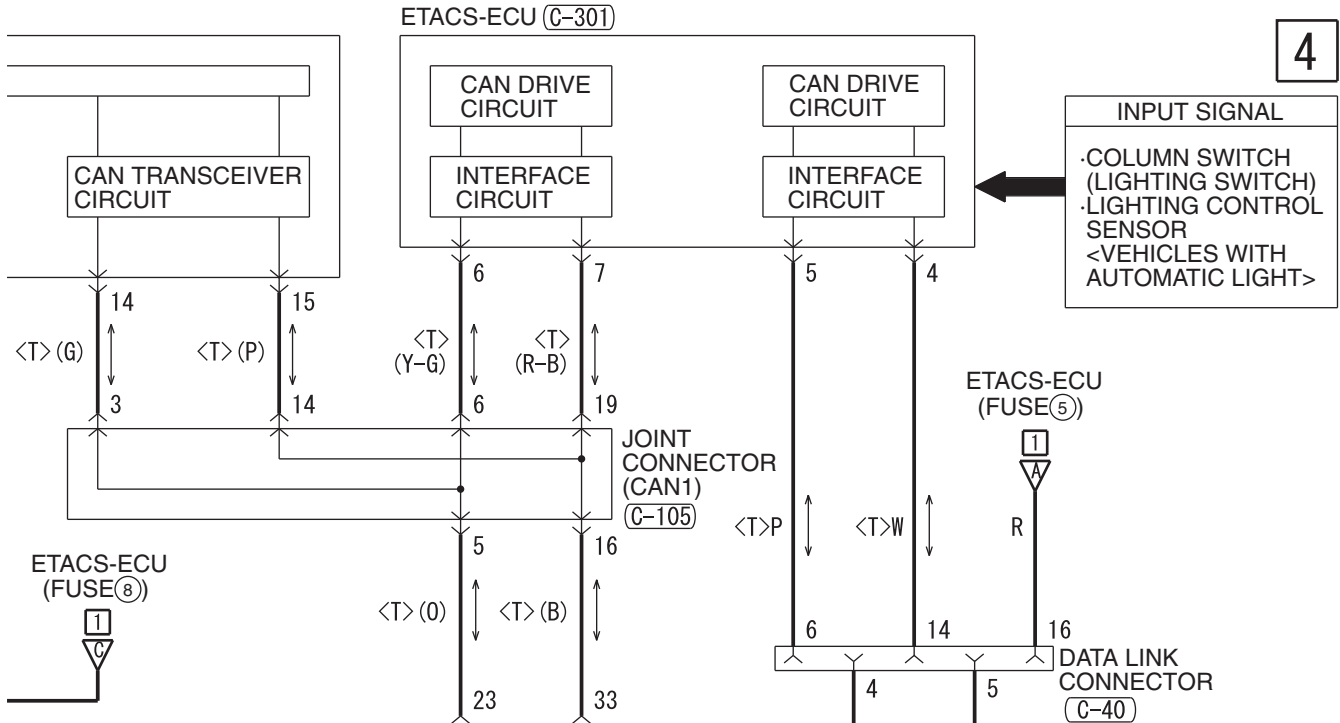

- NOTE
- \*1 : VEHICLES WITHOUT AIR CONDITIONING SYSTEM
  - \*2 : VEHICLES WITH AIR CONDITIONING SYSTEM
  - \*3 : ABS, ASC, ACD, AYC AND S-AWC  
 · ACCESSORY SOCKET AND CIGARETTE LIGHTER  
 · AIR CONDITIONING SYSTEM  
 · HEADLIGHT LEVELING SYSTEM  
 · HEATED SEAT  
 · HEATER <VEHICLES WITHOUT AIR CONDITIONING SYSTEM>  
 · TURN-SIGNAL LIGHT AND HAZARD WARNING LIGHT  
 · TWIN CLUTCH-SPORTRONIC SHIFT TRANSMISSION (TC-SST)
  - \*4 : ABS, ASC, ACD, AYC AND S-AWC  
 · ACCESSORY SOCKET AND CIGARETTE LIGHTER  
 · HEADLIGHT LEVELING SYSTEM  
 · HEATED SEAT

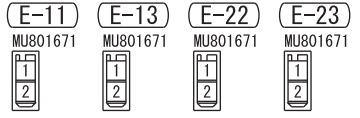
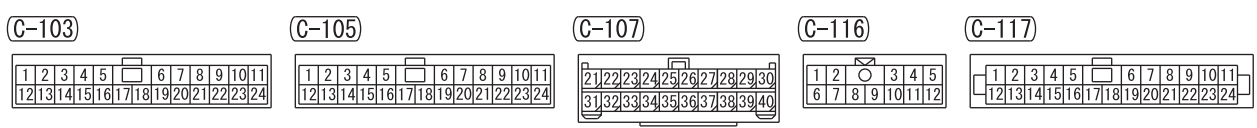

**WIRE COLOR CODE**  
 B : BLACK   LG : LIGHT GREEN   G : GREEN   L : BLUE   W : WHITE  
 Y : YELLOW   SB : SKY BLUE   BR : BROWN   O : ORANGE   GR : GRAY  
 R : RED   P : PINK   V : VIOLET   PU : PURPLE   SI : SILVER

AUDIO SYSTEM <VEHICLES WITHOUT AUDIO AMPLIFIER> (CONTINUED)

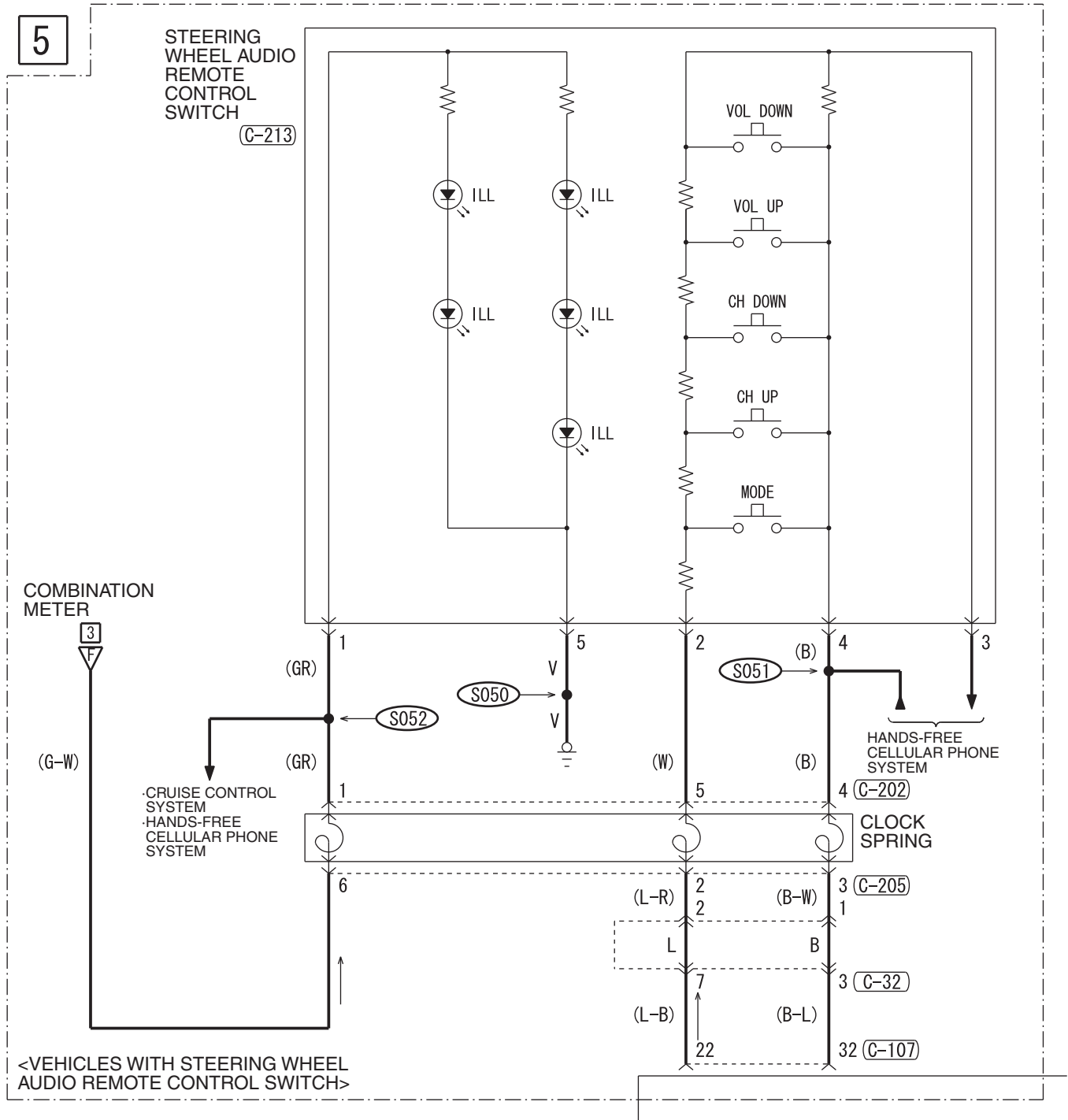

C-32

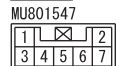

C-107

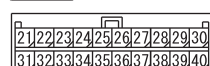

C-109

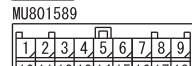

C-125

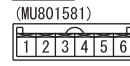

C-202

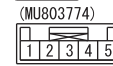

C-205

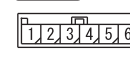

C-213

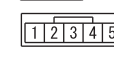

6

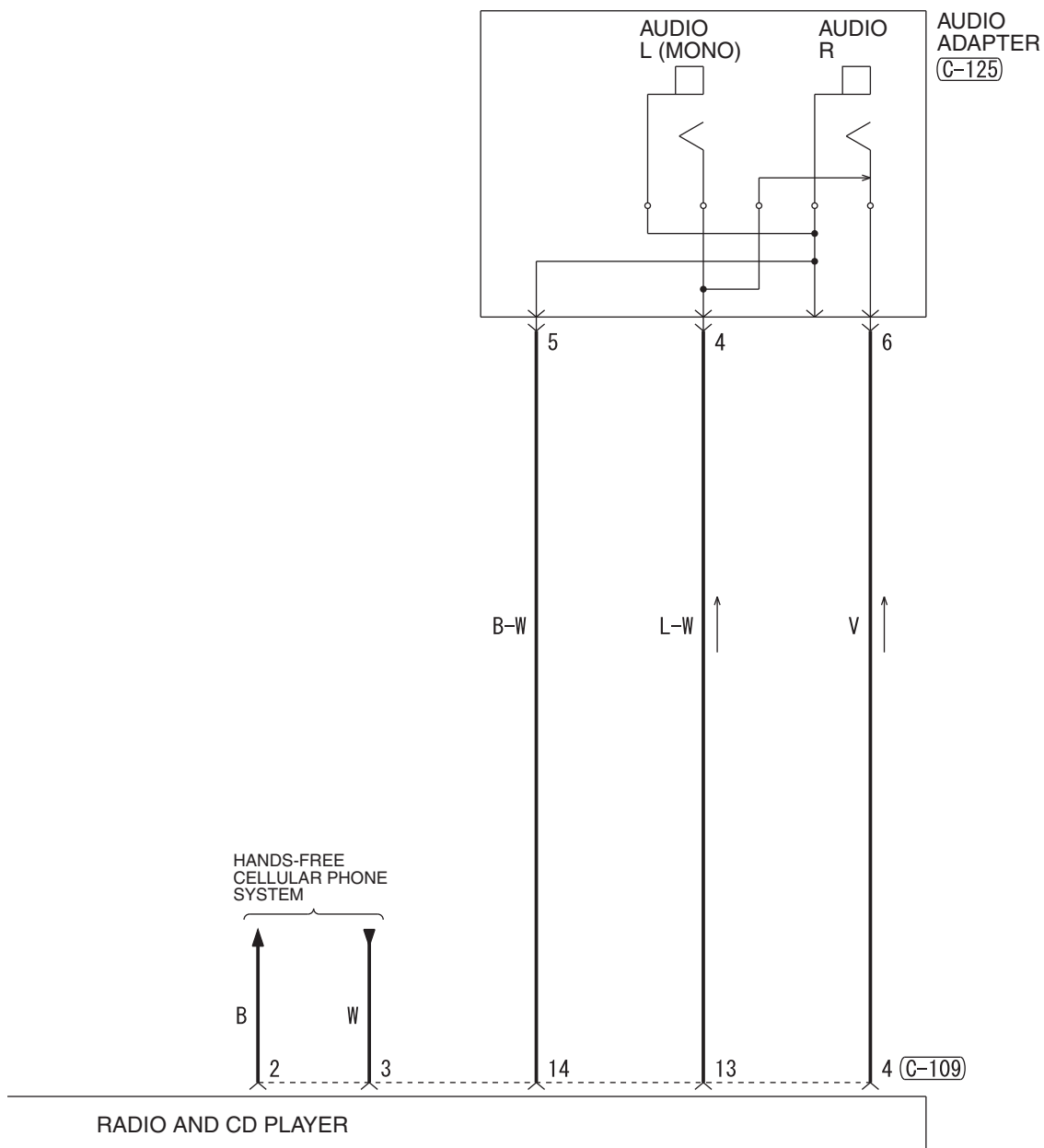

WIRE COLOR CODE  
 B: BLACK LG: LIGHT GREEN G: GREEN L: BLUE W: WHITE Y: YELLOW SB: SKY BLUE  
 BR: BROWN O: ORANGE GR: GRAY R: RED P: PINK V: VIOLET PU: PURPLE SI: SILVER

HAH14M04CB

TSB Revision

**AUDIO SYSTEM <VEHICLES WITH AUDIO AMPLIFIER>**

M1901015605625

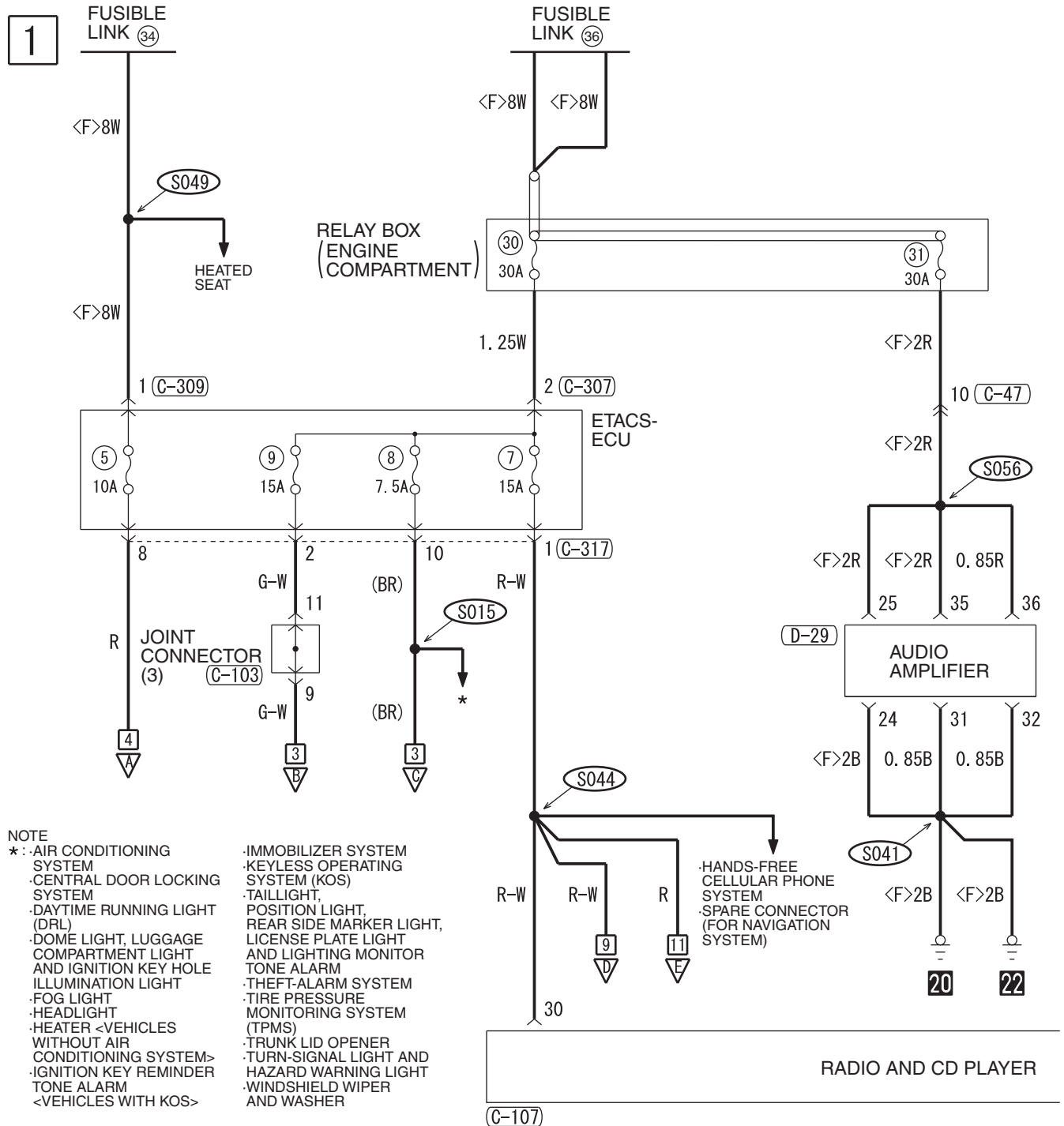

- NOTE
- \* : AIR CONDITIONING SYSTEM
  - CENTRAL DOOR LOCKING SYSTEM
  - DAYTIME RUNNING LIGHT (DRL)
  - DOME LIGHT, LUGGAGE COMPARTMENT LIGHT AND IGNITION KEY HOLE ILLUMINATION LIGHT
  - FOG LIGHT
  - HEADLIGHT
  - HEATER <VEHICLES WITHOUT AIR CONDITIONING SYSTEM>
  - IGNITION KEY REMINDER TONE ALARM <VEHICLES WITH KOS>

- IMMOBILIZER SYSTEM
- KEYLESS OPERATING SYSTEM (KOS)
- TAILLIGHT, POSITION LIGHT, REAR SIDE MARKER LIGHT, LICENSE PLATE LIGHT AND LIGHTING MONITOR TONE ALARM
- THEFT-ALARM SYSTEM
- TIRE PRESSURE MONITORING SYSTEM (TPMS)
- TRUNK LID OPENER
- TURN-SIGNAL LIGHT AND HAZARD WARNING LIGHT
- WINDSHIELD WIPER AND WASHER

- HANDS-FREE CELLULAR PHONE SYSTEM
- SPARE CONNECTOR (FOR NAVIGATION SYSTEM)

C-47

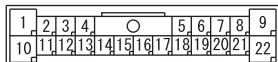

C-103

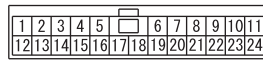

C-107

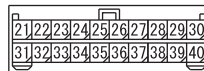

C-118



C-307



C-309



C-315



2

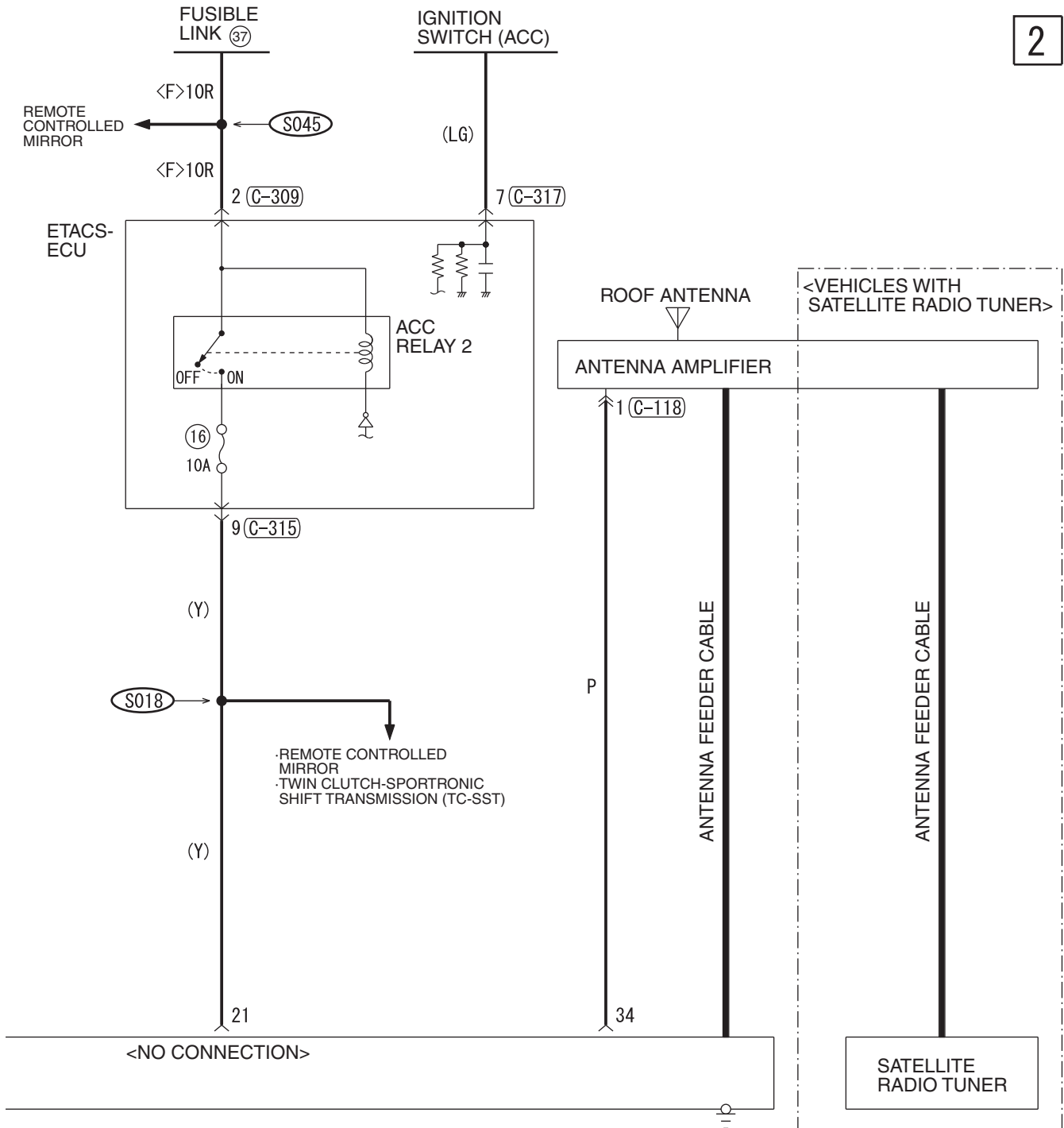

(C-317)

1	2	3	4	5	6	7	
8	9	10	11	12	13	14	15

(D-29)

MU801455

21	22	23	24	25	26	27	28		
29	30	31	32	33	34	35	36	37	38

WIRE COLOR CODE

B : BLACK LG : LIGHT GREEN G : GREEN L : BLUE W : WHITE Y : YELLOW SB : SKY BLUE  
BR : BROWN O : ORANGE GR : GRAY R : RED P : PINK V : VIOLET PU : PURPLE SI : SILVER

HAH14M05AB

AUDIO SYSTEM <VEHICLES WITH AUDIO AMPLIFIER> (CONTINUED)

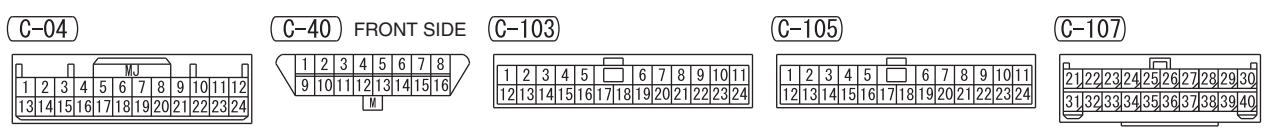
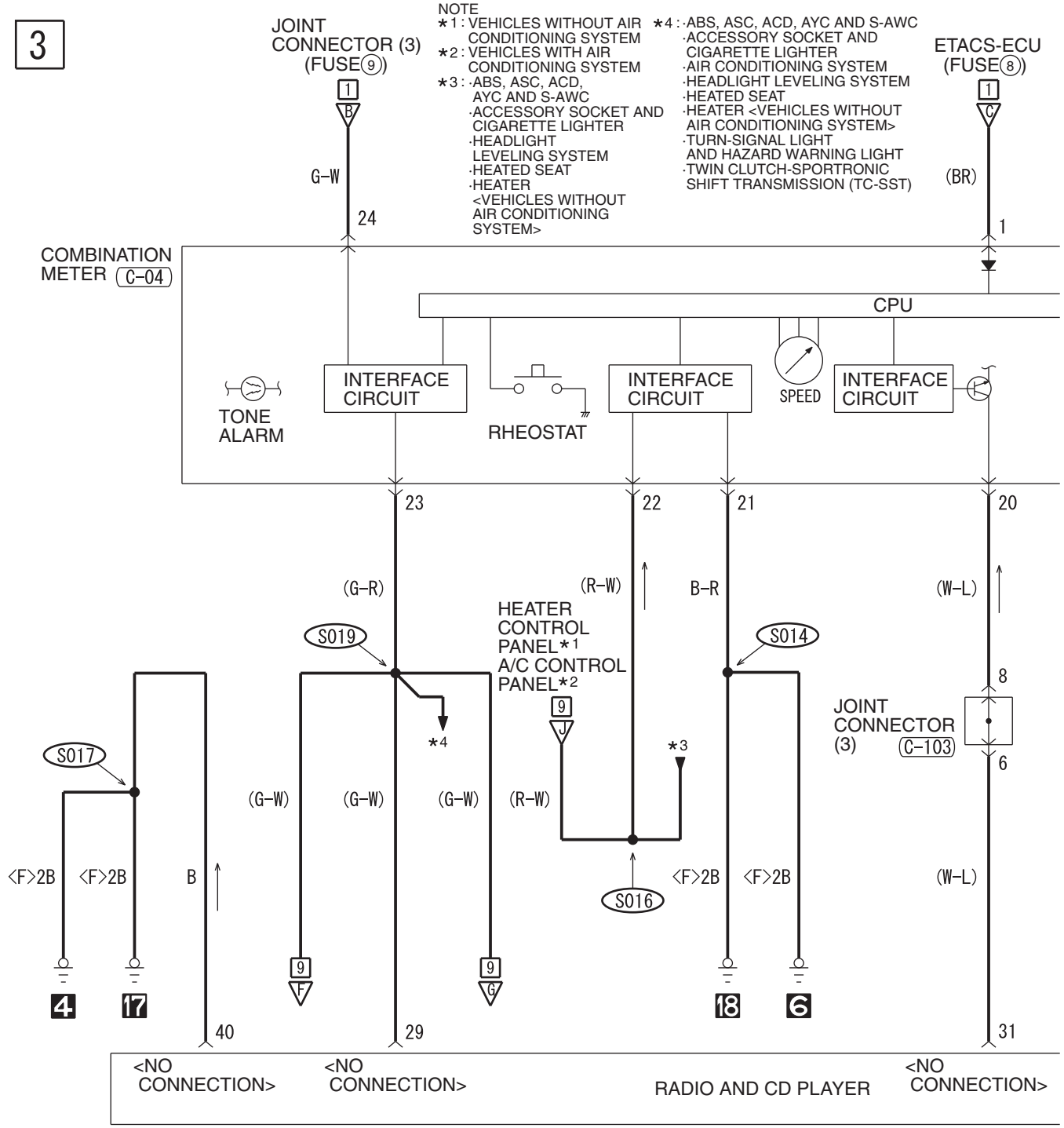

4

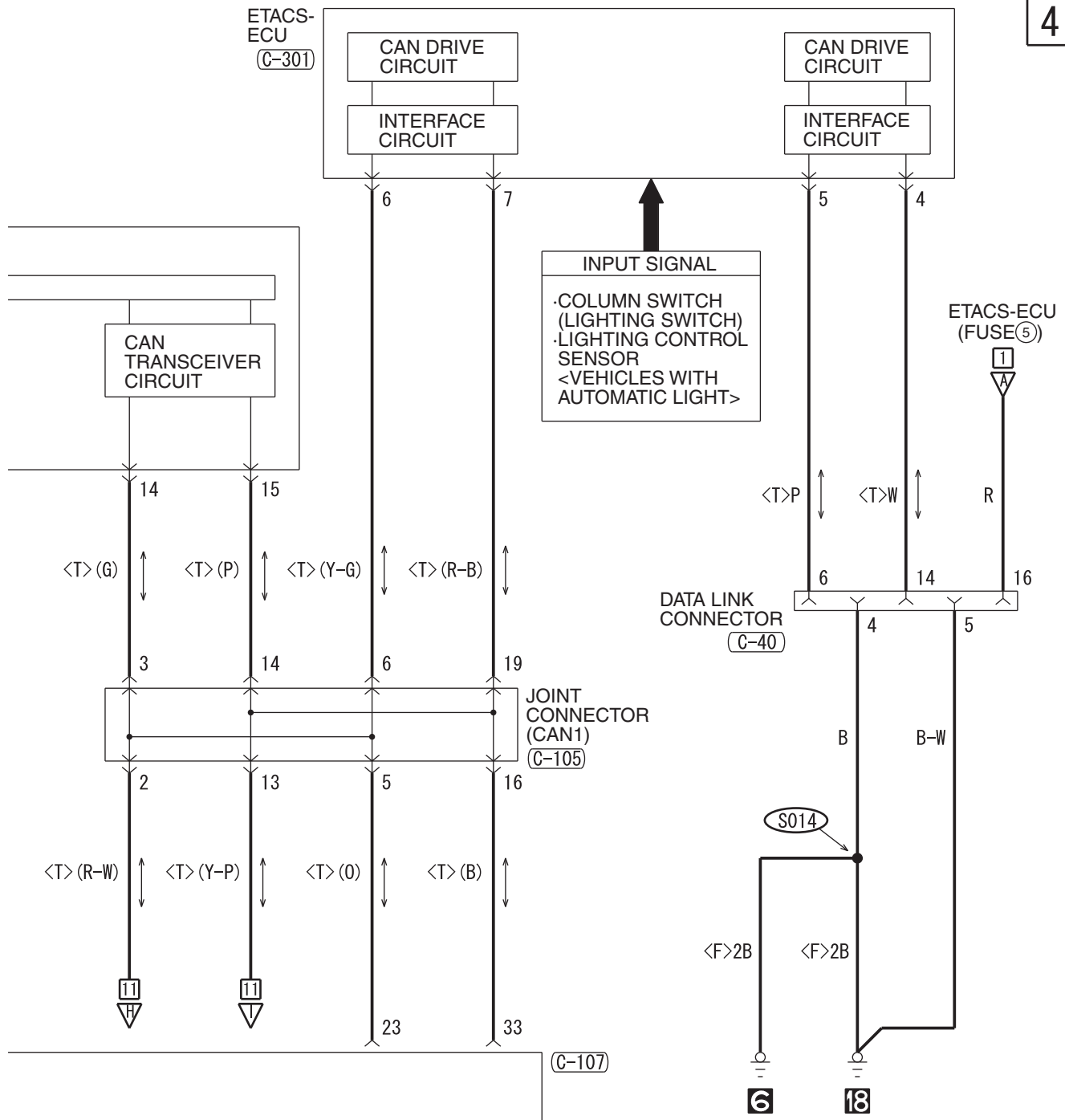

(C-301)

1	2	3	4	5	6	7	8	9	10	11		
12	13	14	15	16	17	18	19	20	21	22	23	24

WIRE COLOR CODE

B : BLACK LG : LIGHT GREEN G : GREEN L : BLUE W : WHITE Y : YELLOW SB : SKY BLUE  
BR : BROWN O : ORANGE GR : GRAY R : RED P : PINK V : VIOLET PU : PURPLE SI : SILVER

HAH14M05BB

TSB Revision

AUDIO SYSTEM <VEHICLES WITH AUDIO AMPLIFIER> (CONTINUED)

5

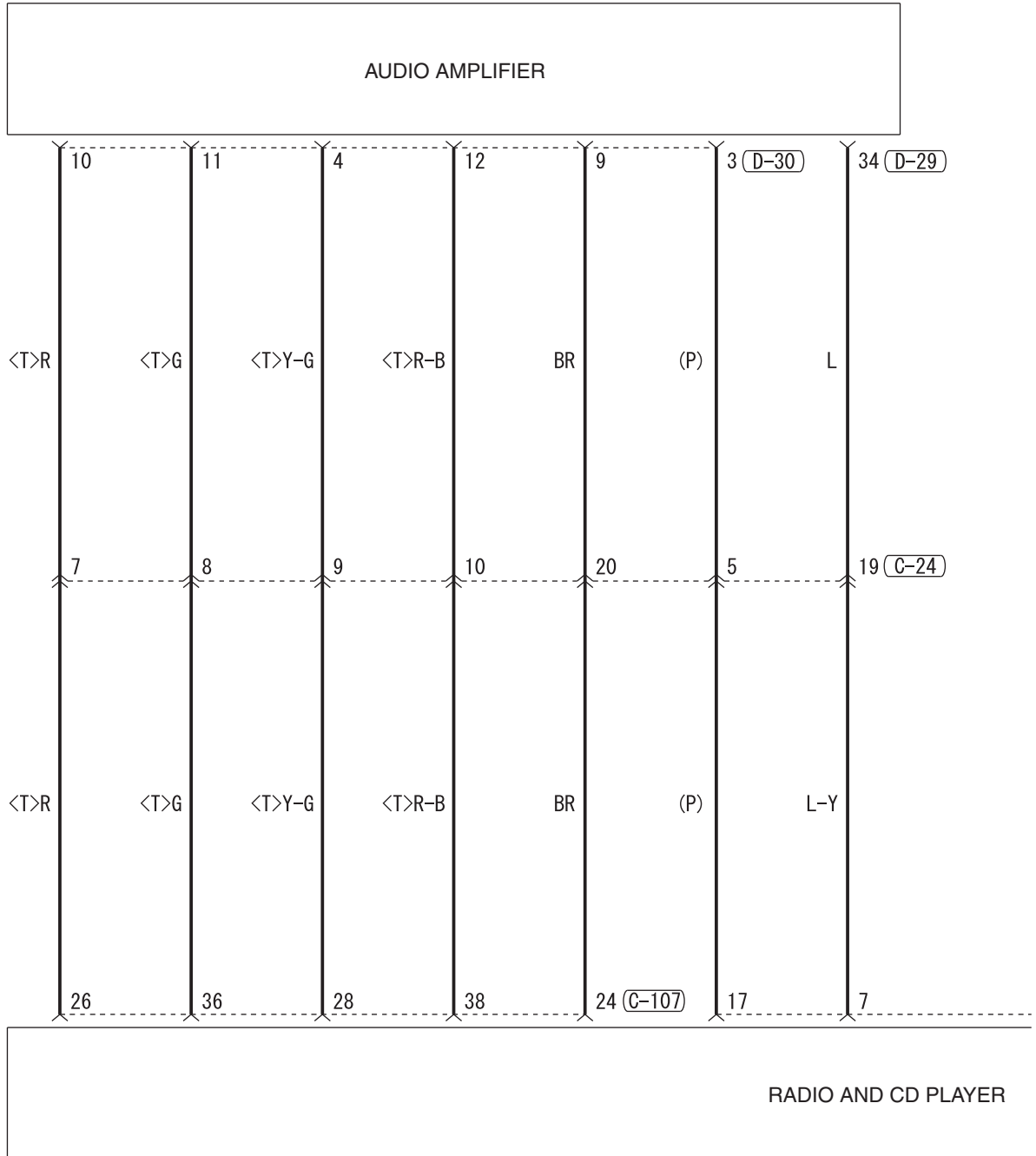

(C-24)

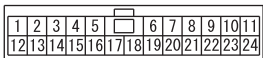

(C-107)

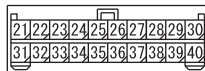

(C-109)

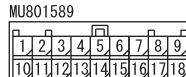

(C-125)

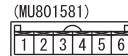

(D-29)

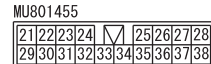

(D-30)

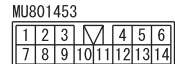



6

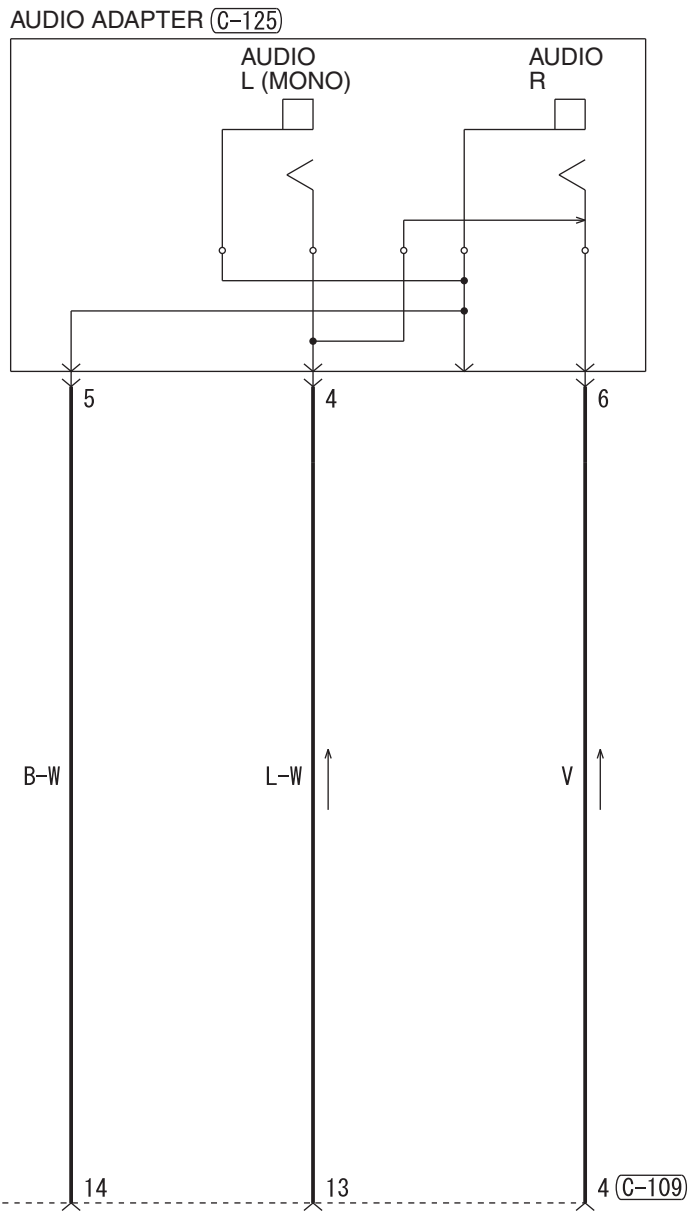

WIRE COLOR CODE  
 B: BLACK LG: LIGHT GREEN G: GREEN L: BLUE W: WHITE Y: YELLOW SB: SKY BLUE  
 BR: BROWN O: ORANGE GR: GRAY R: RED P: PINK V: VIOLET PU: PURPLE SI: SILVER

HAH14M05CB

TSB Revision

AUDIO SYSTEM <VEHICLES WITH AUDIO AMPLIFIER> (CONTINUED)

7

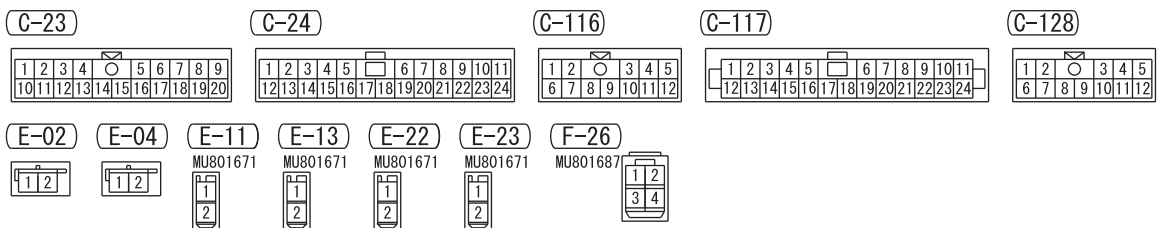
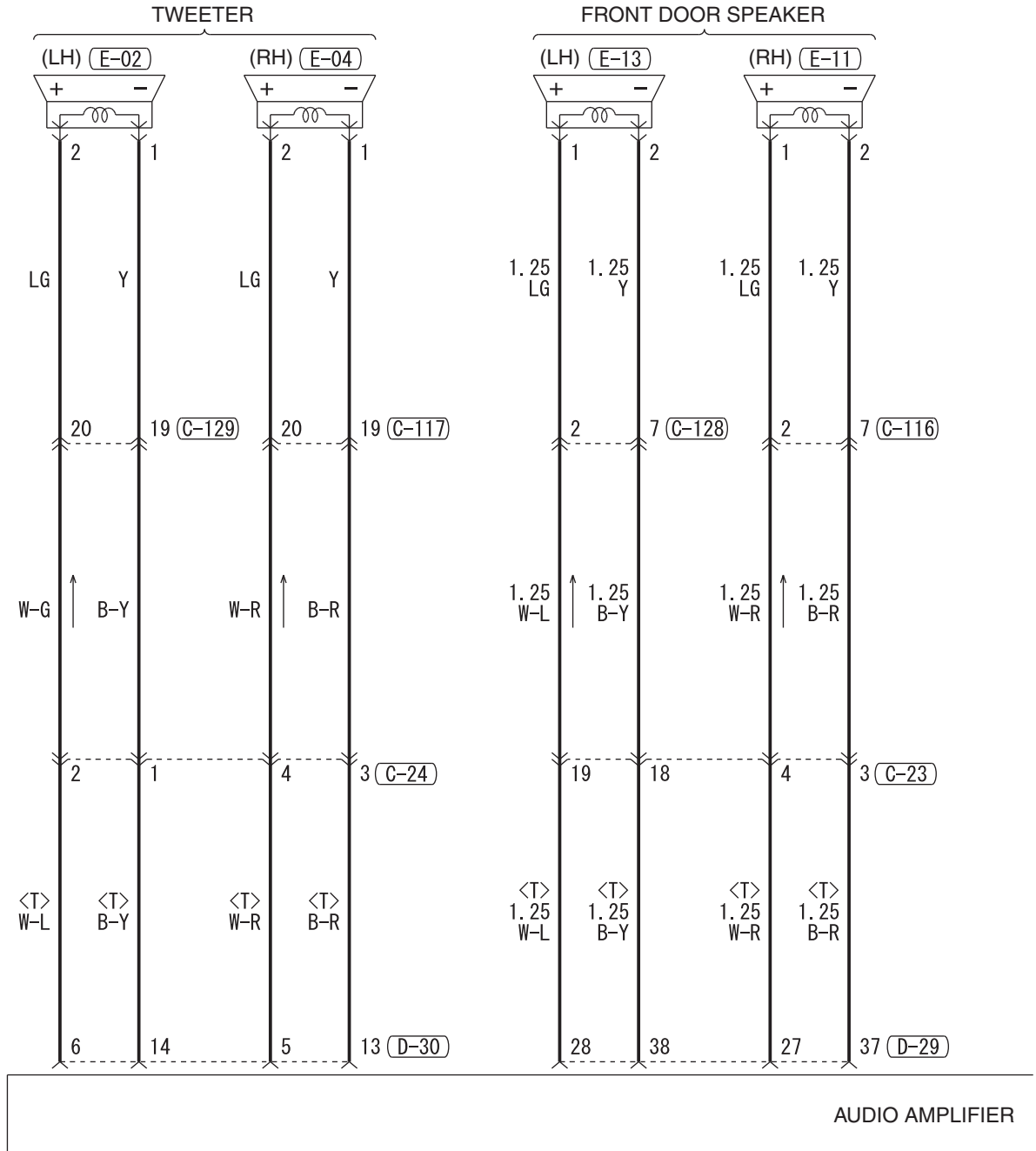

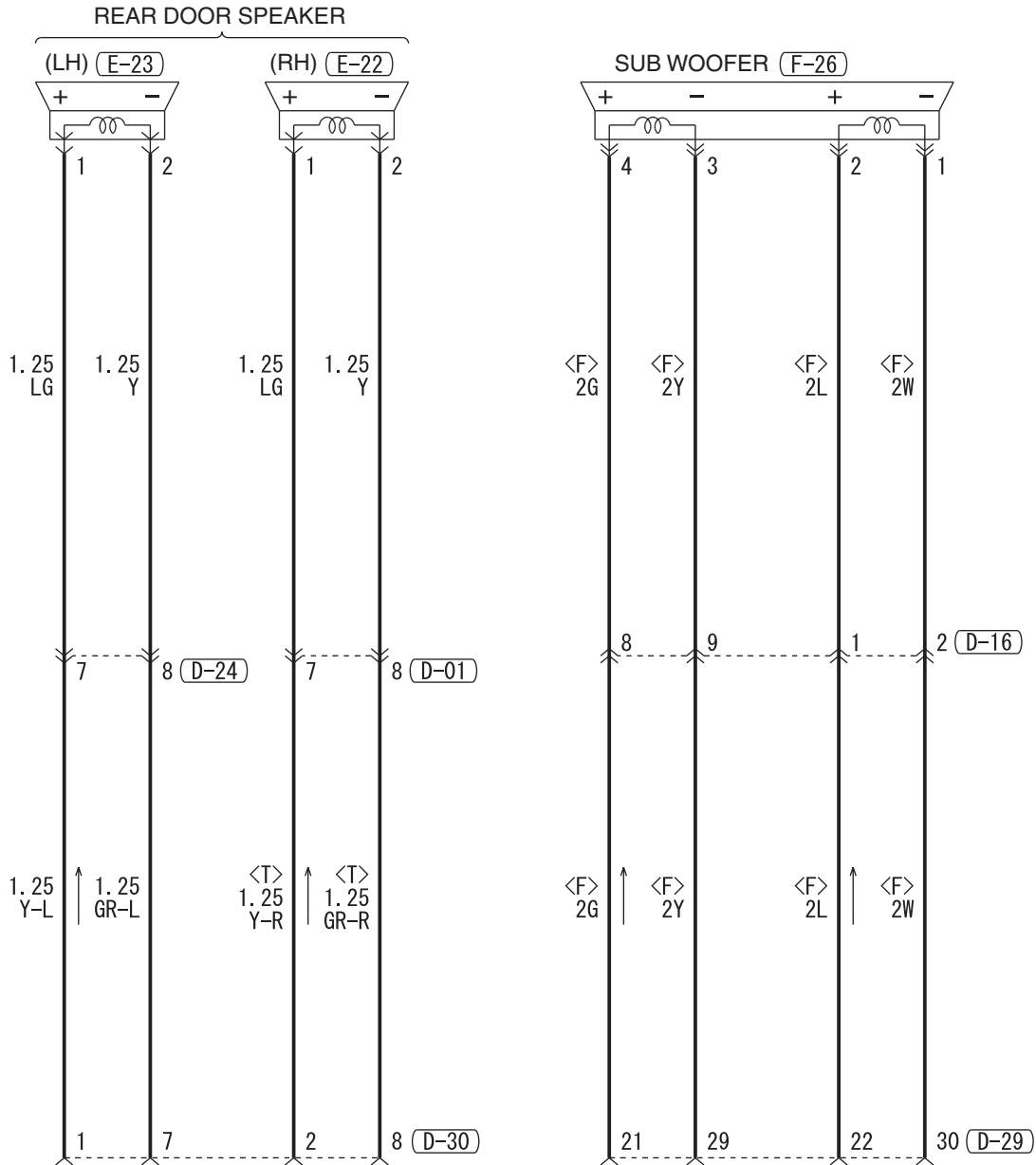

(C-129)

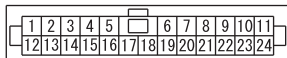

(D-01)

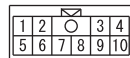

(D-16)

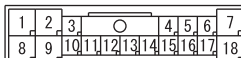

(D-24)

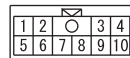

(D-29)

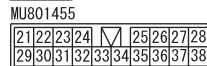

(D-30)

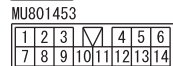

WIRE COLOR CODE

B: BLACK LG: LIGHT GREEN G: GREEN L: BLUE W: WHITE Y: YELLOW SB: SKY BLUE  
BR: BROWN O: ORANGE GR: GRAY R: RED P: PINK V: VIOLET PU: PURPLE SI: SILVER

HAH14M05DB

AUDIO SYSTEM <VEHICLES WITH AUDIO AMPLIFIER> (CONTINUED)

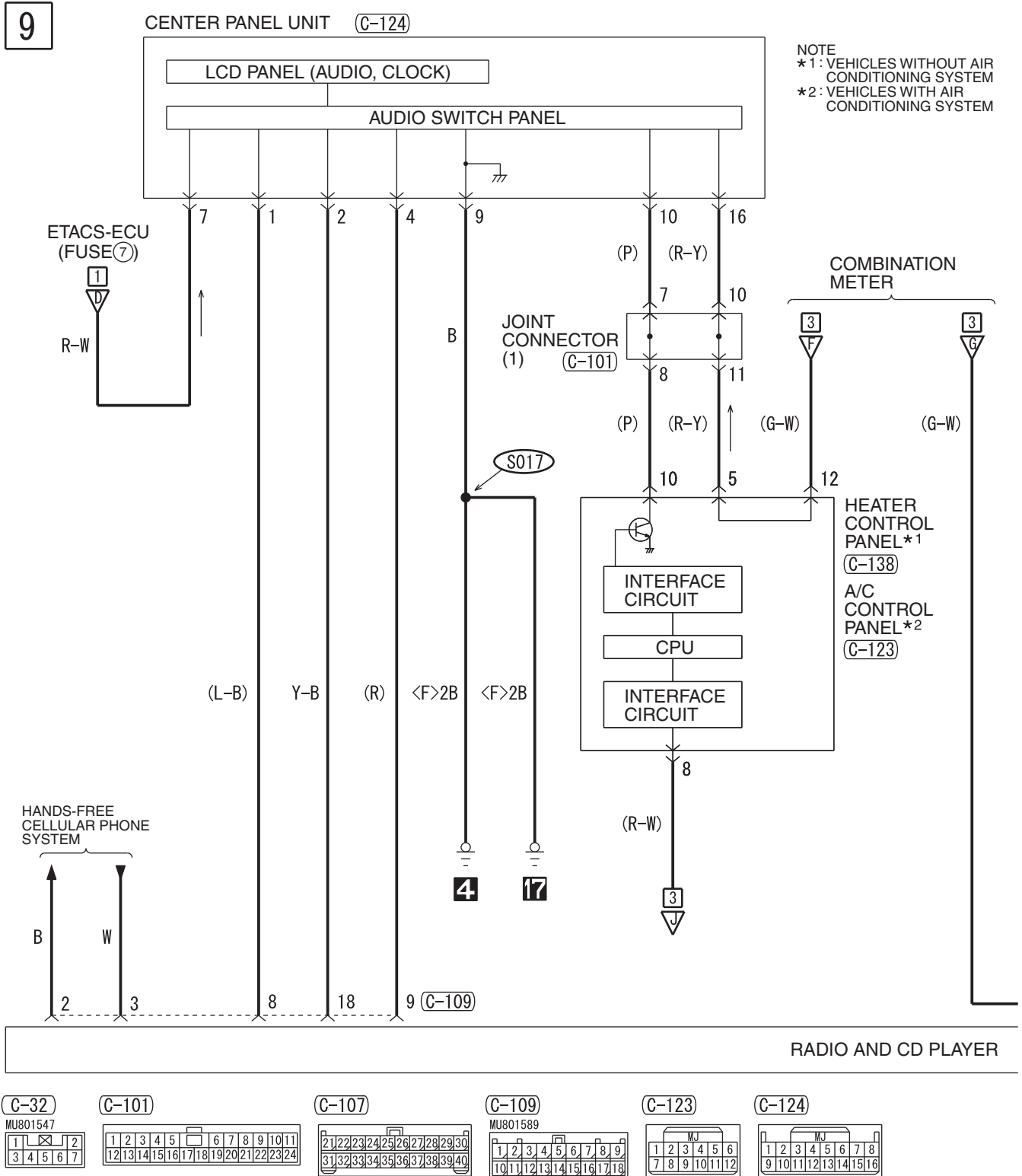

10

STEERING  
WHEEL AUDIO  
REMOTE  
CONTROL  
SWITCH  
(C-213)

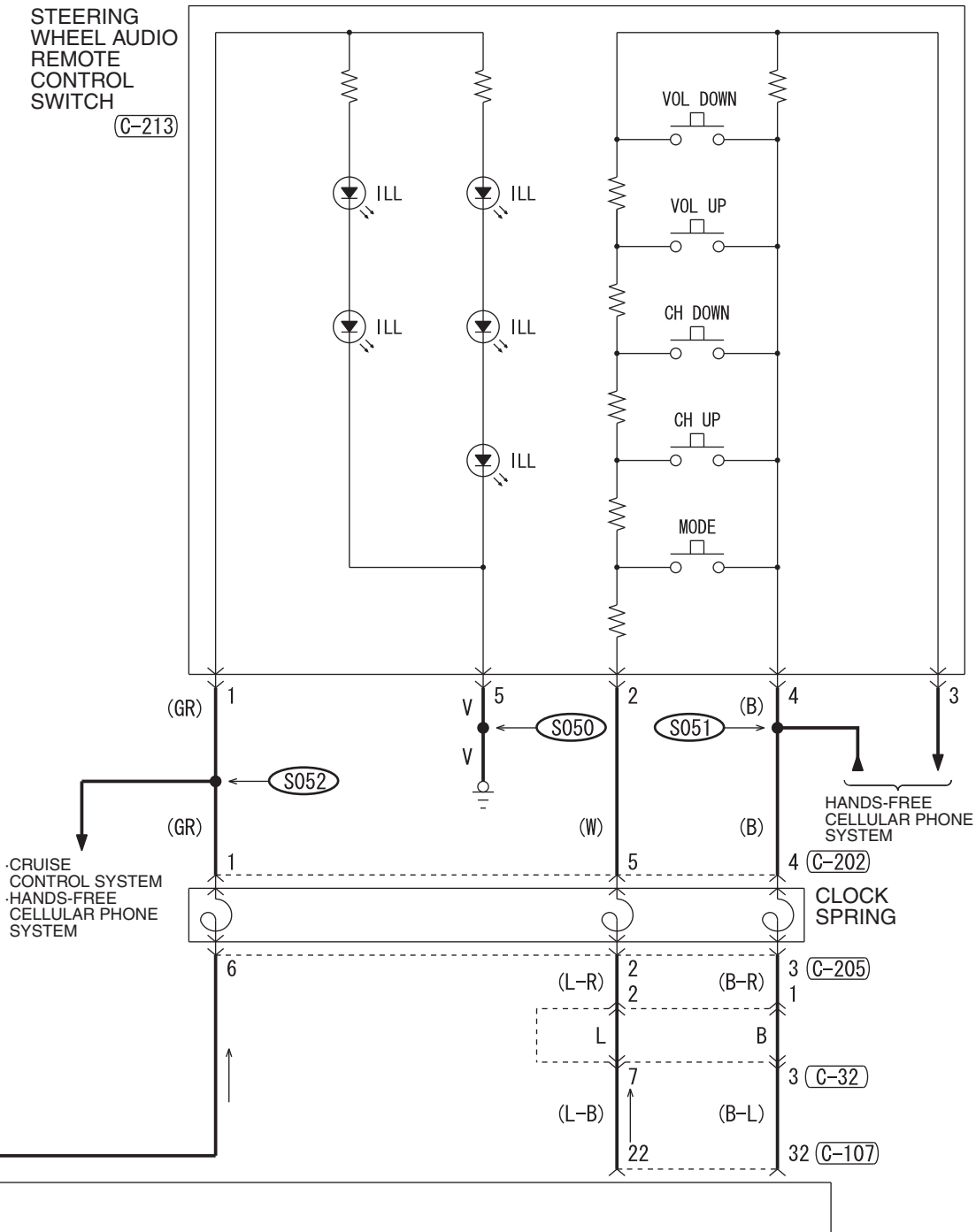

(C-138)

(C-202)

(C-205)

(C-213)

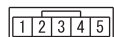
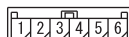
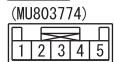
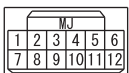

WIRE COLOR CODE

B: BLACK LG: LIGHT GREEN G: GREEN L: BLUE W: WHITE Y: YELLOW SB: SKY BLUE  
BR: BROWN O: ORANGE GR: GRAY R: RED P: PINK V: VIOLET PU: PURPLE SI: SILVER

HAH14M05EB

AUDIO SYSTEM <VEHICLES WITH AUDIO AMPLIFIER> (CONTINUED)

11

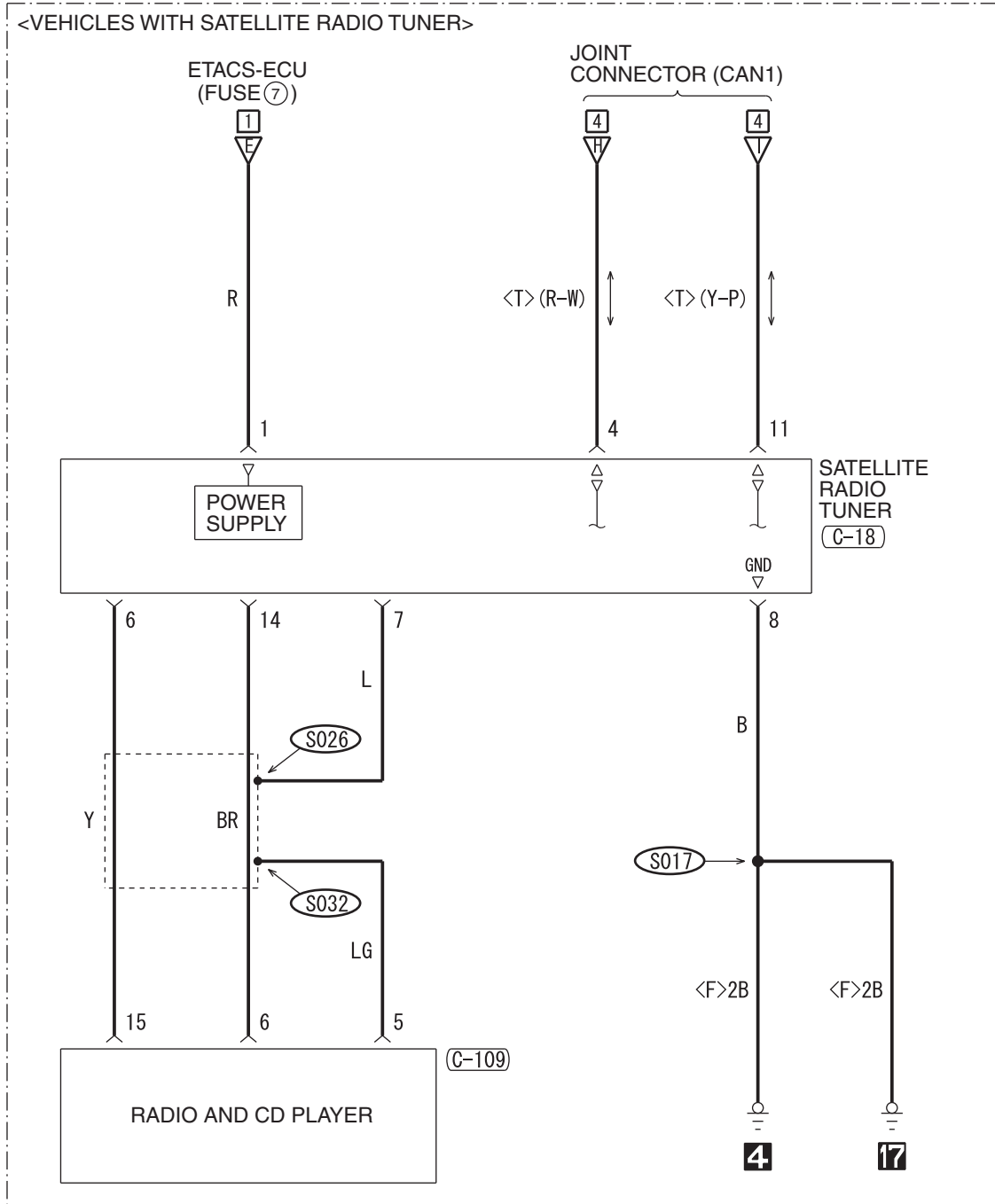

(C-18)

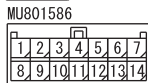

(C-109)

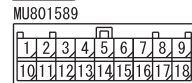

WIRE COLOR CODE

B : BLACK LG : LIGHT GREEN G : GREEN L : BLUE W : WHITE Y : YELLOW SB : SKY BLUE  
BR : BROWN O : ORANGE GR : GRAY R : RED P : PINK V : VIOLET PU : PURPLE SI : SILVER

NOTES

MITSUBISHI MULTI-COMMUNICATION SYSTEM (MMCS)

M1901007501621

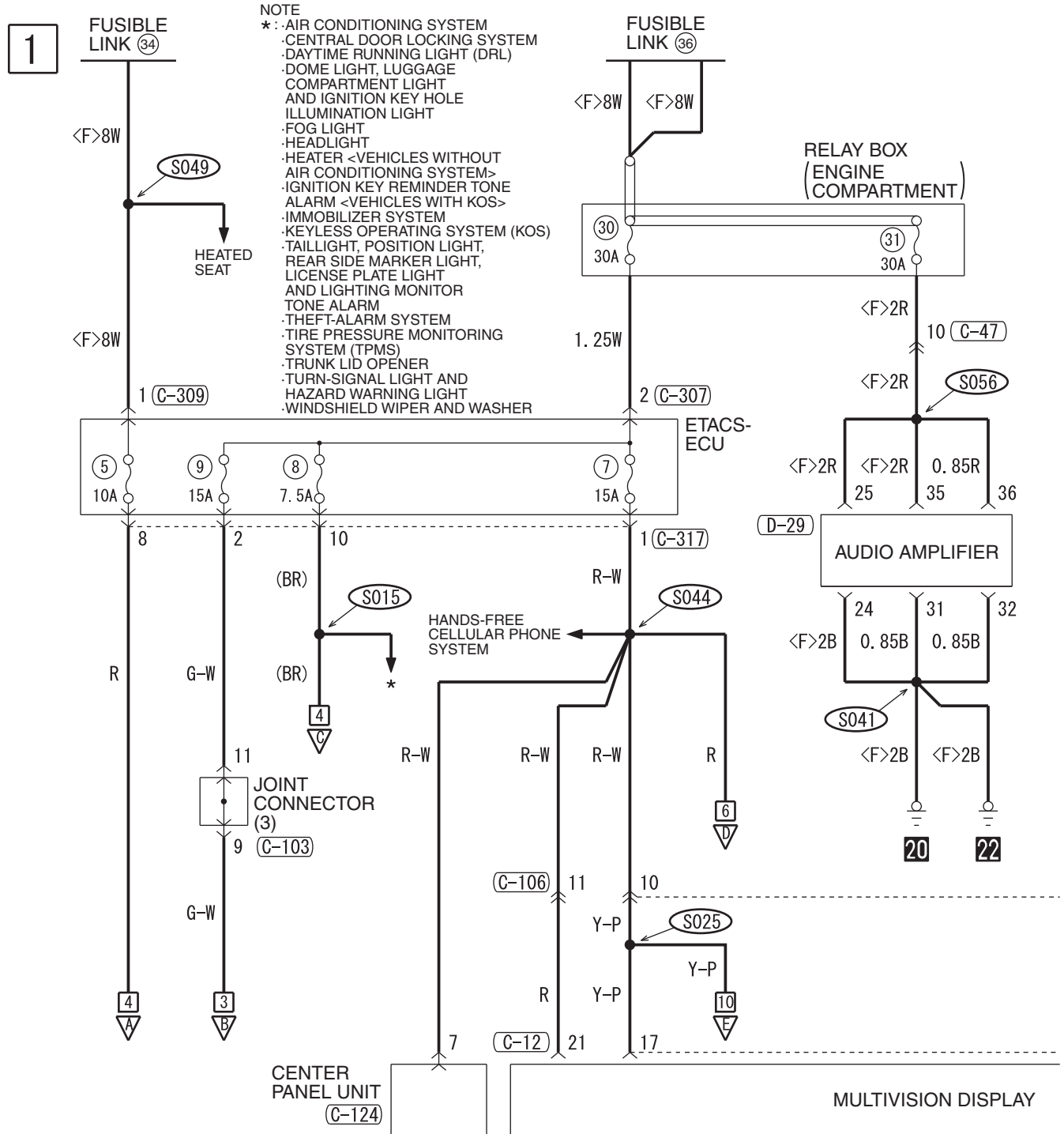

(C-09)

71	72	73	74	75	76	77
----	----	----	----	----	----	----

(C-12)

21	22	23	24	25
----	----	----	----	----

(C-13)

1	2	3	4	5	6	7	8	9					
X	10	11	X	12	X	13	X	14	X	15	16	17	X

(C-47)

1	2	3	4	5	6	7	8	9				
10	11	12	13	14	15	16	17	18	19	20	21	22

(C-103)

1	2	3	4	5	6	7	8	9	10	11		
12	13	14	15	16	17	18	19	20	21	22	23	24

(C-317)

1	2	3	4	5	6	7	
8	9	10	11	12	13	14	15

(D-29)

MU801455

21	22	23	24	25	26	27	28		
29	30	31	32	33	34	35	36	37	38



2

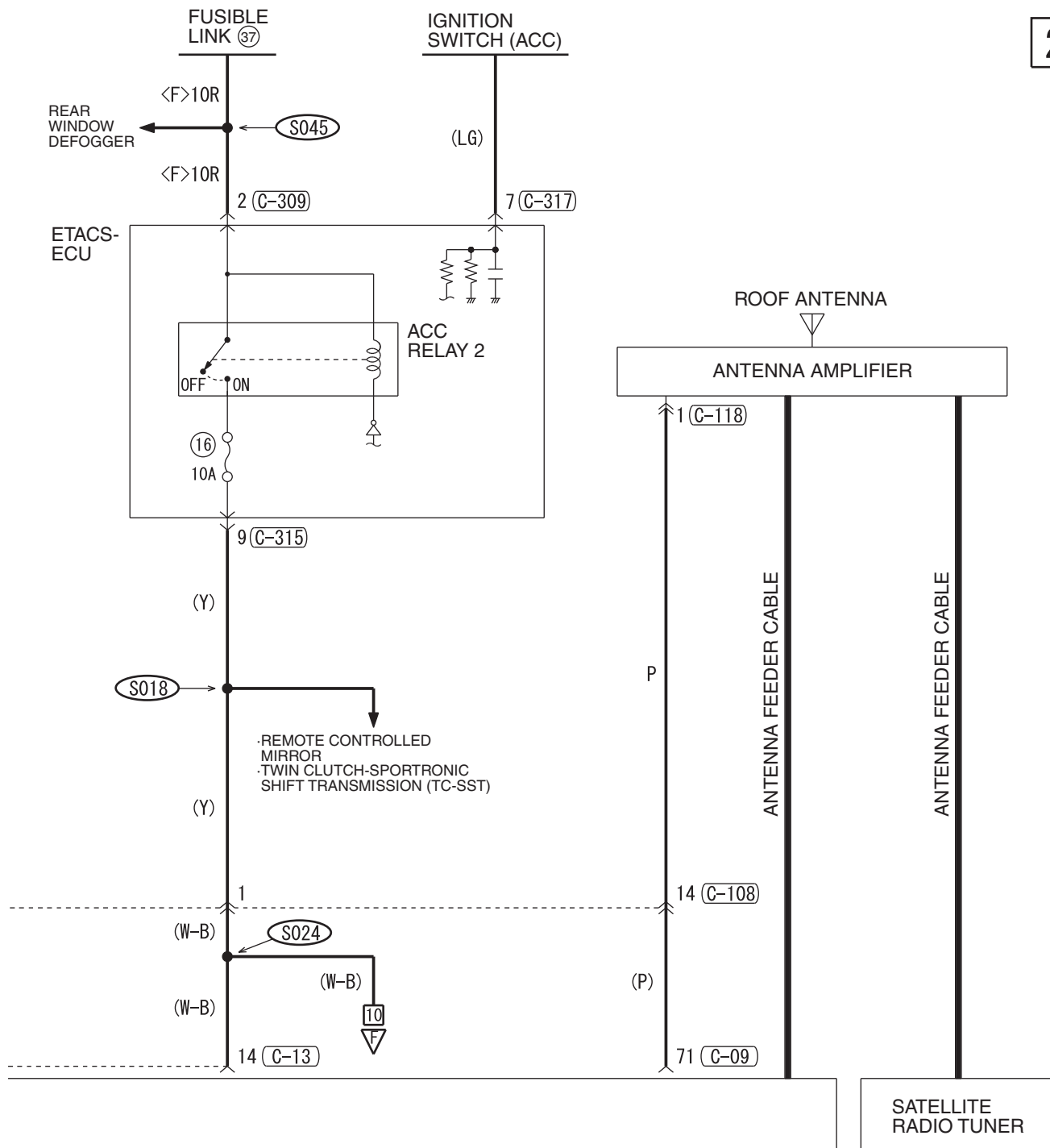

(C-106)

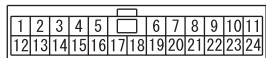

(C-108)

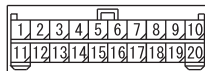

(C-118)



(C-124)

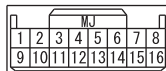

(C-307)



(C-309)



(C-315)

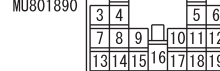

WIRE COLOR CODE  
 B: BLACK LG: LIGHT GREEN G: GREEN L: BLUE W: WHITE Y: YELLOW SB: SKY BLUE  
 BR: BROWN O: ORANGE GR: GRAY R: RED P: PINK V: VIOLET PU: PURPLE SI: SILVER

HAH14M06AB

MITSUBISHI MULTI-COMMUNICATION SYSTEM (MMCS) (CONTINUED)

3

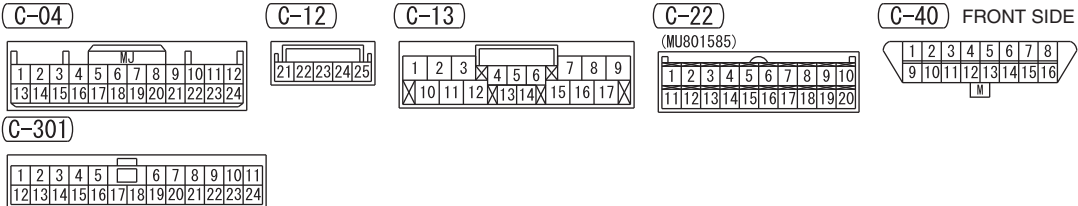
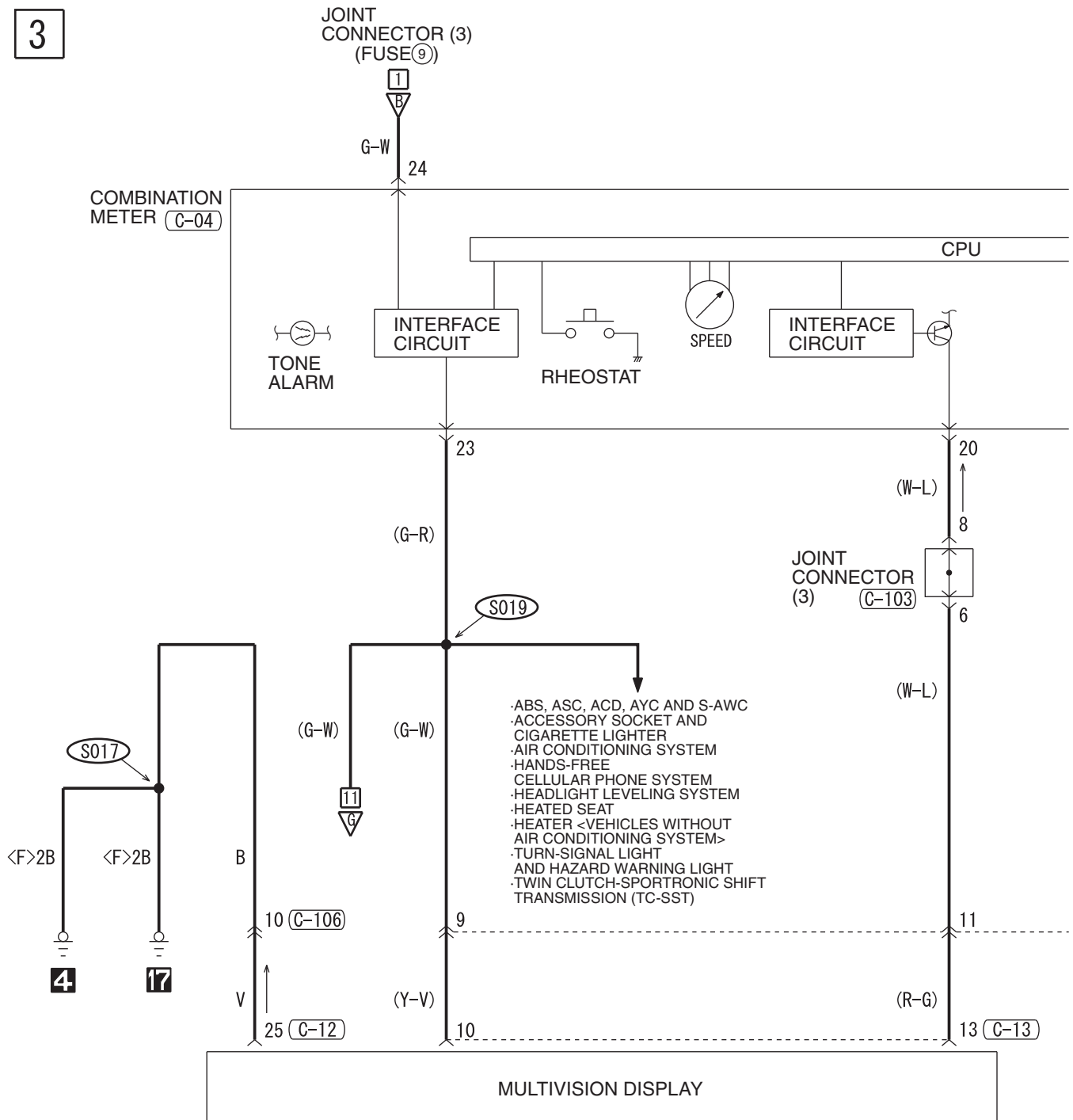

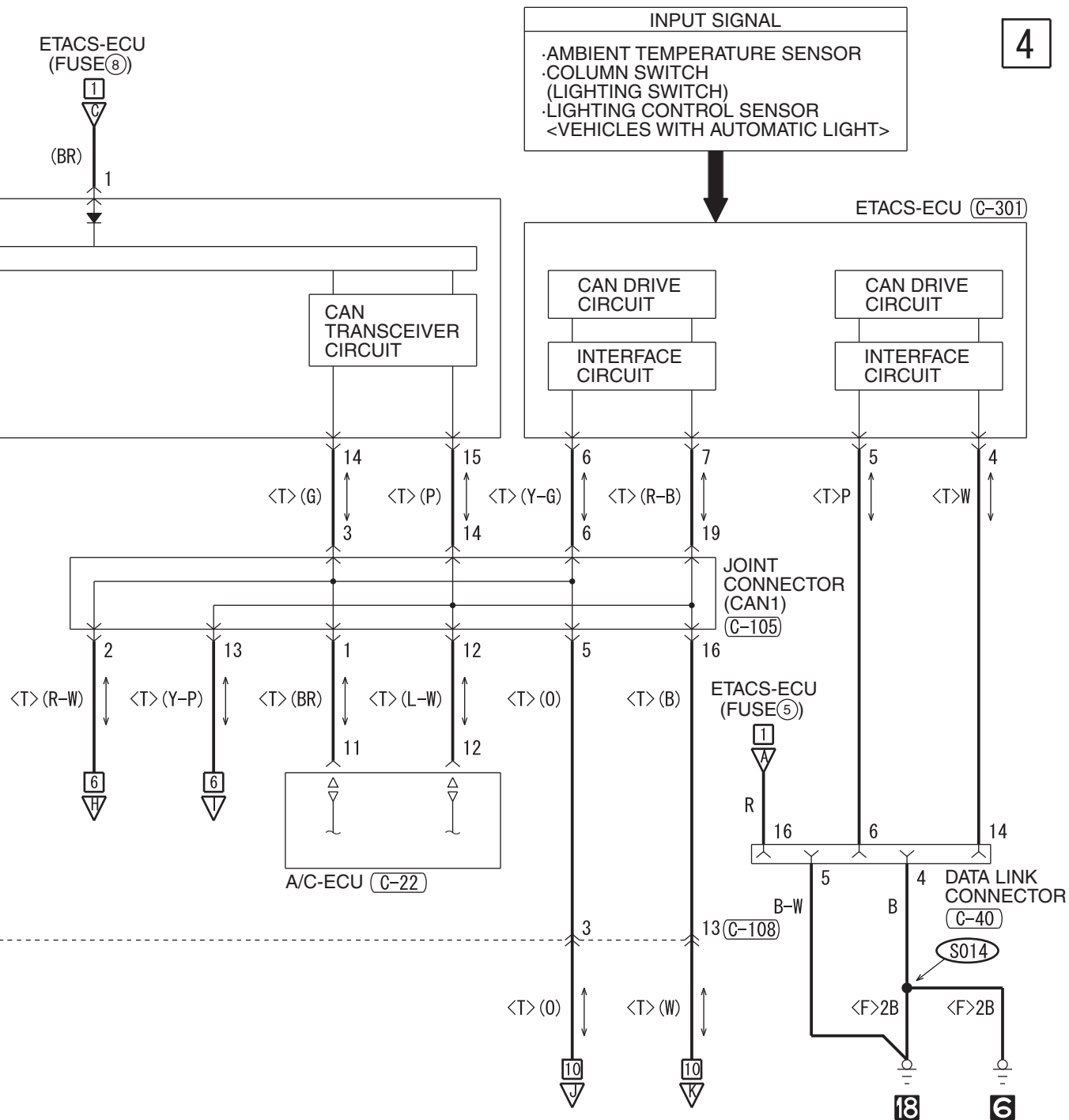

(C-103)

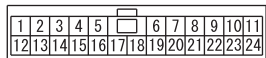

(C-105)

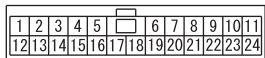

(C-106)

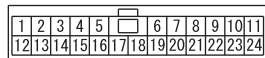

(C-108)

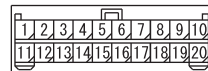

**WIRE COLOR CODE**  
 B: BLACK LG: LIGHT GREEN G: GREEN L: BLUE W: WHITE Y: YELLOW SB: SKY BLUE  
 BR: BROWN O: ORANGE GR: GRAY R: RED P: PINK V: VIOLET PU: PURPLE SI: SILVER

HAH14M06BB

MITSUBISHI MULTI-COMMUNICATION SYSTEM (MMCS) (CONTINUED)

5

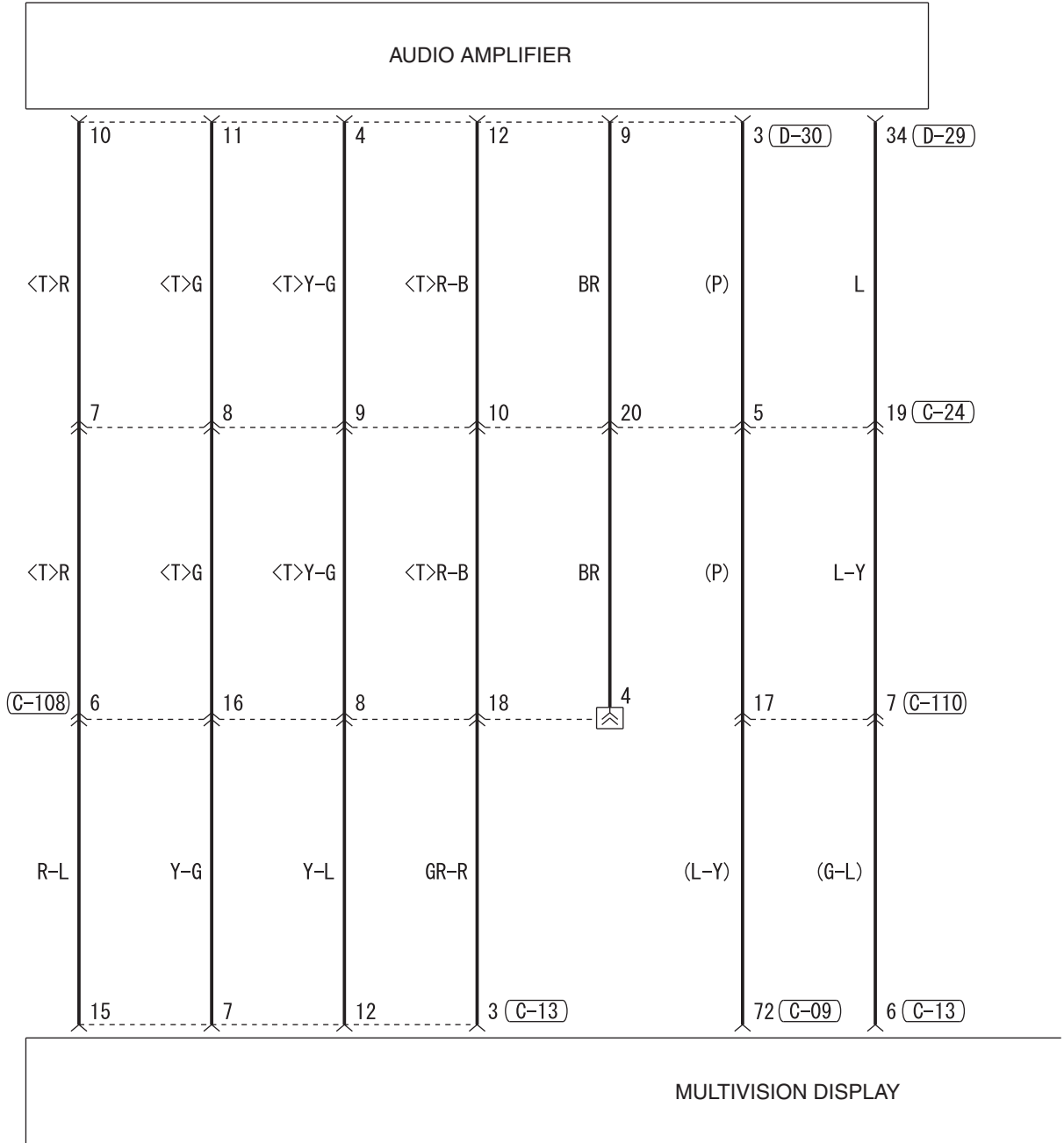

(C-09)

71	72	73	74	75	76	77
----	----	----	----	----	----	----

(C-13)

1	2	3	4	5	6	7	8	9		
X	10	11	12	X	13	14	15	16	17	X

(C-18)

MU801586

1	2	3	4	5	6	7
8	9	10	11	12	13	14

(C-24)

1	2	3	4	5	6	7	8	9	10	11		
12	13	14	15	16	17	18	19	20	21	22	23	24

(C-108)

1	2	3	4	5	6	7	8	9	10
11	12	13	14	15	16	17	18	19	20

(C-110)

MU801589

1	2	3	4	5	6	7	8	9
10	11	12	13	14	15	16	17	18

6

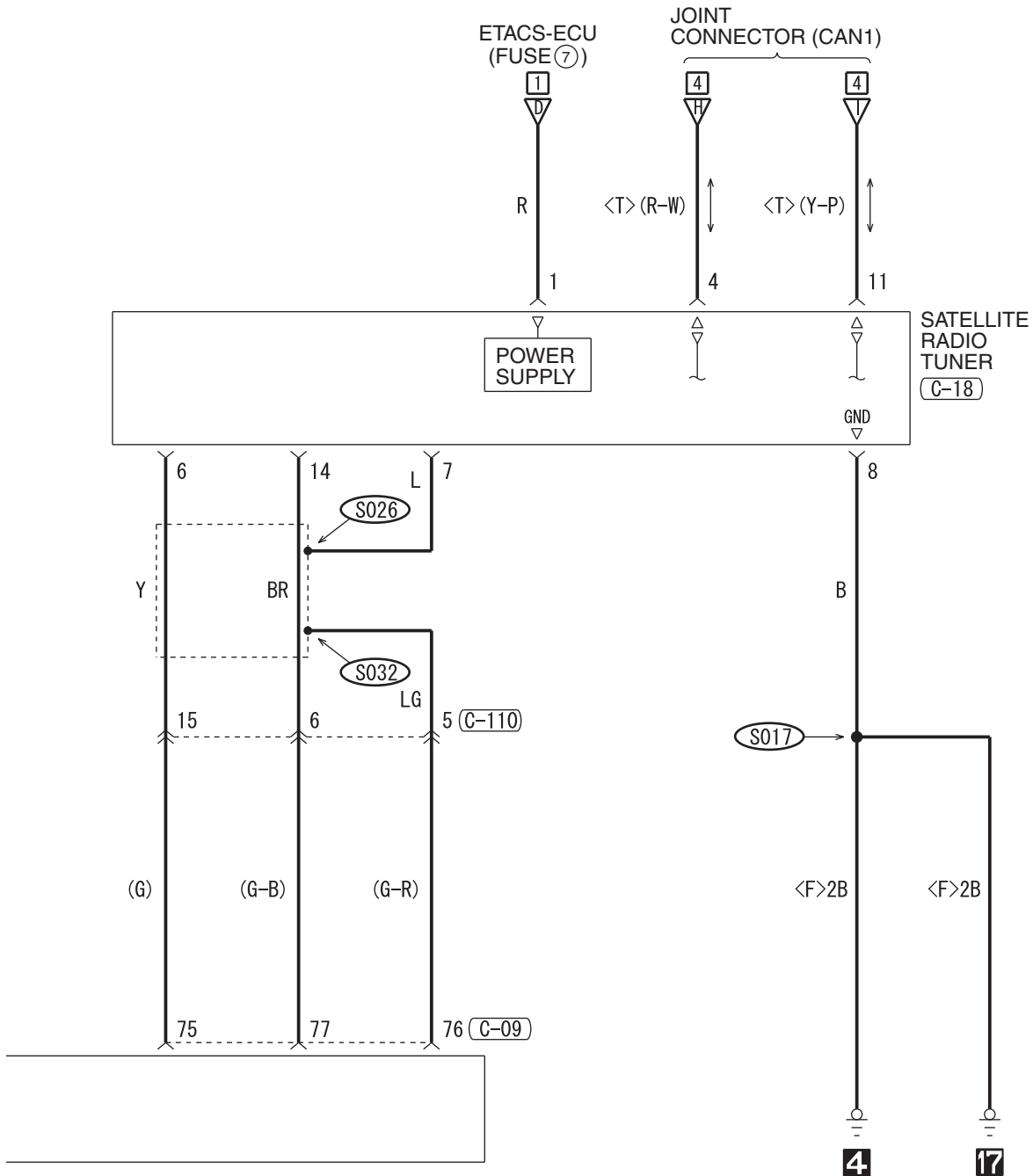

(D-29)

MU801455

21	22	23	24	25	26	27	28		
29	30	31	32	33	34	35	36	37	38

(D-30)

MU801453

1	2	3	4	5	6		
7	8	9	10	11	12	13	14

WIRE COLOR CODE

B : BLACK LG : LIGHT GREEN G : GREEN L : BLUE W : WHITE Y : YELLOW SB : SKY BLUE  
 BR : BROWN O : ORANGE GR : GRAY R : RED P : PINK V : VIOLET PU : PURPLE SI : SILVER

HAH14M06CB

TSB Revision

MITSUBISHI MULTI-COMMUNICATION SYSTEM (MMCS) (CONTINUED)

7

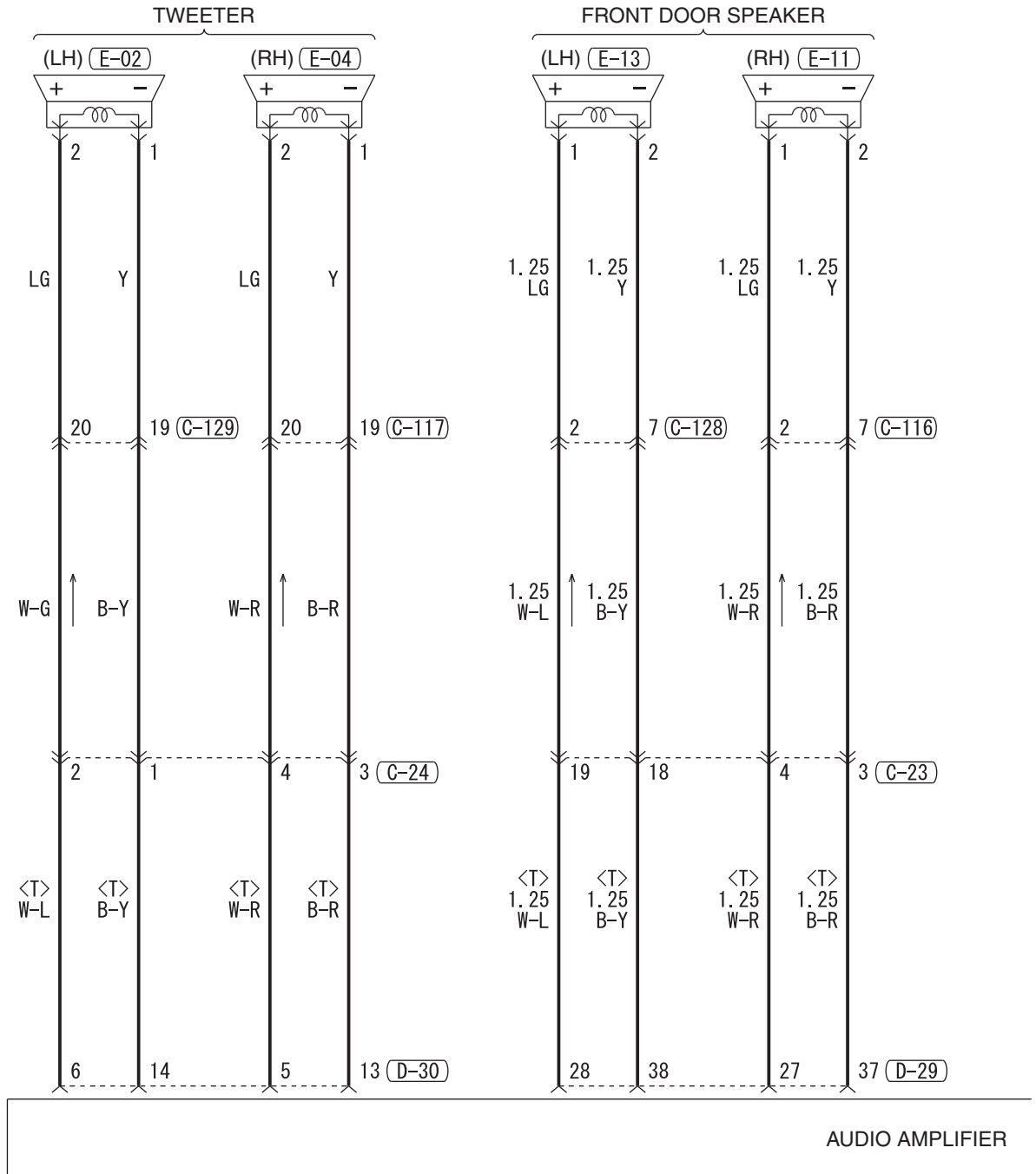

C-23

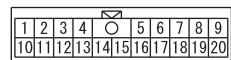

C-24

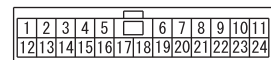

C-116

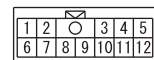

C-117

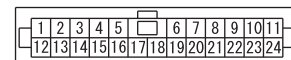

C-128

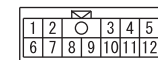

E-02



E-04



E-11



E-13



E-22



E-23



F-26



8

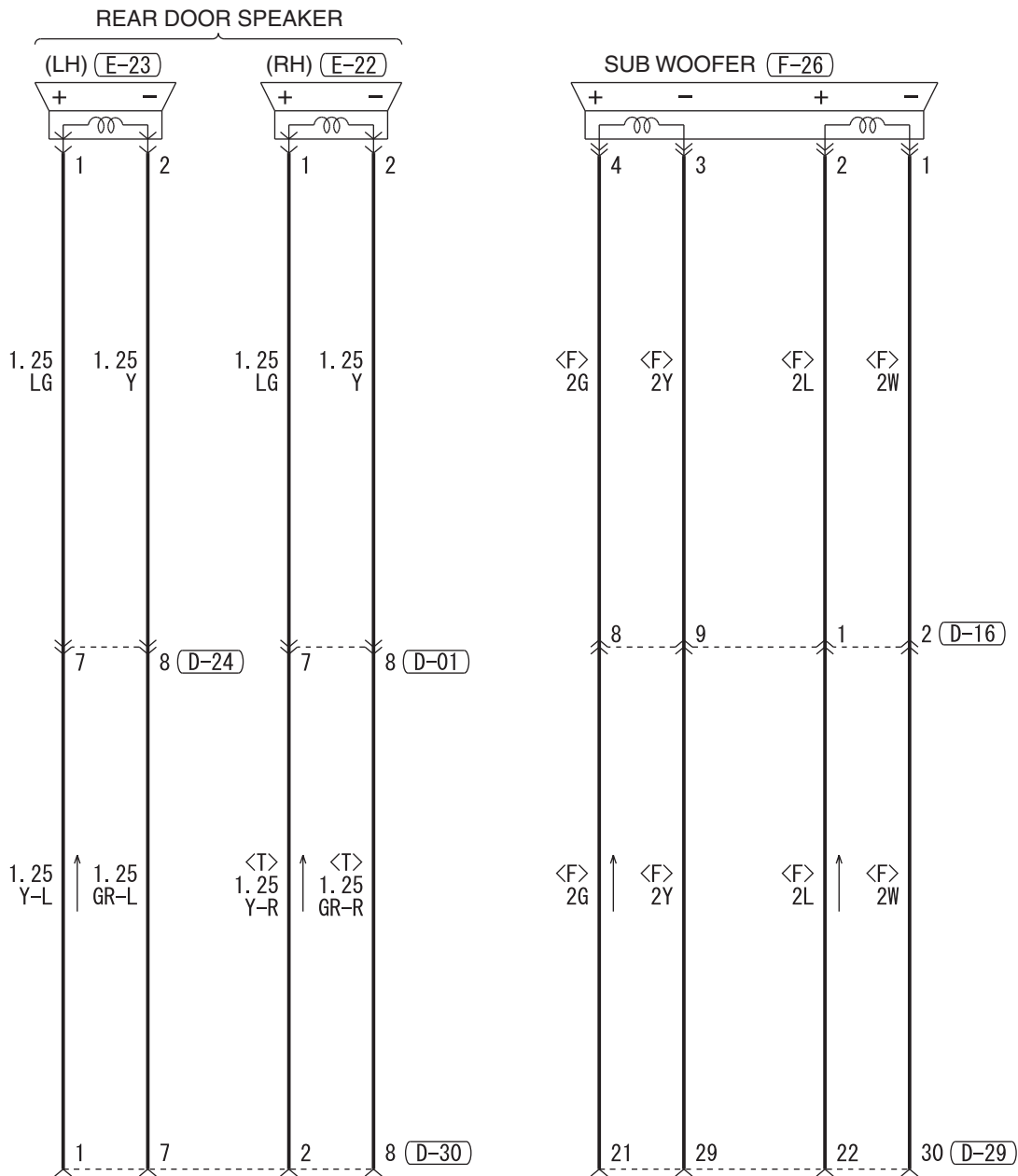

(C-129)

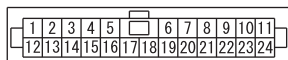

(D-01)

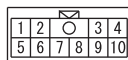

(D-16)

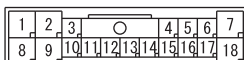

(D-24)

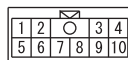

(D-29)

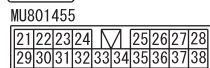

(D-30)

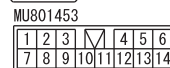

WIRE COLOR CODE

B: BLACK LG: LIGHT GREEN G: GREEN L: BLUE W: WHITE Y: YELLOW SB: SKY BLUE  
 BR: BROWN O: ORANGE GR: GRAY R: RED P: PINK V: VIOLET PU: PURPLE SI: SILVER

HAH14M06DB

TSB Revision

MITSUBISHI MULTI-COMMUNICATION SYSTEM (MMCS) (CONTINUED)

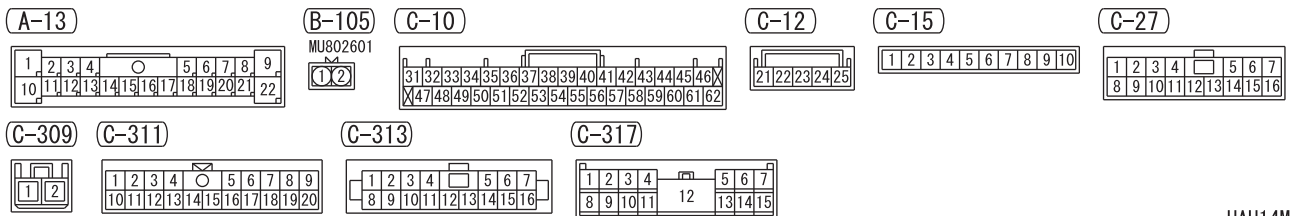
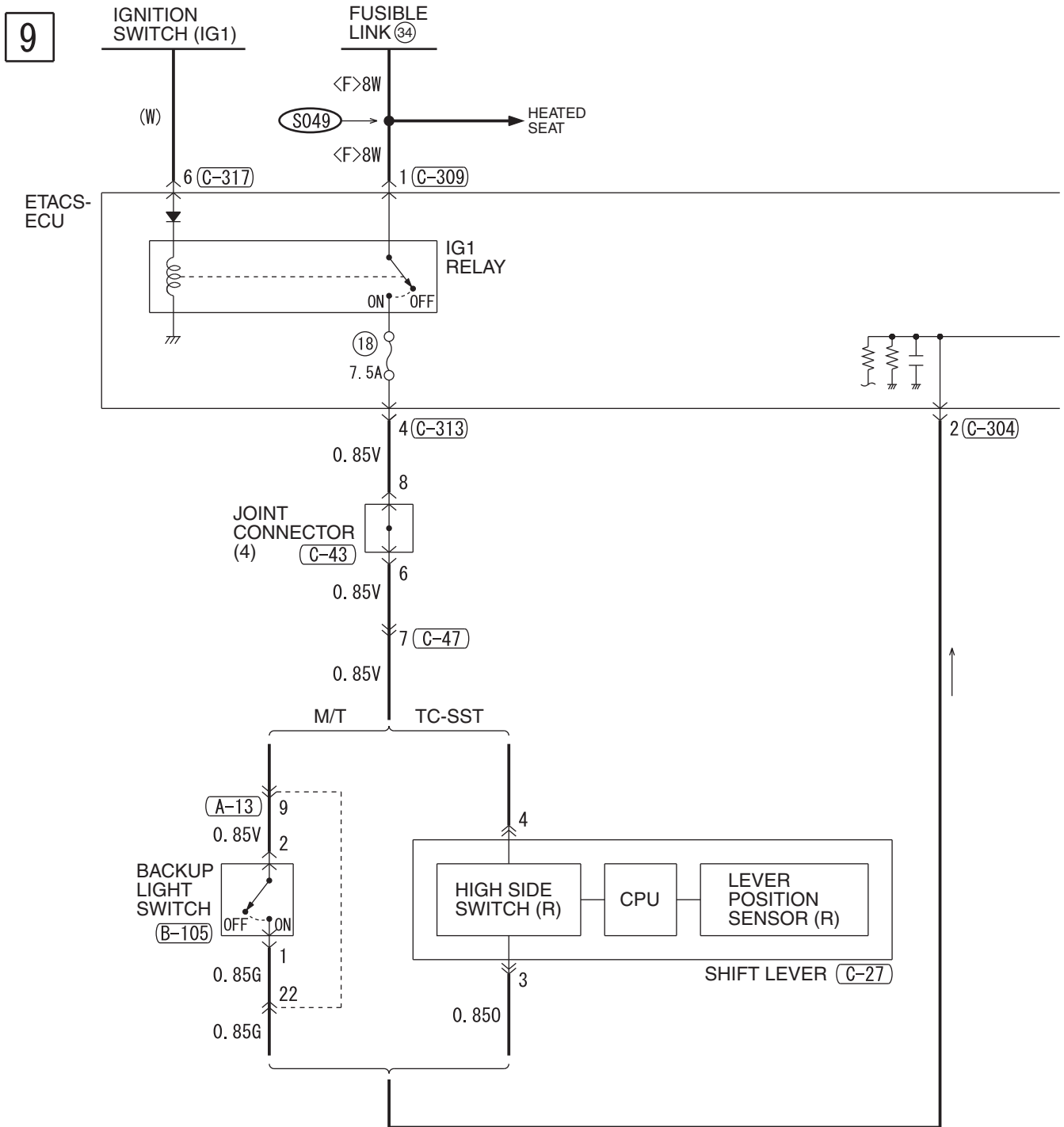



10

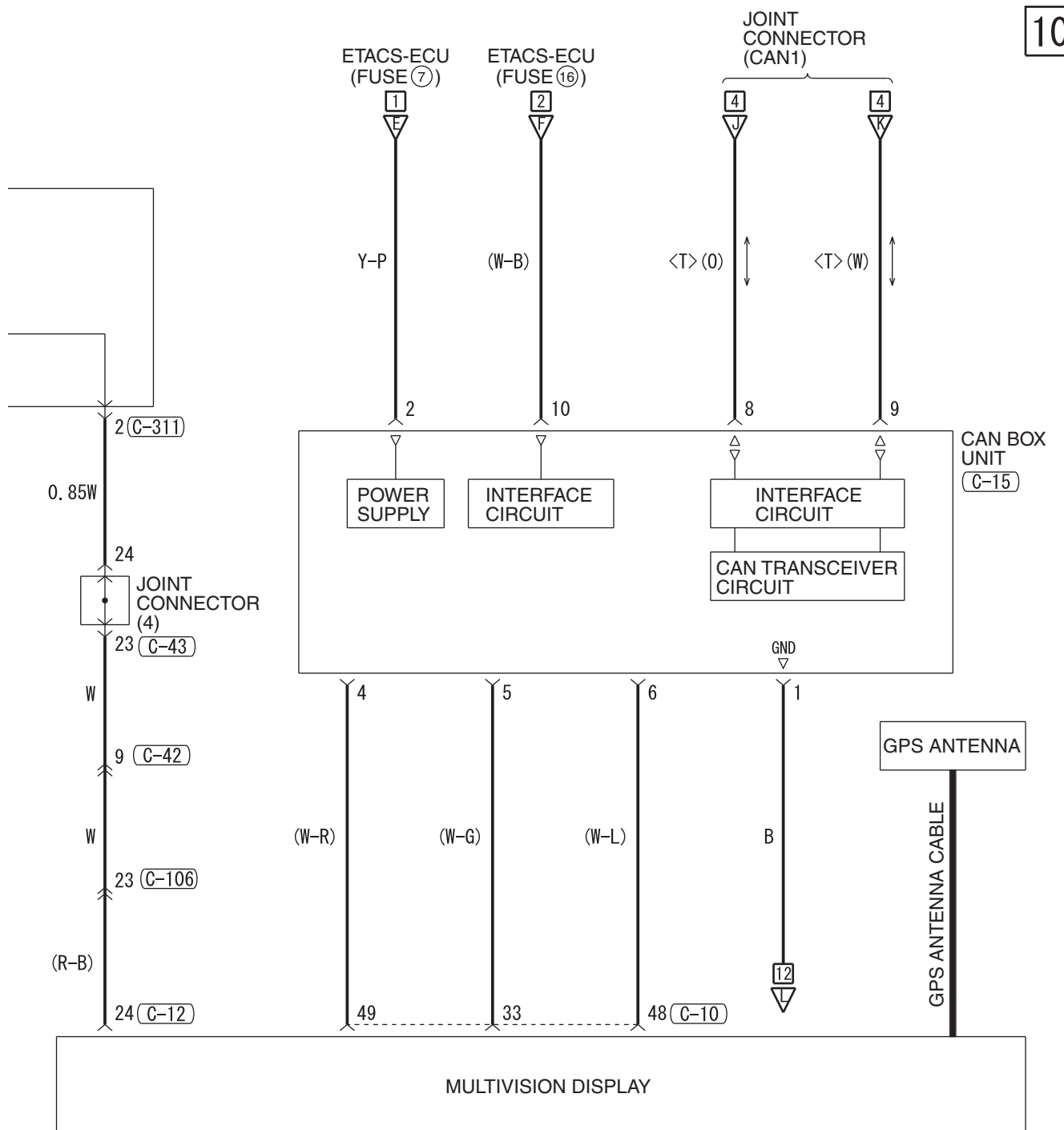

C-42

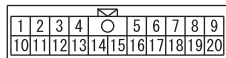

C-43

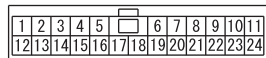

C-47

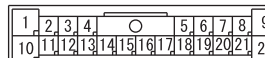

C-106

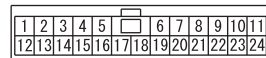

C-304

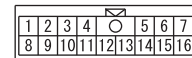

WIRE COLOR CODE  
 B: BLACK LG: LIGHT GREEN G: GREEN L: BLUE W: WHITE Y: YELLOW SB: SKY BLUE  
 BR: BROWN O: ORANGE GR: GRAY R: RED P: PINK V: VIOLET PU: PURPLE SI: SILVER

HAH14M06EB

MITSUBISHI MULTI-COMMUNICATION SYSTEM (MMCS) (CONTINUED)

11

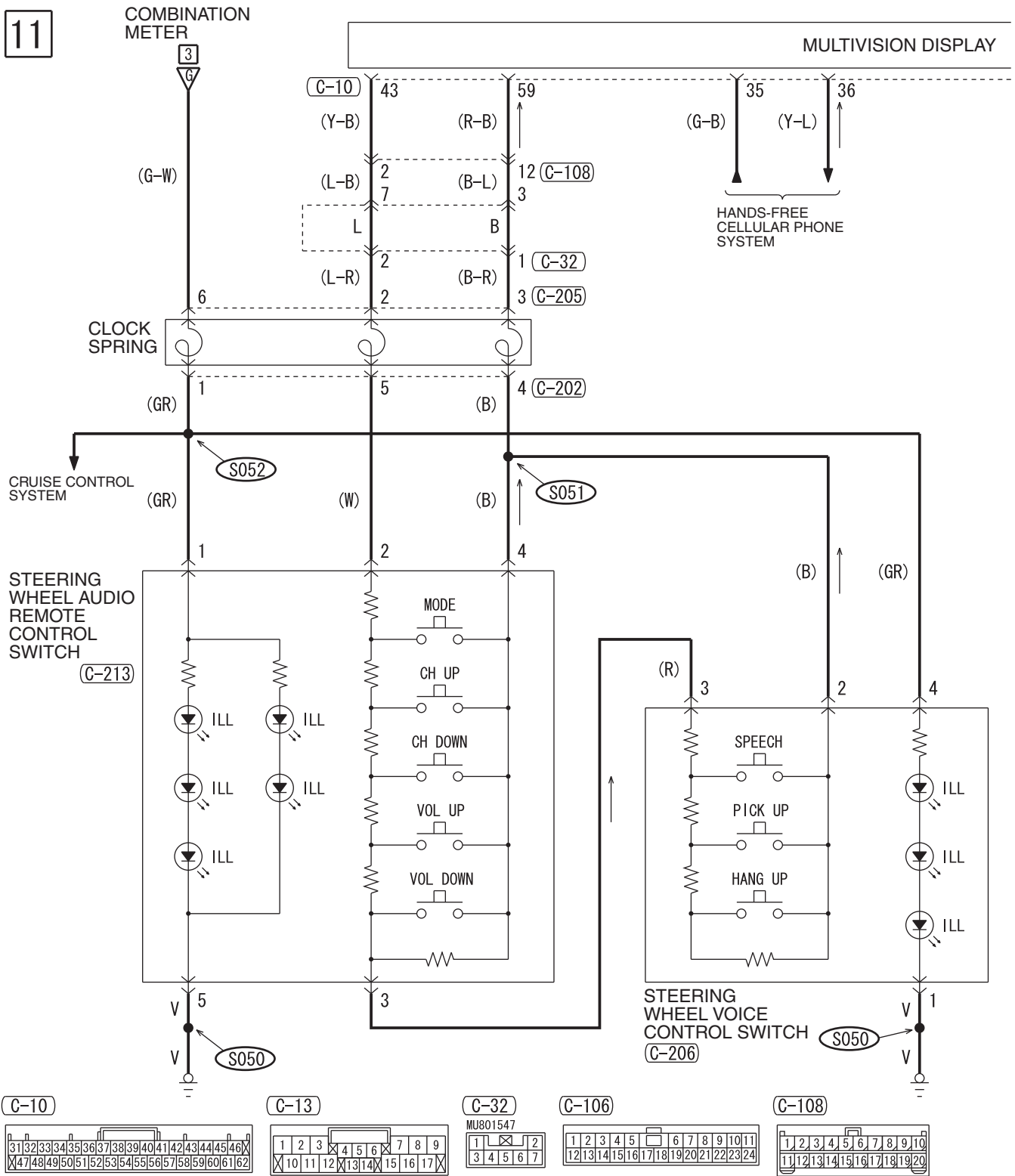



# SPARE CONNECTOR (FOR AUDIO)

M1901019001980

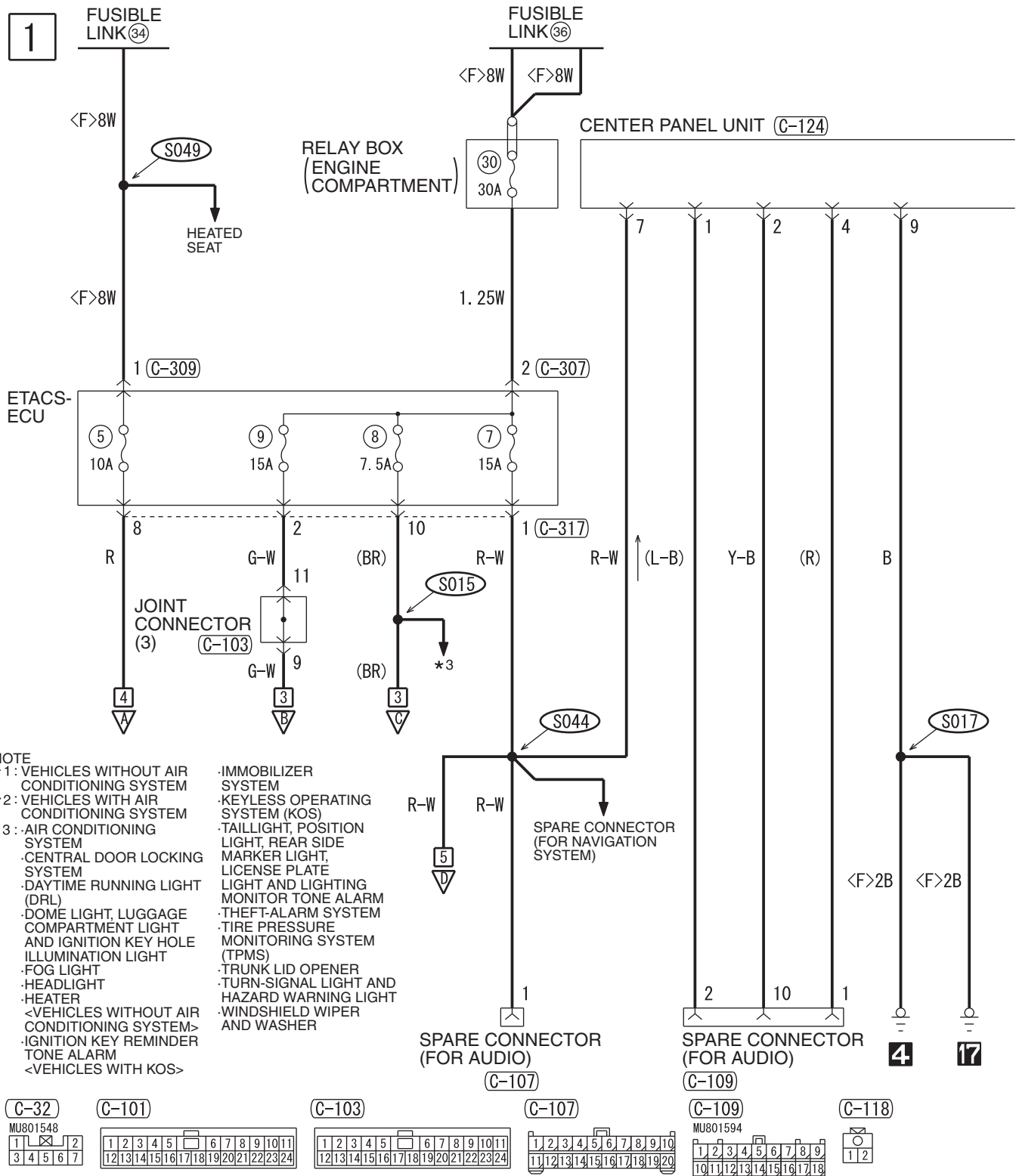

**NOTE**

- \*1: VEHICLES WITHOUT AIR CONDITIONING SYSTEM
  - \*2: VEHICLES WITH AIR CONDITIONING SYSTEM
  - \*3: AIR CONDITIONING SYSTEM
- |  |  |
|--|--|
| <ul style="list-style-type: none"> <li>-CENTRAL DOOR LOCKING SYSTEM</li> <li>-DAYTIME RUNNING LIGHT (DRL)</li> <li>-DOME LIGHT, LUGGAGE COMPARTMENT LIGHT AND IGNITION KEY HOLE ILLUMINATION LIGHT</li> <li>-FOG LIGHT</li> <li>-HEADLIGHT</li> <li>-HEATER</li> <li>&lt;VEHICLES WITHOUT AIR CONDITIONING SYSTEM&gt;</li> <li>-IGNITION KEY REMINDER TONE ALARM</li> <li>&lt;VEHICLES WITH KOS&gt;</li> </ul> | <ul style="list-style-type: none"> <li>-IMMOBILIZER SYSTEM</li> <li>-KEYLESS OPERATING SYSTEM (KOS)</li> <li>-TAILLIGHT, POSITION MARKER LIGHT, REAR SIDE MARKER LIGHT, LICENSE PLATE LIGHT AND LIGHTING MONITOR TONE ALARM</li> <li>-THEFT-ALARM SYSTEM</li> <li>-TIRE PRESSURE MONITORING SYSTEM (TPMS)</li> <li>-TRUNK LID OPENER</li> <li>-TURN-SIGNAL LIGHT AND HAZARD WARNING LIGHT</li> <li>-WINDSHIELD WIPER AND WASHER</li> </ul> |
|--|--|

C-32



C-101

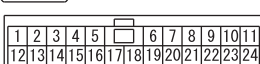

C-103

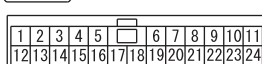

C-107

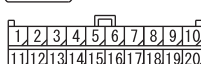

C-109

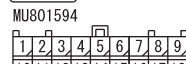

C-118



2

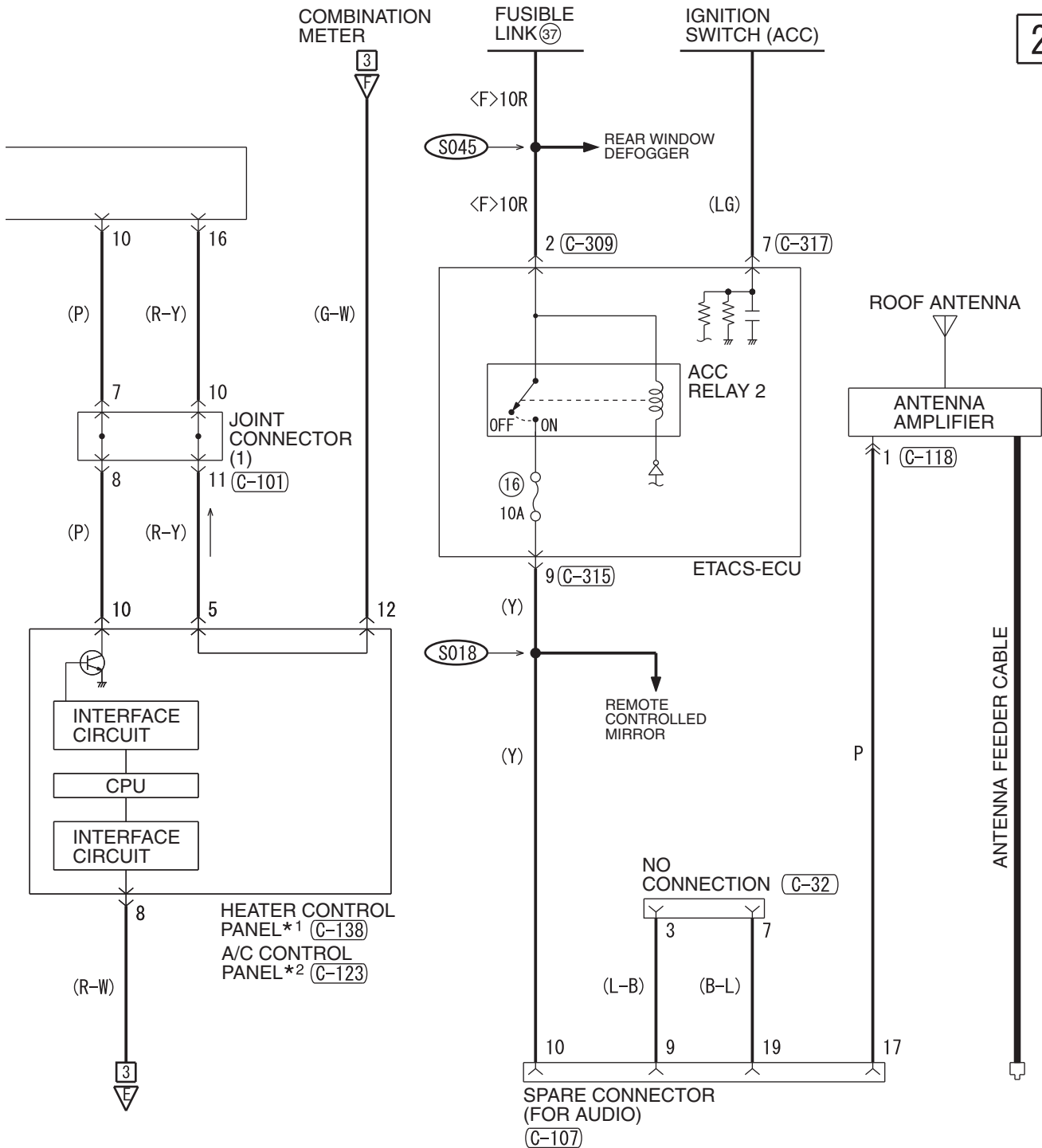

(C-123)

(C-124)

(C-138)

(C-307)

(C-309)

(C-315)

(C-317)

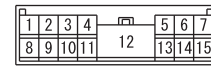
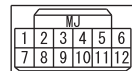
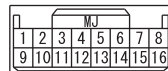
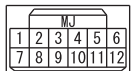

WIRE COLOR CODE

B: BLACK LG: LIGHT GREEN G: GREEN L: BLUE W: WHITE Y: YELLOW SB: SKY BLUE  
BR: BROWN O: ORANGE GR: GRAY R: RED P: PINK V: VIOLET PU: PURPLE SI: SILVER

HAH14M07AB

SPARE CONNECTOR (FOR AUDIO) (CONTINUED)

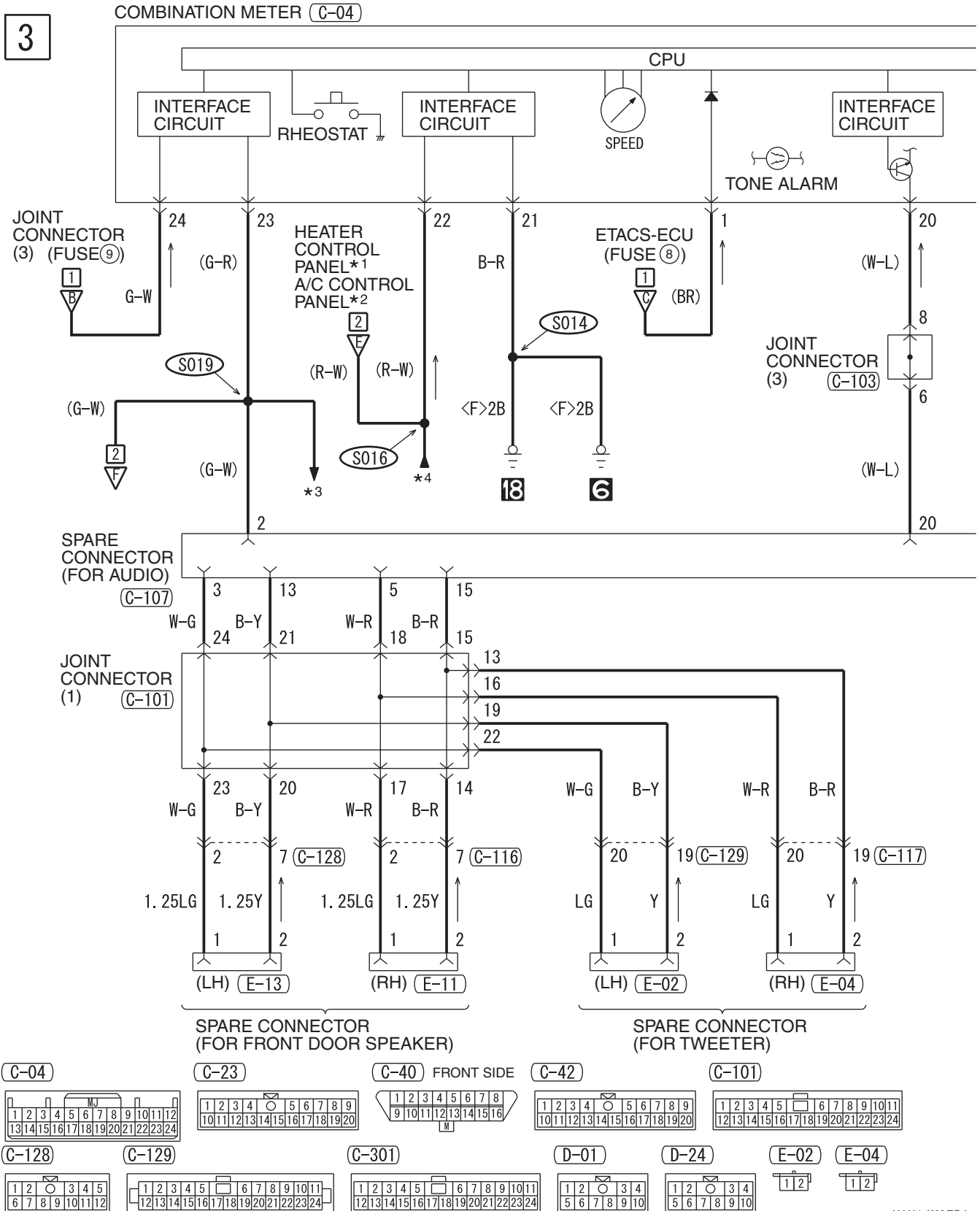

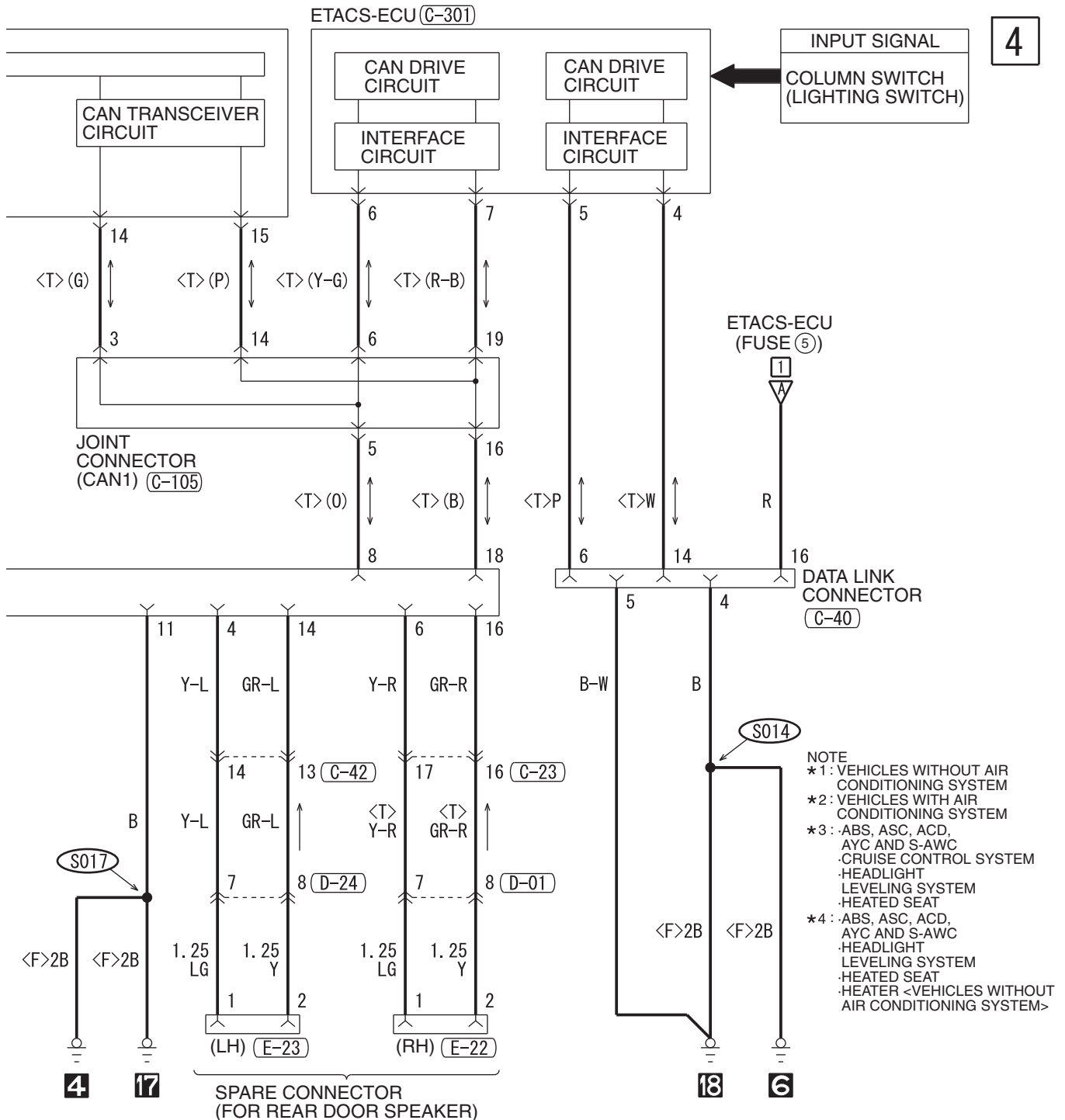

**NOTE**

- \* 1: VEHICLES WITHOUT AIR CONDITIONING SYSTEM
- \* 2: VEHICLES WITH AIR CONDITIONING SYSTEM
- \* 3: -ABS, ASC, ACD, AYC AND S-AWC  
-CRUISE CONTROL SYSTEM  
-HEADLIGHT LEVELING SYSTEM  
-HEATED SEAT
- \* 4: -ABS, ASC, ACD, AYC AND S-AWC  
-HEADLIGHT LEVELING SYSTEM  
-HEATED SEAT  
-HEATER <VEHICLES WITHOUT AIR CONDITIONING SYSTEM>

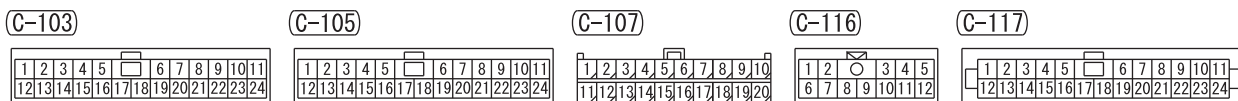

(E-11) MU801672	(E-13) MU801672	(E-22) MU801672	(E-23) MU801672	<b>WIRE COLOR CODE</b>
1 2	1 2	1 2	1 2	B: BLACK LG: LIGHT GREEN G: GREEN L: BLUE W: WHITE Y: YELLOW SB: SKY BLUE BR: BROWN O: ORANGE GR: GRAY R: RED P: PINK V: VIOLET PU: PURPLE SI: SILVER

SPARE CONNECTOR (FOR AUDIO) (CONTINUED)

5

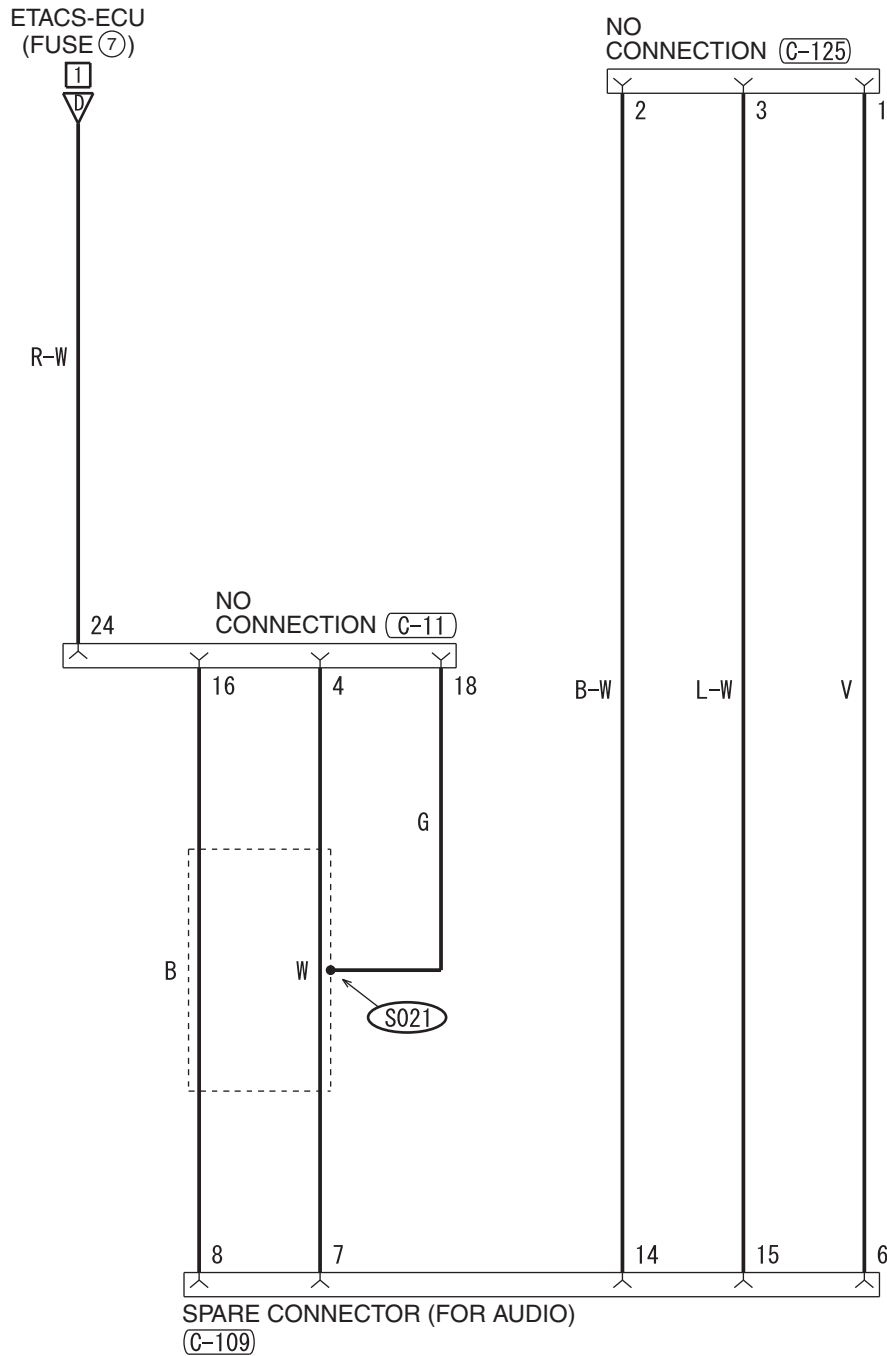

(C-11)

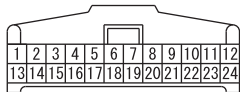

(C-109)

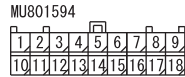

(C-125)

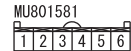

WIRE COLOR CODE

B: BLACK LG: LIGHT GREEN G: GREEN L: BLUE W: WHITE Y: YELLOW SB: SKY BLUE  
BR: BROWN O: ORANGE GR: GRAY R: RED P: PINK V: VIOLET PU: PURPLE SI: SILVER

HAH14M07CA



NOTES

# SPARE CONNECTOR (FOR NAVIGATION SYSTEM)

M1901025000920

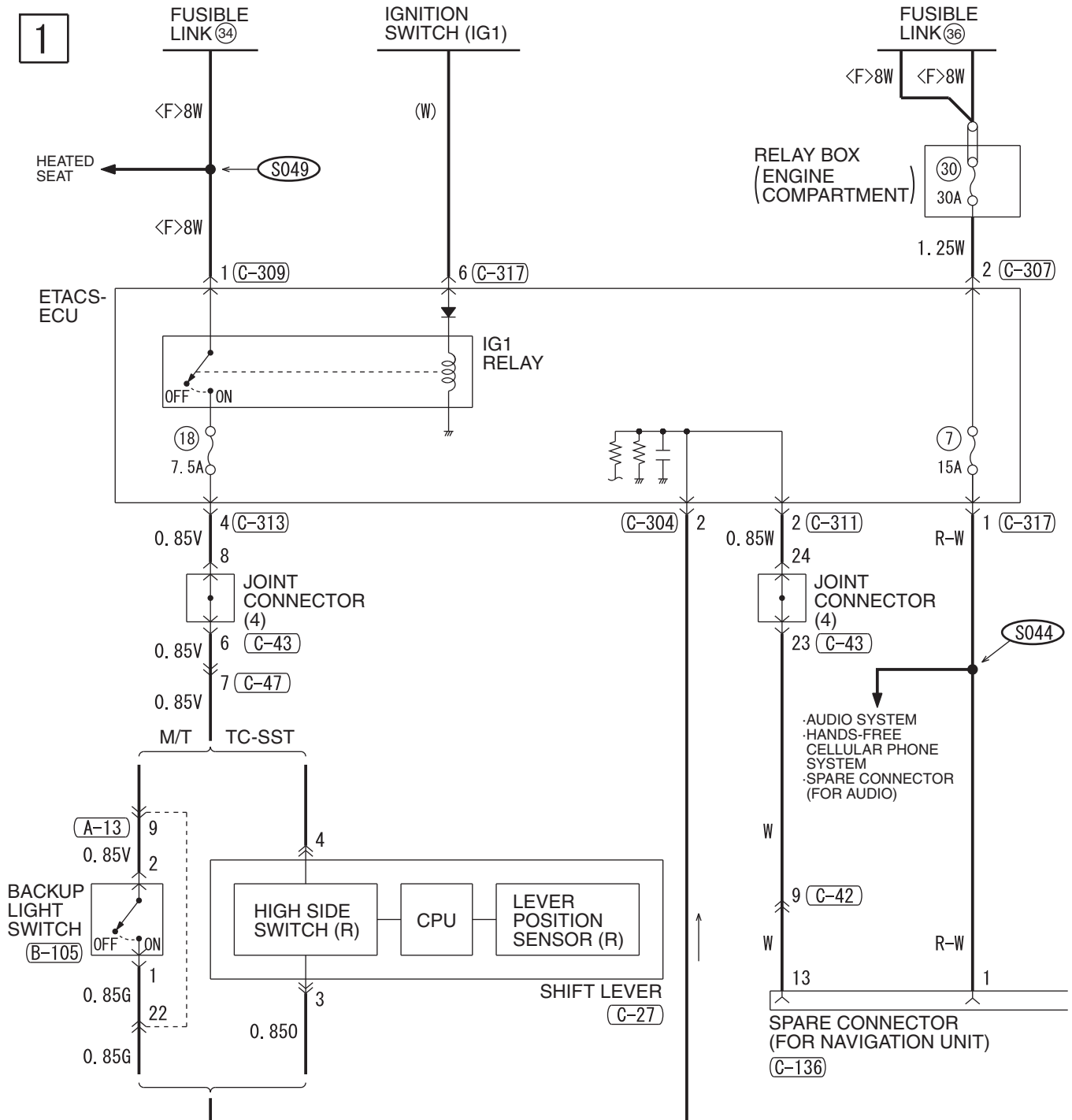

(A-13)

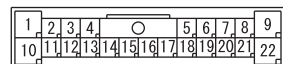

(B-105)



(C-27)

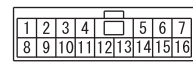

(C-42)

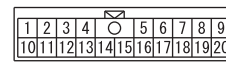

(C-43)

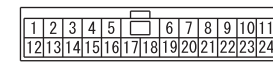

(C-311)

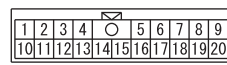

(C-313)

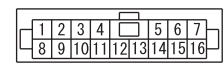

(C-317)

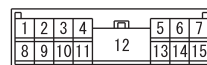

HAH14M08AA

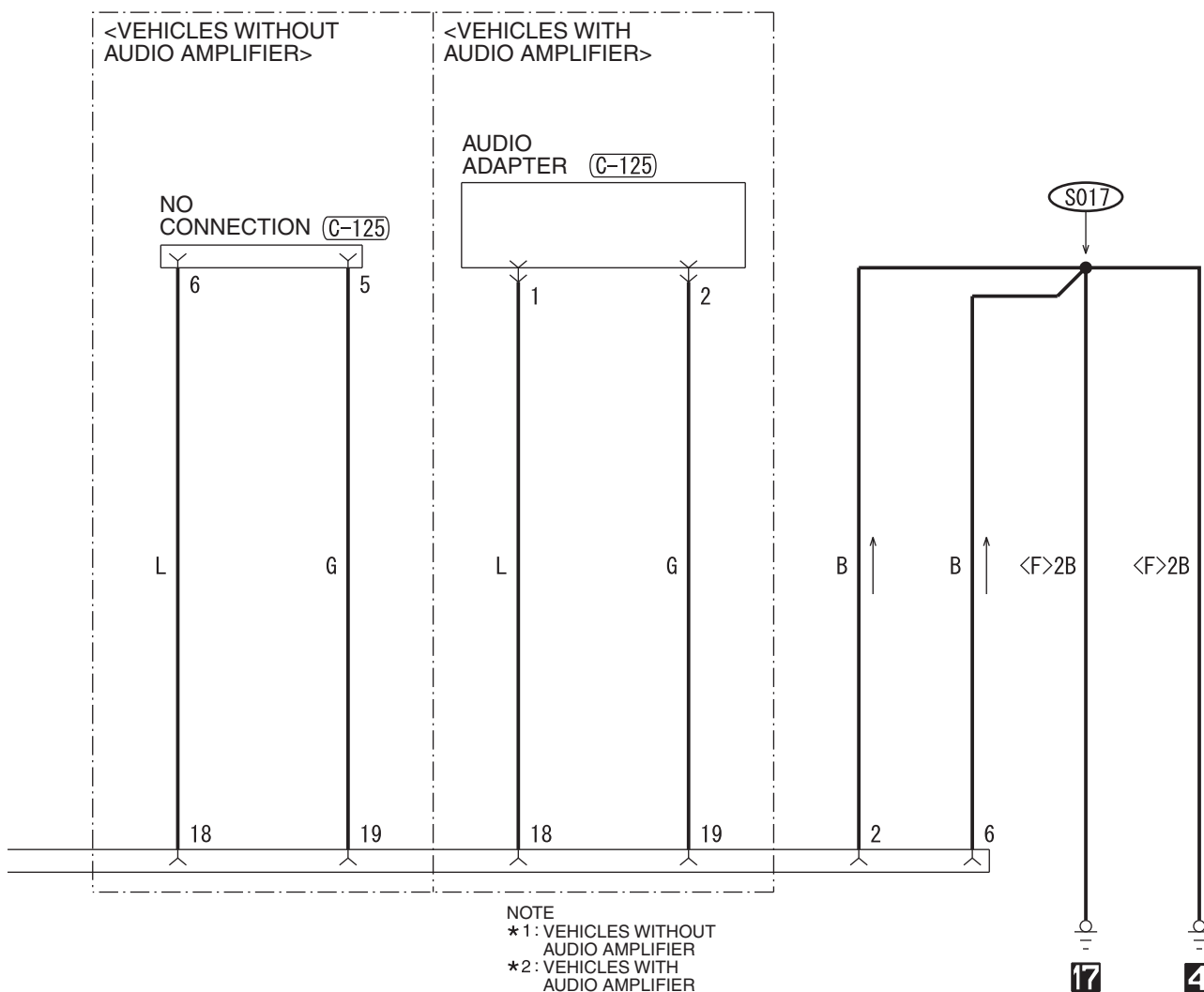

(C-47)

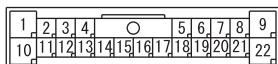

(C-125)

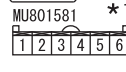

\*1

(MU801581) \*2

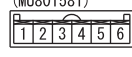

(C-136)

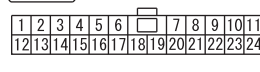

(C-304)

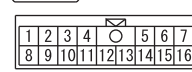

(C-307)



(C-309)



WIRE COLOR CODE

B: BLACK LG: LIGHT GREEN G: GREEN L: BLUE W: WHITE Y: YELLOW SB: SKY BLUE  
BR: BROWN O: ORANGE GR: GRAY R: RED P: PINK V: VIOLET PU: PURPLE SI: SILVER

HAH14M08AB

# ACCESSORY SOCKET AND CIGARETTE LIGHTER

1

**NOTE**

- \*1 : AIR CONDITIONING SYSTEM
- CENTRAL DOOR LOCKING SYSTEM
- DAYTIME RUNNING LIGHT (DRL)
- DOME LIGHT, LUGGAGE COMPARTMENT LIGHT AND IGNITION KEY HOLE ILLUMINATION LIGHT
- FOG LIGHT
- HEADLIGHT
- IGNITION KEY REMINDER TONE ALARM
- IMMOBILIZER SYSTEM
- KEYLESS OPERATING SYSTEM (KOS)
- TAILLIGHT
- POSITION LIGHT, REAR SIDE MARKER LIGHT, LICENSE PLATE LIGHT AND LIGHTING MONITOR TONE ALARM
- THEFT-ALARM SYSTEM
- TIRE PRESSURE MONITORING SYSTEM (TPMS)
- TRUNK LID OPENER
- TURN-SIGNAL LIGHT AND HAZARD WARNING LIGHT
- WINDSHIELD WIPER AND WASHER
- \*2 : -ABS, ASC, ACD, AYC AND S-AWC
- AIR CONDITIONING SYSTEM
- AUDIO SYSTEM
- HANDS-FREE CELLULAR PHONE SYSTEM
- HEADLIGHT LEVELING SYSTEM
- HEATED SEAT
- TURN-SIGNAL LIGHT AND HAZARD WARNING LIGHT
- TWIN CLUTCH-SPORTRONIC SHIFT TRANSMISSION (TC-SST)
- \*3 : -ABS, ASC, ACD, AYC AND S-AWC
- AIR CONDITIONING SYSTEM
- AUDIO SYSTEM
- CRUISE CONTROL SYSTEM
- HANDS-FREE CELLULAR PHONE SYSTEM
- HEADLIGHT LEVELING SYSTEM
- HEATED SEAT
- MITSUBISHI MULTI-COMMUNICATION SYSTEM (MMCS)
- TURN-SIGNAL LIGHT AND HAZARD WARNING LIGHT
- TWIN CLUTCH-SPORTRONIC SHIFT TRANSMISSION (TC-SST)

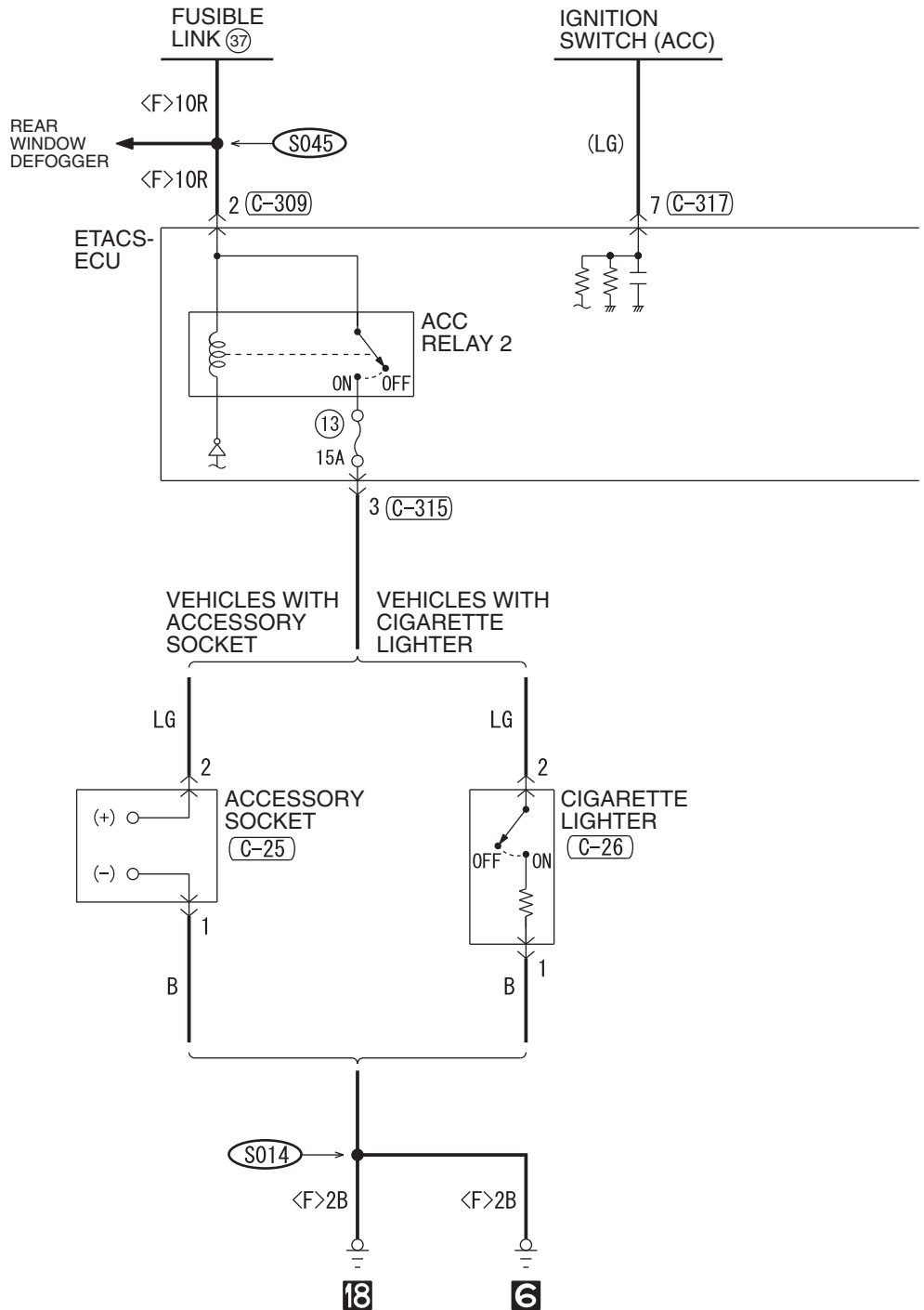

(C-04)

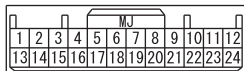

(C-25)



(C-26)



(C-103)

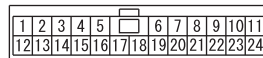

(C-105)

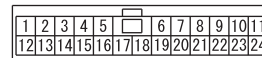

(C-137)



**2**

<VEHICLES WITH CIGARETTE LIGHTER ILLUMINATION LIGHT>

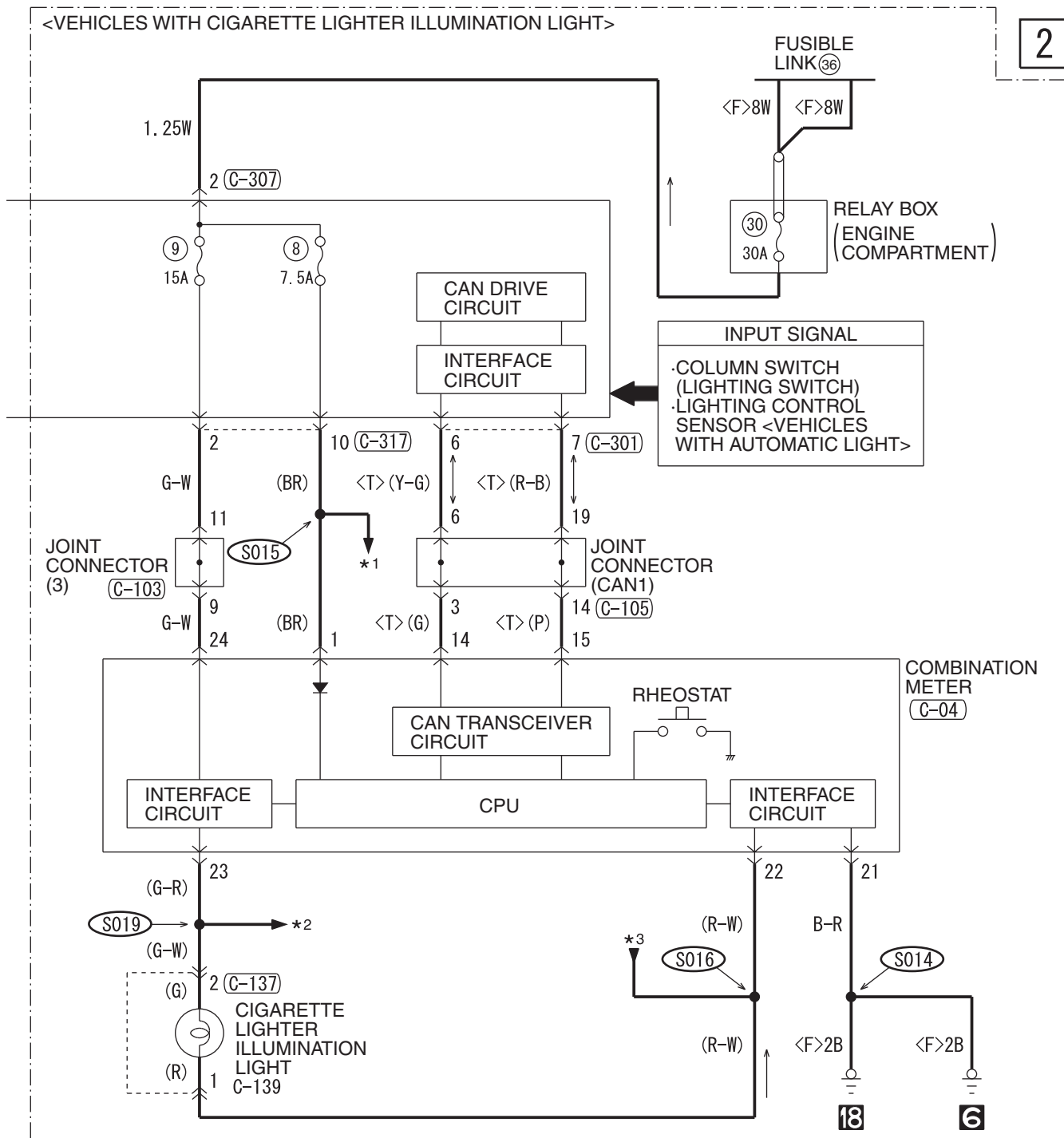

(C-301)

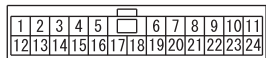

(C-307)



(C-309)



(C-315)



(C-317)

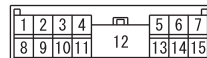

**WIRE COLOR CODE**

B : BLACK   LG : LIGHT GREEN   G : GREEN   L : BLUE   W : WHITE   Y : YELLOW   SB : SKY BLUE  
 BR : BROWN   O : ORANGE   GR : GRAY   R : RED   P : PINK   V : VIOLET   PU : PURPLE   SI : SILVER

ABS, ASC, ACD, AYC AND S-AWC <M/T>

M1901032500262

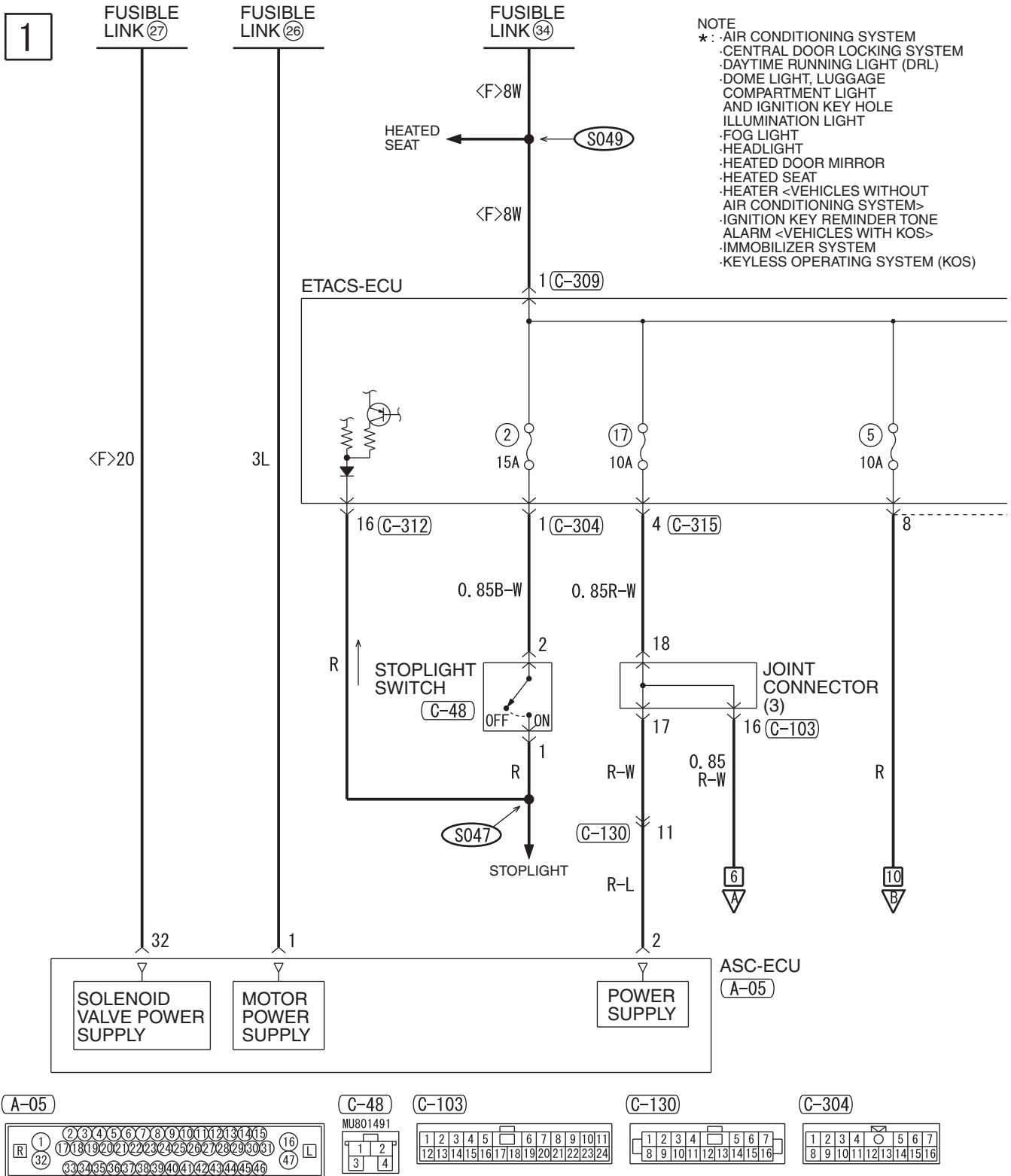

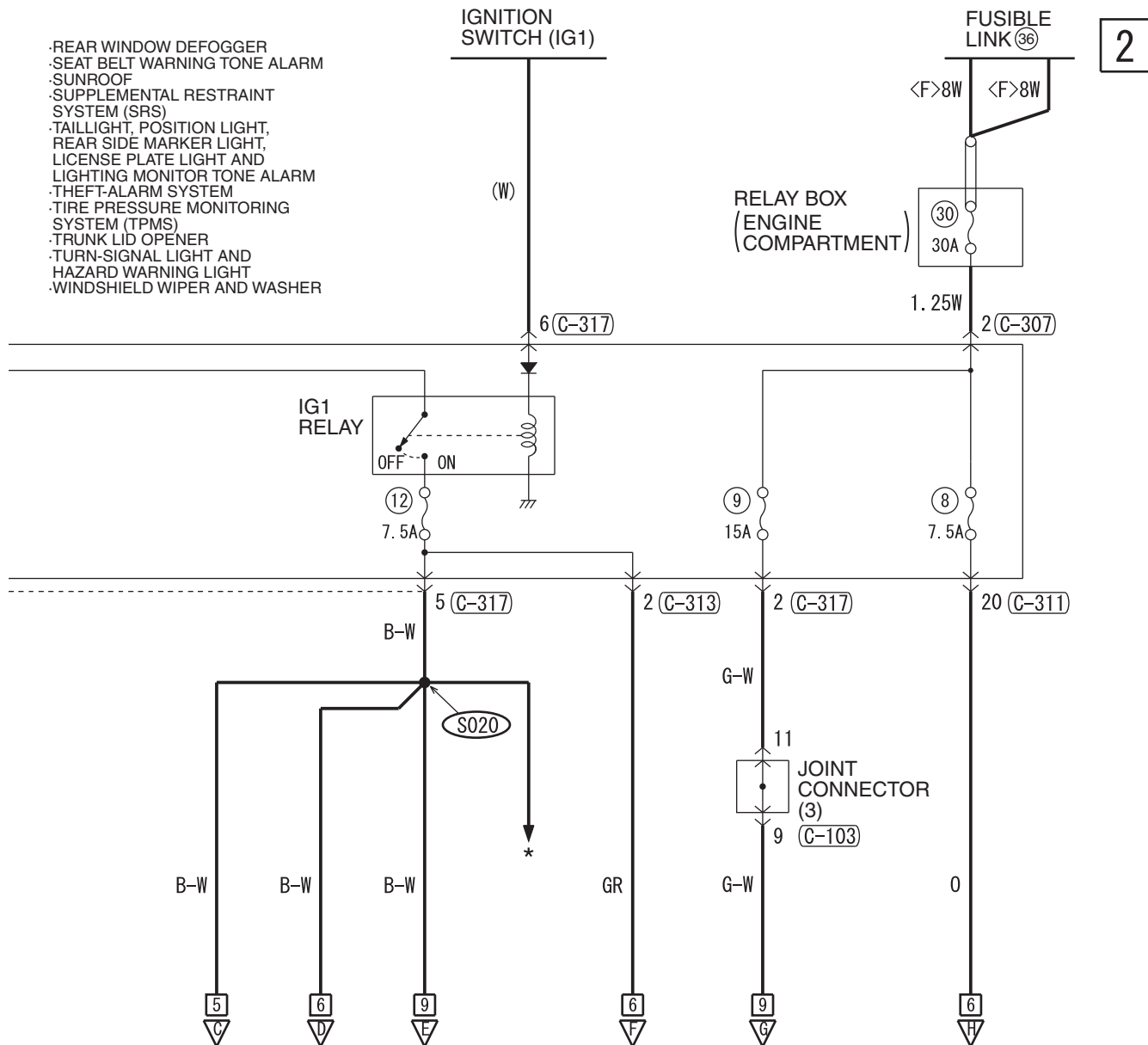

(C-307)



(C-309)



(C-311)

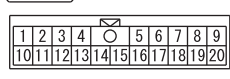

(C-312)

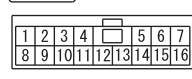

(C-313)

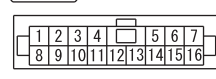

(C-315)



(C-317)

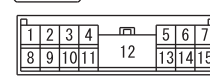

**WIRE COLOR CODE**

B: BLACK LG: LIGHT GREEN G: GREEN L: BLUE W: WHITE Y: YELLOW SB: SKY BLUE  
 BR: BROWN O: ORANGE GR: GRAY R: RED P: PINK V: VIOLET PU: PURPLE SI: SILVER

ABS, ASC, ACD, AYC AND S-AWC <M/T> (CONTINUED)

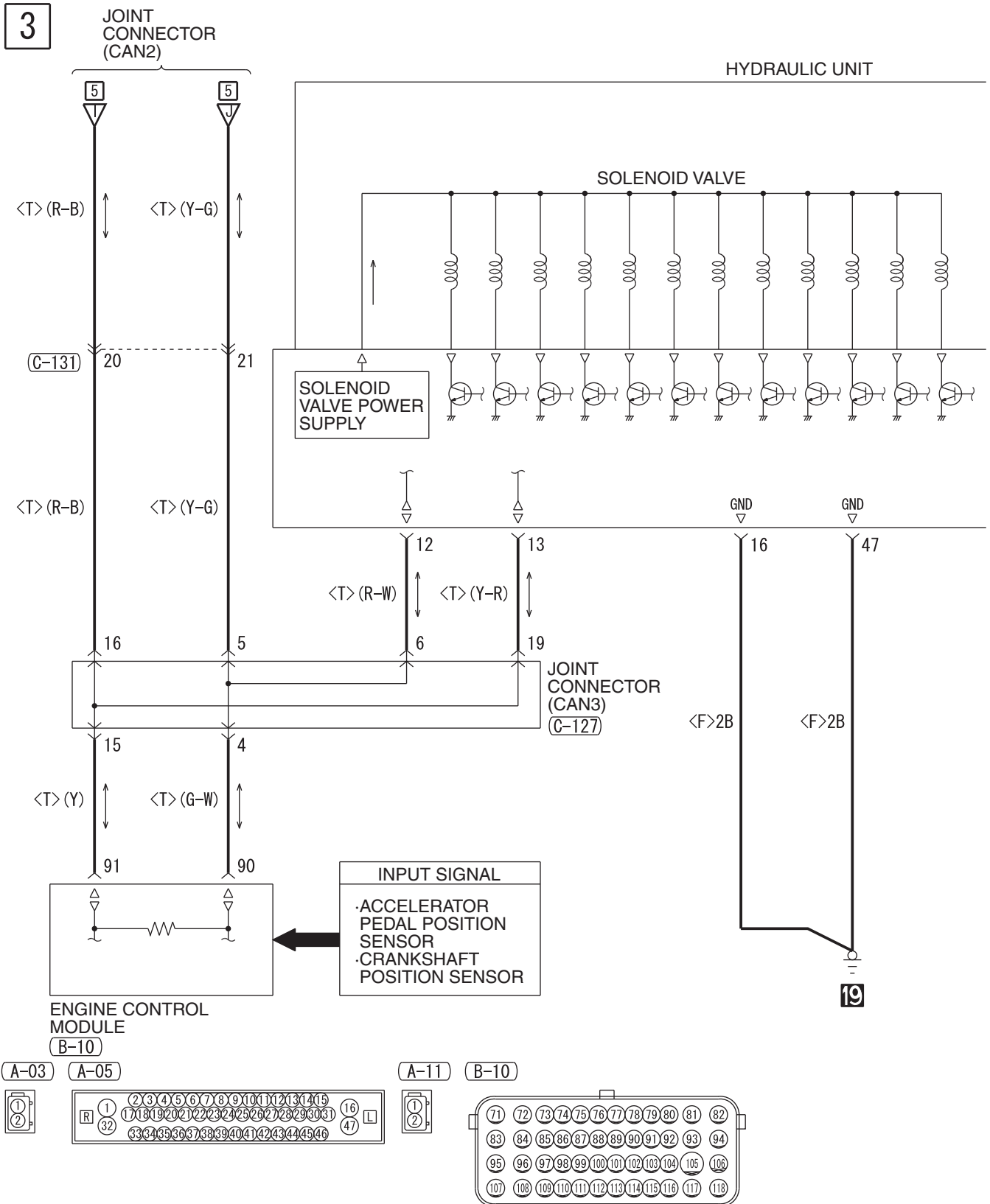



4

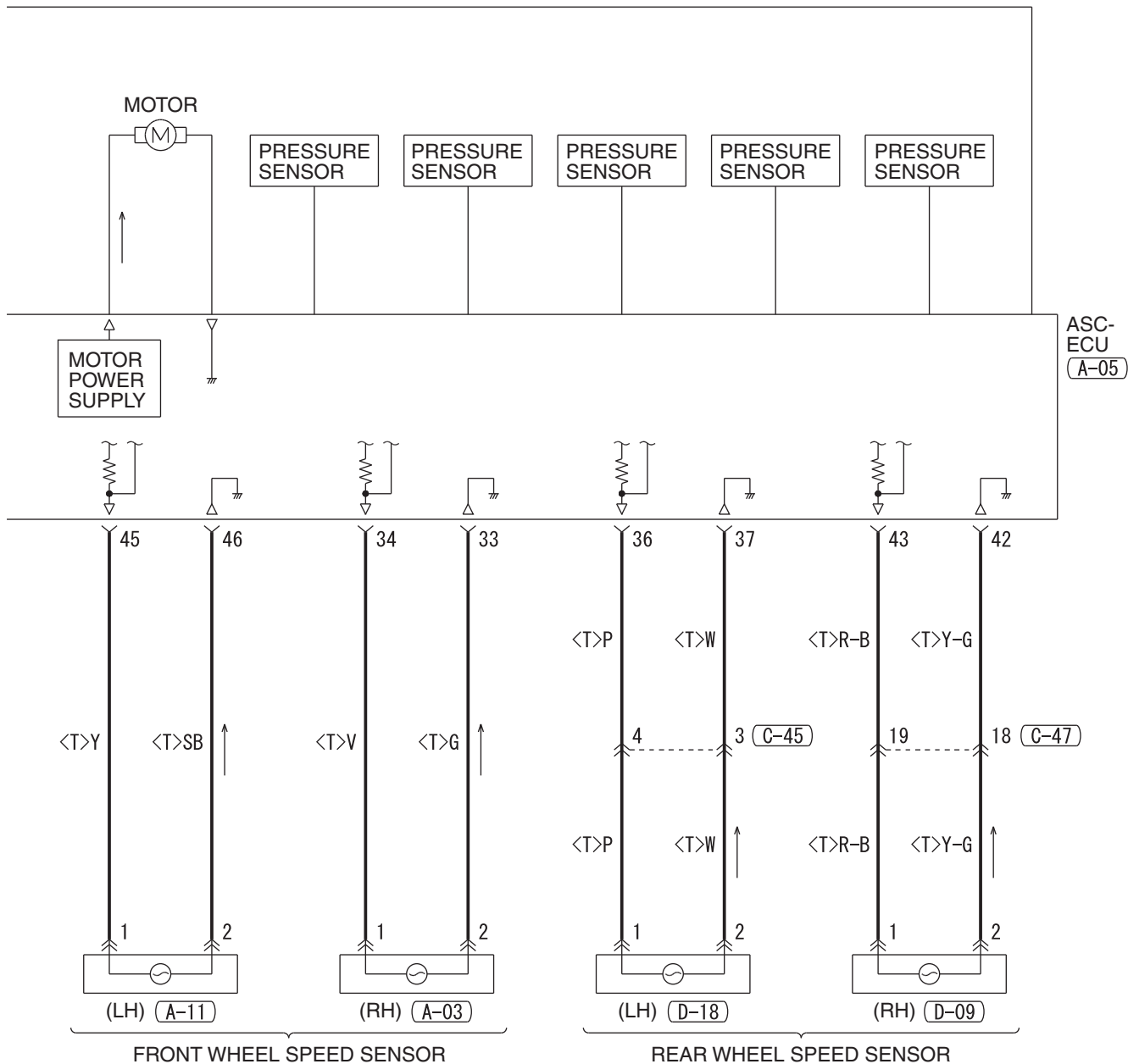

(C-45)

(C-47)

(C-127)

(C-131)

(D-09)

(D-18)

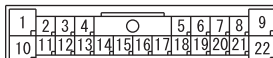
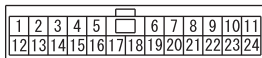

WIRE COLOR CODE

B : BLACK LG : LIGHT GREEN G : GREEN L : BLUE W : WHITE Y : YELLOW SB : SKY BLUE  
BR : BROWN O : ORANGE GR : GRAY R : RED P : PINK V : VIOLET PU : PURPLE SI : SILVER

HAH15M19BB

ABS, ASC, ACD, AYC AND S-AWC <M/T> (CONTINUED)

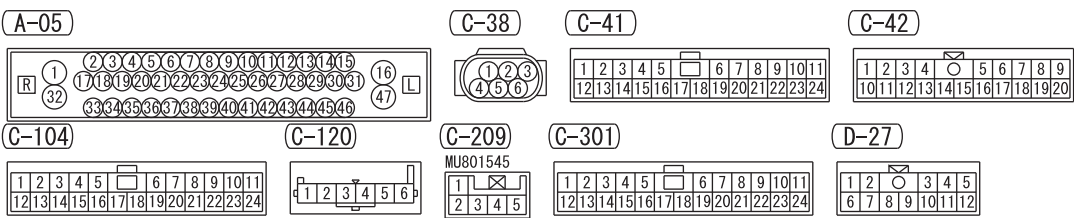
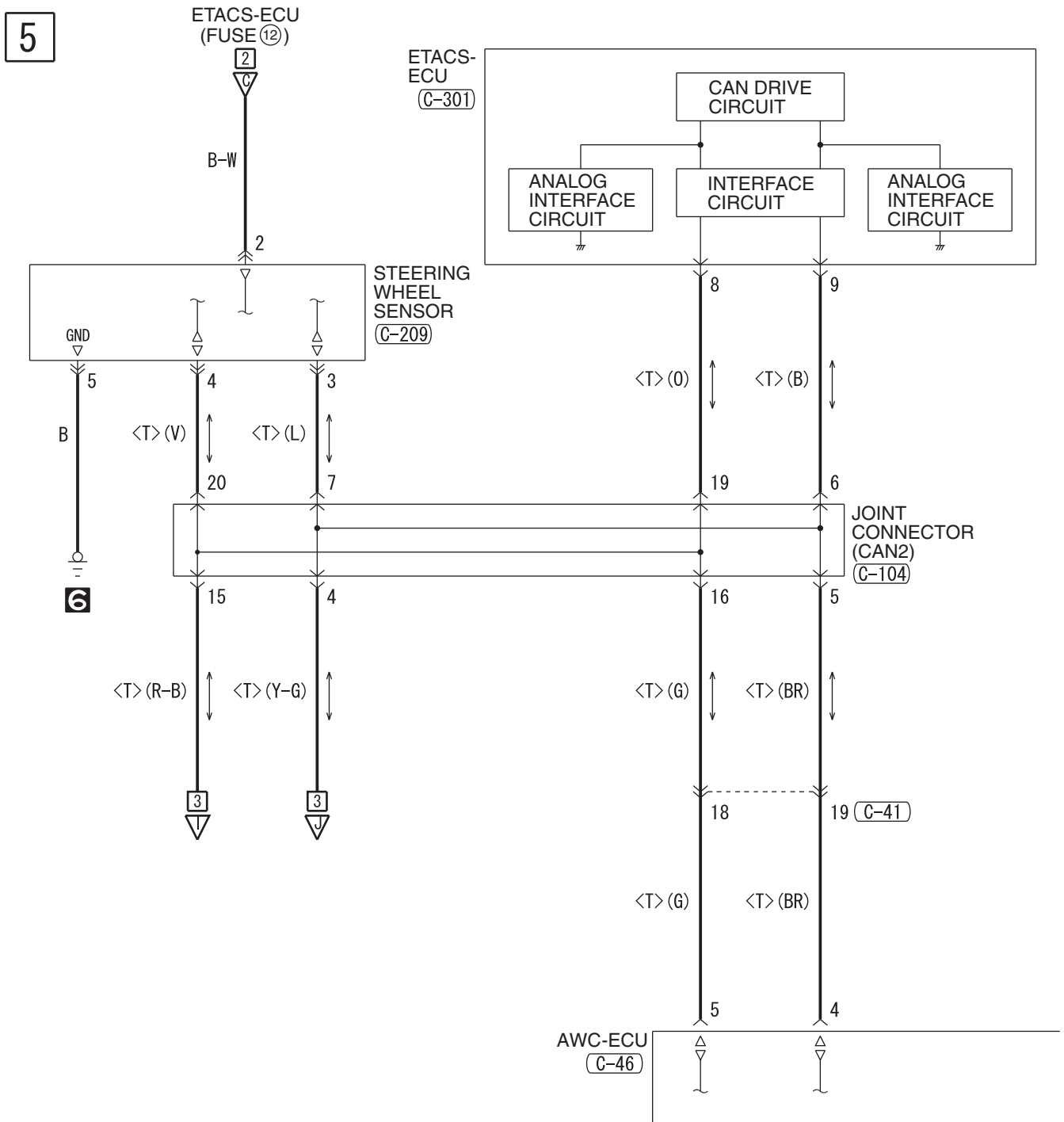

6

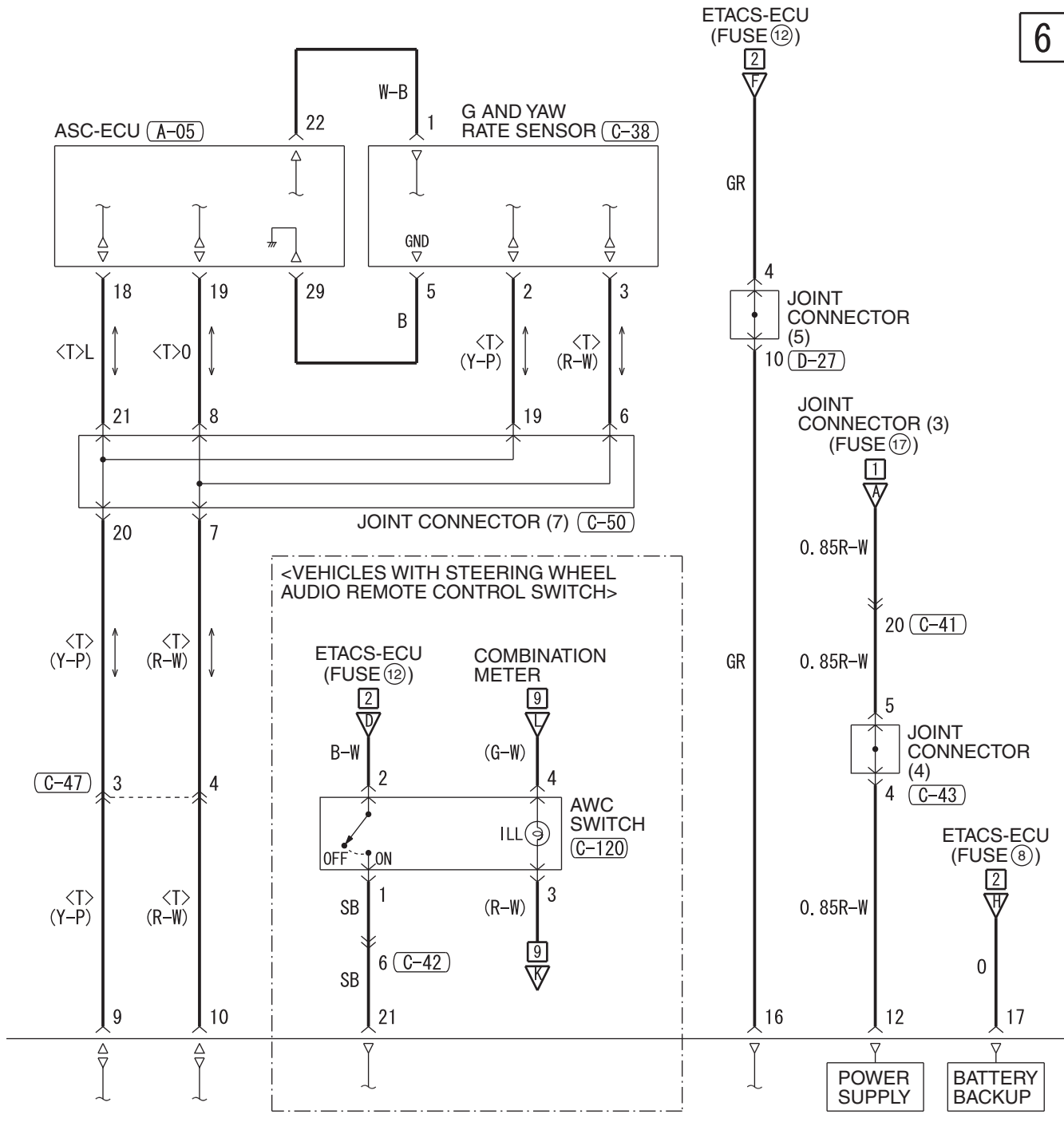

C-43

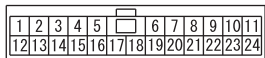

C-46



C-47

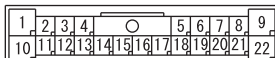

C-50

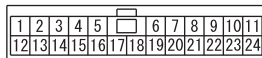

WIRE COLOR CODE

B : BLACK LG : LIGHT GREEN G : GREEN L : BLUE W : WHITE Y : YELLOW SB : SKY BLUE  
BR : BROWN O : ORANGE GR : GRAY R : RED P : PINK V : VIOLET PU : PURPLE SI : SILVER

ABS, ASC, ACD, AYC AND S-AWC <M/T> (CONTINUED)

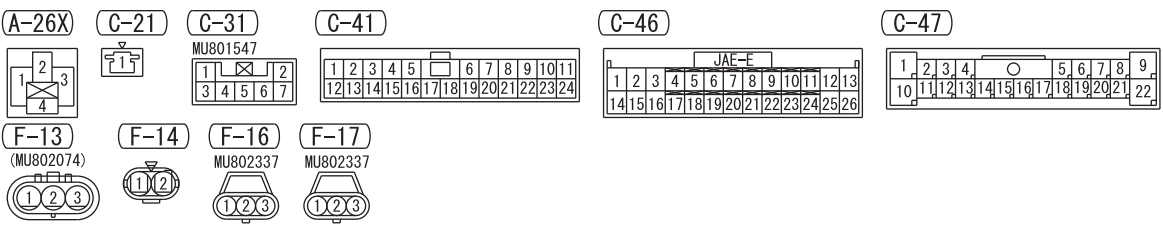
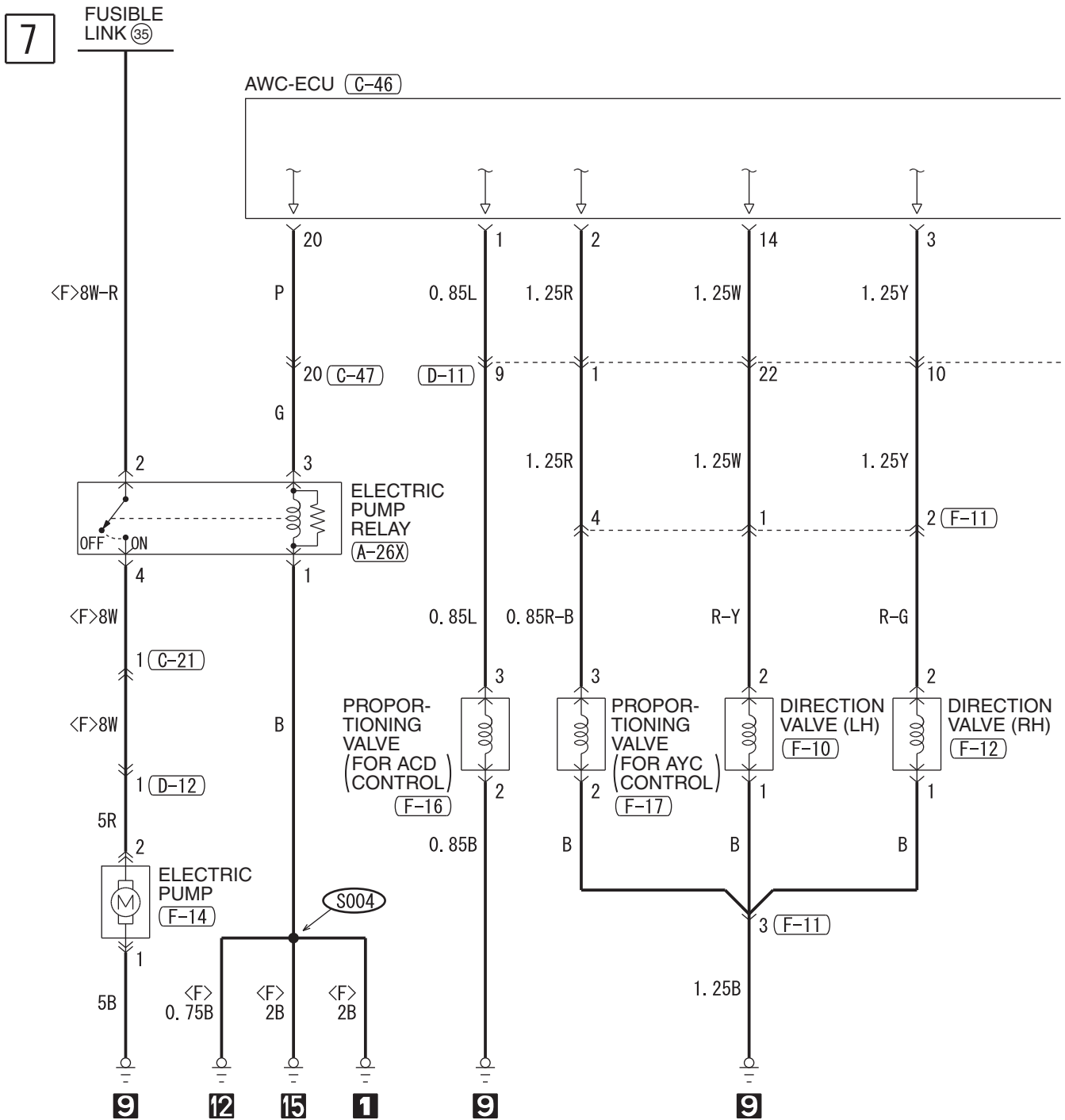

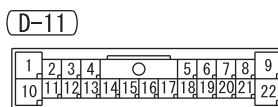
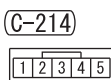
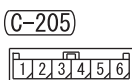
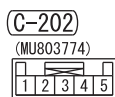
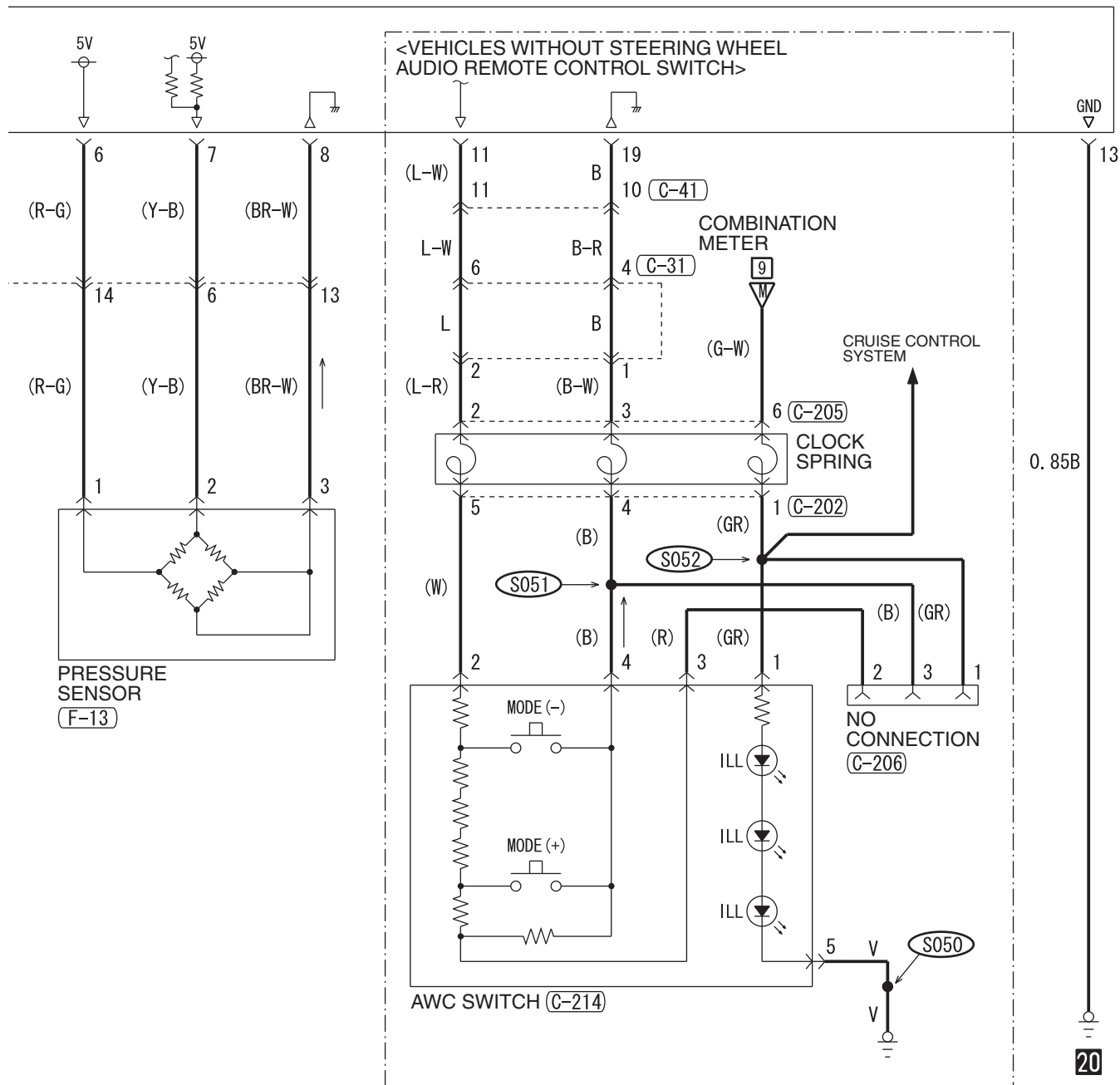

WIRE COLOR CODE  
B: BLACK LG: LIGHT GREEN G: GREEN L: BLUE W: WHITE Y: YELLOW SB: SKY BLUE  
BR: BROWN O: ORANGE GR: GRAY R: RED P: PINK V: VIOLET PU: PURPLE SI: SILVER

ABS, ASC, ACD, AYC AND S-AWC <M/T> (CONTINUED)

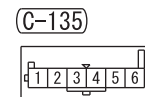
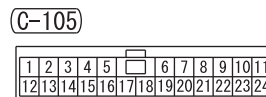
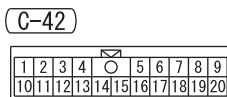
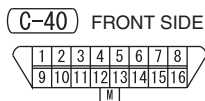
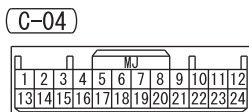
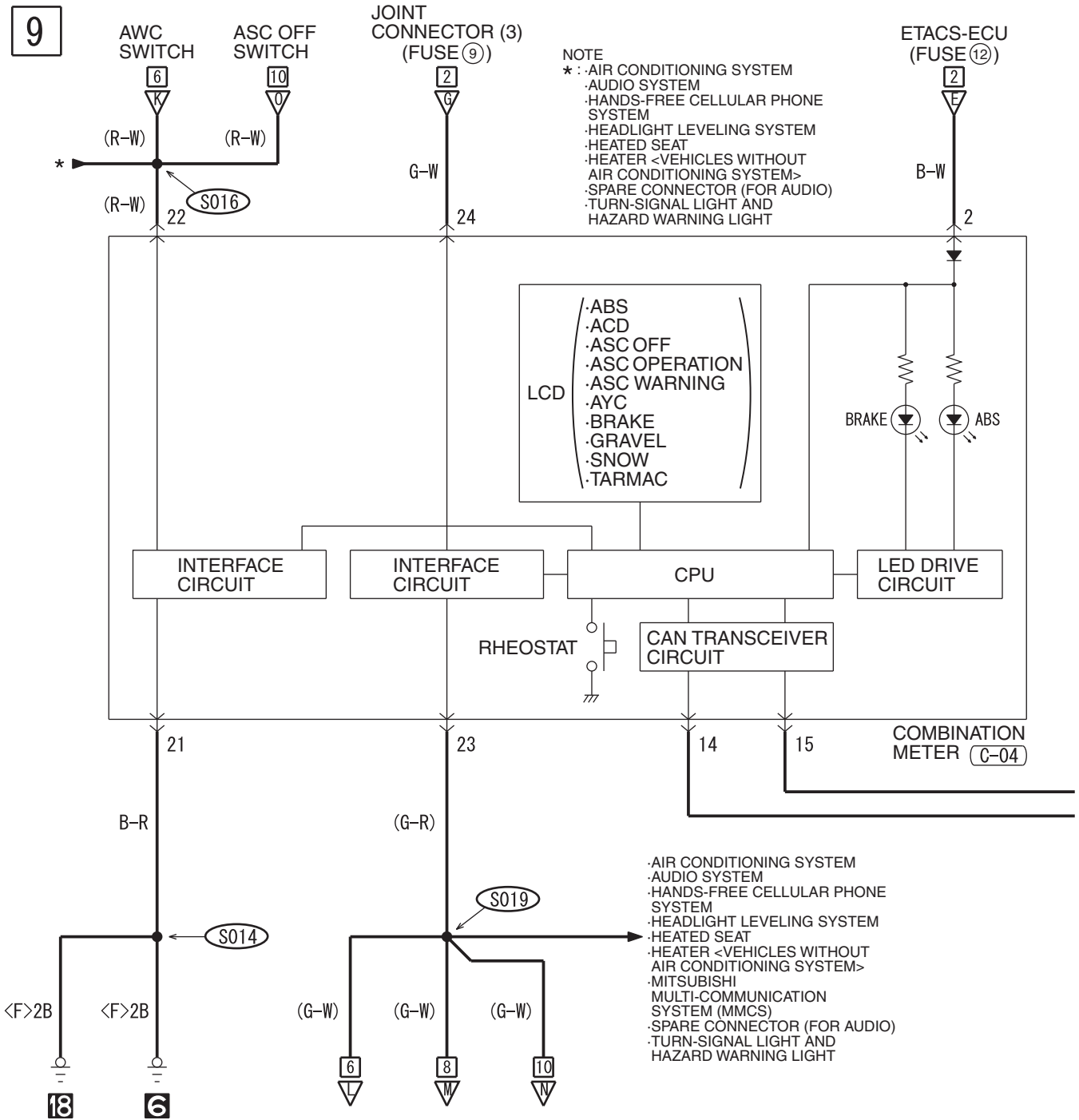

**10**

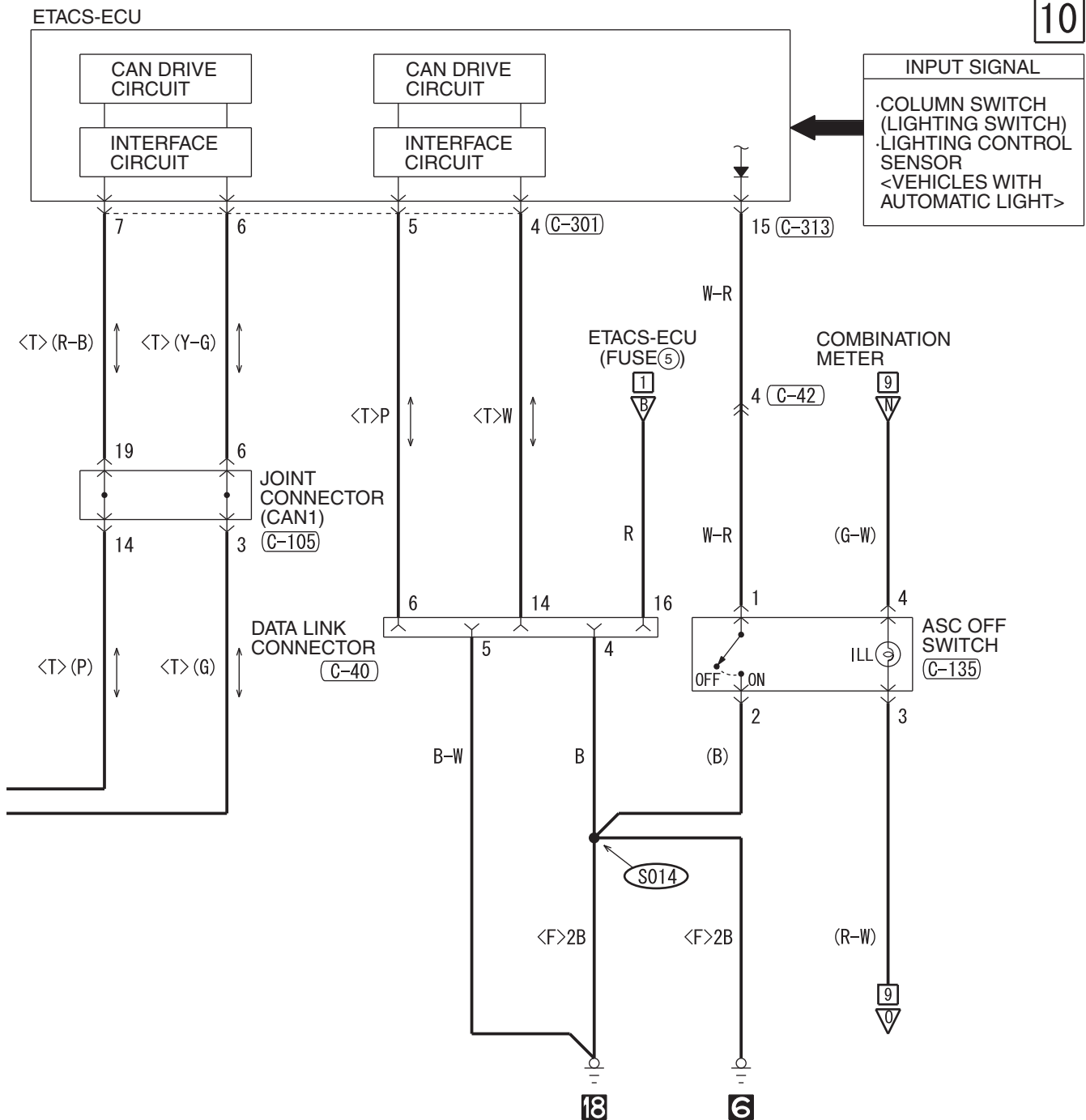

(C-301)

(C-313)

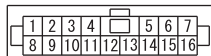

**WIRE COLOR CODE**

B: BLACK LG: LIGHT GREEN G: GREEN L: BLUE W: WHITE Y: YELLOW SB: SKY BLUE  
 BR: BROWN O: ORANGE GR: GRAY R: RED P: PINK V: VIOLET PU: PURPLE SI: SILVER

HAH15M19EB

**TSB Revision**

ABS, ASC, ACD, AYC AND S-AWC <TC-SST>

M1901032500273

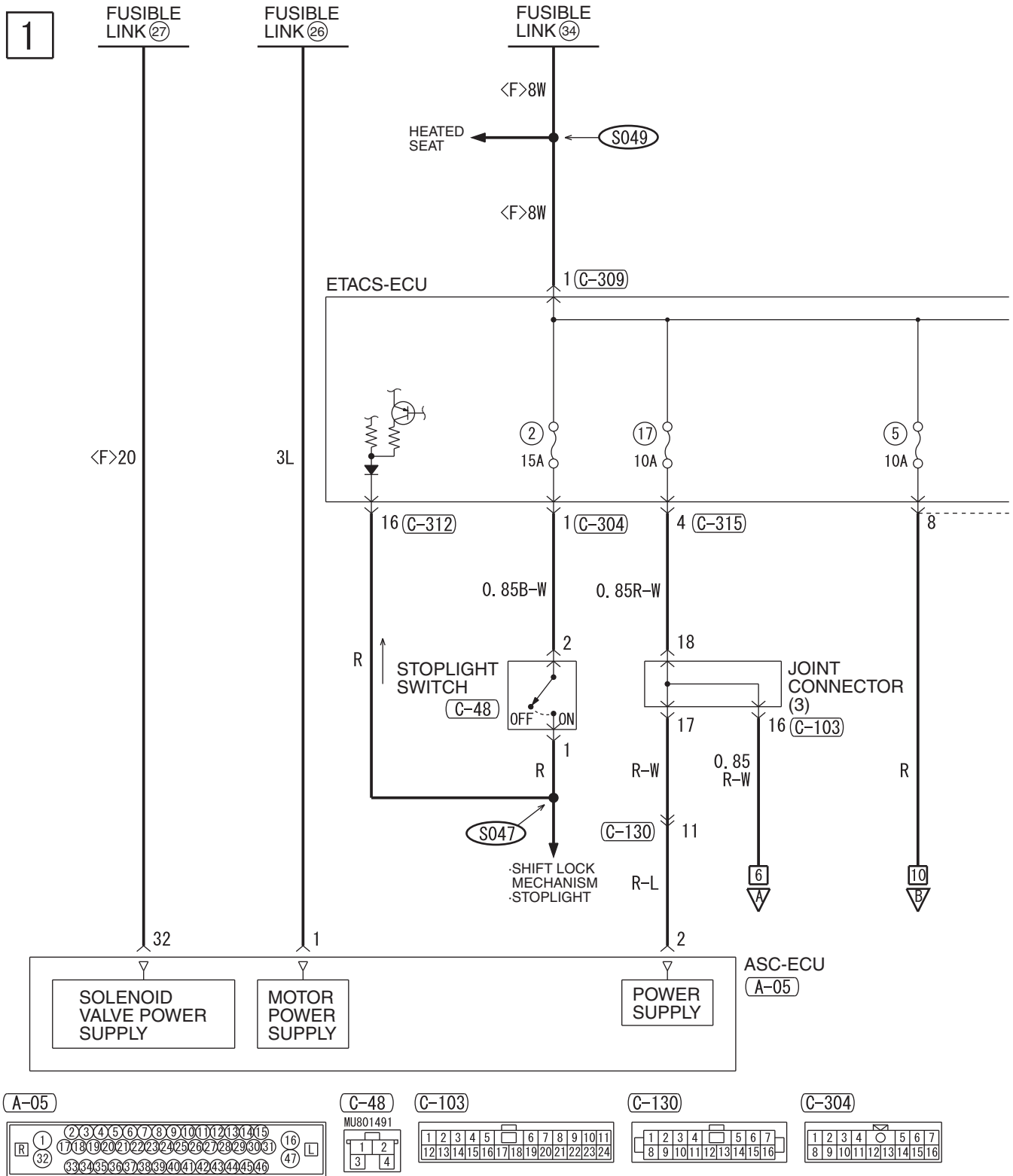

HAH15M20AA



2

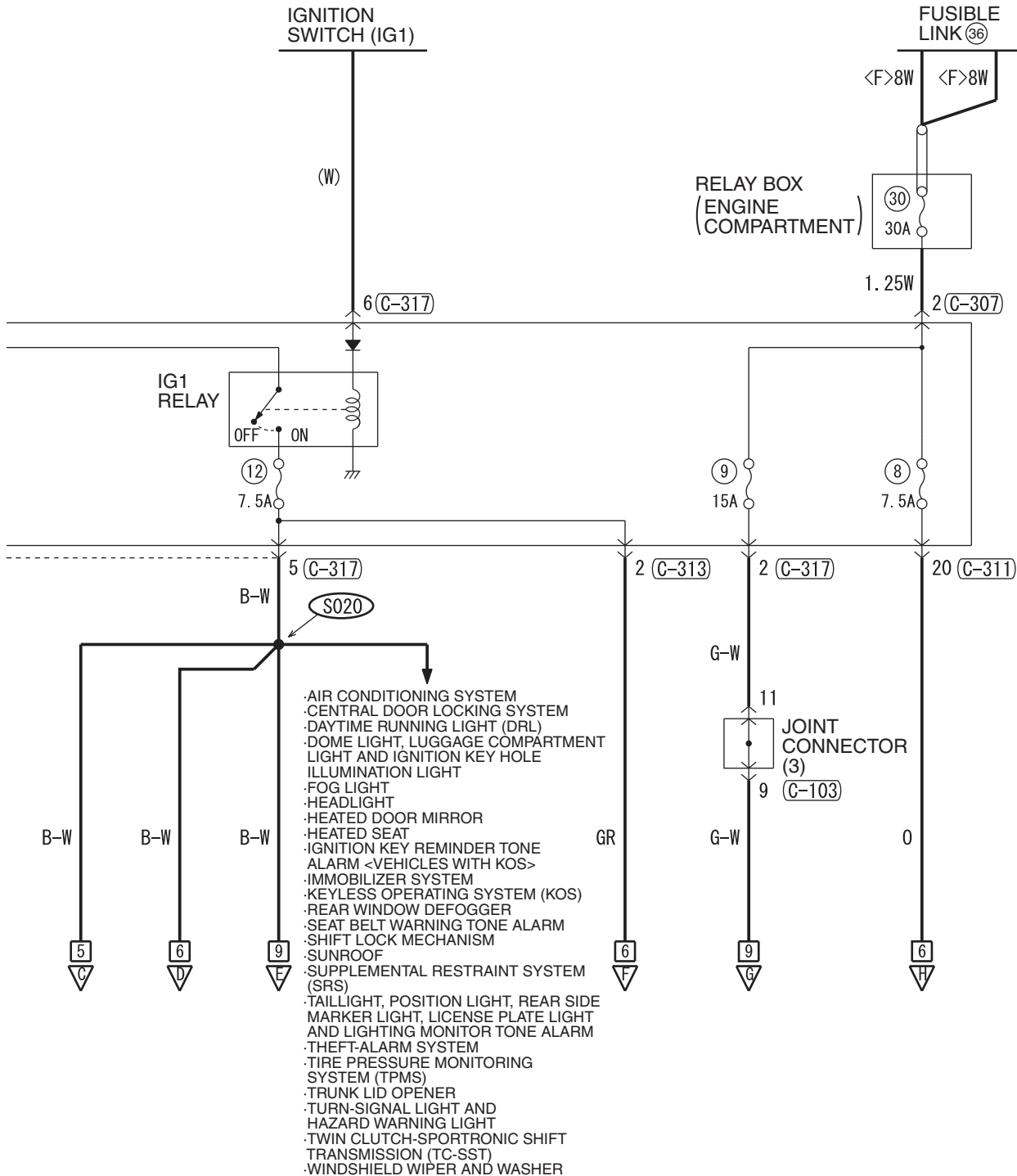

(C-307)

(C-309)

(C-311)

(C-312)

(C-313)

(C-315)

(C-317)

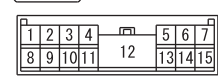
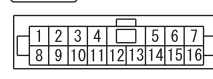
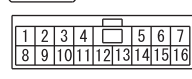
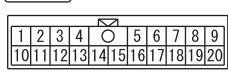

**WIRE COLOR CODE**

B : BLACK LG : LIGHT GREEN G : GREEN L : BLUE W : WHITE Y : YELLOW SB : SKY BLUE  
 BR : BROWN O : ORANGE GR : GRAY R : RED P : PINK V : VIOLET PU : PURPLE SI : SILVER

ABS, ASC, ACD, AYC AND S-AWC <TC-SST> (CONTINUED)

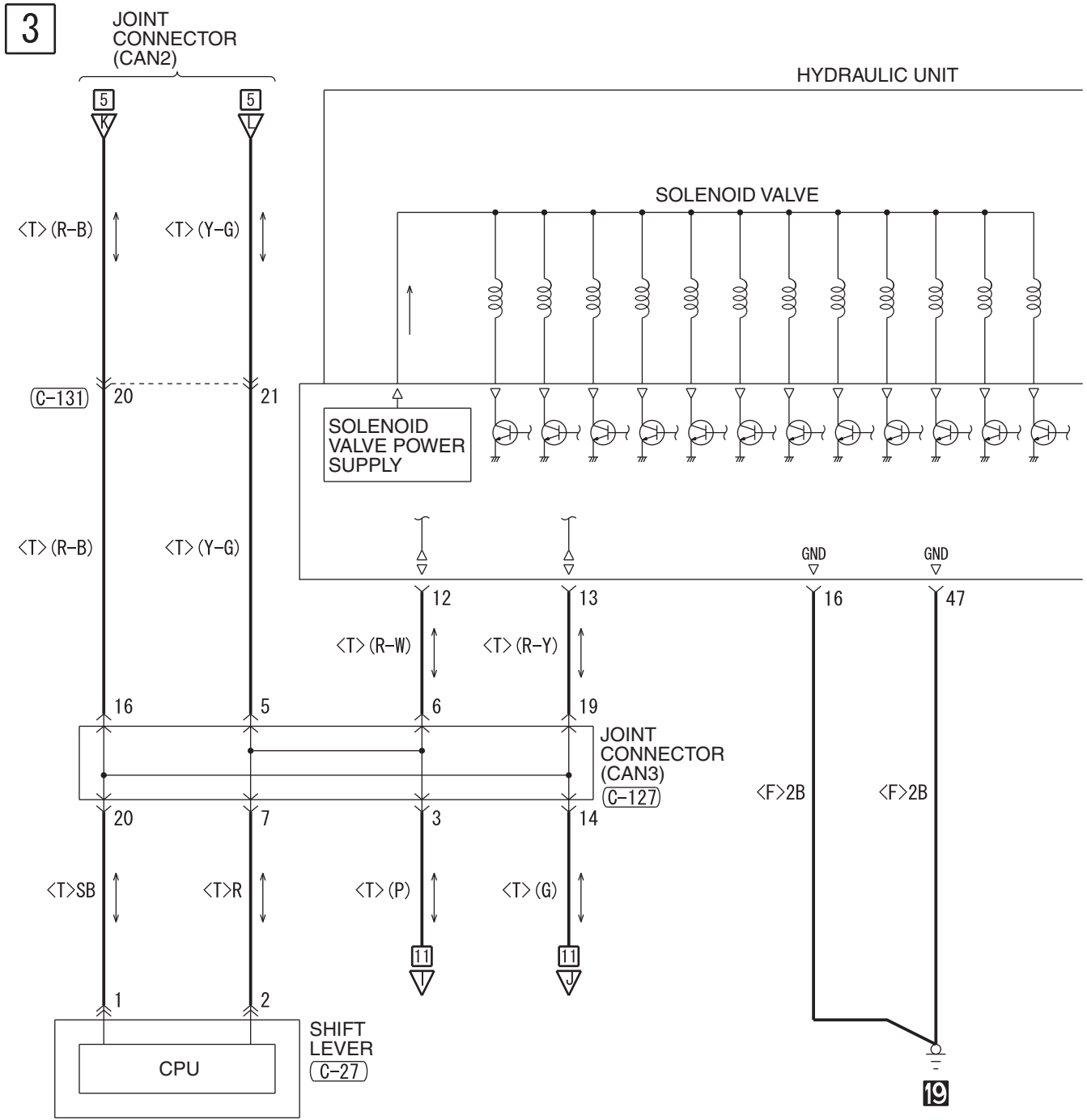

(A-03)

(A-05)

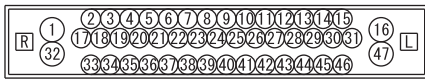

(A-11)

(C-27)

(C-45)

(C-47)

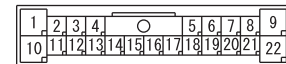
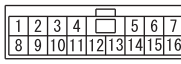

4

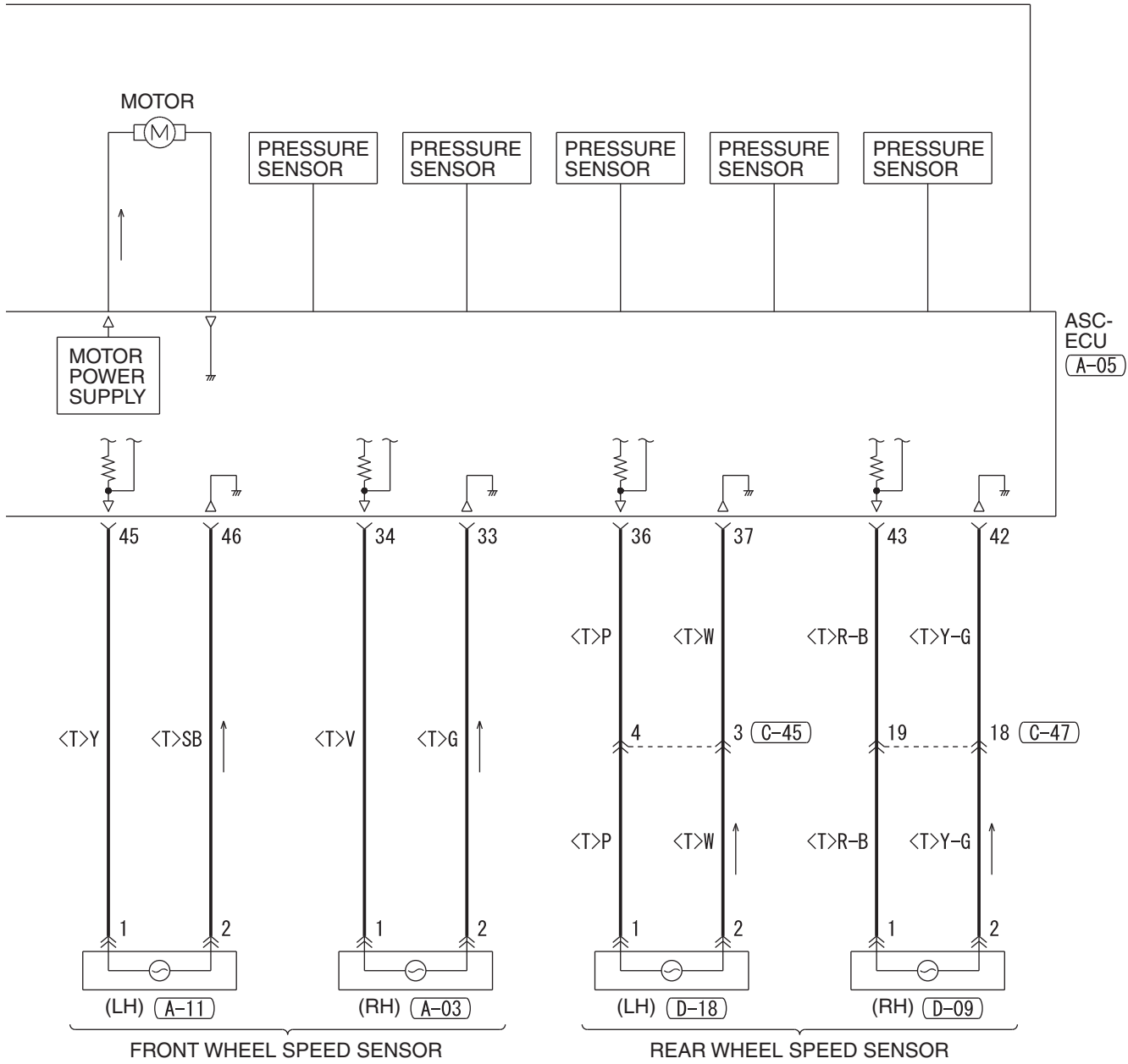

(C-127)

(C-131)

(D-09)

(D-18)

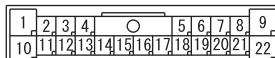
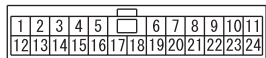

WIRE COLOR CODE  
B: BLACK LG: LIGHT GREEN G: GREEN L: BLUE W: WHITE Y: YELLOW SB: SKY BLUE  
BR: BROWN O: ORANGE GR: GRAY R: RED P: PINK V: VIOLET PU: PURPLE SI: SILVER

HAH15M20BB

TSB Revision

ABS, ASC, ACD, AYC AND S-AWC <TC-SST> (CONTINUED)

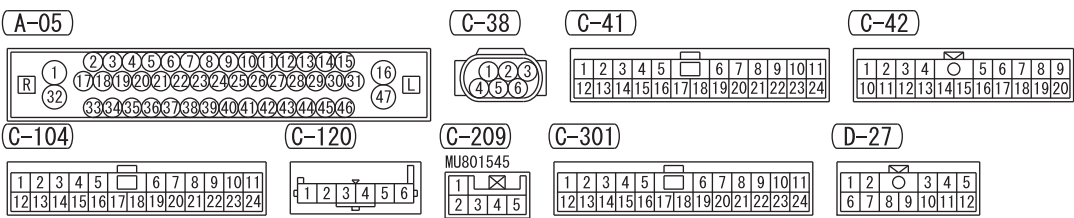
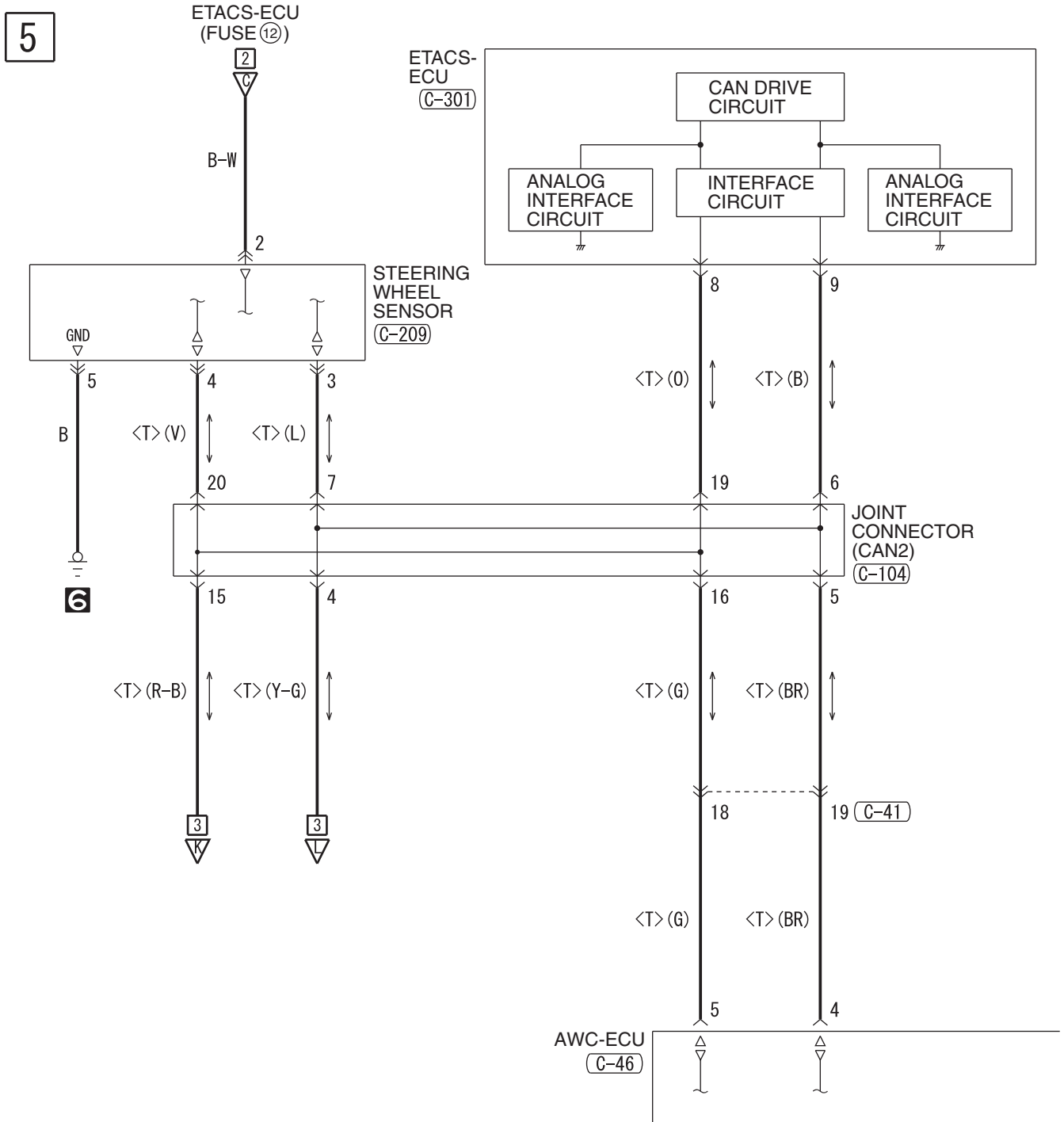

6

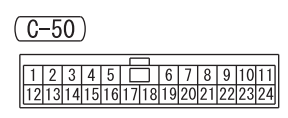
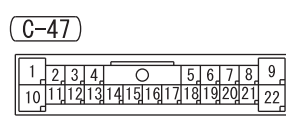
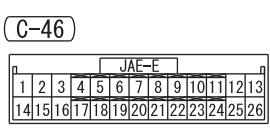
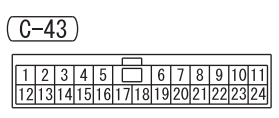
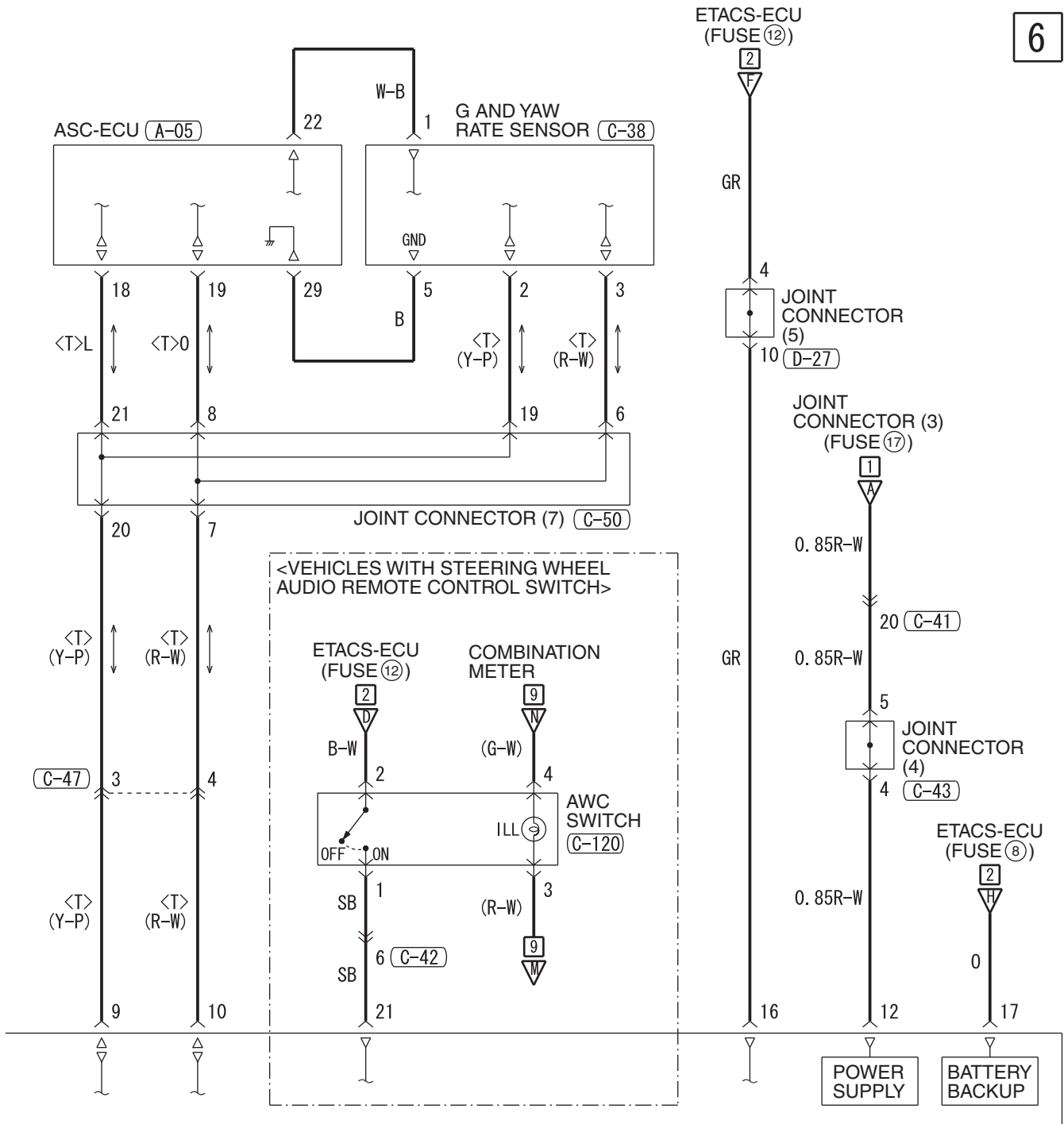

WIRE COLOR CODE  
B: BLACK LG: LIGHT GREEN G: GREEN L: BLUE W: WHITE Y: YELLOW SB: SKY BLUE  
BR: BROWN O: ORANGE GR: GRAY R: RED P: PINK V: VIOLET PU: PURPLE SI: SILVER

ABS, ASC, ACD, AYC AND S-AWC <TC-SST> (CONTINUED)

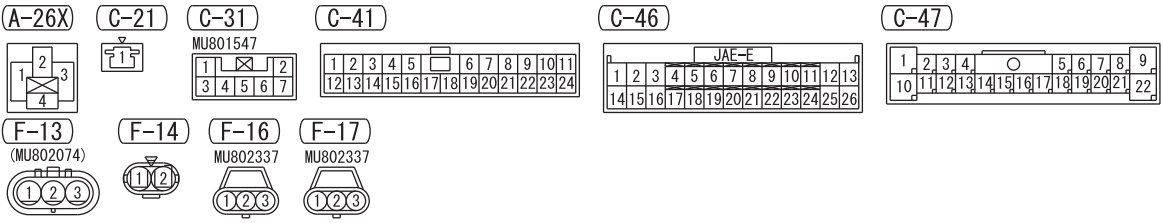
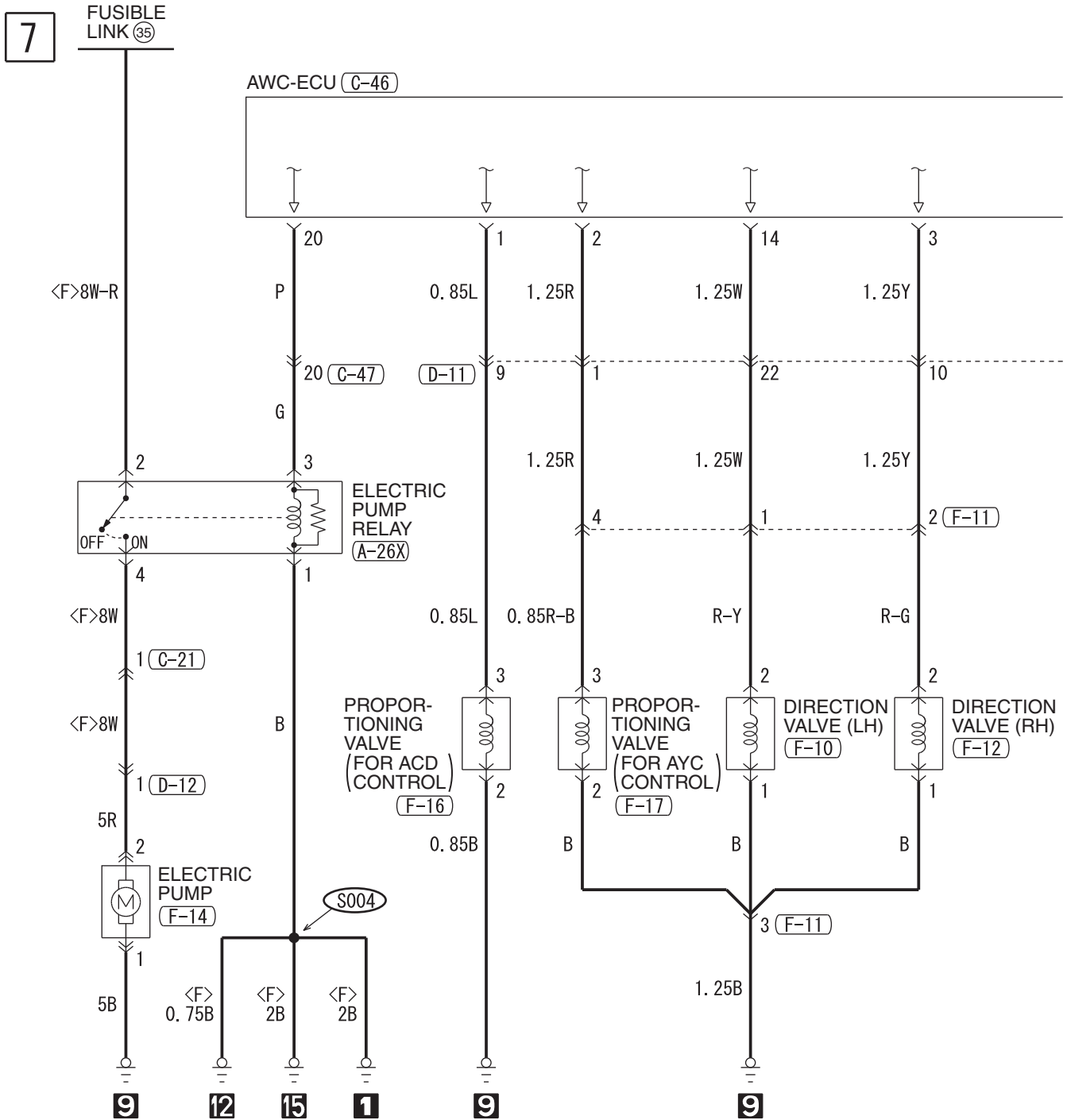

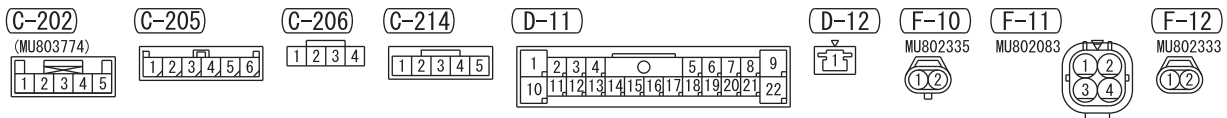
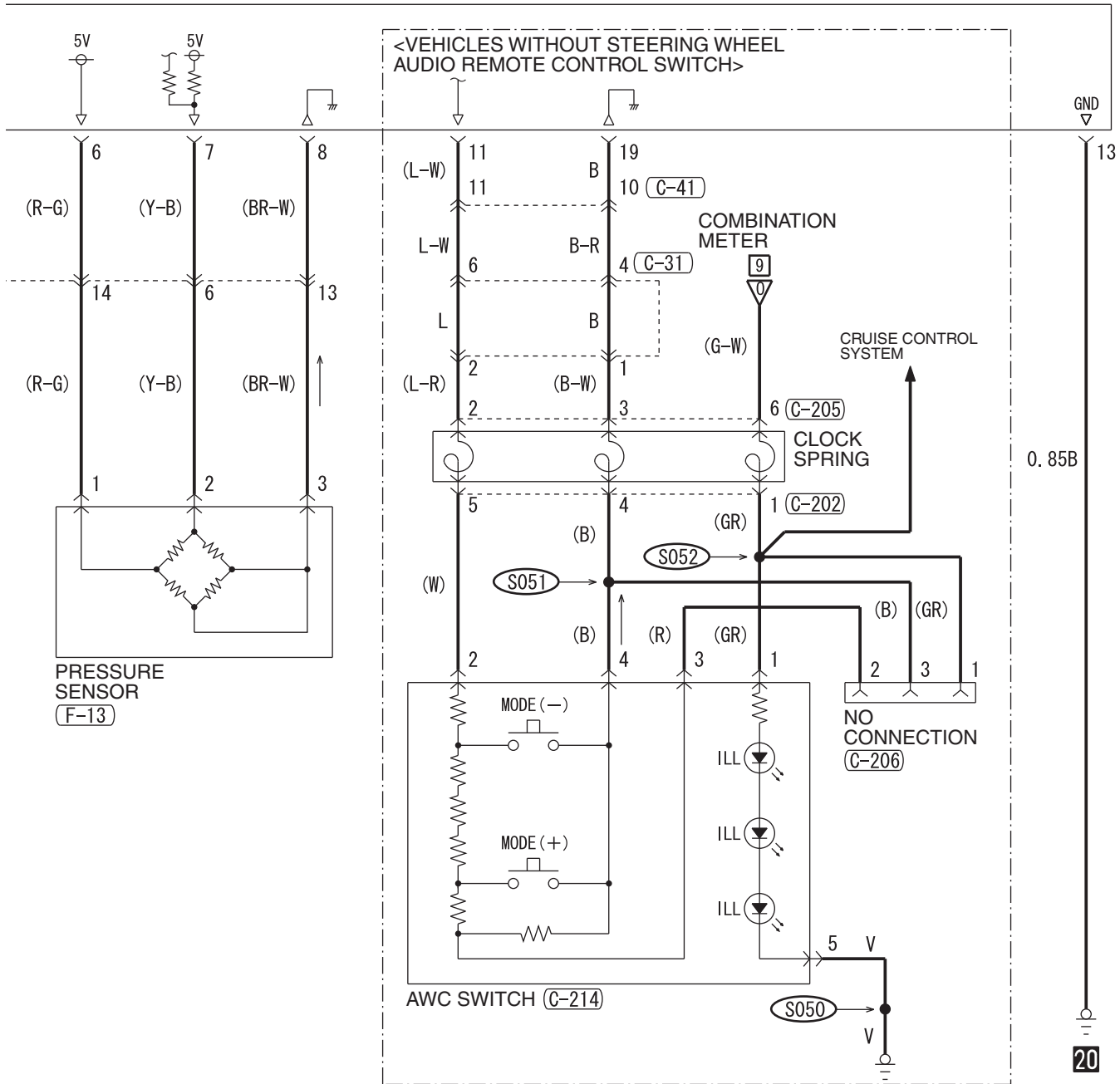

WIRE COLOR CODE  
 B: BLACK LG: LIGHT GREEN G: GREEN L: BLUE W: WHITE Y: YELLOW SB: SKY BLUE  
 BR: BROWN O: ORANGE GR: GRAY R: RED P: PINK V: VIOLET PU: PURPLE SI: SILVER

ABS, ASC, ACD, AYC AND S-AWC <TC-SST> (CONTINUED)

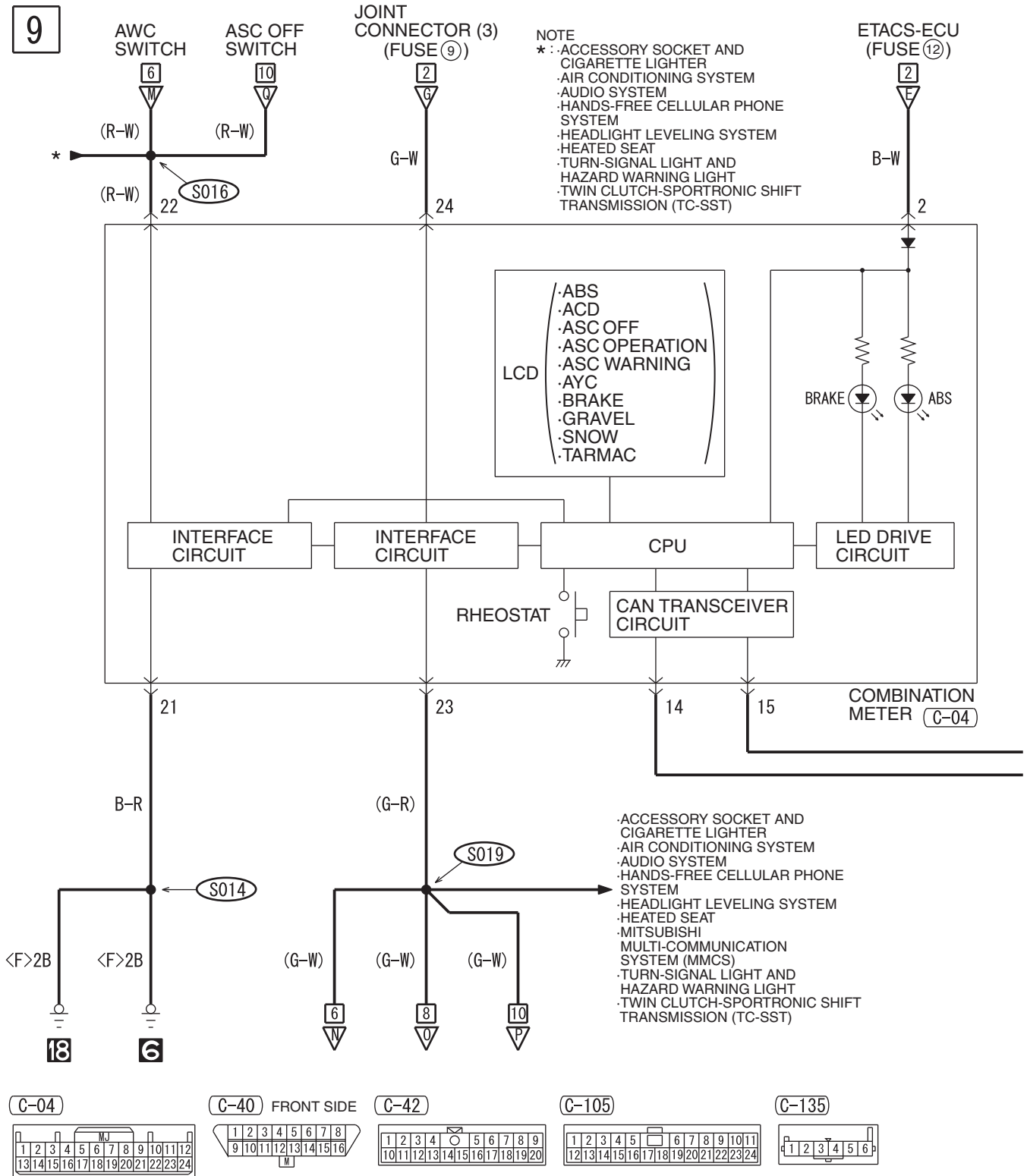



10

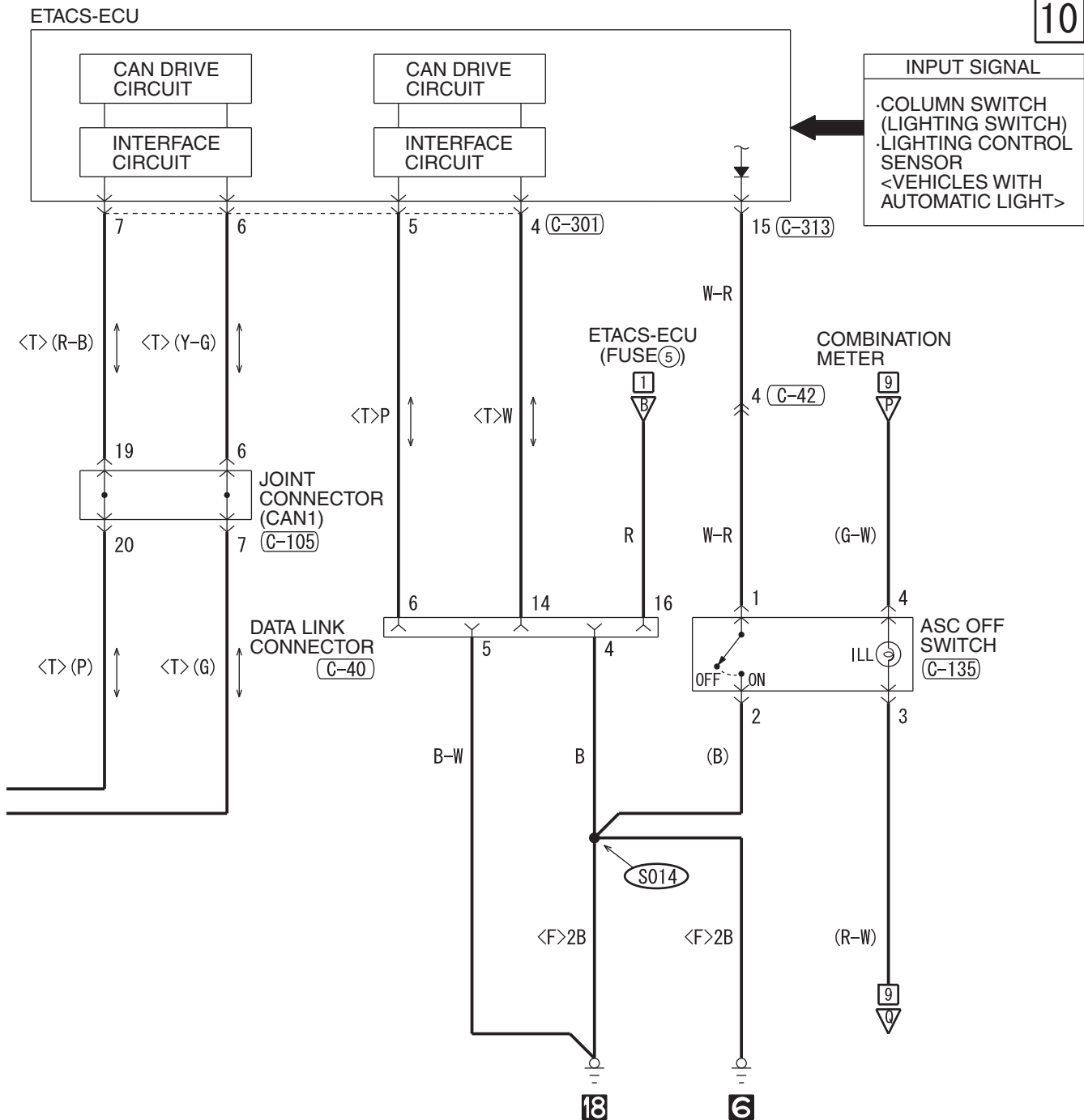

(C-301)

(C-313)

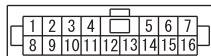
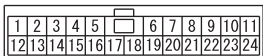

WIRE COLOR CODE  
 B: BLACK LG: LIGHT GREEN G: GREEN L: BLUE W: WHITE Y: YELLOW SB: SKY BLUE  
 BR: BROWN O: ORANGE GR: GRAY R: RED P: PINK V: VIOLET PU: PURPLE SI: SILVER

HAH15M20EB

TSB Revision

ABS, ASC, ACD, AYC AND S-AWC <TC-SST> (CONTINUED)

11

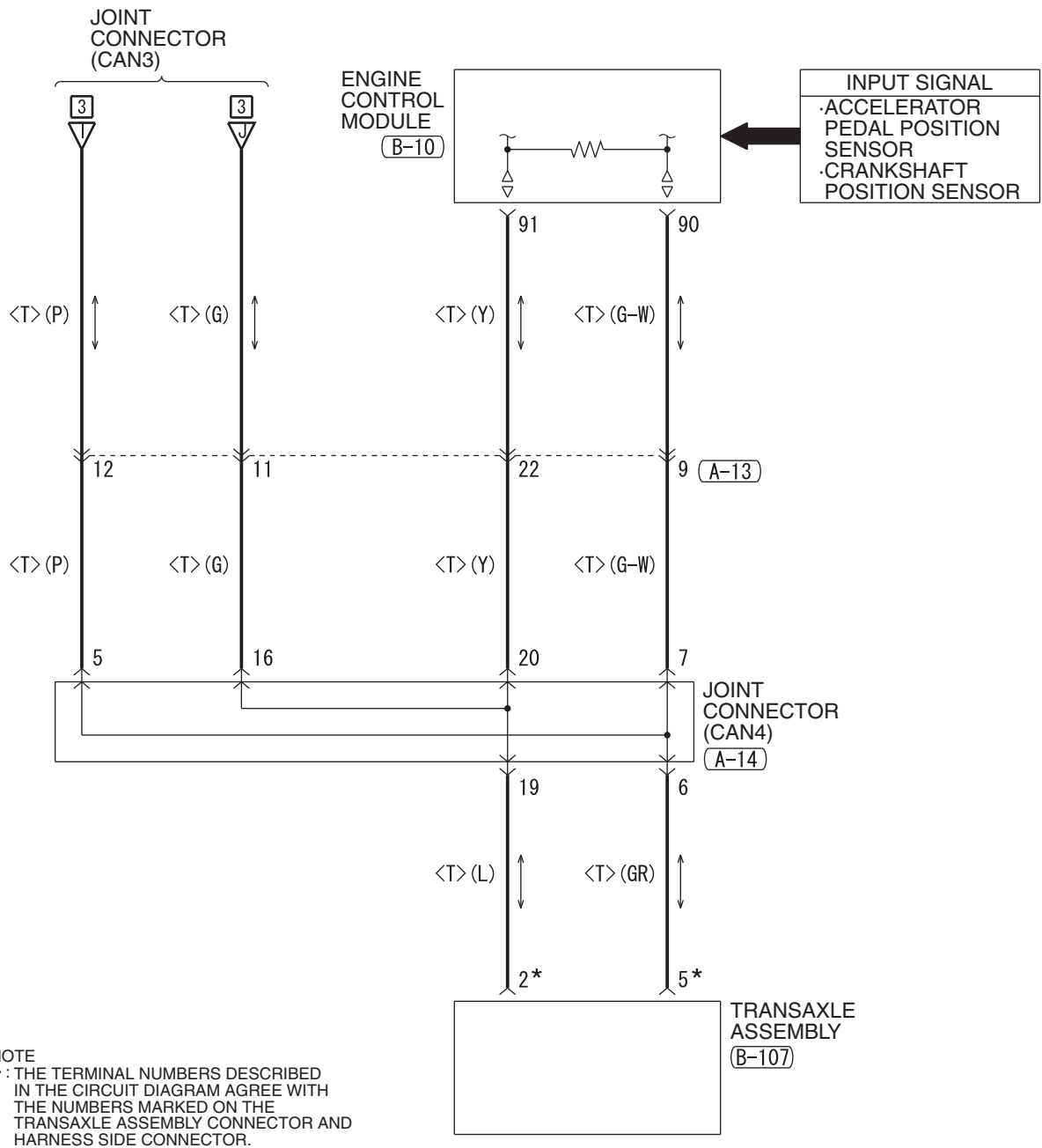

NOTE  
\*: THE TERMINAL NUMBERS DESCRIBED IN THE CIRCUIT DIAGRAM AGREE WITH THE NUMBERS MARKED ON THE TRANSAXLE ASSEMBLY CONNECTOR AND HARNESS SIDE CONNECTOR.

(A-13)

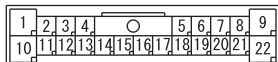

(A-14)

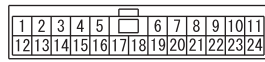

(B-10)

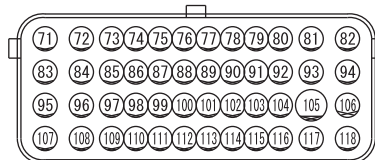

(B-107)\*



NOTES

# SUPPLEMENTAL RESTRAINT SYSTEM (SRS)

M1901009702970

1

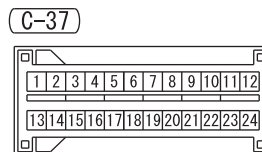
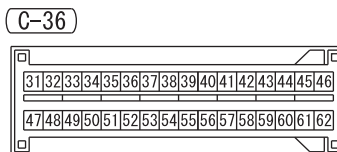
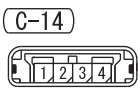
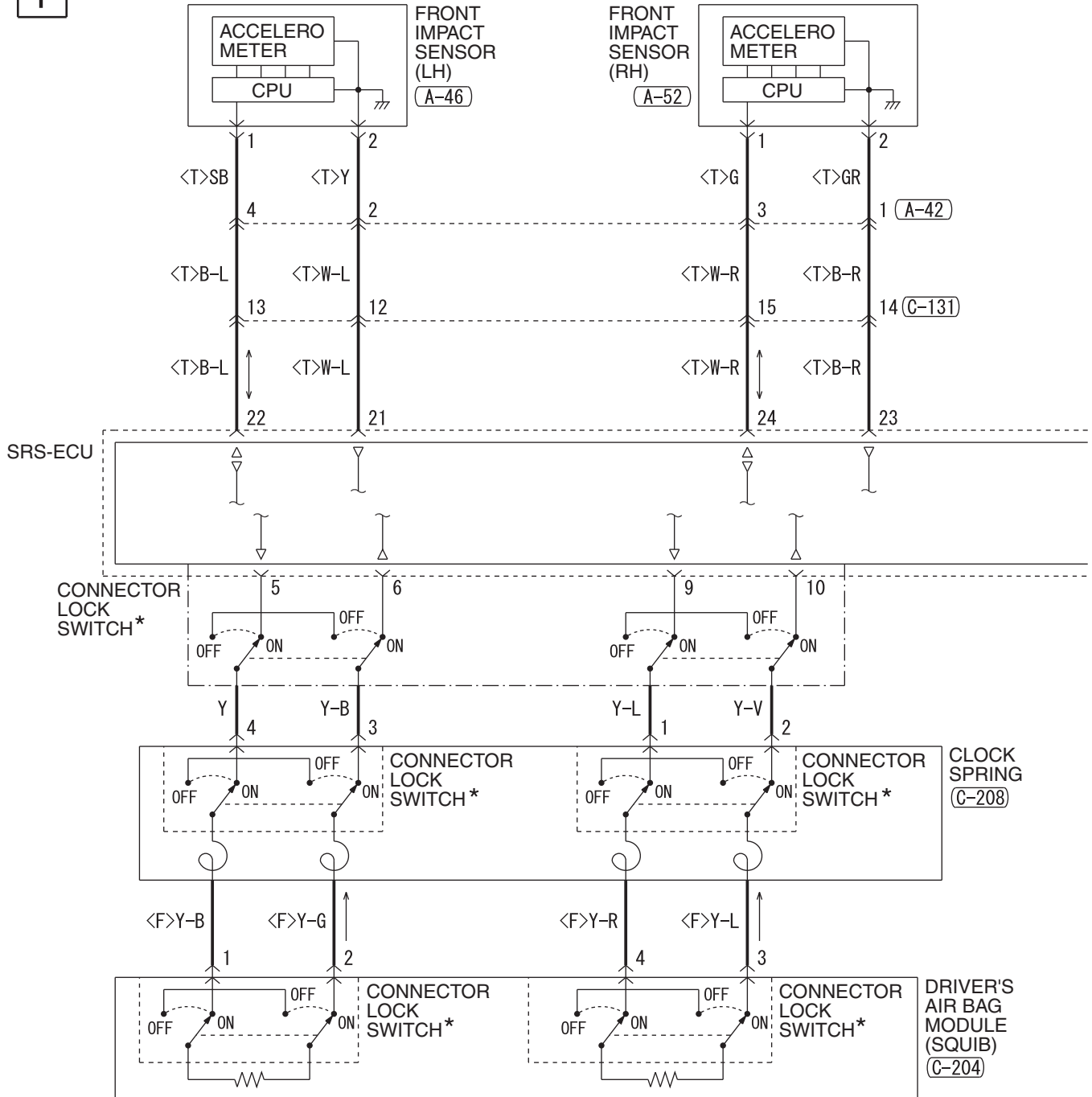

**2**

NOTE  
\* : CONNECTOR COUPLED: ON  
CONNECTOR UNCOUPLED: OFF

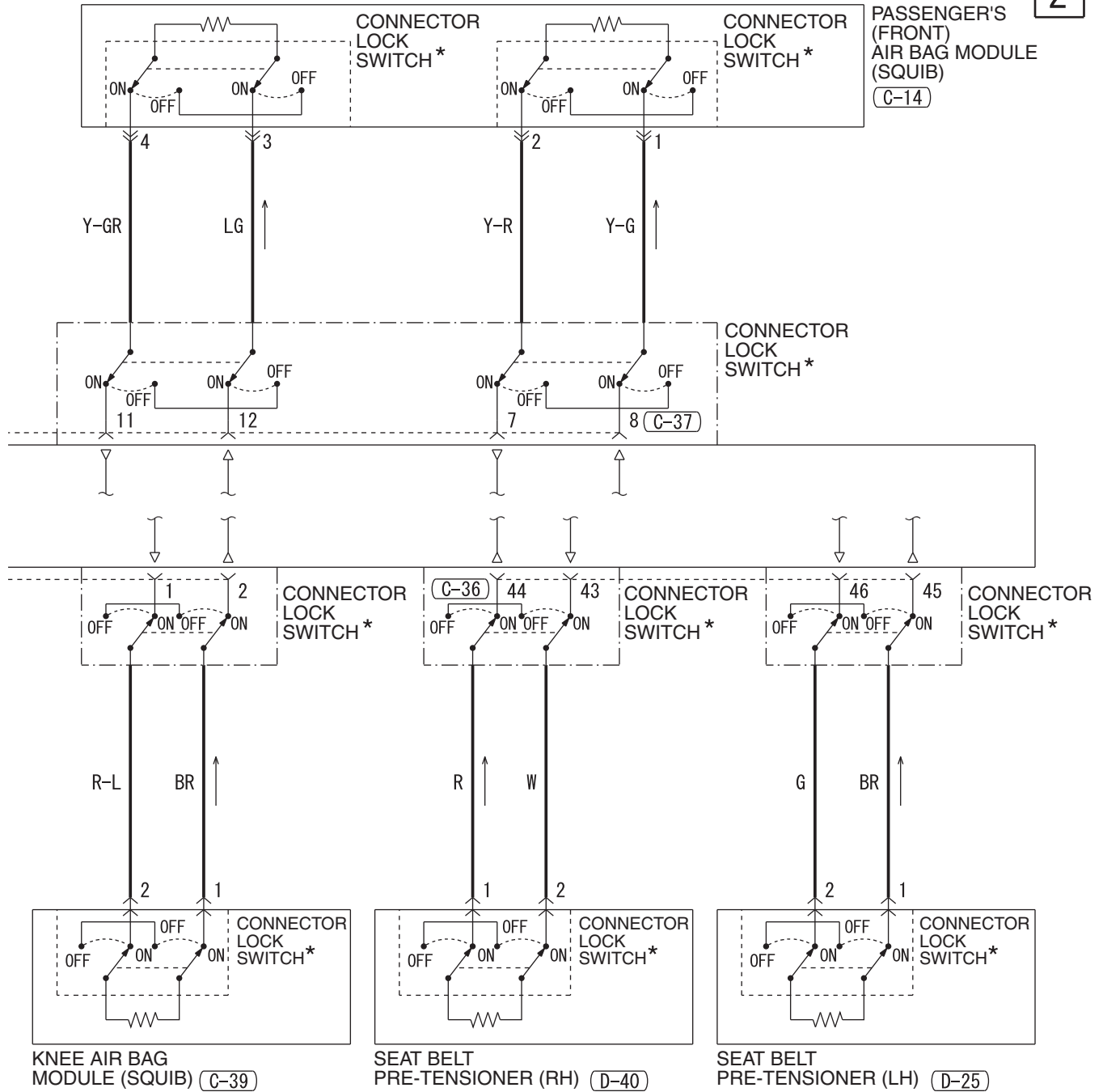

(C-131)      (C-204)      (C-208)      (D-25)      (D-40)

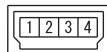
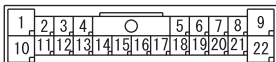

**WIRE COLOR CODE**  
 B : BLACK    LG : LIGHT GREEN    G : GREEN    L : BLUE    W : WHITE    Y : YELLOW    SB : SKY BLUE  
 BR : BROWN    O : ORANGE    GR : GRAY    R : RED    P : PINK    V : VIOLET    PU : PURPLE    SI : SILVER

HAH15M21AB

SUPPLEMENTAL RESTRAINT SYSTEM (SRS) (CONTINUED)

3

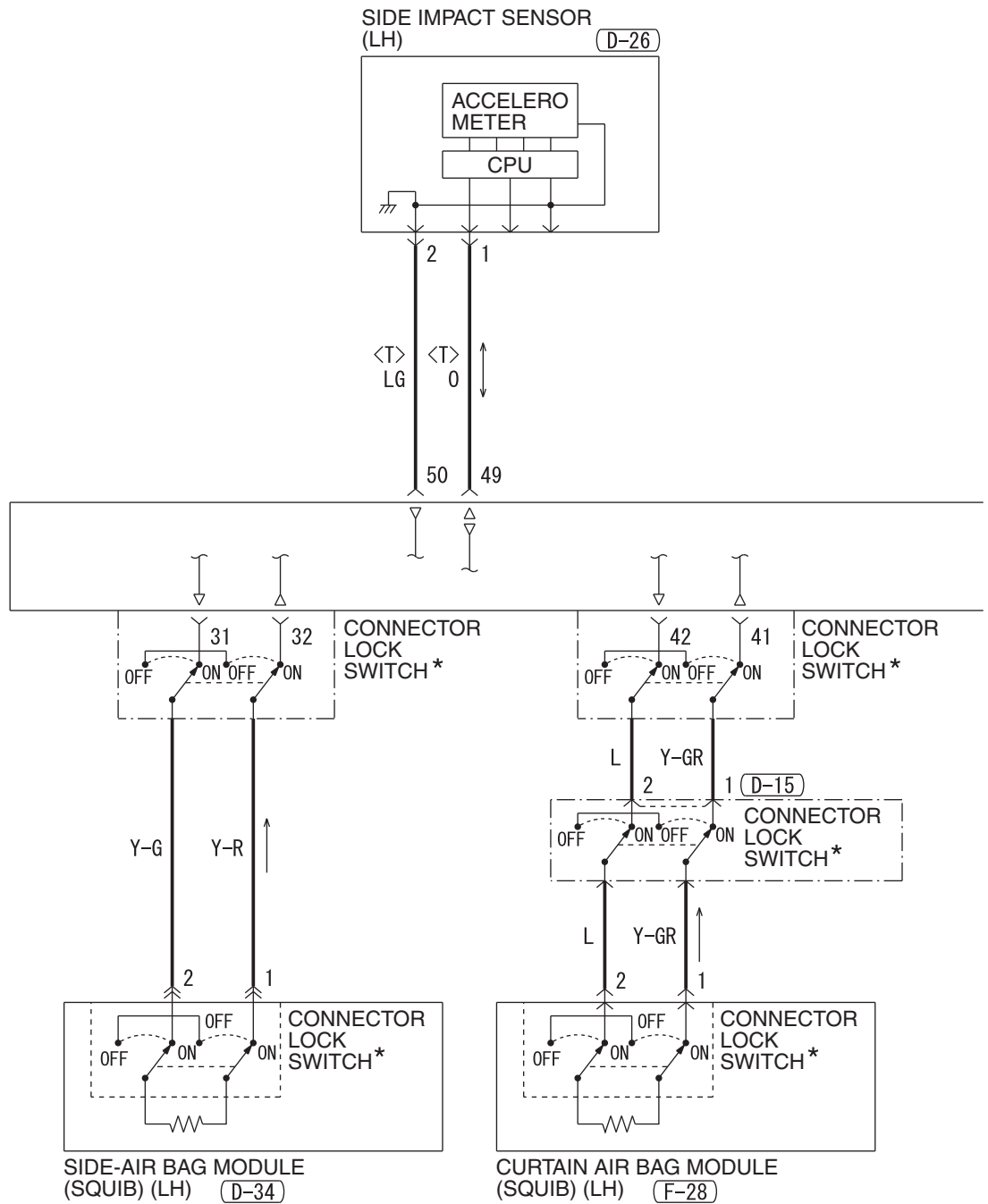

C-36

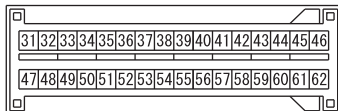

D-10



D-15



D-26

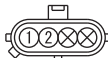

D-34



D-36



D-41

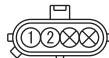

F-04



F-28



4

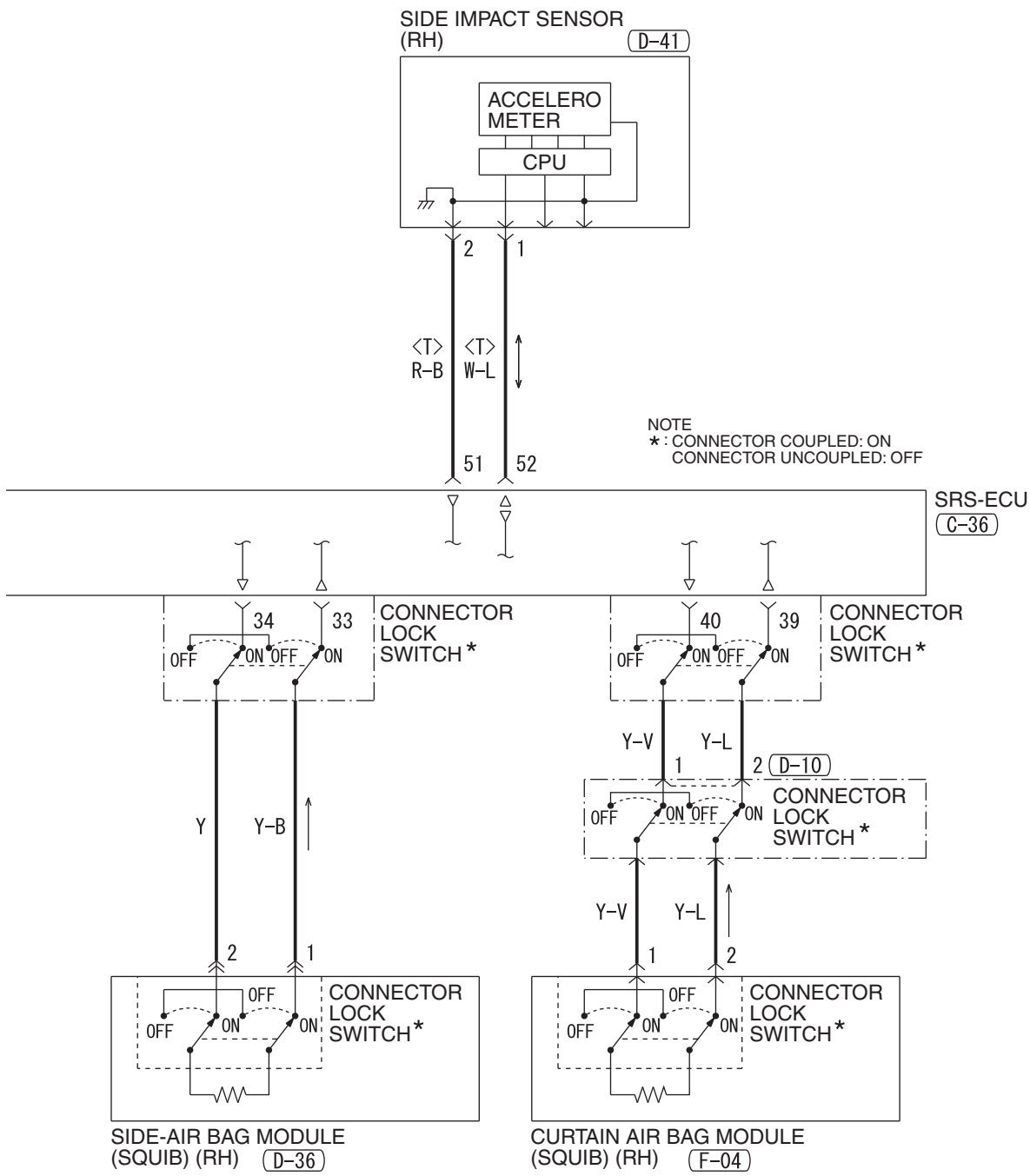

WIRE COLOR CODE  
B: BLACK LG: LIGHT GREEN G: GREEN L: BLUE W: WHITE Y: YELLOW SB: SKY BLUE  
BR: BROWN O: ORANGE GR: GRAY R: RED P: PINK V: VIOLET PU: PURPLE SI: SILVER

HAH15M21BB

SUPPLEMENTAL RESTRAINT SYSTEM (SRS) (CONTINUED)

5

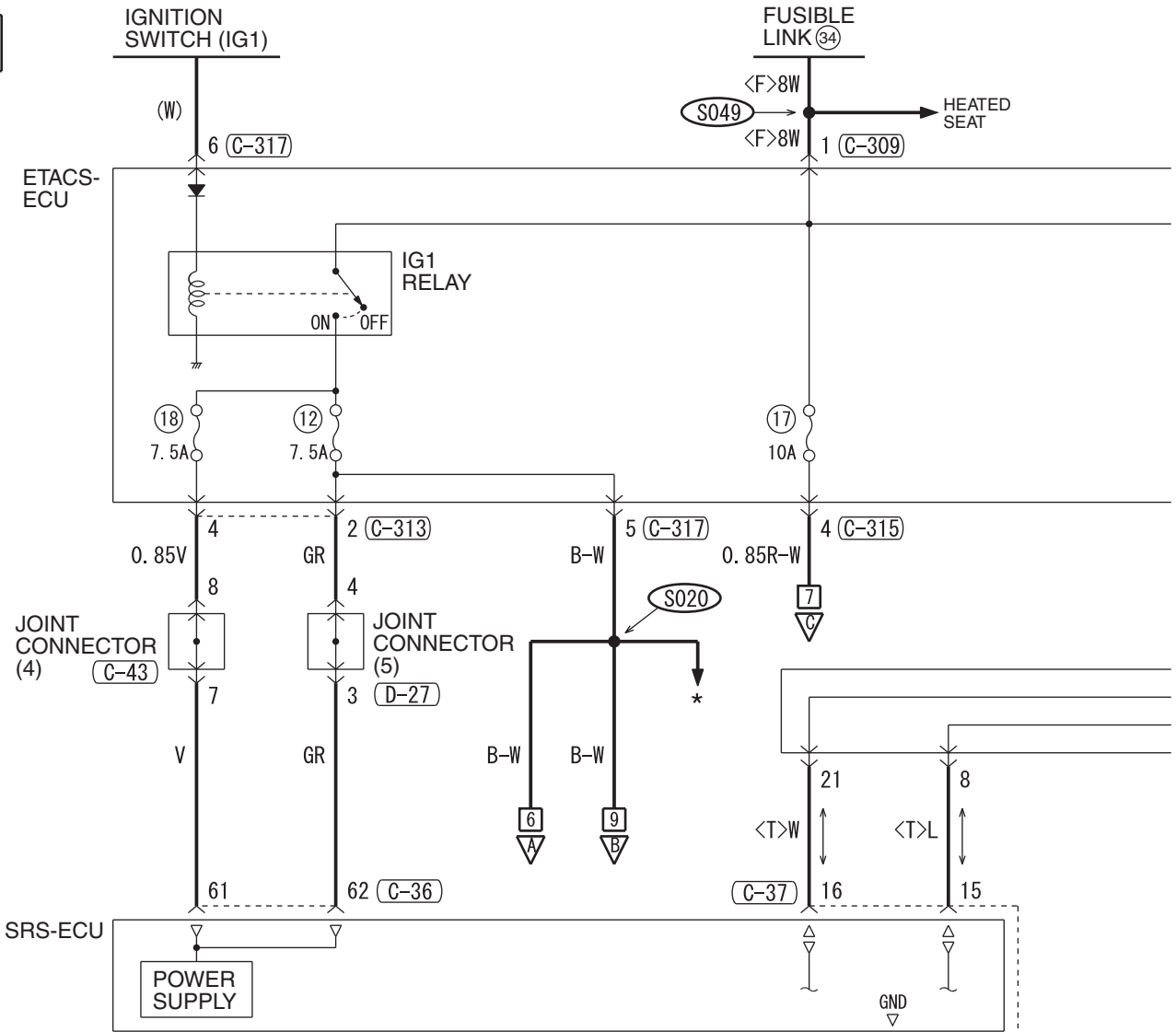

NOTE

- \* : .ABS, ASC, ACD, AYC AND S-AWC
- .AIR CONDITIONING SYSTEM
- .CENTRAL DOOR LOCKING SYSTEM
- .DAYTIME RUNNING LIGHT (DRL)
- .DOME LIGHT, LUGGAGE COMPARTMENT LIGHT AND IGNITION KEY HOLE ILLUMINATION LIGHT
- .FOG LIGHT
- .HEADLIGHT
- .HEATED DOOR MIRROR
- .HEATED SEAT
- .HEATER <VEHICLES WITHOUT AIR CONDITIONING SYSTEM>
- .IGNITION KEY REMINDER TONE ALARM <VEHICLES WITH KOS>
- .IMMOBILIZER SYSTEM
- .KEYLESS OPERATING SYSTEM (KOS)
- .REAR WINDOW DEFOGGER
- .SHIFT LOCK MECHANISM
- .SUNROOF
- .TAILLIGHT, POSITION LIGHT, REAR SIDE MARKER LIGHT, LICENSE PLATE LIGHT AND LIGHTING MONITOR TONE ALARM
- .THEFT-ALARM SYSTEM
- .TIRE PRESSURE MONITORING SYSTEM (TPMS)
- .TRUNK LID OPENER
- .TURN-SIGNAL LIGHT AND HAZARD WARNING LIGHT
- .TWIN CLUTCH-SPORTRONIC SHIFT TRANSMISSION (TC-SST)
- .WINDSHIELD WIPER AND WASHER

C-04

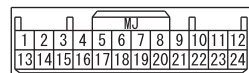

C-36

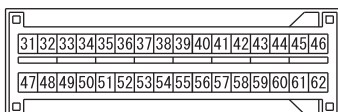

C-37

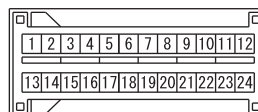

C-40 FRONT SIDE



C-315

MU801890

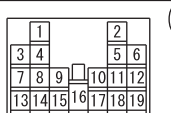

C-317

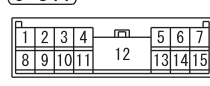

D-27

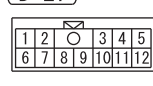



6

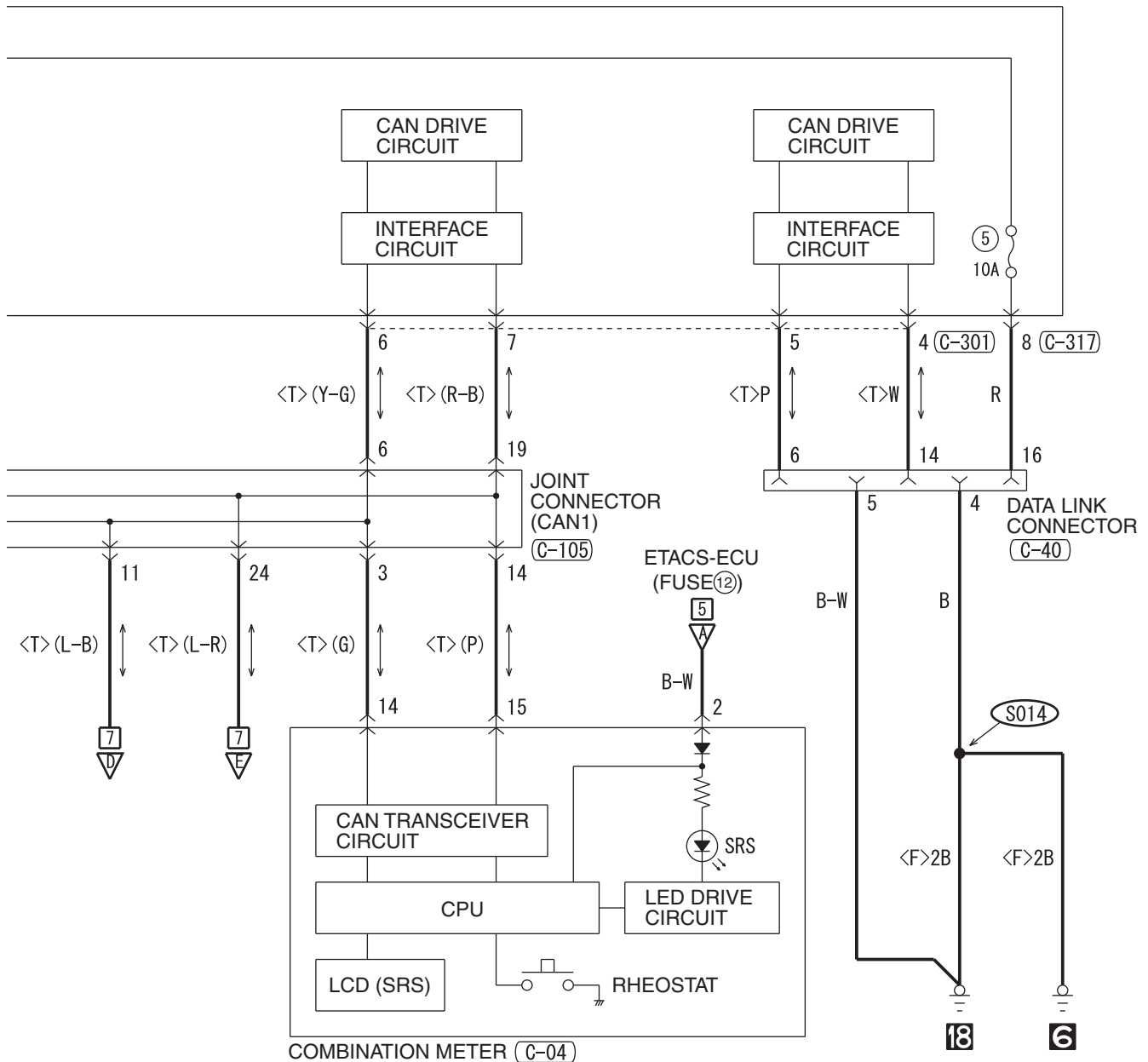

(C-43)

(C-105)

(C-301)

(C-309)

(C-313)

1	2	3	4	5	6	7	8	9	10	11		
12	13	14	15	16	17	18	19	20	21	22	23	24

1	2	3	4	5	6	7	8	9	10	11		
12	13	14	15	16	17	18	19	20	21	22	23	24

1	2	3	4	5	6	7	8	9	10	11		
12	13	14	15	16	17	18	19	20	21	22	23	24

1	2
---	---

1	2	3	4	5	6	7		
8	9	10	11	12	13	14	15	16

WIRE COLOR CODE  
B: BLACK LG: LIGHT GREEN G: GREEN L: BLUE W: WHITE Y: YELLOW SB: SKY BLUE  
BR: BROWN O: ORANGE GR: GRAY R: RED P: PINK V: VIOLET PU: PURPLE SI: SILVER

HAH15M21CB

TSB Revision

SUPPLEMENTAL RESTRAINT SYSTEM (SRS) (CONTINUED)

7

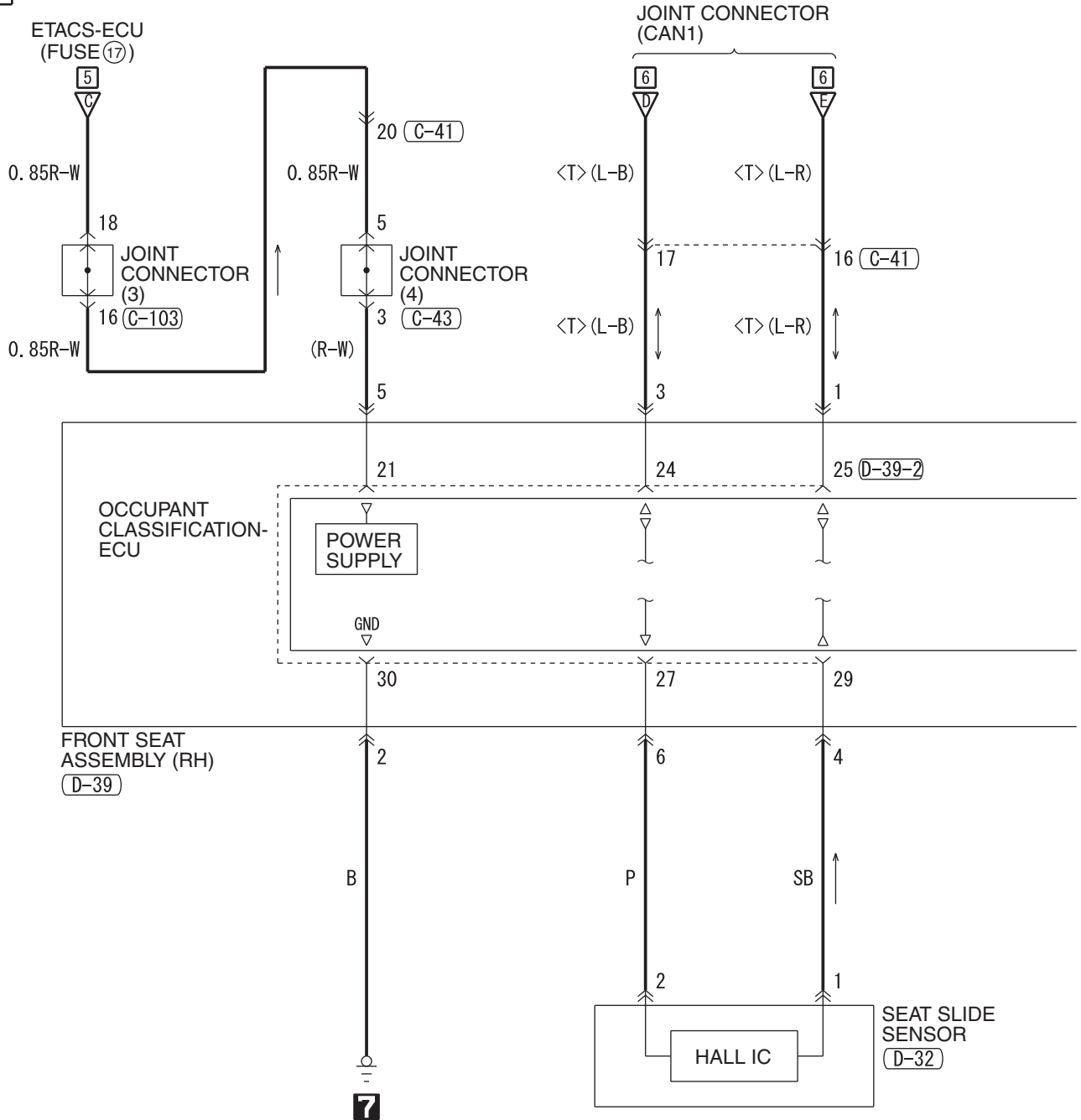

(C-41)

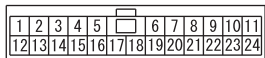

(C-43)

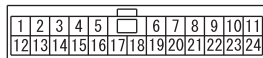

(C-103)

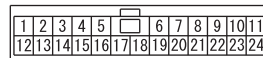

(D-32)



(D-39)



(D-39-1)

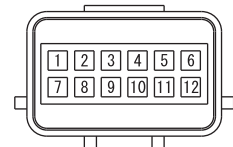

8

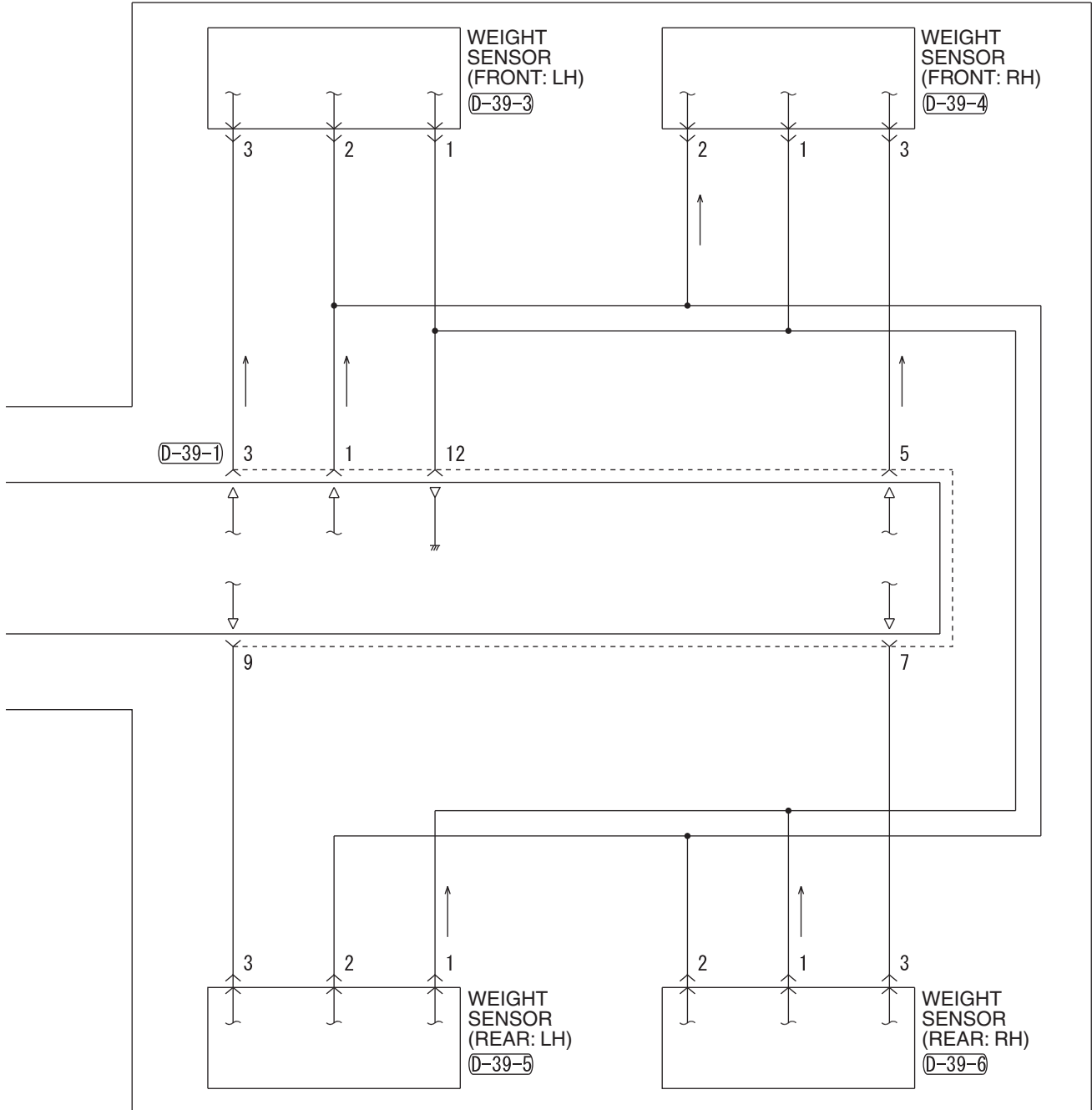

D-39-2

D-39-3

D-39-4

D-39-5

D-39-6

(1)(2)(3)

(1)(2)(3)

(1)(2)(3)

(1)(2)(3)

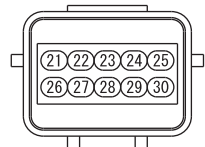

WIRE COLOR CODE  
 B: BLACK LG: LIGHT GREEN G: GREEN L: BLUE W: WHITE  
 Y: YELLOW SB: SKY BLUE BR: BROWN O: ORANGE GR: GRAY  
 R: RED P: PINK V: VIOLET PU: PURPLE SI: SILVER

HAH15M21DB

TSB Revision

SUPPLEMENTAL RESTRAINT SYSTEM (SRS) (CONTINUED)

9

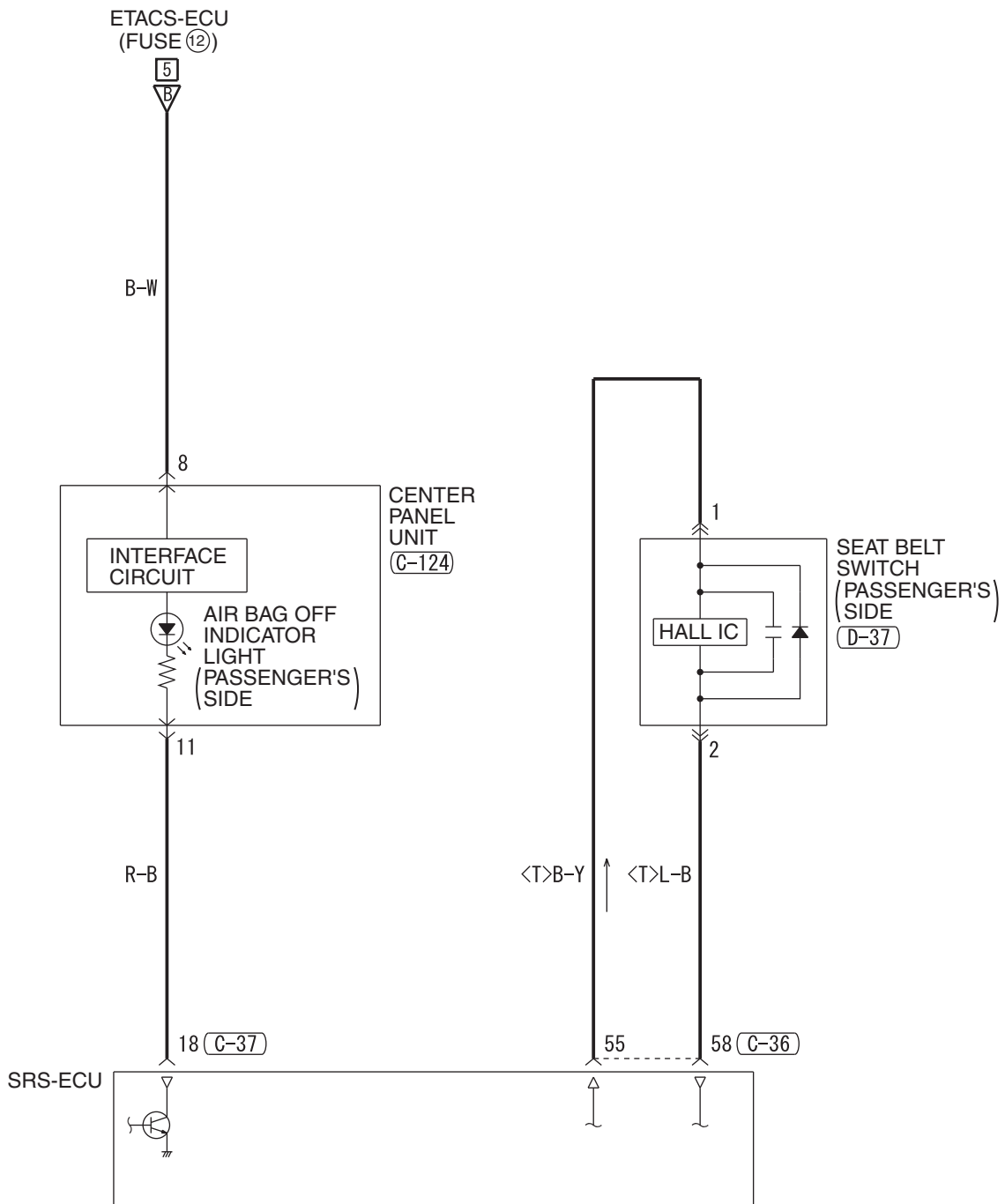

(C-36)

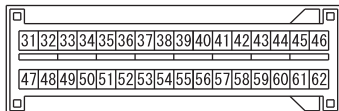

(C-37)

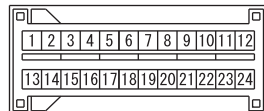

(C-124)

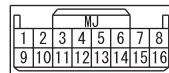

(D-37)



NOTES

# CRUISE CONTROL SYSTEM <M/T>

M1901032901003

1

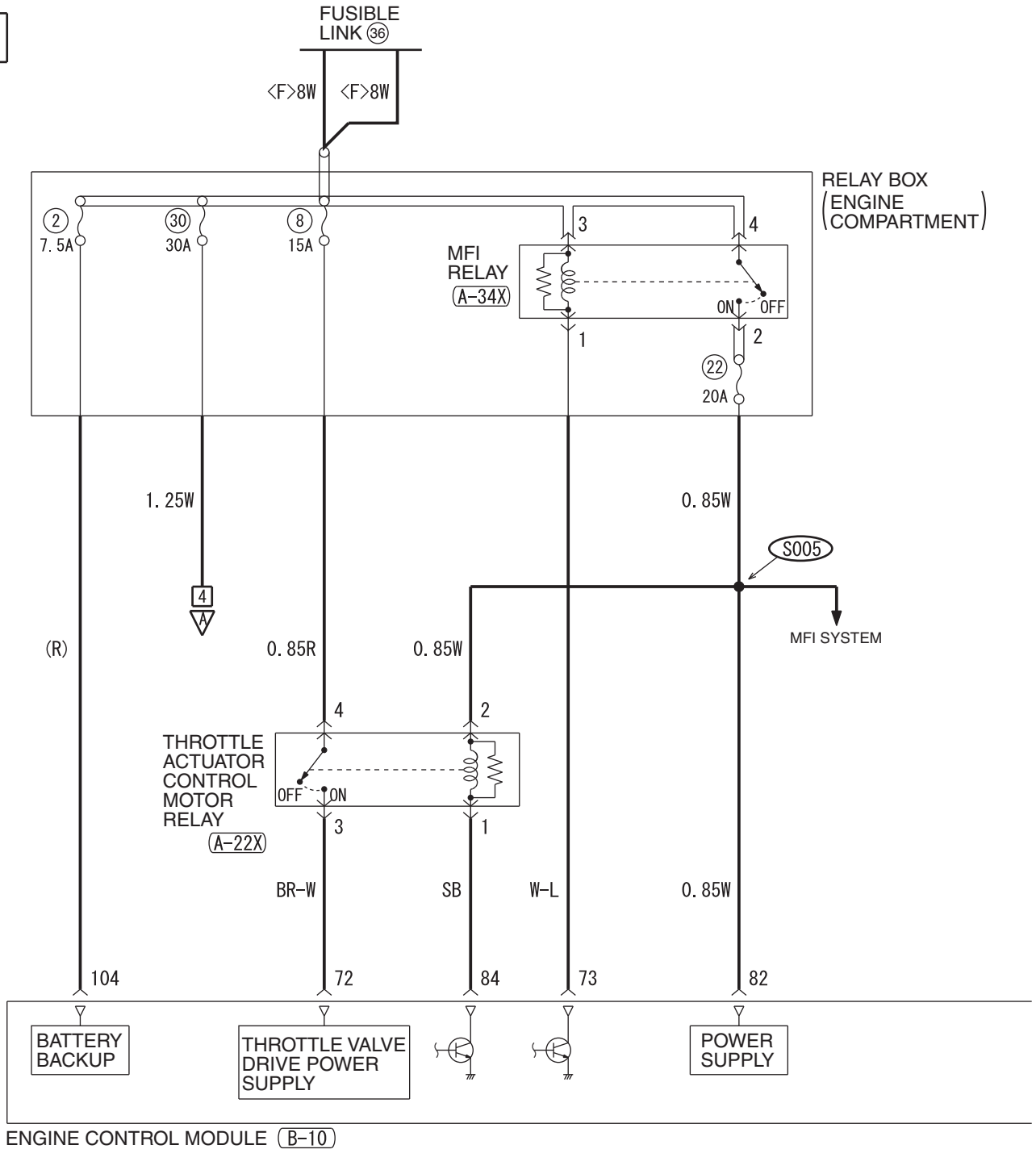

(A-22X)

(A-34X)

(B-10)

(C-48)

(C-49)

(C-304)

(C-309)

(C-312)

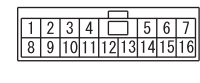
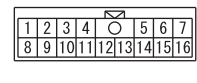
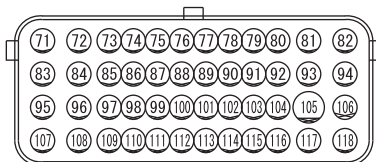

HAH15M22AA

2

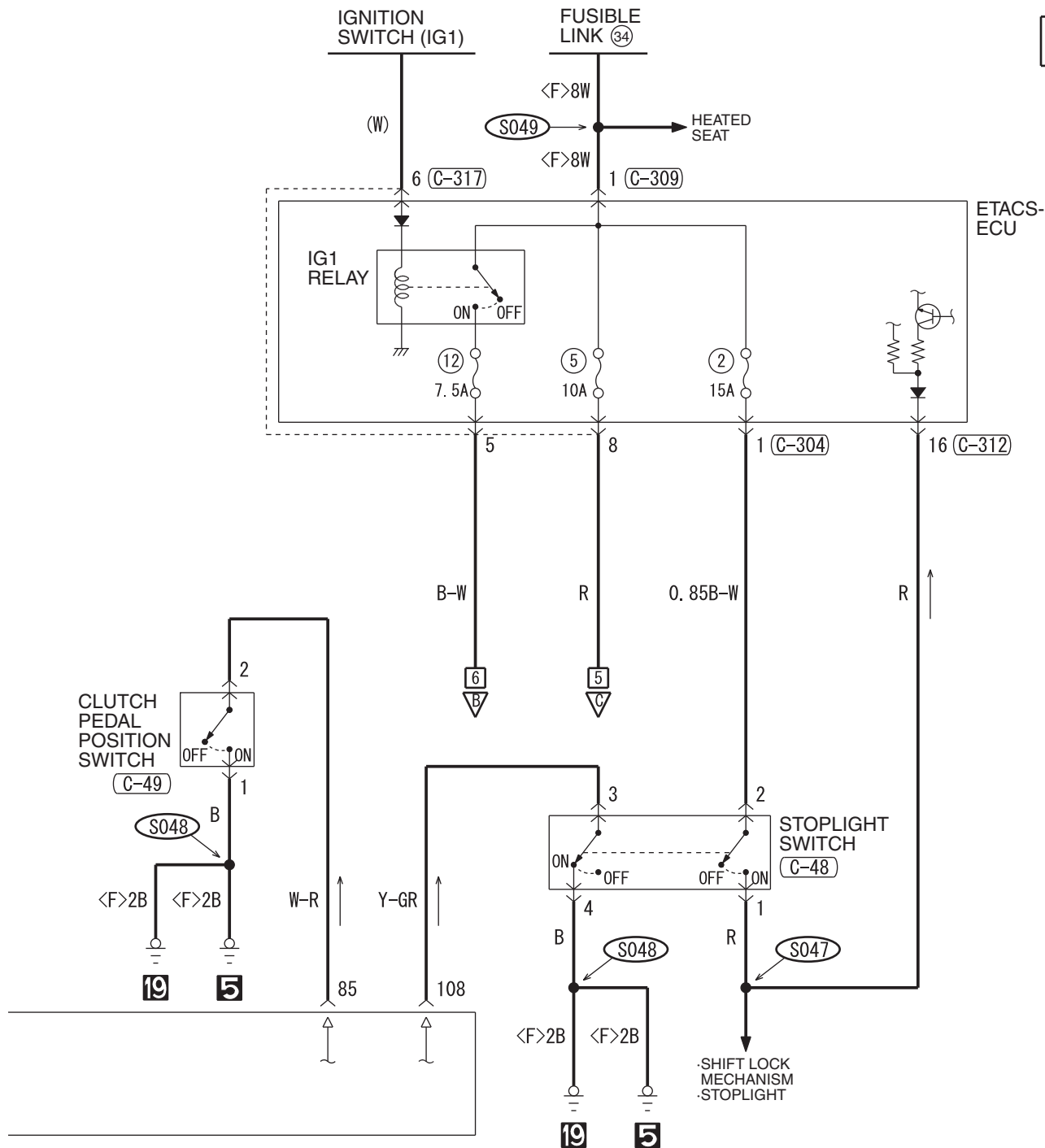

(C-317)

1	2	3	4	5	6	7	
8	9	10	11	12	13	14	15

WIRE COLOR CODE

B: BLACK LG: LIGHT GREEN G: GREEN L: BLUE W: WHITE Y: YELLOW SB: SKY BLUE  
BR: BROWN O: ORANGE GR: GRAY R: RED P: PINK V: VIOLET PU: PURPLE SI: SILVER

HAH15M22AB

TSB Revision

CRUISE CONTROL SYSTEM <M/T> (CONTINUED)

3

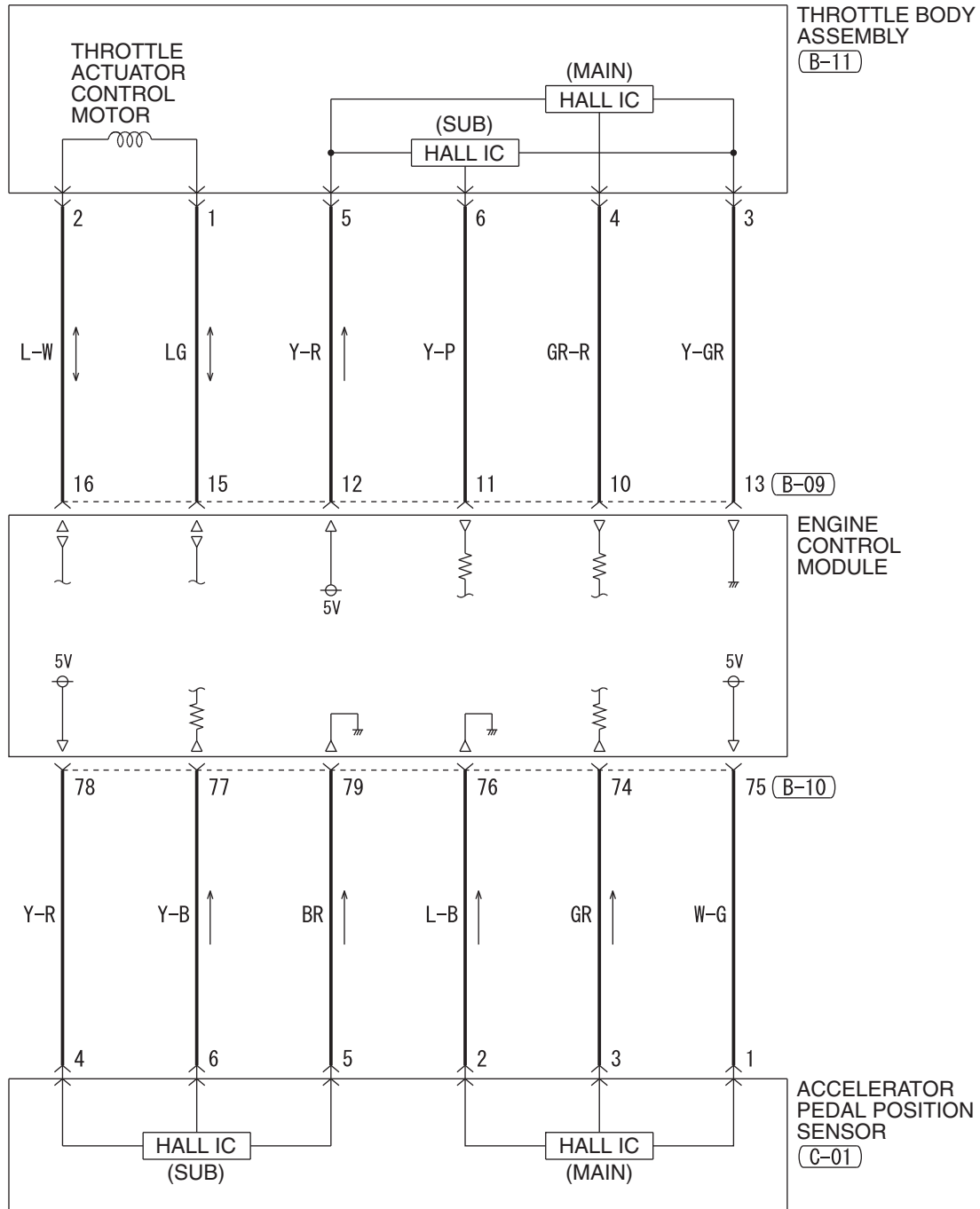

B-09

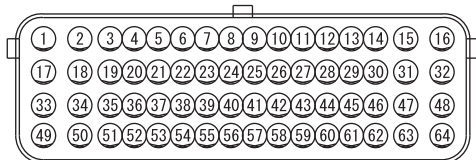

B-10

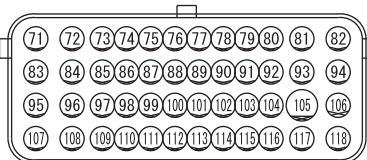

B-11



C-307



C-317

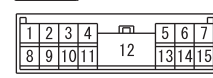



4

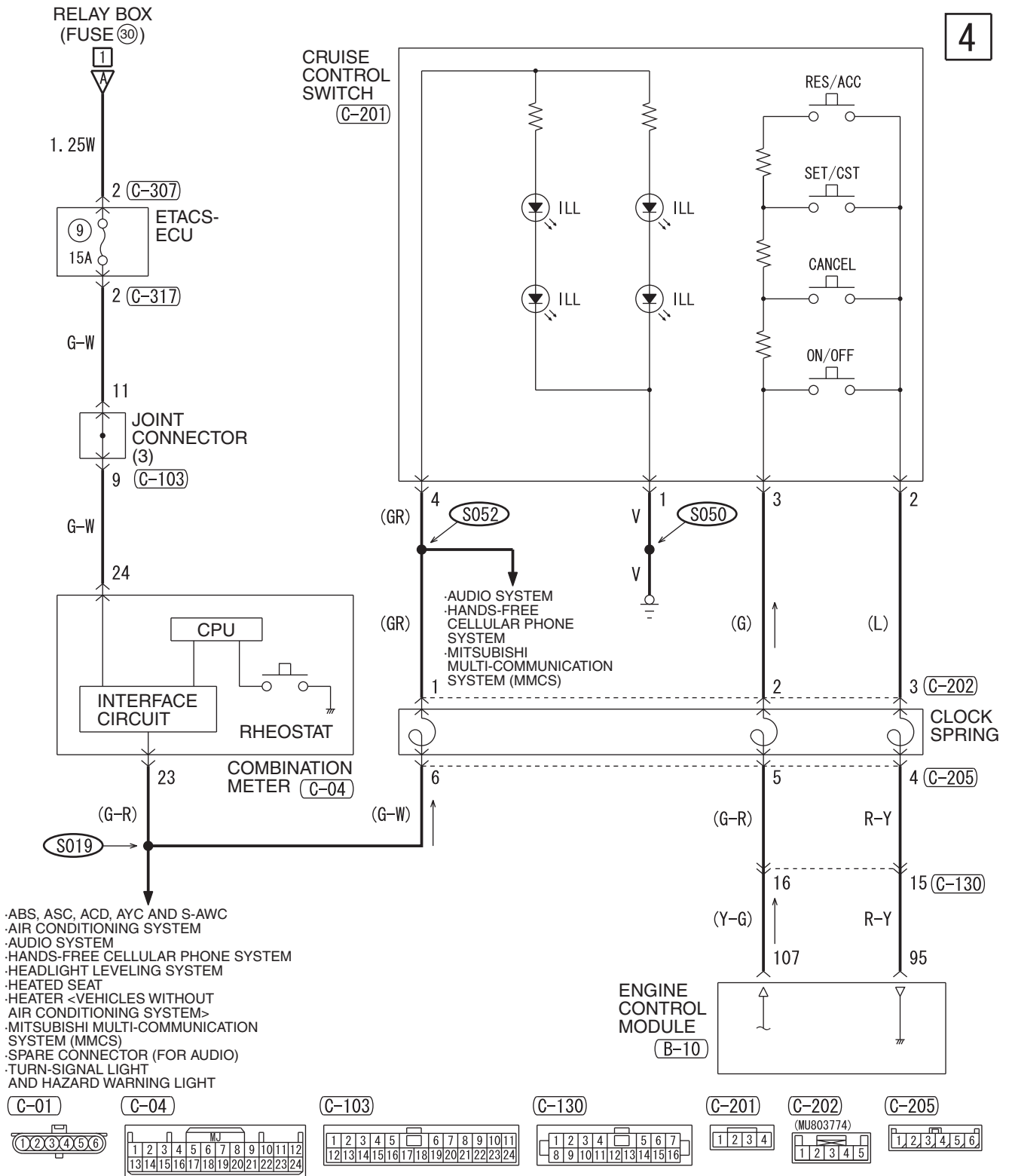

- ABS, ASC, ACD, AYC AND S-AWC
- AIR CONDITIONING SYSTEM
- AUDIO SYSTEM
- HANDS-FREE CELLULAR PHONE SYSTEM
- HEADLIGHT LEVELING SYSTEM
- HEATED SEAT
- HEATER <VEHICLES WITHOUT AIR CONDITIONING SYSTEM>
- MITSUBISHI MULTI-COMMUNICATION SYSTEM (MMCS)
- SPARE CONNECTOR (FOR AUDIO)
- TURN-SIGNAL LIGHT AND HAZARD WARNING LIGHT

WIRE COLOR CODE  
B: BLACK LG: LIGHT GREEN G: GREEN L: BLUE W: WHITE Y: YELLOW SB: SKY BLUE  
BR: BROWN O: ORANGE GR: GRAY R: RED P: PINK V: VIOLET PU: PURPLE SI: SILVER

HAH15M22BB

CRUISE CONTROL SYSTEM <M/T> (CONTINUED)

5

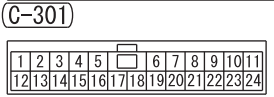
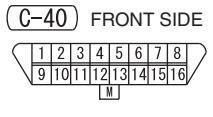
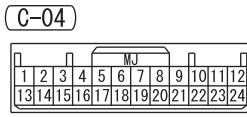
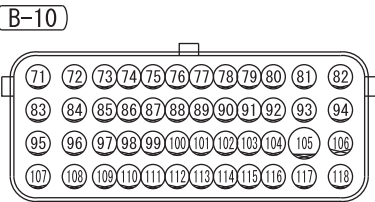
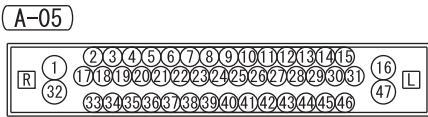
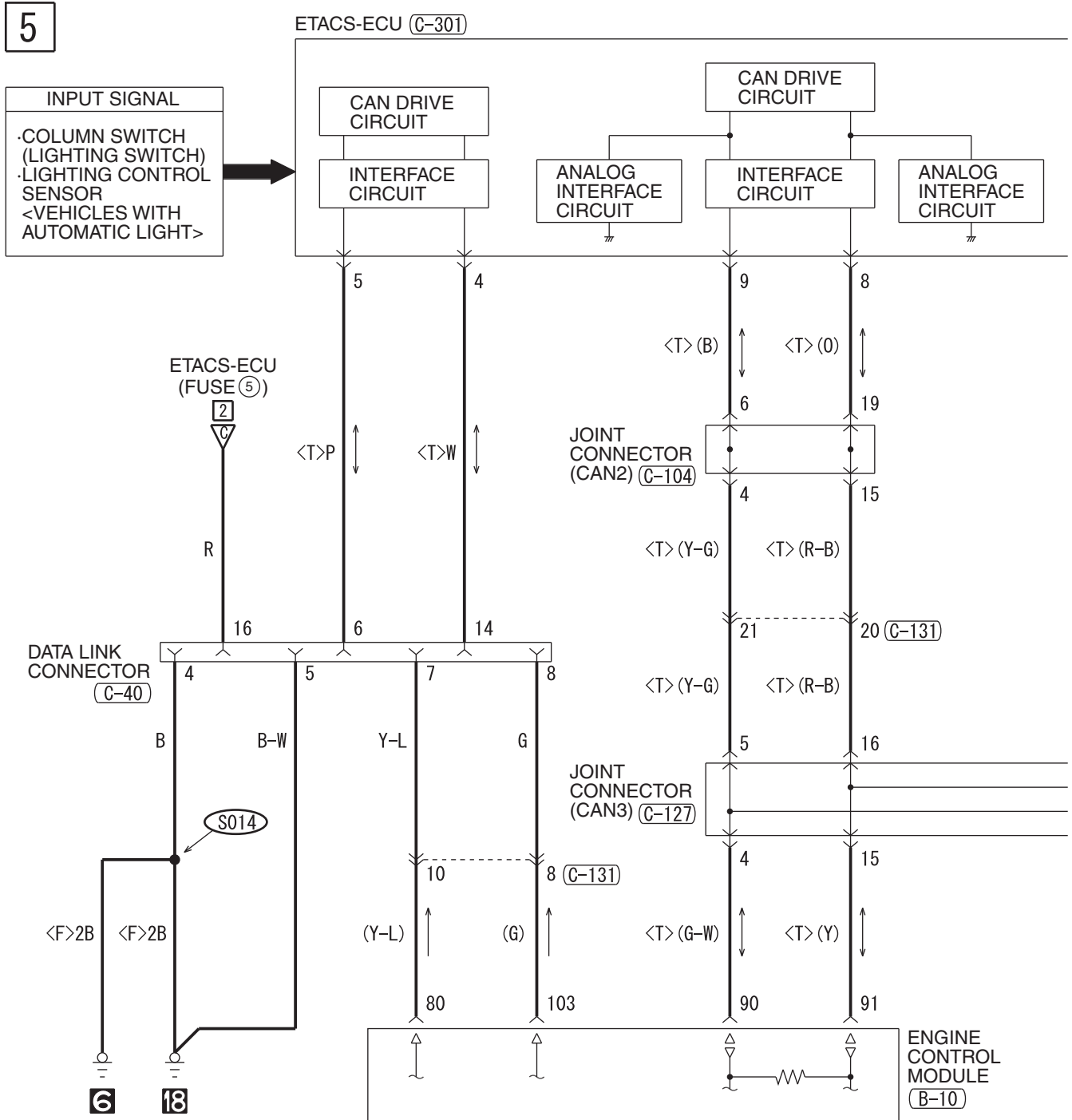

6

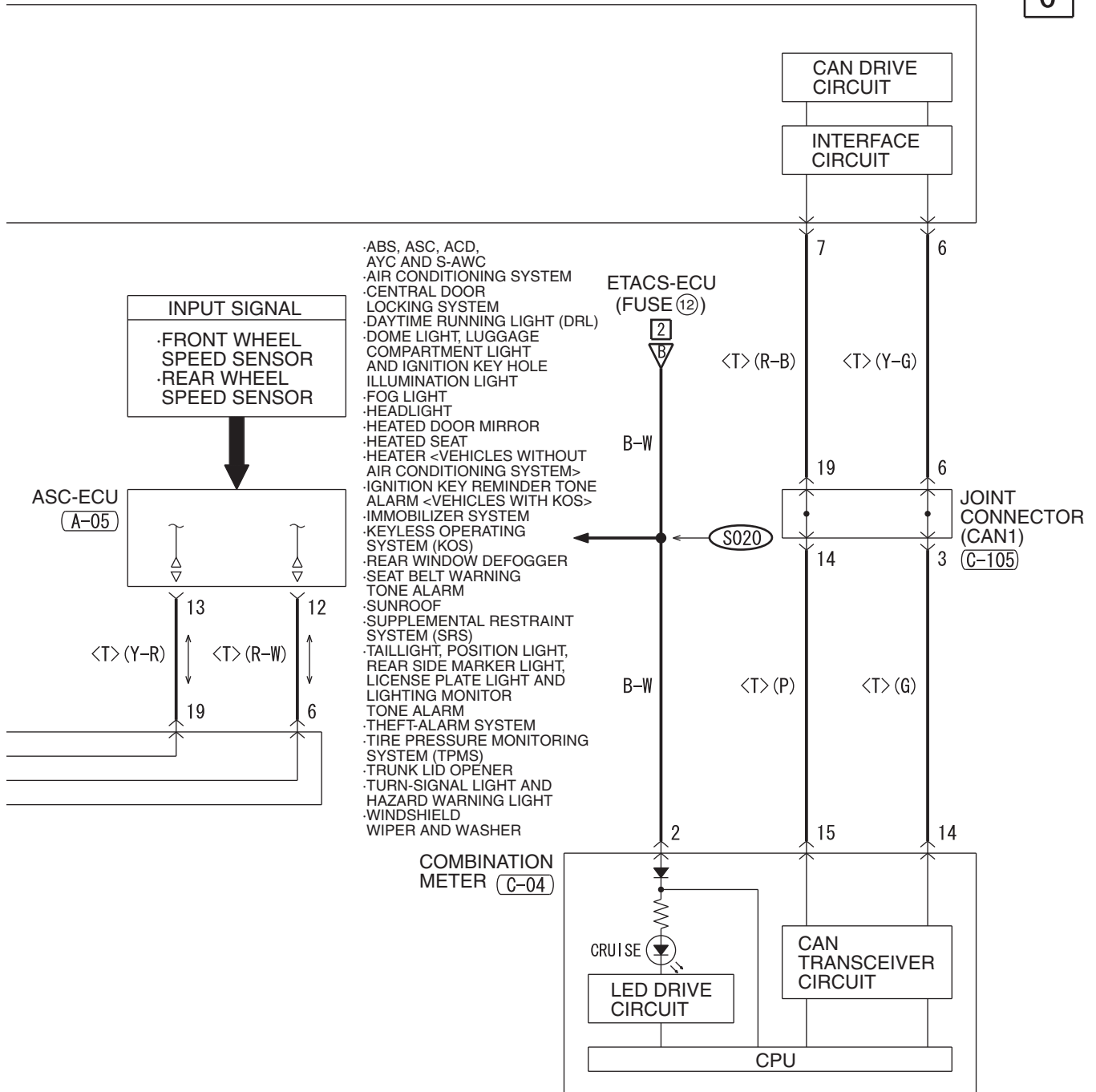

(C-104)

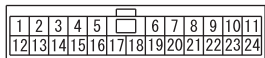

(C-105)

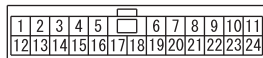

(C-127)

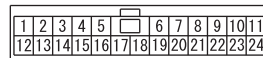

(C-131)

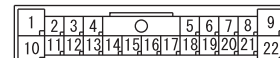

WIRE COLOR CODE

B: BLACK LG: LIGHT GREEN G: GREEN L: BLUE W: WHITE Y: YELLOW SB: SKY BLUE  
BR: BROWN O: ORANGE GR: GRAY R: RED P: PINK V: VIOLET PU: PURPLE SI: SILVER

# CRUISE CONTROL SYSTEM <TC-SST>

M1901032901014

1

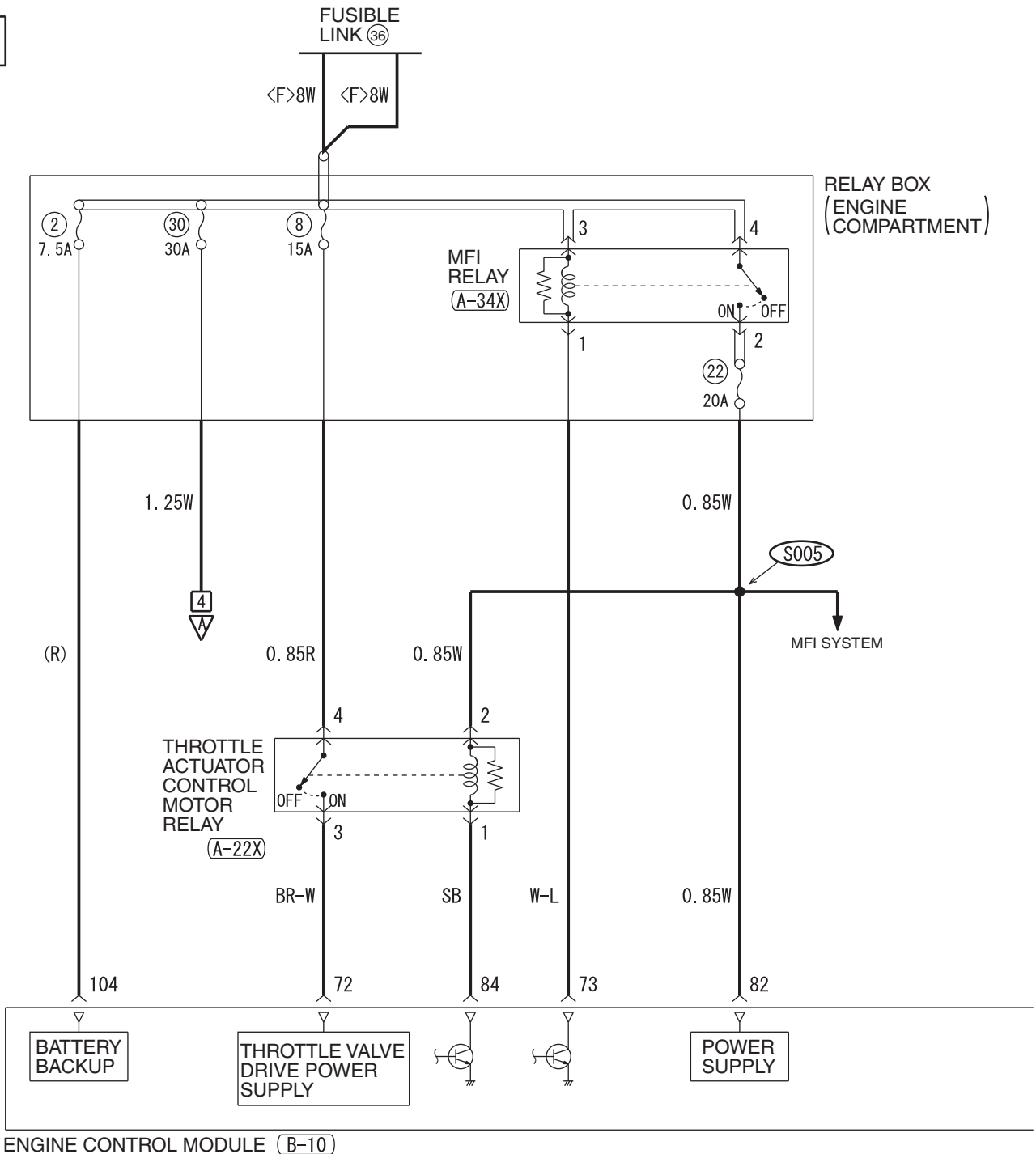

(A-22X) (A-34X) (B-10)

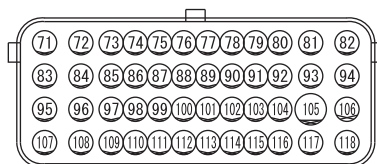

(C-48)



(C-304)

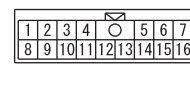

(C-309)



(C-312)

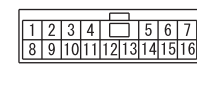

HAH15M23AA

TSB Revision

2

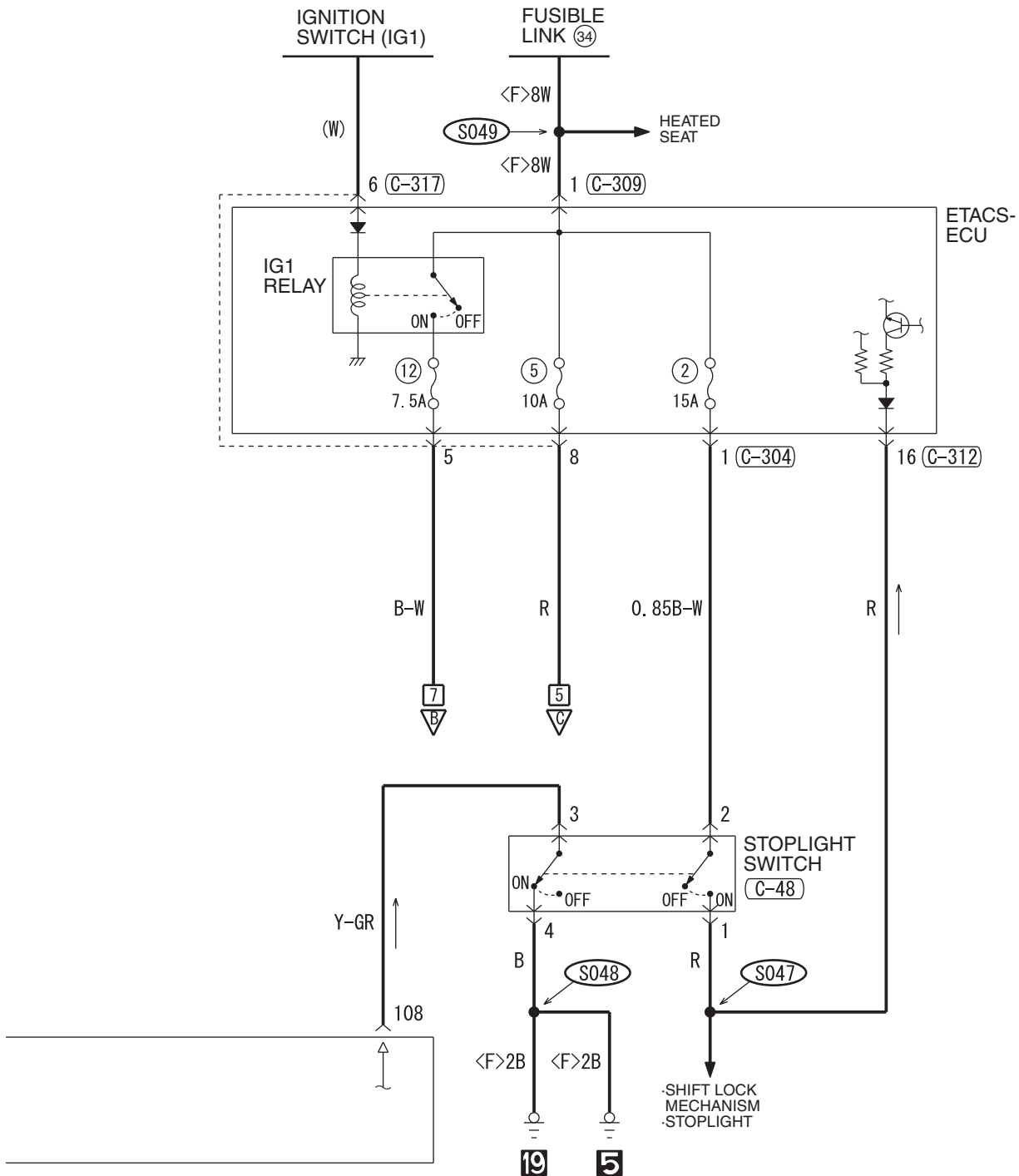

(C-317)

1	2	3	4	5	6	7	
8	9	10	11	12	13	14	15

WIRE COLOR CODE

B: BLACK LG: LIGHT GREEN G: GREEN L: BLUE W: WHITE Y: YELLOW SB: SKY BLUE  
BR: BROWN O: ORANGE GR: GRAY R: RED P: PINK V: VIOLET PU: PURPLE SI: SILVER

HAH15M23AB

TSB Revision

CRUISE CONTROL SYSTEM <TC-SST> (CONTINUED)

3

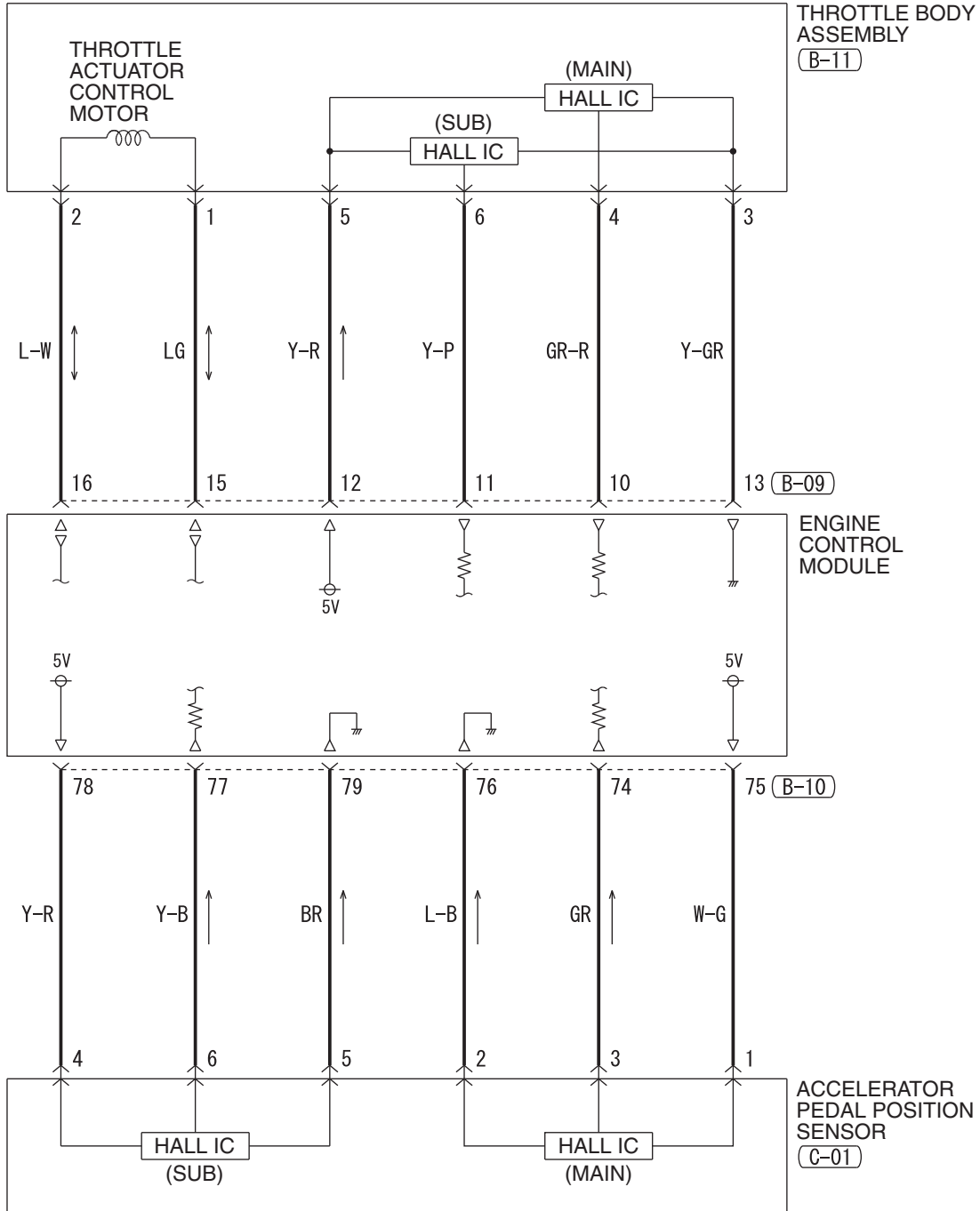

(B-09)

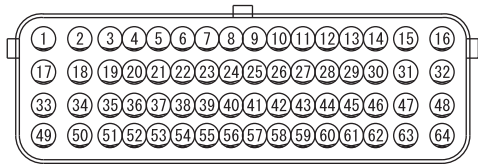

(B-10)

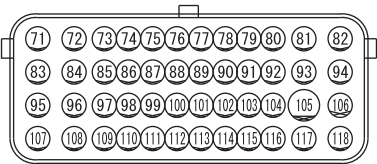

(B-11)

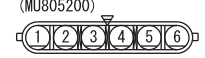

(C-307)



(C-317)

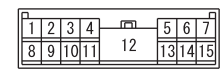

TSB Revision

4

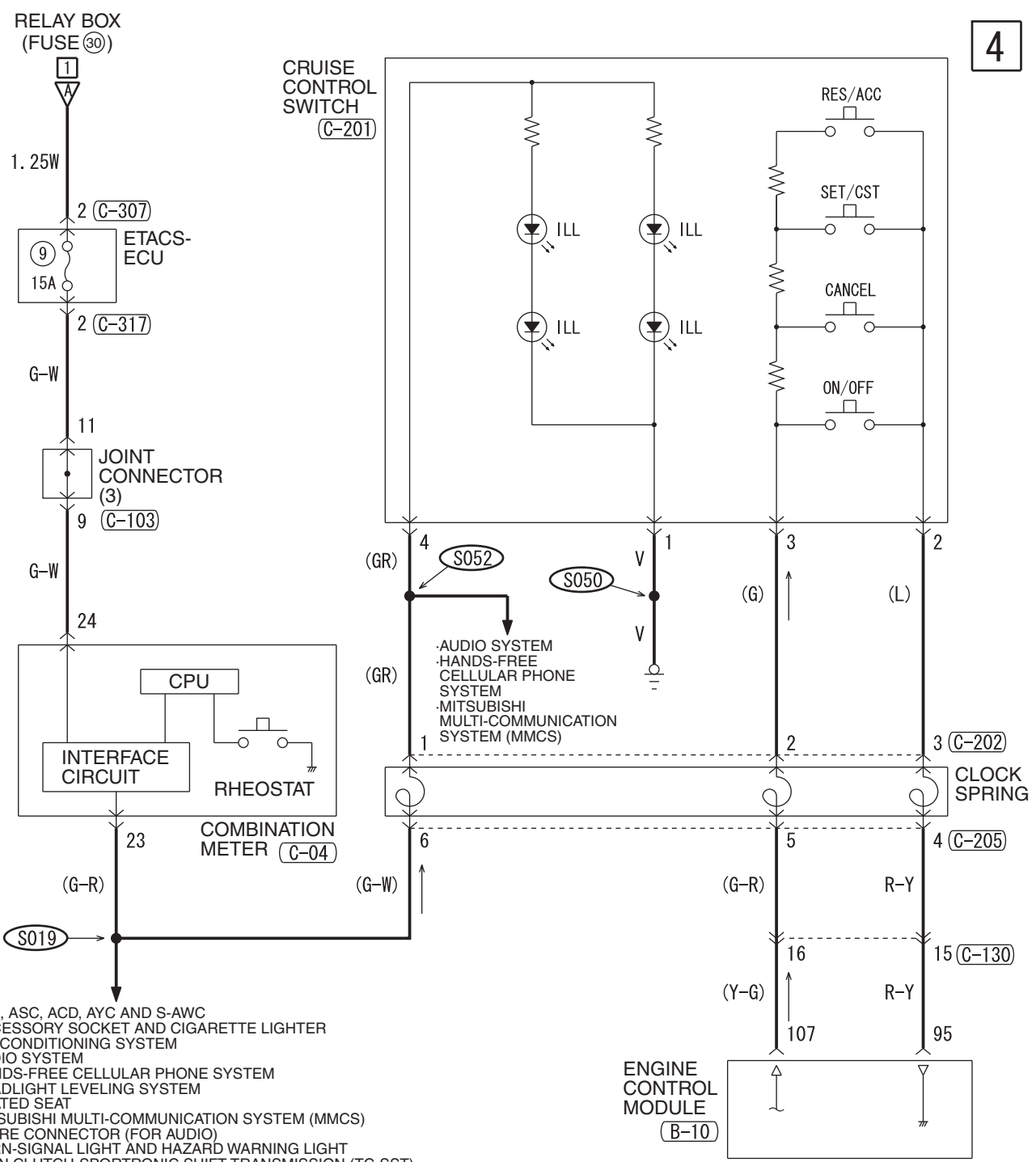

- ABS, ASC, ACD, AYC AND S-AWC
- ACCESSORY SOCKET AND CIGARETTE LIGHTER
- AIR CONDITIONING SYSTEM
- AUDIO SYSTEM
- HANDS-FREE CELLULAR PHONE SYSTEM
- HEADLIGHT LEVELING SYSTEM
- HEATED SEAT
- MITSUBISHI MULTI-COMMUNICATION SYSTEM (MMCS)
- SPARE CONNECTOR (FOR AUDIO)
- TURN-SIGNAL LIGHT AND HAZARD WARNING LIGHT
- TWIN CLUTCH-SPORTRONIC SHIFT TRANSMISSION (TC-SST)

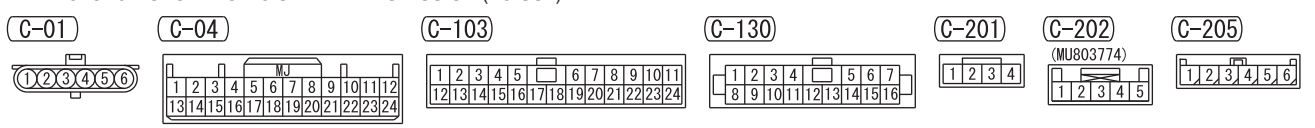

WIRE COLOR CODE  
 B: BLACK LG: LIGHT GREEN G: GREEN L: BLUE W: WHITE Y: YELLOW SB: SKY BLUE  
 BR: BROWN O: ORANGE GR: GRAY R: RED P: PINK V: VIOLET PU: PURPLE SI: SILVER

CRUISE CONTROL SYSTEM <TC-SST> (CONTINUED)

5

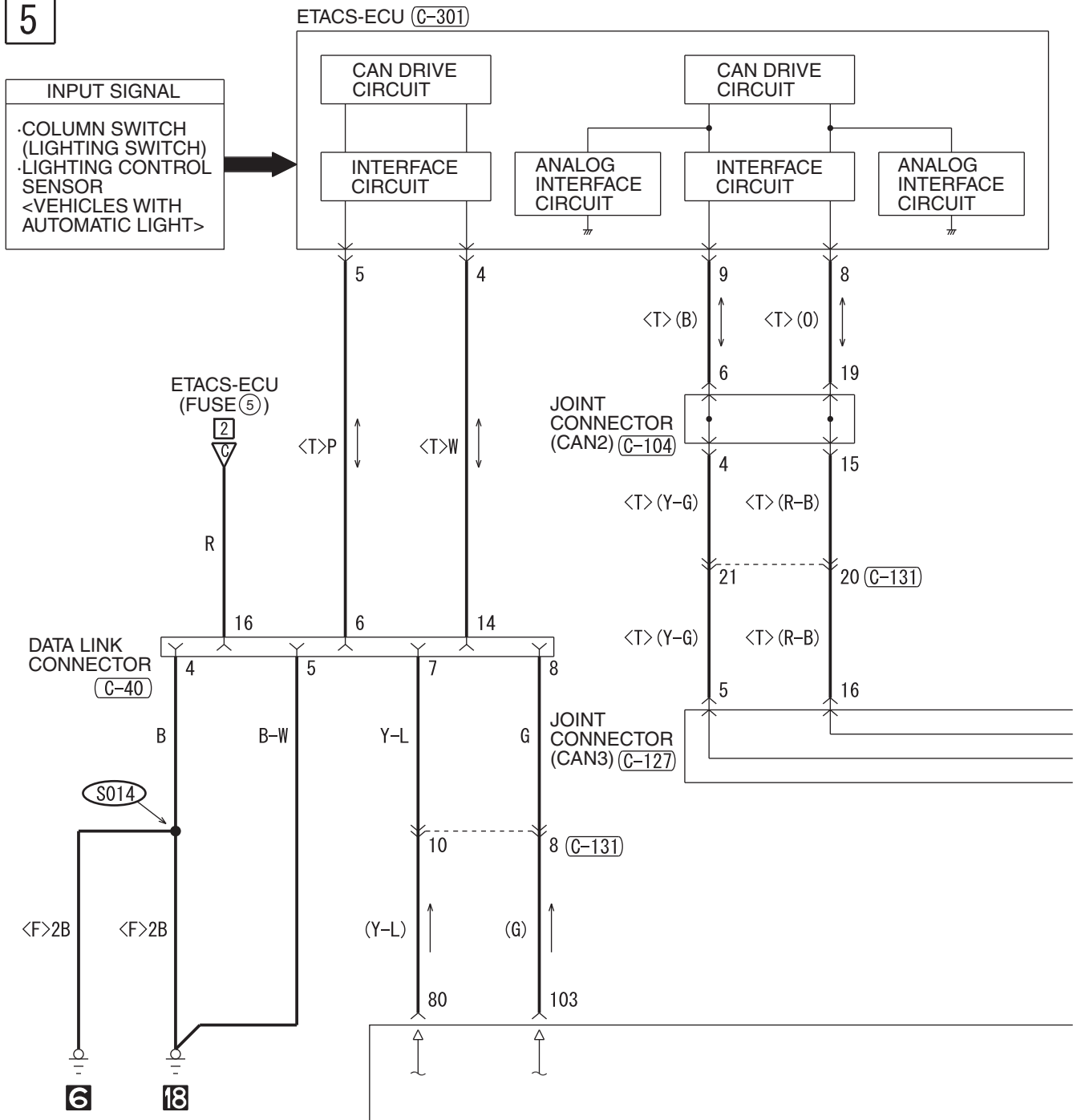

(A-05)

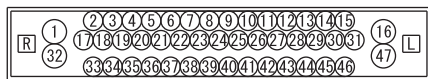

(A-13)

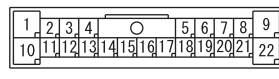

(A-14)

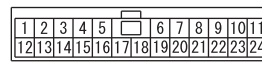

(C-127)

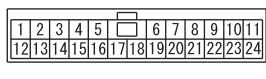

(C-131)

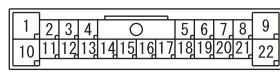

(C-301)

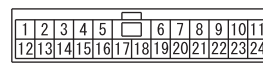



6

NOTE  
\* : THE TERMINAL NUMBERS DESCRIBED  
IN THE CIRCUIT DIAGRAM AGREE WITH  
THE NUMBERS MARKED ON THE  
TRANSAXLE ASSEMBLY CONNECTOR AND  
HARNESS SIDE CONNECTOR.

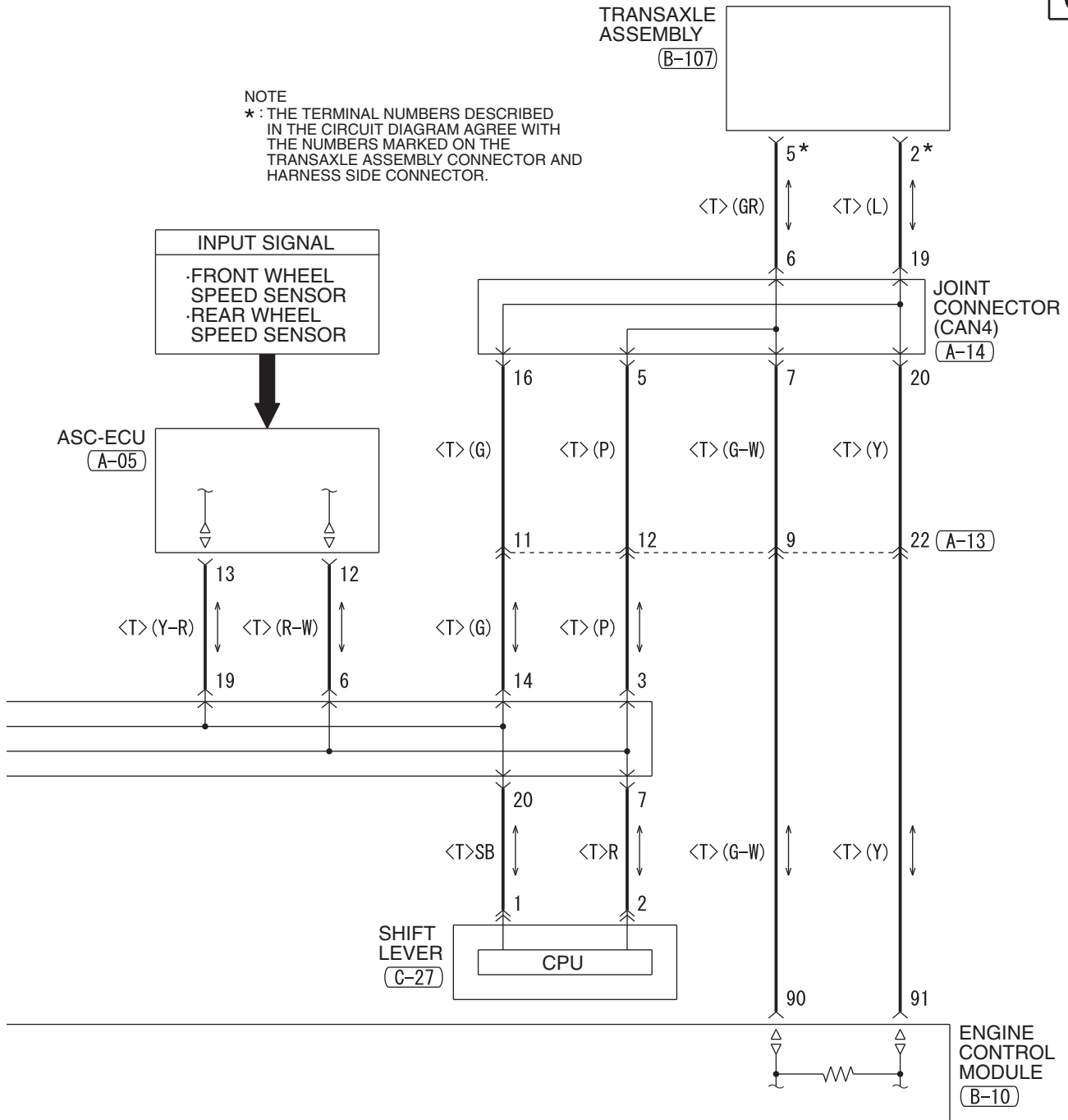

(B-10)

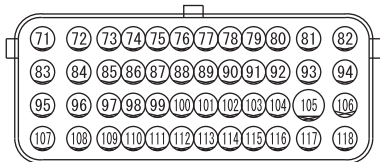

(B-107)\*



(C-27)

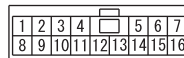

(C-40) FRONT SIDE



(C-104)

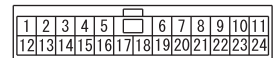

CRUISE CONTROL SYSTEM <TC-SST> (CONTINUED)

7

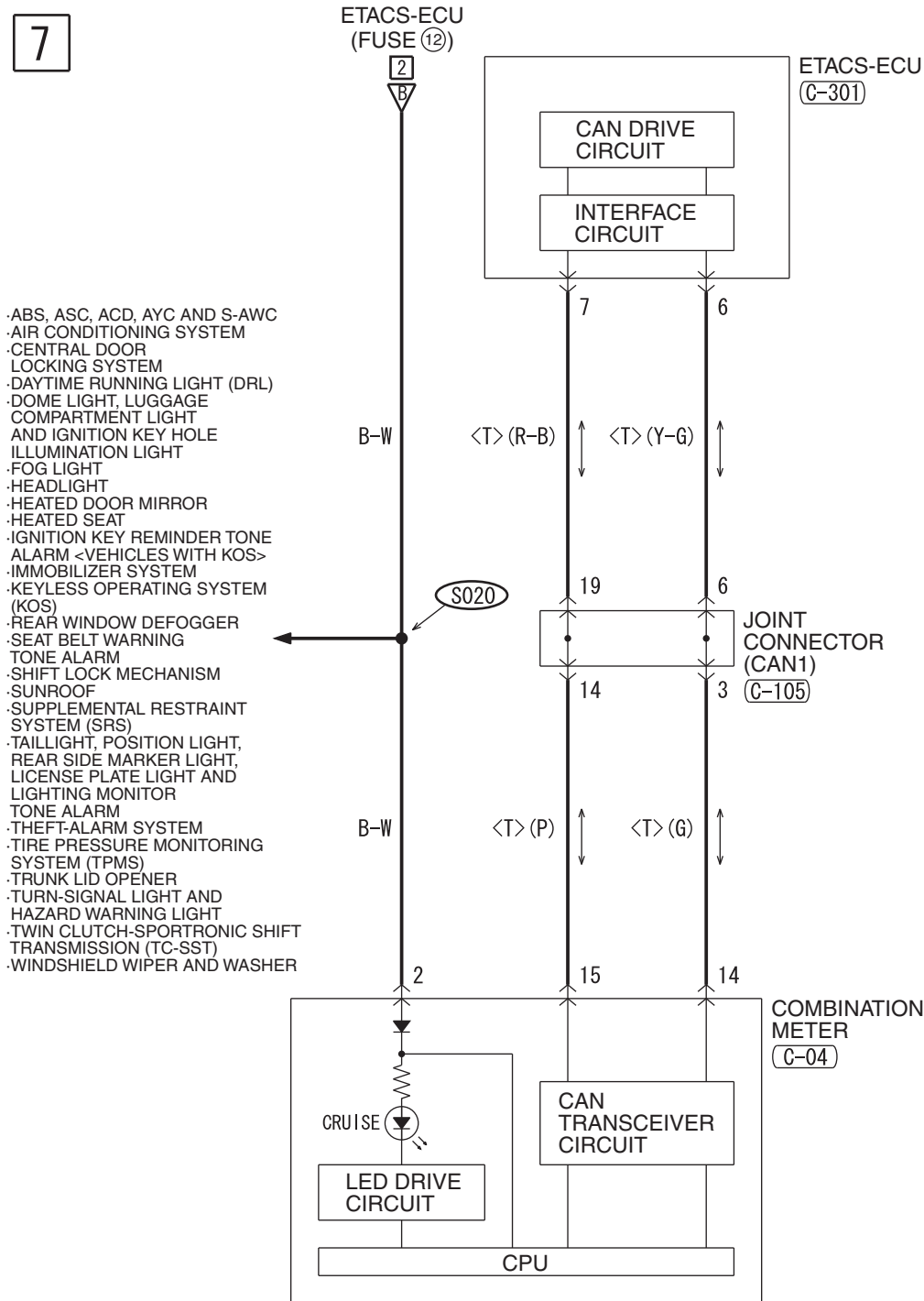

- ABS, ASC, ACD, AYC AND S-AWC
- AIR CONDITIONING SYSTEM
- CENTRAL DOOR LOCKING SYSTEM
- DAYTIME RUNNING LIGHT (DRL)
- DOME LIGHT, LUGGAGE COMPARTMENT LIGHT AND IGNITION KEY HOLE ILLUMINATION LIGHT
- FOG LIGHT
- HEADLIGHT
- HEATED DOOR MIRROR
- HEATED SEAT
- IGNITION KEY REMINDER TONE ALARM <VEHICLES WITH KOS>
- IMMOBILIZER SYSTEM
- KEYLESS OPERATING SYSTEM (KOS)
- REAR WINDOW DEFOGGER
- SEAT BELT WARNING TONE ALARM
- SHIFT LOCK MECHANISM
- SUNROOF
- SUPPLEMENTAL RESTRAINT SYSTEM (SRS)
- TAILLIGHT, POSITION LIGHT, REAR SIDE MARKER LIGHT, LICENSE PLATE LIGHT AND LIGHTING MONITOR TONE ALARM
- THEFT-ALARM SYSTEM
- TIRE PRESSURE MONITORING SYSTEM (TPMS)
- TRUNK LID OPENER
- TURN-SIGNAL LIGHT AND HAZARD WARNING LIGHT
- TWIN CLUTCH-SPORTRONIC SHIFT TRANSMISSION (TC-SST)
- WINDSHIELD WIPER AND WASHER

(C-04)

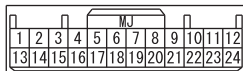

(C-105)

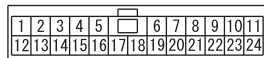

(C-301)

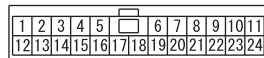

WIRE COLOR CODE

B : BLACK LG : LIGHT GREEN G : GREEN L : BLUE W : WHITE Y : YELLOW SB : SKY BLUE  
BR : BROWN O : ORANGE GR : GRAY R : RED P : PINK V : VIOLET PU : PURPLE SI : SILVER

NOTES

TIRE PRESSURE MONITORING SYSTEM (TPMS) <M/T>

M1901003900840

1

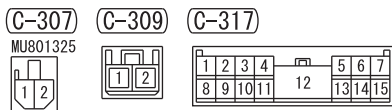
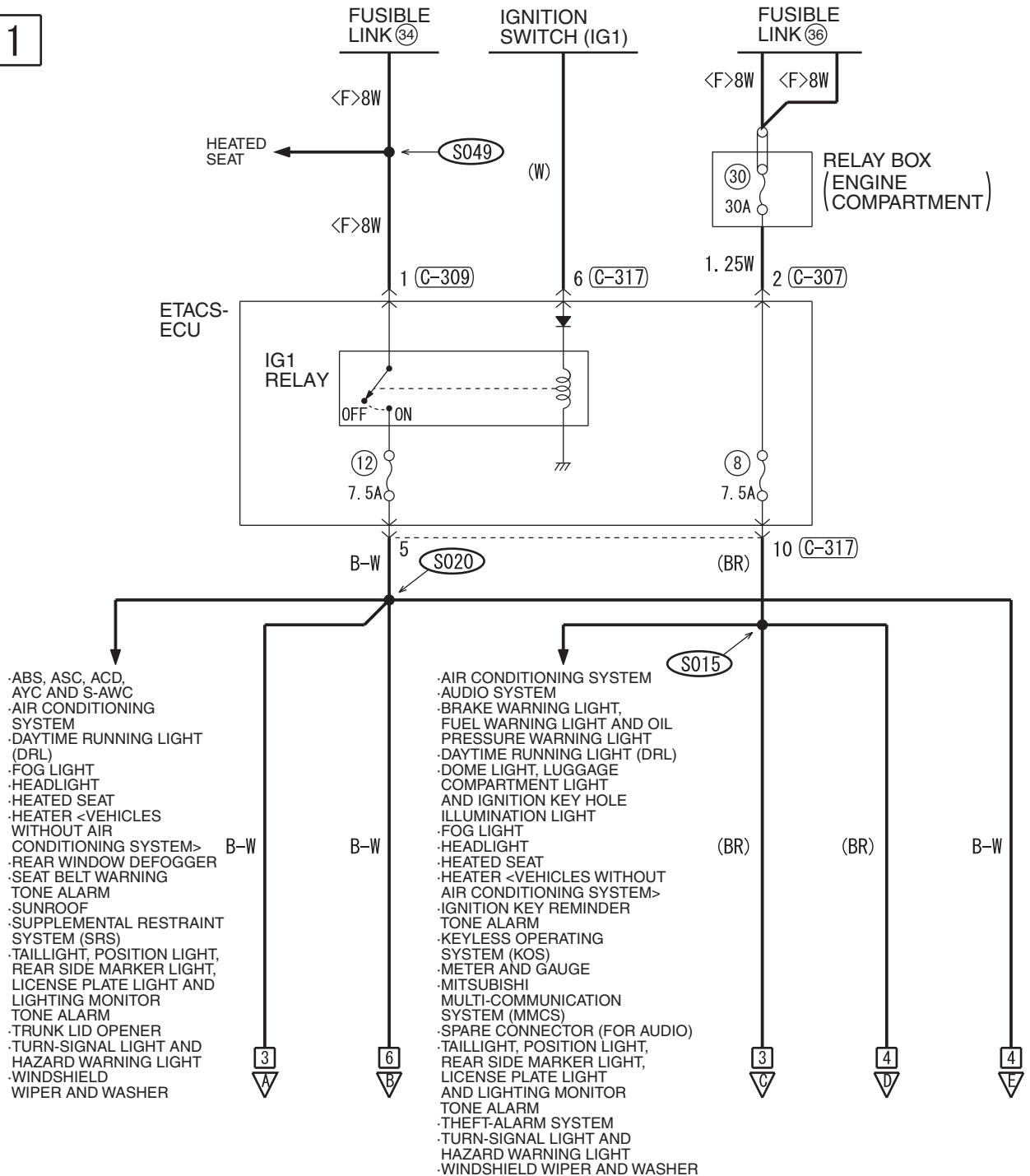

2

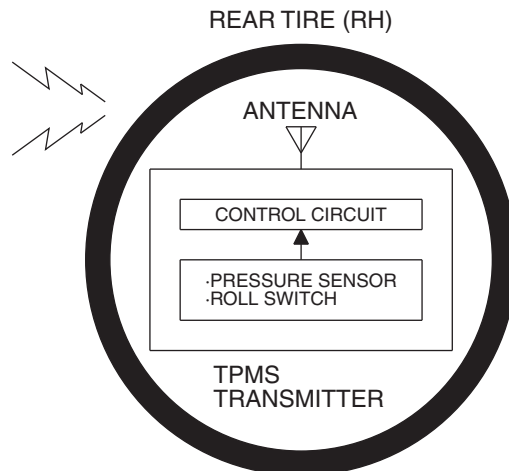
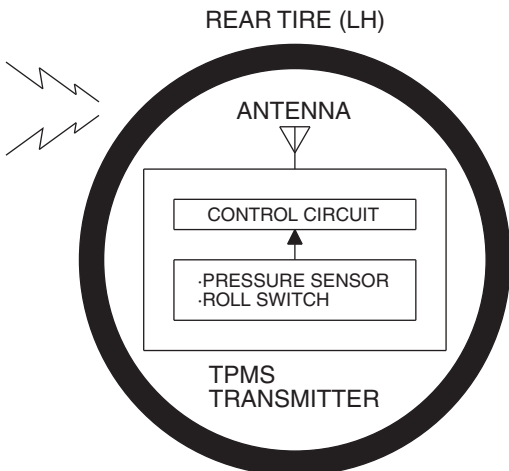
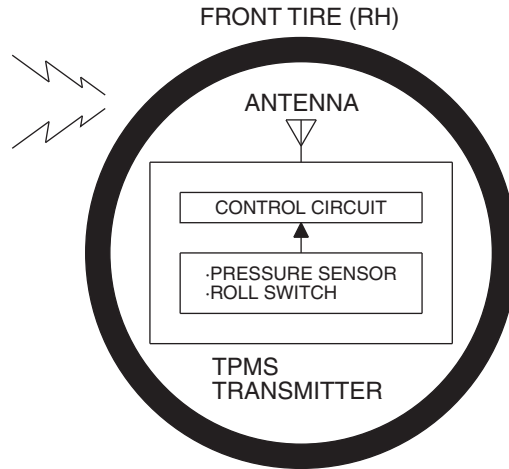
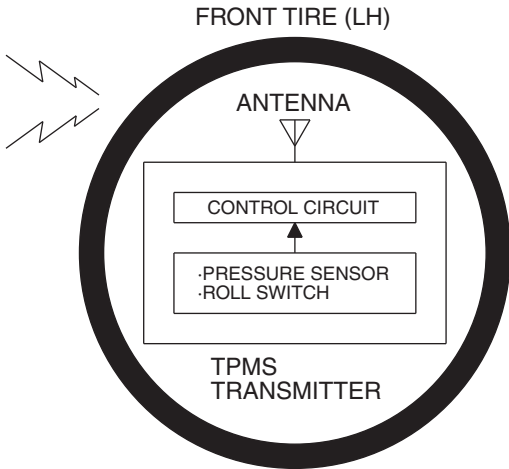

WIRE COLOR CODE  
B: BLACK LG: LIGHT GREEN G: GREEN L: BLUE W: WHITE Y: YELLOW SB: SKY BLUE  
BR: BROWN O: ORANGE GR: GRAY R: RED P: PINK V: VIOLET PU: PURPLE SI: SILVER

HAH15M24AB

TSB Revision

TIRE PRESSURE MONITORING (TPMS) <M/T> (CONTINUED)

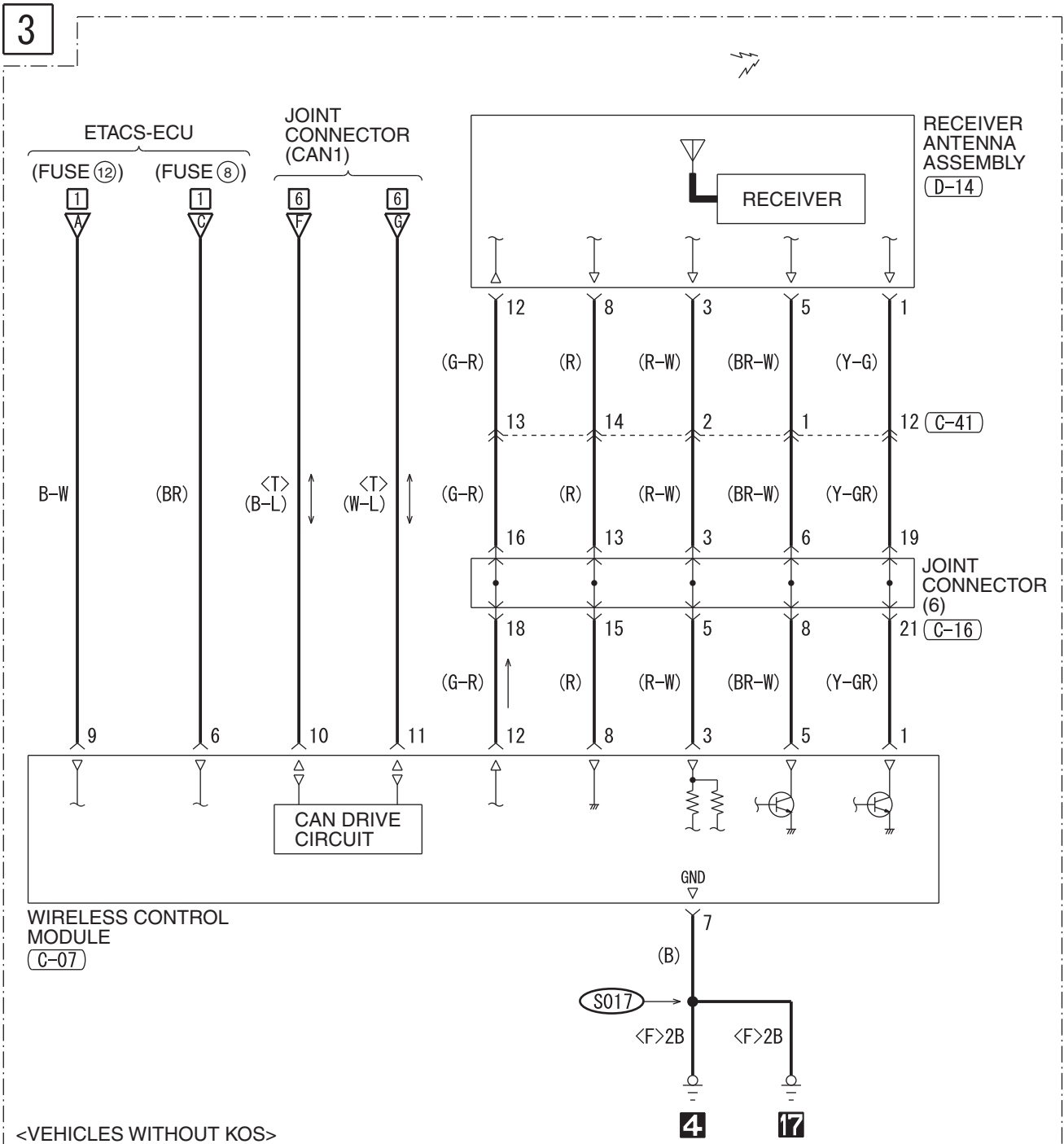

(C-05)

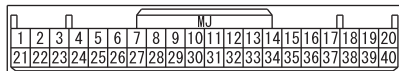

(C-07)

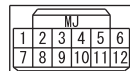

(C-16)

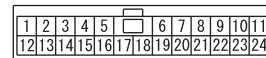

(C-41)

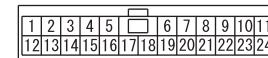

(D-14)

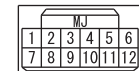

4

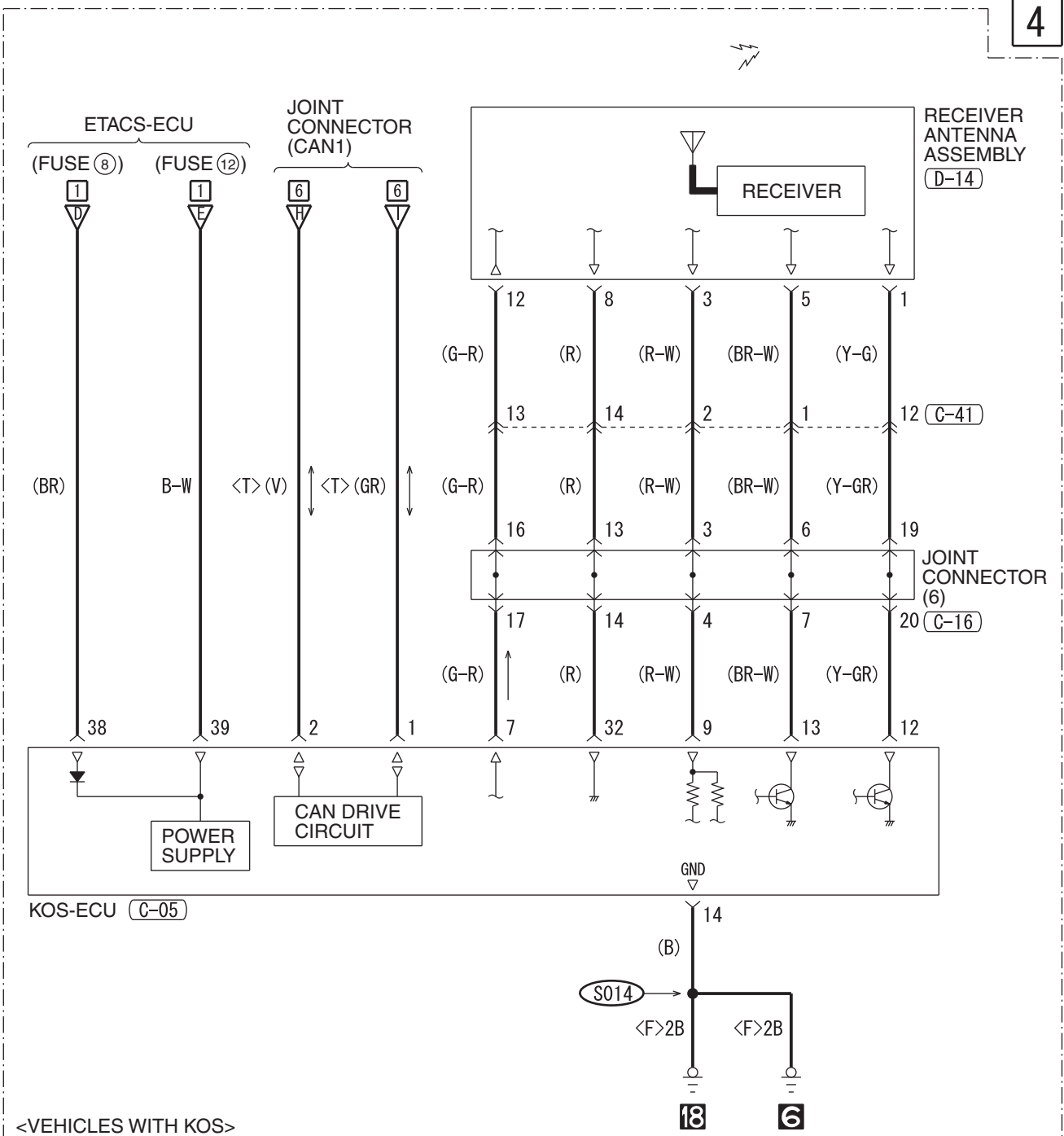

TIRE PRESSURE MONITORING (TPMS) <M/T> (CONTINUED)

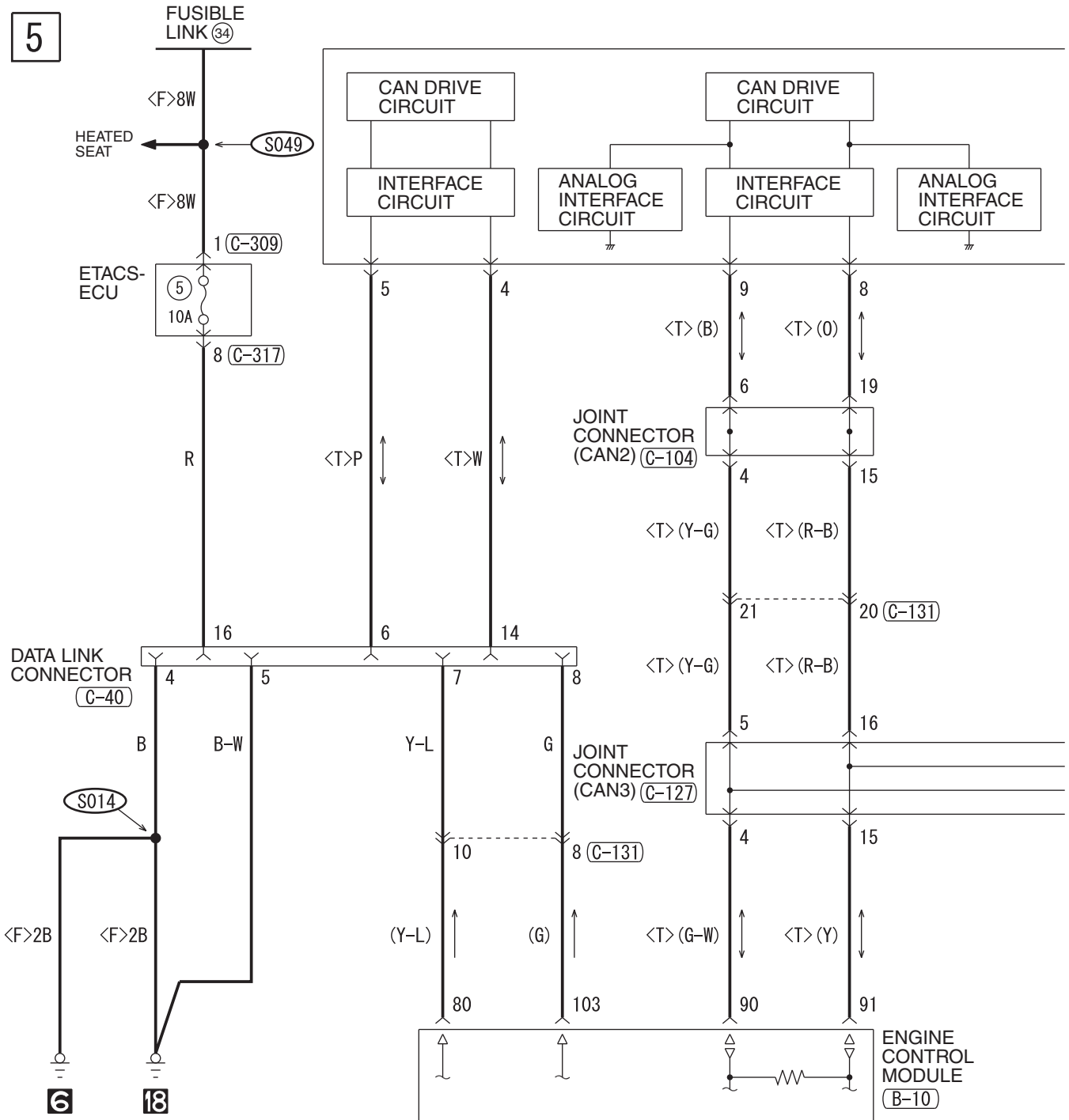

A-05

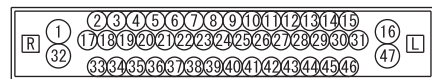

C-301



C-309



B-10

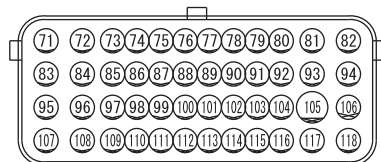

C-04

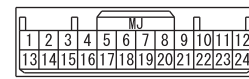

C-317

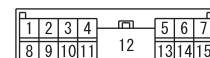

C-40 FRONT SIDE





6

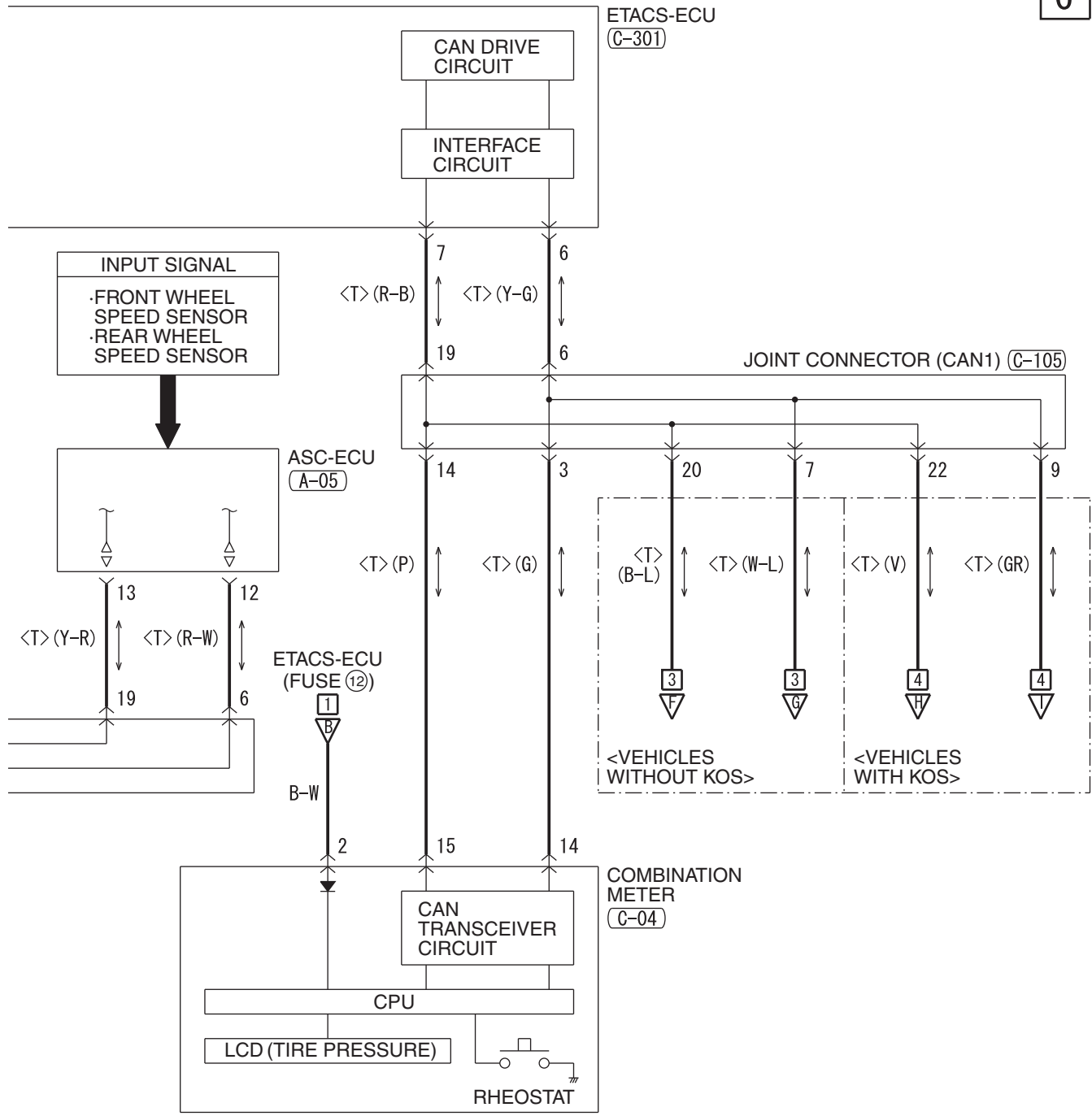

(C-104)

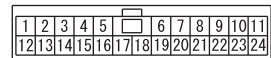

(C-105)

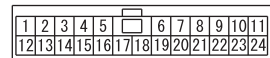

(C-127)

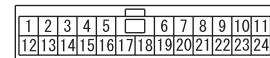

(C-131)

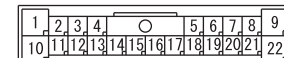

**WIRE COLOR CODE**  
 B : BLACK   LG : LIGHT GREEN   G : GREEN   L : BLUE   W : WHITE   Y : YELLOW   SB : SKY BLUE  
 BR : BROWN   O : ORANGE   GR : GRAY   R : RED   P : PINK   V : VIOLET   PU : PURPLE   SI : SILVER

HAH15M24CB

**TSB Revision**

TIRE PRESSURE MONITORING SYSTEM (TPMS) <TC-SST>

M1901003900851

1

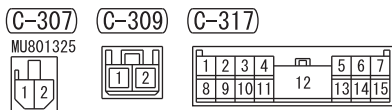
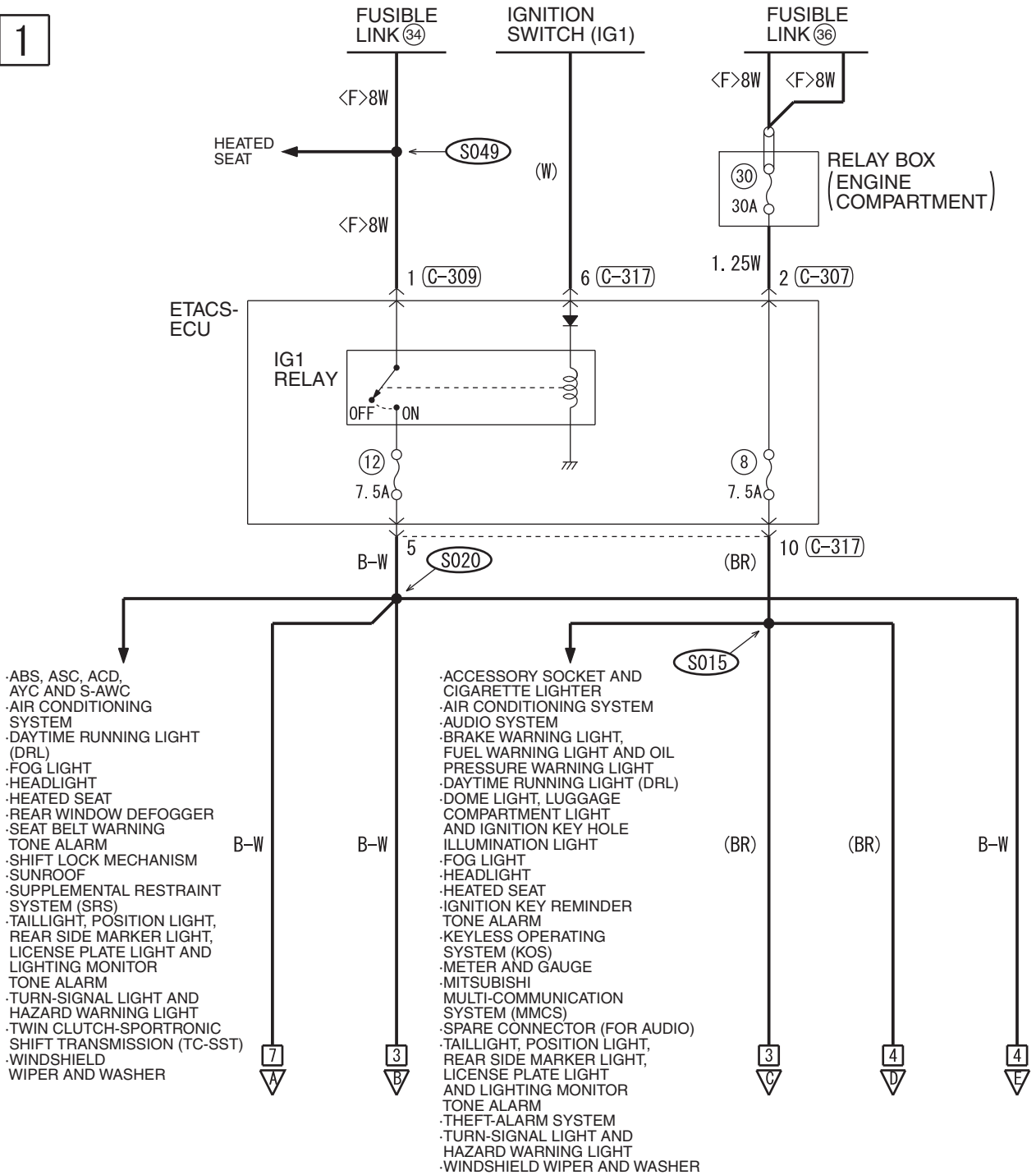

2

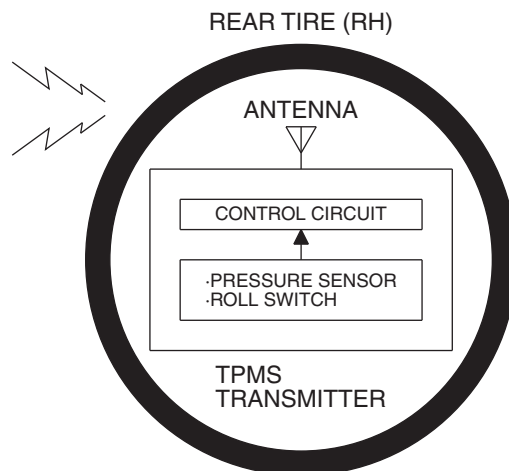
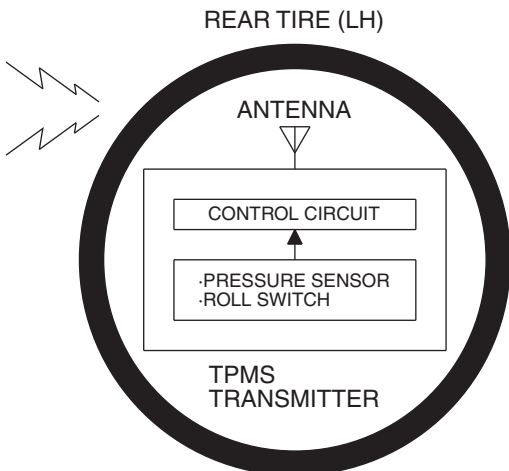
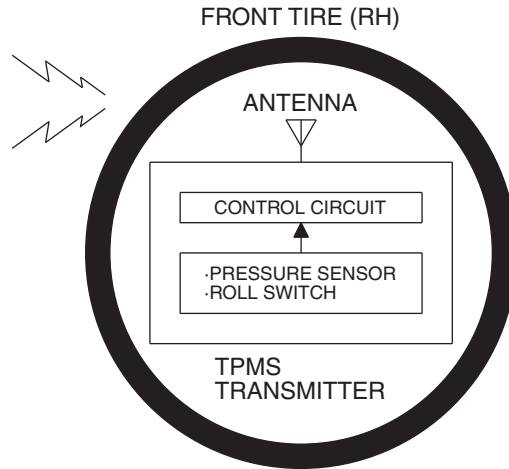
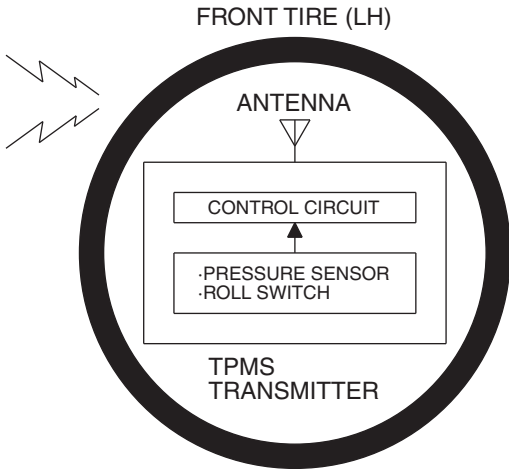

WIRE COLOR CODE  
 B: BLACK LG: LIGHT GREEN G: GREEN L: BLUE W: WHITE Y: YELLOW SB: SKY BLUE  
 BR: BROWN O: ORANGE GR: GRAY R: RED P: PINK V: VIOLET PU: PURPLE SI: SILVER

HAH15M25AB

TSB Revision

TIRE PRESSURE MONITORING (TPMS) <TC-SST> (CONTINUED)

3

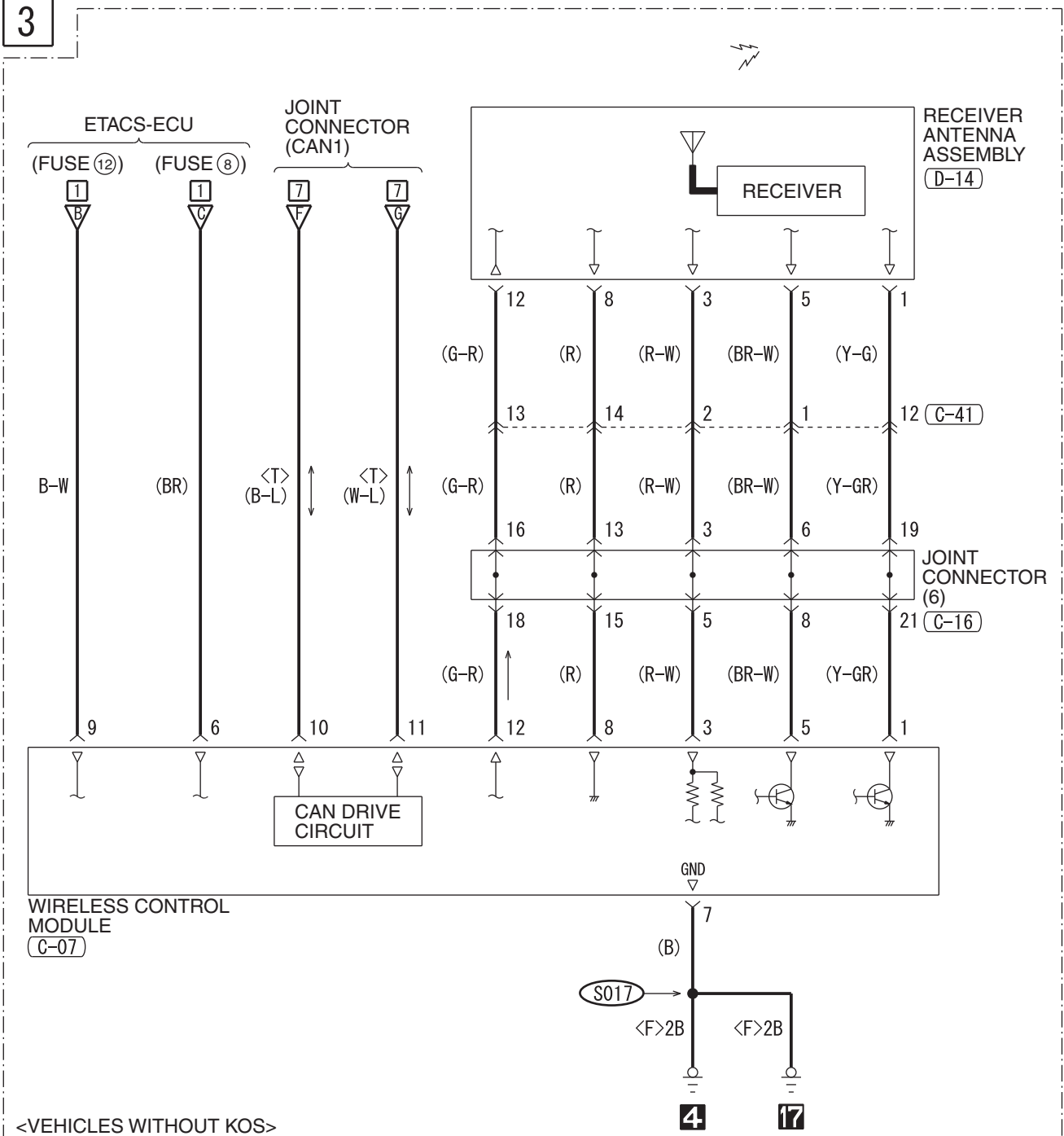

<VEHICLES WITHOUT KOS>

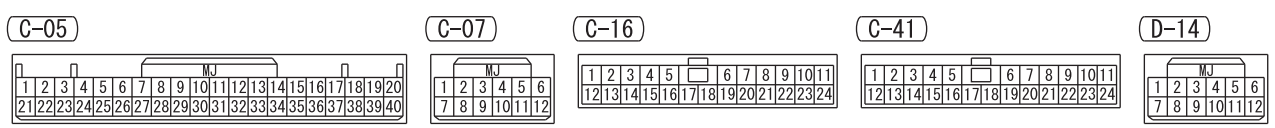

**4**

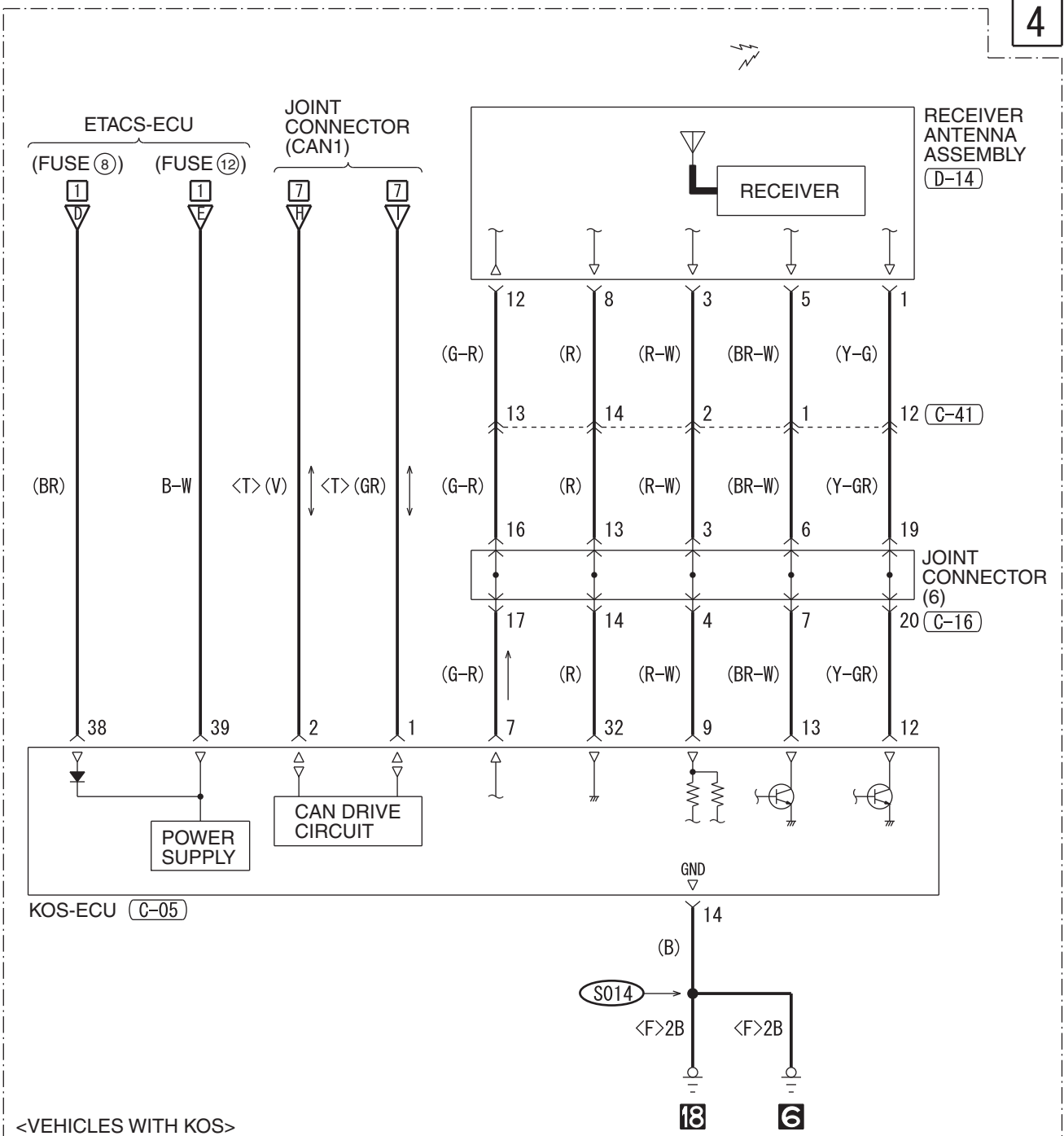

<VEHICLES WITH KOS>

**WIRE COLOR CODE**  
 B: BLACK LG: LIGHT GREEN G: GREEN L: BLUE W: WHITE Y: YELLOW SB: SKY BLUE  
 BR: BROWN O: ORANGE GR: GRAY R: RED P: PINK V: VIOLET PU: PURPLE SI: SILVER

HAH15M255BB

**TSB Revision**

TIRE PRESSURE MONITORING (TPMS) <TC-SST> (CONTINUED)

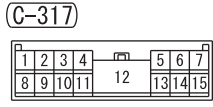
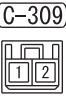
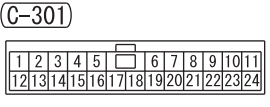
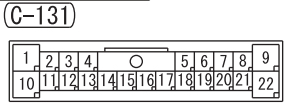
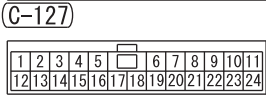
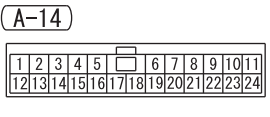
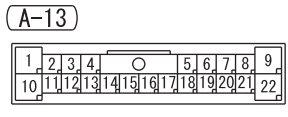
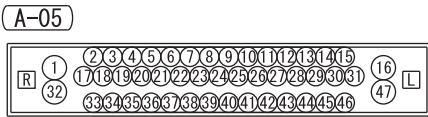
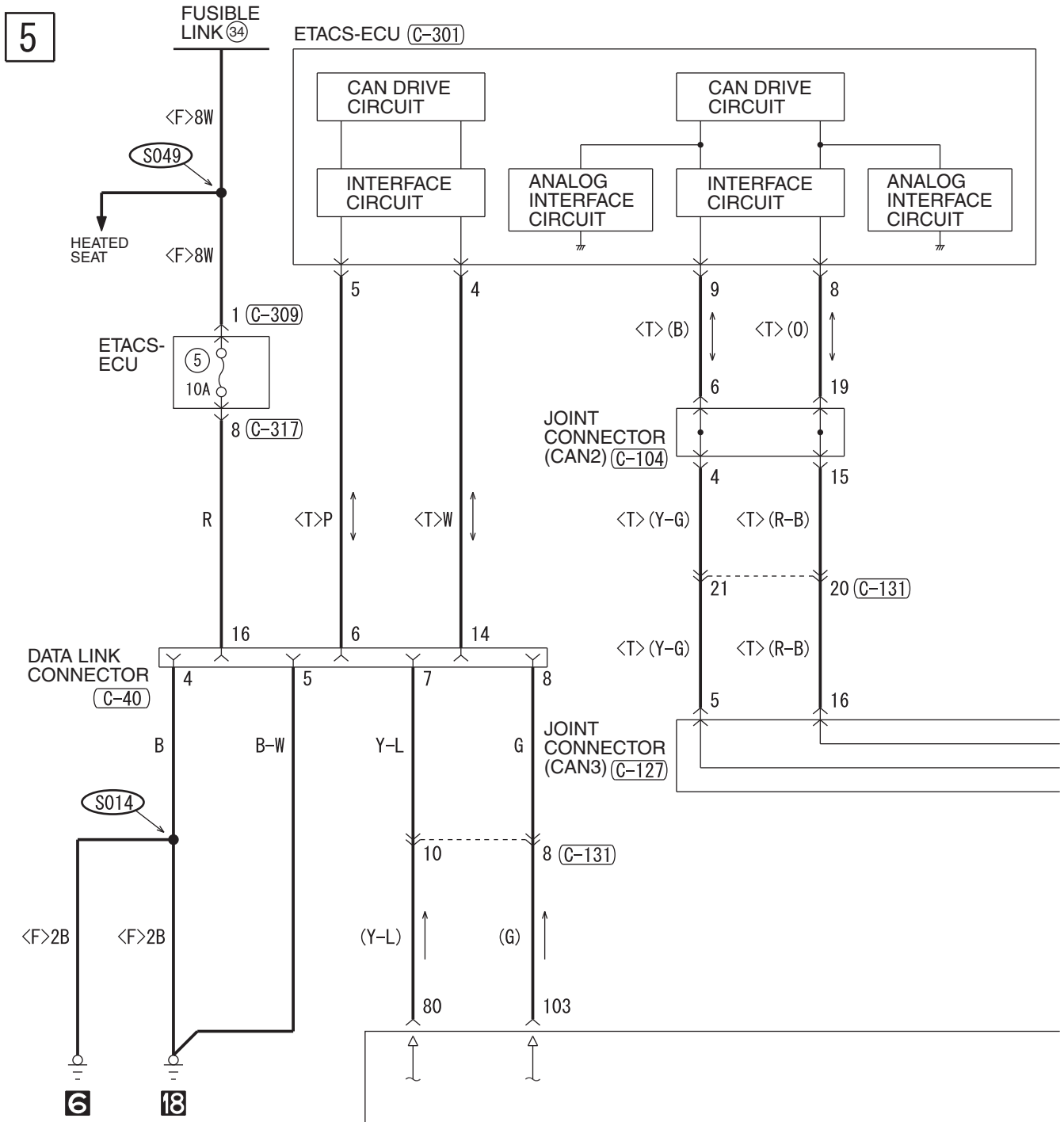

6

NOTE  
\* : THE TERMINAL NUMBERS DESCRIBED  
IN THE CIRCUIT DIAGRAM AGREE WITH  
THE NUMBERS MARKED ON THE  
TRANSAXLE ASSEMBLY CONNECTOR AND  
HARNES SIDE CONNECTOR.

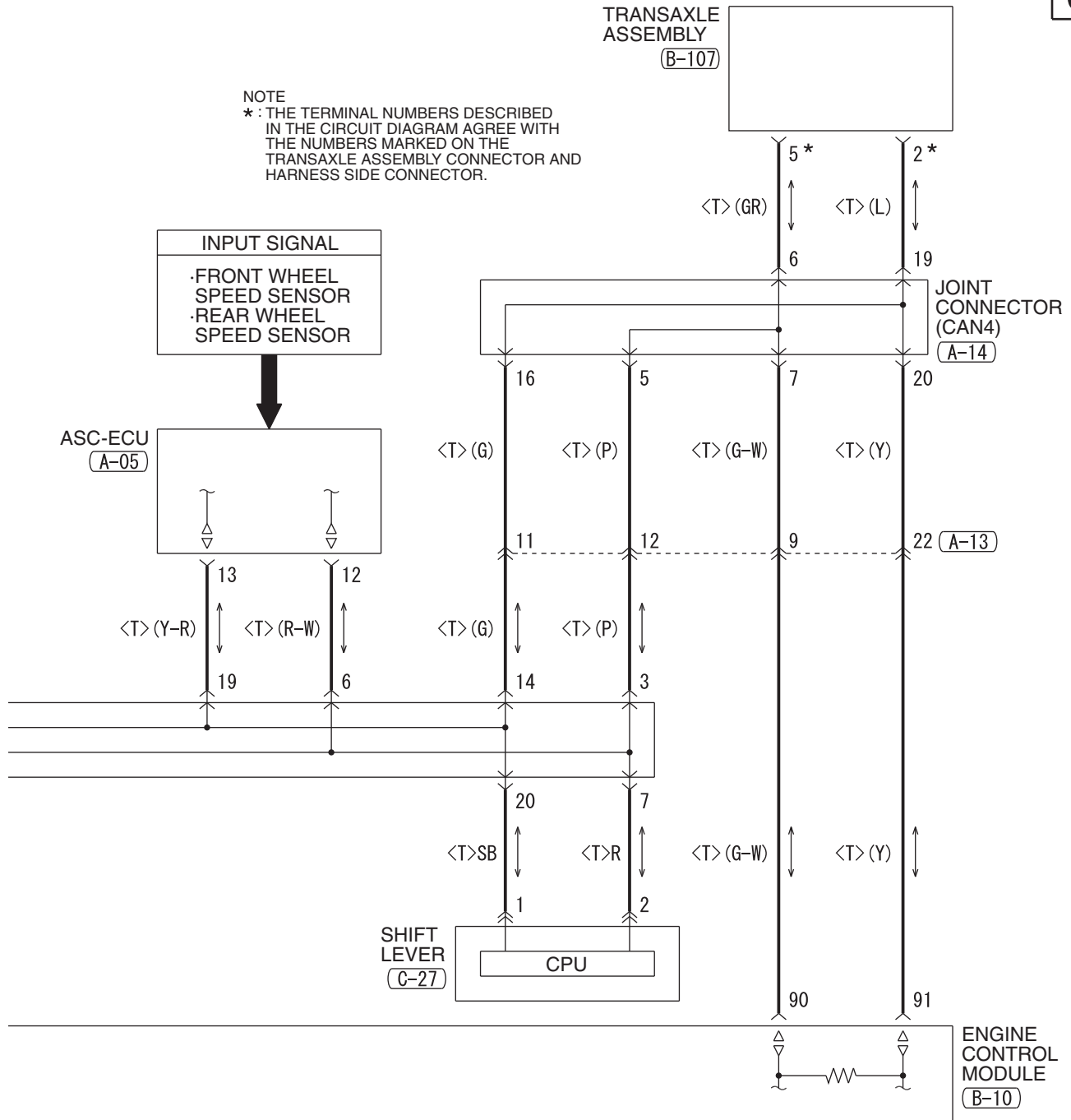

(B-10)

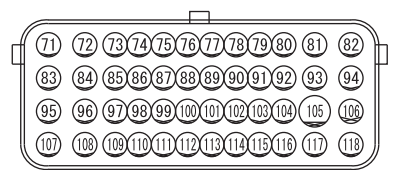

(B-107)\*



(C-27)

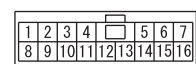

(C-40) FRONT SIDE



(C-104)

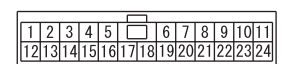

TIRE PRESSURE MONITORING (TPMS) <TC-SST> (CONTINUED)

7

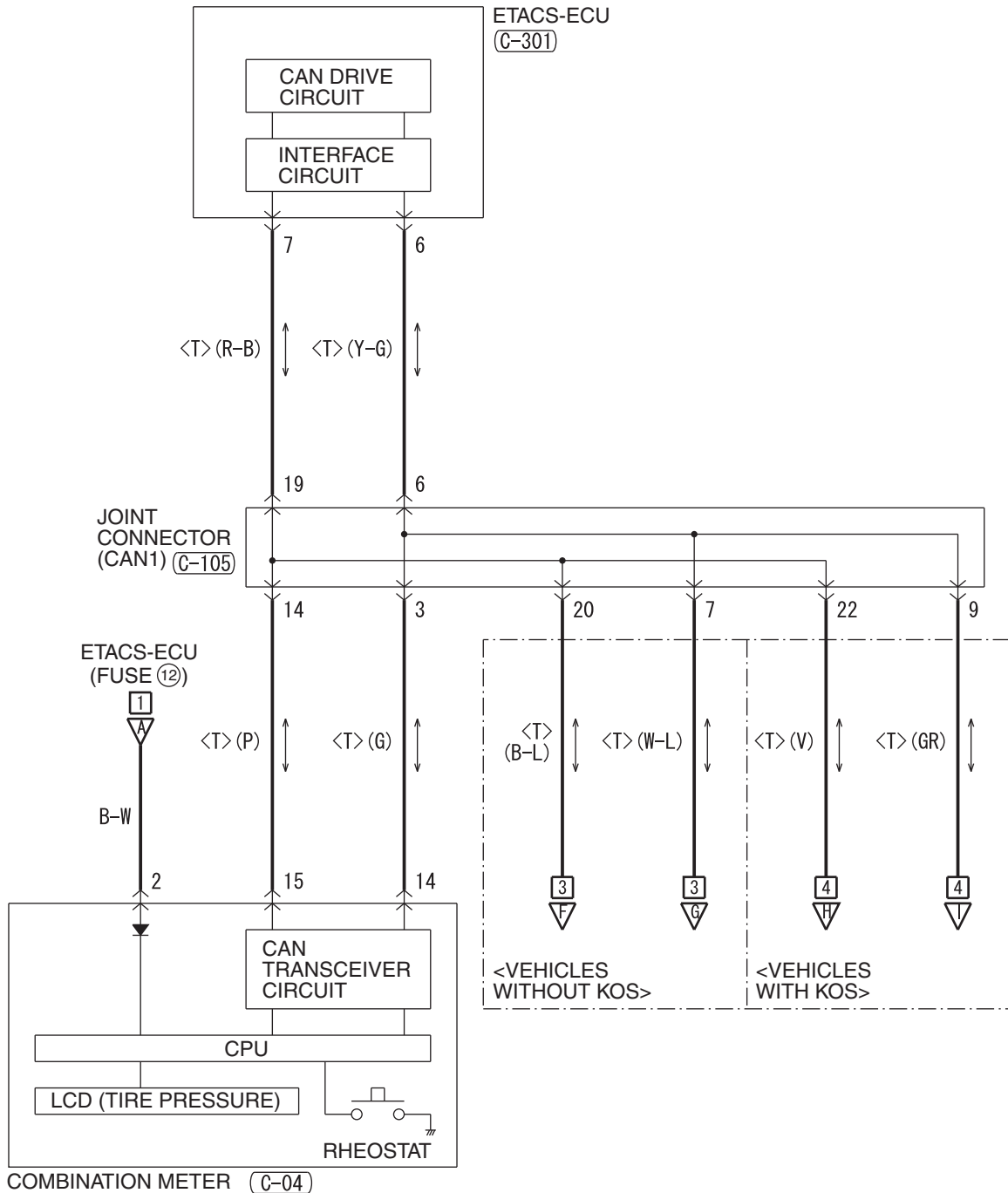

(C-04)

(C-105)

(C-301)

1	2	3	4	5	6	7	8	9	10	11	12
13	14	15	16	17	18	19	20	21	22	23	24

1	2	3	4	5	6	7	8	9	10	11		
12	13	14	15	16	17	18	19	20	21	22	23	24

1	2	3	4	5	6	7	8	9	10	11		
12	13	14	15	16	17	18	19	20	21	22	23	24

WIRE COLOR CODE

B : BLACK LG : LIGHT GREEN G : GREEN L : BLUE W : WHITE Y : YELLOW SB : SKY BLUE  
BR : BROWN O : ORANGE GR : GRAY R : RED P : PINK V : VIOLET PU : PURPLE SI : SILVER

HAH15M25DA



NOTES

# IMMOBILIZER SYSTEM <M/T>

M1901013604819

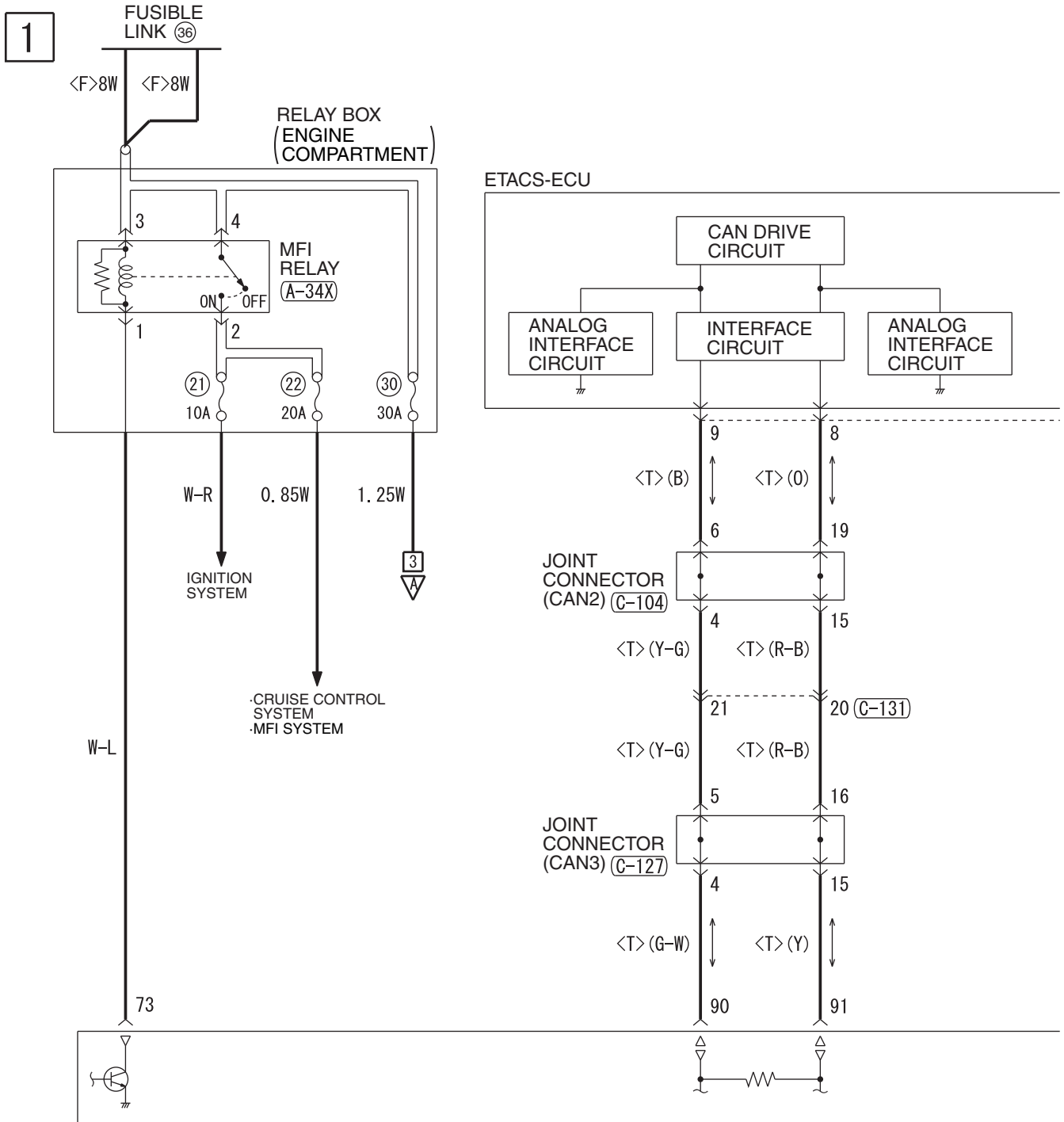

(A-34X)

(B-10)

(C-40) FRONT SIDE

(C-104)

(C-105)

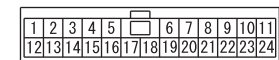
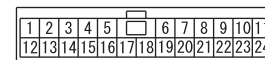
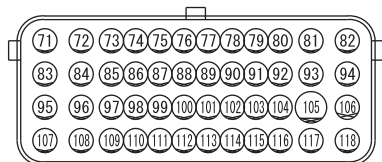

HAH15M26AA

2

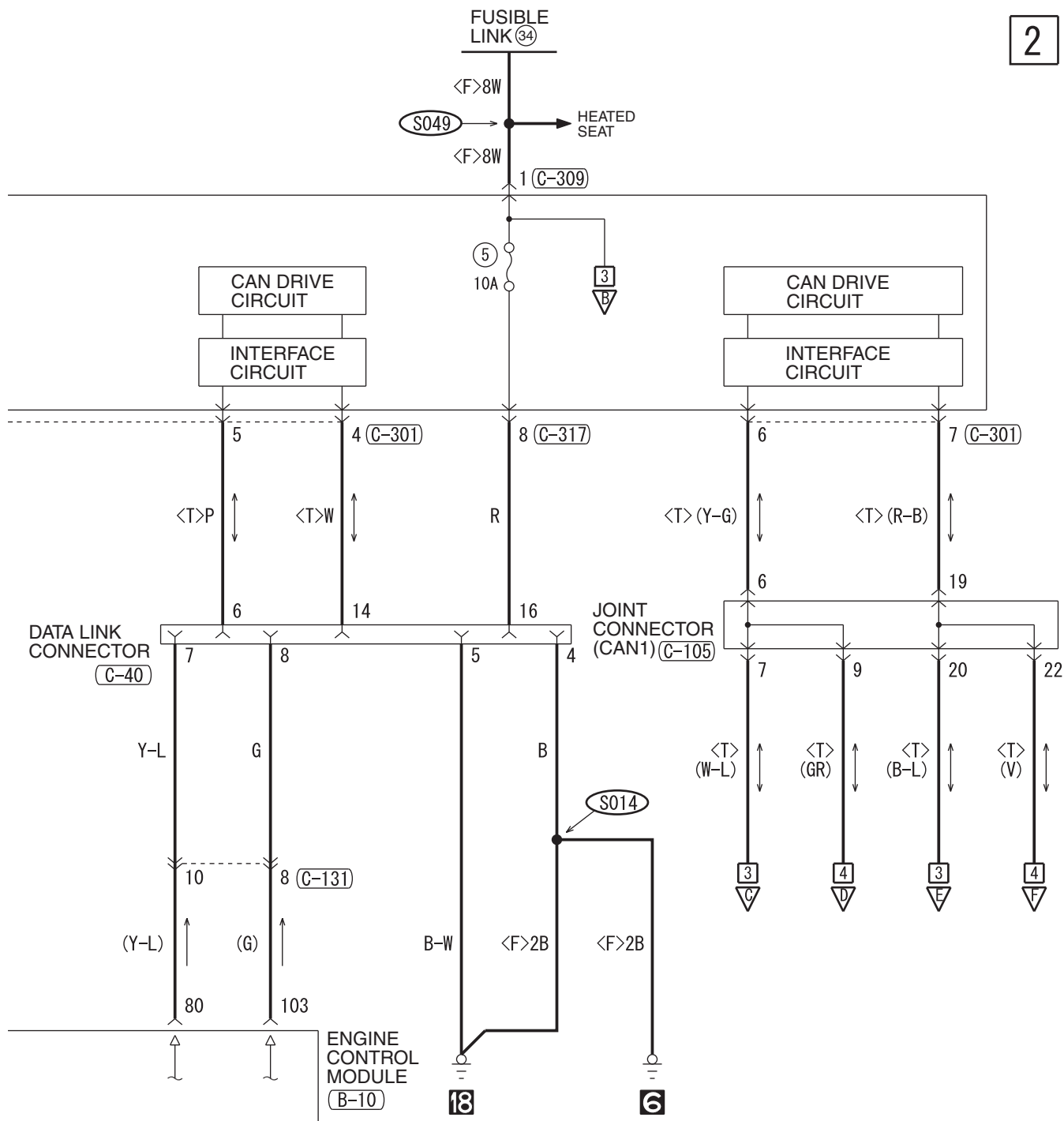

(C-127)

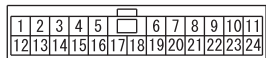

(C-131)

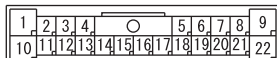

(C-301)

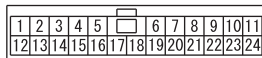

(C-309)



(C-317)

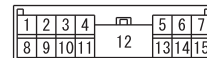

WIRE COLOR CODE  
 B : BLACK LG : LIGHT GREEN G : GREEN L : BLUE W : WHITE Y : YELLOW SB : SKY BLUE  
 BR : BROWN O : ORANGE GR : GRAY R : RED P : PINK V : VIOLET PU : PURPLE SI : SILVER

HAH15M26AB

IMMOBILIZER SYSTEM <M/T> (CONTINUED)

3

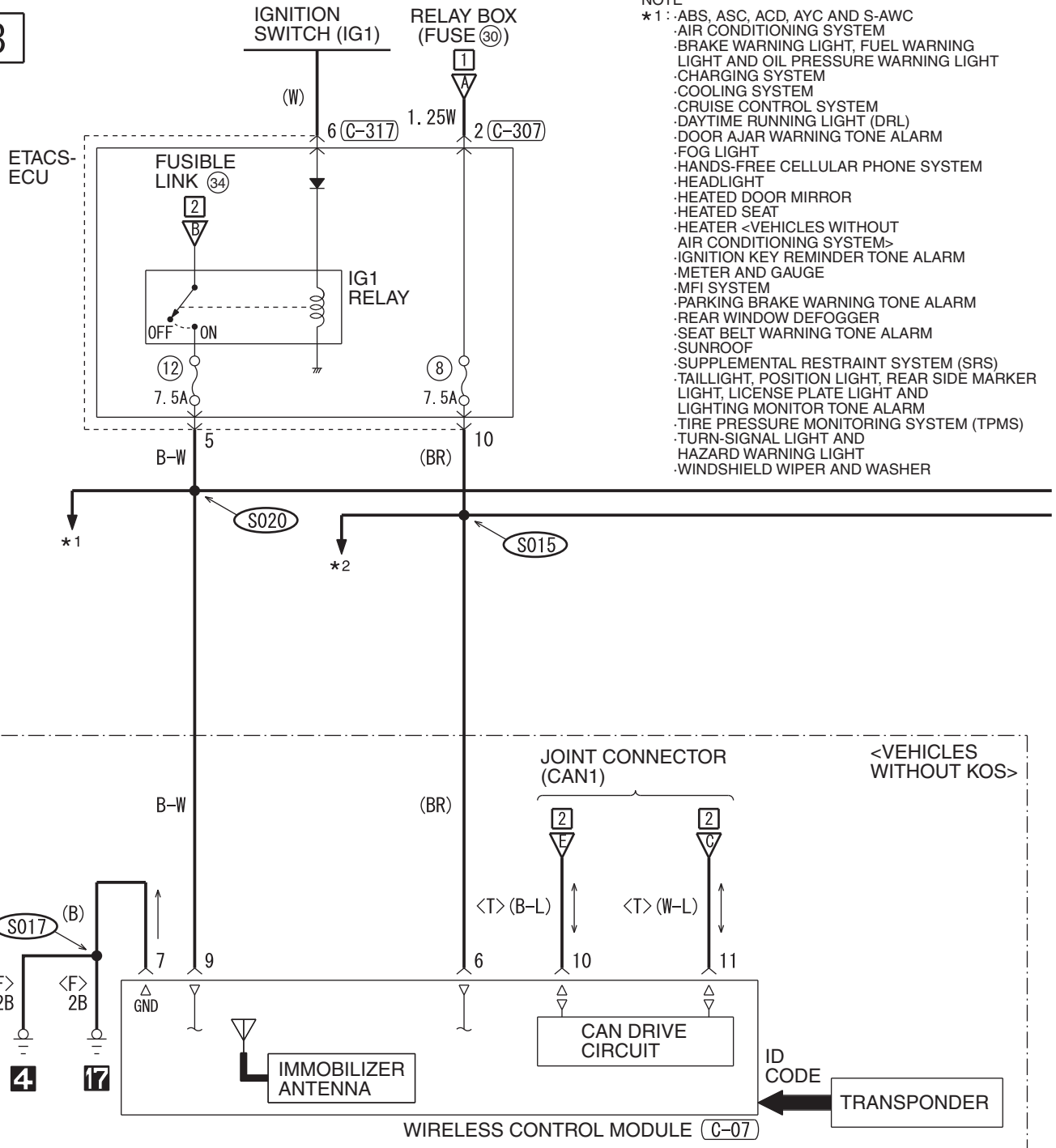

NOTE

- \* 1 : -ABS, ASC, ACD, AYC AND S-AWC
- AIR CONDITIONING SYSTEM
- BRAKE WARNING LIGHT, FUEL WARNING LIGHT AND OIL PRESSURE WARNING LIGHT
- CHARGING SYSTEM
- COOLING SYSTEM
- CRUISE CONTROL SYSTEM
- DAYTIME RUNNING LIGHT (DRL)
- DOOR AJAR WARNING TONE ALARM
- FOG LIGHT
- HANDS-FREE CELLULAR PHONE SYSTEM
- HEADLIGHT
- HEATED DOOR MIRROR
- HEATED SEAT
- HEATER <VEHICLES WITHOUT AIR CONDITIONING SYSTEM>
- IGNITION KEY REMINDER TONE ALARM
- METER AND GAUGE
- MFI SYSTEM
- PARKING BRAKE WARNING TONE ALARM
- REAR WINDOW DEFOGGER
- SEAT BELT WARNING TONE ALARM
- SUNROOF
- SUPPLEMENTAL RESTRAINT SYSTEM (SRS)
- TAILLIGHT, POSITION LIGHT, REAR SIDE MARKER LIGHT, LICENSE PLATE LIGHT AND LIGHTING MONITOR TONE ALARM
- TIRE PRESSURE MONITORING SYSTEM (TPMS)
- TURN-SIGNAL LIGHT AND HAZARD WARNING LIGHT
- WINDSHIELD WIPER AND WASHER

C-05

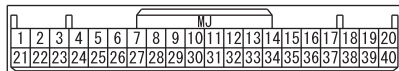

C-07

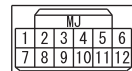

C-08

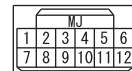

C-16



C-307



C-317

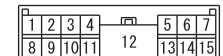

- \*2: -AIR CONDITIONING SYSTEM  
-AUDIO SYSTEM  
-BRAKE WARNING LIGHT,  
FUEL WARNING LIGHT AND OIL  
PRESSURE WARNING LIGHT  
-DOME LIGHT, LUGGAGE  
COMPARTMENT LIGHT AND  
IGNITION KEY HOLE  
ILLUMINATION LIGHT  
-FOG LIGHT  
-HEADLIGHT  
-HEATED SEAT  
-HEATER <VEHICLES WITHOUT  
AIR CONDITIONING SYSTEM>  
-IGNITION KEY REMINDER TONE ALARM

- METER AND GAUGE  
-MITSUBISHI  
MULTI-COMMUNICATION  
SYSTEM (MMCS)  
-SPARE CONNECTOR (FOR AUDIO)  
-TAILLIGHT, POSITION LIGHT,  
REAR SIDE MARKER LIGHT,  
LICENSE PLATE LIGHT  
AND LIGHTING MONITOR  
TONE ALARM  
-THEFT-ALARM SYSTEM  
-TURN-SIGNAL LIGHT  
AND HAZARD WARNING LIGHT  
-WINDSHIELD WIPER AND WASHER

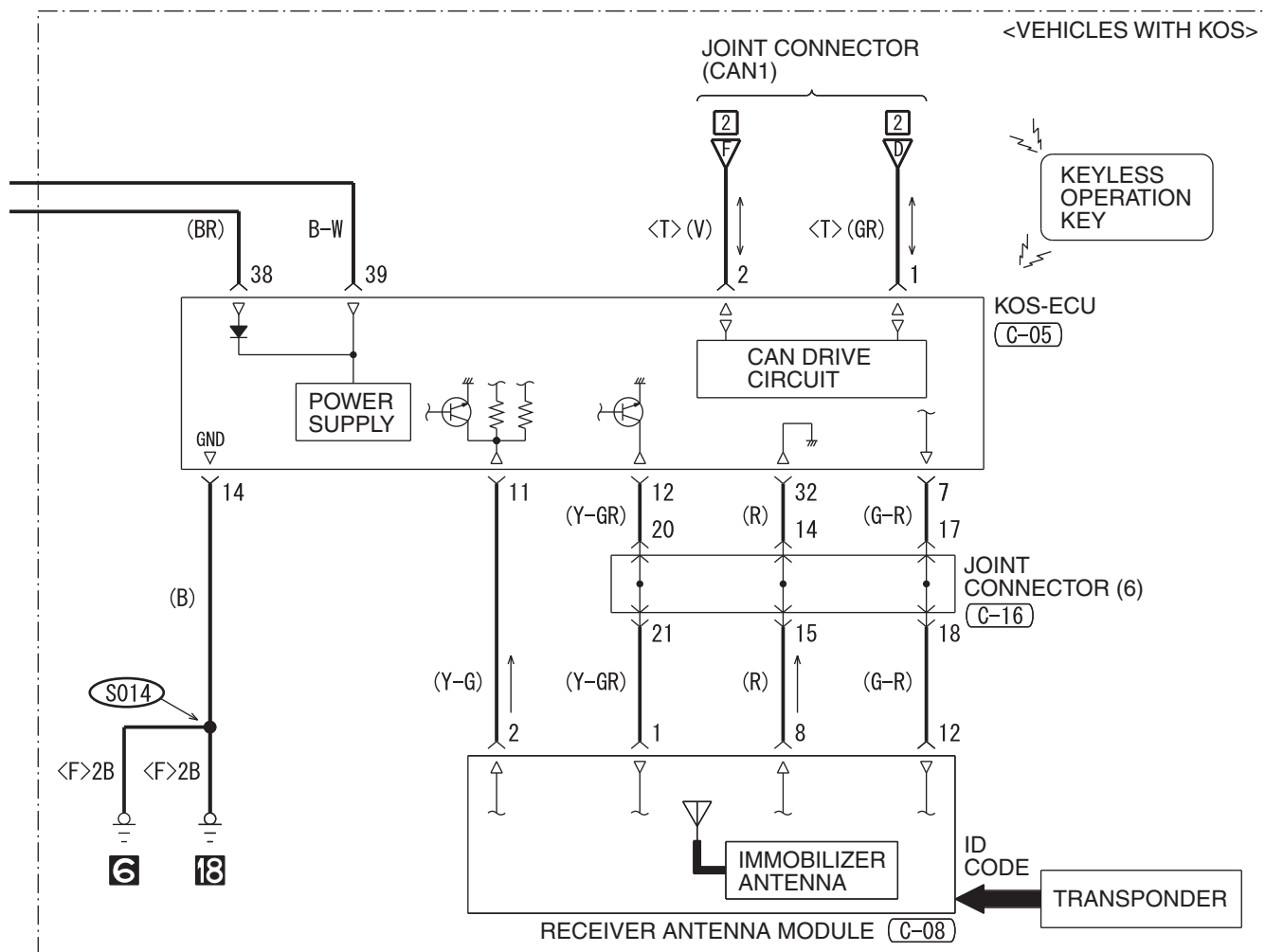

WIRE COLOR CODE

B: BLACK LG: LIGHT GREEN G: GREEN L: BLUE W: WHITE Y: YELLOW SB: SKY BLUE  
BR: BROWN O: ORANGE GR: GRAY R: RED P: PINK V: VIOLET PU: PURPLE SI: SILVER

# IMMOBILIZER SYSTEM <TC-SST>

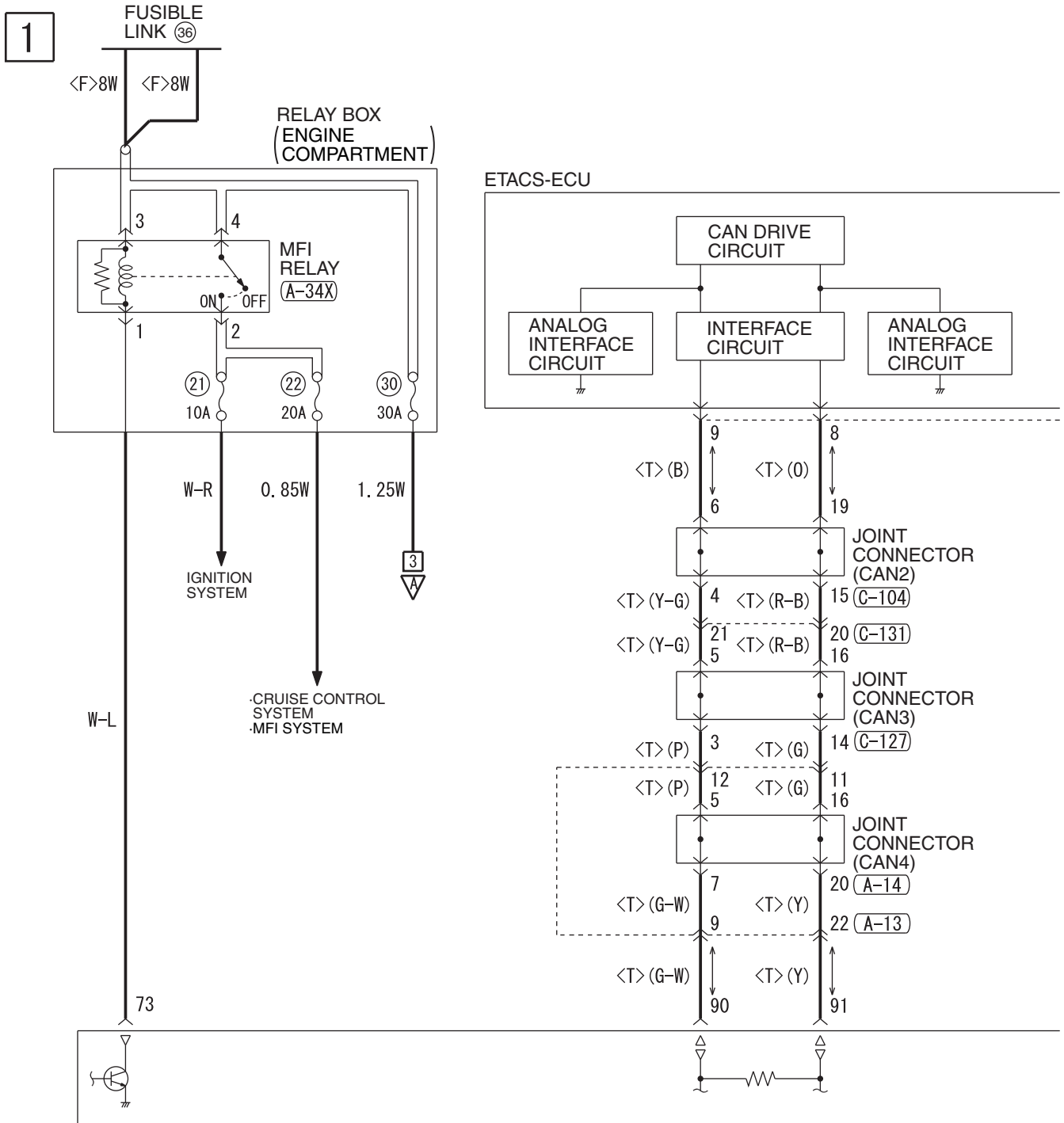

(A-13)

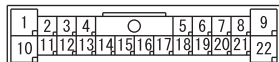

(A-14)

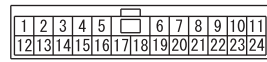

(A-34X)



(B-10)

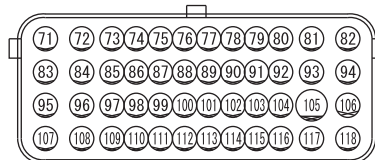

(C-40) FRONT SIDE



(C-301)

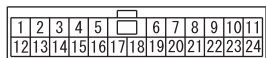

(C-309)



(C-317)

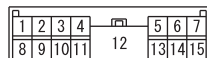

2

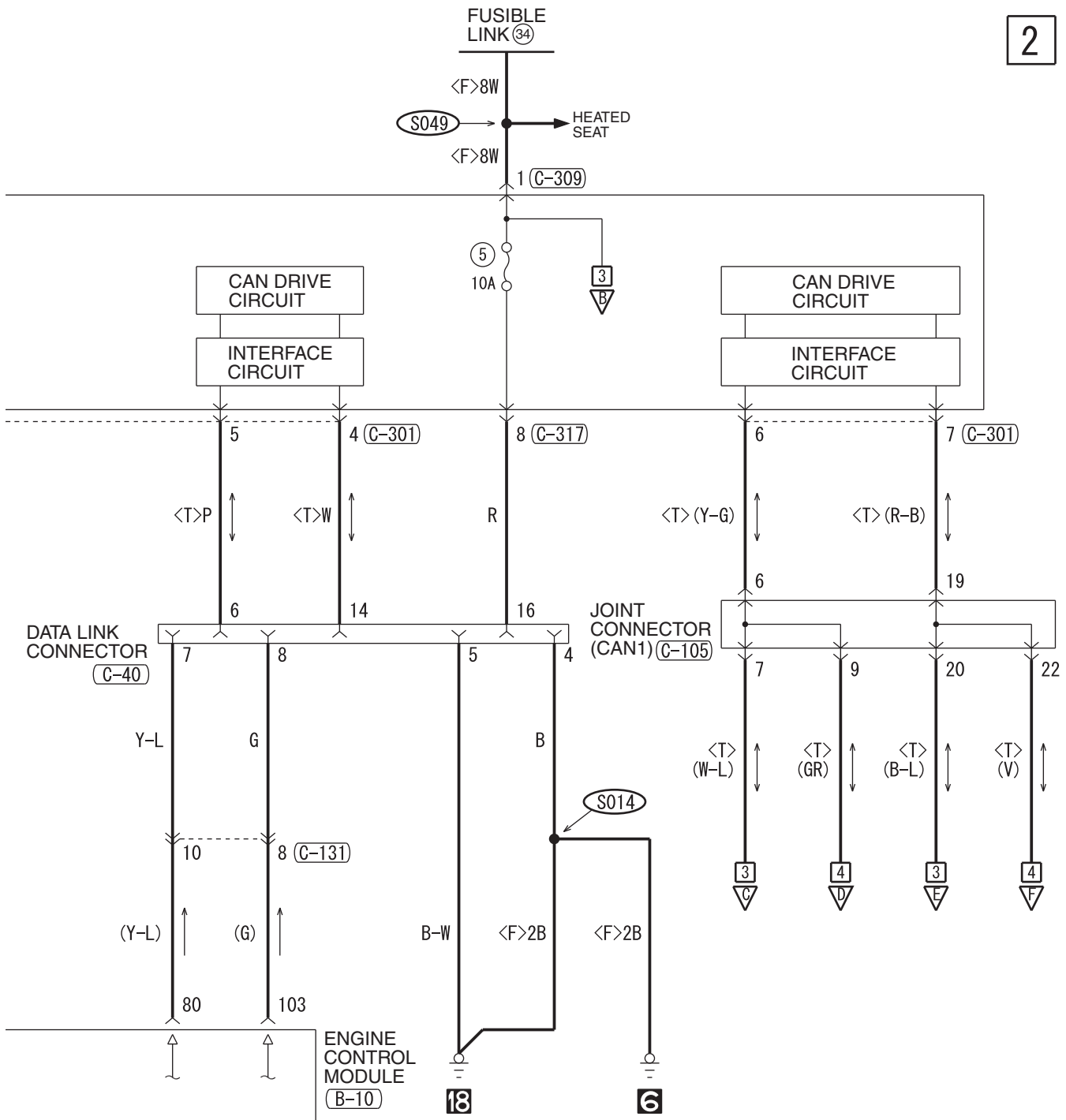

(C-104)

1	2	3	4	5	6	7	8	9	10	11		
12	13	14	15	16	17	18	19	20	21	22	23	24

(C-105)

1	2	3	4	5	6	7	8	9	10	11		
12	13	14	15	16	17	18	19	20	21	22	23	24

(C-127)

1	2	3	4	5	6	7	8	9	10	11		
12	13	14	15	16	17	18	19	20	21	22	23	24

(C-131)

1	2	3	4	5	6	7	8	9				
10	11	12	13	14	15	16	17	18	19	20	21	22

WIRE COLOR CODE

B : BLACK LG : LIGHT GREEN G : GREEN L : BLUE W : WHITE Y : YELLOW SB : SKY BLUE  
BR : BROWN O : ORANGE GR : GRAY R : RED P : PINK V : VIOLET PU : PURPLE SI : SILVER

IMMOBILIZER SYSTEM <TC-SST> (CONTINUED)

3

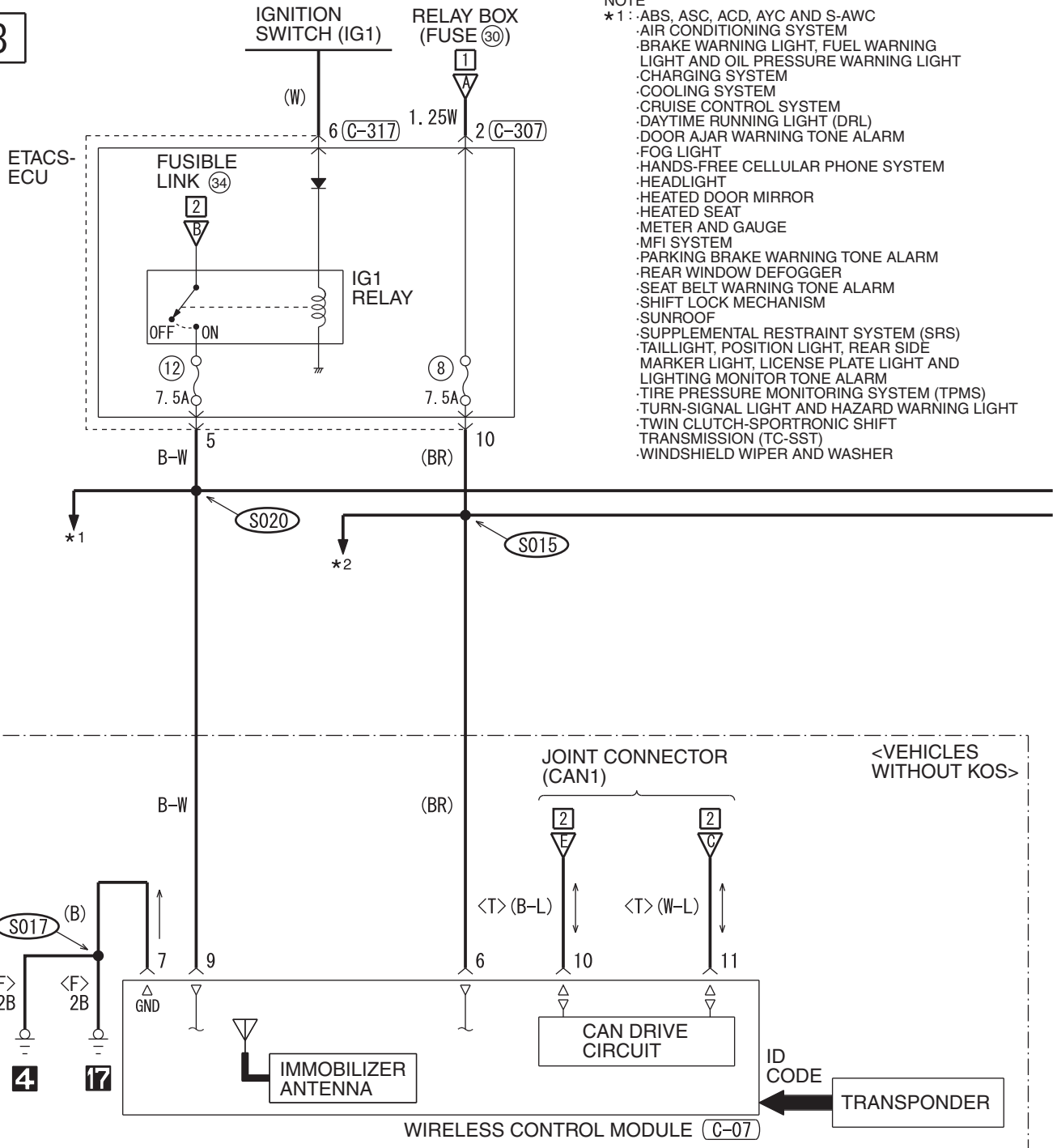

- NOTE  
\*1 : .ABS, ASC, ACD, AYC AND S-AWC  
.AIR CONDITIONING SYSTEM  
.BRAKE WARNING LIGHT, FUEL WARNING LIGHT AND OIL PRESSURE WARNING LIGHT  
.CHARGING SYSTEM  
.COOLING SYSTEM  
.CRUISE CONTROL SYSTEM  
.DAYTIME RUNNING LIGHT (DRL)  
.DOOR AJAR WARNING TONE ALARM  
.FOG LIGHT  
.HANDS-FREE CELLULAR PHONE SYSTEM  
.HEADLIGHT  
.HEATED DOOR MIRROR  
.HEATED SEAT  
.METER AND GAUGE  
.MFI SYSTEM  
.PARKING BRAKE WARNING TONE ALARM  
.REAR WINDOW DEFOGGER  
.SEAT BELT WARNING TONE ALARM  
.SHIFT LOCK MECHANISM  
.SUNROOF  
.SUPPLEMENTAL RESTRAINT SYSTEM (SRS)  
.TAILLIGHT, POSITION LIGHT, REAR SIDE MARKER LIGHT, LICENSE PLATE LIGHT AND LIGHTING MONITOR TONE ALARM  
.TIRE PRESSURE MONITORING SYSTEM (TPMS)  
.TURN-SIGNAL LIGHT AND HAZARD WARNING LIGHT  
.TWIN CLUTCH-SPORTRONIC SHIFT TRANSMISSION (TC-SST)  
.WINDSHIELD WIPER AND WASHER

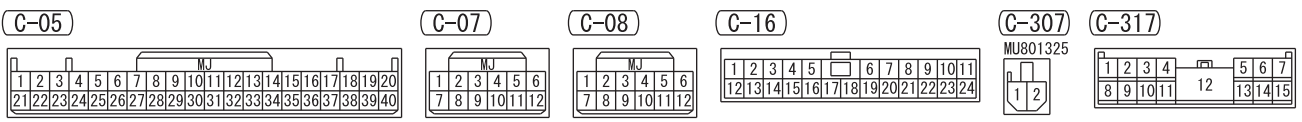



- \*2: ·ACCESSORY SOCKET AND CIGARETTE LIGHTER
- AIR CONDITIONING SYSTEM
- AUDIO SYSTEM
- BRAKE WARNING LIGHT, FUEL WARNING LIGHT AND OIL PRESSURE WARNING LIGHT
- DOME LIGHT, LUGGAGE COMPARTMENT LIGHT AND IGNITION KEY HOLE ILLUMINATION LIGHT
- FOG LIGHT
- HEADLIGHT
- HEATED SEAT
- IGNITION KEY REMINDER TONE ALARM
- METER AND GAUGE
- MITSUBISHI MULTI-COMMUNICATION SYSTEM (MMCS)
- SPARE CONNECTOR (FOR AUDIO)
- TAILLIGHT, POSITION LIGHT, REAR SIDE MARKER LIGHT, LICENSE PLATE LIGHT AND LIGHTING MONITOR TONE ALARM
- THEFT-ALARM SYSTEM
- TURN-SIGNAL LIGHT AND HAZARD WARNING LIGHT
- WINDSHIELD WIPER AND WASHER

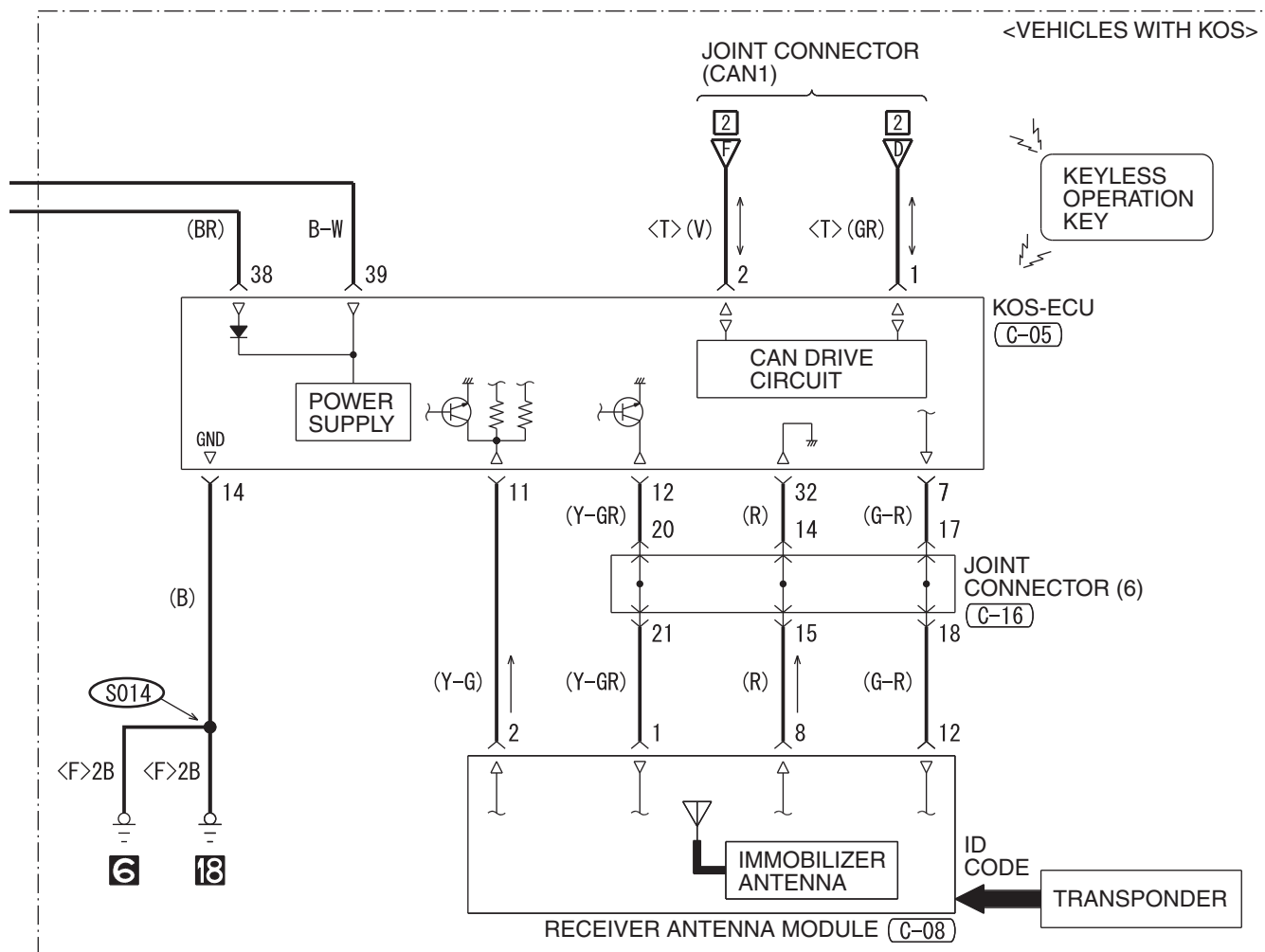

WIRE COLOR CODE

B: BLACK LG: LIGHT GREEN G: GREEN L: BLUE W: WHITE Y: YELLOW SB: SKY BLUE  
BR: BROWN O: ORANGE GR: GRAY R: RED P: PINK V: VIOLET PU: PURPLE SI: SILVER

# SUNROOF

1

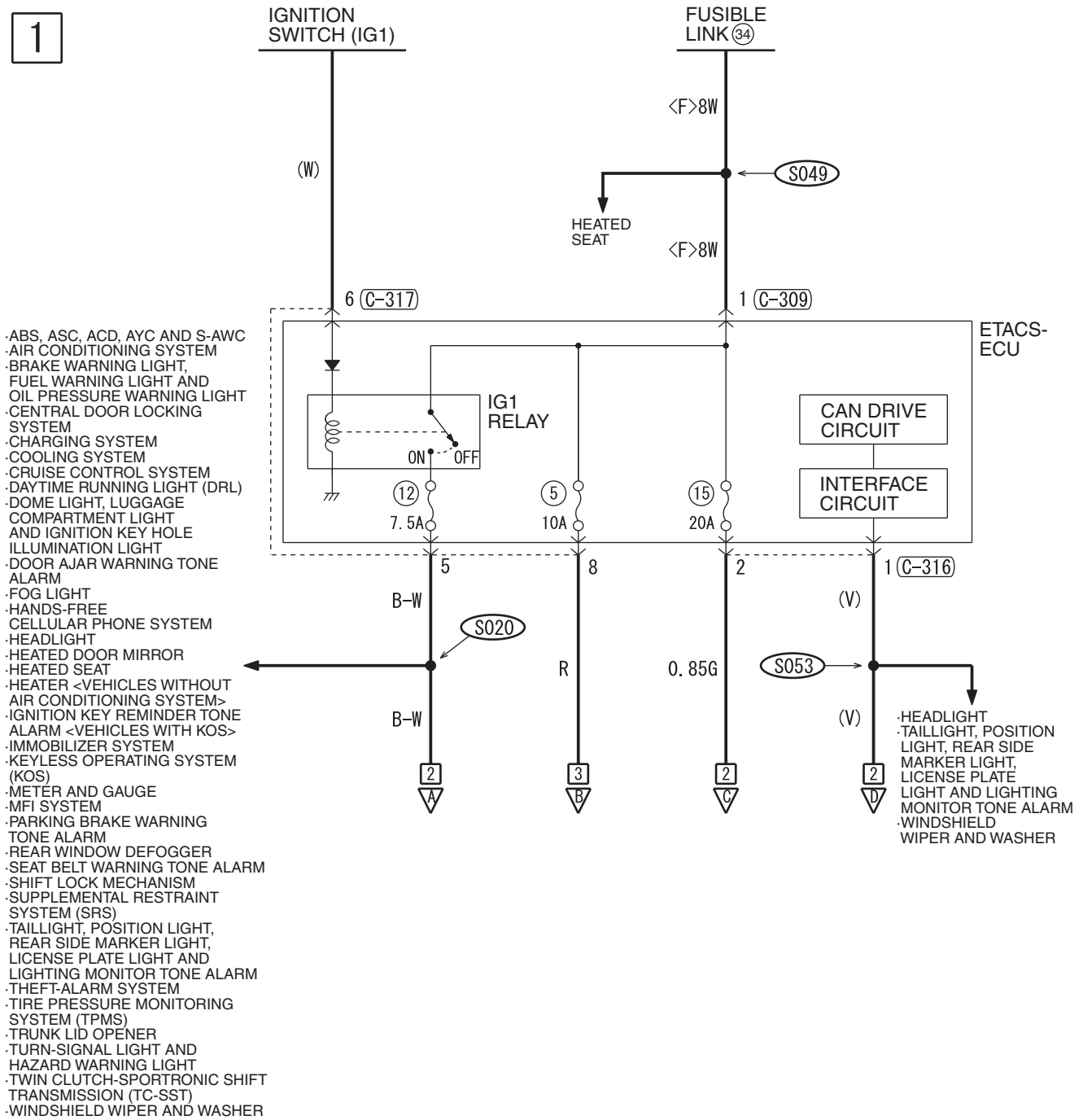

(C-133)



(C-309)



(C-316)



(C-317)

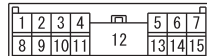

(D-05)

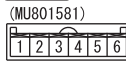

(D-06)



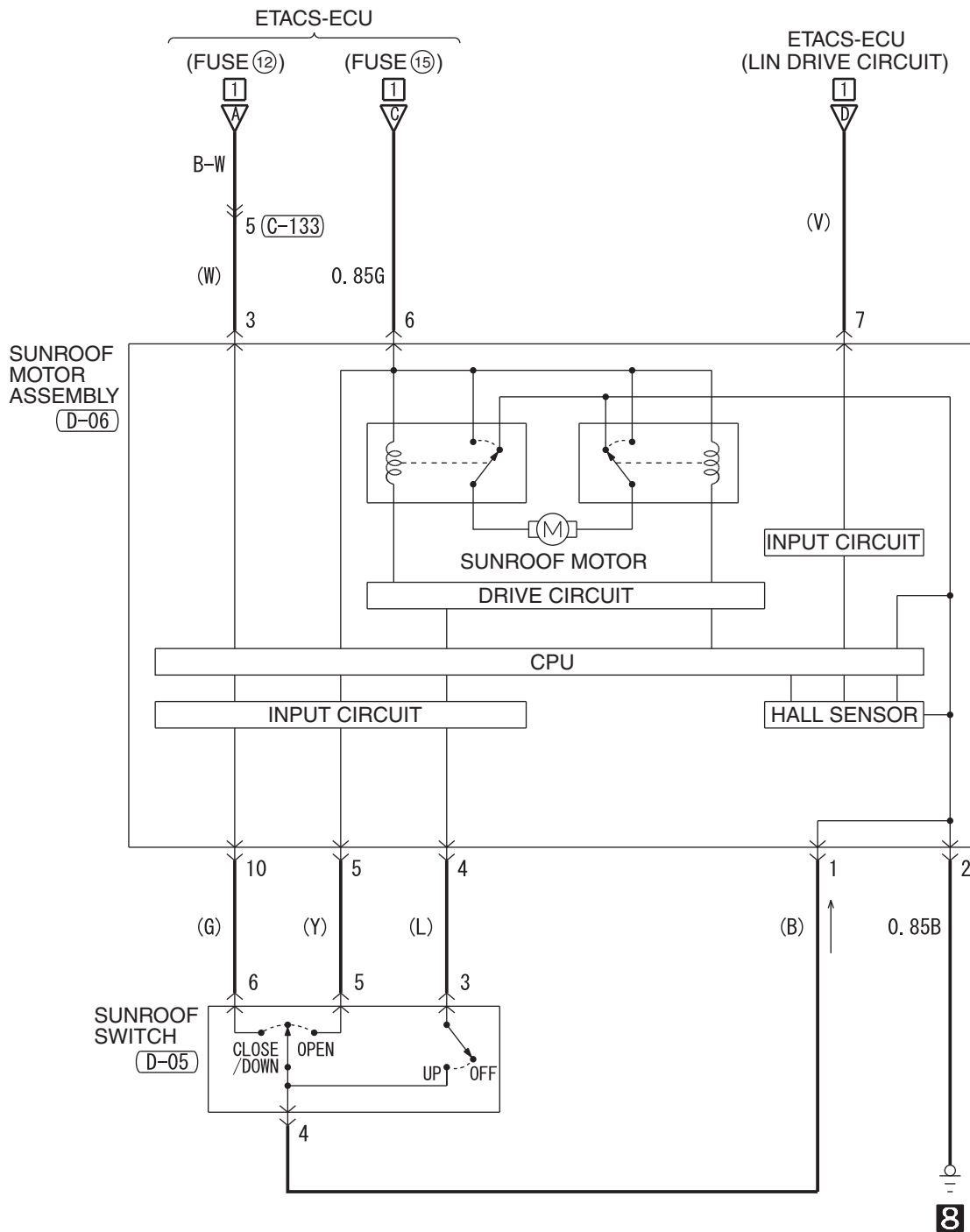

2

WIRE COLOR CODE  
 B: BLACK LG: LIGHT GREEN G: GREEN L: BLUE W: WHITE Y: YELLOW SB: SKY BLUE  
 BR: BROWN O: ORANGE GR: GRAY R: RED P: PINK V: VIOLET PU: PURPLE SI: SILVER

HAH15M28AB

TSB Revision



NOTES

# HEATED SEAT

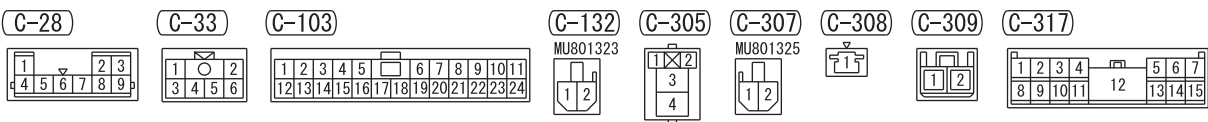
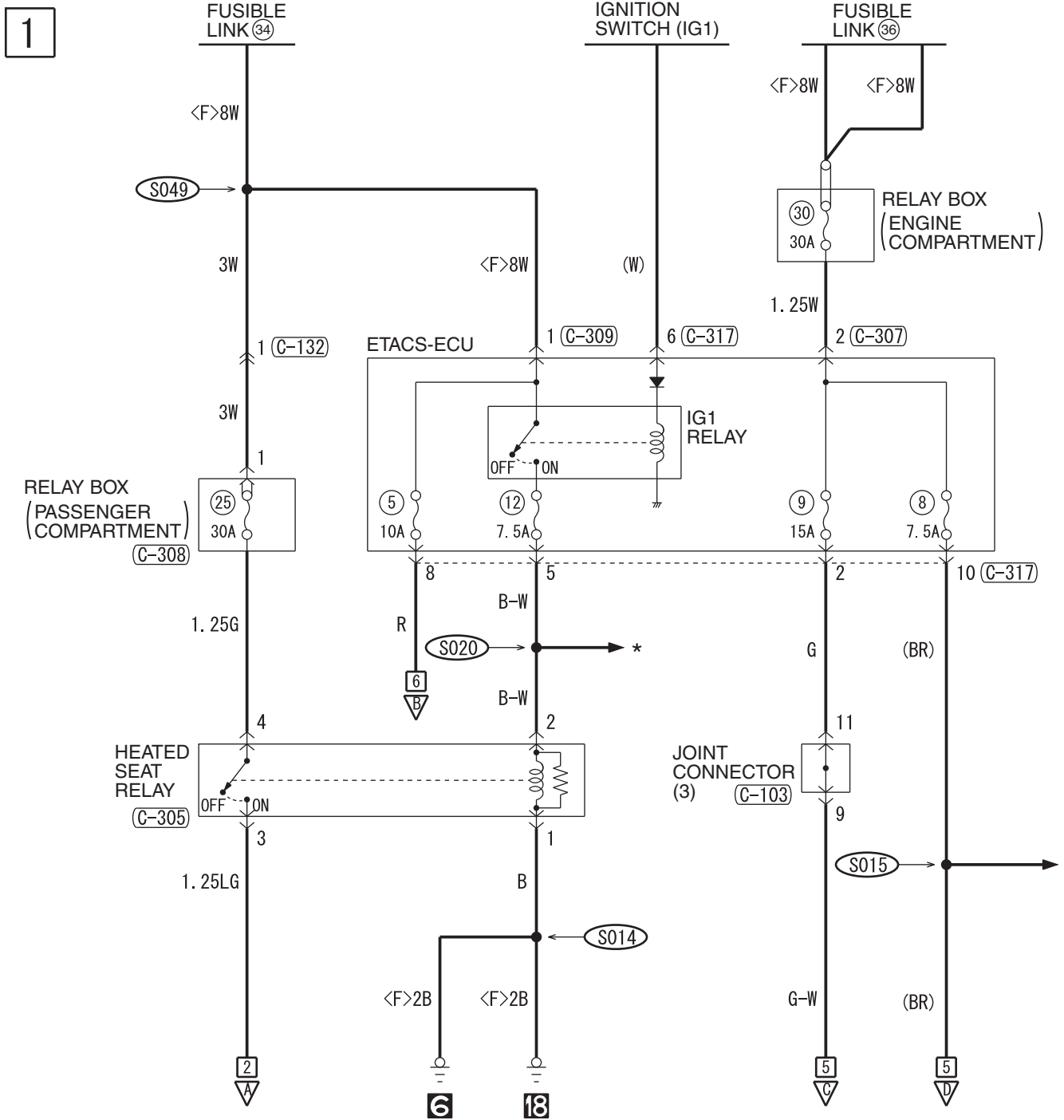

2

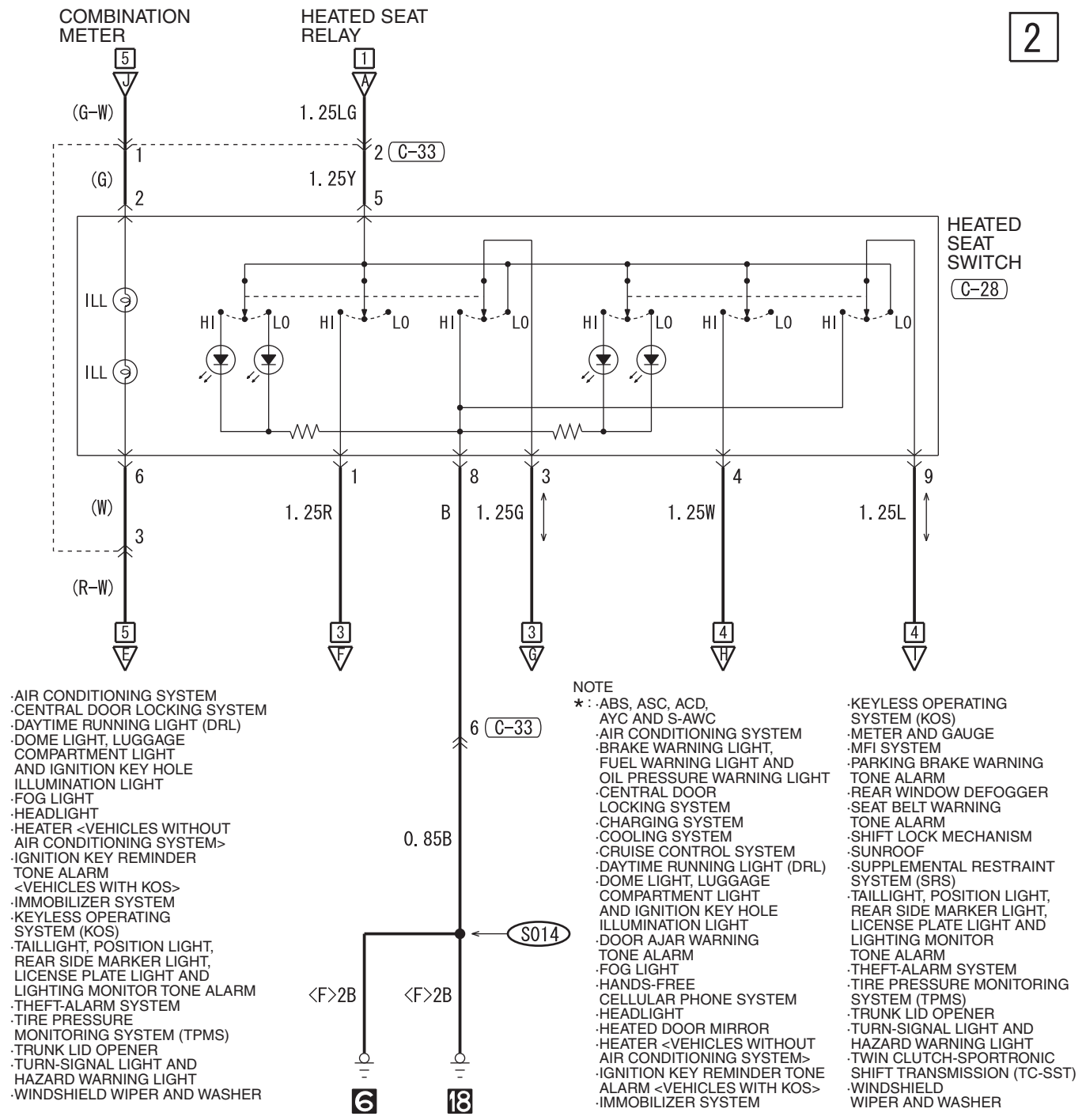

WIRE COLOR CODE  
B : BLACK LG : LIGHT GREEN G : GREEN L : BLUE W : WHITE Y : YELLOW SB : SKY BLUE  
BR : BROWN O : ORANGE GR : GRAY R : RED P : PINK V : VIOLET PU : PURPLE SI : SILVER

HAH15M29AB

HEATED SEAT (CONTINUED)

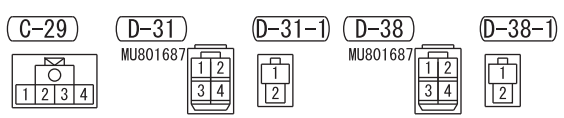
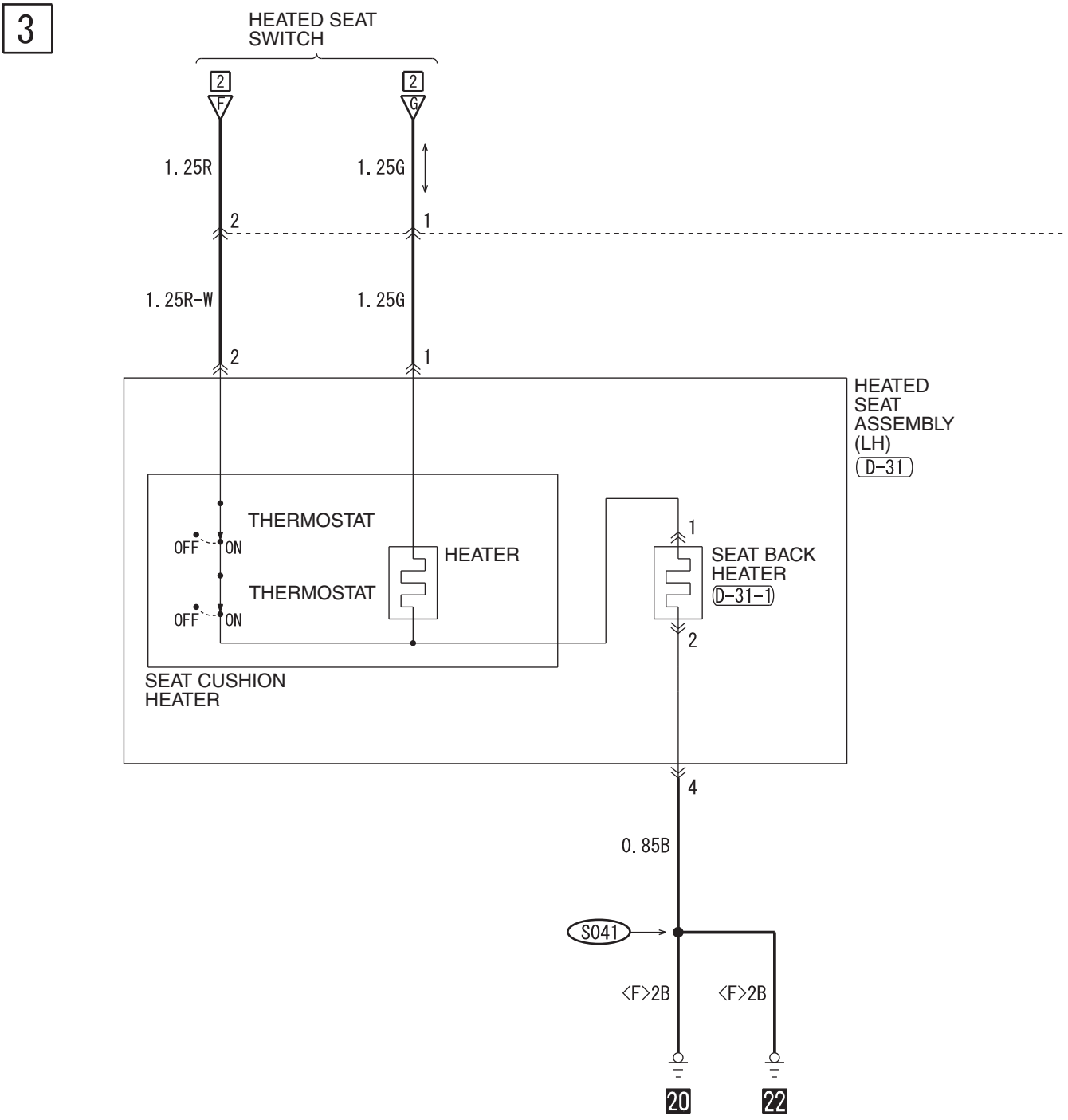



4

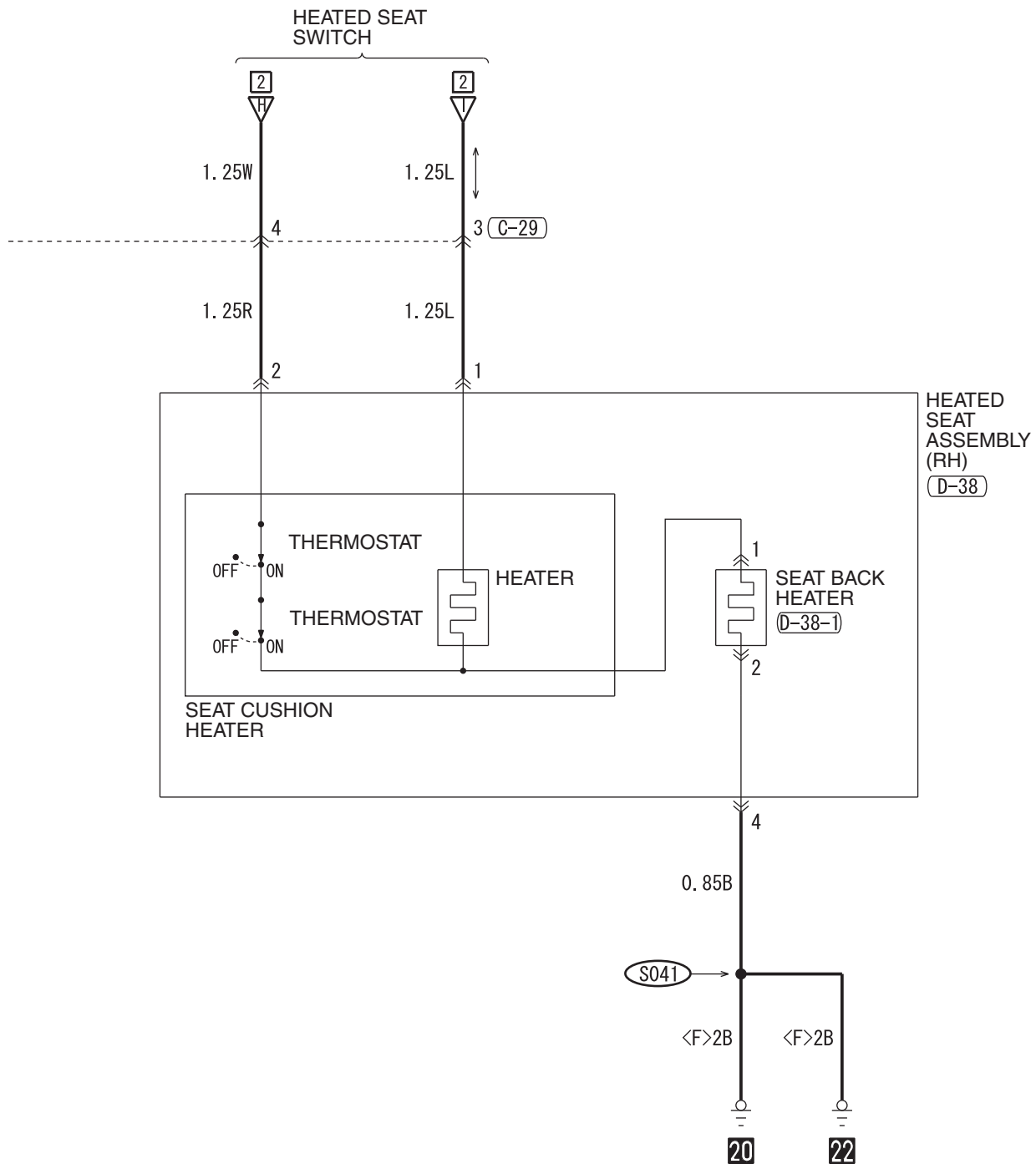

WIRE COLOR CODE

B: BLACK LG: LIGHT GREEN G: GREEN L: BLUE W: WHITE Y: YELLOW SB: SKY BLUE  
BR: BROWN O: ORANGE GR: GRAY R: RED P: PINK V: VIOLET PU: PURPLE SI: SILVER

HAH15M29BB

TSB Revision

HEATED SEAT (CONTINUED)

5

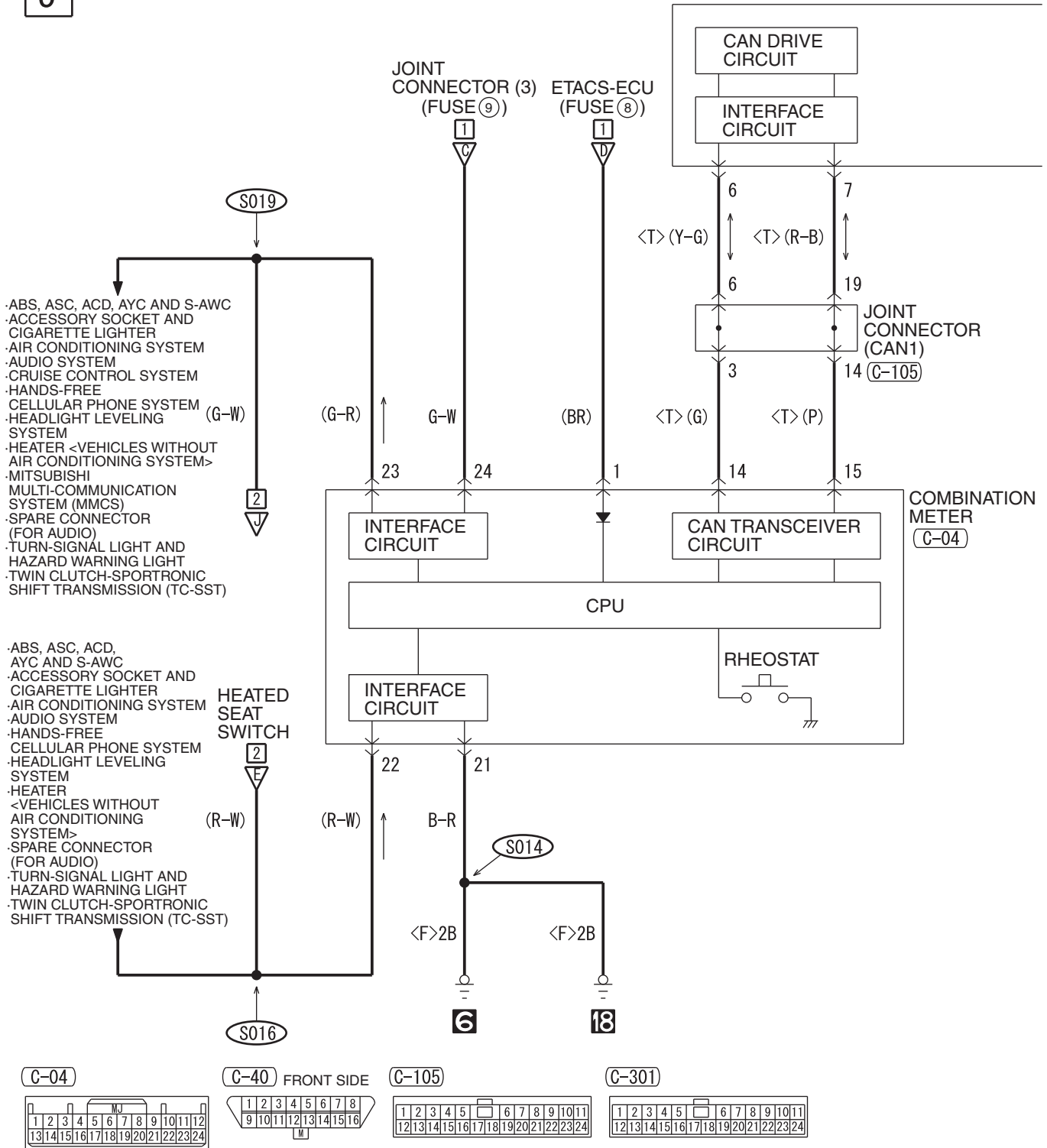

6

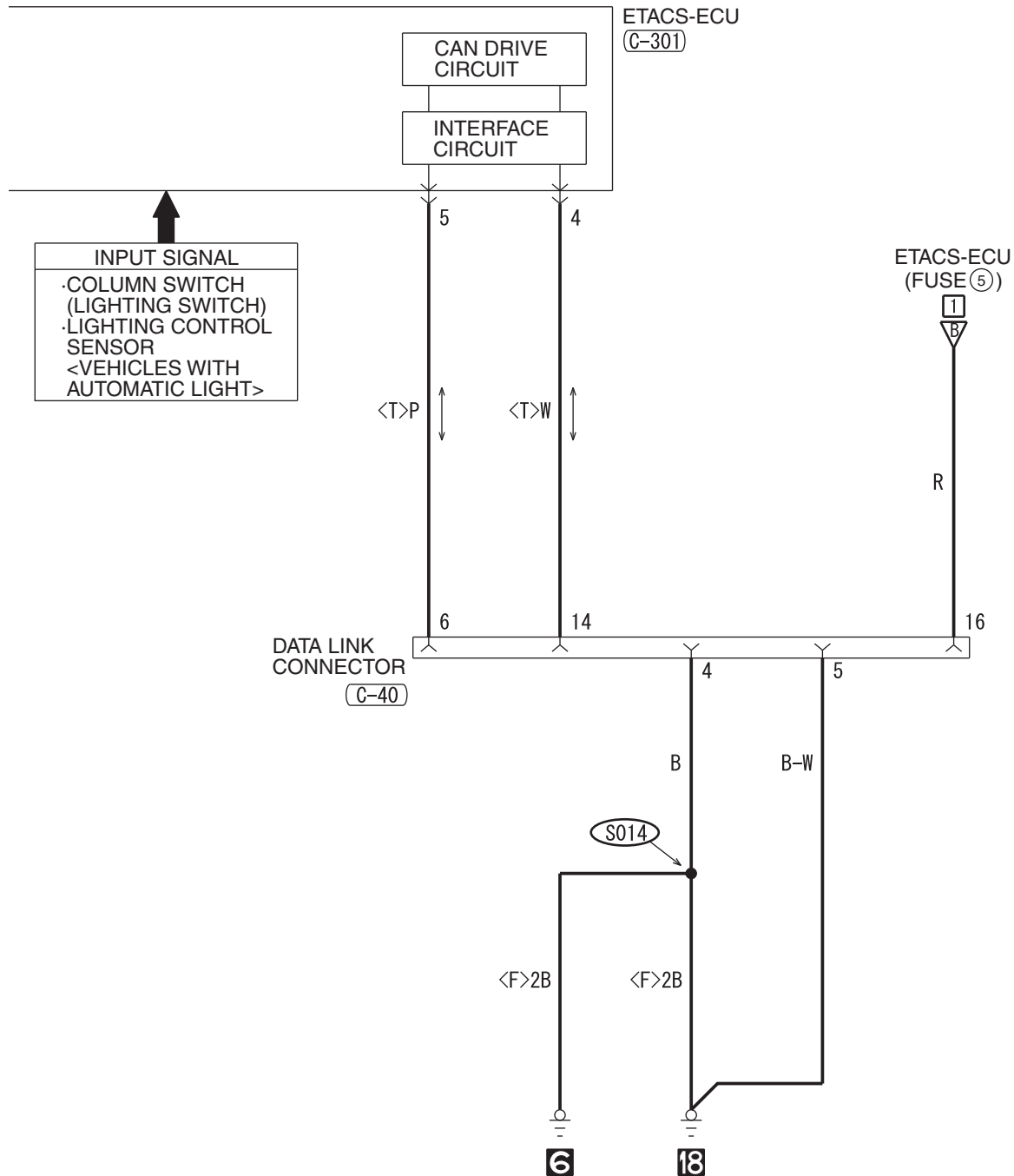

WIRE COLOR CODE

B: BLACK LG: LIGHT GREEN G: GREEN L: BLUE W: WHITE Y: YELLOW SB: SKY BLUE  
BR: BROWN O: ORANGE GR: GRAY R: RED P: PINK V: VIOLET PU: PURPLE SI: SILVER

HAH15M29CB

TSB Revision

# HANDS-FREE CELLULAR PHONE SYSTEM

M1901033200855

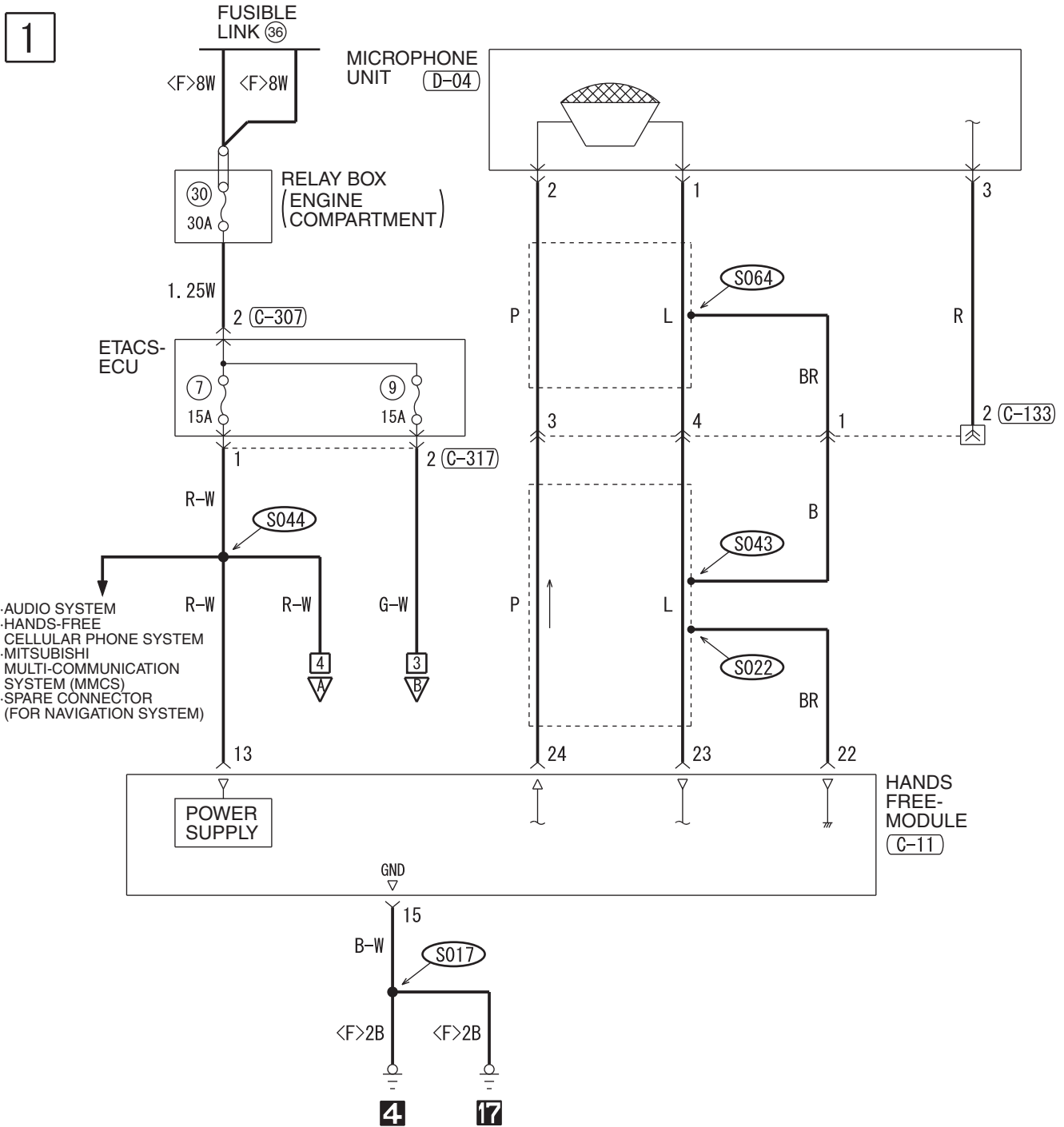

(A-05)

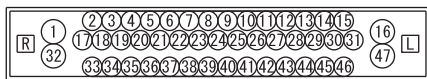

(C-11)

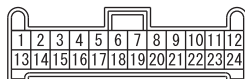

(C-104)

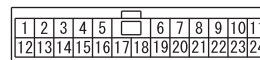

(C-105)

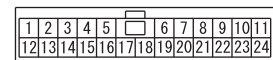

(C-317)

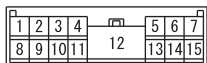

(D-04)



HAH15M30AA

2

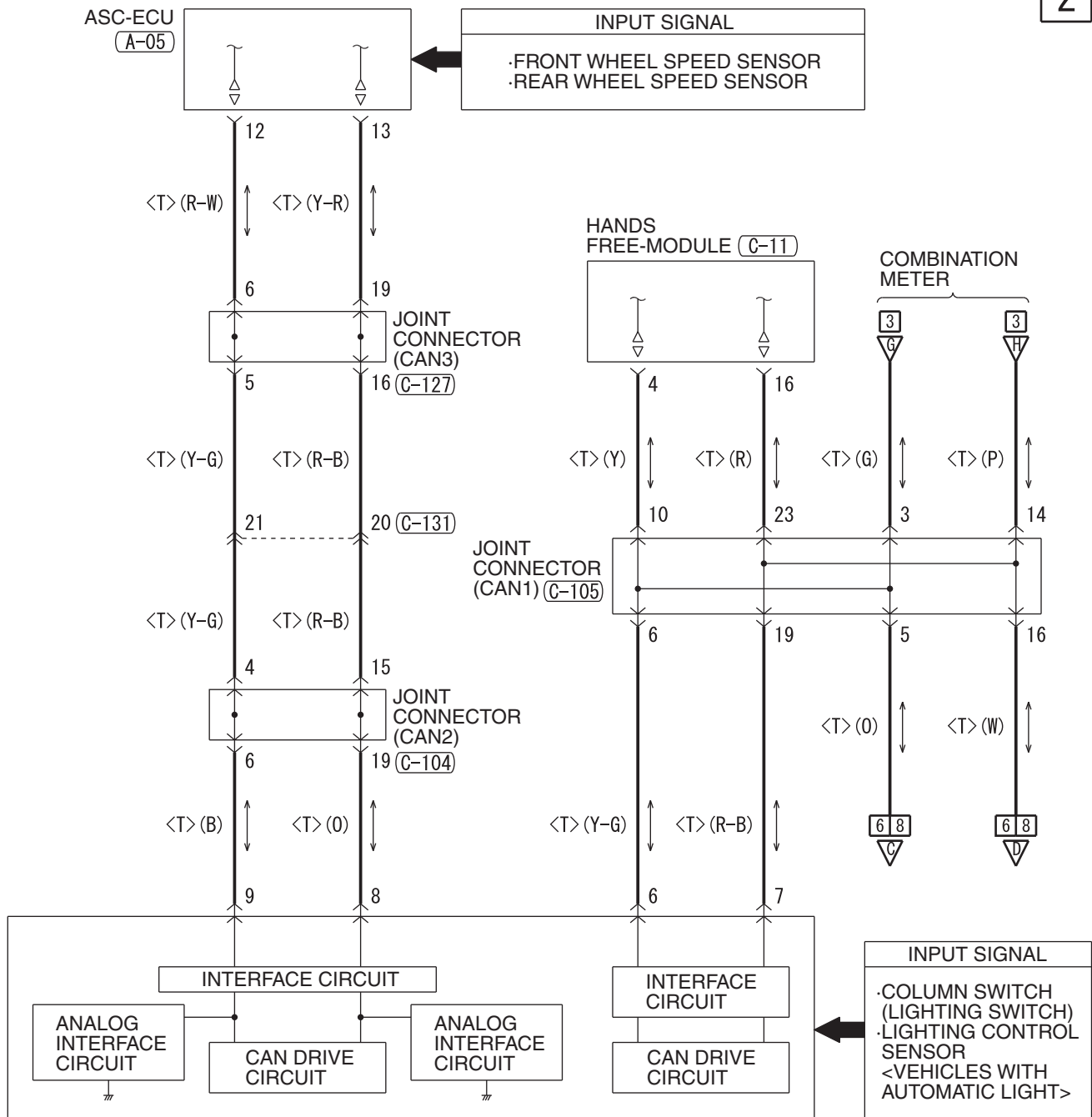

ETACS-ECU (C-301)

(C-127)

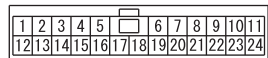

(C-131)

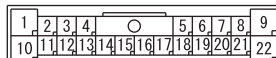

(C-133)

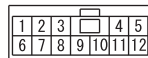

(C-301)

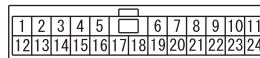

(C-307)



WIRE COLOR CODE  
B : BLACK LG : LIGHT GREEN G : GREEN L : BLUE W : WHITE Y : YELLOW SB : SKY BLUE  
BR : BROWN O : ORANGE GR : GRAY R : RED P : PINK V : VIOLET PU : PURPLE SI : SILVER

HAH15M30AB

HANDS-FREE CELLULAR PHONE SYSTEM (CONTINUED)

3

NOTE  
\*1: VEHICLES WITHOUT AIR  
CONDITIONING SYSTEM  
\*2: VEHICLES WITH AIR  
CONDITIONING SYSTEM

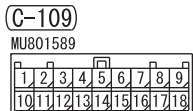
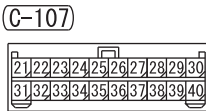
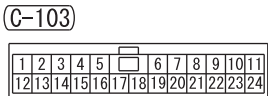
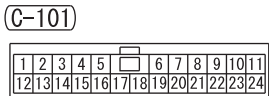
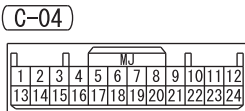
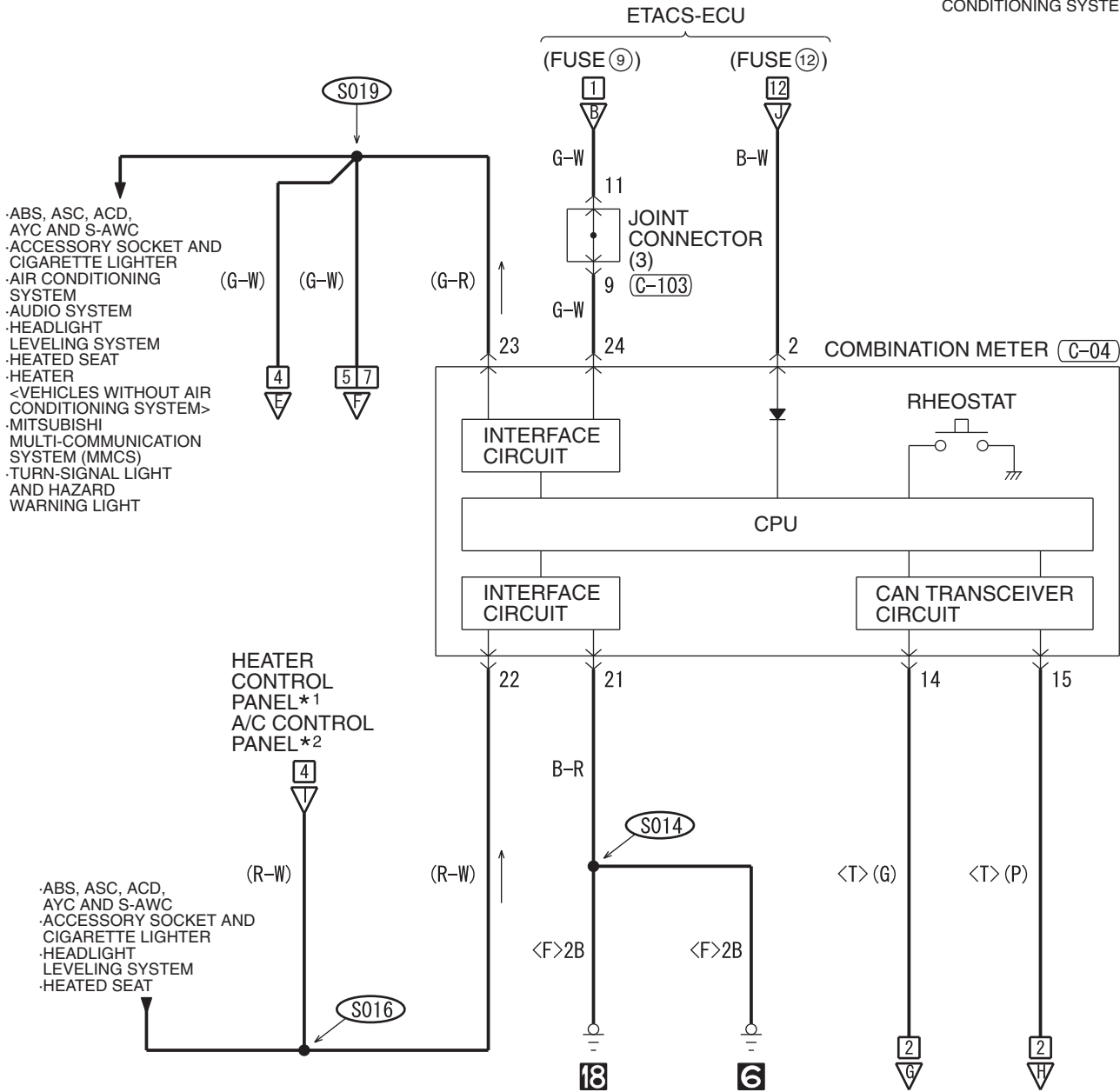

4

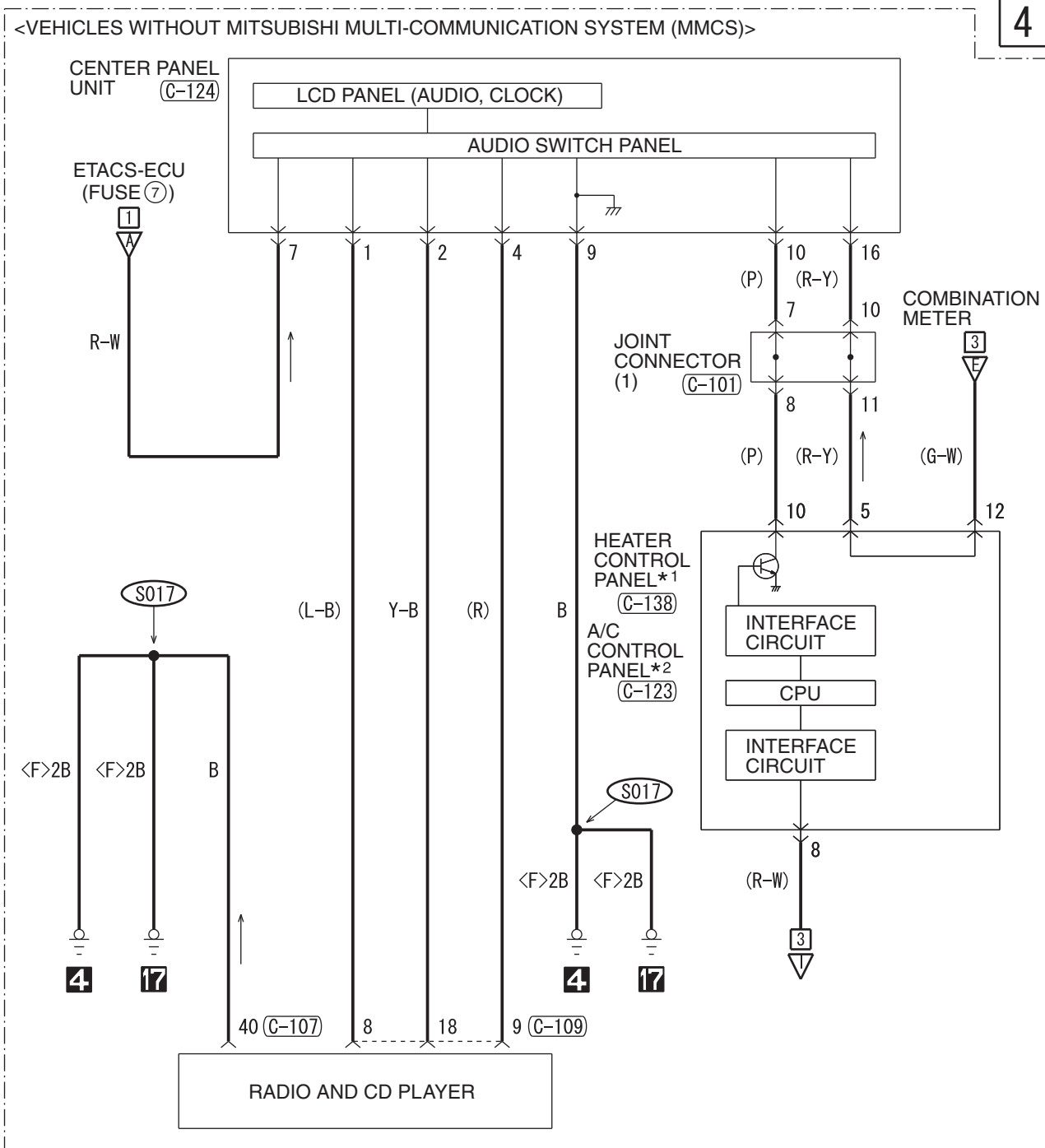

(C-123)

(C-124)

(C-138)

MJ					
1	2	3	4	5	6
7	8	9	10	11	12

MJ							
1	2	3	4	5	6	7	8
9	10	11	12	13	14	15	16

MJ					
1	2	3	4	5	6
7	8	9	10	11	12

WIRE COLOR CODE

B : BLACK LG : LIGHT GREEN G : GREEN L : BLUE W : WHITE Y : YELLOW SB : SKY BLUE  
BR : BROWN O : ORANGE GR : GRAY R : RED P : PINK V : VIOLET PU : PURPLE SI : SILVER

HAH15M30BB

HANDS-FREE CELLULAR PHONE SYSTEM (CONTINUED)

5

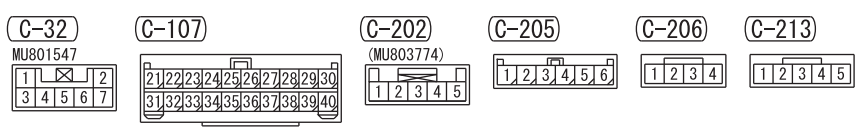
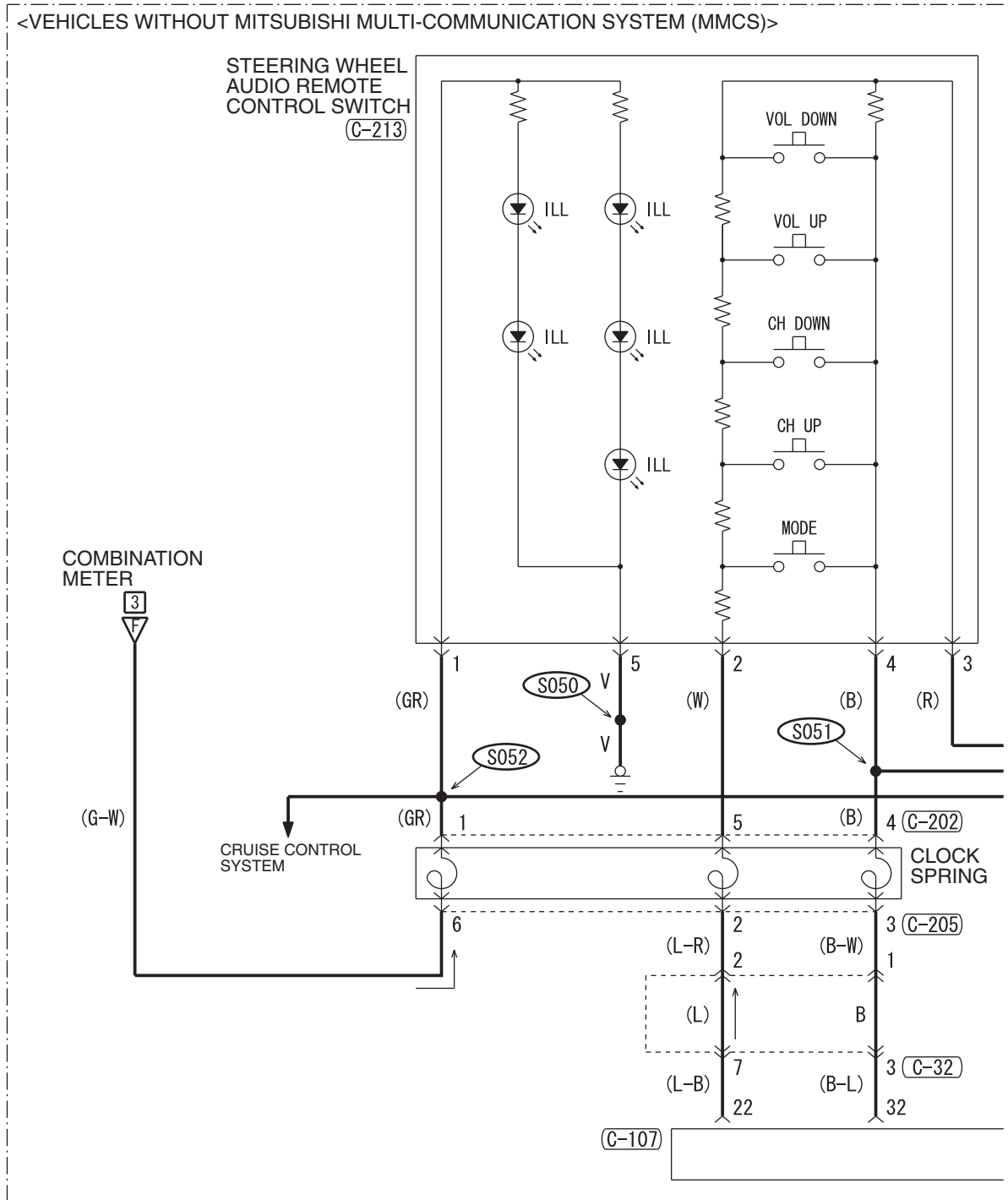



6

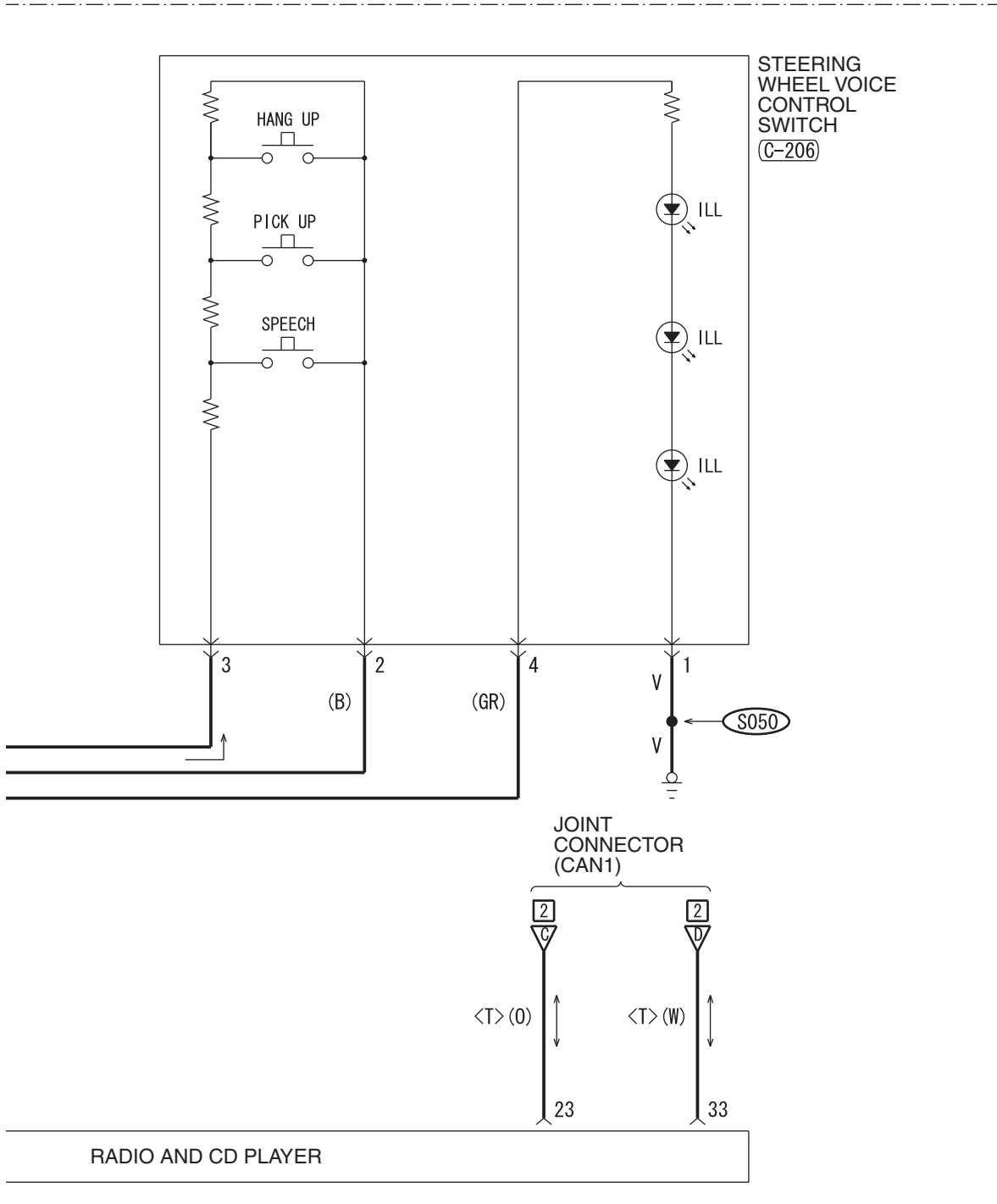

WIRE COLOR CODE  
 B : BLACK LG : LIGHT GREEN G : GREEN L : BLUE W : WHITE Y : YELLOW SB : SKY BLUE  
 BR : BROWN O : ORANGE GR : GRAY R : RED P : PINK V : VIOLET PU : PURPLE SI : SILVER

HAH15M30CB

HANDS-FREE CELLULAR PHONE SYSTEM (CONTINUED)

7

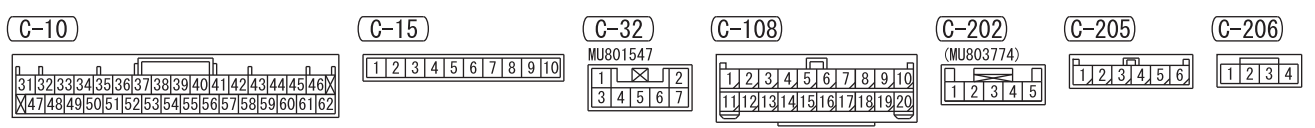
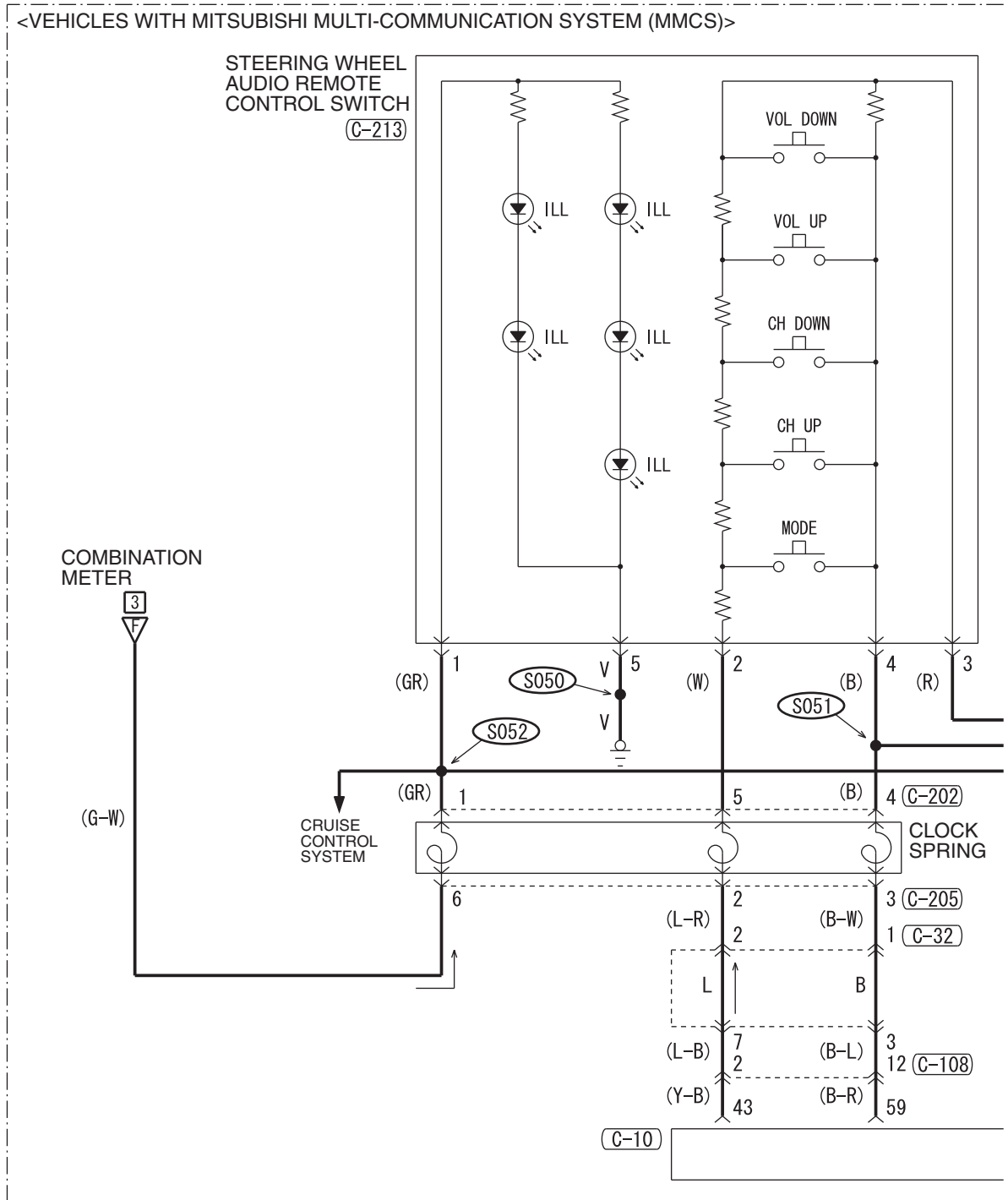

8

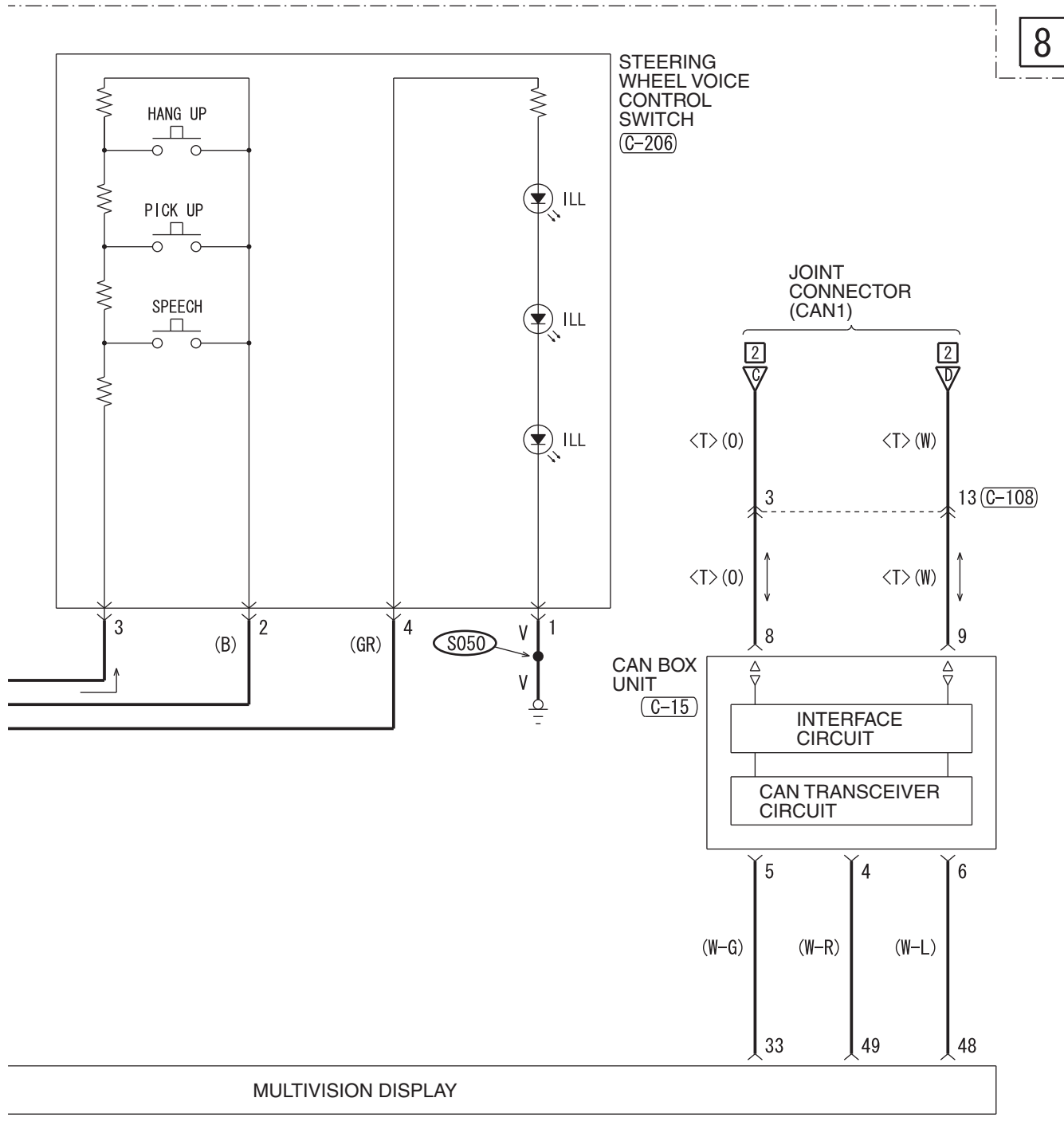

(C-213)

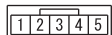

WIRE COLOR CODE  
 B: BLACK LG: LIGHT GREEN G: GREEN L: BLUE W: WHITE Y: YELLOW SB: SKY BLUE  
 BR: BROWN O: ORANGE GR: GRAY R: RED P: PINK V: VIOLET PU: PURPLE SI: SILVER

HAH15M30DB

HANDS-FREE CELLULAR PHONE SYSTEM (CONTINUED)

9

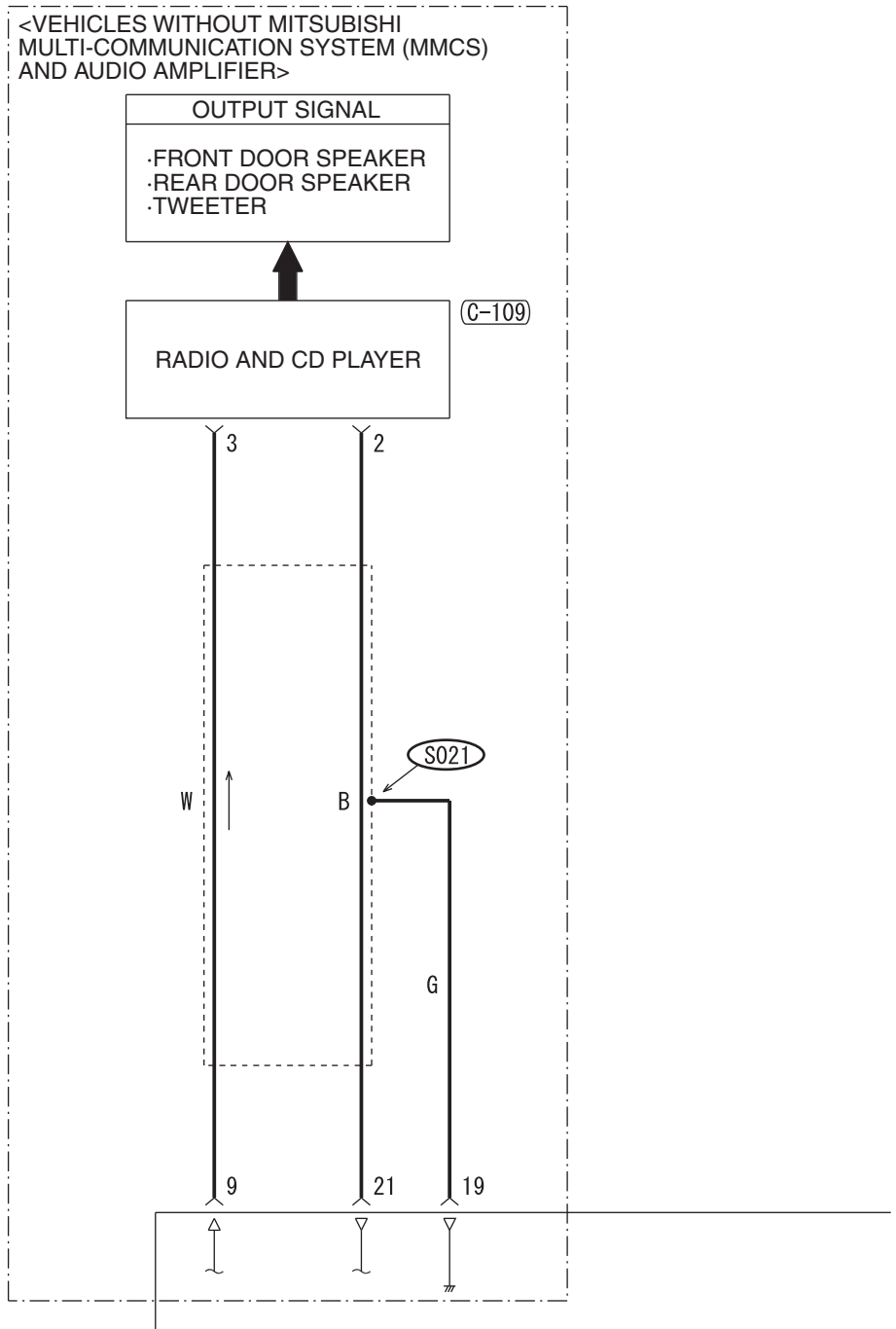

(C-11)

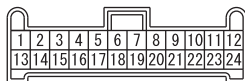

(C-24)

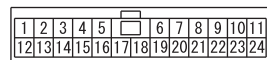

(C-107)

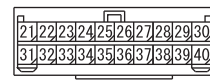

(C-109)

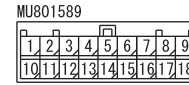

(D-29)

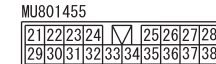

10

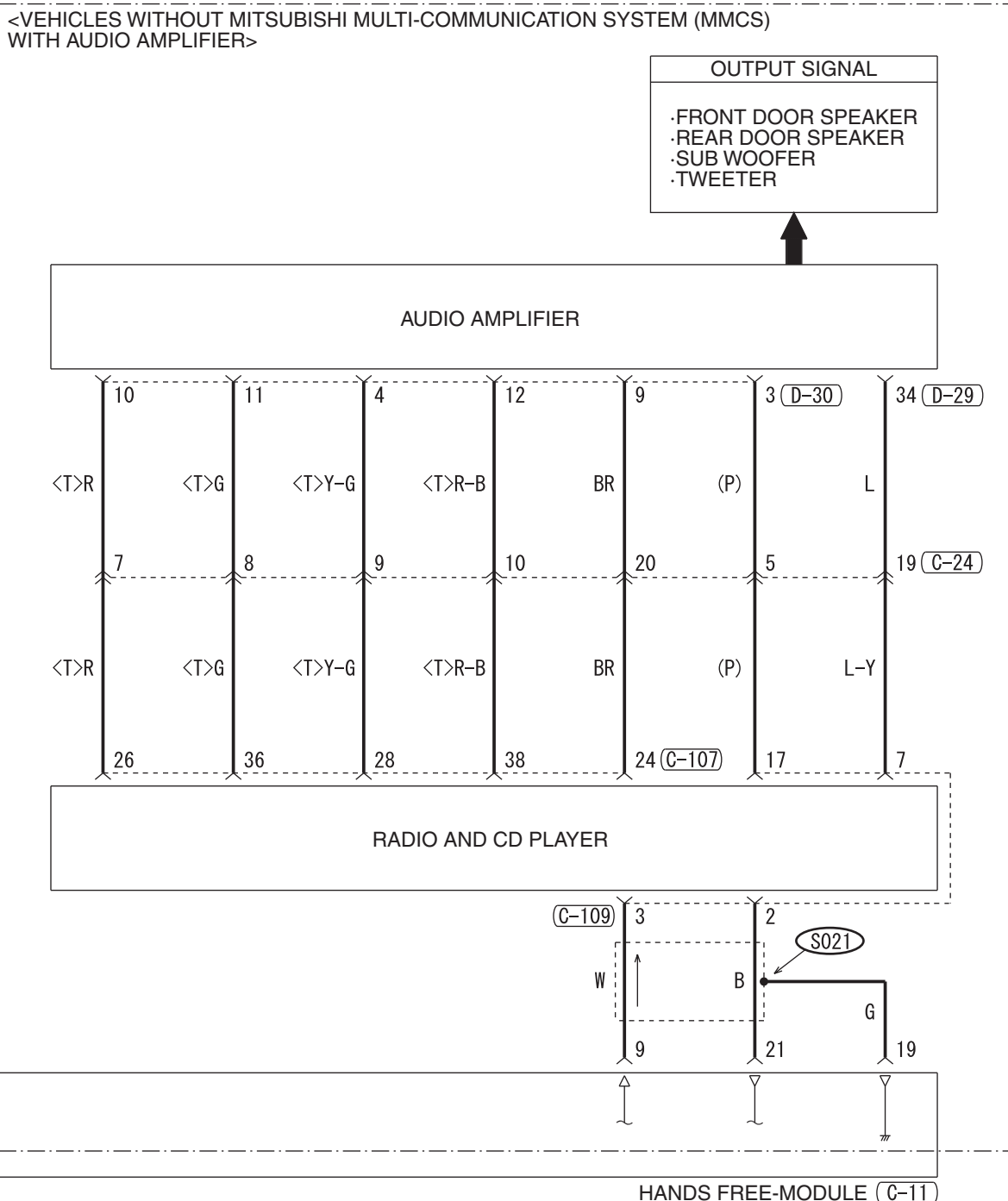

(D-30)

MU801453

1	2	3	4	5	6
7	8	9	10	11	12
13	14				

WIRE COLOR CODE

B: BLACK LG: LIGHT GREEN G: GREEN L: BLUE W: WHITE Y: YELLOW SB: SKY BLUE  
BR: BROWN O: ORANGE GR: GRAY R: RED P: PINK V: VIOLET PU: PURPLE SI: SILVER

HAH15M30EB

TSB Revision

HANDS-FREE CELLULAR PHONE SYSTEM (CONTINUED)

11

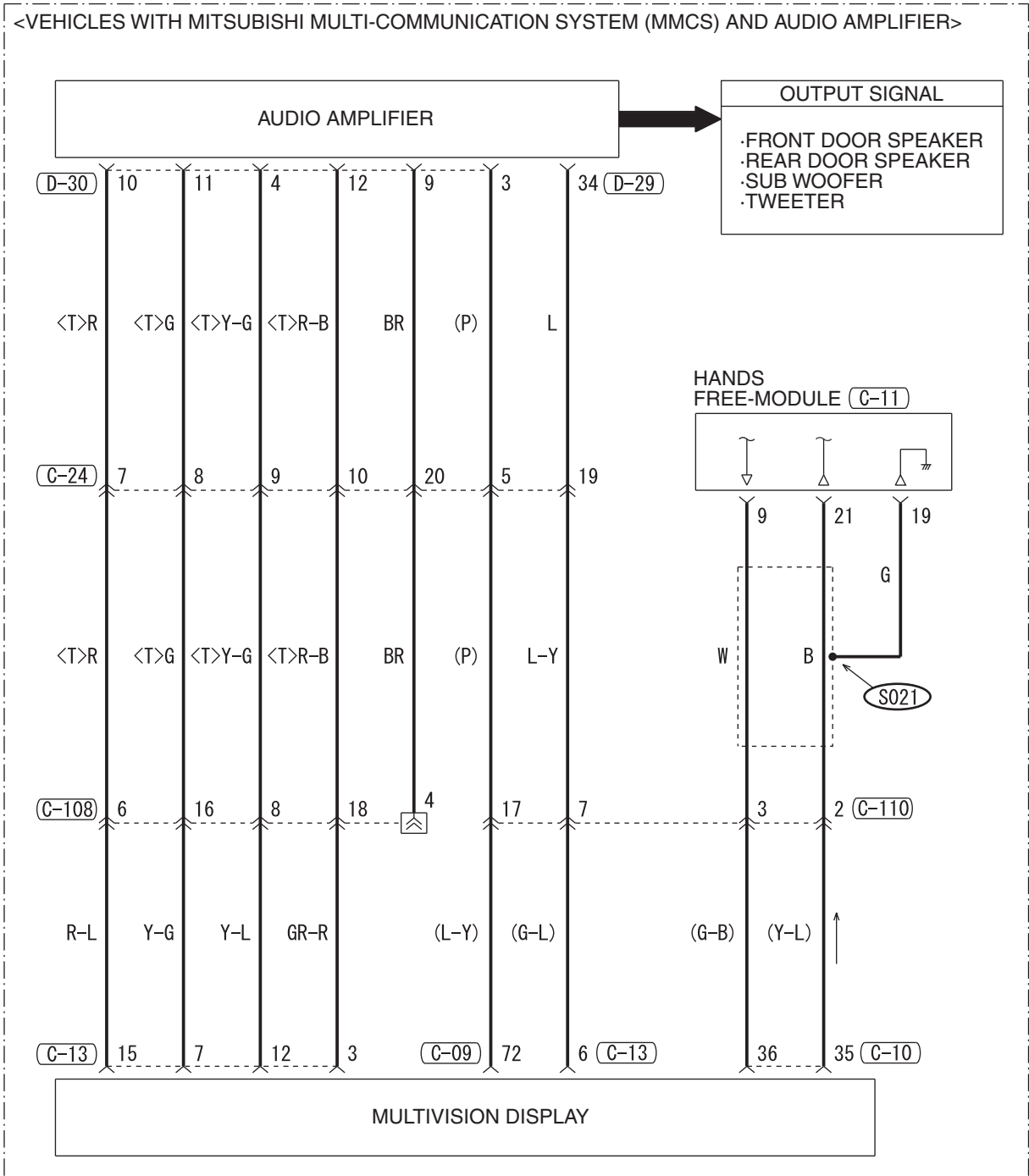

(C-09)

71	72	73	74	75	76	77
----	----	----	----	----	----	----

(C-10)

31	32	33	34	35	36	37	38	39	40	41	42	43	44	45	46	X
X	47	48	49	50	51	52	53	54	55	56	57	58	59	60	61	62

(C-11)

1	2	3	4	5	6	7	8	9	10	11	12
13	14	15	16	17	18	19	20	21	22	23	24

(C-13)

1	2	3	X	4	5	6	7	8	9		
X	10	11	12	X	13	14	X	15	16	17	X

(C-24)

1	2	3	4	5	6	7	8	9	10	11		
12	13	14	15	16	17	18	19	20	21	22	23	24

(D-29)

MU801455

21	22	23	24	M	25	26	27	28	
29	30	31	32	33	34	35	36	37	38

(D-30)

MU801453

1	2	3	M	4	5	6	
7	8	9	10	11	12	13	14

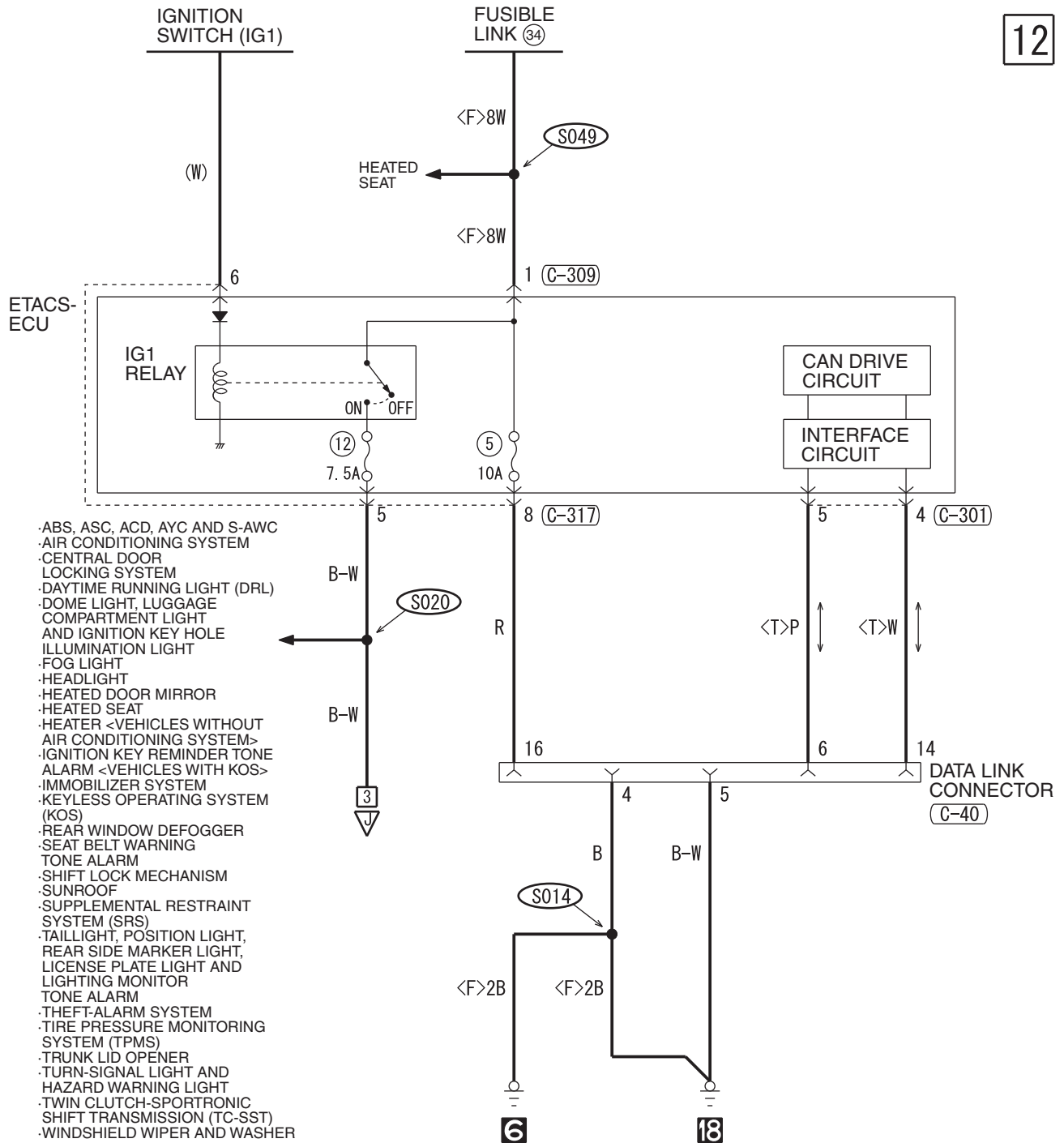

(C-40) FRONT SIDE

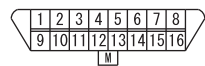

(C-108)

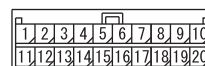

(C-110)

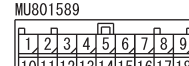

(C-301)

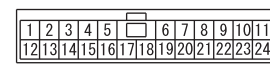

(C-309)



(C-317)

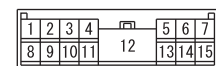

WIRE COLOR CODE

B: BLACK LG: LIGHT GREEN G: GREEN L: BLUE W: WHITE Y: YELLOW SB: SKY BLUE  
BR: BROWN O: ORANGE GR: GRAY R: RED P: PINK V: VIOLET PU: PURPLE SI: SILVER

# IGNITION KEY REMINDER TONE ALARM <VEHICLES WITHOUT KOS>

M1901011302311

1

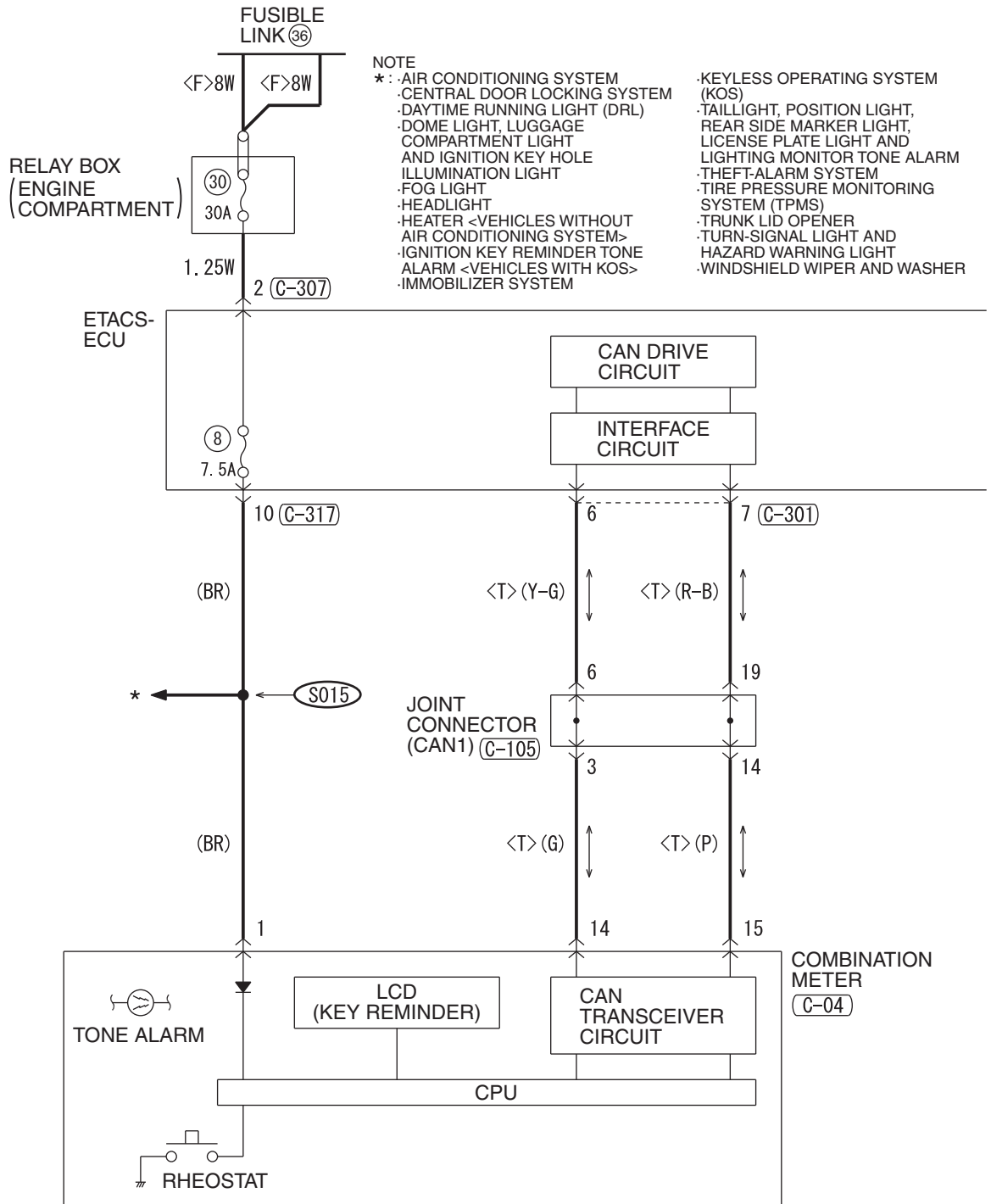

- NOTE
- \* : -AIR CONDITIONING SYSTEM
  - CENTRAL DOOR LOCKING SYSTEM
  - DAYTIME RUNNING LIGHT (DRL)
  - DOME LIGHT, LUGGAGE COMPARTMENT LIGHT AND IGNITION KEY HOLE ILLUMINATION LIGHT
  - FOG LIGHT
  - HEADLIGHT
  - HEATER <VEHICLES WITHOUT AIR CONDITIONING SYSTEM>
  - IGNITION KEY REMINDER TONE ALARM <VEHICLES WITH KOS>
  - IMMOBILIZER SYSTEM
  - KEYLESS OPERATING SYSTEM (KOS)
  - TAILLIGHT, POSITION LIGHT, REAR SIDE MARKER LIGHT, LICENSE PLATE LIGHT AND LIGHTING MONITOR TONE ALARM
  - THEFT-ALARM SYSTEM
  - TIRE PRESSURE MONITORING SYSTEM (TPMS)
  - TRUNK LID OPENER
  - TURN-SIGNAL LIGHT AND HAZARD WARNING LIGHT
  - WINDSHIELD WIPER AND WASHER

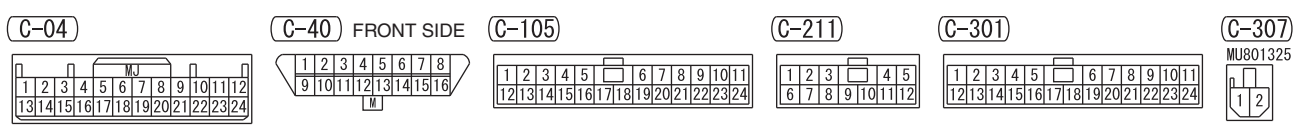



2

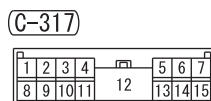
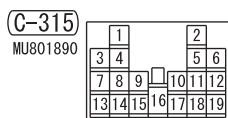
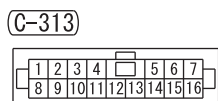
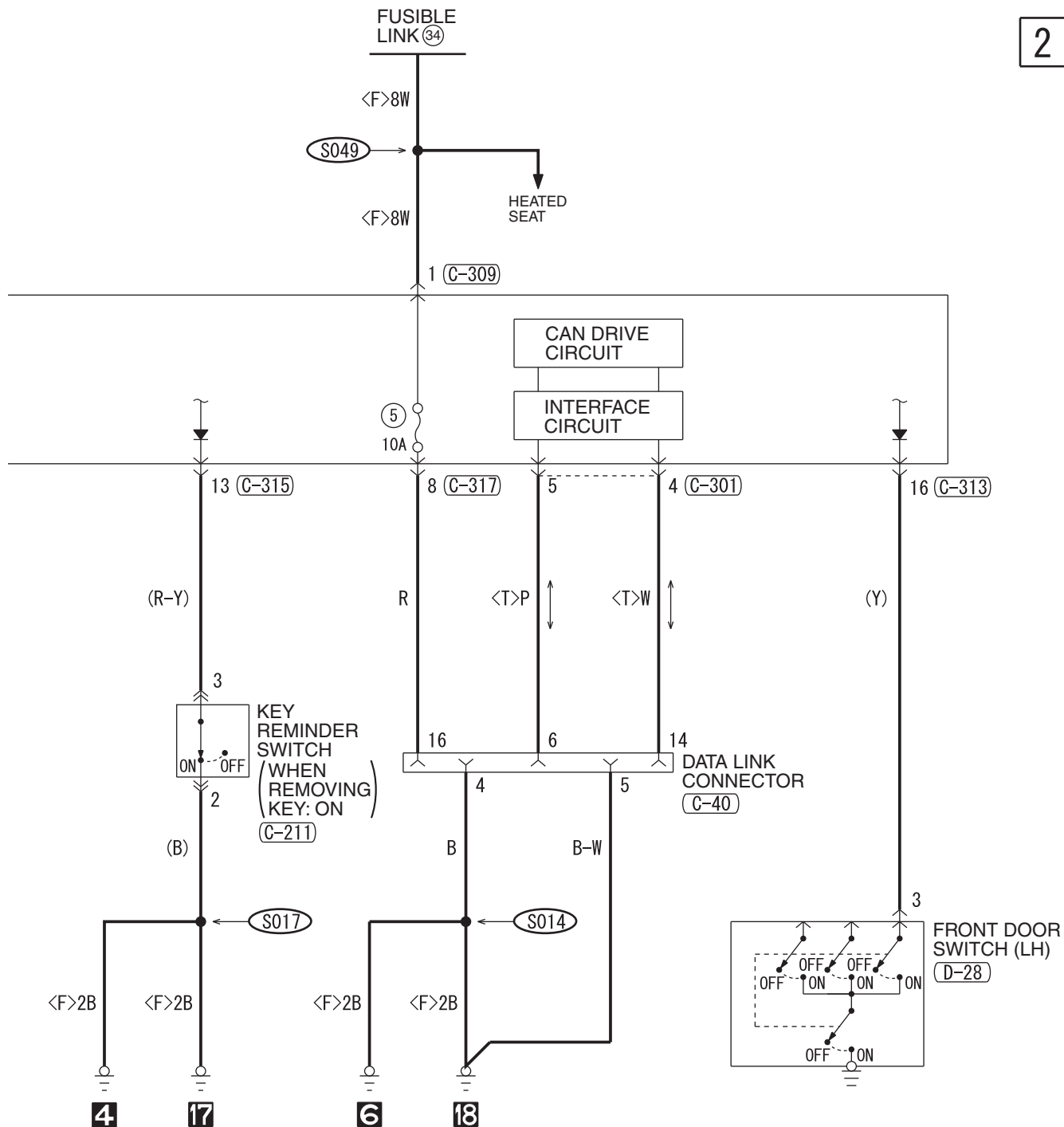

WIRE COLOR CODE  
B : BLACK LG : LIGHT GREEN G : GREEN L : BLUE W : WHITE Y : YELLOW SB : SKY BLUE  
BR : BROWN O : ORANGE GR : GRAY R : RED P : PINK V : VIOLET PU : PURPLE SI : SILVER

HAH15M31AB

# IGNITION KEY REMINDER TONE ALARM <VEHICLES WITH KOS>

M1901011302322

1

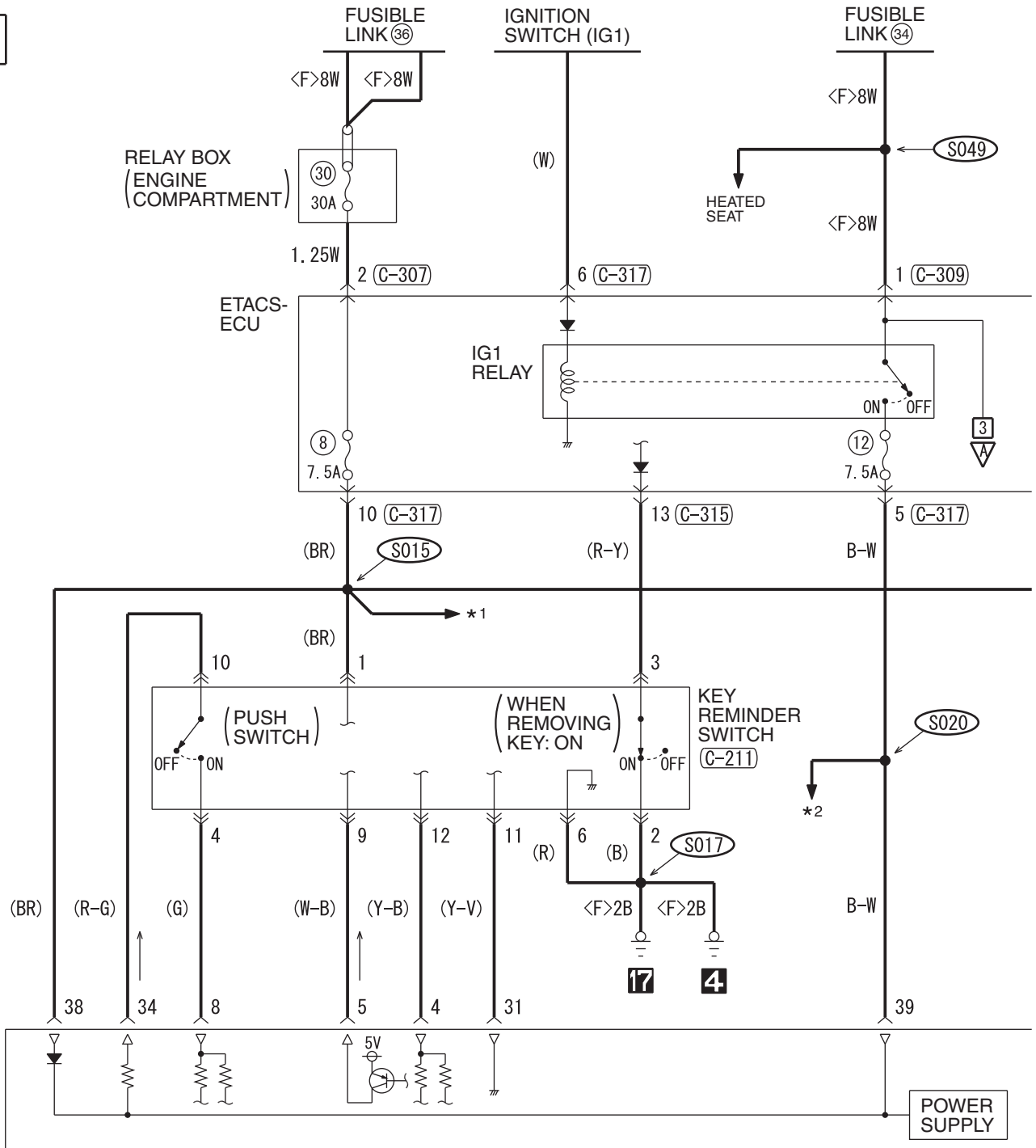

C-04

1	2	3	4	5	6	7	8	9	10	11	12
13	14	15	16	17	18	19	20	21	22	23	24

C-05

1	2	3	4	5	6	7	8	9	10	11	12	13	14	15	16	17	18	19	20
21	22	23	24	25	26	27	28	29	30	31	32	33	34	35	36	37	38	39	40

C-105

1	2	3	4	5	6	7	8	9	10	11		
12	13	14	15	16	17	18	19	20	21	22	23	24

C-211

1	2	3	4	5		
6	7	8	9	10	11	12

2

**NOTE**

- \*1 :**
- AIR CONDITIONING SYSTEM
  - CENTRAL DOOR LOCKING SYSTEM
  - DAYTIME RUNNING LIGHT (DRL)
  - DOME LIGHT, LUGGAGE COMPARTMENT LIGHT AND IGNITION KEY HOLE ILLUMINATION LIGHT
  - FOG LIGHT
  - HEADLIGHT
  - IMMOBILIZER SYSTEM
  - TAILLIGHT, POSITION LIGHT, REAR SIDE MARKER LIGHT, LICENSE PLATE LIGHT AND LIGHTING MONITOR TONE ALARM
  - THEFT-ALARM SYSTEM
  - TIRE PRESSURE MONITORING SYSTEM (TPMS)
  - TRUNK LID OPENER
  - TURN-SIGNAL LIGHT AND HAZARD WARNING LIGHT
  - WINDSHIELD WIPER AND WASHER

- \*2 :**
- ABS, ASC, ACD, AYC AND S-AWC
  - AIR CONDITIONING SYSTEM
  - BRAKE WARNING LIGHT, FUEL WARNING LIGHT AND OIL PRESSURE WARNING LIGHT
  - CENTRAL DOOR LOCKING SYSTEM
  - CHARGING SYSTEM
  - COOLING SYSTEM
  - CRUISE CONTROL SYSTEM
  - DAYTIME RUNNING LIGHT (DRL)
  - DOME LIGHT, LUGGAGE COMPARTMENT LIGHT AND IGNITION KEY HOLE ILLUMINATION LIGHT
  - DOOR AJAR WARNING TONE ALARM
  - FOG LIGHT
  - HANDS-FREE CELLULAR PHONE SYSTEM
  - HEADLIGHT
  - HEATED DOOR MIRROR
  - HEATED SEAT
  - IMMOBILIZER SYSTEM
  - METER AND GAUGE
  - MFI SYSTEM
  - PARKING BRAKE REMINDER TONE ALARM
  - REAR WINDOW DEFOGGER
  - SEAT BELT WARNING TONE ALARM
  - SHIFT LOCK MECHANISM
  - SUNROOF
  - SUPPLEMENTAL RESTRAINT SYSTEM (SRS)
  - TAILLIGHT, POSITION LIGHT, REAR SIDE MARKER LIGHT, LICENSE PLATE LIGHT AND LIGHTING MONITOR TONE ALARM
  - THEFT-ALARM SYSTEM
  - TIRE PRESSURE MONITORING SYSTEM (TPMS)
  - TRUNK LID OPENER
  - TURN-SIGNAL LIGHT AND HAZARD WARNING LIGHT
  - TWIN CLUTCH-SPORTRONIC SHIFT TRANSMISSION (TC-SST)
  - WINDSHIELD WIPER AND WASHER

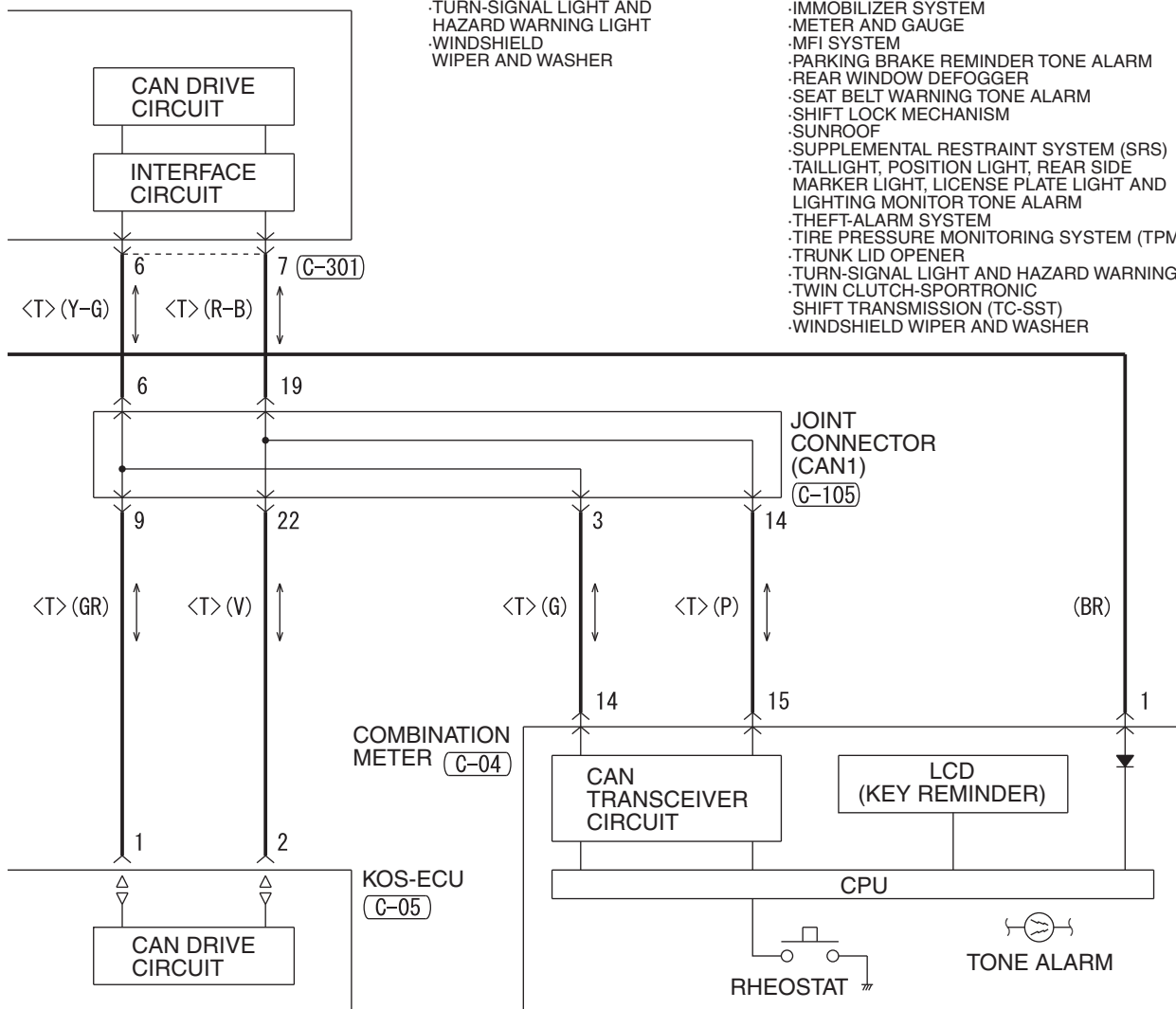

(C-301)

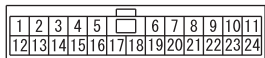

(C-307)



(C-309)



(C-315)



(C-317)

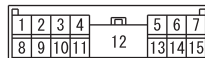

**WIRE COLOR CODE**

B : BLACK   LG : LIGHT GREEN   G : GREEN   L : BLUE   W : WHITE   Y : YELLOW   SB : SKY BLUE  
 BR : BROWN   O : ORANGE   GR : GRAY   R : RED   P : PINK   V : VIOLET   PU : PURPLE   SI : SILVER

IGNITION KEY REMINDER TONE ALARM <VEHICLES WITH KOS> (CONTINUED)

3

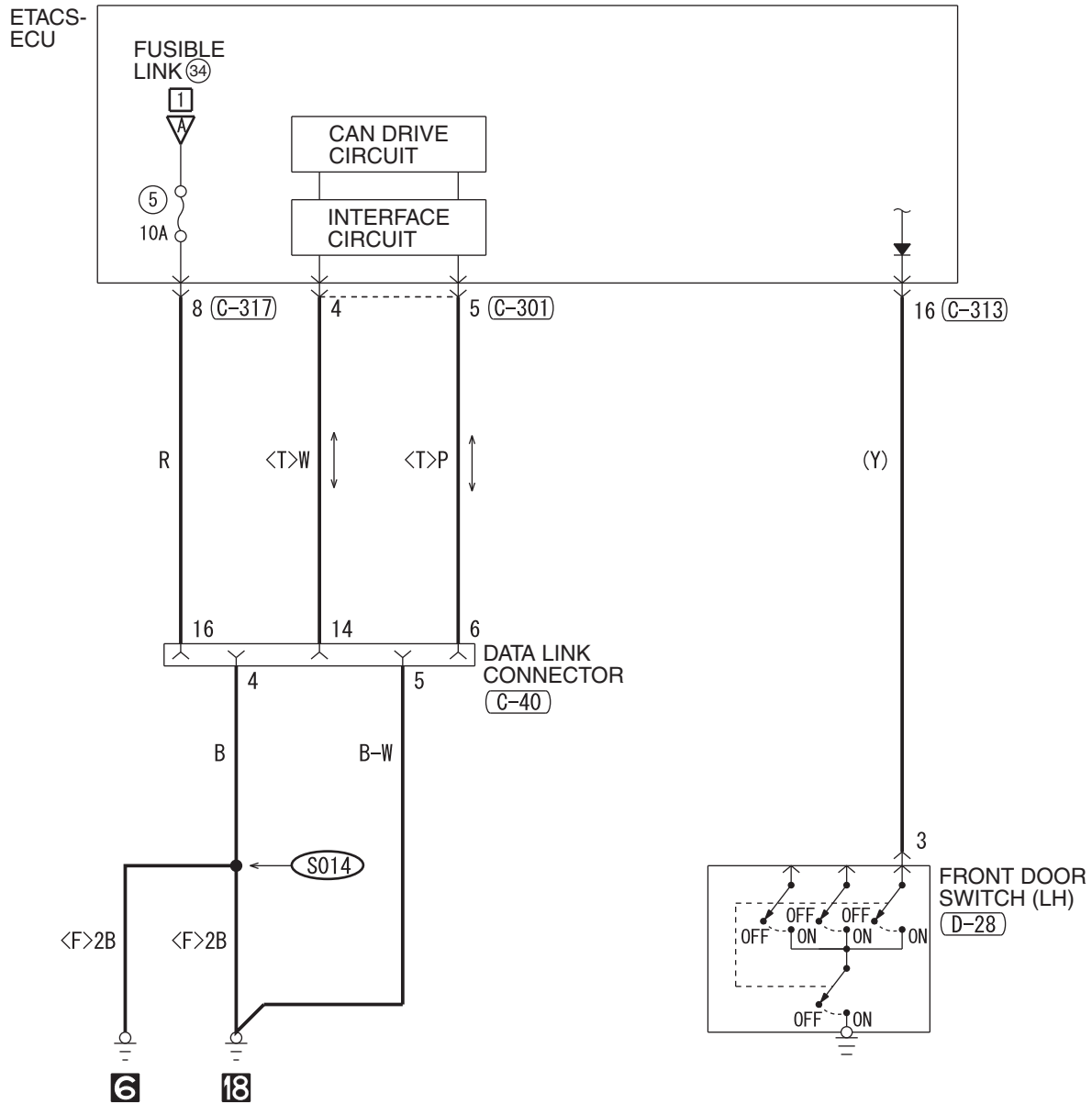

(C-40) FRONT SIDE

(C-301)

(C-313)

(C-317)

(D-28)

(MU801536)

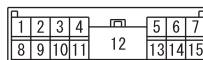
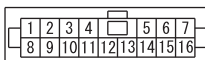
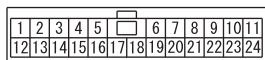

WIRE COLOR CODE

B: BLACK LG: LIGHT GREEN G: GREEN L: BLUE W: WHITE Y: YELLOW SB: SKY BLUE  
BR: BROWN O: ORANGE GR: GRAY R: RED P: PINK V: VIOLET PU: PURPLE SI: SILVER

NOTES

# SEAT BELT WARNING TONE ALARM

M1901011202132

1

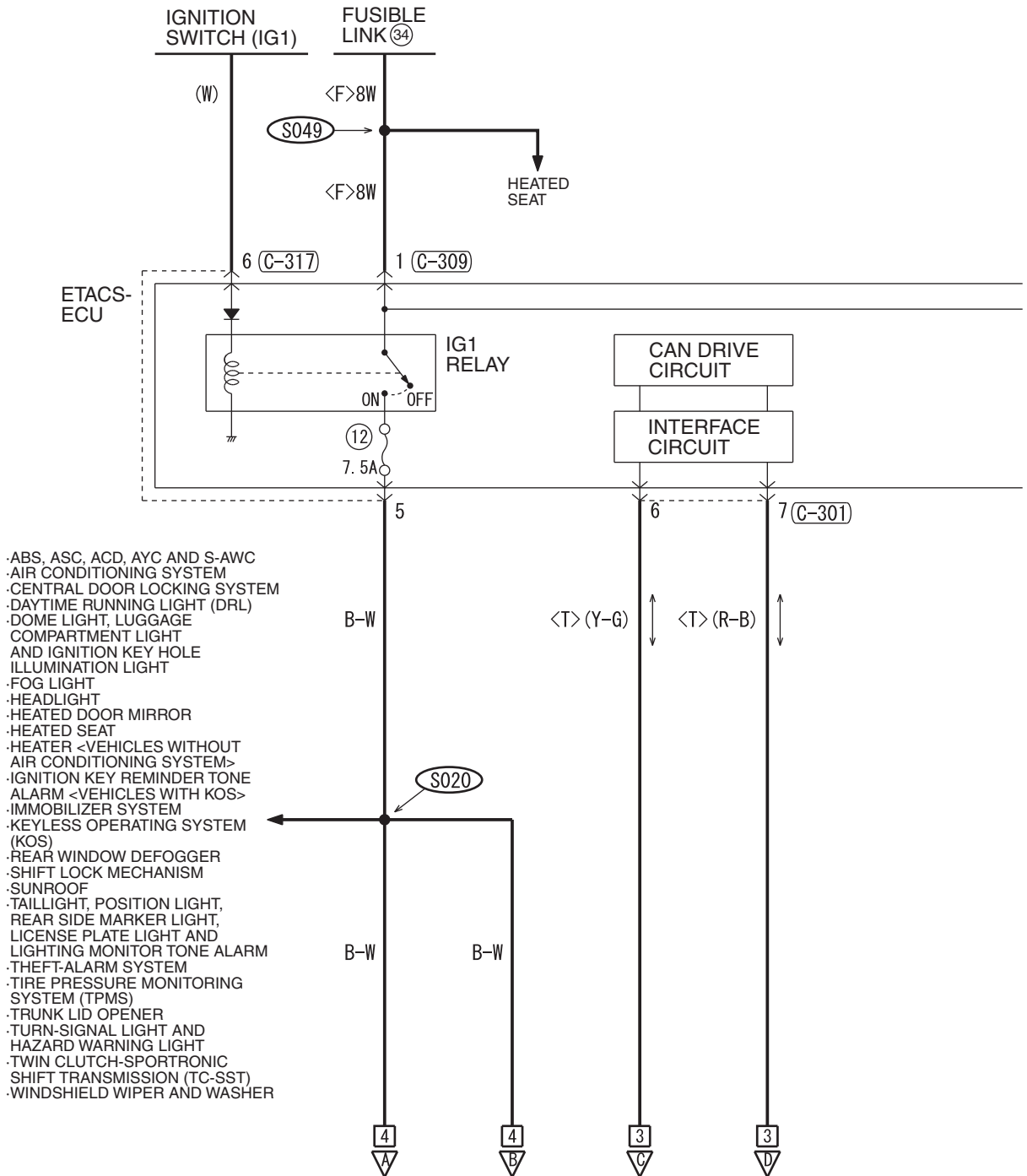

(A-05)

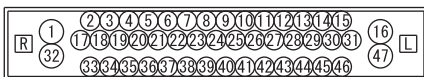

(C-40) FRONT SIDE



(C-104)

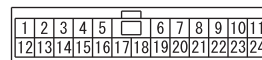

(C-127)

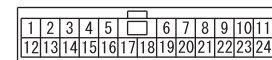

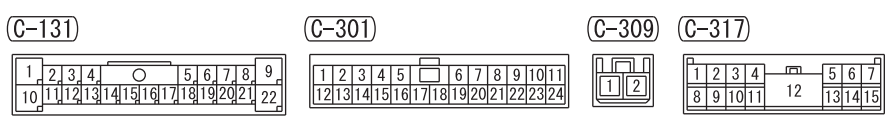
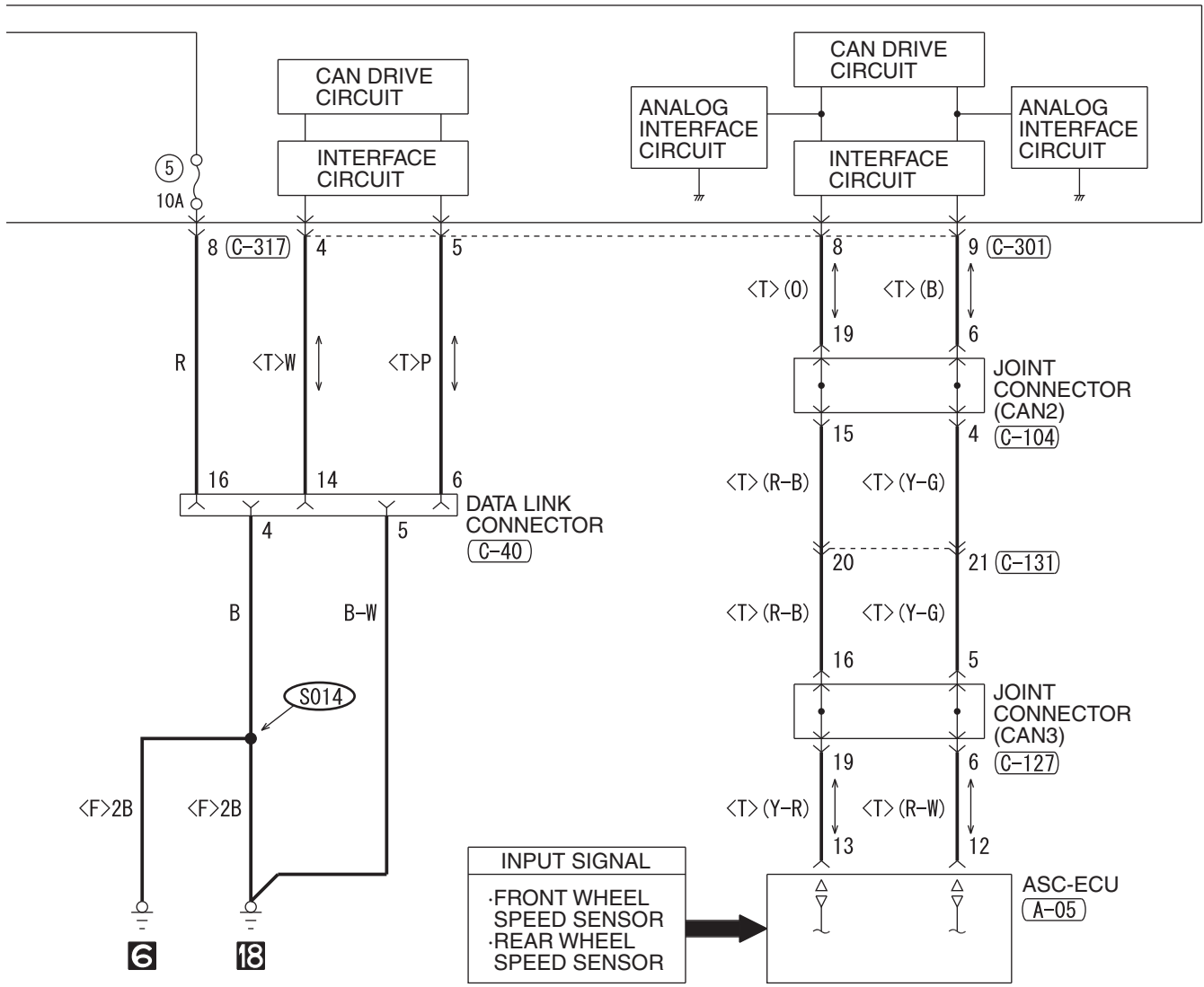

WIRE COLOR CODE  
 B: BLACK LG: LIGHT GREEN G: GREEN L: BLUE W: WHITE Y: YELLOW SB: SKY BLUE  
 BR: BROWN O: ORANGE GR: GRAY R: RED P: PINK V: VIOLET PU: PURPLE SI: SILVER

SEAT BELT WARNING TONE ALARM (CONTINUED)

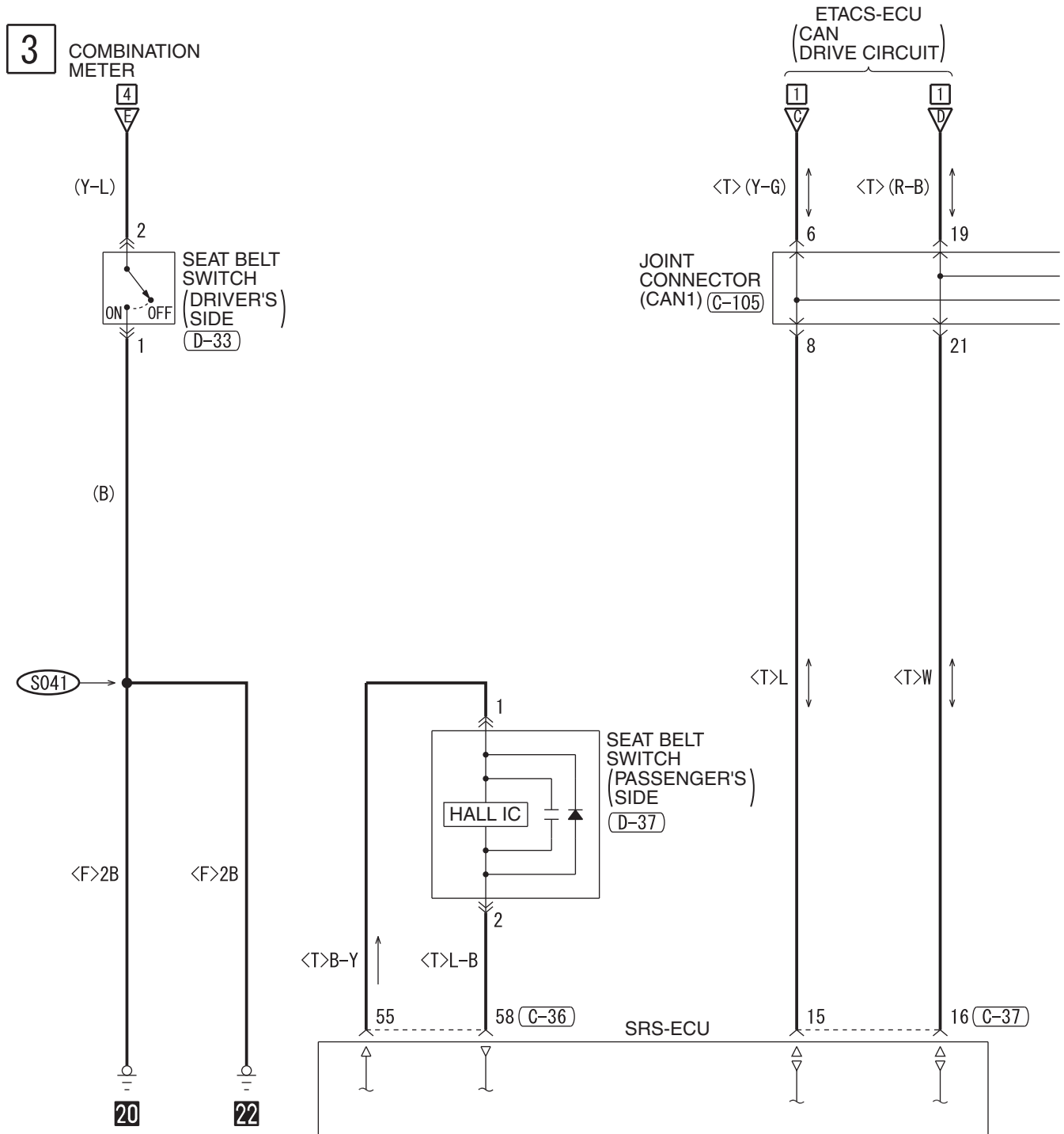

C-04

1	2	3	4	5	6	7	8	9	10	11	12
13	14	15	16	17	18	19	20	21	22	23	24

C-36

31	32	33	34	35	36	37	38	39	40	41	42	43	44	45	46
47	48	49	50	51	52	53	54	55	56	57	58	59	60	61	62

C-37

1	2	3	4	5	6	7	8	9	10	11	12
13	14	15	16	17	18	19	20	21	22	23	24

C-41

1	2	3	4	5	6	7	8	9	10	11		
12	13	14	15	16	17	18	19	20	21	22	23	24



4

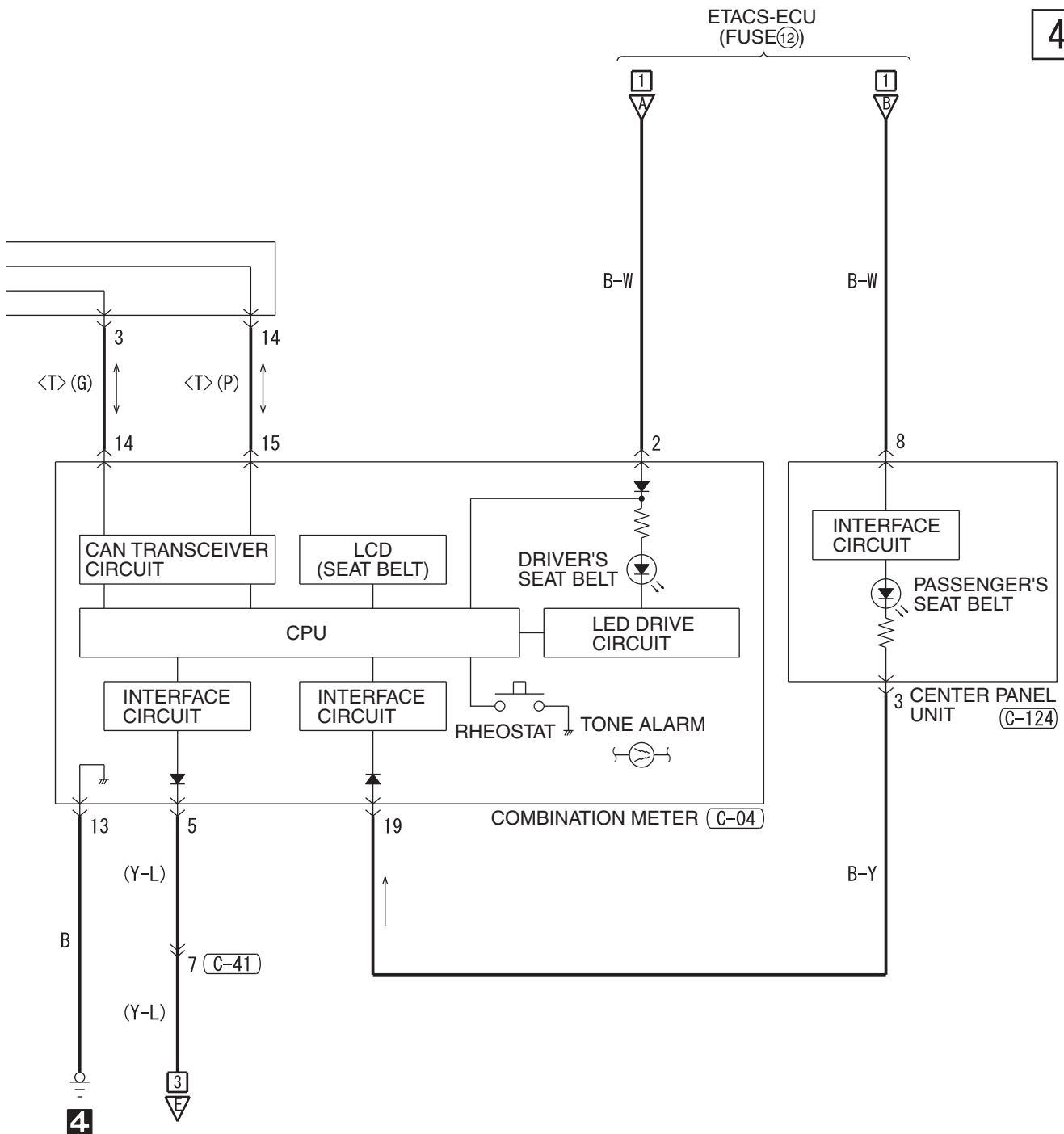

(C-105)

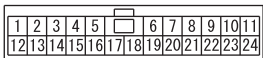

(C-124)

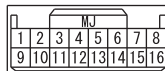

(D-33)



(D-37)



MU802601

WIRE COLOR CODE

B: BLACK LG: LIGHT GREEN G: GREEN L: BLUE W: WHITE Y: YELLOW SB: SKY BLUE  
BR: BROWN O: ORANGE GR: GRAY R: RED P: PINK V: VIOLET PU: PURPLE SI: SILVER

HAH15M33BB

# DOOR AJAR WARNING TONE ALARM

M1901016603031

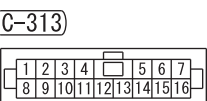
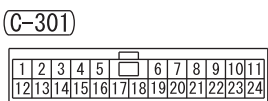
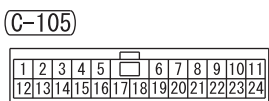
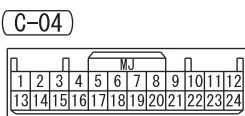
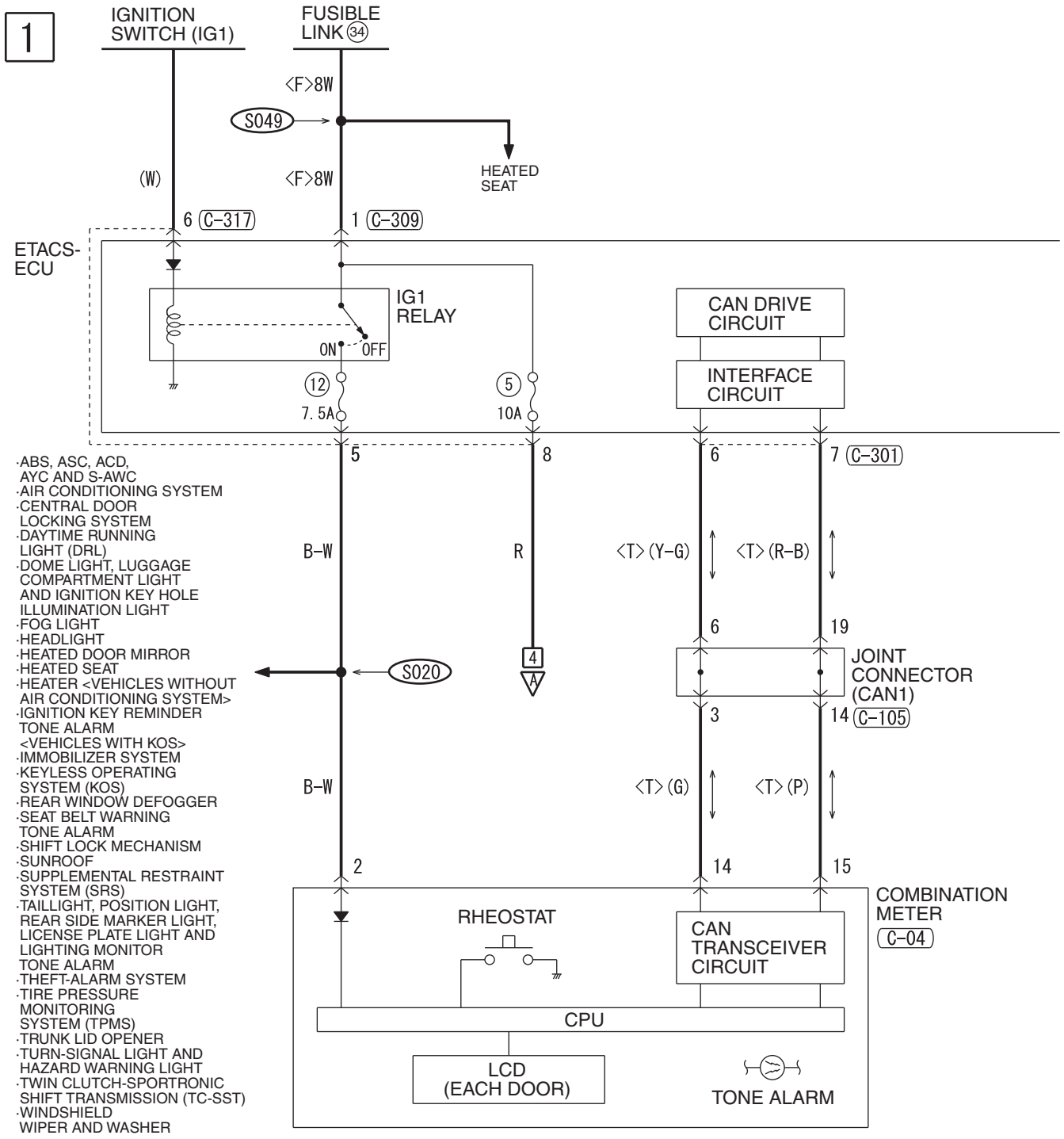

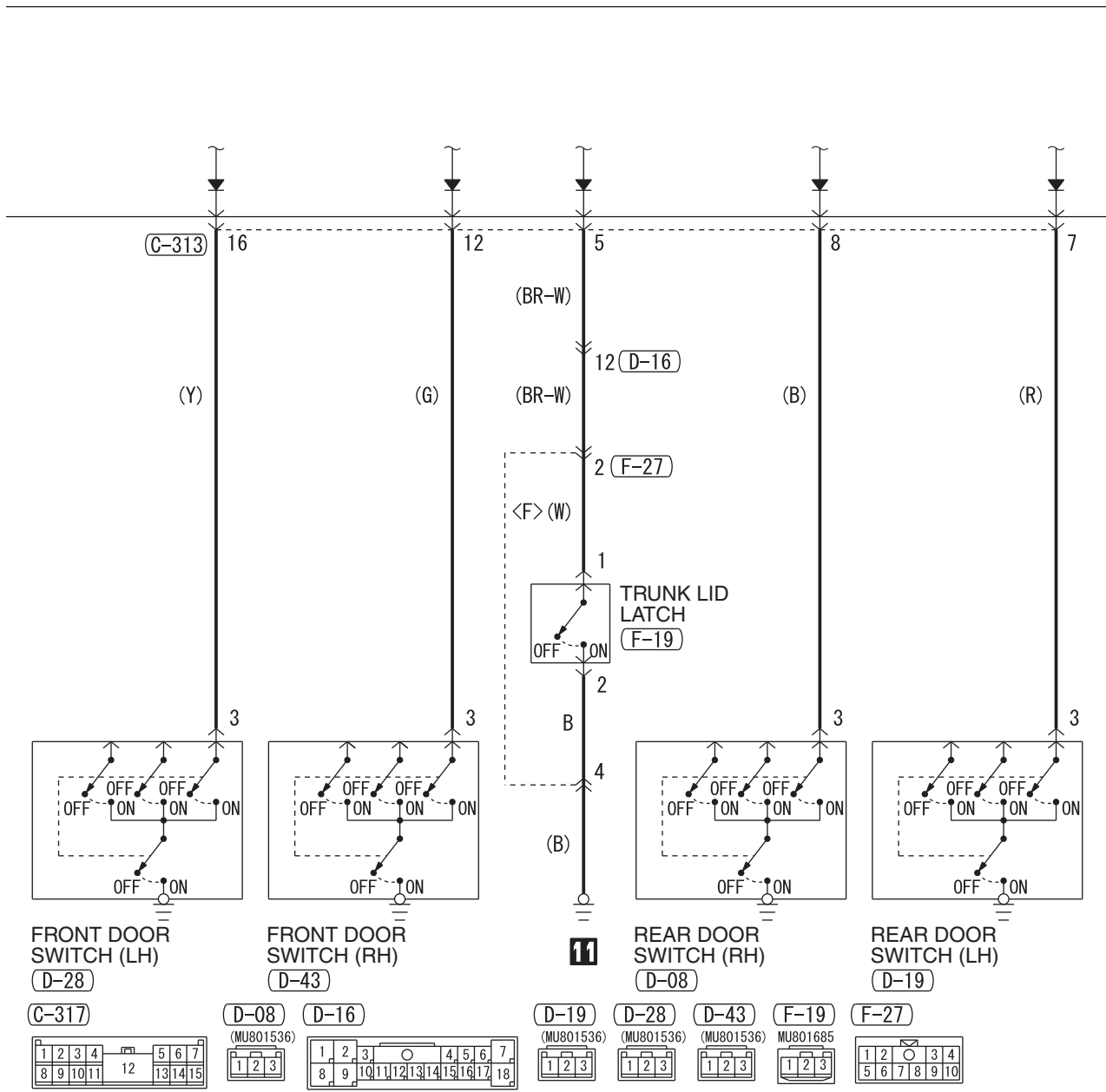

WIRE COLOR CODE  
 B : BLACK LG : LIGHT GREEN G : GREEN L : BLUE W : WHITE Y : YELLOW SB : SKY BLUE  
 BR : BROWN O : ORANGE GR : GRAY R : RED P : PINK V : VIOLET PU : PURPLE SI : SILVER

HAH15M34AB

DOOR AJAR WARNING TONE ALARM (CONTINUED)

3

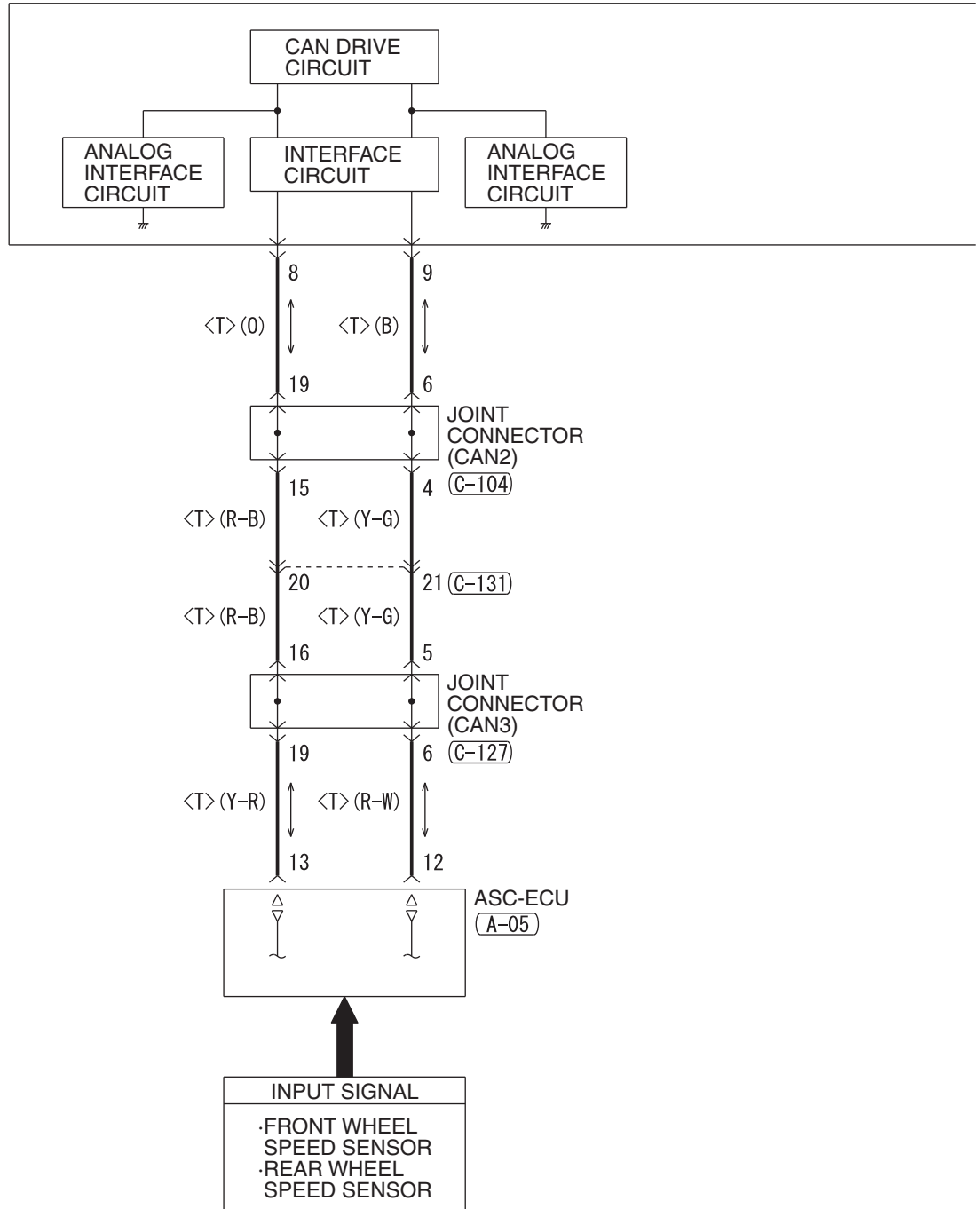

(A-05)

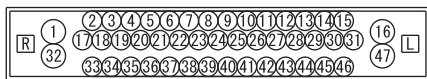

(C-40) FRONT SIDE



(C-104)

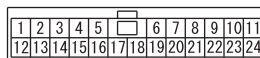

(C-127)

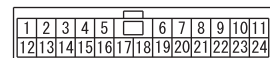

4

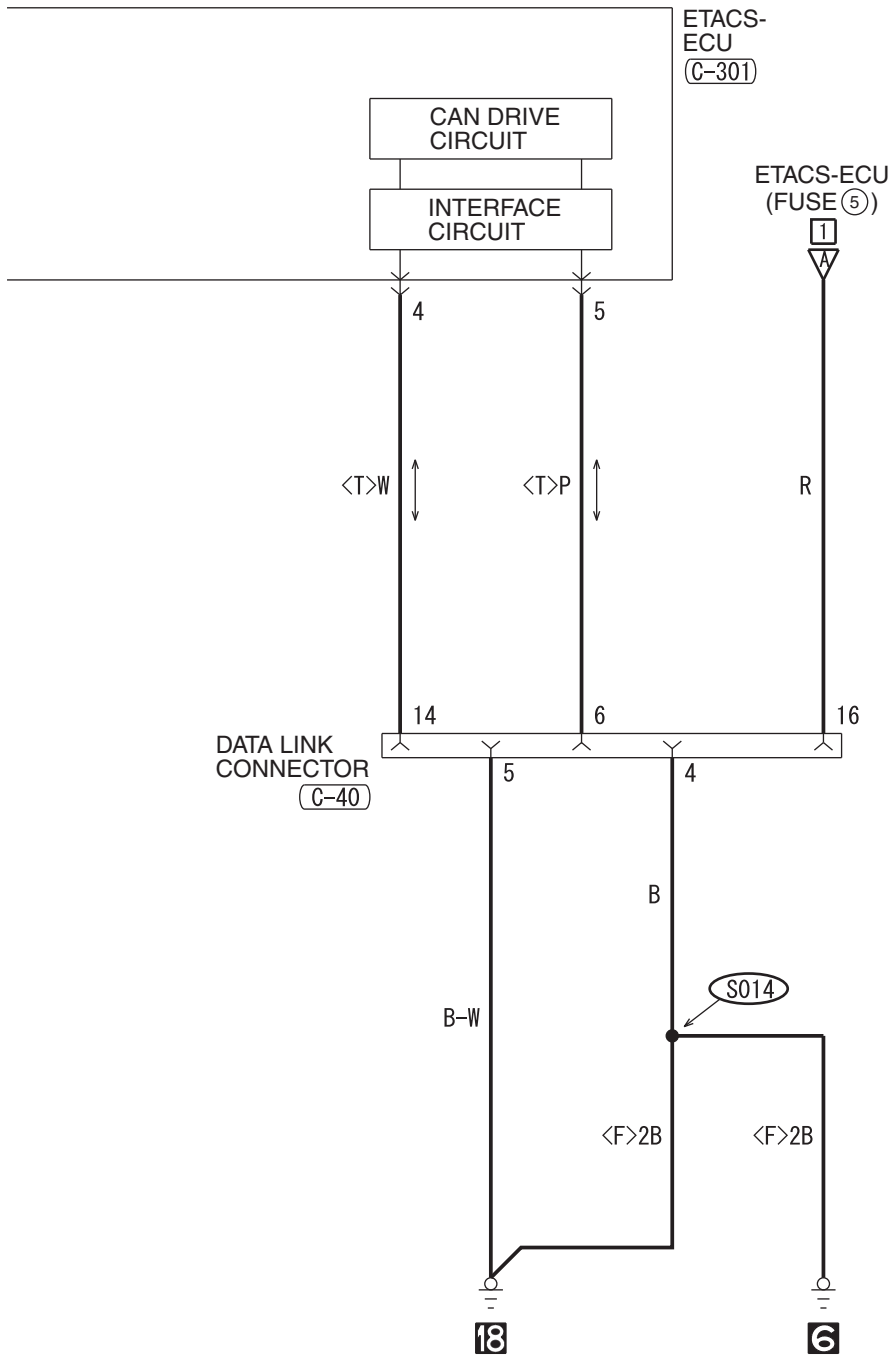

(C-131)

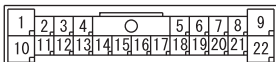

(C-301)

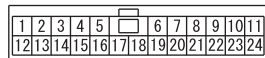

WIRE COLOR CODE

B: BLACK LG: LIGHT GREEN G: GREEN L: BLUE W: WHITE Y: YELLOW SB: SKY BLUE  
BR: BROWN O: ORANGE GR: GRAY R: RED P: PINK V: VIOLET PU: PURPLE SI: SILVER

HAH15M34BB

TSB Revision

# PARKING BRAKE REMINDER TONE ALARM

M1901033500748

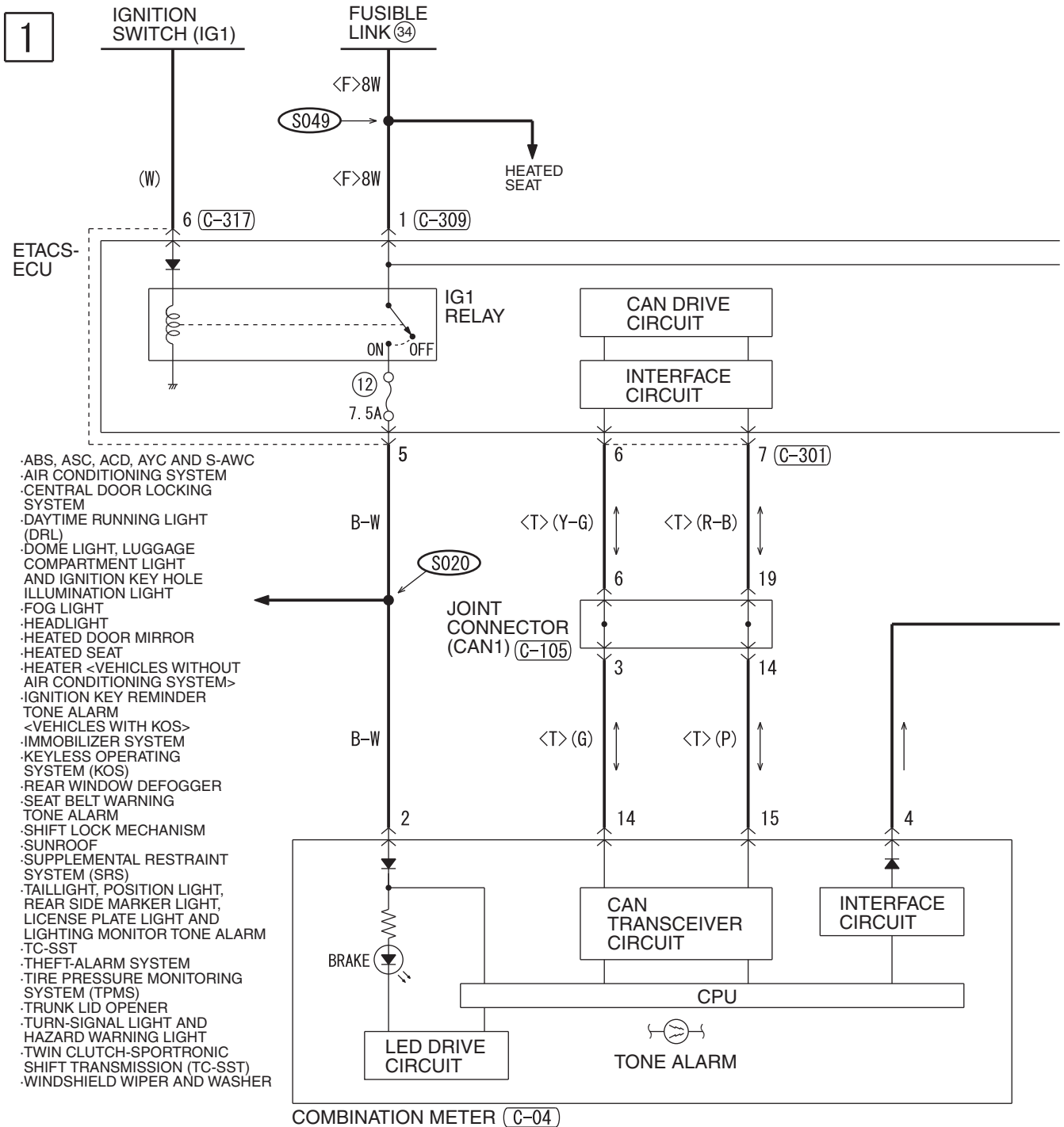

- ABS, ASC, ACD, AYC AND S-AWC
- AIR CONDITIONING SYSTEM
- CENTRAL DOOR LOCKING SYSTEM
- DAYTIME RUNNING LIGHT (DRL)
- DOME LIGHT, LUGGAGE COMPARTMENT LIGHT AND IGNITION KEY HOLE ILLUMINATION LIGHT
- FOG LIGHT
- HEADLIGHT
- HEATED DOOR MIRROR
- HEATED SEAT
- HEATER <VEHICLES WITHOUT AIR CONDITIONING SYSTEM>
- IGNITION KEY REMINDER TONE ALARM
- <VEHICLES WITH KOS>
- IMMOBILIZER SYSTEM
- KEYLESS OPERATING SYSTEM (KOS)
- REAR WINDOW DEFOGGER
- SEAT BELT WARNING TONE ALARM
- SHIFT LOCK MECHANISM
- SUNROOF
- SUPPLEMENTAL RESTRAINT SYSTEM (SRS)
- TAILLIGHT, POSITION LIGHT, REAR SIDE MARKER LIGHT, LICENSE PLATE LIGHT AND LIGHTING MONITOR TONE ALARM
- TC-SST
- THEFT-ALARM SYSTEM
- TIRE PRESSURE MONITORING SYSTEM (TPMS)
- TRUNK LID OPENER
- TURN-SIGNAL LIGHT AND HAZARD WARNING LIGHT
- TWIN CLUTCH-SPORTRONIC SHIFT TRANSMISSION (TC-SST)
- WINDSHIELD WIPER AND WASHER

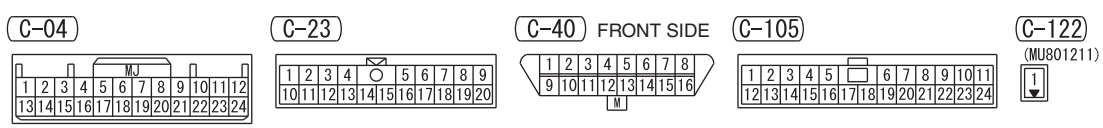

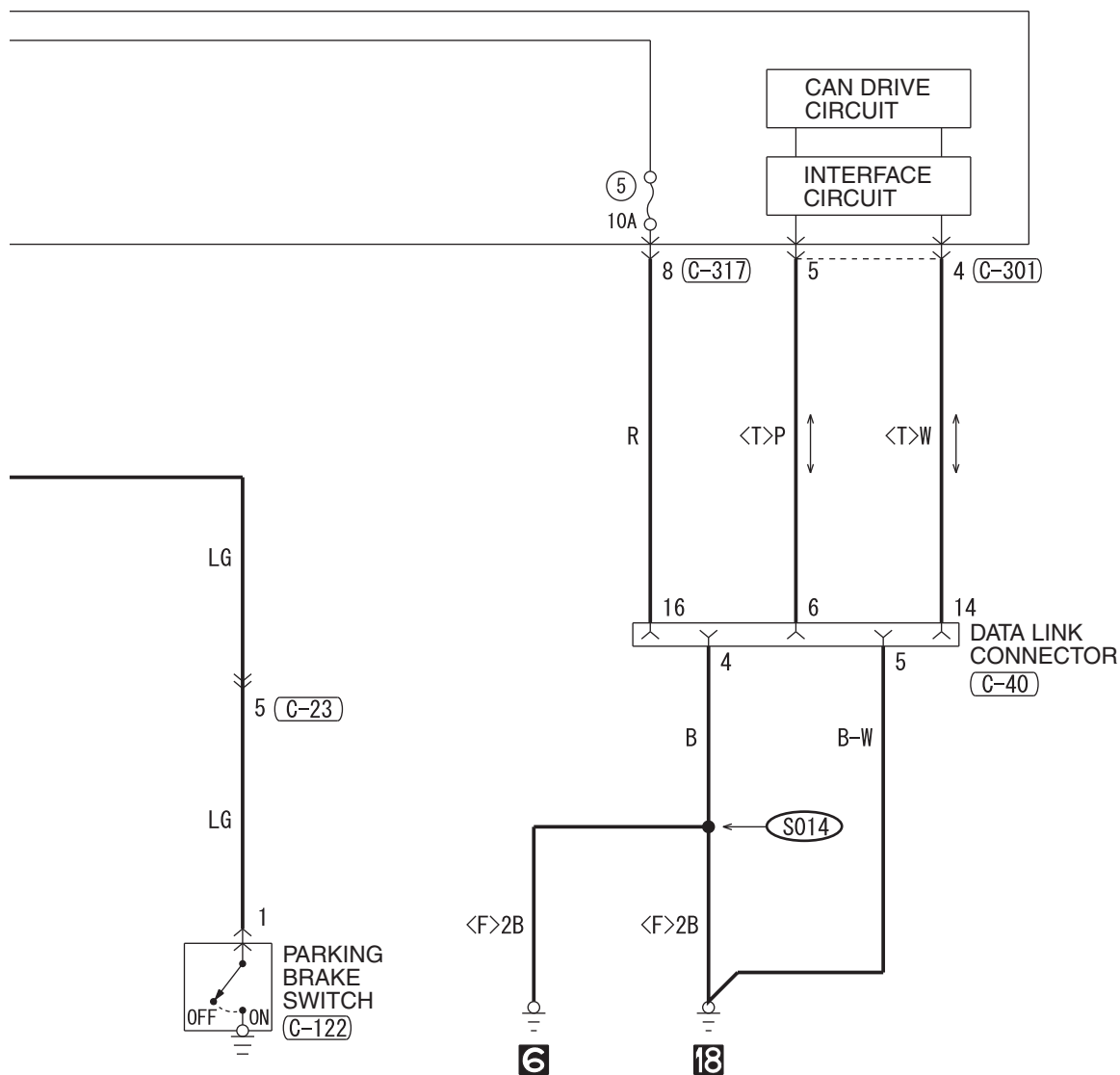

(C-301)

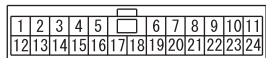

(C-309)



(C-317)

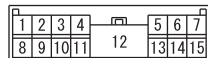

WIRE COLOR CODE

B : BLACK LG : LIGHT GREEN G : GREEN L : BLUE W : WHITE Y : YELLOW SB : SKY BLUE  
 BR : BROWN O : ORANGE GR : GRAY R : RED P : PINK V : VIOLET PU : PURPLE SI : SILVER

HAH15M35AB

PARKING BRAKE REMINDER TONE ALARM (CONTINUED)

3

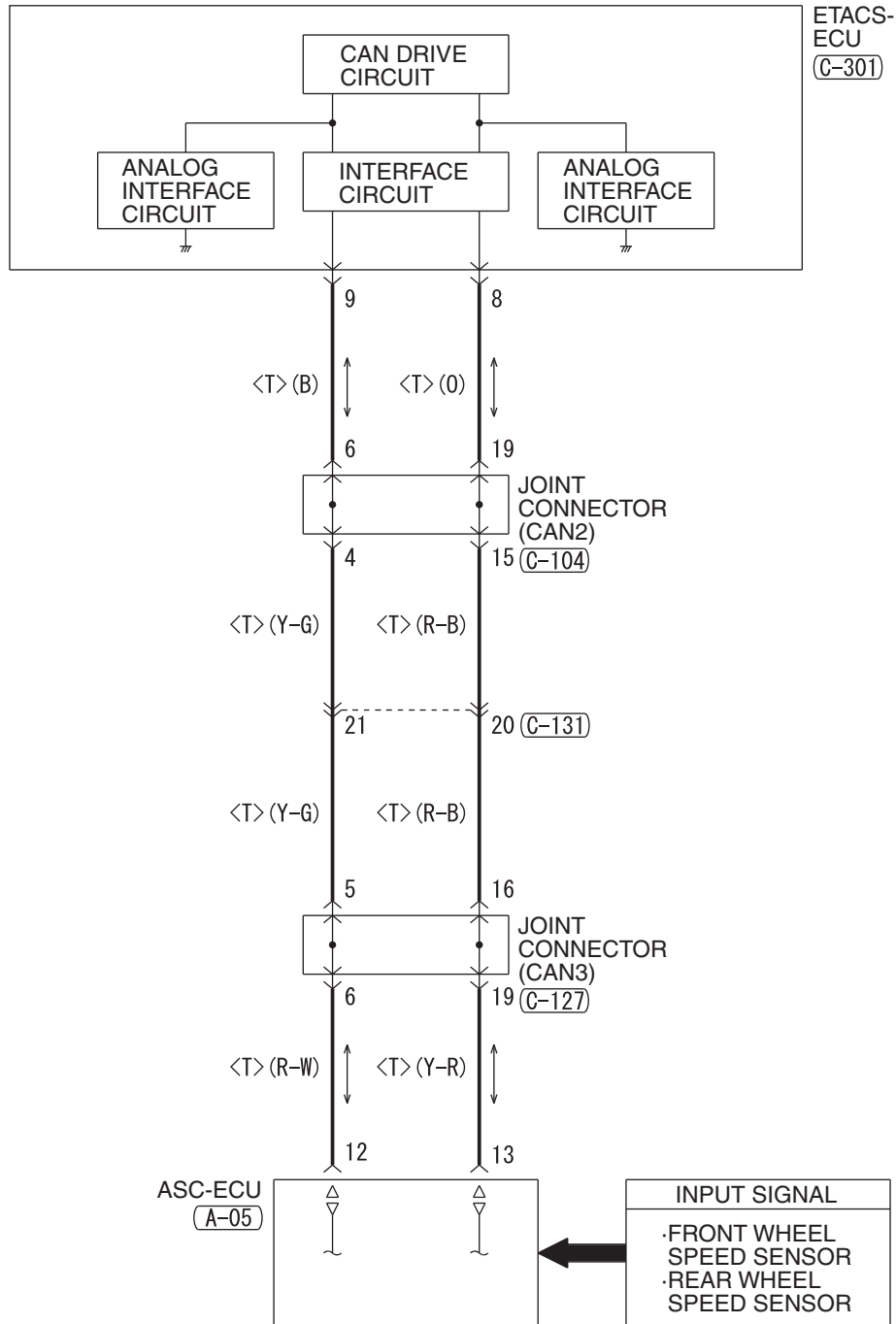

(A-05)

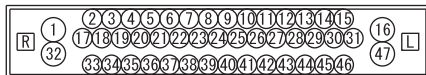

(C-104)

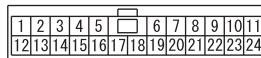

(C-127)

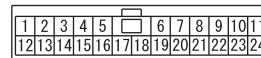

(C-131)

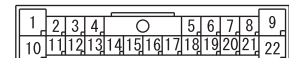

(C-301)

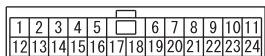

WIRE COLOR CODE

B : BLACK LG : LIGHT GREEN G : GREEN L : BLUE W : WHITE  
 Y : YELLOW SB : SKY BLUE BR : BROWN O : ORANGE GR : GRAY  
 R : RED P : PINK V : VIOLET PU : PURPLE SI : SILVER

HAH15M35BA



NOTES

# THEFT-ALARM SYSTEM

M1901012401170

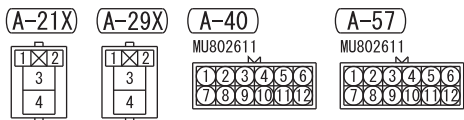
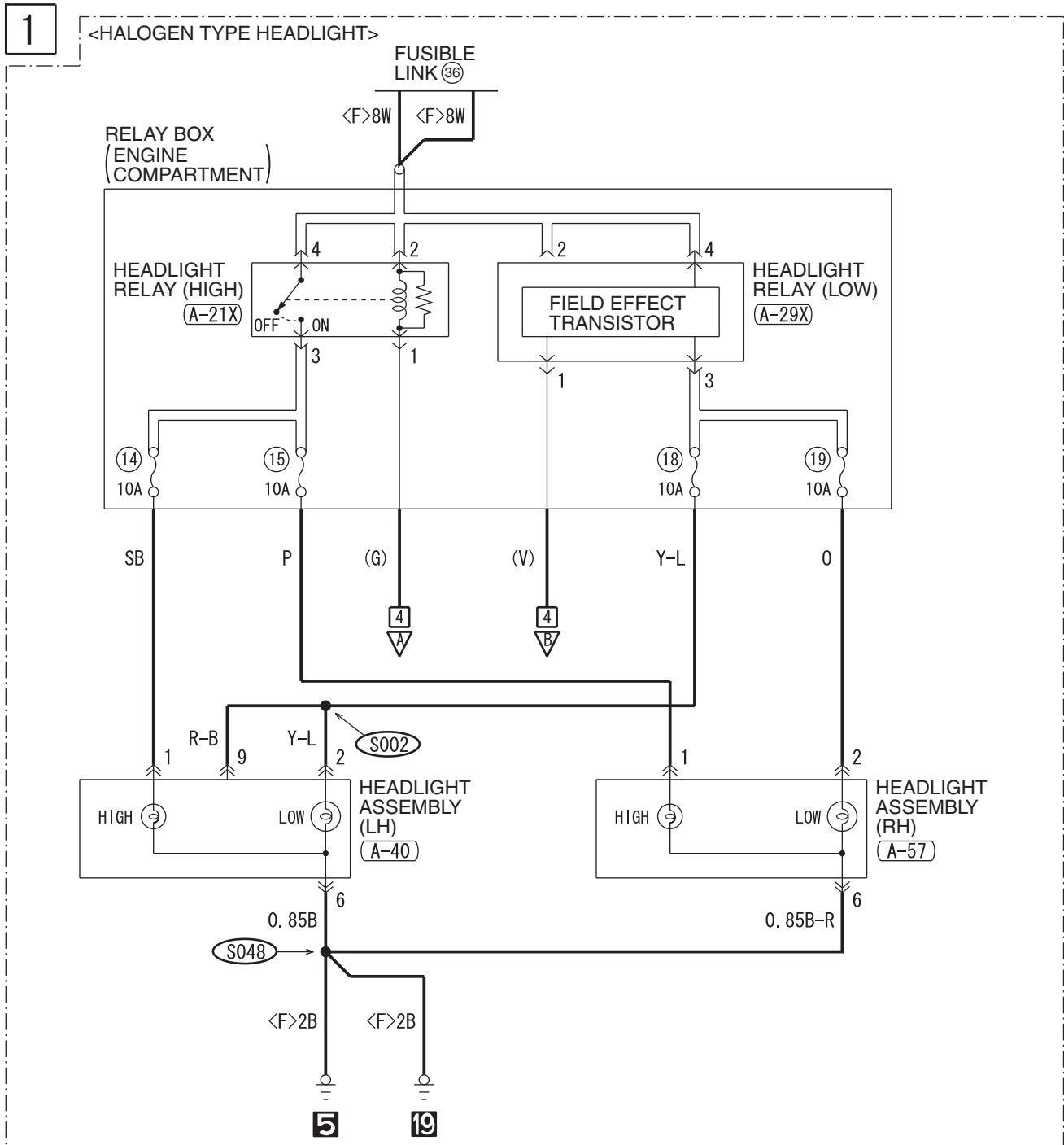

HAH15M36AA

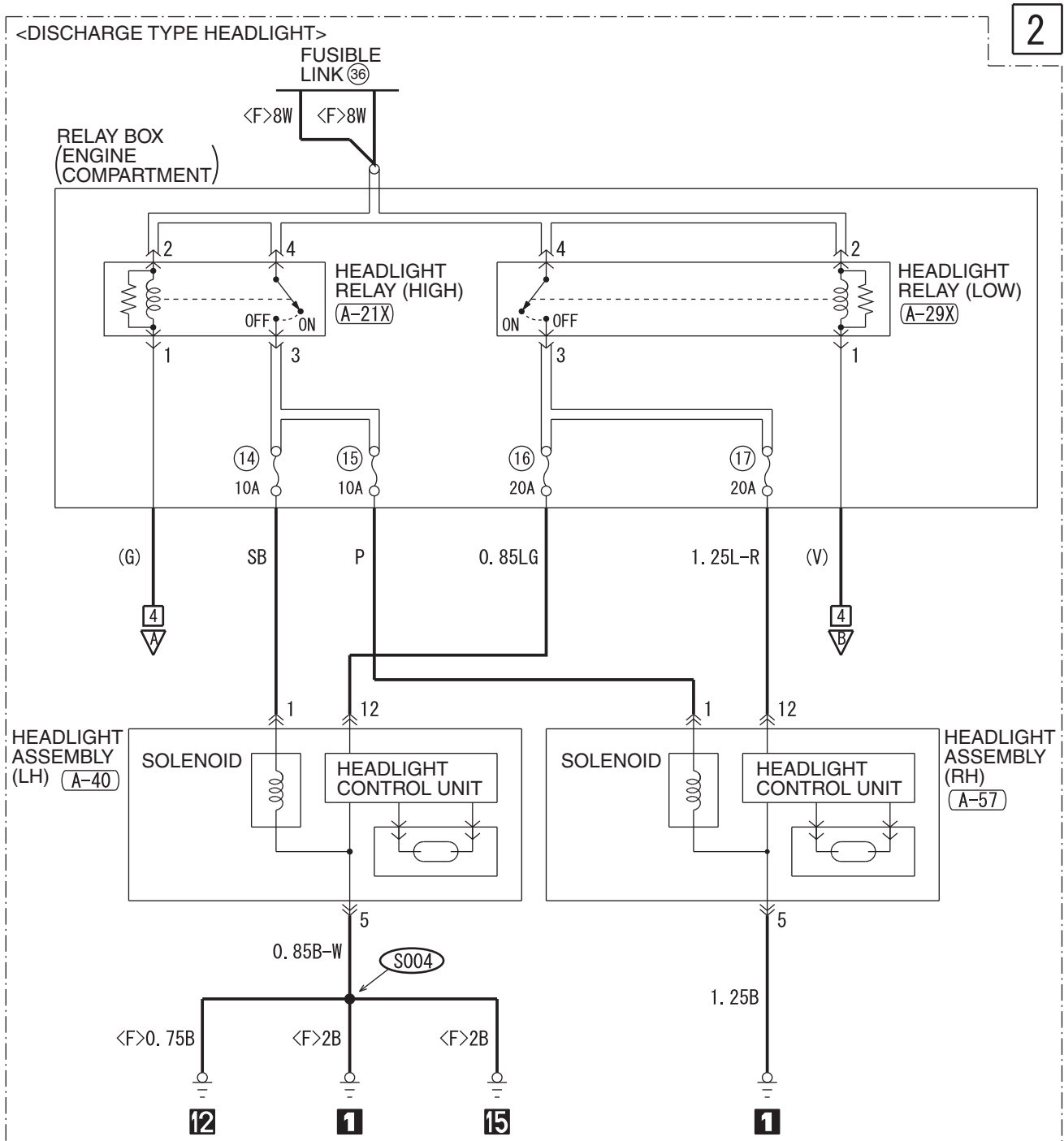

WIRE COLOR CODE

B: BLACK LG: LIGHT GREEN G: GREEN L: BLUE W: WHITE Y: YELLOW SB: SKY BLUE  
BR: BROWN O: ORANGE GR: GRAY R: RED P: PINK V: VIOLET PU: PURPLE SI: SILVER

HAH15M36AB

THEFT-ALARM SYSTEM (CONTINUED)

3

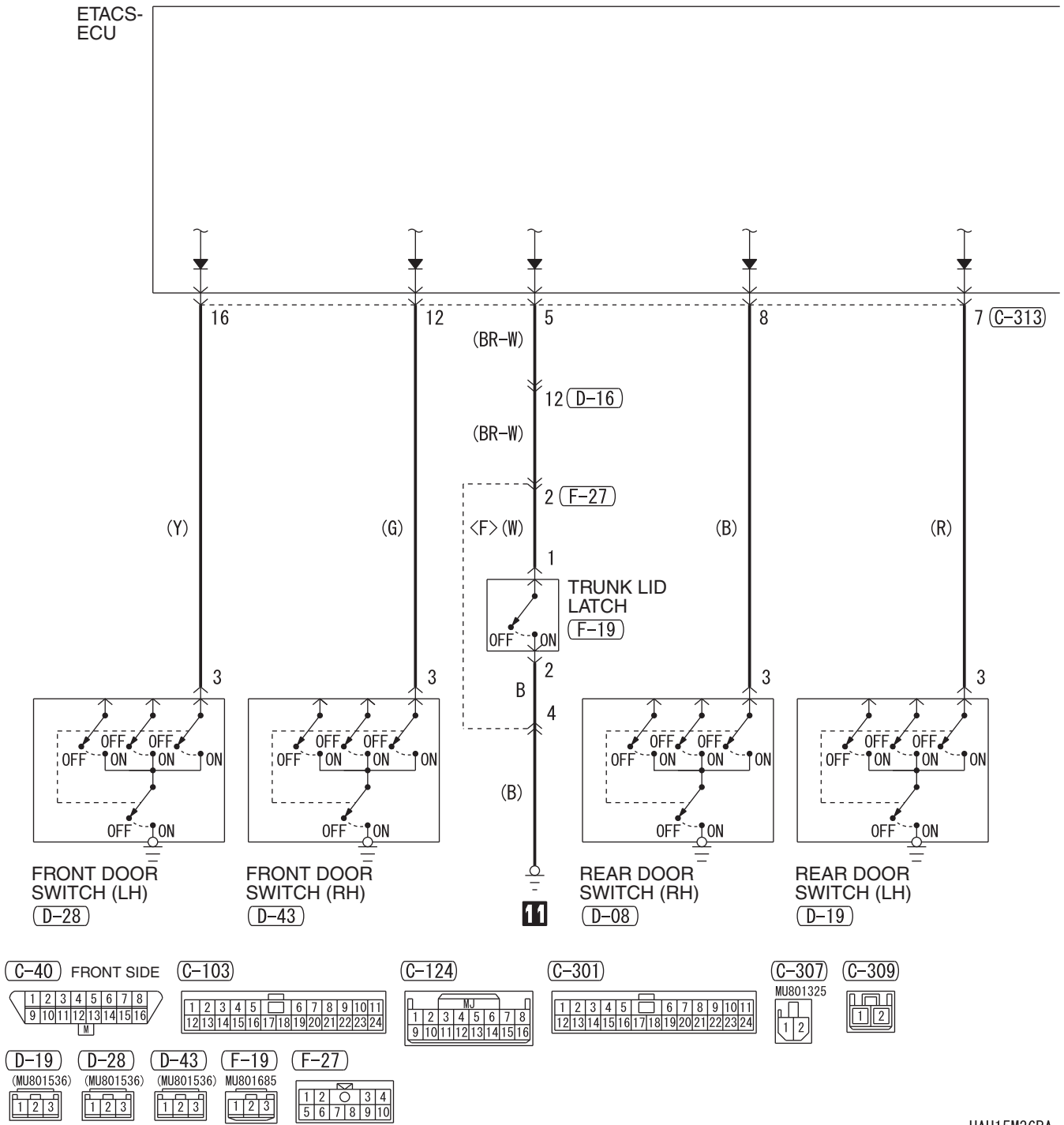

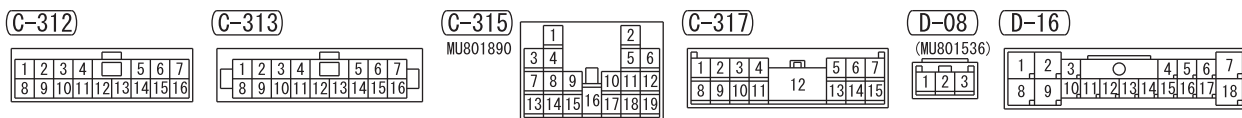
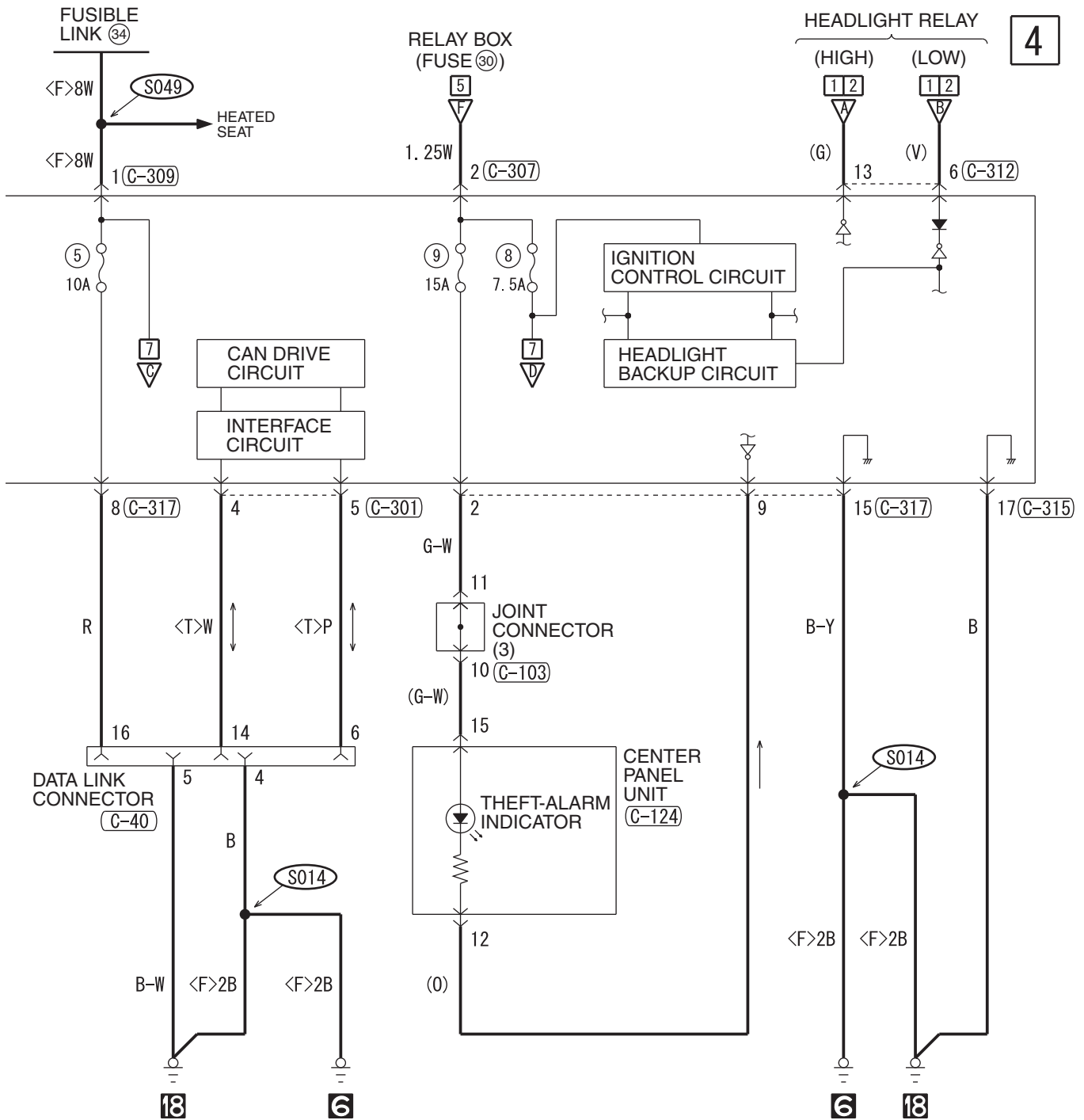

WIRE COLOR CODE  
 B : BLACK LG : LIGHT GREEN G : GREEN L : BLUE W : WHITE Y : YELLOW SB : SKY BLUE  
 BR : BROWN O : ORANGE GR : GRAY R : RED P : PINK V : VIOLET PU : PURPLE SI : SILVER

THEFT-ALARM SYSTEM (CONTINUED)

5

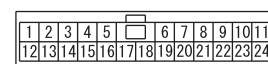
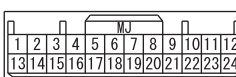
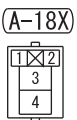
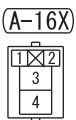
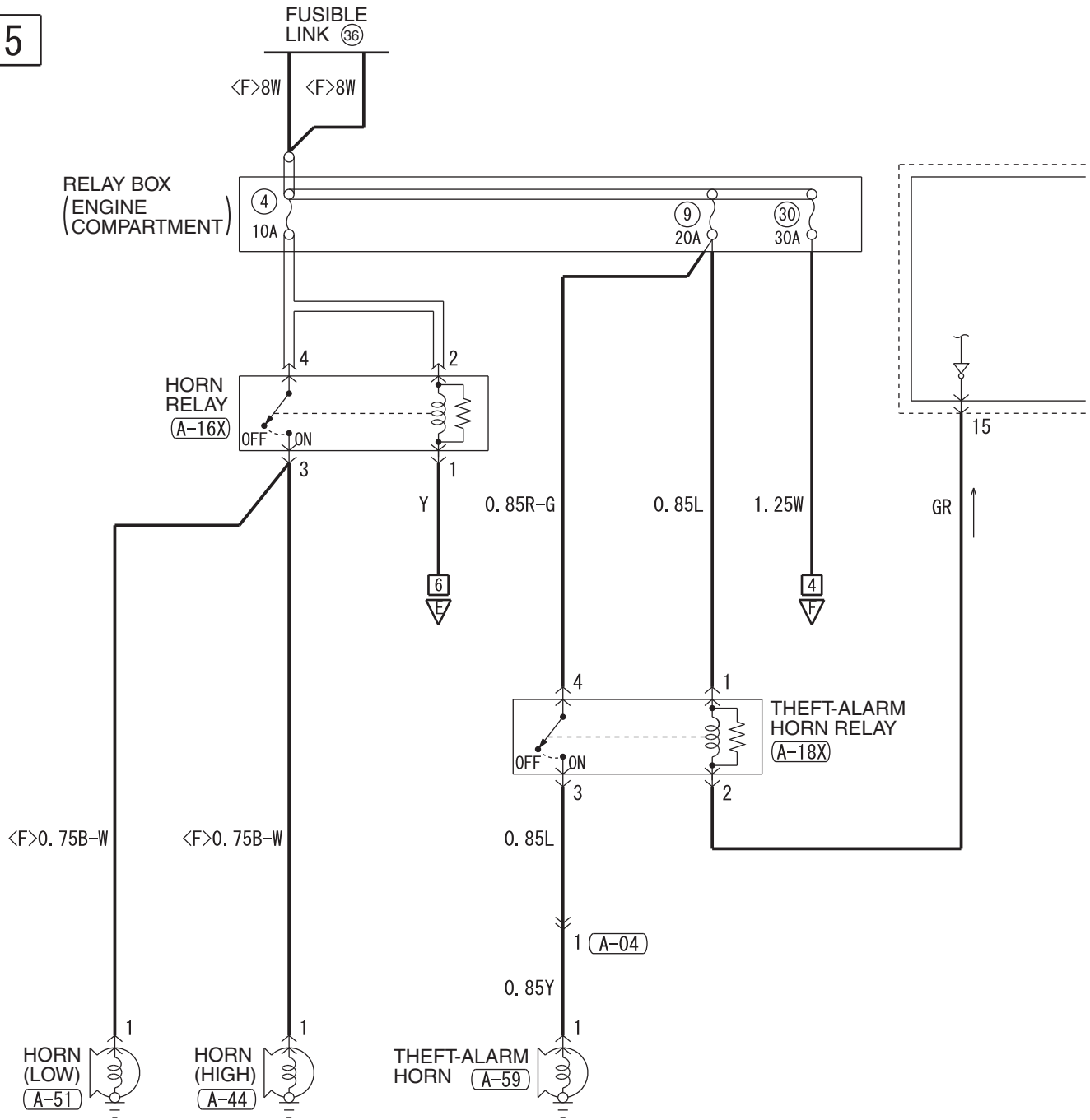

6

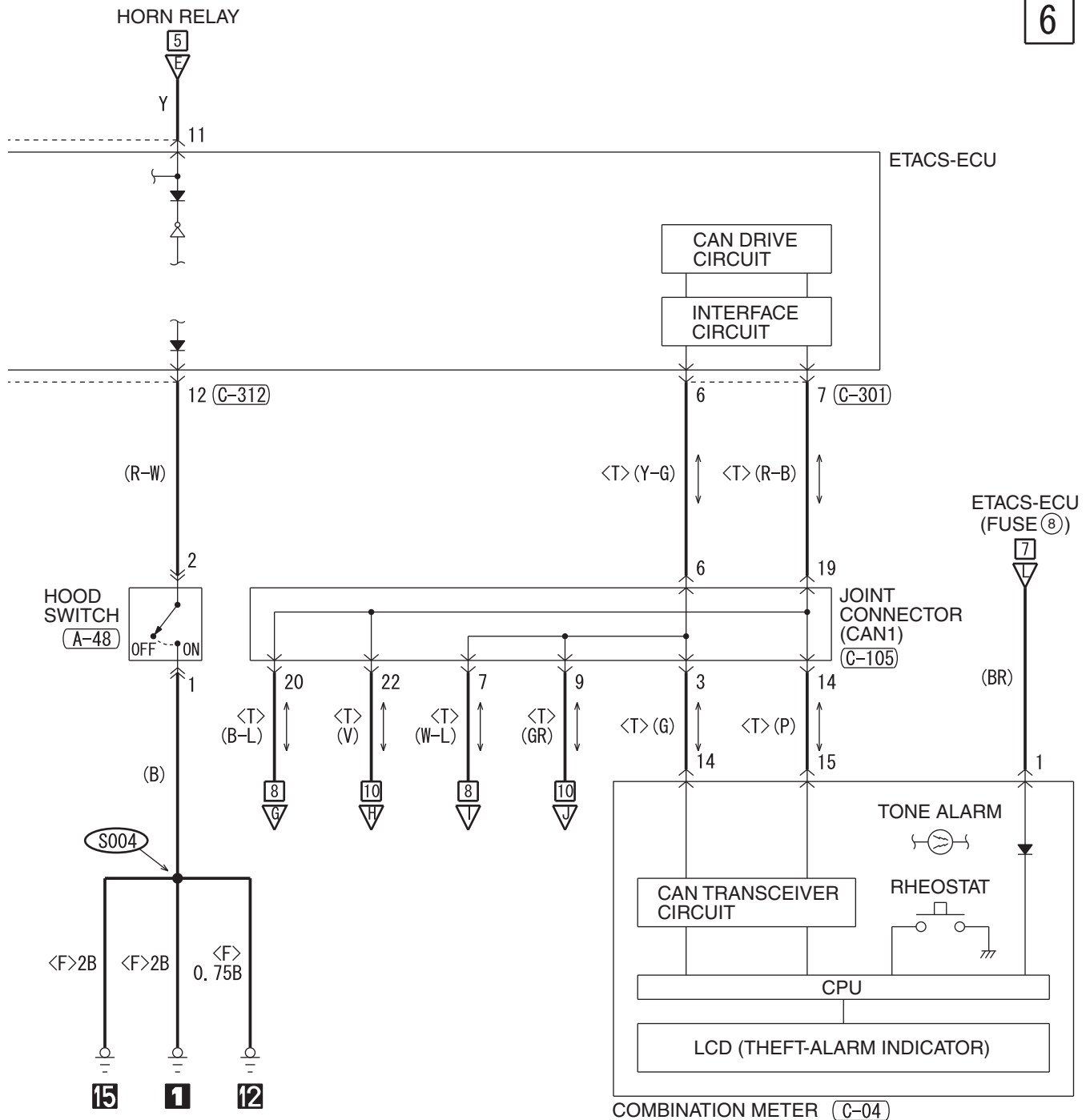

(C-301)

(C-312)

1	2	3	4	5	6	7	8	9	10	11		
12	13	14	15	16	17	18	19	20	21	22	23	24

1	2	3	4	5	6	7		
8	9	10	11	12	13	14	15	16

WIRE COLOR CODE

B: BLACK LG: LIGHT GREEN G: GREEN L: BLUE W: WHITE Y: YELLOW SB: SKY BLUE  
BR: BROWN O: ORANGE GR: GRAY R: RED P: PINK V: VIOLET PU: PURPLE SI: SILVER

HAH15M36CB

TSB Revision

THEFT-ALARM SYSTEM (CONTINUED)

7

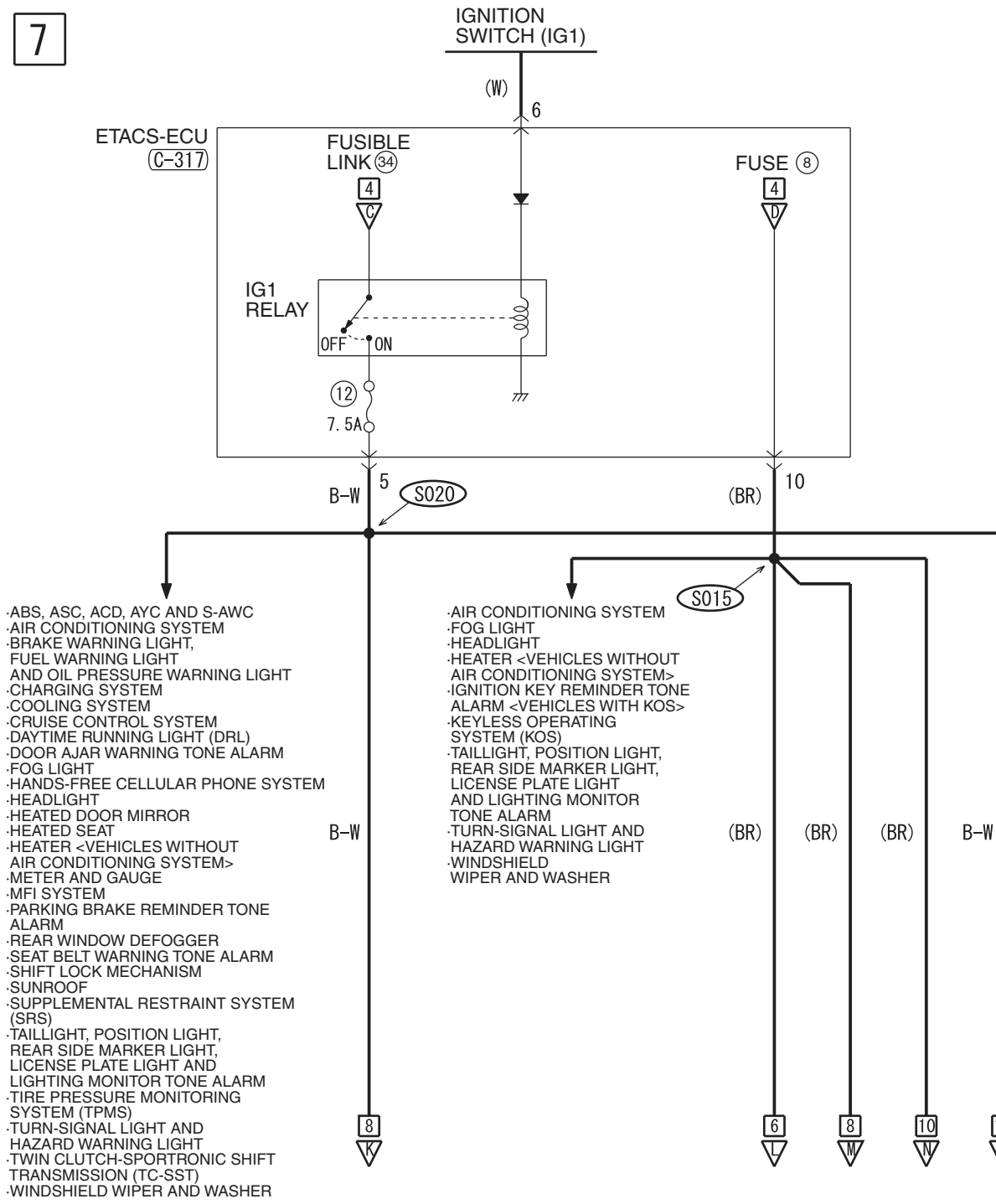

(C-07)

(C-16)

(C-41)

(C-317)

(D-14)

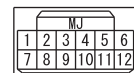
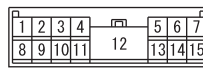
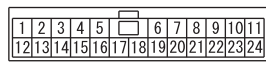
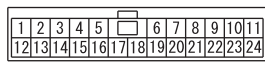
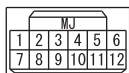



8

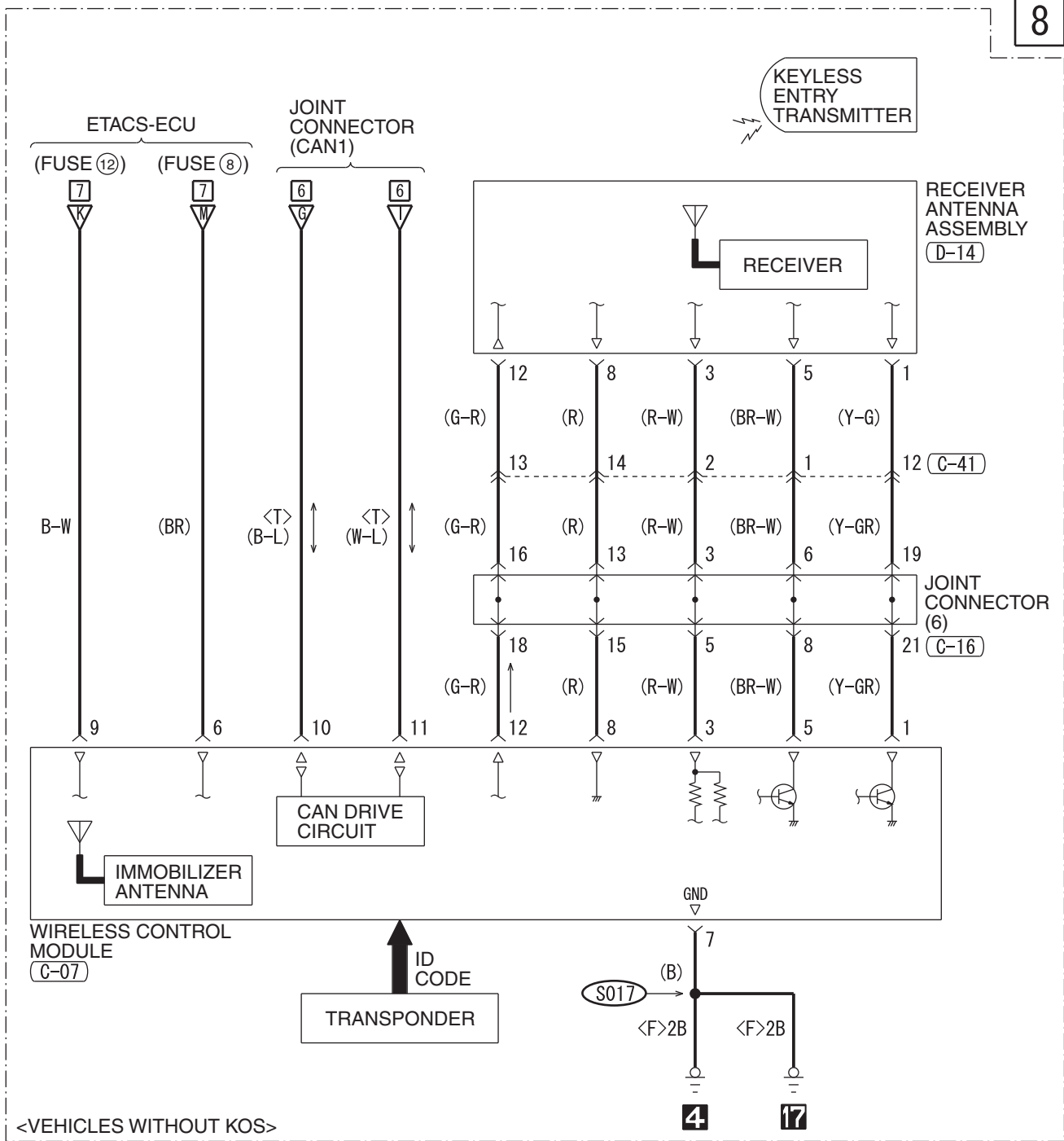

WIRE COLOR CODE  
 B : BLACK LG : LIGHT GREEN G : GREEN L : BLUE W : WHITE Y : YELLOW SB : SKY BLUE  
 BR : BROWN O : ORANGE GR : GRAY R : RED P : PINK V : VIOLET PU : PURPLE SI : SILVER

HAH15M36DB

TSB Revision

THEFT-ALARM SYSTEM (CONTINUED)

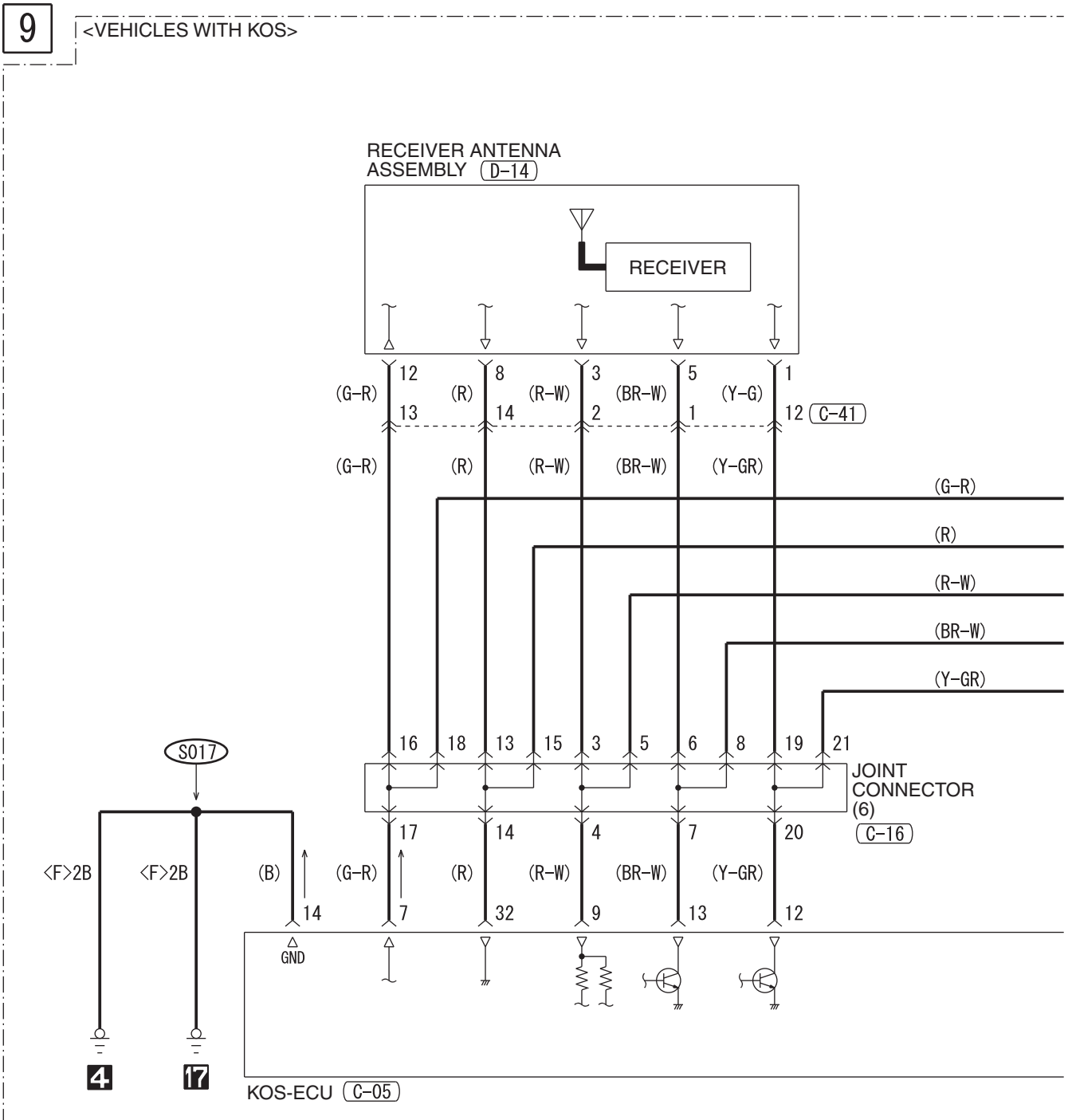

(C-05)

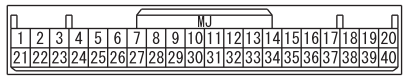

(C-08)

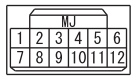

(C-16)

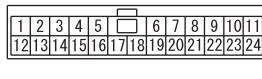

(C-41)

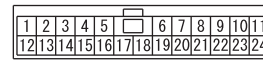

(D-14)

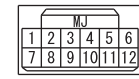

10

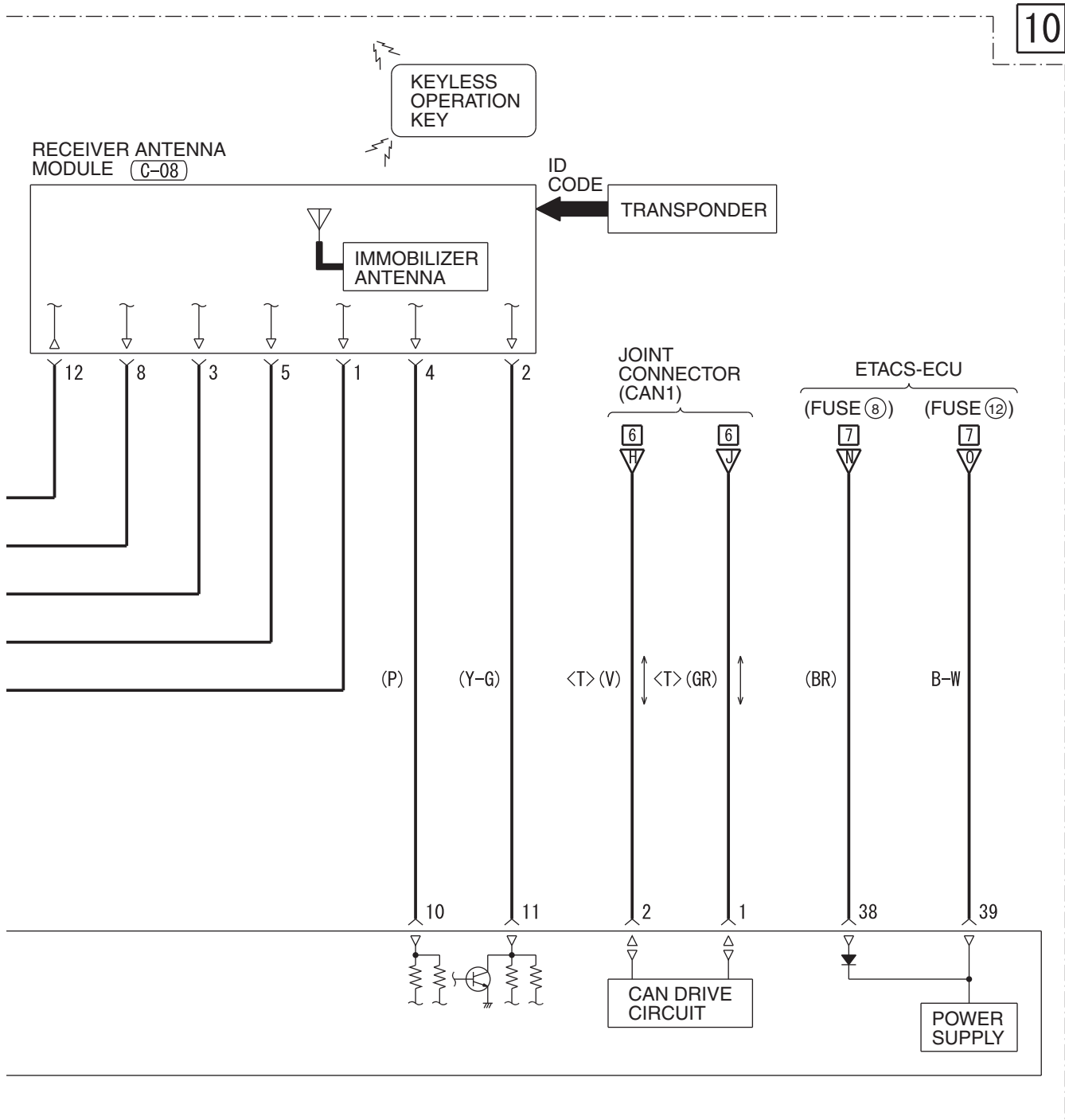

WIRE COLOR CODE

B: BLACK LG: LIGHT GREEN G: GREEN L: BLUE W: WHITE Y: YELLOW SB: SKY BLUE  
BR: BROWN O: ORANGE GR: GRAY R: RED P: PINK V: VIOLET PU: PURPLE SI: SILVER

HAH15M36EB

TSB Revision

# CONTROLLER AREA NETWORK (CAN) <M/T>

M1901004001166

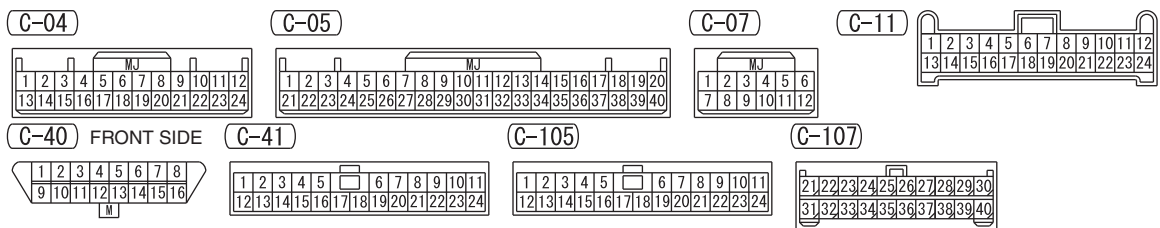
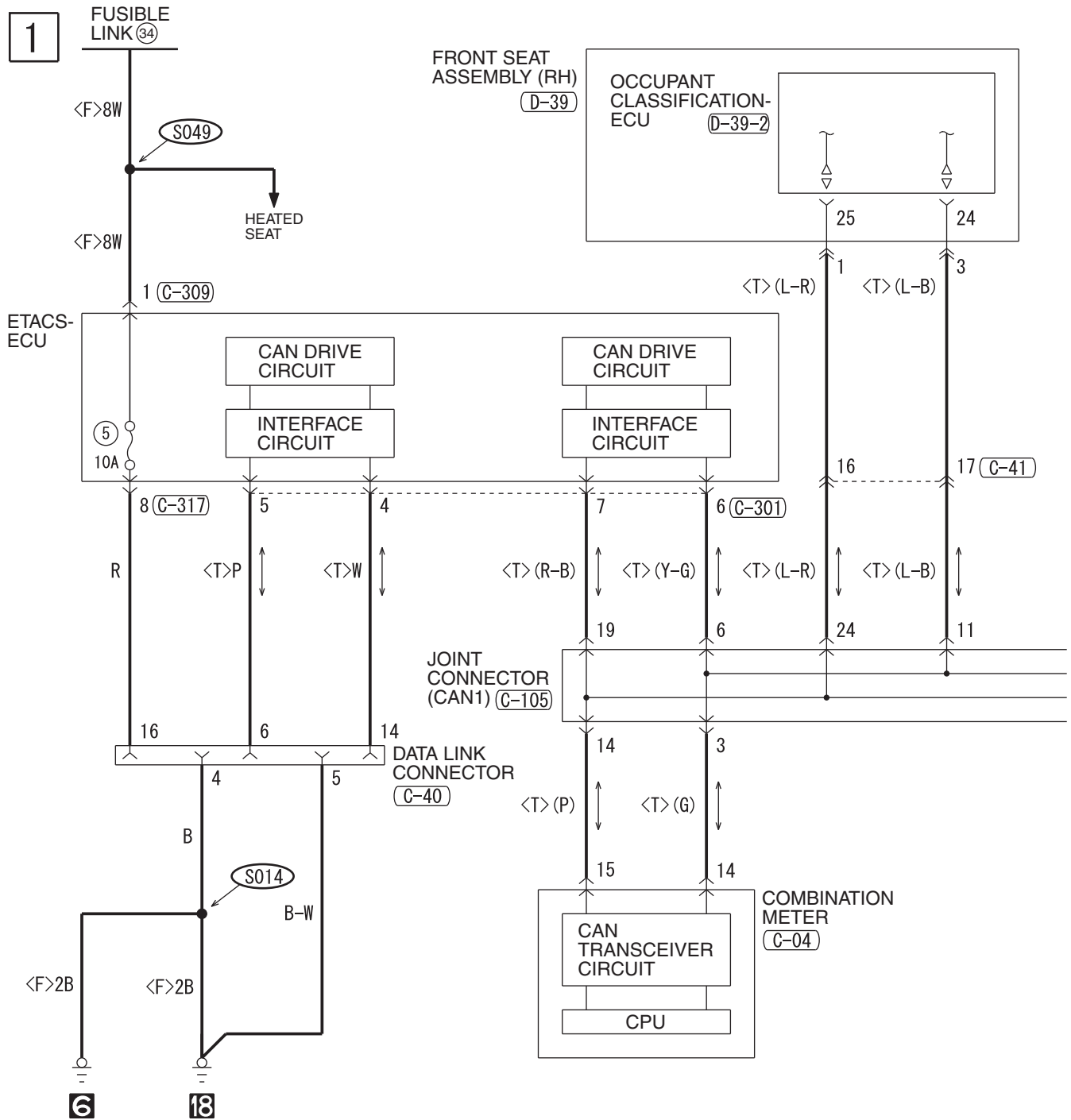

HAH15M37AA

2

NOTE  
\*1 : VEHICLES WITHOUT KOS  
\*2 : VEHICLES WITH KOS  
\*3 : VEHICLES WITHOUT MMCS  
\*4 : VEHICLES WITH MMCS

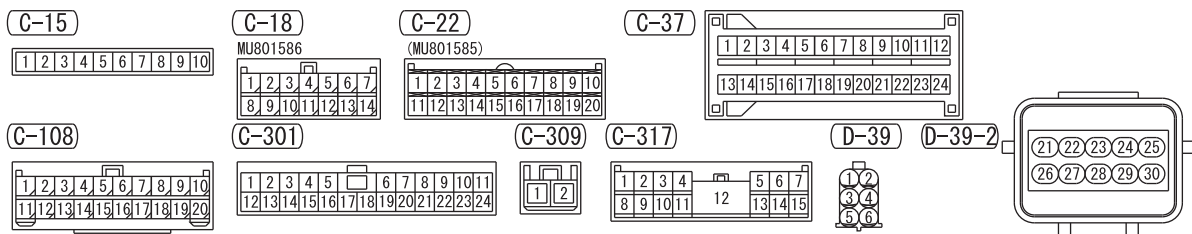
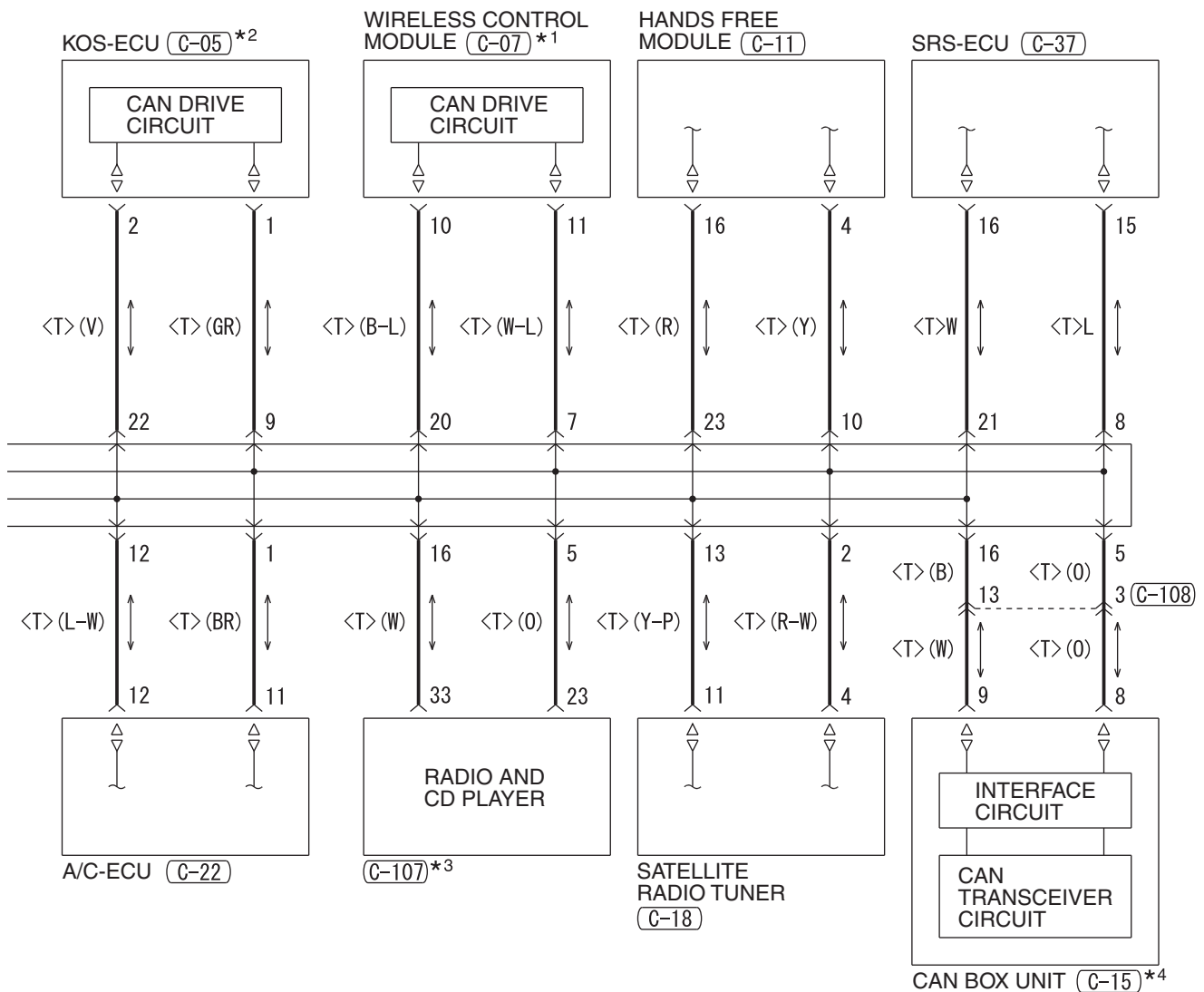

HAH15M37AB

CONTROLLER AREA NETWORK (CAN) <M/T> (CONTINUED)

3

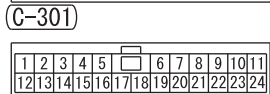
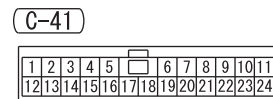
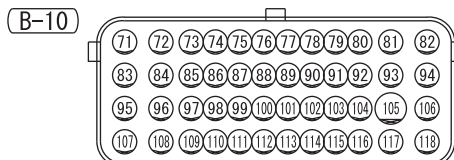
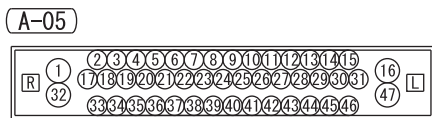
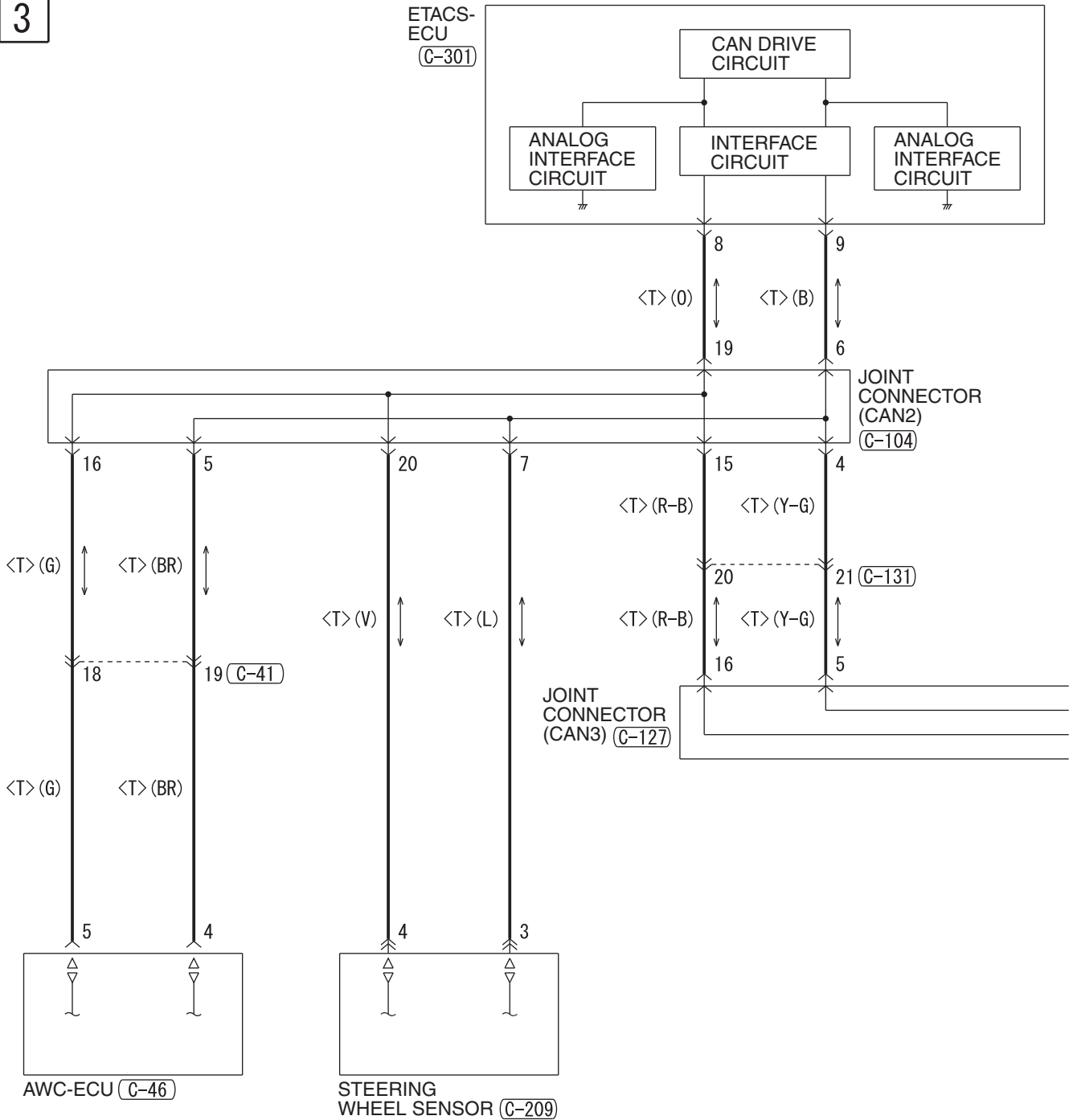

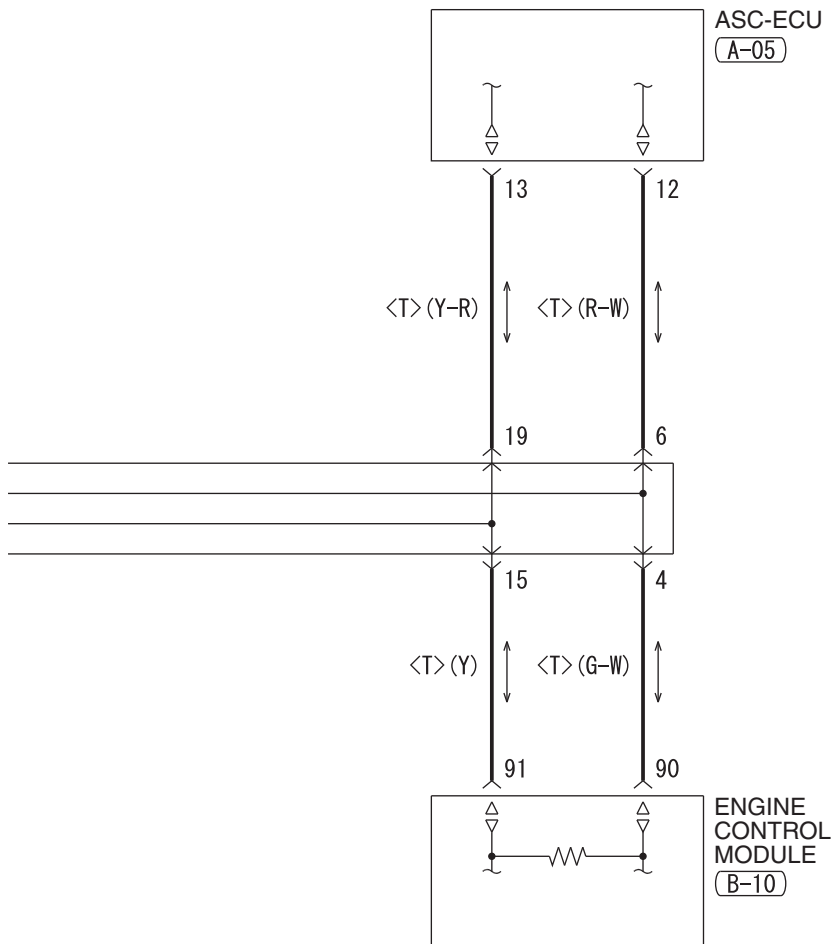

(C-46)

JAE-E												
1	2	3	4	5	6	7	8	9	10	11	12	13
14	15	16	17	18	19	20	21	22	23	24	25	26

(C-104)

1	2	3	4	5	6	7	8	9	10	11		
12	13	14	15	16	17	18	19	20	21	22	23	24

(C-127)

1	2	3	4	5	6	7	8	9	10	11		
12	13	14	15	16	17	18	19	20	21	22	23	24

(C-131)

1	2	3	4	5	6	7	8	9				
10	11	12	13	14	15	16	17	18	19	20	21	22

(C-209)

MU801545				
1	2	3	4	5

WIRE COLOR CODE

B : BLACK LG : LIGHT GREEN G : GREEN L : BLUE W : WHITE Y : YELLOW SB : SKY BLUE  
 BR : BROWN O : ORANGE GR : GRAY R : RED P : PINK V : VIOLET PU : PURPLE SI : SILVER

# CONTROLLER AREA NETWORK (CAN) <TC-SST>

M1901004001177

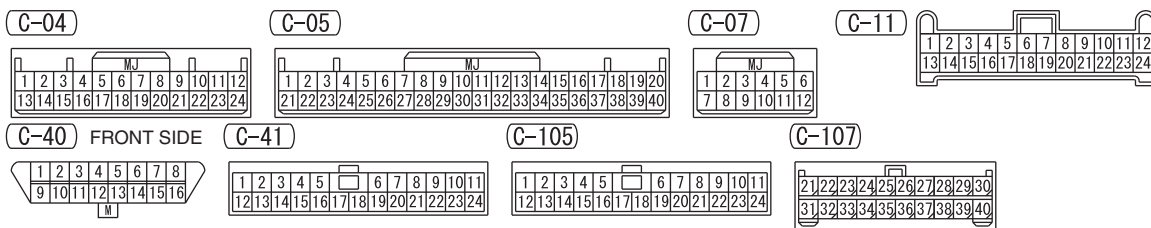
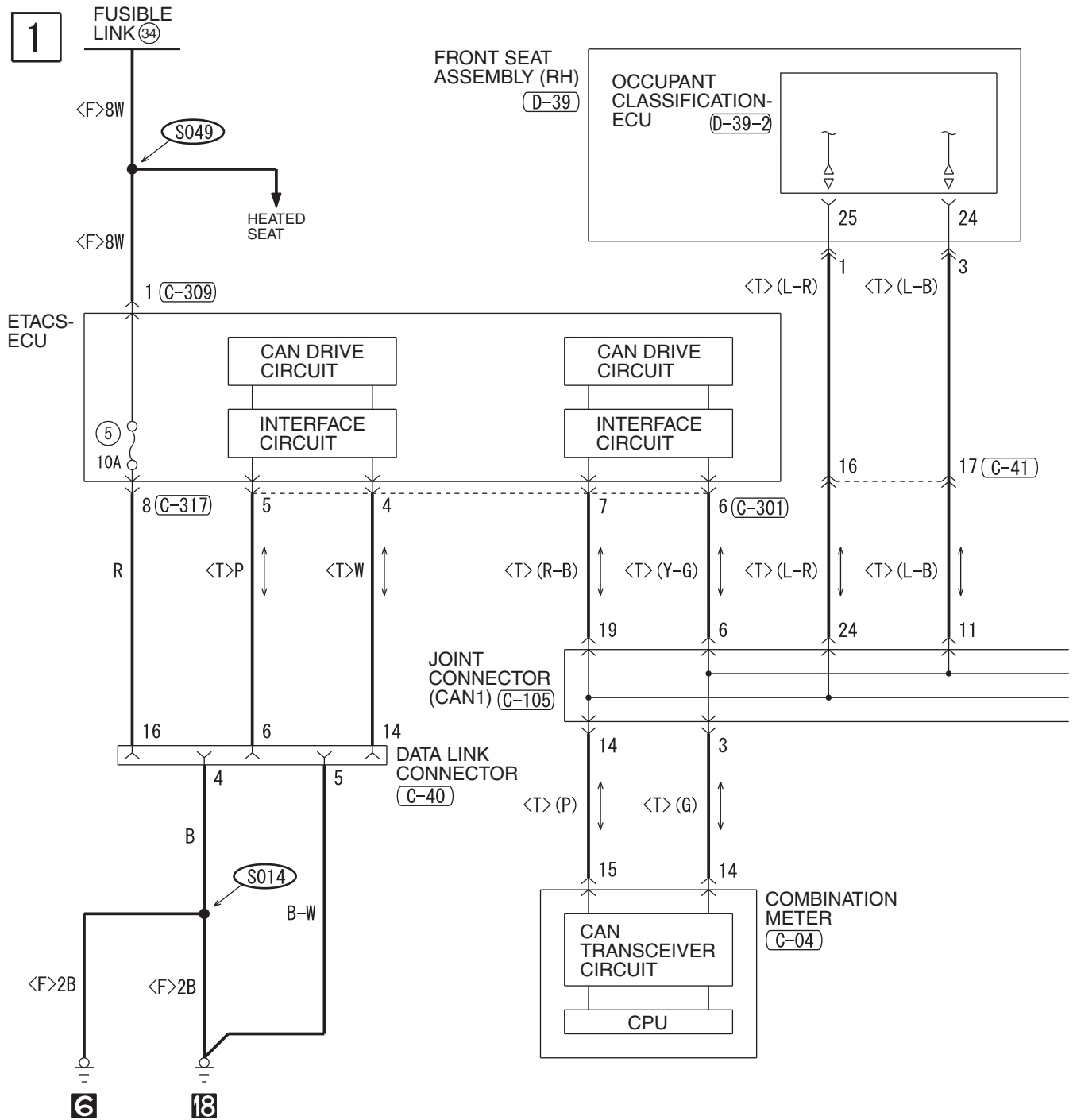

HAH15M38AA



2

NOTE  
\*1 : VEHICLES WITHOUT KOS  
\*2 : VEHICLES WITH KOS  
\*3 : VEHICLES WITHOUT MMCS  
\*4 : VEHICLES WITH MMCS

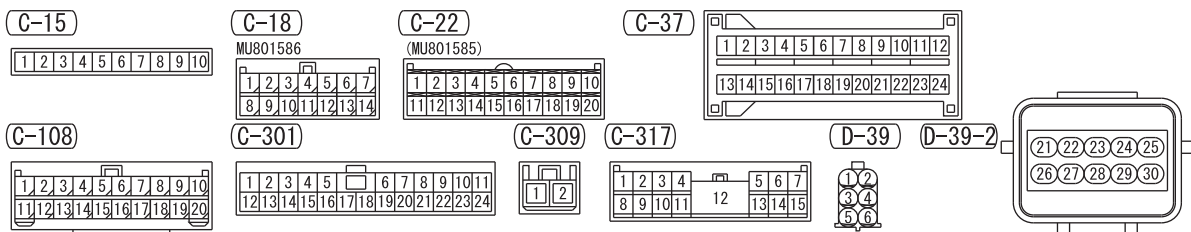
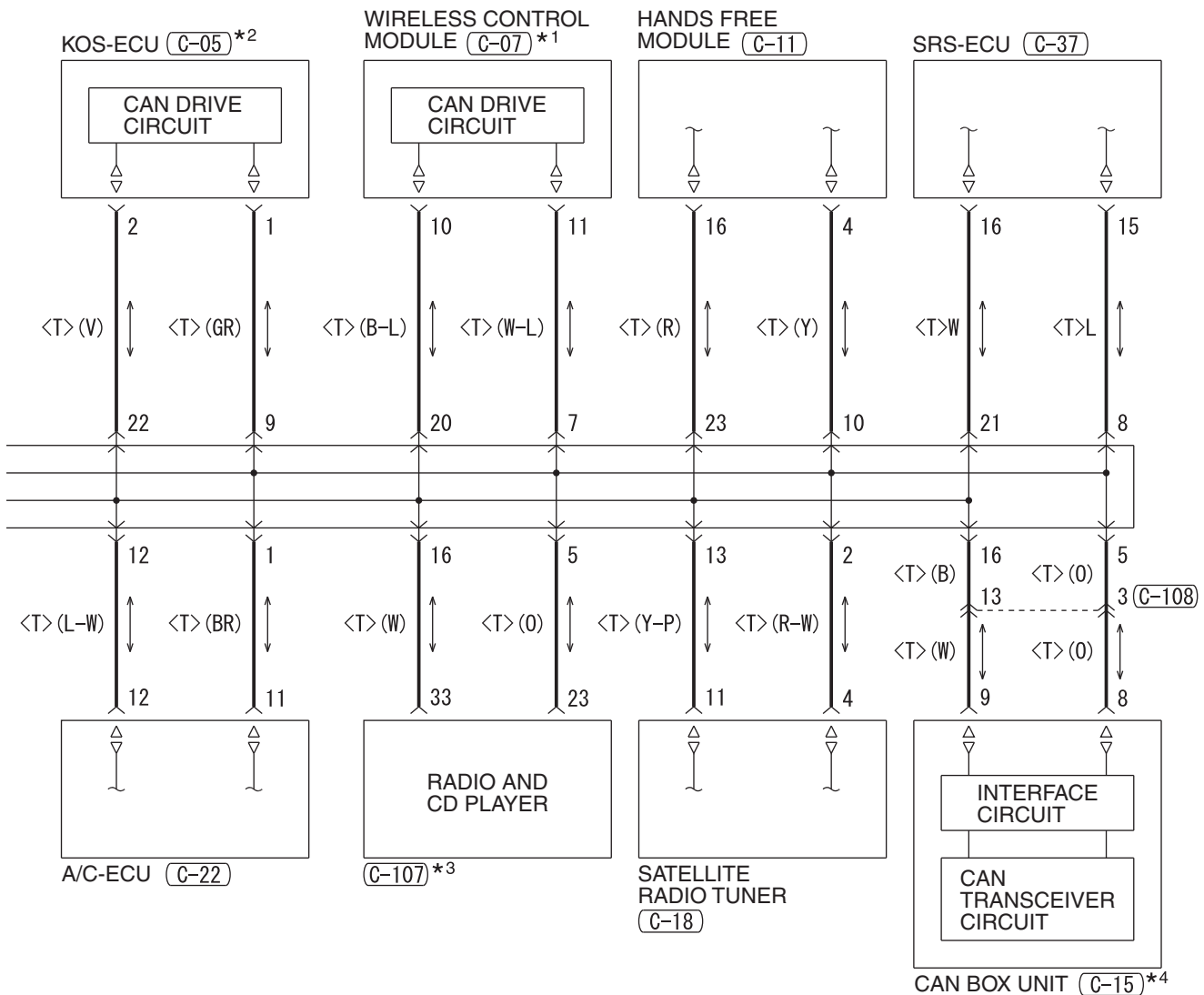

HAH15M38AB

CONTROLLER AREA NETWORK (CAN) <TC-SST> (CONTINUED)

3

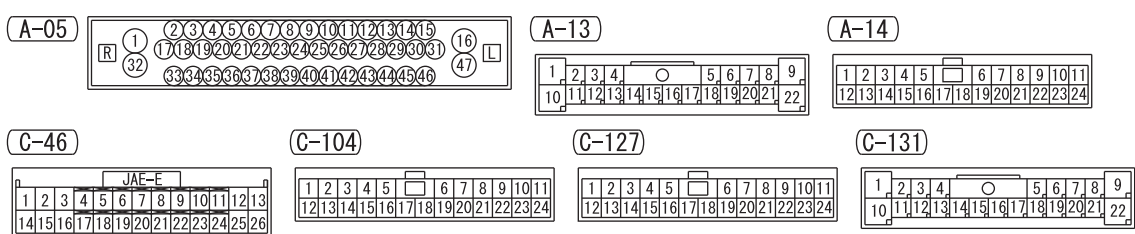
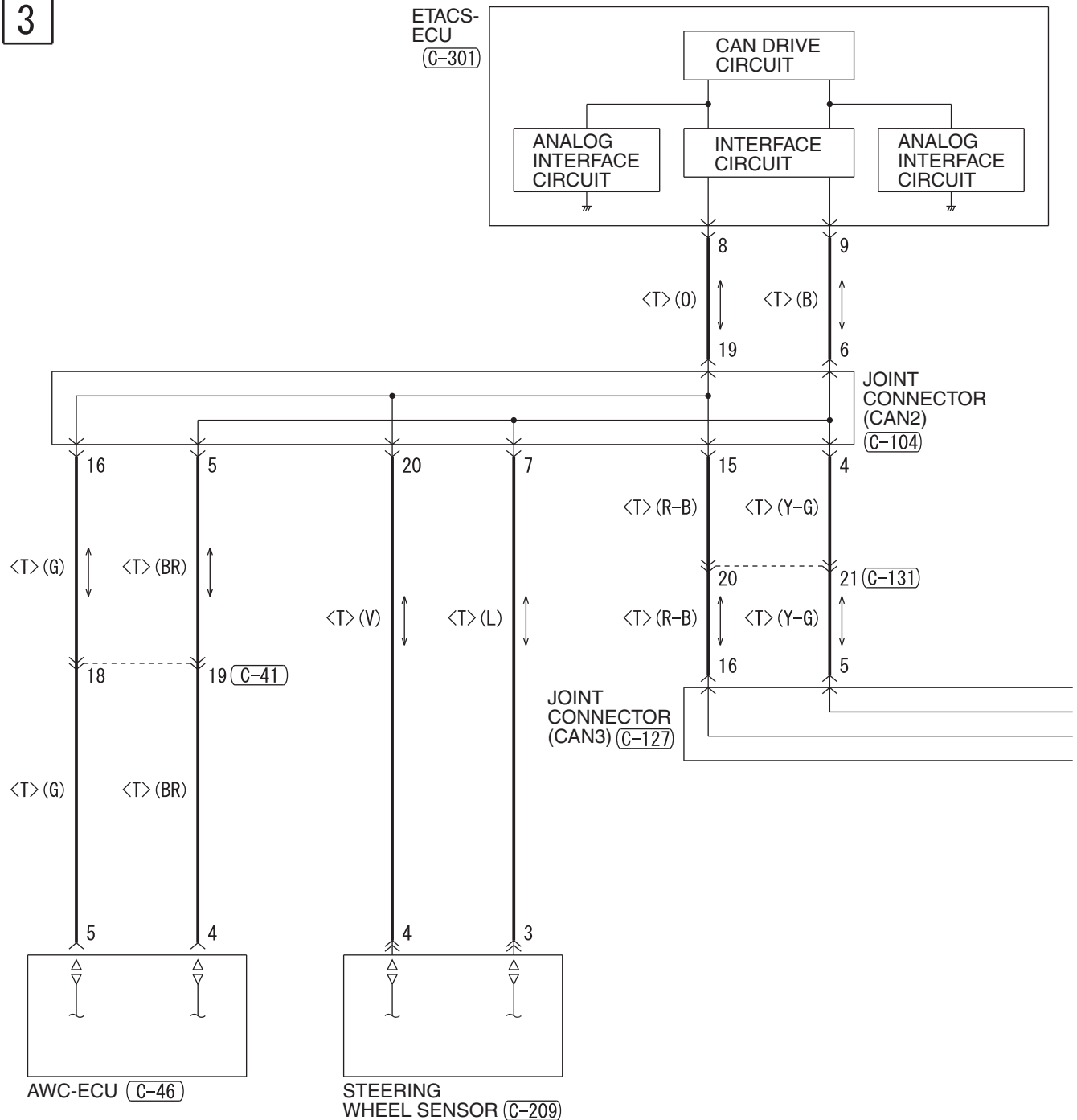

**NOTE**  
 \* : THE TERMINAL NUMBERS DESCRIBED  
 IN THE CIRCUIT DIAGRAM AGREE WITH  
 THE NUMBERS MARKED ON THE  
 TRANSAXLE ASSEMBLY CONNECTOR AND  
 HARNESS SIDE CONNECTOR.

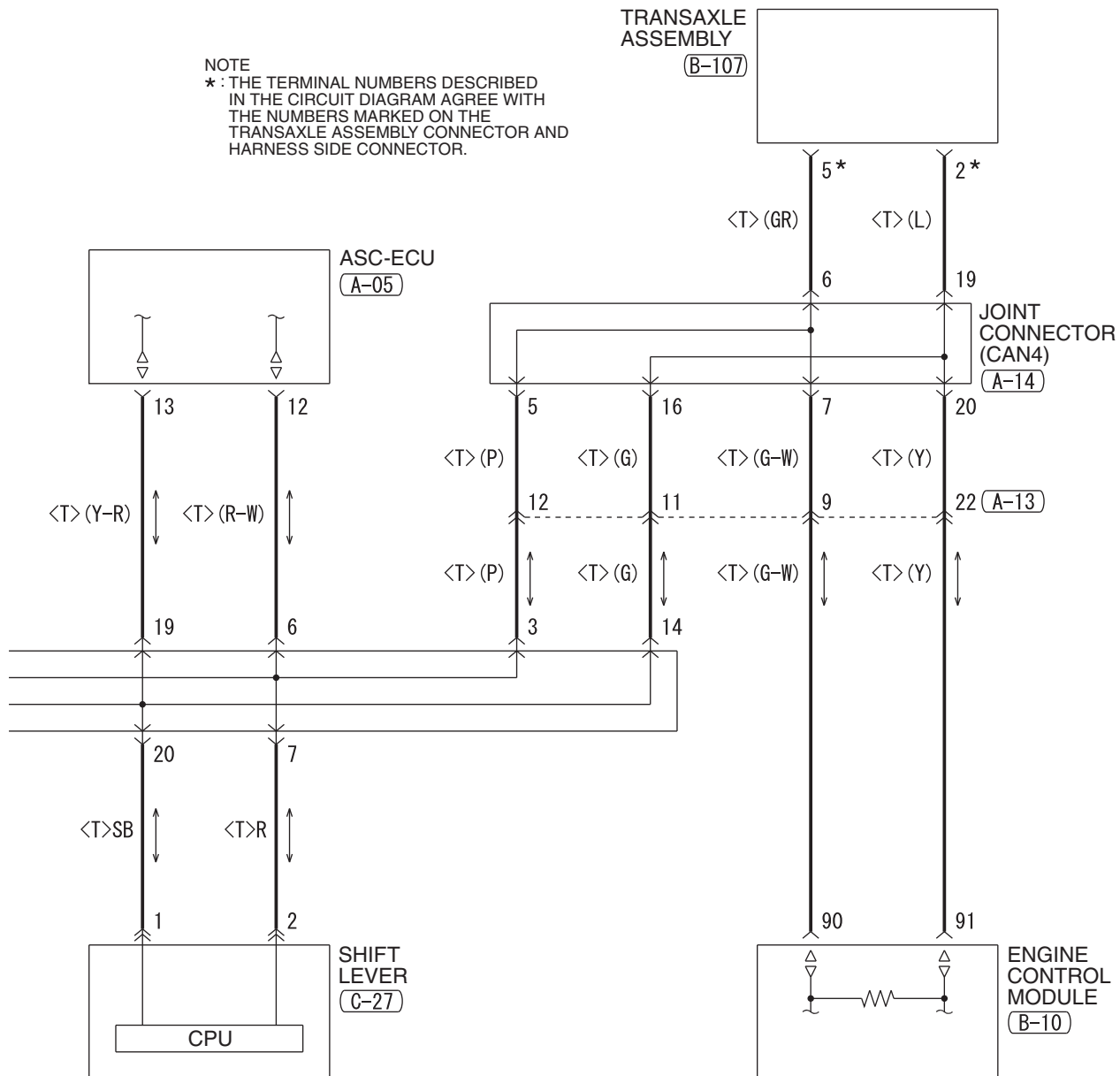

**(B-10)**

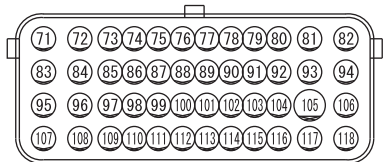

**(B-107)\***



**(C-27)**

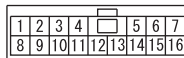

**(C-41)**

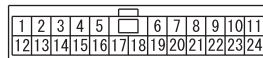

**(C-209)**



**(C-301)**

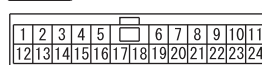

---

## NOTES