

## GROUP 13B

# MULTIPOINT FUEL INJECTION (MFI) <2.4L ENGINE>

## CONTENTS

<b>GENERAL INFORMATION</b> . . . . .	<b>13B-2</b>	FUEL PRESSURE TEST . . . . .	13B-997
<b>GENERAL SPECIFICATIONS</b> . . . . .	<b>13B-6</b>	HOW TO REDUCE PRESSURIZED FUEL PRESSURE . . . . .	13B-1000
<b>SERVICE SPECIFICATIONS</b> . . . . .	<b>13B-7</b>	FUEL TANK PUMP OPERATION CHECK . . . . .	13B-1001
<b>SEALANT AND ADHESIVE</b> . . . . .	<b>13B-7</b>	MULTIPOINT FUEL INJECTION (MFI) RELAY CONTINUITY CHECK . . . . .	13B-1002
<b>SPECIAL TOOL</b> . . . . .	<b>13B-8</b>	FUEL PUMP RELAY CONTINUITY CHECK . . . . .	13B-1003
<b>MULTIPOINT FUEL INJECTION (MFI) DIAGNOSIS</b> . . . . .	<b>13B-11</b>	INJECTOR RELAY CONTINUITY CHECK . . . . .	13B-1004
TROUBLESHOOTING STRATEGY . . . . .	13B-11	THROTTLE ACTUATOR CONTROL MOTOR RELAY CONTINUITY CHECK . . . . .	13B-1004
DIAGNOSTIC FUNCTION . . . . .	13B-12	INTAKE AIR TEMPERATURE SENSOR CHECK . . . . .	13B-1005
FAIL-SAFE FUNCTION REFERENCE TABLE . . . . .	13B-47	ENGINE COOLANT TEMPERATURE SENSOR CHECK . . . . .	13B-1005
DIAGNOSTIC TROUBLE CODE CHART . . . . .	13B-51	HEATED OXYGEN SENSOR CHECK . . . . .	13B-1006
SYMPTOM CHART . . . . .	13B-56	INJECTOR CHECK . . . . .	13B-1011
DIAGNOSTIC TROUBLE CODE PROCEDURES . . . . .	13B-60	THROTTLE ACTUATOR CONTROL MOTOR CHECK . . . . .	13B-1011
SYMPTOM PROCEDURES . . . . .	13A-714	ENGINE OIL CONTROL VALVE CHECK . . . . .	13B-1012
DATA LIST REFERENCE TABLE . . . . .	13B-947	EVAPORATIVE EMISSION VENTILATION SOLENOID CHECK . . . . .	13B-1014
GENERAL SCAN TOOL (GST) MODE 01 REFERENCE TABLE . . . . .	13B-963	EVAPORATIVE EMISSION PURGE SOLENOID CHECK . . . . .	13B-1014
ACTUATOR TEST REFERENCE TABLE . . . . .	13B-969	EGR VALVE CHECK . . . . .	13B-1014
CHECK AT THE ENGINE CONTROL MODULE (ECM) . . . . .	13B-970	<b>INJECTOR</b> . . . . .	<b>13B-1015</b>
INSPECTION PROCEDURE USING AN OSCILLOSCOPE . . . . .	13B-978	REMOVAL AND INSTALLATION . . . . .	13B-1015
<b>ON-VEHICLE SERVICE</b> . . . . .	<b>13B-991</b>	<b>THROTTLE BODY ASSEMBLY</b> . . . . .	<b>13B-1020</b>
COMPONENT LOCATION . . . . .	13B-991	REMOVAL AND INSTALLATION . . . . .	13B-1020
THROTTLE BODY (THROTTLE VALVE AREA) CLEANING . . . . .	13B-996	<b>ENGINE CONTROL MODULE (ECM)</b> . . . . .	<b>13B-1022</b>
		REMOVAL AND INSTALLATION . . . . .	13B-1022

## GENERAL INFORMATION

M1131000104974

The Multiport Fuel Injection System consists of sensors which detect the engine conditions, the ENGINE CONTROL MODULE (ECM) which controls the system based on signals from these sensors, and actuators which operate under the control of the ECM.

The ECM carries out activities such as fuel injection control, idle air control, and ignition timing control. In addition, the ECM is equipped with several diagnostic test modes which simplify troubleshooting when a problem develops.

### FUEL INJECTION CONTROL

The injector drive times and injection timing are controlled so that the optimum air/fuel mixture is supplied to the engine to correspond to the continually-changing engine operation conditions. A single injector is mounted at the intake port of each cylinder. Fuel is sent under pressure from the fuel tank to the fuel injectors by the fuel pump, with the pressure being regulated by the fuel pressure regulator. The regulated fuel is distributed to each of the injectors.

Fuel injection is normally carried out once for each cylinder for every two rotations of the crankshaft. The firing order is 1-3-4-2. Each cylinder has a dedicated fuel injector. This is called multiport.

The ECM provides a richer air/fuel mixture by carrying out "open-loop" control when the engine is cold or operating under high load conditions in order to maintain engine performance. In addition, when the engine is under normal operating temperature after warming-up, the ECM controls the air/fuel mixture by using the heated oxygen sensor signal to carry out "closed-loop" control. The closed-loop control achieves the theoretical air/fuel mixture ratio where the catalytic converter can obtain the maximum cleaning performance.

### THROTTLE VALVE OPENING CONTROL

This system electrically controls the opening of the throttle valve. The ECM detects the amount of travel of the accelerator pedal via the accelerator pedal position sensor, and controls the actuation of the throttle actuator control motor, which is mounted on the throttle body, in order to attain the target throttle valve opening that has been predetermined in accordance with driving conditions.

### IDLE AIR CONTROL

The idle speed is kept at the optimum speed by controlling the amount of air that passes through the throttle valve in accordance with changes in idling conditions and engine load during idling.

The ECM drives the throttle actuator control motor to keep the engine running at the pre-set idle target speed in accordance with the engine coolant temperature and A/C and other electrical load. In addition, when the air conditioning switch is turned off and on while the engine is idling, the throttle actuator control motor adjusts the throttle valve pass-through air amount according to the engine load conditions to avoid fluctuations in the engine speed.

### IGNITION TIMING CONTROL

The ignition power transistor located in the ignition primary circuit turns ON and OFF to control the primary current flow to the ignition coil. This controls the ignition timing to provide the optimum ignition timing with respect to the engine operating conditions. The ignition timing is determined by the ECM from engine speed, intake air volume, engine coolant temperature, and atmospheric pressure.

## DIAGNOSTIC TEST MODE

- When a fault is detected in one of the sensors or actuators related to emission control, the Malfunction Indicator Lamp (SERVICE ENGINE SOON or Check Engine Lamp) illuminates to warn the driver.
- When a fault is detected in one of the sensors or actuators, a diagnostic trouble code corresponding to the fault is stored in the ECM.
- The RAM data inside the ECM that is related to the sensors and actuators can be read with the scan tool. In addition, the actuators can be controlled by scan tool MB991958 (M.U.T.-III sub assembly) under certain circumstances.

## OTHER CONTROL FUNCTIONS

### Fuel Pump Control

- Turns the fuel pump relay ON so that current is supplied to the fuel pump while the engine is cranking or running.

### A/C Compressor Clutch Relay Control

- Turns the compressor clutch of the A/C ON and OFF.

### Engine Oil Control Valve Control

- The ECM carries out the duty control of the engine oil control valve according to the operation condition. This varies the phase angle of the camshaft to optimize the valve timing.

### Generator Output Current Control

- Prevent generator output current from increasing suddenly and idle speed from dropping at times such as when the headlights are turned on.

### Evaporative Emission Purge Control

- (Refer to GROUP 17, Emission Control –Evaporative Emission Control System –General Information [P.17-93.](#))

### EGR Control

- (Refer to GROUP 17, Emission Control –Exhaust Gas Recirculation (EGR) System <2.4L ENGINE> –General Information [P.17-102.](#))

MULTIPOINT FUEL INJECTION (MFI) SYSTEM DIAGRAM

<Except vehicles for California>

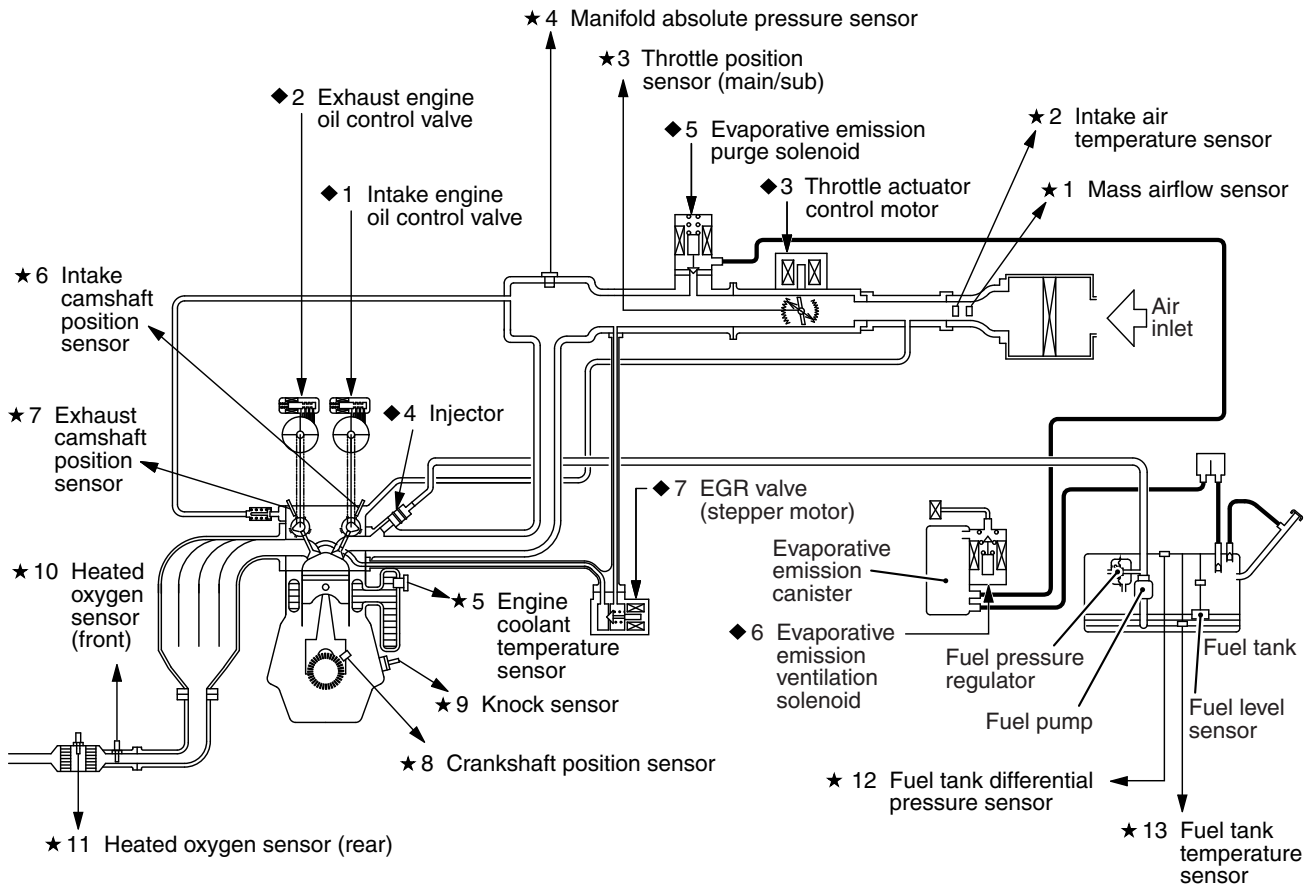
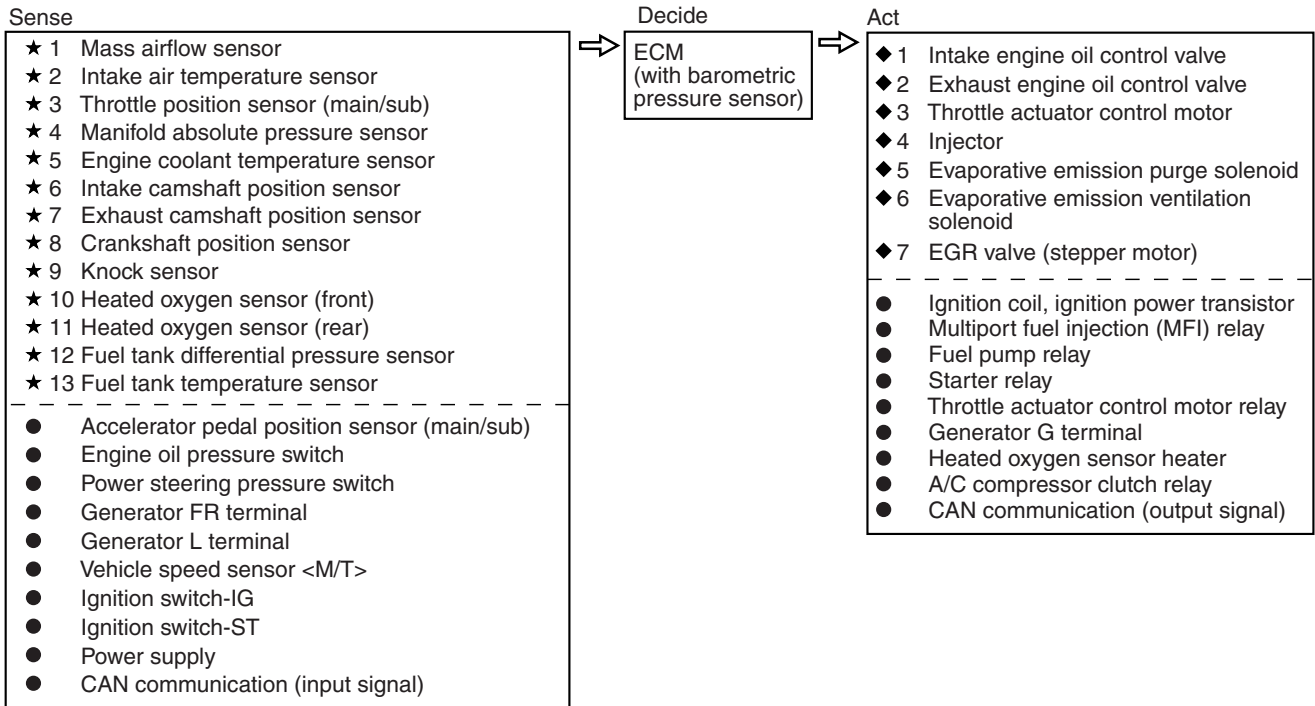

<Vehicles for California>

Sense

- ★1 Mass airflow sensor
  - ★2 Intake air temperature sensor
  - ★3 Throttle position sensor (main/sub)
  - ★4 Manifold absolute pressure sensor
  - ★5 Engine coolant temperature sensor
  - ★6 Intake camshaft position sensor
  - ★7 Exhaust camshaft position sensor
  - ★8 Crankshaft position sensor
  - ★9 Knock sensor
  - ★10 Heated oxygen sensor (front)
  - ★11 Heated oxygen sensor (rear)
  - ★12 Heated oxygen sensor (3rd)
  - ★13 Fuel tank differential pressure sensor
  - ★14 Fuel tank temperature sensor
- 
- Accelerator pedal position sensor (main/sub)
  - Engine oil pressure switch
  - Power steering pressure switch
  - Generator FR terminal
  - Generator L terminal
  - Vehicle speed sensor <M/T>
  - Ignition switch-IG
  - Ignition switch-ST
  - Power supply
  - CAN communication (input signal)

Decide

ECM  
(with barometric pressure sensor)

Act

- ◆1 Intake engine oil control valve
  - ◆2 Exhaust engine oil control valve
  - ◆3 Throttle actuator control motor
  - ◆4 Injector
  - ◆5 Evaporative emission purge solenoid
  - ◆6 Evaporative emission ventilation solenoid
  - ◆7 EGR valve (stepper motor)
- 
- Ignition coil, ignition power transistor
  - Multipoint fuel injection (MFI) relay
  - Fuel pump relay
  - Starter relay
  - Throttle actuator control motor relay
  - Generator G terminal
  - Heated oxygen sensor heater
  - A/C compressor clutch relay
  - CAN communication (output signal)

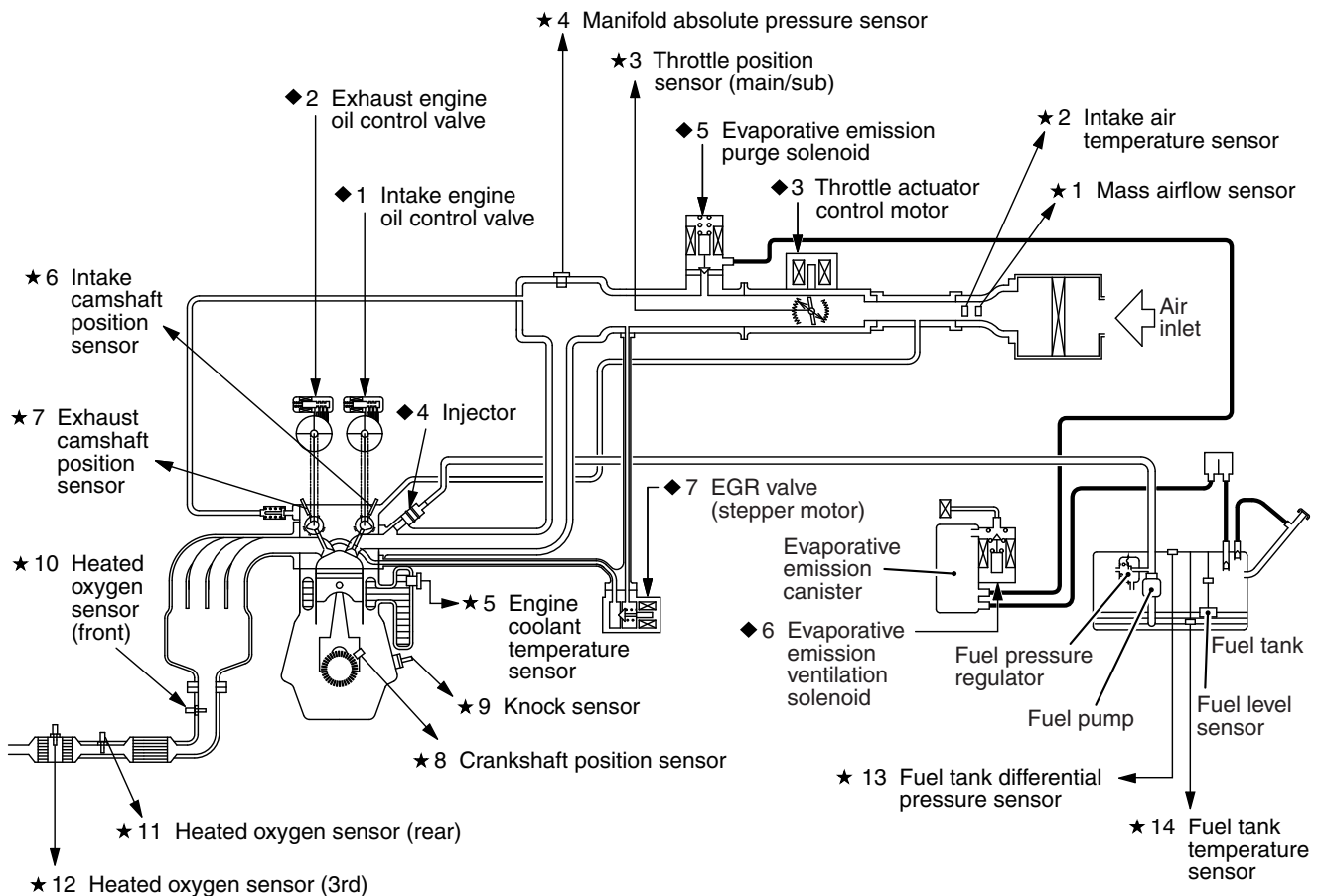

AK801822 AB

NOTE: For the vacuum routing, refer to GROUP 17, Emission Control -Vacuum Hoses -Vacuum Hose Routing P.17-87.

## GENERAL SPECIFICATIONS

M1131000201626

ITEMS		SPECIFICATIONS
Throttle body	Throttle bore mm (in.)	57 (2.24)
	Throttle position sensor	Hall element type
	Throttle actuator control motor	DC motor type, having brushes
Engine control module (ECM)	Identification model No.	Except vehicles for California E6T73381 <M/T> E6T73382 <CVT>
		Vehicles for California E6T73379 <M/T> E6T73380 <CVT>
Sensors	Mass airflow sensor	Heat sensitizing type
	Barometric pressure sensor	Semiconductor diffused pressure type
	Intake air temperature sensor	Thermistor type
	Engine coolant temperature sensor	Thermistor type
	Heated oxygen sensor	Zirconia type
	Accelerator pedal position sensor	Hall element type
	Intake camshaft position sensor	Magneto resistance element type
	Exhaust camshaft position sensor	Magneto resistance element type
	Crankshaft position sensor	Magneto resistance element type
	Knock sensor	Piezoelectric element type
	Power steering pressure switch	Contact switch type
	Manifold absolute pressure sensor	Piezo resistive semiconductor type
	Fuel tank differential pressure sensor	Piezo resistive semiconductor type
	Fuel tank temperature sensor	Thermistor type
	Vehicle speed sensor <M/T>	Magneto resistance element type
Actuators	Multiport fuel injection (MFI) relay	Contact switch type
	Fuel pump relay	Contact switch type
	Throttle actuator control motor relay	Contact switch type
	Starter relay	Contact switch type
	A/C compressor clutch relay	Contact switch type
	Injector type and number	Electromagnetic type, 4
	Injector identification mark	JME290H
	Intake engine oil control valve	Duty cycle type solenoid valve
	Exhaust engine oil control valve	Duty cycle type solenoid valve
	EGR valve	Stepper motor type
	Evaporative emission purge solenoid	Duty cycle type solenoid valve
	Evaporative emission ventilation solenoid	ON/OFF type solenoid valve

## SERVICE SPECIFICATIONS

M1131000302563

ITEMS		STANDARD VALUE
Fuel pressure kPa (psi)		Approximately 324 (47) at curb idle
Intake air temperature sensor resistance kΩ	-20° C (-4° F)	13 -17
	0° C (32° F)	5.4 -6.6
	20° C (68° F)	2.3 -3.0
	40° C (104° F)	1.0 -1.5
	60° C (140° F)	0.56 -0.76
	80° C (176° F)	0.31 -0.43
Engine coolant temperature sensor resistance kΩ	-20° C (-4° F)	14 -17
	0° C (32° F)	5.1 -6.5
	20° C (68° F)	2.1 -2.7
	40° C (104° F)	0.9 -1.3
	60° C (140° F)	0.48 -0.68
	80° C (176° F)	0.26 -0.36
Heated oxygen sensor output voltage V		0.6 -1.0
Heated oxygen sensor heater resistance Ω	Front, Rear	4.5 -8.0 [at 20° C (68° F)]
	3rd <Vehicles for California>	11 -18 [at 20° C (68° F)]
Injector coil resistance Ω		10.5 -13.5 [at 20° C (68° F)]
Throttle actuator control motor coil resistance Ω		0.3 -80 [at 20° C (68° F)]
Intake engine oil control valve coil resistance Ω		6.9 -7.9 [at 20° C (68° F)]
Exhaust engine oil control valve coil resistance Ω		6.9 -7.9 [at 20° C (68° F)]



## SEALANT AND ADHESIVE

M1131000501779

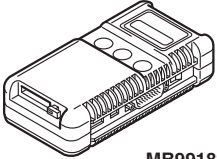

ITEM	SPECIFIED SEALANT
Engine coolant temperature sensor threaded portion	LOCTITE 262, Three bond 1324N or equivalent

**SPECIAL TOOL**

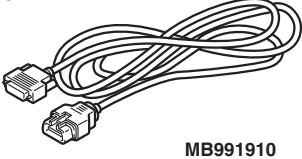
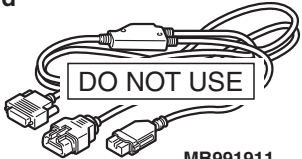
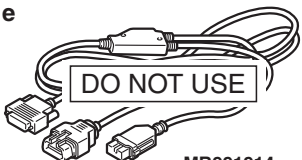
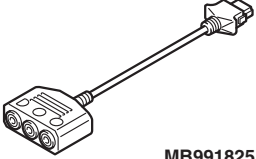
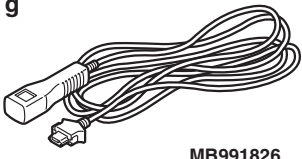
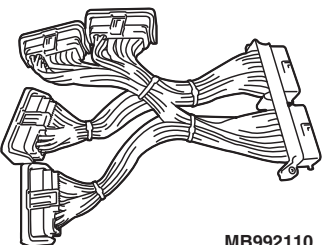
M113100603181

Tool	Tool number and name	Supersession	Application
<p>a</p>  <p>MB991824</p> <p>b</p>  <p>MB991827</p> <p>c</p>  <p>MB991910</p> <p>d</p>  <p>MB991911</p> <p>e</p>  <p>MB991914</p> <p>f</p>  <p>MB991825</p> <p>g</p>  <p>MB991826 MB991958</p>	<p>MB991958 a: MB991824 b: MB991827 c: MB991910 d: MB991911 e: MB991914 f: MB991825 g: MB991826 M.U.T.-III sub assembly a: Vehicle Communication Interface (V.C.I.) b: M.U.T.-III USB Cable c: M.U.T.-III Main Harness A (Vehicles with CAN communication system) d: M.U.T.-III Main Harness B (Vehicles without CAN communication system) e: M.U.T.-III Main Harness C (for Chrysler models only) f: M.U.T.-III Measurement Adapter g: M.U.T.-III Trigger Harness</p>	<p>MB991824-KIT <i>NOTE: g: MB991826 M.U.T.-III Trigger Harness is not necessary when pushing V.C.I. ENTER key.</i></p>	<p><b>CAUTION</b> For vehicles with CAN communication, use M.U.T.-III main harness A to send simulated vehicle speed. If you connect M.U.T.-III main harness B instead, the CAN communication does not function correctly.</p> <ul style="list-style-type: none"> <li>• Reading diagnostic trouble code</li> <li>• MFI system inspection</li> <li>• Measurement of fuel pressure</li> </ul>
 <p>MB992110</p>	<p>MB992110 Power plant ECU check harness</p>	<p>-</p>	<ul style="list-style-type: none"> <li>• Inspection using an oscilloscope</li> <li>• Inspection of the engine control module (ECM) terminal voltage check</li> </ul>

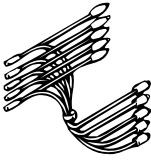

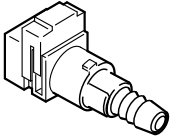
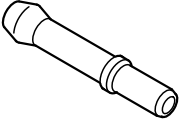
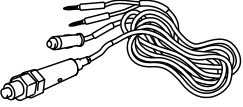
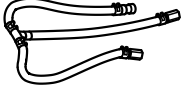
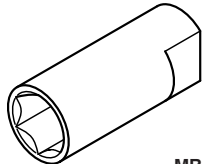
<b>Tool</b>	<b>Tool number and name</b>	<b>Supersession</b>	<b>Application</b>
	MB991709 Test harness	MB991709-01	Inspection using an oscilloscope
 MB991658	MB991658 Test harness	Tool not available	<ul style="list-style-type: none"> <li>• Inspection using an oscilloscope</li> <li>• Inspection of throttle position sensor</li> <li>• Inspection of heated oxygen sensor</li> <li>• Inspection of engine oil control valve</li> </ul>
	MD998464 Test harness (4 pin, square)	Tool not available	Inspection of heated oxygen sensor
 MB992049	MB992049	MB992049-01	Measurement of fuel pressure
 MB992001	MB992001	Hose adaptor	Measurement of fuel pressure
 MB991981	MB991981 Fuel pressure gauge set	Tool not available	Measurement of fuel pressure
 MB992076	MB992076	Injector test set	Measurement of fuel pressure
 MB992042	MB992042 Engine coolant temperature sensor wrench	-	Removal and installation of the engine coolant temperature sensor

# 13B-10

## MULTIPOINT FUEL INJECTION (MFI) <2.4L ENGINE> SPECIAL TOOL

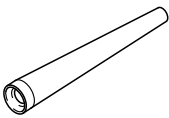
Tool	Tool number and name	Supersession	Application
 <p data-bbox="326 352 402 373">B992106</p>	MB992106 O-ring installer	-	Installation of O-ring on fuel injector injection nozzle side

## MULTIPOINT FUEL INJECTION (MFI) DIAGNOSIS

### TROUBLESHOOTING STRATEGY

M1131150002412

*NOTE: If a DTC is erased, its "freeze frame" data will also be erased and system readiness test status will be reset. Store the "freeze frame" data before erasing the DTC.*

Use these steps to plan your diagnostic strategy. If you follow them carefully, you will be sure to have exhausted most of the possible ways to find an MFI fault.

1. Gather as much information as possible about the complaint from the customer.
2. Verify that the condition described by the customer exists.
3. Check the vehicle for any MFI Diagnostic Trouble Code (DTC).
4. If you cannot verify the condition and there are no DTCs, the malfunction is intermittent. For information on how to cope with intermittent malfunctions, refer to GROUP 00, How to Use Troubleshooting/Inspection Service Points –How to Cope with Intermittent Malfunctions [P.00-13](#).
5. If you can verify the condition but there are no DTCs, or the system cannot communicate with the scan tool, refer to the trouble symptom classification table.
6. If there is a DTC, store the number of the code, then erase the code from the memory using the scan tool.
7. Reconfirm the malfunction symptom and carry out a test drive with the drive cycle pattern.
8. If DTC is set again, carry out an inspection with appropriate diagnostic trouble code procedures.
9. If DTC is not set again, the malfunction is intermittent. For information on how to cope with intermittent malfunctions, refer to GROUP 00, How to Use Troubleshooting/Inspection Service Points –How to Cope with Intermittent Malfunctions [P.00-13](#).
10. After repairs are completed, conduct a road test duplicating the complaint set conditions to confirm the malfunction has been corrected.
11. Erase the permanent DTC. (Refer to Diagnostic Function –Permanent DTC for the procedures of erasing the permanent DTC [P.13B-12](#).)

*NOTE: This is carried out to prevent the failure to pass the Inspection and Maintenance (I/M) test in the states checking whether the permanent DTC is stored or not.*

## DIAGNOSTIC FUNCTION

M1131155503783

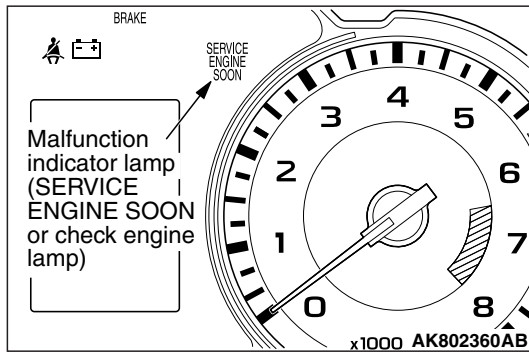
**MALFUNCTION INDICATOR LAMP (SERVICE ENGINE SOON OR CHECK ENGINE LAMP)**

Among the on-board diagnostic items, Malfunction Indicator Lamp (SERVICE ENGINE SOON or Check Engine Lamp) illuminates to notify the driver of an emission control malfunction. However, when an irregular signal returns to normal and the engine control module judges that it has returned to normal, the Malfunction Indicator Lamp (SERVICE ENGINE SOON or Check Engine Lamp) will switch off.

There are two methods for checking the Malfunction Indicator Lamp (SERVICE ENGINE SOON or Check Engine Lamp) burn out: When the ignition switch is in ON position, the Malfunction Indicator Lamp (SERVICE ENGINE SOON or Check Engine Lamp) is illuminated, and then extinguished few seconds later. When the ignition switch is in ON position and the engine starts, the Malfunction Indicator Lamp (SERVICE ENGINE SOON or Check Engine Lamp) is extinguished.

*NOTE: When the Transaxle Control Module (TCM) detects malfunctions related to the CVT, the Malfunction indicator Lamp (SERVICE ENGINE SOON or Check Engine Lamp) is also illuminated.*

**Items Indicated by the Malfunction Indicator Lamp (SERVICE ENGINE SOON or Check Engine Lamp)**

<b>DTC</b>	<b>ITEM</b>
P0010	Intake engine oil control valve circuit
P0011	Intake variable valve timing system target error
P0013	Exhaust engine oil control valve circuit
P0014	Exhaust variable valve timing system target error
P0016	Crankshaft/camshaft (intake) position sensor phase problem
P0017	Crankshaft/camshaft (exhaust) position sensor phase problem
P0031	Heated oxygen sensor (front) heater control circuit low
P0032	Heated oxygen sensor (front) heater control circuit high
P0037	Heated oxygen sensor (rear) heater control circuit low
P0038	Heated oxygen sensor (rear) heater control circuit high
P0043	Heated oxygen sensor (3rd) heater control circuit low <Vehicles for California>
P0044	Heated oxygen sensor (3rd) heater control circuit high <Vehicles for California>
P0069	Abnormal correlation between manifold absolute pressure sensor and barometric pressure sensor
P0101* <sup>1</sup>	Mass airflow circuit range/performance problem
P0102* <sup>1</sup>	Mass airflow circuit low input
P0103* <sup>1</sup>	Mass airflow circuit high input
P0106	Manifold absolute pressure circuit range/performance problem
P0107	Manifold absolute pressure circuit low input
P0108	Manifold absolute pressure circuit high input
P0111* <sup>1</sup>	Intake air temperature circuit range/performance problem
P0112* <sup>1</sup>	Intake air temperature circuit low input
P0113* <sup>1</sup>	Intake air temperature circuit high input
P0116* <sup>1</sup>	Engine coolant temperature circuit range/performance problem
P0117* <sup>1</sup>	Engine coolant temperature circuit low input
P0118* <sup>1</sup>	Engine coolant temperature circuit high input
P0122* <sup>1</sup>	Throttle position sensor (main) circuit low input
P0123* <sup>1</sup>	Throttle position sensor (main) circuit high input
P0125* <sup>1</sup>	Insufficient coolant temperature for closed loop fuel control
P0128	Coolant thermostat (coolant temperature below thermostat regulating temperature)
P0131	Heated oxygen sensor (front) circuit low voltage
P0132	Heated oxygen sensor (front) circuit high voltage
P0133	Heated oxygen sensor (front) circuit slow response
P0134* <sup>1</sup>	Heated oxygen sensor (front) circuit no activity detected
P0137	Heated oxygen sensor (rear) circuit low voltage
P0138	Heated oxygen sensor (rear) circuit high voltage

<b>DTC</b>	<b>ITEM</b>
P0139	Heated oxygen sensor (rear) circuit slow response
P0140	Heated oxygen sensor (rear) circuit no activity detected
P0143	Heated oxygen sensor (3rd) circuit low voltage <Vehicles for California>
P0144	Heated oxygen sensor (3rd) circuit high voltage <Vehicles for California>
P0145	Heated oxygen sensor (3rd) circuit slow response <Vehicles for California>
P0146	Heated oxygen sensor (3rd) circuit no activity detected <Vehicles for California>
P0171	System too lean
P0172	System too rich
P0181	Fuel tank temperature sensor circuit range/performance
P0182	Fuel tank temperature sensor circuit low input
P0183	Fuel tank temperature sensor circuit high input
P0201	Injector circuit-cylinder 1
P0202	Injector circuit-cylinder 2
P0203	Injector circuit-cylinder 3
P0204	Injector circuit-cylinder 4
P0222 <sup>*1</sup>	Throttle position sensor (sub) circuit low input
P0223 <sup>*1</sup>	Throttle position sensor (sub) circuit high input
P0300 <sup>*2</sup>	Random/multiple cylinder misfire detected
P0301 <sup>*2</sup>	Cylinder 1 misfire detected
P0302 <sup>*2</sup>	Cylinder 2 misfire detected
P0303 <sup>*2</sup>	Cylinder 3 misfire detected
P0304 <sup>*2</sup>	Cylinder 4 misfire detected
P0327	Knock sensor circuit low
P0328	Knock sensor circuit high
P0335 <sup>*1</sup>	Crankshaft position sensor circuit
P0340 <sup>*1</sup>	Intake camshaft position sensor circuit
P0365 <sup>*1</sup>	Exhaust camshaft position sensor circuit
P0401	Exhaust gas recirculation flow insufficient detected
P0420	Warm up catalyst efficiency below threshold <Except vehicles for California>
P0421	Warm up catalyst efficiency below threshold <Vehicles for California>
P0441	Evaporative emission control system incorrect purge flow
P0442	Evaporative emission control system leak detected (small leak)
P0443	Evaporative emission control system purge control valve circuit
P0446	Evaporative emission control system vent control circuit
P0450	Evaporative emission control system pressure sensor malfunction
P0451	Evaporative emission control system pressure sensor range/performance
P0452	Evaporative emission control system pressure sensor low input
P0453	Evaporative emission control system pressure sensor high input

<b>DTC</b>	<b>ITEM</b>
P0455	Evaporative emission control system leak detected (gross leak)
P0456	Evaporative emission control system leak detected (very small leak)
P0461	Fuel level sensor circuit range/performance
P0462	Fuel level sensor circuit low input
P0463	Fuel level sensor circuit high input
P0489	EGR valve (stepper motor) circuit malfunction (ground short)
P0490	EGR valve (stepper motor) circuit malfunction (battery short)
P0500 <sup>*1</sup>	Vehicle speed sensor malfunction <M/T>
P0506	Idle control system RPM lower than expected
P0507	Idle control system RPM higher than expected
P050B	Ignition timing retard insufficient
P0551	Power steering pressure switch circuit range/performance
P0554	Power steering pressure switch circuit intermittent
P0603 <sup>*1</sup>	EEPROM malfunction
P0606 <sup>*1</sup>	Engine control module main processor malfunction
P0630 <sup>*1</sup>	Vehicle Identification Number (VIN) malfunction
P0638 <sup>*1</sup>	Throttle actuator control motor circuit range/ performance
P0642 <sup>*1</sup>	Throttle position sensor power supply
P0657 <sup>*1</sup>	Throttle actuator control motor relay circuit malfunction
P1233 <sup>*1</sup>	Throttle position sensor (main) plausibility
P1234 <sup>*1</sup>	Throttle position sensor (sub) plausibility
P1235 <sup>*1</sup>	Mass airflow sensor plausibility
P1236 <sup>*1</sup>	A/D converter
P1237 <sup>*1</sup>	Accelerator pedal position sensor plausibility
P1238 <sup>*1</sup>	Mass airflow sensor plausibility (torque monitor)
P1239 <sup>*1</sup>	Engine RPM plausibility
P1241 <sup>*1</sup>	Torque monitor
P1506	Idle control system RPM lower than expected at low temperature
P1507	Idle control system RPM higher than expected at low temperature
P1590 <sup>*1</sup>	TCM to ECM communication error in torque reduction request <CVT>
P1603 <sup>*1</sup>	Battery backup circuit malfunction
P1676 <sup>*1</sup>	Variant coding
P2096	Post catalyst fuel trim system too lean
P2097	Post catalyst fuel trim system too rich
P2100 <sup>*1</sup>	Throttle actuator control motor circuit (open)
P2101 <sup>*1</sup>	Throttle actuator control motor magneto malfunction
P2122 <sup>*1</sup>	Accelerator pedal position sensor (main) circuit low input

DTC	ITEM
P2123*1	Accelerator pedal position sensor (main) circuit high input
P2127*1	Accelerator pedal position sensor (sub) circuit low input
P2128*1	Accelerator pedal position sensor (sub) circuit high input
P2135*1	Throttle position sensor (main and sub) range/performance problem
P2138*1	Accelerator pedal position sensor (main and sub) range/performance problem
P2195	Heated oxygen sensor (front) inactive
P2228*1	Barometric pressure circuit low input
P2229*1	Barometric pressure circuit high input
P2252	Heated oxygen sensor offset circuit low voltage
P2253	Heated oxygen sensor offset circuit high voltage
P2423	HC adsorber (HC trap catalyst) efficiency below threshold <Vehicles for California>
U0101*1	TCM time-out <CVT>
U0141*1	ETACS-ECU time-out
U1180*1	Combination meter time-out

*NOTE: If the Malfunction Indicator Lamp (SERVICE ENGINE SOON or Check Engine Lamp) illuminates because of a malfunction of the engine control module (ECM), communication between the scan tool MB991958 (M.U.T.-III sub assembly) and the ECM is impossible. In this case, the diagnostic trouble code cannot be read.*

*NOTE: After the ECM has detected a malfunction, the Malfunction Indicator Lamp (SERVICE ENGINE SOON or Check Engine Lamp) illuminates when the engine is next turned on and the same malfunction is re-detected. However, for items marked with a "\*1" in the DTC NO. column, the Malfunction Indicator Lamp (SERVICE ENGINE SOON or Check Engine Lamp) illuminates only on the first detection of the malfunction.*

*NOTE: The codes marked with a "\*2" in the diagnosis code number column have the following two conditions for illuminating the Malfunction Indicator Lamp (SERVICE ENGINE SOON or Check Engine Lamp).*

- In case that the misfire causing the damaged catalyst is detected, the Malfunction Indicator Lamp (SERVICE ENGINE SOON or Check Engine Lamp) is illuminated at the time.
- In case that the misfire deteriorating the exhaust gas is detected, the Malfunction Indicator Lamp (SERVICE ENGINE SOON or Check Engine Lamp) is illuminated when the same malfunction is re-detected after the next engine start.

*NOTE: After the Malfunction Indicator Lamp (SERVICE ENGINE SOON or Check Engine Lamp) illuminates, it will be switched off under the following conditions.*

- When the ECM monitored the powertrain malfunction three times\* and met set condition requirements, it detected no malfunction. \*: In this case, "one time" indicates from engine start to next engine start.
- For misfiring or a fuel trim malfunction, when driving conditions (engine speed, engine coolant temperature, etc.) are similar to those when the malfunction was first recorded.
- The illuminated Malfunction Indicator Lamp (SERVICE ENGINE SOON or Check Engine Lamp) for the vehicle identification number related faults is extinguished when the vehicle identification number is detected.



## HOW TO CONNECT THE SCAN TOOL (M.U.T.-III)

### Required Special Tool:

- MB991958: Scan Tool (M.U.T.-III Sub Assembly)
  - MB991824: V.C.I.
  - MB991827: USB Cable
  - MB991910: Main Harness A

### **⚠ CAUTION**

To prevent damage to scan tool MB991958, always turn the ignition switch to the "LOCK" (OFF) position before connecting or disconnecting scan tool MB991958.

1. Ensure that the ignition switch is at the "LOCK" (OFF) position.
2. Start up the personal computer.
3. Connect special tool MB991827 to special tool MB991824 and the personal computer.
4. Connect special tool MB991910 to special tool MB991824.
5. Connect special tool MB991910 to the data link connector.
6. Turn the power switch of special tool MB991824 to the "ON" position.

*NOTE: When the special tool MB991824 is energized, special tool MB991824 indicator light will be illuminated in a green color.*

7. Start the M.U.T.-III system on the personal computer.

*NOTE: Disconnecting the scan tool MB991958 is the reverse of the connecting sequence, making sure that the ignition switch is at the "LOCK" (OFF) position.*

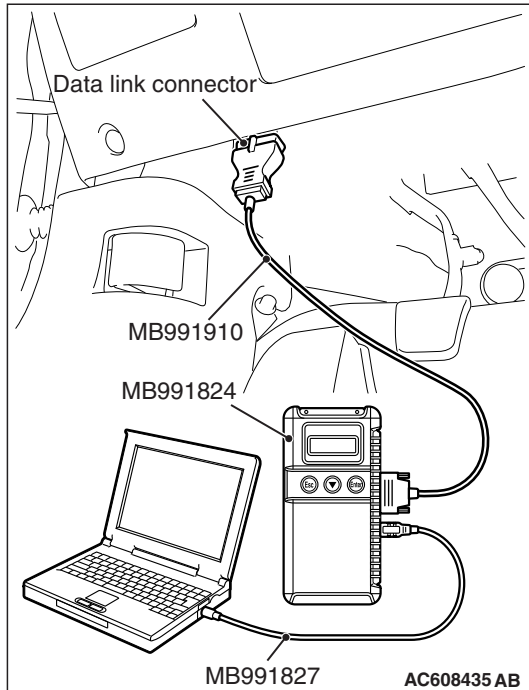

## HOW TO READ AND ERASE DIAGNOSTIC TROUBLE CODES.

### Required Special Tool:

- MB991958: Scan Tool (M.U.T.-III Sub Assembly)
  - MB991824: V.C.I.
  - MB991827: USB Cable
  - MB991910: Main Harness A

**⚠ CAUTION**

To prevent damage to scan tool MB991958, always turn the ignition switch to the "LOCK" (OFF) position before connecting or disconnecting scan tool MB991958.

1. Connect scan tool MB991958 to the data link connector.
2. Turn the ignition switch to the "ON" position.
3. Select "System select."
4. Choose "from 2006 MY" under "MODEL YEAR".
5. Check that "Vehicle Information" contents are correct.
6. Choose "MFI".
7. Select "Diagnostic Trouble Code"
8. If a DTC is set, it is shown.
9. Choose "Erase DTCs" to erase the DTC.

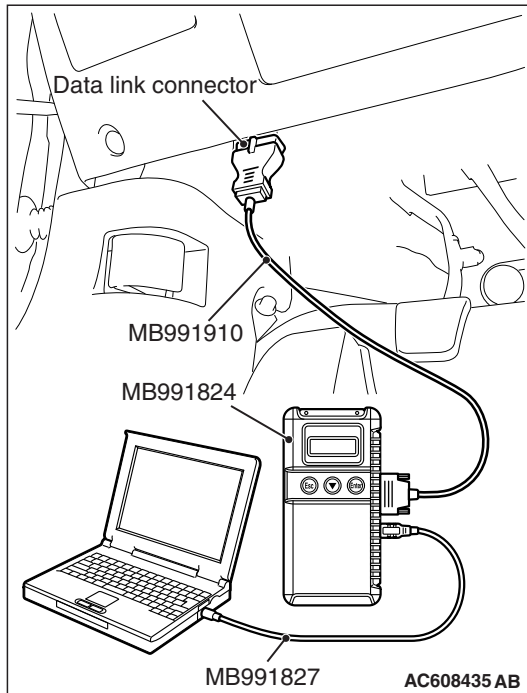
**HOW TO READ DATA LIST****Required Special Tool:**

- MB991958: Scan Tool (M.U.T.-III Sub Assembly)
  - MB991824: V.C.I.
  - MB991827: USB Cable
  - MB991910: Main Harness A

**⚠ CAUTION**

To prevent damage to scan tool MB991958, always turn the ignition switch to the "LOCK" (OFF) position before connecting or disconnecting scan tool MB991958.

1. Connect scan tool MB991958 to the data link connector.
2. Turn the ignition switch to the "ON" position.
3. Select "System select."
4. Choose "from 2006 MY" under "MODEL YEAR".
5. Check that "Vehicle Information" contents are correct.
6. Choose "MFI".
7. Select "Data List."
8. Choose an appropriate item and select the "OK" button.

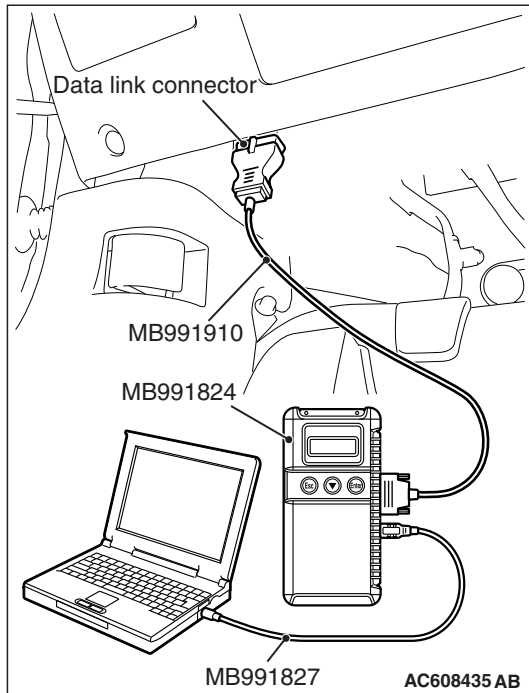

## HOW TO PERFORM ACTUATOR TEST

### Required Special Tool:

- MB991958: Scan Tool (M.U.T.-III Sub Assembly)
  - MB991824: V.C.I.
  - MB991827: USB Cable
  - MB991910: Main Harness A

**⚠ CAUTION**

To prevent damage to scan tool MB991958, always turn the ignition switch to the "LOCK" (OFF) position before connecting or disconnecting scan tool MB991958.

1. Connect scan tool MB991958 to the data link connector.
2. Turn the ignition switch to the "ON" position.
3. Select "System select."
4. Choose "from 2006 MY" under "MODEL YEAR".
5. Check that "Vehicle Information" contents are correct.
6. Choose "MFI".
7. Select "Actuator Test."
8. Choose an appropriate item and select the "OK" button.

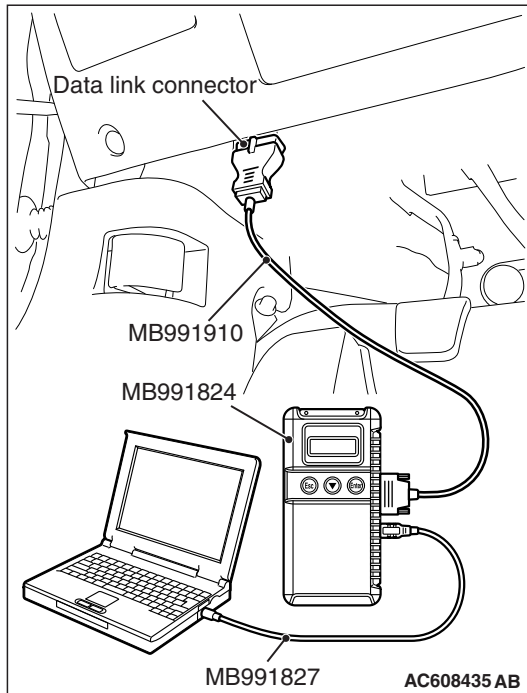

## HOW TO DIAGNOSE THE CAN BUS LINES

### Required Special Tool:

- MB991958: Scan Tool (M.U.T.-III Sub Assembly)
  - MB991824: V.C.I.
  - MB991827: USB Cable
  - MB991910: Main Harness A



## CONFIRMATION METHOD

### **⚠ CAUTION**

To prevent damage to scan tool MB991958, always turn the ignition switch to the "LOCK" (OFF) position before connecting or disconnecting scan tool MB991958.

1. Connect scan tool MB991958 to the data link connector.
2. Turn the ignition switch to the "ON" position.
3. Select "System select."
4. Choose "from 2006 MY" under "MODEL YEAR".
5. Check that "Vehicle Information" contents are correct.
6. Choose "MFI".
7. Select "Special Function" from MFI Screen.
8. Select "Provisional DTCs" from Special Function Screen.

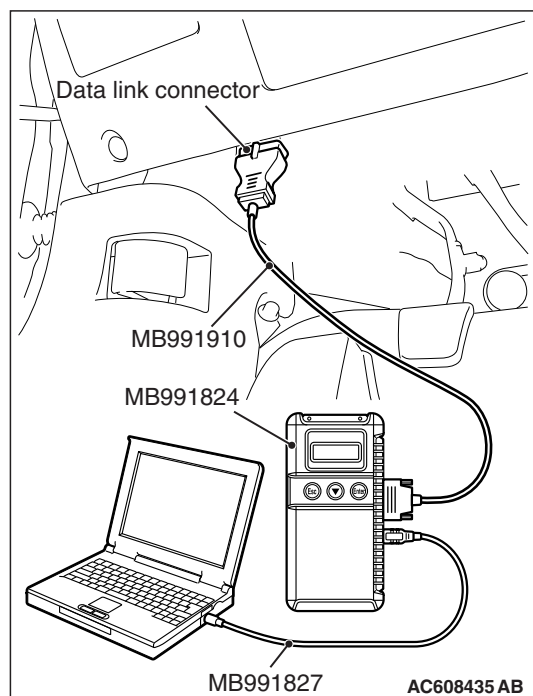

## PERMANENT DTC

The permanent DTC(PDTC) is stored in the EEPROM of the engine control module (ECM) as the permanent status, which checks that the malfunction of the emission related components/ the system has not been repaired yet. When detecting the malfunction necessary to illuminate the malfunction indicator lamp (SERVICE ENGINE SOON or Check Engine Lamp), the ECM illuminates the MIL and stores the appropriate DTC as the permanent DTC in the EEPROM concurrently. The usual DTC is stored in the EEPROM aside from this. The ECM can store up to 6 PDTCs. The ECM, therefore, cannot store the 7th and subsequent PDTCs. If the temporary malfunction causes the malfunction indicator lamp to be illuminated and then the reinstatement during the subsequent driving causes it to be extinguished, the PDTC is erased. Also if the ECM checks that the DTC malfunction is fixed during the driving after the DTC repair is completed, the PDTC is erased. The permanent DTC, however, is not erased by disconnecting the battery terminal or erasing with the scan tool (M.U.T-III). The permanent DTC can be erased if all readiness statuses are erased or not completed at the time of reprogramming the ECM. If must be erased while the vehicle is repaired, the PDTC can be erased by the procedures shown below. If must be erased because of the failure to pass the Inspection and Maintenance (I/M) test, the permanent DTC can also be erased by the following procedure:

### PROCEDURES FOR ERASING PERMANENT DTC

1. Check that the DTC is not stored. If the DTC is stored, perform the DTC troubleshooting, then repair the DTC.  
*NOTE: The order of step 2 and 3 can be exchanged.*
2. Drive the vehicle at least once under the conditions satisfying all the following requirements:
  - The total driving (engine running) time must be more than 10 consecutive minutes.
  - More than 30 seconds of idling must be included in the driving
  - More than 5 consecutive minutes of driving at more than 40 km/h (25 mph) must be included in the driving.
3. Drive the vehicle at least two times in the drive cycle pattern suitable for the permanent DTC. (Refer to OBD-II DRIVE CYCLE for the drive cycle pattern.) If the DTC does not have the drive cycle pattern, start and stop the engine. Wait 15 seconds or more to start again after the stop. Repeat at least 2 times.
4. Restart and stop the engine.
5. Check that the permanent DTC is erased. If the permanent DTC is not erased, check the DTC or the provisional DTC. If the malfunction code is stored, repair the DTC. Try to erase the permanent DTC again (from Step 1 to 5). If the malfunction code is not stored, the drive cycle pattern (Step 3) monitoring the malfunction can possibly be insufficient.

### MODE 6 REFERENCE TABLE

The engine control module (ECM) monitors the condition of emission control system.

By selecting MODE 6 using scan tool, Test Result and Limit Value (minimum) \*1 or (maximum) \*2 about the main items of emission control system which ECM monitors can be confirmed. The value at the last monitoring is output by ECM as a test result.

ON-BOARD DIAGNOSTIC MONITOR ID	STANDARDIZED / MANUFACTURER DEFIND TEST ID	MONITORING ITEM	SIMPLE TECHNICAL DESCRIPTION	CONVERSION COEFFICIENT IN USING GENERAL SCAN TOOL
01	81	Oxygen Sensor Monitor Bank 1 –Sensor 1 Rich/Lean Switching frequency	ECM monitors the deteriorated condition of the heated oxygen sensor (front) by checking the rich/lean switching frequency of the heated oxygen sensor (front).	× 1 count
02	08	Oxygen Sensor Monitor Bank 1 –Sensor 2 Maximum Sensor Voltage for Test Cycle	ECM checks the output voltage of the heated oxygen sensor (rear) in order to monitor whether the heated oxygen sensor (rear) outputs the rich signal.	× 0.122mV
	82	Oxygen Sensor Monitor Bank 1 –Sensor 2 Output Voltage change	ECM checks the output voltage of the heated oxygen sensor (rear) in order to monitor whether the heated oxygen sensor (rear) output is stuck.	× 0.122 mV
	05	Oxygen Sensor Monitor Bank 1 –Sensor 2 Rich To Lean Sensor Switch Time	ECM checks the rich to lean switching time of the heated oxygen sensor (rear) in order to monitor the response of the heated oxygen sensor (rear).	× 1 msec
	88	Oxygen Sensor Monitor Bank 1 –Sensor 2 Output Voltage drop slope	ECM checks the output voltage drop slope of the heated oxygen sensor (rear) in order to monitor the response of the heated oxygen sensor (rear).	× 1 msec



ON-BOARD DIAGNOSTIC MONITOR ID	STANDARDIZED / MANUFACTURER DEFINED TEST ID	MONITORING ITEM	SIMPLE TECHNICAL DESCRIPTION	CONVERSION COEFFICIENT IN USING GENERAL SCAN TOOL
03 <Vehicles for California>	82	Oxygen Sensor Monitor Bank 1 –Sensor 3 Output Voltage change	ECM checks the output voltage of the heated oxygen sensor (3rd) in order to monitor whether the heated oxygen sensor (3rd) output is stuck.	× 0.122 mV
	05	Oxygen Sensor Monitor Bank 1 –Sensor 3 Rich To Lean Sensor Switch Time	ECM checks the rich to lean switching time of the heated oxygen sensor (3rd) in order to monitor the response of the heated oxygen sensor (3rd).	× 1 msec
	88	Oxygen Sensor Monitor Bank 1 –Sensor 3 Output Voltage drop slope	ECM checks the output voltage drop slope of the heated oxygen sensor (3rd) in order to monitor the response of the heated oxygen sensor (3rd).	× 1 msec
21	83	Catalyst Monitor Bank 1 Frequency ratio between Front- and Rear-Oxygen Sensors	ECM monitors the deterioration of catalyst by the output frequency ratio between heated oxygen sensor (front) and heated oxygen sensor (rear).	× 0.0039
31	84	EGR Monitor Difference of manifold pressure before and after EGR activation	ECM monitors the operation of EGR system by the pressure difference of intake manifold between before and after introduction of EGR using the manifold absolute pressure sensor.	× 0.0117 kPa
35	89	VVT Monitor Bank 1 (L4-IN) Cam Phase Angle Deviation (between target and actual position)	ECM monitors the deviation between the intake camshaft target phase angle and the intake camshaft actual phase angle.	× 0.01°
36	89	VVT Monitor Bank 2 (L4-EX) Cam Phase Angle Deviation (between target and actual position)	ECM monitors the deviation between the exhaust camshaft target phase angle and the exhaust camshaft actual phase angle.	× 0.01°

ON-BOARD DIAGNOSTIC MONITOR ID	STANDARDIZED / MANUFACTURER DEFINE TEST ID	MONITORING ITEM	SIMPLE TECHNICAL DESCRIPTION	CONVERSION COEFFICIENT IN USING GENERAL SCAN TOOL
39	85	EVAP Monitor (Cap off) Pressure drop during de-pressurizing	ECM monitors the leak of fuel evaporation gas by checking whether the pressure can be reduced (the amount of pressure reduction) using the fuel tank differential pressure sensor after sealing the fuel tank and the fuel line.	× 0.0117 kPa
3B	85	EVAP Monitor (0.040") Pressure rise during airtight condition	After ECM vacuumizes the fuel tank and the fuel line and then the specified time is passed, ECM monitors the leak of fuel evaporation gas through the fuel tank differential pressure sensor to check the reduction of vacuum in the fuel tank.	× 0.0117 kPa
3C	85	EVAP Monitor (0.020") Pressure rise during airtight condition	After ECM vacuumizes the fuel tank and the fuel line and then the specified time is passed, ECM monitors the leak of fuel evaporation gas through the fuel tank differential pressure sensor to check the reduction of vacuum in the fuel tank.	× 0.0117 kPa
A2	0B	Mis-Fire Cylinder 1 Data EWMA Misfire Counts For Last 10 Driving Cycles	ECM monitors angular acceleration of crankshaft and detect misfire. EWMA (Exponential Weighted Moving Average) misfire counts for last 10 driving cycles.	× 1 count
	0C	Mis-Fire Cylinder 1 Data Misfire Counts For Last/Current Driving Cycle	ECM monitors angular acceleration of crankshaft and detect misfire. Misfire counts for last/current driving cycle.	× 1 count

ON-BOARD DIAGNOSTIC MONITOR ID	STANDARDIZED / MANUFACTURER DEFINED TEST ID	MONITORING ITEM	SIMPLE TECHNICAL DESCRIPTION	CONVERSION COEFFICIENT IN USING GENERAL SCAN TOOL
A3	0B	Mis-Fire Cylinder 2 Data EWMA Misfire Counts For Last 10 Driving Cycles	ECM monitors angular acceleration of crankshaft and detect misfire. EWMA (Exponential Weighted Moving Average) misfire counts for last 10 driving cycles.	× 1 count
	0C	Mis-Fire Cylinder 2 Data Misfire Counts For Last/Current Driving Cycle	ECM monitors angular acceleration of crankshaft and detect misfire. Misfire counts for last/current driving cycle.	× 1 count
A4	0B	Mis-Fire Cylinder 3 Data EWMA Misfire Counts For Last 10 Driving Cycles	ECM monitors angular acceleration of crankshaft and detect misfire. EWMA (Exponential Weighted Moving Average) misfire counts for last 10 driving cycles.	× 1 count
	0C	Mis-Fire Cylinder 3 Data Misfire Counts For Last/Current Driving Cycle	ECM monitors angular acceleration of crankshaft and detect misfire. Misfire counts for last/current driving cycle.	× 1 count
A5	0B	Mis-Fire Cylinder 4 Data EWMA Misfire Counts For Last 10 Driving Cycles	ECM monitors angular acceleration of crankshaft and detect misfire. EWMA (Exponential Weighted Moving Average) misfire counts for last 10 driving cycles.	× 1 count
	0C	Mis-Fire Cylinder 4 Data Misfire Counts For Last/Current Driving Cycle	ECM monitors angular acceleration of crankshaft and detect misfire. Misfire counts for last/current driving cycle.	× 1 count

*NOTE: \*1: Minimum value: The test fails if test value is less than this value.*

*NOTE: \*2: Maximum value: The test fails if test value is greater than this value.*

*NOTE: When not finishing the monitor of the driving cycle for the request of On-Board Monitoring Test Request, the ECM outputs the stored latest monitor test result.*

*NOTE: When the monitored test results are erased by the battery disconnection and so on, the ECM outputs the values in hexadecimal of "0000" or "FFFF", otherwise it outputs abnormal values and so on. In case of this, the ECU outputs are handled as invalid-values. When the first monitor (Readiness Status) is completed after this, the ECM outputs the valid-values.*

*NOTE: "Test Limit Type & Component ID byte" output from the ECM is given in hexadecimal of "00" or "80". "00" means the maximum value and "80" means the minimum value.*

## ON-BOARD DIAGNOSTICS

The engine control module (ECM) monitors the input/output signals (some signals all the time and others under specified conditions) of the ECM. When a malfunction continues for a specified time or longer after the irregular signal is initially monitored, the ECM judges that a malfunction has occurred. After the ECM first detects a malfunction, a diagnostic trouble code is recorded when the engine is restarted and the same malfunction is re-detected. However, for items marked with a "\*"1", a diagnostic trouble code is recorded on the first detection of the malfunction. There are 137 diagnostic items. The diagnostic results can be read out with a scan tool. Since memorization of the diagnostic trouble codes is backed up directly by the battery, the diagnostic results are memorized even if the ignition key is turned off. The diagnostic trouble codes will, however, be erased when the battery terminal or the ECM connector is disconnected. In addition, the diagnostic trouble code can also be erased by turning the ignition switch to ON and sending the diagnostic trouble code erase signal from scan tool MB991958 to the ECM.

*NOTE: If the sensor connector is disconnected with the ignition switch turned on, the diagnostic trouble code is memorized. In this case, send the diagnostic trouble code erase signal to the ECM in order to erase the diagnostic memory. The 137 diagnostic items are all indicated sequentially from the smallest code number. The ECM records the engine operating condition when the diagnostic trouble code is set. This data is called "Freeze-frame" data. This data can be read by using the scan tool, and can then be used in simulation tests for troubleshooting. Data items are as follows:*

*NOTE: If the ECM detects multiple malfunctions, the ECM stores the "Freeze-frame" data for only the first item that was detected. However, if the ECM detects a misfire or a fuel system malfunction, the ECM stores the data by giving priority to the misfire or fuel system malfunction, regardless of the order in which the malfunction was detected.*

*NOTE: As for Diagnostic trouble code P1603, "Freeze-frame" data is not memorized.*

### Freeze Frame Data for M.U.T.-III

ITEM NO.	M.U.T.-III SCAN TOOL DISPLAY	DATA ITEM	UNIT or STATE
1	Odometer	Odometer	km or mile
2	Ignition cycle (Warm up cycle)	Ignition cycle (Warm up cycle)	-
4	Accumulated minute	Accumulated minute*	min

*NOTE: \*: Accumulated time of current malfunction from time point when malfunction is detected.*

### Freeze Frame Data (OBD) for M.U.T.-III

ITEM NO.	M.U.T.-III SCAN TOOL DISPLAY	DATA ITEM	UNIT or STATE
AA	Airflow sensor	Mass airflow sensor	g/s
AB	TP sensor (main)	Throttle position sensor (main)	%
BA	Target EGR	Target EGR stepper motor	%
BB	Barometric pressure sensor	Barometric pressure sensor	kPa or in.Hg
BC	Relative TP sensor	Relative throttle position sensor	%
BD	TP sensor (sub)	Throttle position sensor (sub)	%
BE	APP sensor (main)	Accelerator pedal position sensor (main)	%
BF	APP sensor (sub)	Accelerator pedal position sensor (sub)	%

ITEM NO.	M.U.T.-III SCAN TOOL DISPLAY	DATA ITEM	UNIT or STATE
C0	Fuel system status (bank1)	Fuel control system status	• Open loop
			• Closed loop
			• Open loop-drive condition
			• Open loop-DTC set
			• Closed loop-O2 (rear) failed
C1*	Fuel system status (bank 2)	Fuel control system status (bank 2)	N/A
C2	Calculated load value	Calculated load value	%
C3	ECT sensor	Engine coolant temperature sensor	° C or ° F
C4	Short term fuel trim (bank 1)	Short-term fuel trim	%
C5*	Short term fuel trim (bank 3)	Short-term fuel trim (bank 3)	****
C6	Long term fuel trim (bank 1)	Long-term fuel trim	%
C7*	Long term fuel trim (bank 3)	Long-term fuel trim (bank 3)	****
CC	MAP sensor	Manifold absolute pressure sensor	kPa or in.Hg
CD	Crankshaft position sensor	Crankshaft position sensor	r/min
CE	Vehicle speed	Vehicle speed	km/h or mph
CF	Spark advance	Spark advance	° CA
D0	Intake air temperature sensor 1	Intake air temperature sensor	° C or ° F
D1	Time since engine running	Time since engine running	sec
D6	EVAP. emission purge SOL. duty	Evaporative emission purge solenoid duty	%
D7	Fuel level gauge	Fuel level gauge	%
D8	Power supply voltage	Power supply voltage	V
D9	Absolute load value	Absolute load value	%
DA	Target equivalence ratio	Target equivalence ratio	–
DB	Intake air temperature sensor 1	Intake air temperature sensor (ambient air temperature)	° C or ° F
DC	Throttle actuator	Throttle actuator control motor	%
DD	Relative APP sensor	Relative accelerator pedal position sensor	%
242	Fuel tank differential PRS.SNSR	Fuel tank differential pressure sensor	Pa

NOTE: \*: Data items are displayed on scan tool display, but the in-line 4 engine is not applicable and its data is displayed as "N/A" or "\*\*\*\*".

**Freeze Frame Data for General Scan Tool**

<b>COMMON EXAMPLE of GENERAL SCAN TOOL DISPLAY</b>	<b>PRAMETER IDENTIFICATION (PID)</b>	<b>DESCRIPTION</b>	<b>UNIT or STATE</b>
DTCFRZF	02	DTC that caused required freeze frame data storage	Pxxxx, Uxxxx
FUELSYS 1	03	See M.U.T.-III Item No. C0	
LOAD_PCT	04	See M.U.T.-III Item No. C2	
ECT	05	See M.U.T.-III Item No. C3	
SHRTFT 1	06	See M.U.T.-III Item No. C4	
LONGFT 1	07	See M.U.T.-III Item No. C6	
MAP	0B	See M.U.T.-III Item No. CC	
RPM	0C	See M.U.T.-III Item No. CD	
VSS	0D	See M.U.T.-III Item No. CE	
SPARKADV	0E	See M.U.T.-III Item No. CF	
IAT	0F	See M.U.T.-III Item No. D0	
MAF	10	See M.U.T.-III Item No. AA	
TP	11	See M.U.T.-III Item No. AB	
RUNTM	1F	See M.U.T.-III Item No. D1	
EGR_PCT	2C	See M.U.T.-III Item No. BA	
EVAP_PCT	2E	See M.U.T.-III Item No. D6	
FLI	2F	See M.U.T.-III Item No. D7	
EVAP_VP	32	See M.U.T.-III Item No. 242	
BARO	33	See M.U.T.-III Item No. BB	
VPWR	42	See M.U.T.-III Item No. D8	
LOAD_ABS	43	See M.U.T.-III Item No. D9	
EQ_RAT	44	See M.U.T.-III Item No. DA	
TP_R	45	See M.U.T.-III Item No. BC	
AAT	46	See M.U.T.-III Item No. DB	
TP_B	47	See M.U.T.-III Item No. BD	
APP_D	49	See M.U.T.-III Item No. BE	
APP_E	4A	See M.U.T.-III Item No. BF	
TAC_PCT	4C	Command Throttle Actuator Control	%
APP_R	5A	See M.U.T.-III Item No. DD	

## OBD- II DRIVE CYCLE

All kinds of diagnostic trouble codes (DTCs) can be monitored by carrying out a short drive according to the following 23 drive cycle patterns. In other words, doing such a drive regenerates any kind of trouble which involves illuminating the Malfunction Indicator Lamp (SERVICE ENGINE SOON or Check Engine Lamp) and verifies the repair procedure has been eliminated [the trouble the Malfunction Indicator Lamp (SERVICE ENGINE SOON or Check Engine Lamp) is no longer illuminated].

**⚠ CAUTION**

**Two technicians should always be in the vehicle when carrying out a test.**

*NOTE: Check that the diagnosis trouble code (DTC) is not output before driving the OBD-II drive cycle. Erase the DTC if it has been output.*

*NOTE: Drive cycle patterns are not established for Vehicle speed sensor monitor (DTC P0500), Power steering pressure switch monitor (P0551), and Fuel level sensor monitor (DTC P0461). Please reference the M.U.T. data list to judge whether these monitor items are normal.*

### DRIVE CYCLE PATTERN LIST

MONITOR ITEM	DIAGNOSTIC TROUBLE CODE (DTC)	PATTERN
Heated oxygen sensor (front) monitor <Readiness test item>	P0133	1
Heated oxygen sensor (rear) feedback control system monitor	P2096, P2097	
Heated oxygen sensor heater monitor <Readiness test item>	P0031, P0037	2
Heated oxygen sensor heater monitor	P0032, P0038, P0043, P0044	
Exhaust gas recirculation (EGR) system monitor <Readiness test item>	P0401, P0489, P0490	3
Catalytic converter monitor <Readiness test item>	P0420, P0421	4
Evaporative emission system leak monitor (small leak and gross leak) <Readiness test item>	P0442, P0455	5
Evaporative purge system monitor	P0441	
Fuel tank pressure sensor monitor	P0450	
Evaporative emission system leak monitor (very small leak) <Readiness test item>	P0456	6
Mass airflow sensor monitor	P0101	7
Manifold absolute pressure (MAP) sensor monitor	P0106, P0107	
Intake air temperature sensor monitor	P0111	8
Engine coolant temperature sensor monitor	P0116, P0125	9
Thermostat monitor	P0128	10
Heated oxygen sensor (rear) monitor <Readiness test item>	P0139	11
Heated oxygen sensor (3rd) monitor	P0145	
HC adsorber (HC trap catalyst) monitor	P2423	
Air fuel ratio feedback monitor	P0134	12

MONITOR ITEM	DIAGNOSTIC TROUBLE CODE (DTC)	PATTERN
Heated oxygen sensor (rear) monitor <Readiness test item>	P0140	13
Heated oxygen sensor (3rd) monitor	P0146	
Fuel tank temperature sensor monitor	P0181	14
Misfire monitor	P0300, P0301, P0302, P0303, P0304	15
Fuel tank pressure sensor monitor	P0451	16
Power steering pressure switch monitor	P0554	17
Throttle position sensor plausibility monitor	P1233, P1234	
Mass airflow sensor plausibility monitor	P1235, P1238	
Torque monitor	P1241	
Idle speed control system monitor	P0506, P0507	18
Ignition timing retard control (cold start strategy) monitor	P050B	19
Idle speed control system monitor	P1506, P1507	
Variable valve timing system (MIVEC) monitor	P0010, P0011, P0013, P0014, P0016, P0017	20
Fuel trim monitor	P0171, P0172	21
Heated oxygen sensor monitor	P0131, P0137, P0143, P2195	22
Mass airflow sensor monitor	P0102, P0103	23
Manifold absolute pressure (MAP) sensor monitor	P0108	
Intake air temperature sensor monitor	P0112, P0113	
Engine coolant temperature sensor monitor	P0117, P0118	
Heated oxygen sensor monitor	P0132, P0138, P0144, P2252, P2253	
Fuel tank temperature sensor monitor	P0182, P0183	
Injector monitor	P0201, P0202, P0203, P0204	
Knock sensor monitor	P0327, P0328	
Crankshaft position sensor monitor	P0335	
Camshaft position sensor monitor	P0340, P0365	
Evaporative emission purge solenoid monitor	P0443	
Evaporative emission ventilation solenoid monitor	P0446	
Fuel tank pressure sensor monitor	P0452, P0453	
Fuel level sensor monitor	P0462, P0463	
Engine RPM plausibility monitor	P1239	
Barometric pressure sensor monitor	P2228, P2229	



**PATTERN 1**

<p>Drive cycle pattern</p>	
<p>Inspection conditions</p>	<ul style="list-style-type: none"> <li>• Engine coolant temperature: More than 76° C (169° F)</li> <li>• Condition of CVT: Selector lever "D" range</li> </ul>
<p>Test procedure</p>	<ol style="list-style-type: none"> <li>1. Start the engine with all the accessories switched OFF.</li> <li>2. Drive the vehicle for 4 minutes at the following conditions. (During the monitor) <ul style="list-style-type: none"> <li><i>NOTE: When the system is normal, the monitor is completed earlier.</i></li> <li>• Vehicle speed: More than 30 km/h (19 mph)</li> <li>• Engine speed: More than 1,400 r/min, less than 3,000 r/min</li> <li>• Engine load: More than 30 %, less than 60 %</li> <li>• Without rapid accelerator pedal movement</li> </ul> </li> <li>3. Stop the vehicle in a safe place and turn the ignition switch to "LOCK" (OFF) position.</li> <li>4. Start the engine and do Steps 1 to 3 again. <ul style="list-style-type: none"> <li><i>NOTE: When the vehicle is operating normally and the OBD-II Drive Cycle is carried out, the Readiness Codes will be set as "Complete" on the first drive cycle. The second drive cycle is required to set the Readiness Codes as "Complete" if a fault is detected during the first drive cycle.</i></li> </ul> </li> <li>5. Confirm that the diagnostic trouble code (DTC) is not output.</li> </ol>

**PATTERN 2**

<p>Test procedure</p>	<ol style="list-style-type: none"> <li>1. Start the engine with all the accessories switched OFF.</li> <li>2. Let the engine idle for 10 seconds. (During the monitor)</li> <li>3. Turn the ignition switch to the "LOCK" (OFF) position.</li> <li>4. Start the engine and do Steps 1 to 3 again. <ul style="list-style-type: none"> <li><i>NOTE: When the vehicle is operating normally and the OBD-II Drive Cycle is carried out, the Readiness Codes will be set as "Complete" on the first drive cycle. The second drive cycle is required to set the Readiness Codes as "Complete" if a fault is detected during the first drive cycle.</i></li> </ul> </li> <li>5. Confirm that the diagnostic trouble code (DTC) is not output.</li> </ol>
-----------------------	---

PATTERN 3

<p>Drive cycle pattern</p>	<p style="text-align: right;">AK402431AF</p>
<p>Inspection conditions</p>	<ul style="list-style-type: none"> <li>• Engine coolant temperature: More than 76° C (169° F)</li> <li>• Intake air temperature: More than -10° C (14° F)</li> <li>• Barometric pressure: More than 76 kPa (22.4 in.Hg)</li> <li>• Condition of CVT: Selector lever "D" range</li> </ul>
<p>Test procedure</p>	<ol style="list-style-type: none"> <li>1. Start the engine with all the accessories switched OFF.</li> <li>2. Accelerate until the vehicle speed is 60 km/h (38 mph) and then drive the vehicle for 90 seconds.</li> <li>3. Release the accelerator pedal and reduce vehicle speed to 30 km/h (18 mph). (During the monitor)</li> <li>4. Accelerate until the vehicle speed is 60 km/h (38 mph) and then drive the vehicle for 20 seconds.</li> <li>5. Release the accelerator pedal and reduce vehicle speed to 30 km/h (18 mph). (During the monitor)</li> <li>6. Stop the vehicle in a safe place and turn the ignition switch to "LOCK" (OFF) position.</li> <li>7. Start the engine and do Steps 1 to 6 again.</li> </ol> <p><i>NOTE: When the vehicle is operating normally and the OBD-II Drive Cycle is carried out, the Readiness Codes will be set as "Complete" on the first drive cycle. The second drive cycle is required to set the Readiness Codes as "Complete" if a fault is detected during the first drive cycle.</i></p> <ol style="list-style-type: none"> <li>8. Confirm that the diagnostic trouble code (DTC) is not output.</li> </ol>

**PATTERN 4**

<p>Drive cycle pattern</p>	<p>AK402432AC</p>
<p>Inspection conditions</p>	<ul style="list-style-type: none"> <li>• Engine coolant temperature: More than 0° C (32° F)</li> <li>• Intake air temperature: More than -10° C (14° F)</li> <li>• Barometric pressure: More than 76 kPa (22.4 in.Hg)</li> <li>• Condition of CVT: Selector lever "D" range</li> </ul>
<p>Test procedure</p>	<ol style="list-style-type: none"> <li>1. Start the engine with all accessories switched OFF.</li> <li>2. Drive the vehicle for 5 minutes at the following conditions. (During the monitor) <ul style="list-style-type: none"> <li>• Engine speed: Less than 3,000 r/min</li> <li>• Airflow rate: More than 10 g/sec, less than 45 g/sec</li> <li>• Accelerator pedal: Except full close</li> <li>• Without rapid accelerator pedal movement</li> </ul> </li> <li>3. Release the accelerator pedal for 5 seconds.</li> <li>4. Drive the vehicle for 3 minutes at the following conditions. (During the monitor) <ul style="list-style-type: none"> <li>• Engine speed: Less than 3,000 r/min</li> <li>• Airflow rate: More than 10 g/sec, less than 45 g/sec</li> <li>• Accelerator pedal: Except full close</li> <li>• Without rapid accelerator pedal movement</li> </ul> <p><i>NOTE: When the system is normal, the monitor is completed earlier.</i></p> </li> <li>5. Stop the vehicle in a safe place and turn the ignition switch to "LOCK" (OFF) position.</li> <li>6. Start the engine and do Steps 1 to 5 again. <p><i>NOTE: When the vehicle is operating normally and the OBD-II Drive Cycle is carried out, the Readiness Codes will be set as "Complete" on the first drive cycle. The second drive cycle is required to set the Readiness Codes as "Complete" if a fault is detected during the first drive cycle.</i></p> </li> <li>7. Confirm that the diagnostic trouble code (DTC) is not output.</li> </ol>

**PATTERN 5**

<p>Drive cycle pattern</p>	<p align="right">AK402430 AI</p>
<p>Inspection conditions</p>	<ul style="list-style-type: none"> <li>• Engine coolant temperature at engine start: Less than 36° C (96° F)</li> <li>• Intake air temperature at engine start: Less than 36° C (96° F)</li> <li>• Fuel amount at engine start: More than 15 %, less than 40 %</li> <li>• Engine coolant temperature: More than 60° C (140° F)</li> <li>• Intake air temperature: More than 5° C (41° F), less than 45° C (113° F)</li> <li>• Barometric pressure: More than 76 kPa (22.4 in.Hg)</li> <li>• Fuel temperature: Less than 36° C (96° F)</li> <li>• Condition of CVT: Selector lever "D" range</li> </ul>
<p>Test procedure</p>	<ol style="list-style-type: none"> <li>1. Start the engine with all the accessories switched OFF.</li> <li>2. Drive the vehicle for 16 minutes at the following conditions. (During the monitor) <ul style="list-style-type: none"> <li>• Engine speed: More than 1,600 r/min, less than 4,000 r/min</li> <li>• Vehicle speed: More than 20 km/h (12 mph)</li> <li>• Engine load: More than 20 %, less than 70 %</li> <li>• Without rapid accelerator pedal movement</li> </ul> <p><i>NOTE: Keep running as long as possible with the power steering pressure switch in the OFF position.</i></p> <p><i>NOTE: When the system is normal, the monitor is completed earlier.</i></p> </li> <li>3. Stop the vehicle in a safe place and turn the ignition switch to "LOCK" (OFF) position.</li> <li>4. Start the engine and do Steps 1 to 3 again. <p><i>NOTE: When the vehicle is operating normally and the OBD-II Drive Cycle is carried out, the Readiness Codes will be set as "Complete" on the first drive cycle. The second drive cycle is required to set the Readiness Codes as "Complete" if a fault is detected during the first drive cycle.</i></p> </li> <li>5. Confirm that the diagnostic trouble code (DTC) is not output.</li> </ol>

**PATTERN 6**

<p>Inspection conditions</p>	<ul style="list-style-type: none"> <li>• Engine coolant temperature at engine start: Less than 36° C (96° F)</li> <li>• Intake air temperature at engine start: Less than 36° C (96° F)</li> <li>• Fuel amount at engine start: More than 40 %, less than 85 %</li> <li>• Engine coolant temperature: More than 20° C (68° F)</li> <li>• Intake air temperature: More than -10° C (14° F)</li> <li>• Barometric pressure: More than 76 kPa (22.4 in.Hg)</li> <li>• Fuel temperature: Less than 33° C (91° F)</li> </ul>
<p>Test procedure</p>	<ol style="list-style-type: none"> <li>1. Start the engine with all the accessories switched OFF.</li> <li>2. Let the engine idle for 16 minutes. (During the monitor) <i>NOTE: When the system is normal, the monitor is completed earlier.</i></li> <li>3. Turn the ignition switch to "LOCK" (OFF) position.</li> <li>4. Start the engine and do Steps 1 to 3 again. <i>NOTE: When the vehicle is operating normally and the OBD-II Drive Cycle is carried out, the Readiness Codes will be set as "Complete" on the first drive cycle. The second drive cycle is required to set the Readiness Codes as "Complete" if a fault is detected during the first drive cycle.</i></li> <li>5. Confirm that the diagnostic trouble code (DTC) is not output.</li> </ol>

**PATTERN 7**

<p>Drive cycle pattern</p>	<p align="right">AK402442AE</p>
<p>Inspection conditions</p>	<ul style="list-style-type: none"> <li>• Engine coolant temperature at engine start: More than 0° C (32° F)</li> <li>• Condition of CVT: Selector lever "D" range</li> </ul>
<p>Test procedure</p>	<ol style="list-style-type: none"> <li>1. Start the engine with all the accessories switched OFF.</li> <li>2. Let the engine idle for 30 seconds. (During the monitor)</li> <li>3. Accelerate the vehicle for 2 seconds at the following conditions. (During the monitor) <ul style="list-style-type: none"> <li>• Engine speed: More than 1,500 r/min</li> <li>• Engine load: More than 20 %</li> <li>• Throttle position sensor output voltage: More than 3.5 volts</li> </ul> </li> <li>4. Stop the vehicle in a safe place and turn the ignition switch to "LOCK" (OFF) position.</li> <li>5. Start the engine and do Steps 1 to 4 again.</li> <li>6. Confirm that the diagnostic trouble code (DTC) is not output.</li> </ol>

**PATTERN 8**

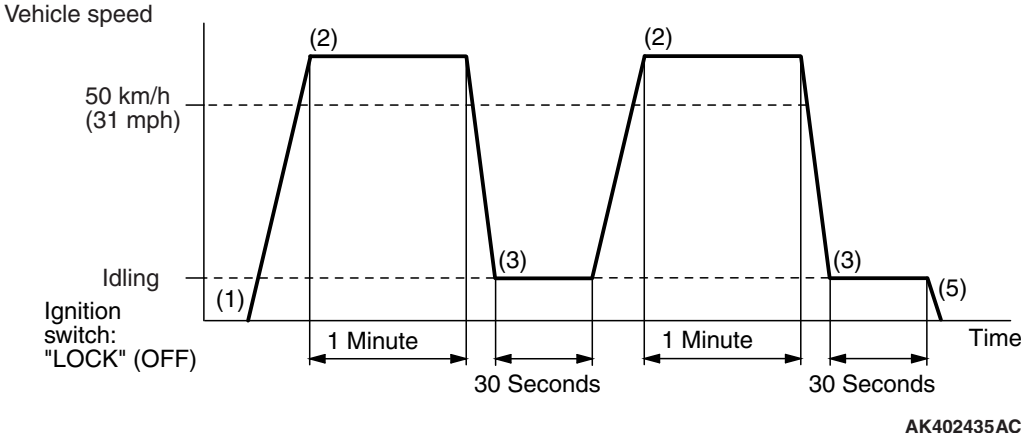
<p>Drive cycle pattern</p>	
<p>Inspection conditions</p>	<ul style="list-style-type: none"> <li>• Engine coolant temperature: More than 76° C (169° F)</li> <li>• Condition of CVT: Selector lever "D" range</li> </ul>
<p>Test procedure</p>	<ol style="list-style-type: none"> <li>1. Start the engine with all the accessories switched OFF.</li> <li>2. Drive the vehicle at more than 50 km/h (31 mph) for 1 minute.</li> <li>3. Stop the vehicle in a safe place and let the engine idle for 30 seconds.</li> <li>4. Repeat Steps 2 and 3 again.</li> <li>5. Stop the vehicle in a safe place and turn the ignition switch to "LOCK" (OFF) position.</li> <li>6. Confirm that the diagnostic trouble code (DTC) is not output.</li> </ol>

**PATTERN 9**

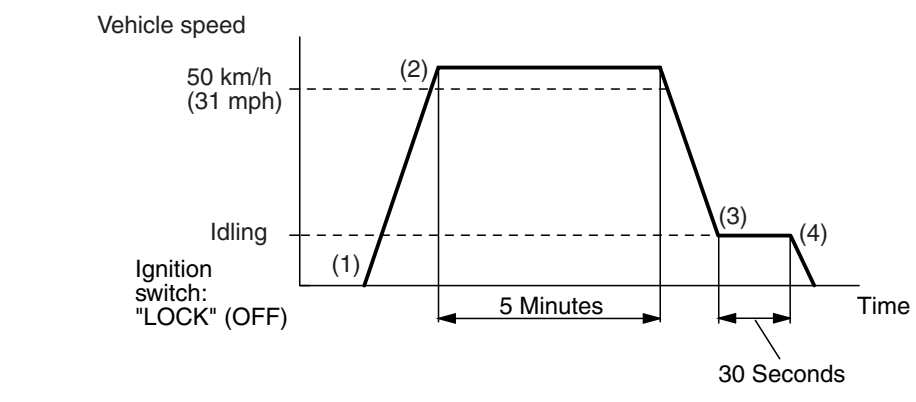
<p>Drive cycle pattern</p>	
<p>Inspection conditions</p>	<ul style="list-style-type: none"> <li>• Engine coolant temperature at engine start: More than 0° C (32° F)</li> <li>• Intake air temperature: Less than 60° C (140° F)</li> <li>• Engine coolant temperature: More than 40° C (104° F)</li> <li>• Condition of CVT: Selector lever "D" range</li> </ul>
<p>Test procedure</p>	<ol style="list-style-type: none"> <li>1. Start the engine with all the accessories switched OFF.</li> <li>2. Drive the vehicle for 5 minutes at the following condition.             <ul style="list-style-type: none"> <li>• Vehicle speed: More than 50 km/h (31 mph)</li> <li>• Air flow rate: More than 12 g/sec</li> <li>• Except fuel cut</li> </ul> </li> <li>3. Stop the vehicle in a safe place and let the engine idle for 30 seconds.</li> <li>4. Turn the ignition switch to "LOCK" (OFF) position.</li> <li>5. Confirm that the diagnostic trouble code (DTC) is not output.</li> </ol>

**PATTERN 10**

<p>Drive cycle pattern</p>	
<p>Inspection conditions</p>	<ul style="list-style-type: none"> <li>• Engine coolant temperature at engine start: More than <math>-10^{\circ}\text{C}</math> (<math>14^{\circ}\text{F}</math>), less than <math>60^{\circ}\text{C}</math> (<math>140^{\circ}\text{F}</math>)</li> <li>• Intake air temperature: More than <math>-10^{\circ}\text{C}</math> (<math>14^{\circ}\text{F}</math>)</li> <li>• Dropping of intake air temperature since engine start: Less than <math>10^{\circ}\text{C}</math> (<math>18^{\circ}\text{F}</math>)</li> <li>• Condition of CVT: Selector lever "D" range</li> </ul>
<p>Test procedure</p>	<ol style="list-style-type: none"> <li>1. Start the engine with all the accessories switched OFF.</li> <li>2. Drive the vehicle for 6 minutes at the following conditions. (During the monitor) <ul style="list-style-type: none"> <li>• Vehicle speed: More than 50 km/h (31 mph)</li> <li>• Air flow rate: More than 10 g/sec</li> </ul> <p><i>NOTE: The system is normal if engine coolant temperature will rise more than <math>77^{\circ}\text{C}</math> (<math>171^{\circ}\text{F}</math>) within 6 minutes.</i></p> </li> <li>3. Stop the vehicle in a safe place and turn the ignition switch to "LOCK" (OFF) position.</li> <li>4. Start the engine and do Steps 1 to 3 again.</li> <li>5. Confirm that the diagnostic trouble code (DTC) is not output.</li> </ol>

PATTERN 11

<p>Drive cycle pattern</p>	<p style="text-align: right;">AK604701AC</p>
<p>Inspection conditions</p>	<ul style="list-style-type: none"> <li>• Engine coolant temperature: More than 76° C (169° F)</li> <li>• Intake air temperature: More than -10° C (14° F)</li> <li>• Barometric pressure: More than 76 kPa (22.4 in.Hg)</li> <li>• Condition of CVT: Selector lever "D" range</li> </ul>
<p>Test procedure</p>	<ol style="list-style-type: none"> <li>1. Start the engine with all the accessories switched OFF.</li> <li>2. Drive the vehicle at 50 km/h (31 mph) for 6 minutes.</li> <li>3. Release the accelerator pedal for 10 seconds then stop the vehicle in a safe place. (During the monitor)</li> <li>4. Turn the ignition switch to "LOCK" (OFF) position.</li> <li>5. Start the engine and do Steps 1 to 4 again.</li> </ol> <p><i>NOTE: When the vehicle is operating normally and the OBD-II Drive Cycle is carried out, the Readiness Codes will be set as "Complete" on the first drive cycle. The second drive cycle is required to set the Readiness Codes as "Complete" if a fault is detected during the first drive cycle.</i></p> <ol style="list-style-type: none"> <li>6. Confirm that the diagnostic trouble code (DTC) is not output.</li> </ol>



**PATTERN 12**

<p>Drive cycle pattern</p>	<p style="text-align: right;">AK402436AE</p>
<p>Inspection conditions</p>	<ul style="list-style-type: none"> <li>• Engine coolant temperature: More than 0° C (32° F)</li> <li>• Condition of CVT: Selector lever "D" range</li> </ul>
<p>Test procedure</p>	<ol style="list-style-type: none"> <li>1. Start the engine with all the accessories switched OFF.</li> <li>2. Let the engine idle for 3 minutes.</li> <li>3. Drive the vehicle for 30 seconds at the following conditions. (During the monitor) <ul style="list-style-type: none"> <li>• Engine speed: More than 1,200 r/min</li> <li>• Engine load: More than 30 %</li> <li>• Throttle position sensor output: Less than 3.0 volts</li> <li>• Except fuel cut</li> </ul> </li> <li>4. Stop the vehicle in a safe place and turn the ignition switch to "LOCK" (OFF) position.</li> <li>5. Confirm that the diagnostic trouble code (DTC) is not output.</li> </ol>

**PATTERN 13**

<p>Drive cycle pattern</p>	
<p>Inspection conditions</p>	<ul style="list-style-type: none"> <li>• Engine coolant temperature: More than 76° C (169° F)</li> <li>• Condition of CVT: Selector lever "D" range</li> </ul>
<p>Test procedure</p>	<ol style="list-style-type: none"> <li>1. Start the engine with all the accessories switched OFF.</li> <li>2. Drive the vehicle at 50 km/h (31 mph) for 5 minutes.</li> <li>3. Release the accelerator pedal for 5 seconds then stop the vehicle in a safe place.</li> <li>4. Increase the speed of the vehicle to 50 km/h (31 mph) under the following conditions, and then drive the vehicle for 1 minute. <ul style="list-style-type: none"> <li>• Engine speed: More than 1,500 r/min</li> <li>• Engine load: More than 40 %</li> </ul> </li> <li>5. Release the accelerator pedal for 5 seconds then stop the vehicle in a safe place.</li> <li>6. Repeat Steps 4 and 5 for 2 times.</li> <li>7. Stop the vehicle in a safe place and turn the ignition switch to "LOCK" (OFF) position.</li> <li>8. Start the engine and do Steps 1 to 7 again.</li> </ol> <p><i>NOTE: When the vehicle is operating normally and the OBD-II Drive Cycle is carried out, the Readiness Codes will be set as "Complete" on the first drive cycle. The second drive cycle is required to set the Readiness Codes as "Complete" if a fault is detected during the first drive cycle.</i></p> <ol style="list-style-type: none"> <li>9. Confirm that the diagnostic trouble code (DTC) is not output.</li> </ol>

**PATTERN 14**

<p>Inspection conditions</p>	<ul style="list-style-type: none"> <li>• Engine coolant temperature at engine start: More than -10° C (14° F), less than 36° C (97° F)</li> <li>• Difference between engine coolant temperature and intake air temperature at engine start: Less than 5° C (9° F)</li> <li>• Condition of CVT: Selector lever "D" range</li> </ul>
<p>Test procedure</p>	<ol style="list-style-type: none"> <li>1. Start the engine with all the accessories switched OFF.</li> <li>2. Drive the vehicle at more than 30 km/h (19 mph) until engine coolant temperature rises more than 60° C (140° F). (During the monitor)</li> <li>3. Stop the vehicle in a safe place and turn the ignition switch to "LOCK" (OFF) position.</li> <li>4. Start the engine and do Steps 1 to 3 again.</li> <li>5. Confirm that the diagnostic trouble code (DTC) is not output.</li> </ol>

**PATTERN 15**

<p>Drive cycle pattern</p>	<p style="text-align: right;">AK402440AE</p>
<p>Inspection conditions</p>	<ul style="list-style-type: none"> <li>• Engine coolant temperature: More than -10° C (14° F)</li> <li>• Barometric pressure: More than 76 kPa (22.4 in.Hg)</li> <li>• Condition of CVT: Selector lever "D" range</li> </ul>
<p>Test procedure</p>	<ol style="list-style-type: none"> <li>1. Start the engine with all the accessories switched OFF.</li> <li>2. Drive the vehicle for 3 minutes at the following conditions. (During the monitor)             <ul style="list-style-type: none"> <li>• Engine speed: More than 500 r/min, less than 3,000 r/min</li> <li>• Engine load: More than 25 %</li> <li>• Without rapid accelerator pedal change</li> <li>• Except fuel cut</li> </ul> </li> <li>3. Stop the vehicle in a safe place and turn the ignition switch to "LOCK" (OFF) position.</li> <li>4. Start the engine and do Steps 1 to 3 again.</li> <li>5. Confirm that the diagnostic trouble code (DTC) is not output.</li> </ol>

**PATTERN 16**

<p>Drive cycle pattern</p>	<p>Vehicle speed</p> <p>50 km/h (31 mph)</p> <p>Idling</p> <p>Ignition switch: "LOCK" (OFF)</p> <p>Time</p> <p>1st monitor</p> <p>2nd monitor</p> <p>9th monitor</p> <p>10th monitor</p> <p>20 seconds</p> <p>20 seconds</p> <p>AK402438AC</p>
<p>Inspection condition</p>	<p>Condition of CVT: Selector lever "D" range</p>
<p>Test procedure</p>	<ol style="list-style-type: none"> <li>1. Start the engine with all the accessories switched OFF.</li> <li>2. Accelerate until the vehicle speed is more than 50 km/h (31 mph).</li> <li>3. Stop the vehicle in a safe place and let the engine idle for 20 seconds. (During the monitor)</li> <li>4. Repeat Steps 2 and 3 for 10 times.</li> <li>5. Stop the vehicle in a safe place and turn the ignition switch to "LOCK" (OFF) position.</li> <li>6. Start the engine and do Steps 1 to 5 again.</li> <li>7. Confirm that the diagnostic trouble code (DTC) is not output.</li> </ol>

**PATTERN 17**

<p>Drive cycle pattern</p>	<p>Vehicle speed</p> <p>50 km/h (31 mph)</p> <p>Ignition switch: "LOCK" (OFF)</p> <p>Time</p> <p>During the monitor</p> <p>30 seconds</p> <p>AK402441AP</p>
<p>Inspection conditions</p>	<ul style="list-style-type: none"> <li>• Engine coolant temperature: More than 20° C (68° F)</li> <li>• Condition of CVT: Selector lever "D" range</li> </ul>
<p>Test procedure</p>	<ol style="list-style-type: none"> <li>1. Start the engine with all the accessories switched OFF.</li> <li>2. Drive the vehicle at more than 50 km/h (31 mph) for 30 seconds. (During the monitor)</li> <li>3. Stop the vehicle in a safe place and turn the ignition switch to "LOCK" (OFF) position.</li> <li>4. Start the engine and do Steps 1 to 3 again.</li> <li>5. Confirm that the diagnostic trouble code (DTC) is not output.</li> </ol>

**PATTERN 18**

Inspection conditions	<ul style="list-style-type: none"> <li>• Engine coolant temperature: More than 41° C (106° F)</li> <li>• Intake air temperature: More than -10° C (14° F)</li> <li>• Barometric pressure: More than 76 kPa (22.4 in.Hg)</li> </ul>
Test procedure	<ol style="list-style-type: none"> <li>1. Start the engine with all the accessories switched OFF.</li> <li>2. Let the engine idle for 1 minute. (During the monitor)</li> <li>3. Turn the ignition switch to "LOCK" (OFF) position.</li> <li>4. Start the engine and do Steps 1 to 3 again.</li> <li>5. Confirm that the diagnostic trouble code (DTC) is not output.</li> </ol>

**PATTERN 19**

Inspection conditions	<ul style="list-style-type: none"> <li>• Engine coolant temperature: More than 7° C (45° F), less than 41° C (106° F)</li> <li>• Intake air temperature: More than -10° C (14° F)</li> <li>• Barometric pressure: More than 76 kPa (22.4 in.Hg)</li> </ul>
Test procedure	<ol style="list-style-type: none"> <li>1. Start the engine with all the accessories switched OFF.</li> <li>2. Let the engine idle for 1 minute. (During the monitor)</li> <li>3. Turn the ignition switch to "LOCK" (OFF) position.</li> <li>4. Start the engine and do Steps 1 to 3 again.</li> <li>5. Confirm that the diagnostic trouble code (DTC) is not output.</li> </ol>

**PATTERN 20**

Inspection condition	Engine coolant temperature: More than 77° C (171° F), less than 87° C (189° F)
Test procedure	<ol style="list-style-type: none"> <li>1. Start the engine with all the accessories switched OFF.</li> <li>2. Drive the engine at 1,200 –1,500 r/min for 30 seconds. (During the monitor)</li> <li>3. Turn the ignition switch to "LOCK" (OFF) position.</li> <li>4. Start the engine and do Steps 1 to 3 again.</li> <li>5. Confirm that the diagnostic trouble code (DTC) is not output.</li> </ol>

**PATTERN 21**

Inspection condition	Engine coolant temperature: More than 76° C (169° F)
Test procedure	<ol style="list-style-type: none"> <li>1. Start the engine with all the accessories switched OFF.</li> <li>2. Let the engine idle for 15 minutes. (During the monitor)</li> <li>3. Turn the ignition switch to "LOCK" (OFF) position.</li> <li>4. Start the engine and do Steps 1 to 3 again.</li> <li>5. Confirm that the diagnostic trouble code (DTC) is not output.</li> </ol>

**PATTERN 22**

Inspection conditions	<ul style="list-style-type: none"> <li>• Intake air temperature: More than -10° C (14° F)</li> <li>• Engine coolant temperature: More than 0° C (32° F)</li> </ul>
Test procedure	<ol style="list-style-type: none"> <li>1. Start the engine with all the accessories switched OFF.</li> <li>2. Let the engine idle for 5 minutes. (During the monitor)</li> <li>3. Turn the ignition switch to "LOCK" (OFF) position.</li> <li>4. Start the engine and do Steps 1 to 3 again.</li> <li>5. Confirm that the diagnostic trouble code (DTC) is not output.</li> </ol>

**PATTERN 23**

Inspection conditions	<ul style="list-style-type: none"> <li>• Engine coolant temperature: More than 0° C (32° F) &lt;Manifold absolute pressure sensor monitor&gt;</li> <li>• Fuel temperature: Less than 36° C (96° F) &lt;Fuel tank pressure sensor monitor&gt;</li> <li>• Fuel amount at engine start: Less than 85 % &lt;Fuel tank pressure sensor monitor&gt;</li> </ul>
Test procedure	<ol style="list-style-type: none"> <li>1. Start the engine with all the accessories switched OFF.</li> <li>2. Let the engine idle at the engine speed less than 1,000 r/min for 15 seconds. (During the monitor)</li> <li>3. Turn the ignition switch to "LOCK" (OFF) position.</li> <li>4. Start the engine and do Steps 1 to 3 again.</li> <li>5. Confirm that the diagnostic trouble code (DTC) is not output.</li> </ol>

**SYSTEM READINESS TEST STATUS****PURPOSE**

The Readiness function (also referred to as I/M Readiness or I/M Flags) indicates if a full diagnostic check has been "Completed" (is "Ready") for each non-continuous monitor. Enhanced I/M State Emission Programs will use the Readiness status (Codes) to see if the vehicle is ready for OBD-II testing. "Incomplete" (Not Ready) codes will be one of the triggers for I/M failure.

**OVERVIEW**

The ECM monitors the following main diagnosis items and records whether the evaluation was completed or is incomplete. The Readiness Codes are established for the I/M programs, thereby confirming that the vehicles have not been tampered with by erasing the diagnostic trouble code(s) (DTCs) before I/M testing. The Readiness Codes and DTCs can be reset by disconnecting the battery or by erasing the codes with a scan tool MB991958 (M.U.T.-III sub assembly). For this reason, all the Readiness Codes must be displayed "Complete" before I/M testing.

When the monitors run and complete, the scan tool MB991958 (M.U.T.-III sub assembly) will display the Readiness Codes as "Complete" (General Scan Tools display as "Ready"). When the vehicle is operating normally and the OBD-II Drive Cycle is carried out, the Readiness Codes will be set as "Complete" on the first drive cycle. For DTCs requiring two drive cycles to detect a fault, the second drive cycle is required to set the Readiness Codes as "Complete" if a fault is detected during the first drive cycle. If the fault is still there after the second drive cycle, a DTC will be set.

- Catalyst: P0420 <Except vehicles for California>, P0421 <Vehicles for California>
- Evaporative system: P0442, P0455, P0456
- Heated oxygen sensor: P0133, P0139, P0140
- Heated oxygen sensor heater: P0031, P0037
- EGR system: P0401

After all the Readiness Codes are displayed as "Complete", the technician is assured that any DTCs related to the monitor will be displayed if the system has a problem. That is why some State's I/M programs require the Readiness Code as "Complete" before they check for DTCs.

*NOTE: After a repair is made for a DTC, the technician should drive the OBD-II Drive Cycle checking that the scan tool MB991958 (M.U.T.-III Sub Assembly) displays all the Readiness Codes as "Complete".*

**FAIL-SAFE FUNCTION REFERENCE TABLE**

The control is carried out, which keeps the safety driving by the preset control logic when the diagnosis code is output. The diagnosis code having the fail-safe function is as follows.

<b>DTC</b>	<b>DIAGNOSTIC ITEM</b>	<b>FAIL-SAFE AND BACKUP FUNCTION</b>
P0010	Intake engine oil control valve circuit	V.V.T. phase angle (intake) becomes most retarded angle.
P0013	Exhaust engine oil control valve circuit	V.V.T. phase angle (exhaust) becomes most advanced angle.
P0101	Mass airflow circuit range/performance problem	Fuel control is carried out using throttle opening degree and engine speed in accordance with preset map.
P0102	Mass airflow circuit low input	Fuel control is carried out using throttle opening degree and engine speed in accordance with preset map.
P0103	Mass airflow circuit high input	Fuel control is carried out using throttle opening degree and engine speed in accordance with preset map.
P0106	Manifold absolute pressure circuit range/performance problem	Control as if the intake manifold vacuum pressure is 101 kPa (29.8 in.Hg).
P0107	Manifold absolute pressure circuit low input	Control as if the intake manifold vacuum pressure is 101 kPa (29.8 in.Hg).
P0108	Manifold absolute pressure circuit high input	Control as if the intake manifold vacuum pressure is 101 kPa (29.8 in.Hg).
P0111	Intake air temperature circuit range/performance problem	Control as if the intake air temperature is 25° C (77° F).
P0112	Intake air temperature circuit low input	Control as if the intake air temperature is 25° C (77° F).
P0113	Intake air temperature circuit high input	Control as if the intake air temperature is 25° C (77° F).
P0116	Engine coolant temperature circuit range/performance problem	Control as if the engine coolant temperature is 80° C (176° F).
P0117	Engine coolant temperature circuit low input	Control as if the engine coolant temperature is 80° C (176° F).
P0118	Engine coolant temperature circuit high input	Control as if the engine coolant temperature is 80° C (176° F).
P0122	Throttle position sensor (main) circuit low input	<ul style="list-style-type: none"> <li>• Throttle opening degree is restricted.</li> <li>• Throttle opening degree position is in default position if throttle position sensor (sub) fails.</li> </ul>
P0123	Throttle position sensor (main) circuit high input	<ul style="list-style-type: none"> <li>• Throttle opening degree is restricted.</li> <li>• Throttle opening degree position is in default position if throttle position sensor (sub) fails.</li> </ul>
P0125	Insufficient coolant temperature for closed loop fuel control	Control as if the engine coolant temperature is 80° C (176° F).

<b>DTC</b>	<b>DIAGNOSTIC ITEM</b>	<b>FAIL-SAFE AND BACKUP FUNCTION</b>
P0222	Throttle position sensor (sub) circuit low input	<ul style="list-style-type: none"> <li>• Throttle opening degree is restricted.</li> <li>• Throttle opening degree position is in default position if throttle position sensor (main) fails.</li> </ul>
P0223	Throttle position sensor (sub) circuit high input	<ul style="list-style-type: none"> <li>• Throttle opening degree is restricted.</li> <li>• Throttle opening degree position is in default position if throttle position sensor (main) fails.</li> </ul>
P0300	Random/multiple cylinder misfire detected	The supply of fuel to the misfiring cylinder can possibly be cut.
P0301	Cylinder 1 misfire detected	The supply of fuel to the misfiring cylinder can possibly be cut.
P0302	Cylinder 2 misfire detected	The supply of fuel to the misfiring cylinder can possibly be cut.
P0303	Cylinder 3 misfire detected	The supply of fuel to the misfiring cylinder can possibly be cut.
P0304	Cylinder 4 misfire detected	The supply of fuel to the misfiring cylinder can possibly be cut.
P0327	Knock sensor circuit low	Fix the ignition timing with an allowance against knock.
P0328	Knock sensor circuit high	Fix the ignition timing with an allowance against knock.
P0340	Intake camshaft position sensor circuit	<ul style="list-style-type: none"> <li>• Engine runs in learned pattern until engine stops.</li> <li>• Does not control variable valve timing (V.V.T.).</li> </ul>
P0365	Exhaust camshaft position sensor circuit	Does not control variable valve timing (V.V.T.).
P0513	Immobilizer malfunction	Engine start is prohibited.
P0606	Engine control module main processor malfunction	Throttle opening degree position is in default position.
P0622	Generator FR terminal circuit malfunction	Prohibits generator output suppression control against current consumers. (Operates as a normal generator.)
P0638	Throttle actuator control motor circuit range/performance	Throttle opening degree position is in default position.
P0642	Throttle position sensor power supply	Throttle opening degree position is in default position.
P0657	Throttle actuator control motor relay circuit malfunction	Throttle opening degree position is in default position.
P1231	Active stability control plausibility <Vehicles with ASC>	Torque requested by active stability control (ASC) is ignored.
P1232	Fail safe system	Microcomputer is reset.
P1233	Throttle position sensor (main) plausibility	<ul style="list-style-type: none"> <li>• Throttle opening degree is restricted.</li> <li>• Throttle opening degree position is in default position if throttle position sensor (sub) fails.</li> </ul>



<b>DTC</b>	<b>DIAGNOSTIC ITEM</b>	<b>FAIL-SAFE AND BACKUP FUNCTION</b>
P1234	Throttle position sensor (sub) plausibility	<ul style="list-style-type: none"> <li>• Throttle opening degree is restricted.</li> <li>• Throttle opening degree position is in default position if throttle position sensor (main) fails.</li> </ul>
P1235	Mass airflow sensor plausibility	Fuel control is carried out using throttle opening degree and engine speed in accordance with preset map.
P1236	A/D converter	Throttle opening degree position is in default position.
P1237	Accelerator pedal position sensor plausibility	Throttle opening degree position is in default position.
P1238	Mass airflow sensor plausibility (torque monitor)	Throttle opening degree position is in default position.
P1239	Engine RPM plausibility	Throttle opening degree position is in default position.
P1240	Ignition angle	Ignition retard is not carried out.
P1241	Torque monitor	Throttle opening degree position is in default position.
P1242	Fail safe control monitor	Throttle opening degree position is in default position.
P1243	Inquiry/response error	Microcomputer is reset.
P1244	RAM test for all area	Microcomputer is reset.
P1245	Cycle RAM test (engine)	Microcomputer is reset.
P1247	CVT plausibility <CVT>	Torque requested by CVT-ECU is ignored.
P1590	TCM to ECM communication error in torque reduction request <CVT>	Engine output is restricted.
P1603	Battery backup circuit malfunction	All diagnosis codes are stored once failure judgment is completed.
P2100	Throttle actuator control motor circuit (open)	Throttle opening degree position is in default position.
P2101	Throttle actuator control motor magneto malfunction	Throttle opening degree position is in default position.
P2122	Accelerator pedal position sensor (main) circuit low input	<ul style="list-style-type: none"> <li>• Throttle opening degree is restricted.</li> <li>• Throttle opening degree position is in default position if accelerator pedal position sensor (sub) fails.</li> </ul>
P2123	Accelerator pedal position sensor (main) circuit high input	<ul style="list-style-type: none"> <li>• Throttle opening degree is restricted.</li> <li>• Throttle opening degree position is in default position if accelerator pedal position sensor (sub) fails.</li> </ul>
P2127	Accelerator pedal position sensor (sub) circuit low input	<ul style="list-style-type: none"> <li>• Throttle opening degree is restricted.</li> <li>• Throttle opening degree position is in default position if accelerator pedal position sensor (main) fails.</li> </ul>

<b>DTC</b>	<b>DIAGNOSTIC ITEM</b>	<b>FAIL-SAFE AND BACKUP FUNCTION</b>
P2128	Accelerator pedal position sensor (sub) circuit high input	<ul style="list-style-type: none"> <li>• Throttle opening degree is restricted.</li> <li>• Throttle opening degree position is in default position if accelerator pedal position sensor (main) fails.</li> </ul>
P2135	Throttle position sensor (main and sub) range/performance problem	Throttle opening degree position is in default position.
P2138	Accelerator pedal position sensor (main and sub) range/performance problem	<ul style="list-style-type: none"> <li>• Throttle opening degree is restricted.</li> <li>• Throttle opening degree position is in default position if accelerator pedal position sensor (sub) fails.</li> </ul>
P2228	Barometric pressure circuit low input	Control as if the barometric pressure is 101 kPa (29.8 in.Hg).
P2229	Barometric pressure circuit high input	Control as if the barometric pressure is 101 kPa (29.8 in.Hg).
P2253	Heated oxygen sensor offset circuit high voltage	Does not control air-fuel ratio closed loop.
U0167	Immobilizer communication error	Engine start is prohibited.

## DIAGNOSTIC TROUBLE CODE CHART

### **⚠ WARNING**

***When touching the throttle valve, surely shut off the driving circuits of the throttle valve. In the event that the throttle valve is operated, a finger might be injured as the result of being caught by the throttle valve.***

### **⚠ CAUTION**

**During diagnosis, a DTC code associated with other system may be set when the ignition switch is turned on with connector(s) disconnected. On completion, confirm all systems for DTC(s). If DTC(s) are set, erase them all.**

DTC	DIAGNOSTIC ITEM	REFERENCE PAGE
P0010	Intake engine oil control valve circuit	<a href="#">P.13B-60</a>
P0011	Intake variable valve timing system target error	<a href="#">P.13B-67</a>
P0013	Exhaust engine oil control valve circuit	<a href="#">P.13B-70</a>
P0014	Exhaust variable valve timing system target error	<a href="#">P.13B-77</a>
P0016	Crankshaft/camshaft (intake) position sensor phase problem	<a href="#">P.13B-80</a>
P0017	Crankshaft/camshaft (exhaust) position sensor phase problem	<a href="#">P.13B-83</a>
P0031	Heated oxygen sensor (front) heater control circuit low <Except vehicles for California>	<a href="#">P.13B-87</a>
	Heated oxygen sensor (front) heater control circuit low <Vehicles for California>	<a href="#">P.13B-94</a>
P0032	Heated oxygen sensor (front) heater control circuit high <Except vehicles for California>	<a href="#">P.13B-101</a>
	Heated oxygen sensor (front) heater control circuit high <Vehicles for California>	<a href="#">P.13B-106</a>
P0037	Heated oxygen sensor (rear) heater control circuit low <Except vehicles for California>	<a href="#">P.13B-111</a>
	Heated oxygen sensor (rear) heater control circuit low <Vehicles for California>	<a href="#">P.13B-118</a>
P0038	Heated oxygen sensor (rear) heater control circuit high <Except vehicles for California>	<a href="#">P.13B-125</a>
	Heated oxygen sensor (rear) heater control circuit high <Vehicles for California>	<a href="#">P.13B-130</a>
P0043	Heated oxygen sensor (3rd) heater control circuit low <Vehicles for California>	<a href="#">P.13B-135</a>
P0044	Heated oxygen sensor (3rd) heater control circuit high <Vehicles for California>	<a href="#">P.13B-142</a>
P0069	Abnormal correlation between manifold absolute pressure sensor and barometric pressure sensor	<a href="#">P.13B-147</a>
P0101 <sup>*1</sup>	Mass airflow circuit range/performance problem	<a href="#">P.13B-152</a>
P0102 <sup>*1</sup>	Mass airflow circuit low input	<a href="#">P.13B-158</a>
P0103 <sup>*1</sup>	Mass airflow circuit high input	<a href="#">P.13B-165</a>
P0106	Manifold absolute pressure circuit range/performance problem	<a href="#">P.13B-170</a>

<b>DTC</b>	<b>DIAGNOSTIC ITEM</b>	<b>REFERENCE PAGE</b>
P0107	Manifold absolute pressure circuit low input	<a href="#">P.13B-179</a>
P0108	Manifold absolute pressure circuit high input	<a href="#">P.13B-187</a>
P0111*1	Intake air temperature circuit range/performance problem	<a href="#">P.13B-192</a>
P0112*1	Intake air temperature circuit low input	<a href="#">P.13B-198</a>
P0113*1	Intake air temperature circuit high input	<a href="#">P.13B-202</a>
P0116*1	Engine coolant temperature circuit range/performance problem	<a href="#">P.13B-209</a>
P0117*1	Engine coolant temperature circuit low input	<a href="#">P.13B-215</a>
P0118*1	Engine coolant temperature circuit high input	<a href="#">P.13B-220</a>
P0122*1	Throttle position sensor (main) circuit low input	<a href="#">P.13B-227</a>
P0123*1	Throttle position sensor (main) circuit high input	<a href="#">P.13B-232</a>
P0125*1	Insufficient coolant temperature for closed loop fuel control	<a href="#">P.13B-238</a>
P0128	Coolant thermostat (coolant temperature below thermostat regulating temperature)	<a href="#">P.13B-246</a>
P0131	Heated oxygen sensor (front) circuit low voltage <Except vehicles for California>	<a href="#">P.13B-249</a>
	Heated oxygen sensor (front) circuit low voltage <Vehicles for California>	<a href="#">P.13B-258</a>
P0132	Heated oxygen sensor (front) circuit high voltage <Except vehicles for California>	<a href="#">P.13B-266</a>
	Heated oxygen sensor (front) circuit high voltage <Vehicles for California>	<a href="#">P.13B-271</a>
P0133	Heated oxygen sensor (front) circuit slow response <Except vehicles for California>	<a href="#">P.13B-276</a>
	Heated oxygen sensor (front) circuit slow response <Vehicles for California>	<a href="#">P.13B-282</a>
P0134*1	Heated oxygen sensor (front) circuit no activity detected <Except vehicles for California>	<a href="#">P.13B-287</a>
	Heated oxygen sensor (front) circuit no activity detected <Vehicles for California>	<a href="#">P.13B-293</a>
P0137	Heated oxygen sensor (rear) circuit low voltage <Except vehicles for California>	<a href="#">P.13B-300</a>
	Heated oxygen sensor (rear) circuit low voltage <Vehicles for California>	<a href="#">P.13B-308</a>
P0138	Heated oxygen sensor (rear) circuit high voltage <Except vehicles for California>	<a href="#">P.13B-316</a>
	Heated oxygen sensor (rear) circuit high voltage <Vehicles for California>	<a href="#">P.13B-321</a>
P0139	Heated oxygen sensor (rear) circuit slow response <Except vehicles for California>	<a href="#">P.13B-326</a>
	Heated oxygen sensor (rear) circuit slow response <Vehicles for California>	<a href="#">P.13B-331</a>

<b>DTC</b>	<b>DIAGNOSTIC ITEM</b>	<b>REFERENCE PAGE</b>
P0140	Heated oxygen sensor (rear) circuit no activity detected <Except vehicles for California>	<a href="#">P.13B-336</a>
	Heated oxygen sensor (rear) circuit no activity detected <Vehicles for California>	<a href="#">P.13B-340</a>
P0143	Heated oxygen sensor (3rd) circuit low voltage <Vehicles for California>	<a href="#">P.13B-344</a>
P0144	Heated oxygen sensor (3rd) circuit high voltage <Vehicles for California>	<a href="#">P.13B-352</a>
P0145	Heated oxygen sensor (3rd) circuit slow response <Vehicles for California>	<a href="#">P.13B-357</a>
P0146	Heated oxygen sensor (3rd) circuit no activity detected <Vehicles for California>	<a href="#">P.13B-361</a>
P0171	System too lean	<a href="#">P.13B-365</a>
P0172	System too rich	<a href="#">P.13B-371</a>
P0181	Fuel tank temperature sensor circuit range/performance	<a href="#">P.13B-377</a>
P0182	Fuel tank temperature sensor circuit low input	<a href="#">P.13B-383</a>
P0183	Fuel tank temperature sensor circuit high input	<a href="#">P.13B-388</a>
P0201	Injector circuit-cylinder 1	<a href="#">P.13B-395</a>
P0202	Injector circuit-cylinder 2	<a href="#">P.13B-404</a>
P0203	Injector circuit-cylinder 3	<a href="#">P.13B-413</a>
P0204	Injector circuit-cylinder 4	<a href="#">P.13B-422</a>
P0222 <sup>*1</sup>	Throttle position sensor (sub) circuit low input	<a href="#">P.13B-431</a>
P0223 <sup>*1</sup>	Throttle position sensor (sub) circuit high input	<a href="#">P.13B-437</a>
P0300 <sup>*2</sup>	Random/multiple cylinder misfire detected	<a href="#">P.13B-442</a>
P0301 <sup>*2</sup>	Cylinder 1 misfire detected	<a href="#">P.13B-447</a>
P0302 <sup>*2</sup>	Cylinder 2 misfire detected	<a href="#">P.13B-451</a>
P0303 <sup>*2</sup>	Cylinder 3 misfire detected	<a href="#">P.13B-455</a>
P0304 <sup>*2</sup>	Cylinder 4 misfire detected	<a href="#">P.13B-458</a>
P0327	Knock sensor circuit low	<a href="#">P.13B-462</a>
P0328	Knock sensor circuit high	<a href="#">P.13B-466</a>
P0335 <sup>*1</sup>	Crankshaft position sensor circuit	<a href="#">P.13B-470</a>
P0340 <sup>*1</sup>	Intake camshaft position sensor circuit	<a href="#">P.13B-481</a>
P0365 <sup>*1</sup>	Exhaust camshaft position sensor circuit	<a href="#">P.13B-490</a>
P0401	Exhaust gas recirculation flow insufficient detected	<a href="#">P.13B-498</a>
P0420	Warm up catalyst efficiency below threshold <Except vehicles for California>	<a href="#">P.13B-501</a>
P0421	Warm up catalyst efficiency below threshold <Vehicles for California>	<a href="#">P.13B-503</a>
P0441	Evaporative emission control system incorrect purge flow	<a href="#">P.13B-506</a>
P0442	Evaporative emission control system leak detected (small leak)	<a href="#">P.13B-510</a>

<b>DTC</b>	<b>DIAGNOSTIC ITEM</b>	<b>REFERENCE PAGE</b>
P0443	Evaporative emission control system purge control valve circuit	<a href="#">P.13B-522</a>
P0446	Evaporative emission control system vent control circuit	<a href="#">P.13B-529</a>
P0450	Evaporative emission control system pressure sensor malfunction	<a href="#">P.13B-536</a>
P0451	Evaporative emission control system pressure sensor range/performance	<a href="#">P.13B-544</a>
P0452	Evaporative emission control system pressure sensor low input	<a href="#">P.13B-552</a>
P0453	Evaporative emission control system pressure sensor high input	<a href="#">P.13B-562</a>
P0455	Evaporative emission control system leak detected (gross leak)	<a href="#">P.13B-569</a>
P0456	Evaporative emission control system leak detected (very small leak)	<a href="#">P.13B-579</a>
P0461	Fuel level sensor circuit range/performance	<a href="#">P.13B-589</a>
P0462	Fuel level sensor circuit low input	<a href="#">P.13B-592</a>
P0463	Fuel level sensor circuit high input	<a href="#">P.13B-595</a>
P0489	EGR valve (stepper motor) circuit malfunction (ground short)	<a href="#">P.13B-598</a>
P0490	EGR valve (stepper motor) circuit malfunction (battery short)	<a href="#">P.13B-605</a>
P0500 <sup>*1</sup>	Vehicle speed sensor malfunction <M/T>	<a href="#">P.13B-610</a>
P0506	Idle control system RPM lower than expected	<a href="#">P.13B-618</a>
P0507	Idle control system RPM higher than expected	<a href="#">P.13B-621</a>
P050B	Ignition timing retard insufficient	<a href="#">P.13B-624</a>
P0513	Immobilizer malfunction	<a href="#">P.13B-627</a>
P0551	Power steering pressure switch circuit range/performance	<a href="#">P.13B-629</a>
P0554	Power steering pressure switch circuit intermittent	<a href="#">P.13B-634</a>
P0603 <sup>*1</sup>	EEPROM malfunction	<a href="#">P.13B-639</a>
P0606 <sup>*1</sup>	Engine control module main processor malfunction	<a href="#">P.13B-641</a>
P0622	Generator FR terminal circuit malfunction	<a href="#">P.13B-646</a>
P0630 <sup>*1</sup>	Vehicle Identification Number (VIN) malfunction	<a href="#">P.13B-651</a>
P0638 <sup>*1</sup>	Throttle actuator control motor circuit range/ performance	<a href="#">P.13B-653</a>
P0642 <sup>*1</sup>	Throttle position sensor power supply	<a href="#">P.13B-656</a>
P0657 <sup>*1</sup>	Throttle actuator control motor relay circuit malfunction	<a href="#">P.13B-658</a>
P1231	Active stability control plausibility	<a href="#">P.13B-665</a>
P1232	Fail safe system	<a href="#">P.13B-667</a>
P1233 <sup>*1</sup>	Throttle position sensor (main) plausibility	<a href="#">P.13B-668</a>
P1234 <sup>*1</sup>	Throttle position sensor (sub) plausibility	<a href="#">P.13B-672</a>
P1235 <sup>*1</sup>	Mass airflow sensor plausibility	<a href="#">P.13B-676</a>
P1236 <sup>*1</sup>	A/D converter	<a href="#">P.13B-680</a>
P1237 <sup>*1</sup>	Accelerator pedal position sensor plausibility	<a href="#">P.13B-681</a>
P1238 <sup>*1</sup>	Mass airflow sensor plausibility (torque monitor)	<a href="#">P.13B-685</a>

<b>DTC</b>	<b>DIAGNOSTIC ITEM</b>	<b>REFERENCE PAGE</b>
P1239*1	Engine RPM plausibility	<a href="#">P.13B-688</a>
P1240	Ignition angle	<a href="#">P.13B-690</a>
P1241*1	Torque monitor	<a href="#">P.13B-692</a>
P1242	Fail safe control monitor	<a href="#">P.13B-697</a>
P1243	Inquiry/response error	<a href="#">P.13B-699</a>
P1244	RAM test for all area	<a href="#">P.13B-700</a>
P1245	Cycle RAM test (engine)	<a href="#">P.13B-701</a>
P1247	CVT plausibility <CVT>	<a href="#">P.13B-702</a>
P1506	Idle control system RPM lower than expected at low temperature	<a href="#">P.13B-703</a>
P1507	Idle control system RPM higher than expected at low temperature	<a href="#">P.13B-706</a>
P1590*1	TCM to ECM communication error in torque reduction request <CVT>	<a href="#">P.13B-709</a>
P1603*1	Battery backup circuit malfunction	<a href="#">P.13B-712</a>
P1676*1	Variant coding	<a href="#">P.13B-716</a>
P2096	Post catalyst fuel trim system too lean	<a href="#">P.13B-718</a>
P2097	Post catalyst fuel trim system too rich	<a href="#">P.13B-721</a>
P2100*1	Throttle actuator control motor circuit (open)	<a href="#">P.13B-725</a>
P2101*1	Throttle actuator control motor magneto malfunction	<a href="#">P.13B-730</a>
P2122*1	Accelerator pedal position sensor (main) circuit low input	<a href="#">P.13B-734</a>
P2123*1	Accelerator pedal position sensor (main) circuit high input	<a href="#">P.13B-739</a>
P2127*1	Accelerator pedal position sensor (sub) circuit low input	<a href="#">P.13B-744</a>
P2128*1	Accelerator pedal position sensor (sub) circuit high input	<a href="#">P.13B-749</a>
P2135*1	Throttle position sensor (main and sub) range/performance problem	<a href="#">P.13B-753</a>
P2138*1	Accelerator pedal position sensor (main and sub) range/performance problem	<a href="#">P.13B-760</a>
P2195	Heated oxygen sensor (front) inactive <Except vehicles for California>	<a href="#">P.13B-767</a>
	Heated oxygen sensor (front) inactive <Vehicles for California>	<a href="#">P.13B-770</a>
P2228*1	Barometric pressure circuit low input	<a href="#">P.13B-773</a>
P2229*1	Barometric pressure circuit high input	<a href="#">P.13B-775</a>
P2252	Heated oxygen sensor offset circuit low voltage <Except vehicles for California>	<a href="#">P.13B-778</a>
	Heated oxygen sensor offset circuit low voltage <Vehicles for California>	<a href="#">P.13B-783</a>
P2253	Heated oxygen sensor offset circuit high voltage <Except vehicles for California>	<a href="#">P.13B-791</a>
	Heated oxygen sensor offset circuit high voltage <Vehicles for California>	<a href="#">P.13B-798</a>
P2423	HC adsorber (HC trap catalyst) efficiency below threshold <Vehicles for California>	<a href="#">P.13B-808</a>
U0001	Bus off	<a href="#">P.13B-810</a>

DTC	DIAGNOSTIC ITEM	REFERENCE PAGE
U0101* <sup>1</sup>	TCM time-out <CVT>	P.13B-812
U0121	ASC-ECU time-out	P.13B-816
U0141* <sup>1</sup>	ETACS-ECU time-out	P.13B-819
U0167	Immobilizer communication error	P.13B-823
U1180* <sup>1</sup>	Combination meter time-out	P.13B-825

*NOTE: Do not replace the engine control module (ECM) until a through terminal check reveals there are no short/open circuits.*

*NOTE: Check that the ECM ground circuit is normal before checking for the cause of the problem.*

*NOTE: After the ECM detects a malfunction, a diagnostic trouble code is recorded the next time the engine is started and the same malfunction is re-detected. However, for items marked with a "\*1", the diagnostic trouble code is recorded on the first detection of the malfunction.*

*NOTE: The codes marked with a "\*2" in the diagnosis code number column have the following two conditions for recording the diagnostic trouble code.*

- In case that the misfire causing the damaged catalyst is detected, the diagnostic trouble code is recorded at the time.
- In case that the misfire deteriorating the exhaust gas is detected, the diagnostic trouble code is recorded when the same malfunction is re-detected after the next engine start.

## SYMPTOM CHART

M1131151503297

### **⚠ WARNING**

**When touching the throttle valve, surely shut off the driving circuits of the throttle valve. In the event that the throttle valve is operated, a finger might be injured as the result of being caught by the throttle valve.**

### **⚠ CAUTION**

**During diagnosis, a DTC associated with other systems may be set when the ignition switch is turned on with connector(s) disconnected. On completion, confirm all systems for DTC(s). If DTC(s) are set, erase them all.**

### **⚠ CAUTION**

**Disconnecting the battery cables or removing the combination meter will erase the learned value of the fuel gauge. To recover the learned value, input a vehicle speed (by actually driving the vehicle or inputting a simulated vehicle speed), and stop the vehicle. This will complete the learning process.**

*NOTE: Check that the ECM ground circuit is normal before checking for the cause of the problem.*

*NOTE: When the racing (2,000 to 5,000 r/min or more) continues on the vehicle stopped with no load during the specified time or more, the increase in the engine speed might be limited. This comes from the engine protection and control functions and is not a malfunction.*



TROUBLE SYMPTOMS		INSPECTION PROCEDURE	REFERENCE PAGE
Communication with scan tool is impossible	Communication with ECM is not possible	1	<a href="#">P.13B-829</a>
Malfunction Indicator Lamp (SERVICE ENGINE SOON or Check Engine Lamp) and related parts	The Malfunction Indicator Lamp (SERVICE ENGINE SOON or Check Engine Lamp) does not illuminate right after the ignition switch is turned to the "ON" position	2	<a href="#">P.13B-835</a>
	The Malfunction Indicator Lamp (SERVICE ENGINE SOON or Check Engine Lamp) remains illuminated and never goes out	3	<a href="#">P.13B-835</a>
Starting	Cranks, won't start	4	<a href="#">P.13B-837</a>
	Starts up and dies	5	<a href="#">P.13B-844</a>
	Hard starting	6	<a href="#">P.13B-848</a>
Idling stability (improper idling)	Unstable idle (rough idle, hunting)	7	<a href="#">P.13B-853</a>
	Idle speed is high (improper idle speed)	8	<a href="#">P.13B-857</a>
	Idle speed is low (improper idle speed)	9	<a href="#">P.13B-858 &lt;M/T&gt;</a> , <a href="#">P.13B-859 &lt;CVT&gt;</a>
Idling stability (engine stalls)	When the engine is cold, it stalls at idle (die out)	10	<a href="#">P.13B-861</a>
	When the engine is hot, it stalls at idle (die out)	11	<a href="#">P.13B-863</a>
	The engine stalls when accelerating (pass out)	12	<a href="#">P.13B-866</a>
	The engine stalls when decelerating	13	<a href="#">P.13B-868</a>
Driving	Hesitation, sag, stumble, poor acceleration or surge	14	<a href="#">P.13B-870</a>
	Acceleration shock	15	<a href="#">P.13B-873</a>
	Knocking	16	<a href="#">P.13B-875</a>
Dieseling (run-on)		17	<a href="#">P.13B-876</a>
Too high CO and HC concentration when idling		18	<a href="#">P.13B-877</a>
IM240 test failure	Transient, mass emission tailpipe test failure	19	<a href="#">P.13B-879</a>
	Purge flow test of the evaporative emission canister failure	20	<a href="#">P.13B-883</a>
	Pressure test of the evaporative system failure	21	<a href="#">P.13B-884</a>
Generator output voltage is low (approximately 12.3 volts)		22	<a href="#">P.13B-886</a>
Power supply system and ignition switch-IG system		23	<a href="#">P.13B-889</a>
Fuel pump system		24	<a href="#">P.13B-899</a>
Ignition switch-ST system and starter relay system <M/T>		25	<a href="#">P.13B-907</a>
Ignition switch-ST system and starter relay system <CVT>		26	<a href="#">P.13B-919</a>
Ignition circuit system		27	<a href="#">P.13B-932</a>

TROUBLE SYMPTOMS	INSPECTION PROCEDURE	REFERENCE PAGE
A/C system	28	<a href="#">P.13B-938</a>
Engine oil pressure switch system	29	<a href="#">P.13B-941</a>
Power steering pressure switch system	30	<a href="#">P.13B-944</a>

### PROBLEM SYMPTOMS TABLE (FOR YOUR INFORMATION)

ITEMS		SYMPTOM
At starting	Won't start	The starter cranks the engine, but there is no combustion within the cylinders, and the engine won't start.
	Starts up and dies	The engine starts, but then engine soon stalls.
	Hard starting	Engine starts after cranking a while.
Idling stability	Hunting	Engine speed doesn't remain constant; changes at idle.
	Rough idle	Usually, a judgement can be based upon the movement of the tachometer pointer, and the vibration transmitted to the steering wheel, shift lever, body, etc.
	Incorrect idle speed	The engine doesn't idle at the correct speed.
	Engine stall (die out)	The engine stalls when the foot is taken from the accelerator pedal, regardless of whether the vehicle is moving or not.
	Engine stall (pass out)	The engine stalls when the accelerator pedal is depressed.

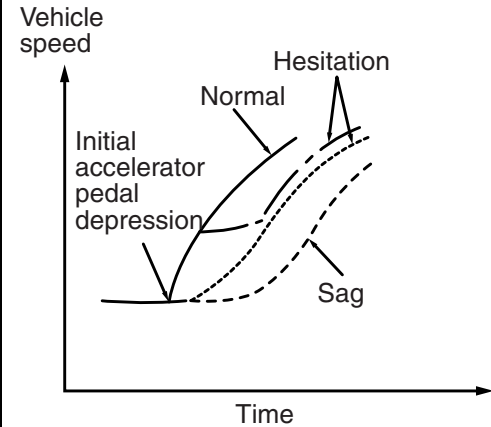
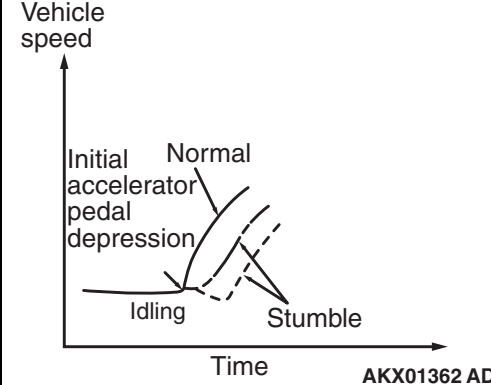
ITEMS	SYMPTOM	
At driving	Hesitation Sag	<p>"Hesitation" is the delay in response of the vehicle speed (engine speed). This occurs when the accelerator is depressed in order to accelerate from the speed at which the vehicle is now traveling, or a temporary drop in vehicle speed (engine speed) during such acceleration. Serious hesitation is called "sag".</p>  <p align="right">AKX01361AC</p>
	Poor acceleration	<p>Poor acceleration is inability to obtain an acceleration corresponding to the degree of throttle opening, even though acceleration is smooth. Also the inability to reach maximum speed.</p>
	Stumble	<p>Engine speed increase is delayed when the accelerator pedal is initially depressed for acceleration.</p>  <p align="right">AKX01362 AD</p>
	Shock	<p>The feeling of a comparatively large impact or vibration when the engine is accelerated or decelerated.</p>
	Surge	<p>This is slight acceleration and deceleration feel usually felt during steady, light throttle cruise. Most notable under light loads.</p>
	Knocking	<p>A sharp sound during driving, which sounds like a hammer striking the cylinder walls. It makes poor driveability.</p>
At stopped	Run on ("dieseling")	<p>The condition in which the engine continues to run after the ignition switch is turned to the "LOCK" (OFF) position. Also called "dieseling".</p>

DIAGNOSTIC TROUBLE CODE PROCEDURES

DTC P0010: Intake Engine Oil Control Valve Circuit

INTAKE ENGINE OIL CONTROL VALVE CIRCUIT

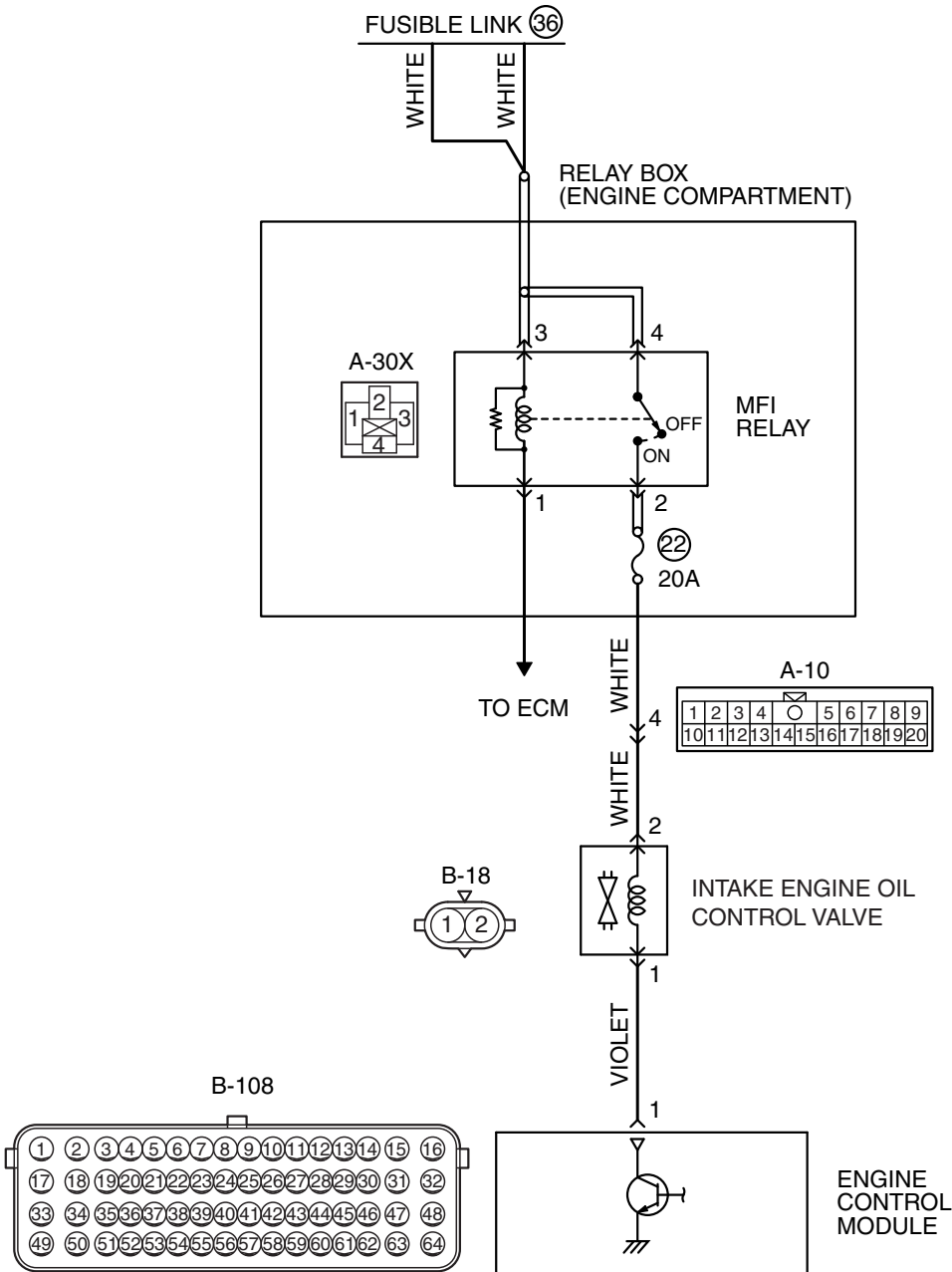

AK704780AB

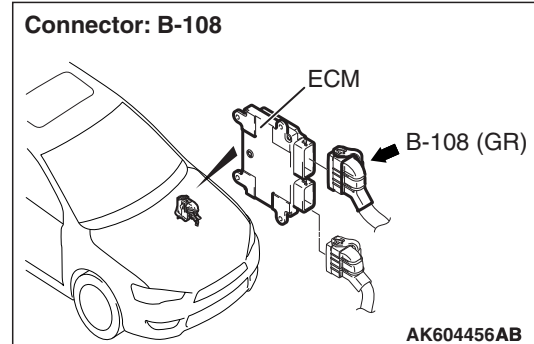
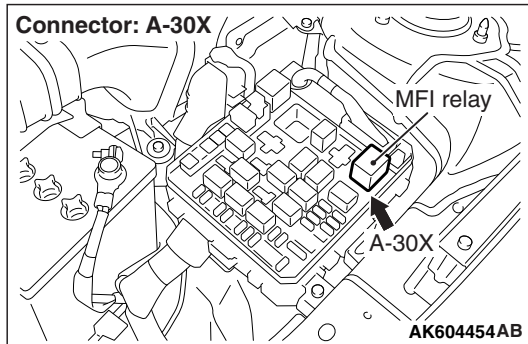
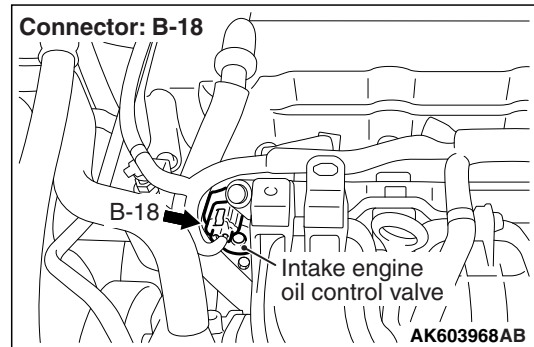
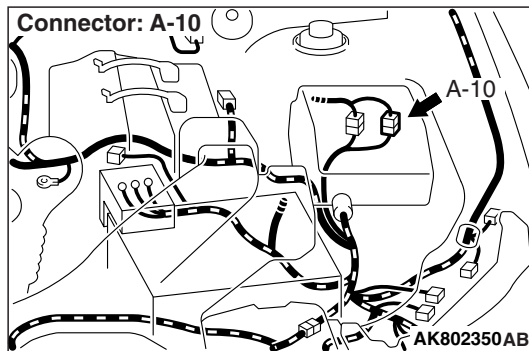

## CIRCUIT OPERATION

- The intake engine oil control valve power is supplied from the MFI relay (terminal No. 2).
- The ECM controls ground intake engine oil control valve by turning the power transistor in the ECM "ON" and "OFF".

## TECHNICAL DESCRIPTION

- The intake engine oil control valve changes the phase angle to operate the MIVEC system in the advance or the retard side in accordance with signals from the ECM.

## DESCRIPTIONS OF MONITOR METHODS

Intake engine oil control valve circuit current is out of the specified range.

## MONITOR EXECUTION

Continuous

## MONITOR EXECUTION CONDITIONS (Other monitor and Sensor)

**Other Monitor (There is no temporary DTC stored in memory for the item monitored below)**

- Not applicable

**Sensor (The sensor below is determined to be normal)**

- Camshaft position sensor
- Crankshaft position sensor
- Engine coolant temperature sensor
- Throttle position sensor
- Engine oil control valve

## DTC SET CONDITIONS

## Logic Flow Chart

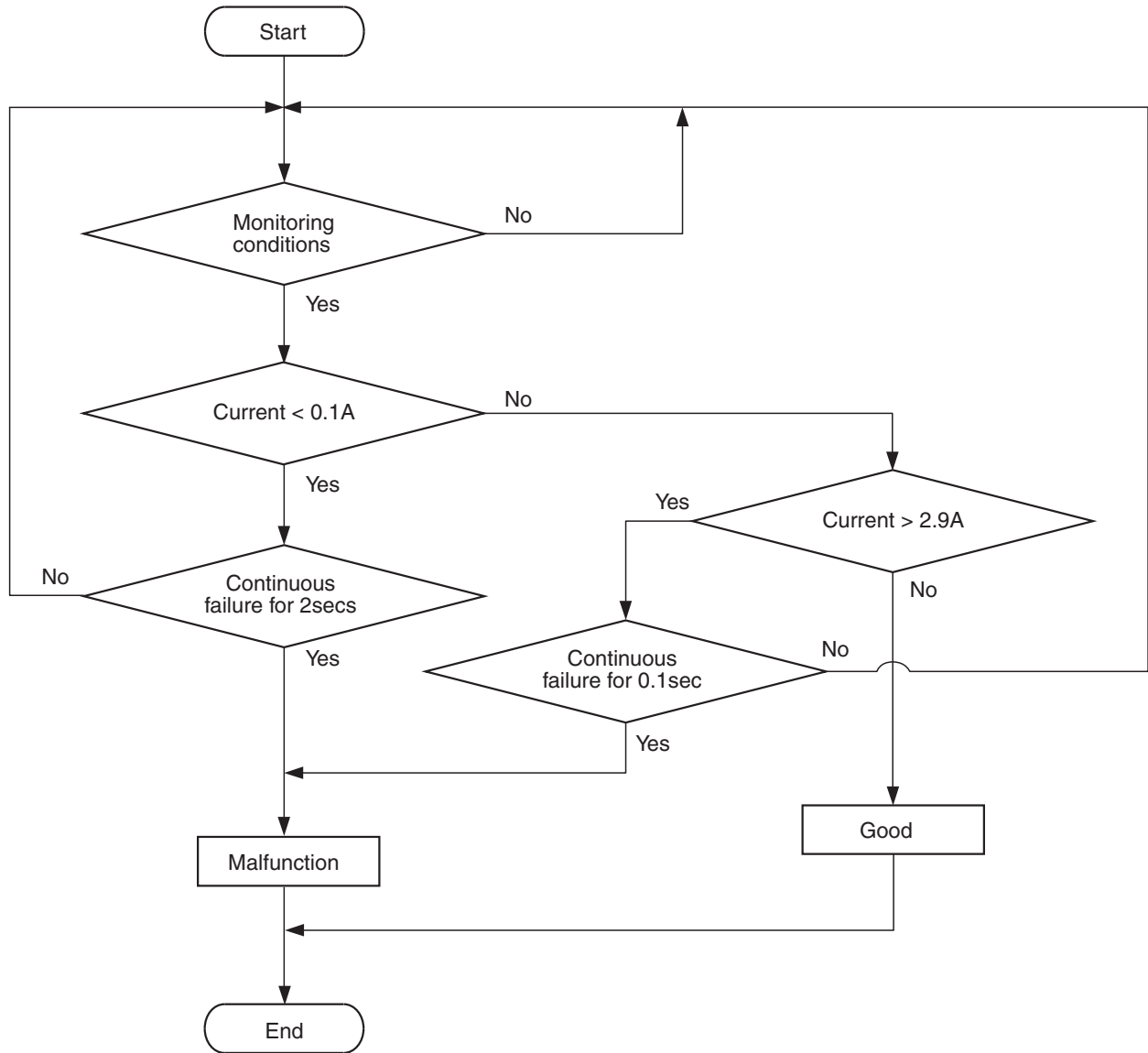

AK704777

**Check Conditions**

- Ignition switch is "ON" position.
- Battery positive voltage is between 10 and 16.5 volts.
- ON duty cycle of the intake engine oil control valve circuit is more than 20 percent.

**Judgement Criterion**

- The ECM terminal current of intake engine oil control valve circuit is less than 0.1 ampere for 2 seconds.

**Check Conditions**

- Ignition switch is "ON" position.

- Battery positive voltage is between 10 and 16.5 volts.

**Judgement Criterion**

- The ECM terminal current of intake engine oil control valve circuit is more than 2.9 amperes for 0.1 second.

**FAIL-SAFE AND BACKUP FUNCTION**

- V.V.T. phase angle (intake) becomes most retarded angle.

**OBD-II DRIVE CYCLE PATTERN**

Refer to Diagnostic Function –OBD-II Drive Cycle – Pattern 20 [P.13B-12](#).

**TROUBLESHOOTING HINTS (The most likely causes for this code to be set are:)**

- Intake engine oil control valve failed.
- Open or shorted intake engine oil control valve circuit, or harness damage, or connector damage.
- ECM failed.

**DIAGNOSIS**

**Required Special Tools:**

- MB991958: Scan Tool (M.U.T.-III Sub Assembly)
  - MB991824: V.C.I.
  - MB991827: USB Cable
  - MB991910: Main Harness A
- MB992110: Power Plant ECU Check Harness

**STEP 1. Using scan tool MB991958, check actuator test item 17: Engine Oil Control Valve.**

**⚠ CAUTION**

To prevent damage to scan tool MB991958, always turn the ignition switch to the "LOCK" (OFF) position before connecting or disconnecting scan tool MB991958.

- (1) Connect scan tool MB991958 to the data link connector.
- (2) Turn the ignition switch to the "ON" position.
- (3) Set scan tool MB991958 to the actuator test mode for item 17, Engine Oil Control Valve.
  - An operation sound should be heard and vibration should be felt when the intake engine oil control valve is operated.
- (4) Turn the ignition switch to the "LOCK" (OFF) position.

**Q: Is the actuator operating properly?**

- YES :** It can be assumed that this malfunction is intermittent. Refer to GROUP 00, How to Use Troubleshooting/Inspection Service Points –How to Cope with Intermittent Malfunctions P.00-13.
- NO :** Go to Step 2.

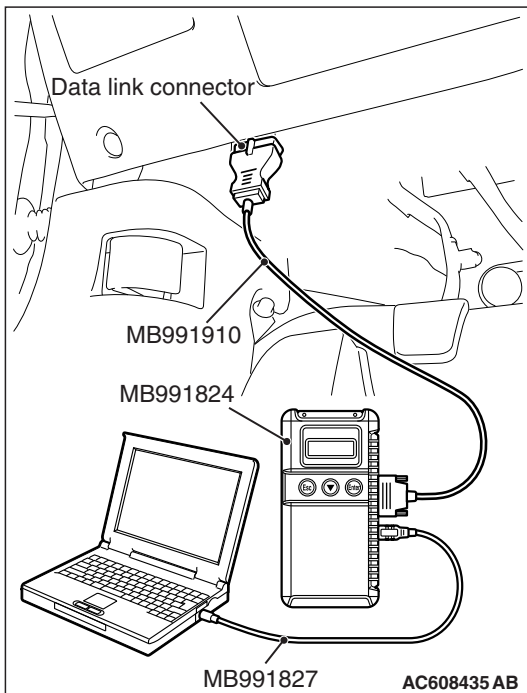

**STEP 2. Check harness connector B-18 at intake engine oil control valve for damage.**

**Q: Is the harness connector in good condition?**

- YES :** Go to Step 3.
- NO :** Repair or replace it. Refer to GROUP 00E, Harness Connector Inspection P.00E-2. Then go to Step 12.

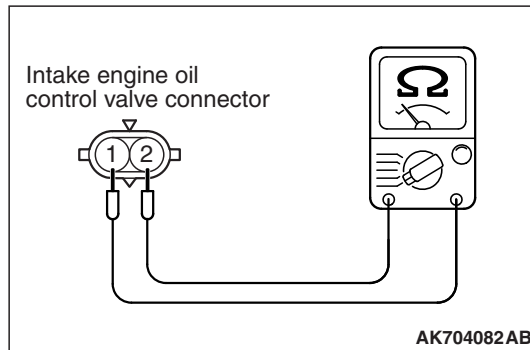
**STEP 3. Check the intake engine oil control valve.**

- (1) Disconnect the intake engine oil control valve connector B-18.
- (2) Measure the resistance between intake engine oil control valve side connector terminal No. 1 and No. 2.

**Standard value: 6.9 – 7.9 Ω [at 20° C (68° F)]**

**Q: Is the measured resistance between 6.9 and 7.9 Ω [at 20° C (68° F)]?**

**YES :** Go to Step 4.

**NO :** Replace the intake engine oil control valve. Then go to Step 12.

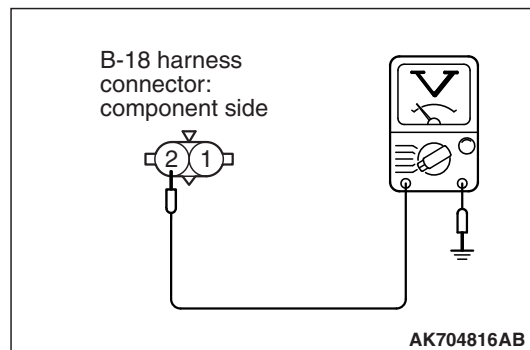
**STEP 4. Measure the power supply voltage at intake engine oil control valve harness side connector B-18.**

- (1) Disconnect the connector B-18 and measure at the harness side.
- (2) Turn the ignition switch to the "ON" position.
- (3) Measure the voltage between terminal No. 2 and ground.
  - Voltage should be battery positive voltage.
- (4) Turn the ignition switch to the "LOCK" (OFF) position.

**Q: Is battery positive voltage (approximately 12 volts) present?**

**YES :** Go to Step 6.

**NO :** Go to Step 5.

**STEP 5. Check harness connector A-30X at MFI relay for damage.**

**Q: Is the harness connector in good condition?**

**YES :** Check harness connector A-10 at intermediate connector for damage, and repair or replace as required. Refer to GROUP 00E, Harness Connector Inspection [P.00E-2](#). If intermediate connector is in good condition, repair harness wire between MFI relay connector A-30X (terminal No. 2) and intake engine oil control valve connector B-18 (terminal No. 2) because of open circuit or short circuit to ground. Then go to Step 12.

**NO :** Repair or replace it. Refer to GROUP 00E, Harness Connector Inspection [P.00E-2](#). Then go to Step 12.

**STEP 6. Check harness connector B-108 at ECM for damage.**

**Q: Is the harness connector in good condition?**

**YES :** Go to Step 7.

**NO :** Repair or replace it. Refer to GROUP 00E, Harness Connector Inspection [P.00E-2](#). Then go to Step 12.



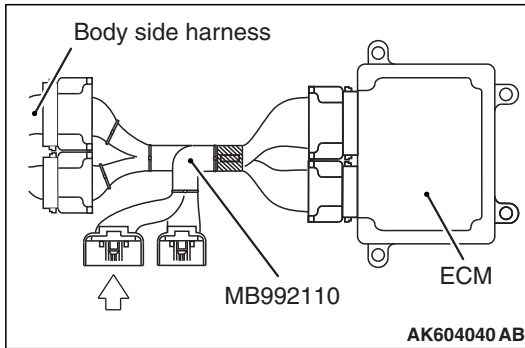

**STEP 7. Measure the power supply voltage at ECM connector B-108 by using power plant ECU check harness special tool MB992110.**

(1) Disconnect all ECM connectors. Connect the power plant ECU check harness special tool MB992110 between the separated connectors.

(2) Turn the ignition switch to the "ON" position.

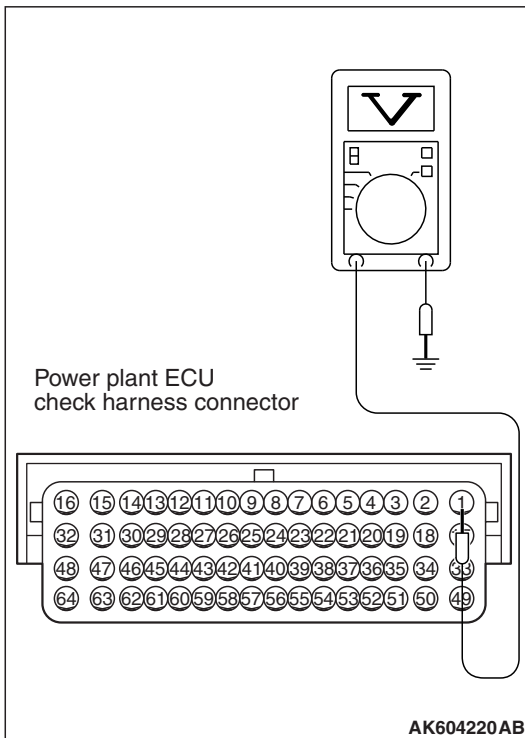

(3) Measure the voltage between terminal No. 1 and ground.

- Voltage should be battery positive voltage.

(4) Turn the ignition switch to the "LOCK" (OFF) position.

**Q: Is battery positive voltage (approximately 12 volts) present?**

**YES :** Go to Step 8.

**NO :** Repair harness wire between intake engine oil control valve connector B-18 (terminal No. 1) and ECM connector B-108 (terminal No. 1) because of open circuit or short circuit to ground. Then go to Step 12.

**STEP 8. Check harness connector A-30X at MFI relay for damage.**

**Q: Is the harness connector in good condition?**

**YES :** Go to Step 9.

**NO :** Repair or replace it. Refer to GROUP 00E, Harness Connector Inspection [P.00E-2](#). Then go to Step 12.

**STEP 9. Check for harness damage between MFI relay connector A-30X (terminal No. 2) and intake engine oil control valve connector B-18 (terminal No. 2).**

*NOTE: Check harness after checking intermediate connector A-10. If intermediate connector is damaged, repair or replace it. Refer to GROUP 00E, Harness Connector Inspection P.00E-2. Then go to Step 12.*

**Q: Is the harness wire in good condition?**

**YES** : Go to Step 10.

**NO** : Repair it. Then go to Step 12.

---

**STEP 10. Check for harness damage between intake engine oil control valve connector B-18 (terminal No. 1) and ECM connector B-108 (terminal No. 1).**

**Q: Is the harness wire in good condition?**

**YES** : Go to Step 11.

**NO** : Repair it. Then go to Step 12.

---

**STEP 11. Using scan tool MB991958, check actuator test item 17: Engine Oil Control Valve.**

(1) Turn the ignition switch to the "ON" position.

(2) Set scan tool MB991958 to the actuator test mode for item 17, Engine Oil Control Valve.

- An operation sound should be heard and vibration should be felt when the intake engine oil control valve is operated.

(3) Turn the ignition switch to the "LOCK" (OFF) position.

**Q: Is the actuator operating properly?**

**YES** : It can be assumed that this malfunction is intermittent. Refer to GROUP 00, How to Use Troubleshooting/Inspection Service Points –How to Cope with Intermittent Malfunctions P.00-13.

**NO** : Replace the ECM (Refer to, Removal and Installation P.13B-1022). Then go to Step 12.

---

**STEP 12. Test the OBD-II drive cycle.**

(1) Carry out test drive with the drive cycle pattern. Refer to Diagnostic Function –OBD-II Drive Cycle –Pattern 20 P.13B-12.

(2) Check the diagnostic trouble code (DTC).

**Q: Is DTC P0010 set?**

**YES** : Retry the troubleshooting.

**NO** : The inspection is complete.

**DTC P0011: Intake Variable Valve Timing System Target Error**

**TECHNICAL DESCRIPTION**

- The ECM checks the variable valve timing system for malfunction.

**DESCRIPTIONS OF MONITOR METHODS**

The difference between the actual intake valve opening timing and the intake valve target opening timing is over the specified value.

**MONITOR EXECUTION**

Continuous

**MONITOR EXECUTION CONDITIONS  
(Other monitor and Sensor)**

**Other Monitor (There is no temporary DTC stored in memory for the item monitored below)**

- Not applicable

**Sensor (The sensor below is determined to be normal)**

- Camshaft position sensor
- Crankshaft position sensor
- Engine coolant temperature sensor
- Throttle position sensor
- Engine oil control valve

**DTC SET CONDITIONS**

**Logic Flow Chart**

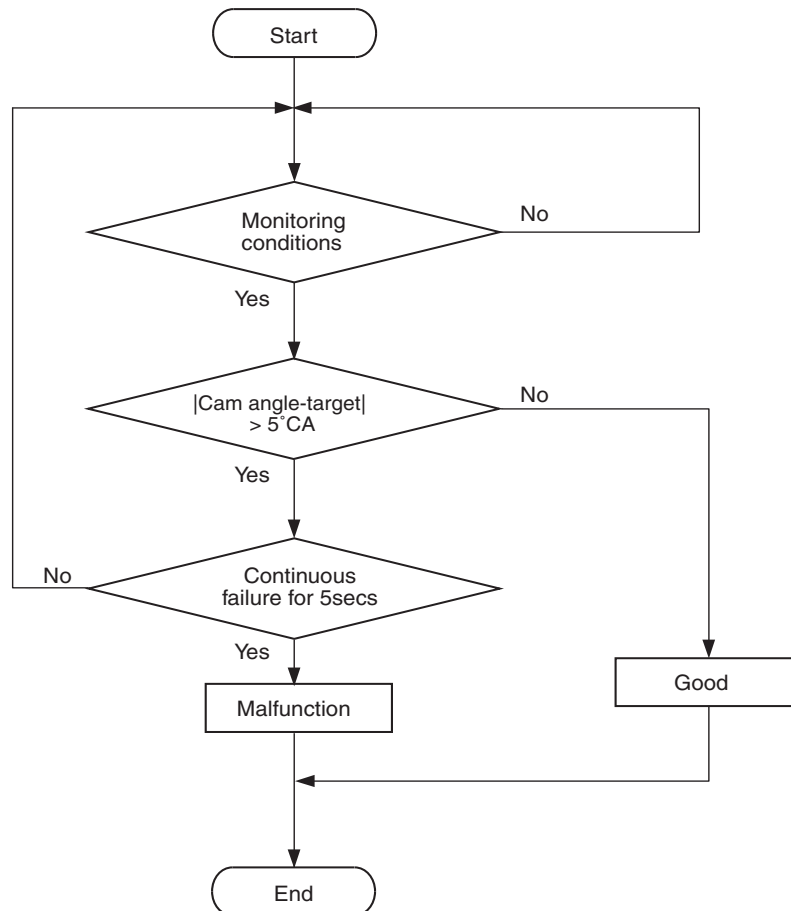

Cam angle: Intake valve open timing (intake side)  
Exhaust valve close timing (exhaust side)

AK704222

**Check Conditions**

- More than 20 seconds have passed since the engine starting sequence was completed.
- Engine speed is more than 1,188 r/min.
- Engine coolant temperature is more than 76° C (169° F).

**Judgment Criterion**

- The difference between the actual intake valve opening timing and the intake valve target opening timing is more than 5 degrees for 5 seconds.

**FAIL-SAFE AND BACKUP FUNCTION**

- None

**OBD-II DRIVE CYCLE PATTERN**

Refer to Diagnostic Function –OBD-II Drive Cycle – Pattern 20 [P.13B-12](#).

**TROUBLESHOOTING HINTS (The most likely causes for this code to be set are:)**

- Intake engine oil control valve failed.
- Oil passage of variable valve timing control system clogged.
- Intake variable valve timing sprocket operation mechanism stuck.
- ECM failed.

**DIAGNOSIS****Required Special Tool:**

- MB991958: Scan Tool (M.U.T.-III Sub Assembly)
  - MB991824: V.C.I.
  - MB991827: USB Cable
  - MB991910: Main Harness A

**STEP 1. Using scan tool MB991958, read the diagnostic trouble code (DTC).**

**⚠ CAUTION**

To prevent damage to scan tool MB991958, always turn the ignition switch to the "LOCK" (OFF) position before connecting or disconnecting scan tool MB991958.

- (1) Connect scan tool MB991958 to the data link connector.
- (2) Turn the ignition switch to the "ON" position.
- (3) Set scan tool MB991958, read the DTC.
- (4) Turn the ignition switch to the "LOCK" (OFF) position.

**Q: Is the diagnostic trouble code other than P0011 set?**

- YES :** Refer to, Diagnostic Trouble Code Chart [P.13B-51](#).  
**NO :** Go to Step 2.

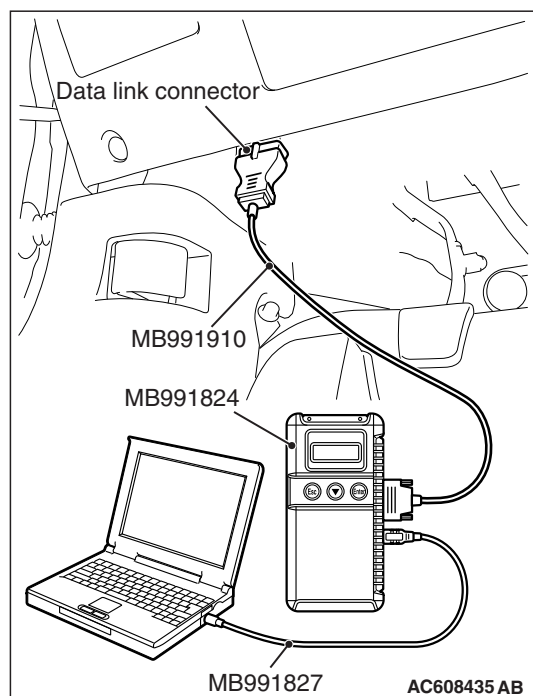

**STEP 2. Check the intake engine oil control valve.**

Refer to, Engine Oil Control Valve Check [P.13B-1012](#).

**Q: Is the check result normal?**

- YES :** Go to Step 3.  
**NO :** Replace the intake engine oil control valve. Then go to Step 6.

---

**STEP 3. Check intake variable valve timing sprocket operation mechanism for being stuck.**

Refer to GROUP 11D, Timing Chain –Inspection [P.11D-37](#).

**Q: Is the check result normal?**

**YES** : Go to Step 4.

**NO** : Repair it. Then go to Step 6.

---

**STEP 4. Check oil passage of intake variable valve timing control system for being clogged.**

**Q: Is the check result normal?**

**YES** : Go to Step 5.

**NO** : Repair it. Then go to Step 6.

---

**STEP 5. Check the trouble symptoms.**

(1) Carry out test drive with the drive cycle pattern. Refer to Diagnostic Function –OBD-II Drive Cycle –Pattern 20 [P.13B-12](#).

(2) Check the diagnostic trouble code (DTC).

**Q: Is DTC P0011 set?**

**YES** : Replace the ECM (Refer to, Removal and Installation [P.13B-1022](#)). Then go to Step 6.

**NO** : It can be assumed that this malfunction is intermittent. Refer to GROUP 00, How to Use Troubleshooting/Inspection Service Points –How to Cope with Intermittent Malfunctions [P.00-13](#).

---

**STEP 6. Test the OBD-II drive cycle.**

(1) Carry out a test drive with the drive cycle pattern. Refer to Diagnostic Function –OBD-II Drive Cycle –Pattern 20 [P.13B-12](#).

(2) Check the diagnostic trouble code (DTC).

**Q: Is DTC P0011 set?**

**YES** : Retry the troubleshooting.

**NO** : The inspection is complete.

DTC P0013: Exhaust Engine Oil Control Valve Circuit

EXHAUST ENGINE OIL CONTROL VALVE CIRCUIT

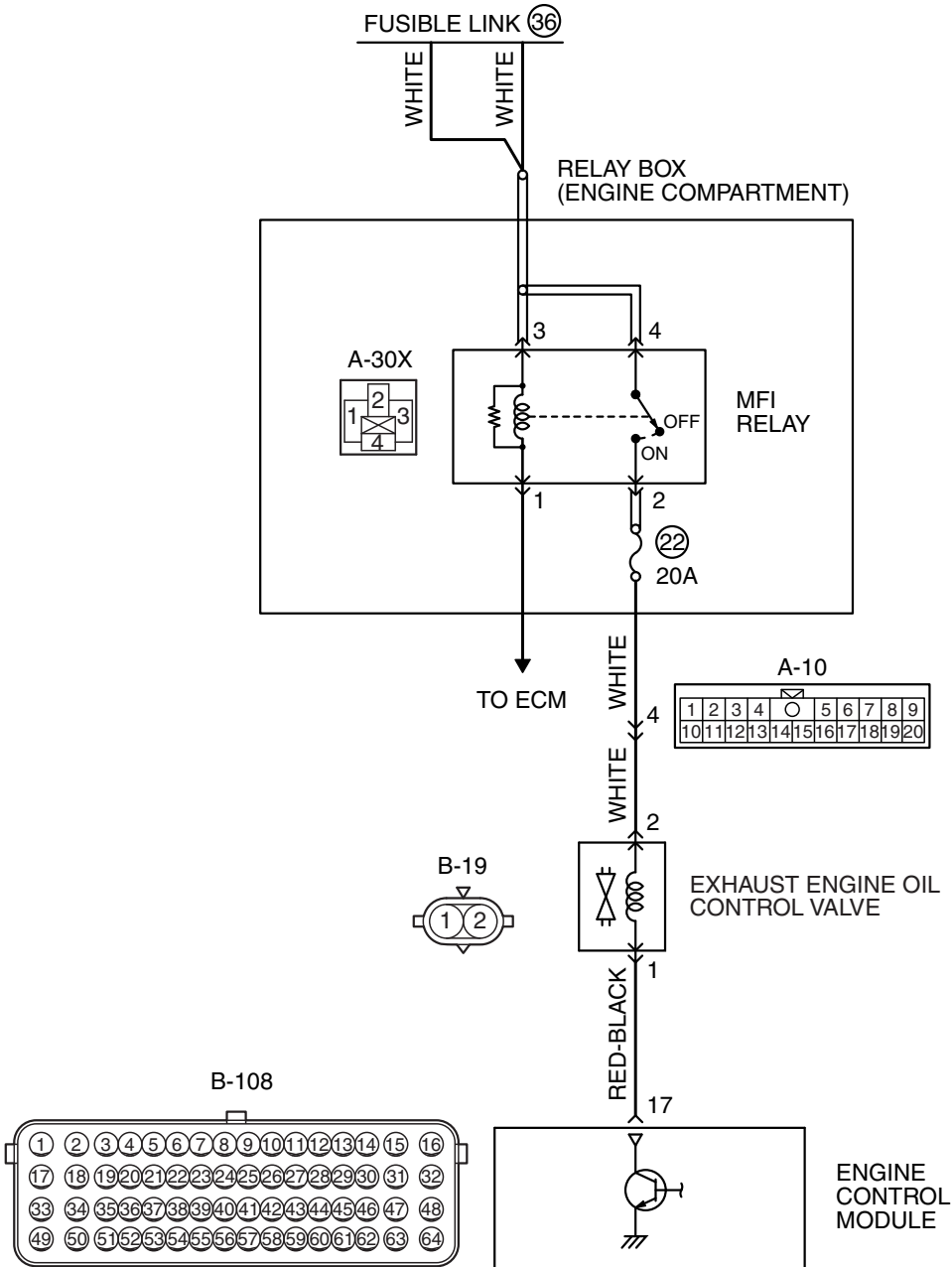

AK704780AC

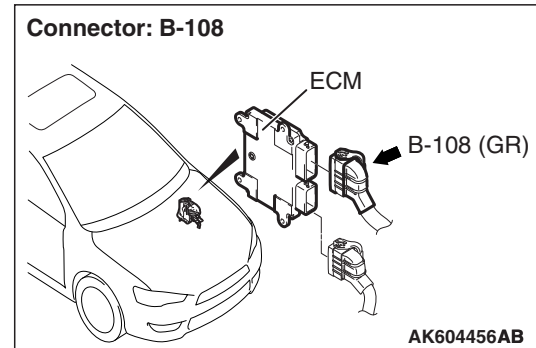
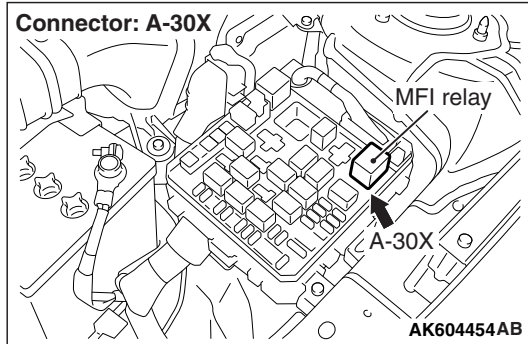
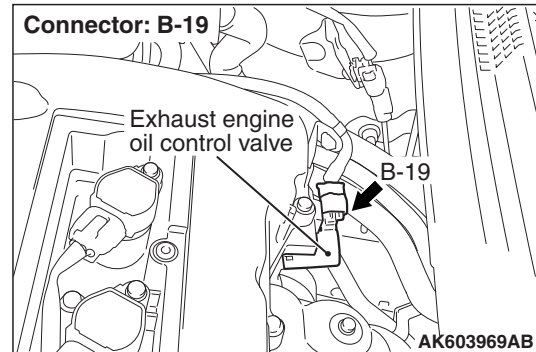
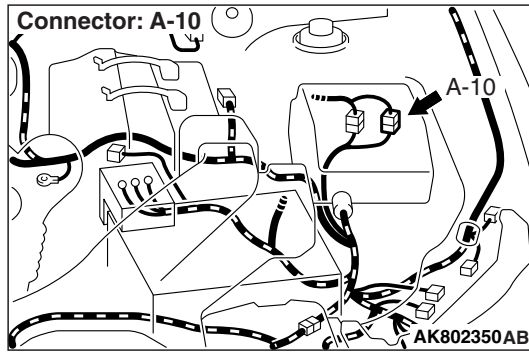

## CIRCUIT OPERATION

- The exhaust engine oil control valve power is supplied from the MFI relay (terminal No. 2).
- The ECM controls ground exhaust engine oil control valve by turning the power transistor in the ECM "ON" and "OFF".

## TECHNICAL DESCRIPTION

- The exhaust engine oil control valve changes the phase angle to operate the MIVEC system in the advance or the retard side in accordance with signals from the ECM.

## DESCRIPTIONS OF MONITOR METHODS

Exhaust engine oil control valve circuit current is out of the specified range.

## MONITOR EXECUTION

Continuous

## MONITOR EXECUTION CONDITIONS (Other monitor and Sensor)

**Other Monitor (There is no temporary DTC stored in memory for the item monitored below)**

- Not applicable

**Sensor (The sensor below is determined to be normal)**

- Camshaft position sensor
- Crankshaft position sensor
- Engine coolant temperature sensor
- Throttle position sensor
- Engine oil control valve

## DTC SET CONDITIONS

## Logic Flow Chart

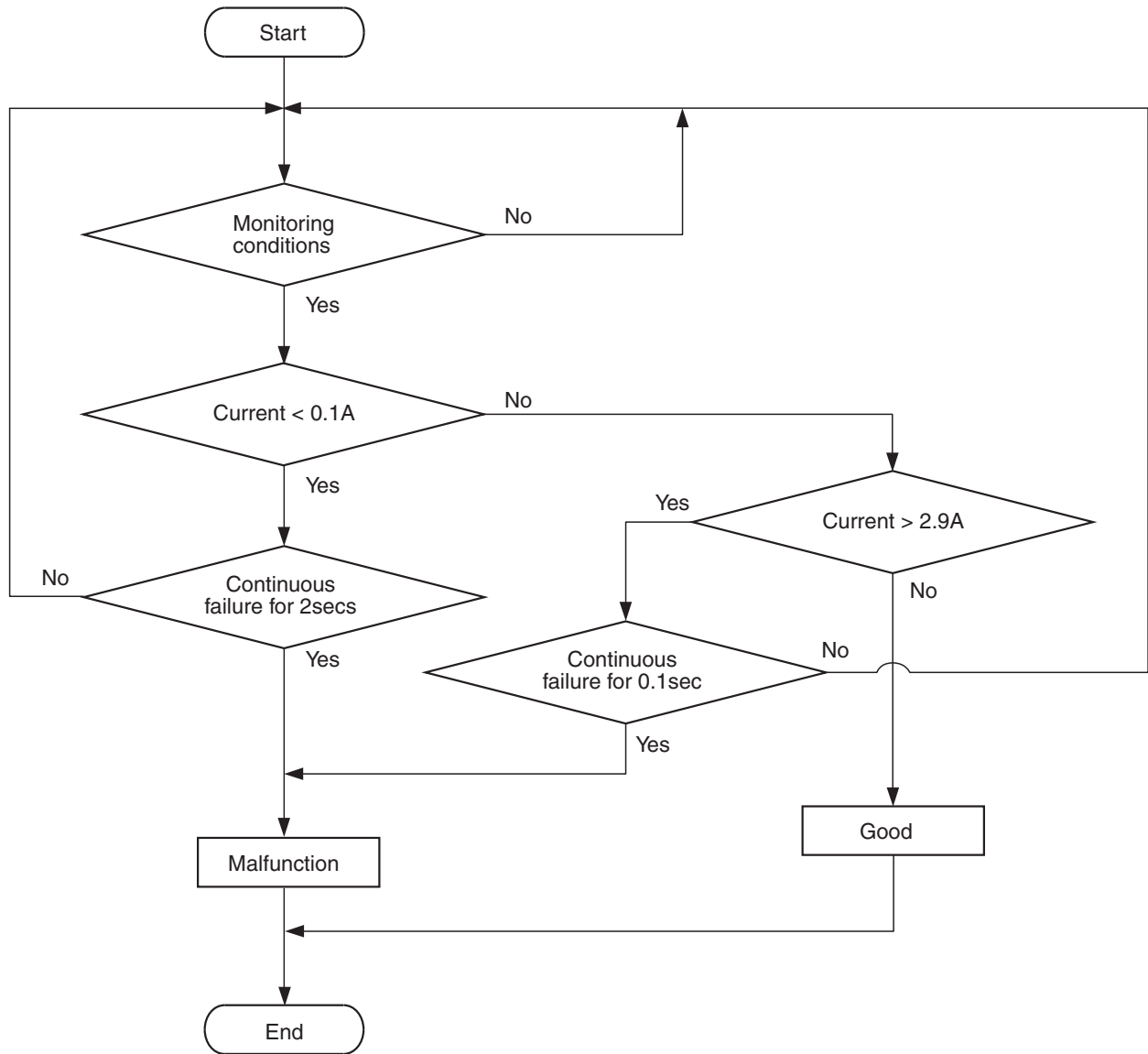

AK704777

**Check Conditions**

- Ignition switch is "ON" position.
- Battery positive voltage is between 10 and 16.5 volts.
- ON duty cycle of the exhaust engine oil control valve circuit is more than 20 percent.

**Judgement Criterion**

- The ECM terminal current of exhaust engine oil control valve circuit is less than 0.1 ampere for 2 seconds.

- Battery positive voltage is between 10 and 16.5 volts.

**Judgement Criterion**

- The ECM terminal current of exhaust engine oil control valve circuit is more than 2.9 amperes for 0.1 second.

**FAIL-SAFE AND BACKUP FUNCTION**

- V.V.T. phase angle (exhaust) becomes most advanced angle.

**Check Conditions**

- Ignition switch is "ON" position.



## OBD-II DRIVE CYCLE PATTERN

Refer to Diagnostic Function –OBD-II Drive Cycle –  
Pattern 20 P.13B-12.

## TROUBLESHOOTING HINTS (The most likely causes for this code to be set are:)

- Exhaust engine oil control valve failed.
- Open or shorted exhaust engine oil control valve circuit, or harness damage, or connector damage.
- ECM failed.

## DIAGNOSIS

### Required Special Tools:

- MB991958: Scan Tool (M.U.T.-III Sub Assembly)
  - MB991824: V.C.I.
  - MB991827: USB Cable
  - MB991910: Main Harness A
- MB992110: Power Plant ECU Check Harness

**STEP 1. Using scan tool MB991958, check actuator test item 17: Engine Oil Control Valve.**

### ⚠ CAUTION

To prevent damage to scan tool MB991958, always turn the ignition switch to the "LOCK" (OFF) position before connecting or disconnecting scan tool MB991958.

- (1) Connect scan tool MB991958 to the data link connector.
- (2) Turn the ignition switch to the "ON" position.
- (3) Set scan tool MB991958 to the actuator test mode for item 17, Engine Oil Control Valve.
  - An operation sound should be heard and vibration should be felt when the exhaust engine oil control valve is operated.
- (4) Turn the ignition switch to the "LOCK" (OFF) position.

### Q: Is the actuator operating properly?

**YES :** It can be assumed that this malfunction is intermittent. Refer to GROUP 00, How to Use Troubleshooting/Inspection Service Points –How to Cope with Intermittent Malfunctions P.00-13.

**NO :** Go to Step 2.

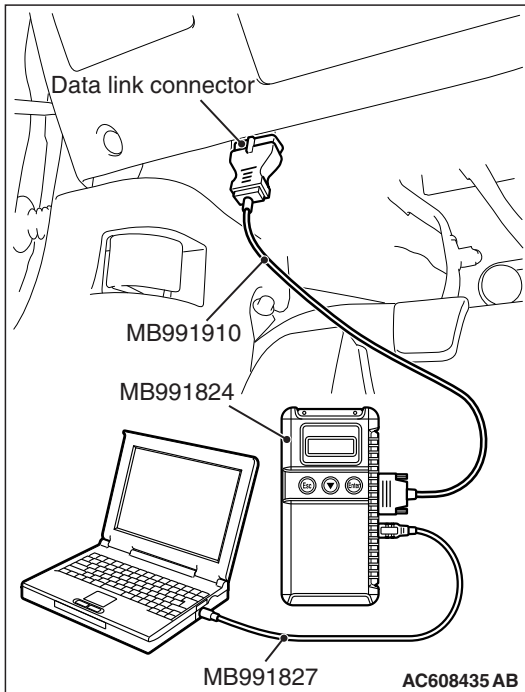

**STEP 2. Check harness connector B-19 at exhaust engine oil control valve for damage.**

### Q: Is the harness connector in good condition?

**YES :** Go to Step 3.

**NO :** Repair or replace it. Refer to GROUP 00E, Harness Connector Inspection P.00E-2. Then go to Step 12.

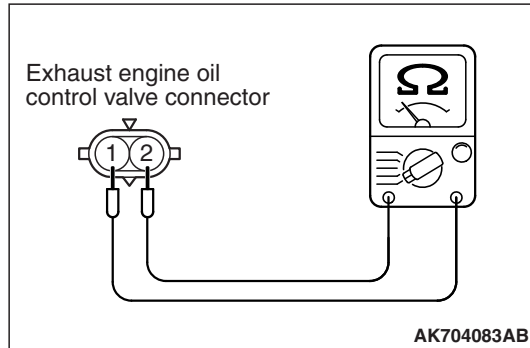
**STEP 3. Check the exhaust engine oil control valve.**

- (1) Disconnect the exhaust engine oil control valve connector B-19.
- (2) Measure the resistance between exhaust engine oil control valve side connector terminal No. 1 and No. 2.

**Standard value: 6.9 – 7.9  $\Omega$  [at 20° C (68° F)]**

**Q: Is the measured resistance between 6.9 and 7.9  $\Omega$  [at 20° C (68° F)]?**

**YES :** Go to Step 4.

**NO :** Replace the exhaust engine oil control valve. Then go to Step 12.

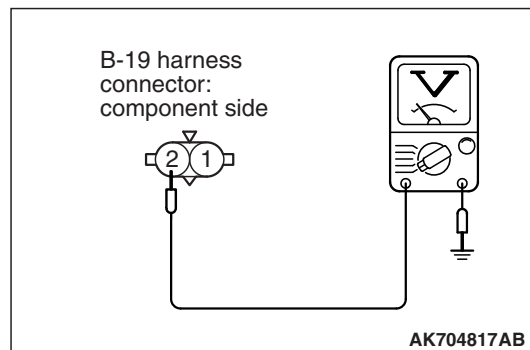
**STEP 4. Measure the power supply voltage at exhaust engine oil control valve harness side connector B-19.**

- (1) Disconnect the connector B-19 and measure at the harness side.
- (2) Turn the ignition switch to the "ON" position.
- (3) Measure the voltage between terminal No. 2 and ground.
  - Voltage should be battery positive voltage.
- (4) Turn the ignition switch to the "LOCK" (OFF) position.

**Q: Is battery positive voltage (approximately 12 volts) present?**

**YES :** Go to Step 6.

**NO :** Go to Step 5.

**STEP 5. Check harness connector A-30X at MFI relay for damage.**

**Q: Is the harness connector in good condition?**

**YES :** Check harness connector A-10 at intermediate connector for damage, and repair or replace as required. Refer to GROUP 00E, Harness Connector Inspection [P.00E-2](#). If intermediate connector is in good condition, repair harness wire between MFI relay connector A-30X (terminal No. 2) and exhaust engine oil control valve connector B-19 (terminal No. 2) because of open circuit or short circuit to ground. Then go to Step 12.

**NO :** Repair or replace it. Refer to GROUP 00E, Harness Connector Inspection [P.00E-2](#). Then go to Step 12.

**STEP 6. Check harness connector B-108 at ECM for damage.**

**Q: Is the harness connector in good condition?**

**YES :** Go to Step 7.

**NO :** Repair or replace it. Refer to GROUP 00E, Harness Connector Inspection [P.00E-2](#). Then go to Step 12.

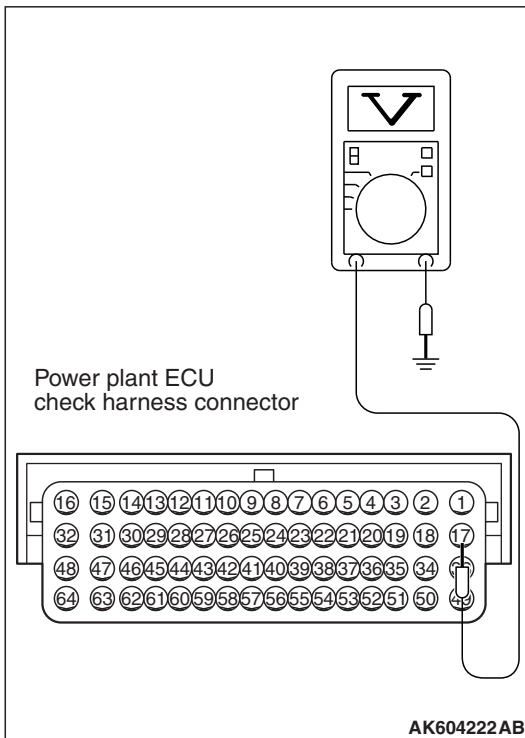
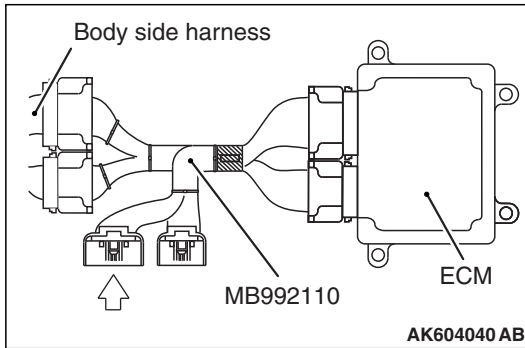

**STEP 7. Measure the power supply voltage at ECM connector B-108 by using power plant ECU check harness special tool MB992110.**

(1) Disconnect all ECM connectors. Connect the power plant ECU check harness special tool MB992110 between the separated connectors.

(2) Turn the ignition switch to the "ON" position.

(3) Measure the voltage between terminal No. 17 and ground.

- Voltage should be battery positive voltage.

(4) Turn the ignition switch to the "LOCK" (OFF) position.

**Q: Is battery positive voltage (approximately 12 volts) present?**

**YES :** Go to Step 8.

**NO :** Repair harness wire between exhaust engine oil control valve connector B-19 (terminal No. 1) and ECM connector B-108 (terminal No. 17) because of open circuit or short circuit to ground. Then go to Step 12.

**STEP 8. Check harness connector A-30X at MFI relay for damage.**

**Q: Is the harness connector in good condition?**

**YES :** Go to Step 9.

**NO :** Repair or replace it. Refer to GROUP 00E, Harness Connector Inspection [P.00E-2](#). Then go to Step 12.

**STEP 9. Check for harness damage between MFI relay connector A-30X (terminal No. 2) and exhaust engine oil control valve connector B-19 (terminal No. 2).**

*NOTE: Check harness after checking intermediate connector A-10. If intermediate connector is damaged, repair or replace it. Refer to GROUP 00E, Harness Connector Inspection P.00E-2. Then go to Step 12.*

**Q: Is the harness wire in good condition?**

**YES :** Go to Step 10.

**NO :** Repair it. Then go to Step 12.

---

**STEP 10. Check for harness damage between exhaust engine oil control valve connector B-19 (terminal No. 1) and ECM connector B-108 (terminal No. 17).**

**Q: Is the harness wire in good condition?**

**YES :** Go to Step 11.

**NO :** Repair it. Then go to Step 12.

---

**STEP 11. Using scan tool MB991958, check actuator test item 17: Engine Oil Control Valve.**

(1) Turn the ignition switch to the "ON" position.

(2) Set scan tool MB991958 to the actuator test mode for item 17, Engine Oil Control Valve.

- An operation sound should be heard and vibration should be felt when the exhaust engine oil control valve is operated.

(3) Turn the ignition switch to the "LOCK" (OFF) position.

**Q: Is the actuator operating properly?**

**YES :** It can be assumed that this malfunction is intermittent. Refer to GROUP 00, How to Use Troubleshooting/Inspection Service Points –How to Cope with Intermittent Malfunctions P.00-13.

**NO :** Replace the ECM (Refer to, Removal and Installation P.13B-1022). Then go to Step 12.

---

**STEP 12. Test the OBD-II drive cycle.**

(1) Carry out test drive with the drive cycle pattern. Refer to Diagnostic Function –OBD-II Drive Cycle –Pattern 20 P.13B-12.

(2) Check the diagnostic trouble code (DTC).

**Q: Is DTC P0013 set?**

**YES :** Retry the troubleshooting.

**NO :** The inspection is complete.

---

**DTC P0014: Exhaust Variable Valve Timing System Target Error**

---

**TECHNICAL DESCRIPTION**

- The ECM checks the variable valve timing system for malfunction.

**DESCRIPTIONS OF MONITOR METHODS**

The difference between the actual exhaust valve closing timing and the exhaust valve target closing timing is over the specified value.

**MONITOR EXECUTION**

Continuous

**MONITOR EXECUTION CONDITIONS  
(Other monitor and Sensor)**

**Other Monitor (There is no temporary DTC stored in memory for the item monitored below)**

- Not applicable

**Sensor (The sensor below is determined to be normal)**

- Camshaft position sensor
- Crankshaft position sensor
- Engine coolant temperature sensor
- Throttle position sensor
- Engine oil control valve

## DTC SET CONDITIONS

## Logic Flow Chart

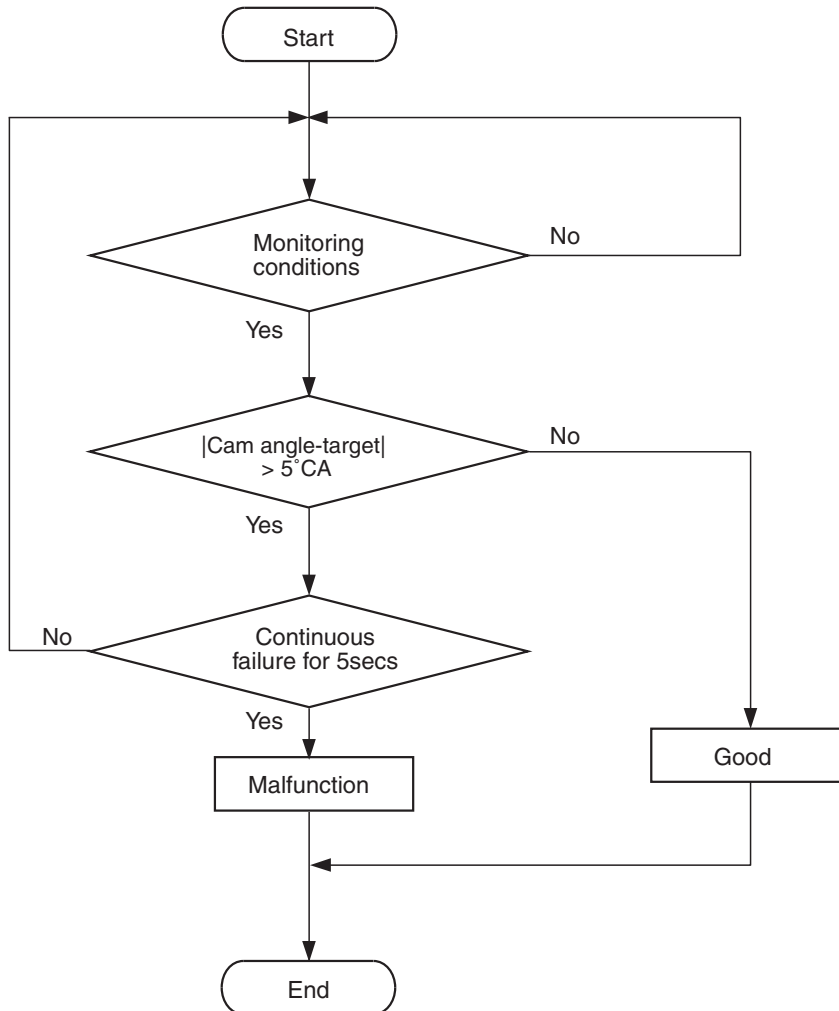

Cam angle: Intake valve open timing (intake side)  
Exhaust valve close timing (exhaust side)

AK704222

**Check Conditions**

- More than 20 seconds have passed since the engine starting sequence was completed.
- Engine speed is more than 1,188 r/min.
- Engine coolant temperature is more than 76° C (169° F).

**Judgment Criterion**

- The difference between the actual exhaust valve closing timing and the exhaust valve target closing timing is more than 5 degrees for 5 seconds.

**FAIL-SAFE AND BACKUP FUNCTION**

- None

**OBD-II DRIVE CYCLE PATTERN**

Refer to Diagnostic Function –OBD-II Drive Cycle – Pattern 20 [P.13B-12](#).

**TROUBLESHOOTING HINTS (The most likely causes for this code to be set are:)**

- Exhaust engine oil control valve failed.
- Oil passage of variable valve timing control system clogged.
- Exhaust variable valve timing sprocket operation mechanism stuck.
- ECM failed.

## DIAGNOSIS

### Required Special Tool:

- MB991958: Scan Tool (M.U.T.-III Sub Assembly)
  - MB991824: V.C.I.
  - MB991827: USB Cable
  - MB991910: Main Harness A

**STEP 1. Using scan tool MB991958, read the diagnostic trouble code (DTC).**

### **⚠ CAUTION**

To prevent damage to scan tool MB991958, always turn the ignition switch to the "LOCK" (OFF) position before connecting or disconnecting scan tool MB991958.

- (1) Connect scan tool MB991958 to the data link connector.
- (2) Turn the ignition switch to the "ON" position.
- (3) Set scan tool MB991958, read the DTC.
- (4) Turn the ignition switch to the "LOCK" (OFF) position.

**Q: Is the diagnostic trouble code other than P0014 set?**

- YES** : Refer to, Diagnostic Trouble Code Chart [P.13B-51](#).  
**NO** : Go to Step 2.

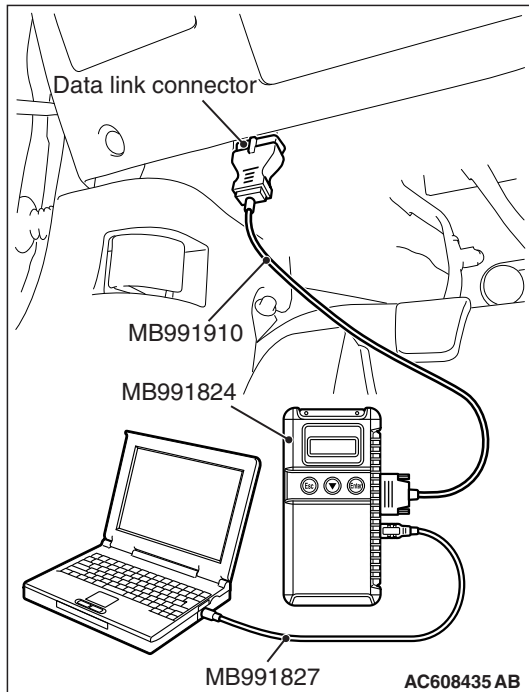

**STEP 2. Check the exhaust engine oil control valve.**

- Refer to, Engine Oil Control Valve Check [P.13B-1012](#).

**Q: Is the check result normal?**

- YES** : Go to Step 3.  
**NO** : Replace the exhaust engine oil control valve. Then go to Step 6.

**STEP 3. Check exhaust variable valve timing sprocket operation mechanism for being stuck.**

Refer to GROUP 11D, Timing Chain –Inspection [P.11D-37](#).

**Q: Is the check result normal?**

- YES** : Go to Step 4.  
**NO** : Repair it. Then go to Step 6.

**STEP 4. Check oil passage of exhaust variable valve timing control system for being clogged.**

**Q: Is the check result normal?**

- YES** : Go to Step 5.  
**NO** : Repair it. Then go to Step 6.

**STEP 5. Check the trouble symptoms.**

- (1) Carry out test drive with the drive cycle pattern. Refer to Diagnostic Function –OBD-II Drive Cycle –Pattern 20 [P.13B-12](#).
- (2) Check the diagnostic trouble code (DTC).

**Q: Is DTC P0014 set?**

**YES :** Replace the ECM (Refer to, Removal and Installation [P.13B-1022](#)). Then go to Step 6.

**NO :** It can be assumed that this malfunction is intermittent. Refer to GROUP 00, How to Use Troubleshooting/Inspection Service Points –How to Cope with Intermittent Malfunctions [P.00-13](#).

**STEP 6. Test the OBD-II drive cycle.**

- (1) Carry out a test drive with the drive cycle pattern. Refer to Diagnostic Function –OBD-II Drive Cycle –Pattern 20 [P.13B-12](#).
- (2) Check the diagnostic trouble code (DTC).

**Q: Is DTC P0014 set?**

**YES :** Retry the troubleshooting.

**NO :** The inspection is complete.

---

**DTC P0016: Crankshaft/camshaft (intake) Position Sensor Phase Problem**

---

**TECHNICAL DESCRIPTION**

- The ECM checks the variable valve timing system for malfunction.

**DESCRIPTIONS OF MONITOR METHODS**

The open timing of the intake valve is faster or slower than the specified value.

**MONITOR EXECUTION**

Continuous

**MONITOR EXECUTION CONDITIONS  
(Other monitor and Sensor)**

**Other Monitor (There is no temporary DTC stored in memory for the item monitored below)**

- Not applicable

**Sensor (The sensor below is determined to be normal)**

- Camshaft position sensor
- Crankshaft position sensor
- Engine coolant temperature sensor
- Throttle position sensor
- Engine oil control valve



DTC SET CONDITIONS

Logic Flow Chart

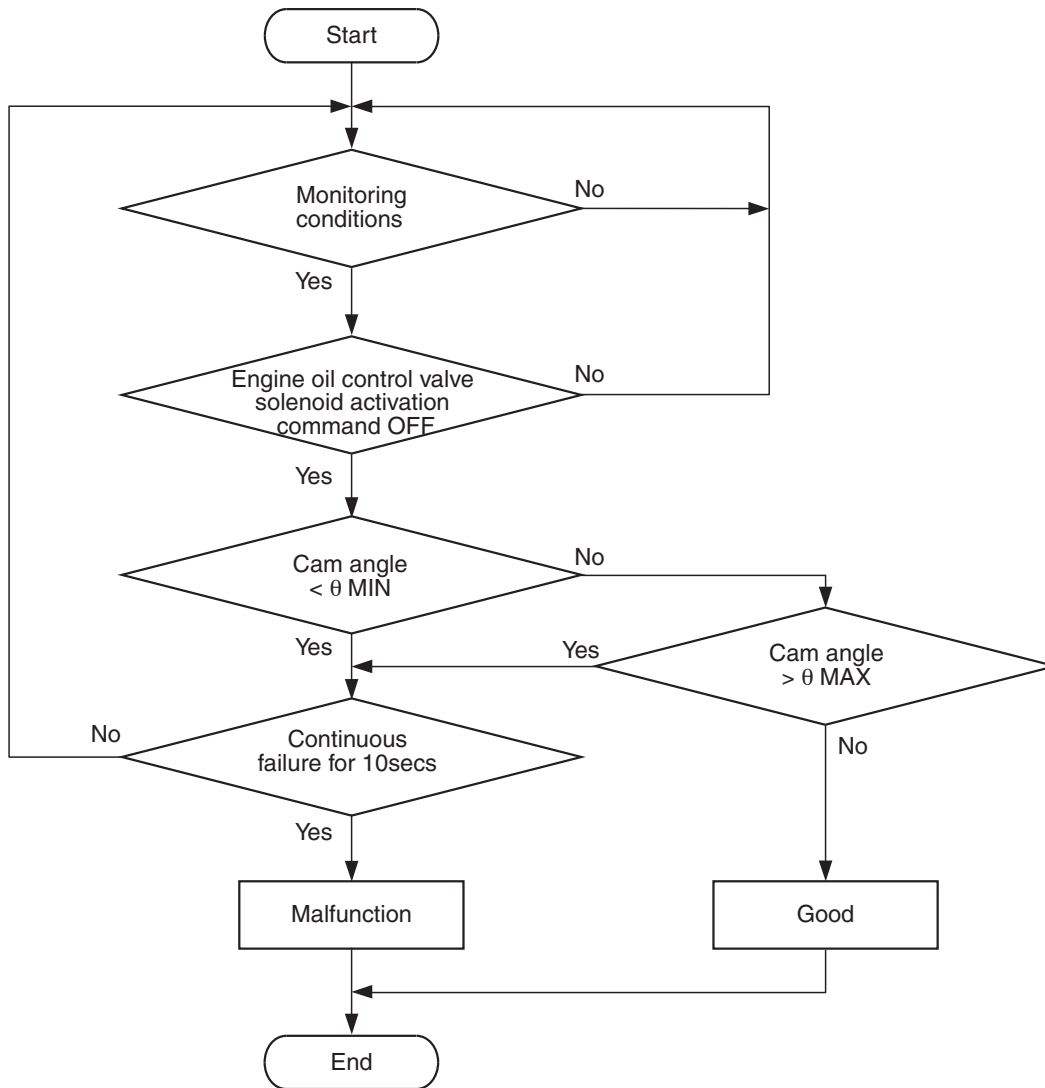

Cam angle: Intake valve open timing (intake side)  
Exhaust valve close timing (exhaust side)  
θ MAX : Maximum threshold value  
θ MIN : Minimum threshold value

AK900350

**Check Conditions**

- Engine speed is between 594 r/min and 1,500 r/min.
- Engine coolant temperature is between 20° C (68° F) and 88° C (190° F).
- Intake engine oil control valve is "OFF".
- 1 second has passed after the above mentions have been met.

**Judgment Criterion**

- The open timing of the intake valve is less than -7.0 degrees (ATDC) for 10 seconds.

or

- The open timing of the intake valve is more than 6.1 degrees (ATDC) for 10 seconds.

**FAIL-SAFE AND BACKUP FUNCTION**

- None

**OBD-II DRIVE CYCLE PATTERN**

Refer to Diagnostic Function –OBD-II Drive Cycle – Pattern 20 P.13B-12.

**TROUBLESHOOTING HINTS (The most likely causes for this code to be set are:)**

- Timing chain in out of place.
- Loose timing chain.
- Intake variable valve timing sprocket tooth coming off.
- ECM failed.

**DIAGNOSIS****Required Special Tool:**

- MB991958: Scan Tool (M.U.T.-III Sub Assembly)
  - MB991824: V.C.I.
  - MB991827: USB Cable
  - MB991910: Main Harness A

---

**STEP 1. Using the oscilloscope, measure output wave pattern at crankshaft position sensor and intake camshaft position sensor.**

**OK:** Wave pattern should be displayed on inspection procedure using an oscilloscope (Refer to [P.13B-978](#)), its maximum value should be 4.8 V or more, and its minimum value should be 0.6 V or less. There must be no noise in the output wave pattern.

**Q: Is the wave pattern normal?**

- YES :** Go to Step 2.  
**NO :** Go to Step 3.

---

**STEP 2. Check the trouble symptoms.**

- (1) Carry out a test drive with the drive cycle pattern. Refer to Diagnostic Function –OBD-II Drive Cycle –Pattern 20 [P.13B-12](#).
- (2) Check the diagnostic trouble code (DTC).

**Q: Is DTC P0016 set?**

- YES :** Replace the ECM (Refer to, Removal and Installation [P.13B-1022](#)). Then go to Step 4.
- NO :** It can be assumed that this malfunction is intermittent. Refer to GROUP 00, How to Use Troubleshooting/ Inspection Service Points –How to Cope with Intermittent Malfunctions [P.00-13](#).

---

**STEP 3. Check timing mark on the timing chain.****Q: Is timing chain in out of place?**

- YES :** Repair it. Then go to Step 4.
- NO :** Check the following items, and repair or replace the defective items.
- a. Check the timing chain loose.
  - b. Check the intake variable valve timing sprocket tooth coming off.
- Then go to Step 4.

---

**STEP 4. Test the OBD-II drive cycle.**

- (1) Carry out a test drive with the drive cycle pattern. Refer to Diagnostic Function –OBD-II Drive Cycle –Pattern 20 P.13B-12.
- (2) Check the diagnostic trouble code (DTC).

**Q: Is DTC P0016 set?**

**YES :** Retry the troubleshooting.

**NO :** The inspection is complete.

---

**DTC P0017: Crankshaft/camshaft (exhaust) Position Sensor Phase Problem**

---

**TECHNICAL DESCRIPTION**

- The ECM checks the variable valve timing system for malfunction.

**DESCRIPTIONS OF MONITOR METHODS**

The close timing of the exhaust valve is faster or slower than the specified value.

**MONITOR EXECUTION**

Continuous

**MONITOR EXECUTION CONDITIONS  
(Other monitor and Sensor)**

**Other Monitor (There is no temporary DTC stored in memory for the item monitored below)**

- Not applicable

**Sensor (The sensor below is determined to be normal)**

- Camshaft position sensor
- Crankshaft position sensor
- Engine coolant temperature sensor
- Throttle position sensor
- Engine oil control valve

## DTC SET CONDITIONS

## Logic Flow Chart

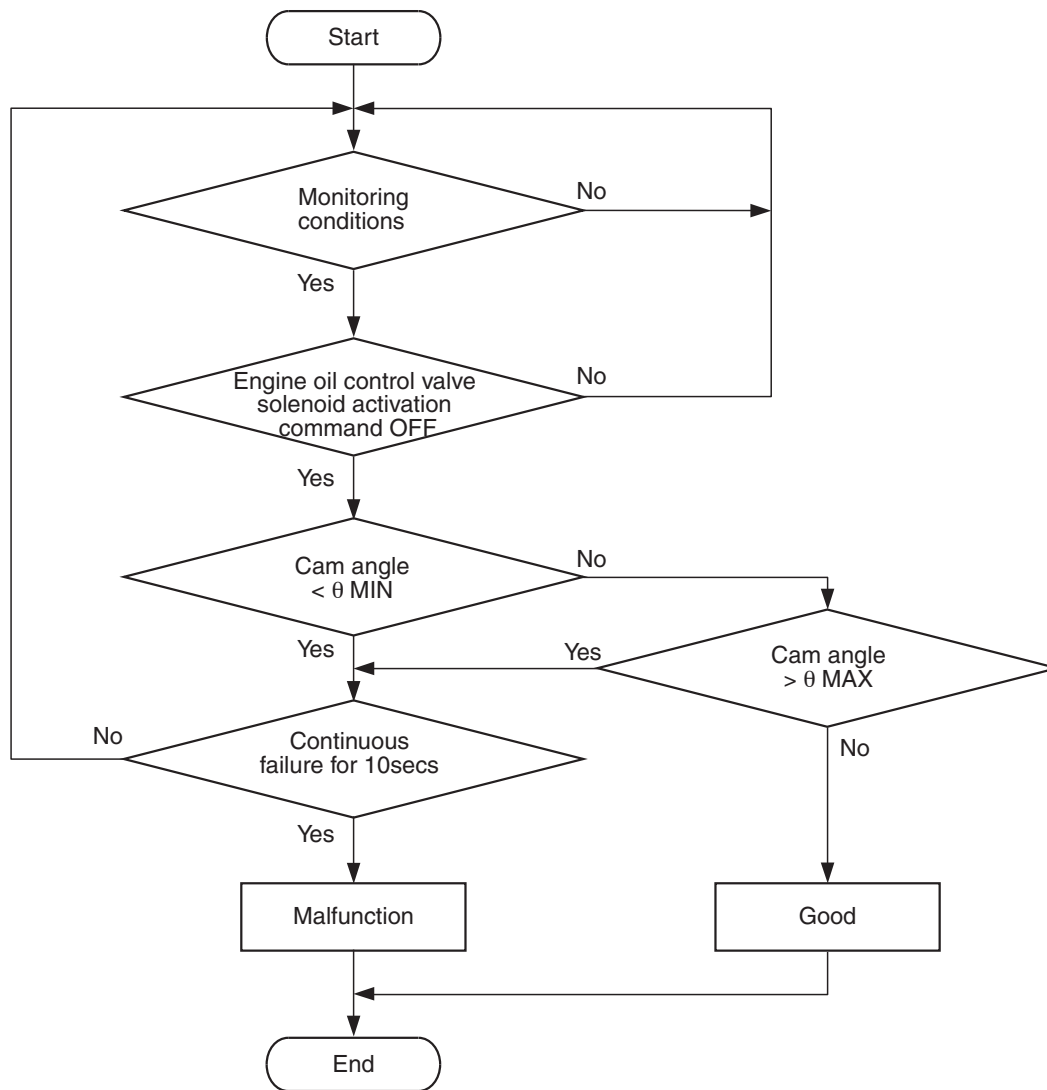

Cam angle: Intake valve open timing (intake side)  
Exhaust valve close timing (exhaust side)  
 $\theta$  MAX : Maximum threshold value  
 $\theta$  MIN : Minimum threshold value

AK900350

**Check Conditions**

- Engine speed is between 594 r/min and 1,500 r/min.
- Engine coolant temperature is between 20° C (68° F) and 88° C (190° F).
- Exhaust engine oil control valve is "OFF".
- 1 second has passed after the above mentions have been met.

**Judgment Criterion**

- The close timing of the exhaust valve is less than -7.7 degrees (ATDC) for 10 seconds.

or

- The close timing of the exhaust valve is more than 5.4 degrees (ATDC) for 10 seconds.

**FAIL-SAFE AND BACKUP FUNCTION**

- None

**OBD-II DRIVE CYCLE PATTERN**

Refer to Diagnostic Function –OBD-II Drive Cycle – Pattern 20 [P.13B-12](#).

**TROUBLESHOOTING HINTS (The most likely causes for this code to be set are:)**

- Timing chain in out of place.

- Loose timing chain.
- Exhaust variable valve timing sprocket tooth coming off.
- ECM failed.

**DIAGNOSIS**

**Required Special Tool:**

- MB991958: Scan Tool (M.U.T.-III Sub Assembly)
  - MB991824: V.C.I.
  - MB991827: USB Cable
  - MB991910: Main Harness A

---

**STEP 1. Using the oscilloscope, measure output wave pattern at crankshaft position sensor and exhaust camshaft position sensor.**

**OK:** Wave pattern should be displayed on inspection procedure using an oscilloscope (Refer to [P.13B-978](#)), its maximum value should be 4.8 V or more, and its minimum value should be 0.6 V or less. There must be no noise in the output wave pattern.

**Q: Is the wave pattern normal?**

**YES :** Go to Step 2.

**NO :** Go to Step 3.

---

**STEP 2. Check the trouble symptoms.**

(1) Carry out a test drive with the drive cycle pattern. Refer to Diagnostic Function –OBD-II Drive Cycle –Pattern 20 [P.13B-12](#).

(2) Check the diagnostic trouble code (DTC).

**Q: Is DTC P0017 set?**

**YES :** Replace the ECM (Refer to, Removal and Installation [P.13B-1022](#)). Then go to Step 4.

**NO :** It can be assumed that this malfunction is intermittent. Refer to GROUP 00, How to Use Troubleshooting/ Inspection Service Points –How to Cope with Intermittent Malfunctions [P.00-13](#).

---

**STEP 3. Check timing mark on the timing chain.****Q: Is timing chain in out of place?****YES** : Repair it. Then go to Step 4.**NO** : Check the following items, and repair or replace the defective items.

- a. Check the timing chain loose.
- b. Check the exhaust variable valve timing sprocket tooth coming off.

Then go to Step 4.

---

**STEP 4. Test the OBD-II drive cycle.**

(1) Carry out a test drive with the drive cycle pattern. Refer to Diagnostic Function –OBD-II Drive Cycle –Pattern 20 [P.13B-12](#).

(2) Check the diagnostic trouble code (DTC).

**Q: Is DTC P0017 set?****YES** : Retry the troubleshooting.**NO** : The inspection is complete.

DTC P0031: Heated Oxygen Sensor (front) Heater Control Circuit Low <Except vehicles for California>

HEATED OXYGEN SENSOR (FRONT) HEATER CIRCUIT <EXCEPT VEHICLES FOR CALIFORNIA>

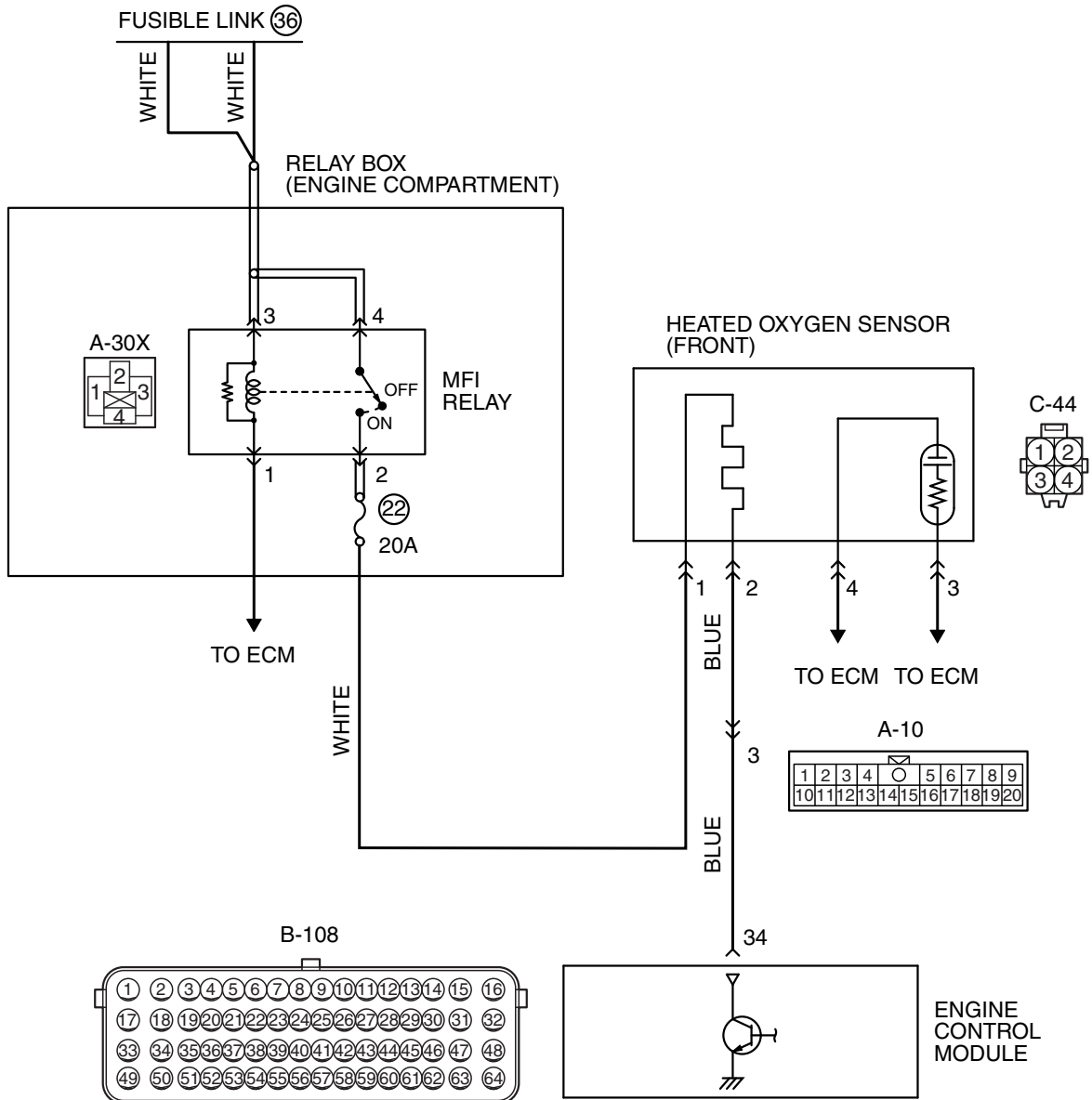

AK802010 AB

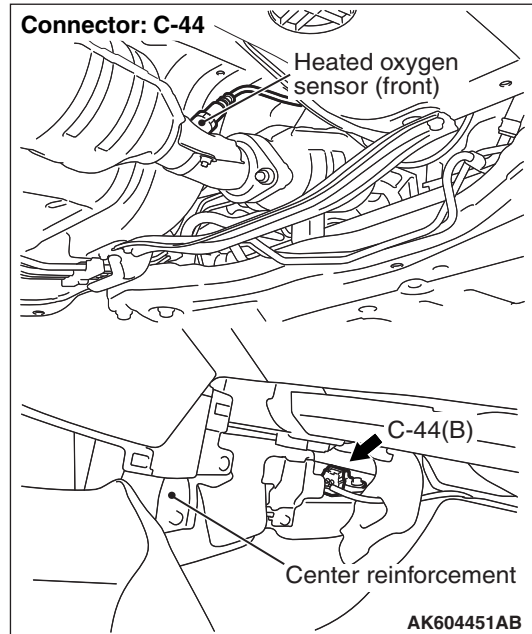
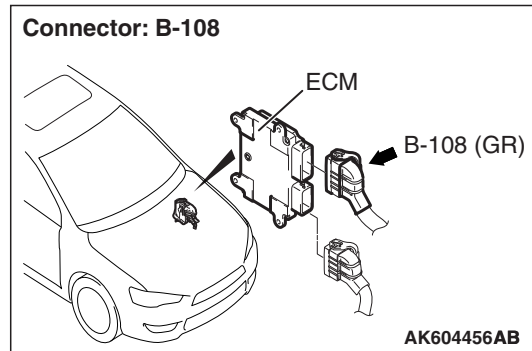
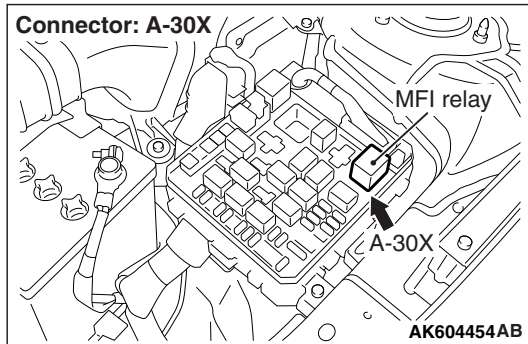
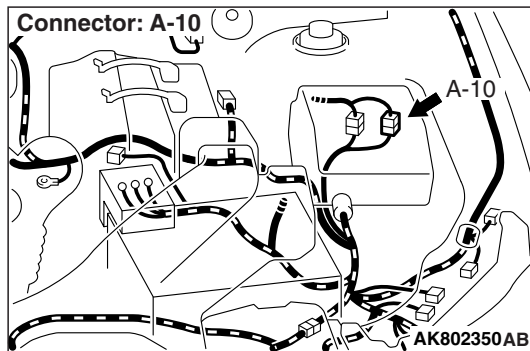

## CIRCUIT OPERATION

- Power is supplied from the MFI relay (terminal No. 2) to the heated oxygen sensor (front) heater.
- The ECM (terminal No. 34) controls continuity to the heated oxygen sensor (front) heater by turning the power transistor in the ECM "ON" and "OFF".

## TECHNICAL DESCRIPTION

- The ECM checks whether the heater current is within a specified range when the heater is energized.
- The ECM checks whether the heater voltage is within a specified range when the heater is not energized.

## DESCRIPTIONS OF MONITOR METHODS

Heated oxygen sensor (front) heater current or voltage is out of specified range.

## MONITOR EXECUTION

Continuous

## MONITOR EXECUTION CONDITIONS (Other monitor and Sensor)

**Other Monitor (There is no temporary DTC stored in memory for the item monitored below)**

- Not applicable

**Sensor (The sensor below is determined to be normal)**

- Not applicable



**DTC SET CONDITIONS**

**Logic Flow Chart**

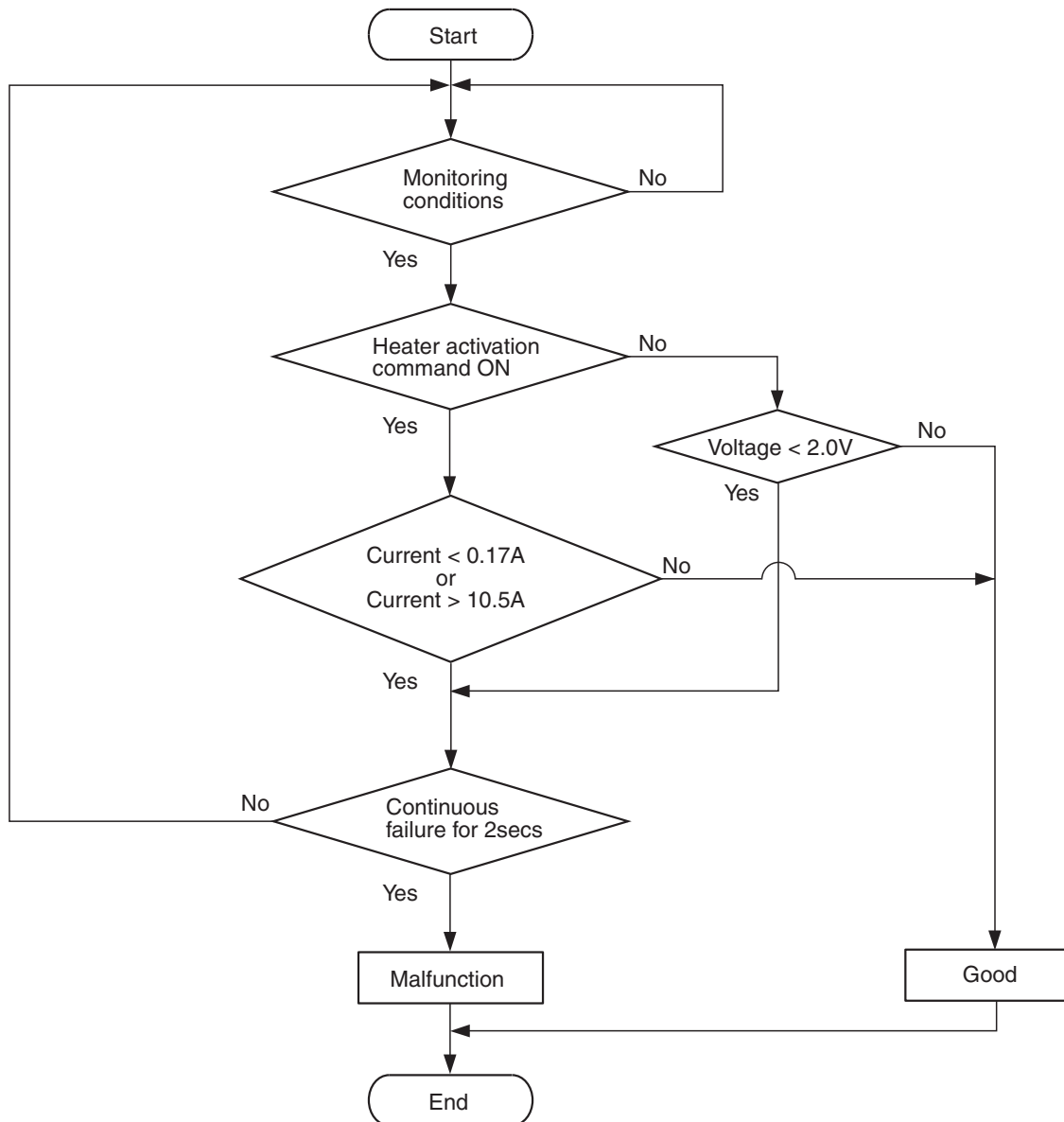

AK900352

**Check Conditions**

- More than 2 seconds have passed since the engine starting sequence was completed.
- While the heated oxygen sensor (front) heater is on.
- Battery positive voltage is between 11 and 16.5 volts.

**Judgement Criterion**

- The heated oxygen sensor (front) heater current is less than 0.17 ampere for 2 seconds.

**Check Conditions**

- More than 2 seconds have passed since the engine starting sequence was completed.

- While the heated oxygen sensor (front) heater is off.
- Battery positive voltage is between 11 and 16.5 volts.

**Judgement Criterion**

- The heated oxygen sensor (front) heater voltage is less than 2.0 volts for 2 seconds.

**FAIL-SAFE AND BACKUP FUNCTION**

- None

**OBD-II DRIVE CYCLE PATTERN**

Refer to Diagnostic Function –OBD-II Drive Cycle –  
Pattern 2 [P.13B-12](#).

**TROUBLESHOOTING HINTS (The most likely causes for this code to be set are:)**

- Open or shorted heated oxygen sensor (front) heater circuit, harness damage or connector damage.
- Heated oxygen sensor (front) heater failed.
- ECM failed.

**DIAGNOSIS****Required Special Tools:**

- MB991958: Scan Tool (M.U.T-III Sub Assembly)
  - MB991824: V.C.I.
  - MB991827: USB Cable
  - MB991910: Main Harness A
- MB991658: Test Harness
- MB992110: Power Plant ECU Check Harness

**STEP 1. Check harness connector C-44 at heated oxygen sensor (front) for damage.****Q: Is the harness connector in good condition?**

**YES** : Go to Step 2.

**NO** : Repair or replace it. Refer to GROUP 00E, Harness Connector Inspection [P.00E-2](#). Then go to Step 11.

**STEP 2. Check the heated oxygen sensor (front).**

- (1) Disconnect heated oxygen sensor (front) connector C-44 and connect test harness special tool, MB991658, to the connector on the heated oxygen sensor (front) side.
- (2) Measure the resistance between heated oxygen sensor connector terminal No. 1 and terminal No. 2.

**Standard value: 4.5 –8.0  $\Omega$  [at 20° C (68° F)]**

**Q: Is the measured resistance between 4.5 and 8.0  $\Omega$  [at 20° C (68° F)]?**

**YES** : Go to Step 3.

**NO** : Replace the heated oxygen sensor (front). Then go to Step 11.

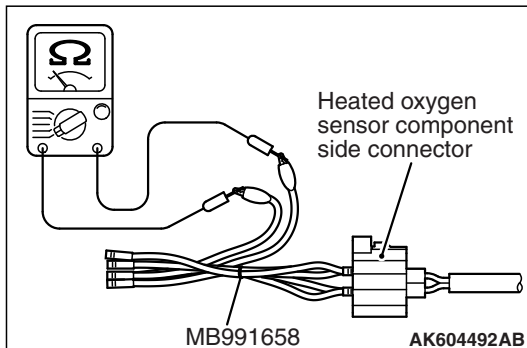

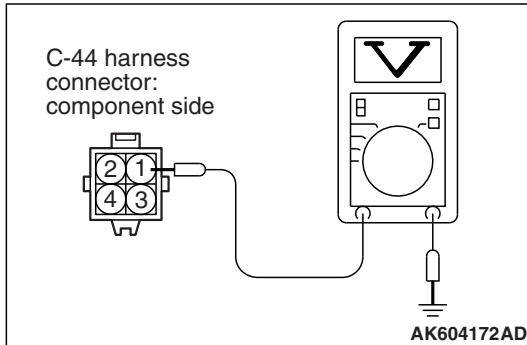

**STEP 3. Measure the power supply voltage at heated oxygen sensor (front) harness side connector C-44.**

- (1) Disconnect the connector C-44 and measure at the harness side.
- (2) Turn the ignition switch to the "ON" position.
- (3) Measure the voltage between terminal No. 1 and ground.
  - Voltage should be battery positive voltage.
- (4) Turn the ignition switch to the "LOCK" (OFF) position.

**Q: Is battery positive voltage (approximately 12 volts) present?**

**YES :** Go to Step 5.

**NO :** Go to Step 4.

**STEP 4. Check harness connector A-30X at MFI relay for damage.**

**Q: Is the harness connector in good condition?**

**YES :** Repair harness wire between MFI relay connector A-30X (terminal No. 2) and heated oxygen sensor (front) connector C-44 (terminal No. 1) because of open circuit or short circuit to ground. Then go to Step 11.

**NO :** Repair or replace it. Refer to GROUP 00E, Harness Connector Inspection [P.00E-2](#). Then go to Step 11.

**STEP 5. Check harness connector B-108 at ECM for damage.**

**Q: Is the harness connector in good condition?**

**YES :** Go to Step 6.

**NO :** Repair or replace it. Refer to GROUP 00E, Harness Connector Inspection [P.00E-2](#). Then go to Step 11.

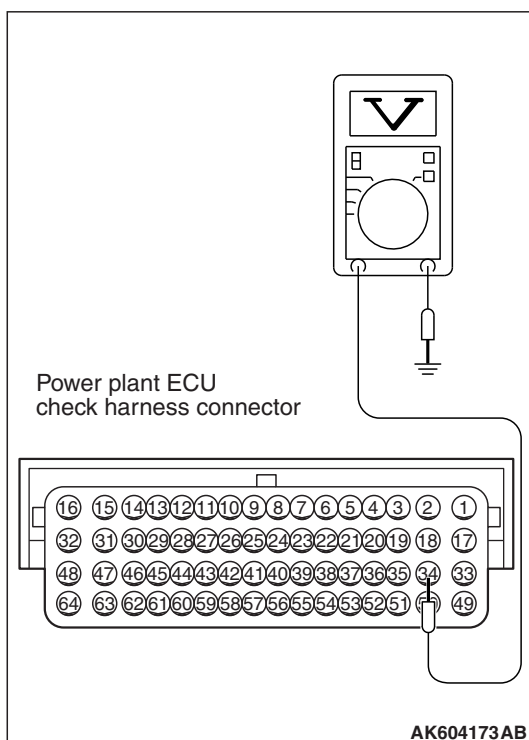
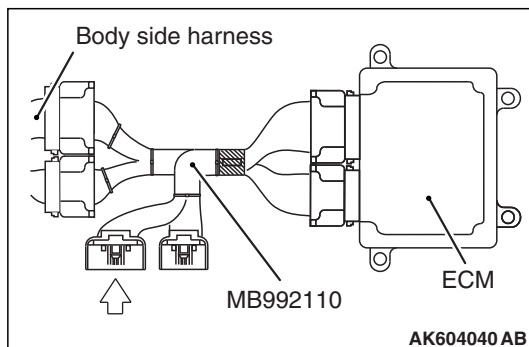

**STEP 6. Measure the power supply voltage at ECM connector B-108 by using power plant ECU check harness special tool MB992110.**

- (1) Disconnect all ECM connectors. Connect the power plant ECU check harness special tool MB992110 between the separated connectors.
- (2) Turn the ignition switch to the "ON" position.

- (3) Measure the voltage between terminal No. 34 and ground.
  - Voltage should be battery positive voltage.
- (4) Turn the ignition switch to the "LOCK" (OFF) position.

**Q: Is battery positive voltage (approximately 12 volts) present?**

**YES :** Go to Step 7.

**NO :** Check harness connector A-10 at intermediate connector for damage, and repair or replace as required. Refer to GROUP 00E, Harness Connector Inspection P.00E-2. If intermediate connector is in good condition, repair harness wire between heated oxygen sensor (front) connector C-44 (terminal No. 2) and ECM connector B-108 (terminal No. 34) because of open circuit or short circuit to ground. Then go to Step 11.

**STEP 7. Check harness connector A-30X at MFI relay for damage.**

**Q: Is the harness connector in good condition?**

**YES :** Go to Step 8.

**NO :** Repair or replace it. Refer to GROUP 00E, Harness Connector Inspection P.00E-2. Then go to Step 11.

**STEP 8. Check for harness damage between MFI relay connector A-30X (terminal No. 2) and heated oxygen sensor (front) connector C-44 (terminal No. 1).**

**Q: Is the harness wire in good condition?**

**YES :** Go to Step 9.

**NO :** Repair it. Then go to Step 11.

---

**STEP 9. Check for harness damage between heated oxygen sensor (front) connector C-44 (terminal No. 2) and ECM connector B-108 (terminal No. 34).**

*NOTE: Check harness after checking intermediate connector A-10. If intermediate connector is damaged, repair or replace it. Refer to GROUP 00E, Harness Connector Inspection P.00E-2. Then go to Step 11.*

**Q: Is the harness wire in good condition?**

**YES :** Go to Step 10.

**NO :** Repair it. Then go to Step 11.

---

**STEP 10. Check the trouble symptoms.**

(1) Carry out a test drive with the drive cycle pattern. Refer to Diagnostic Function –OBD-II Drive Cycle –Pattern 2 P.13B-12.

(2) Check the diagnostic trouble code (DTC).

**Q: Is DTC P0031 set?**

**YES :** Replace the ECM (Refer to, Removal and Installation P.13B-1022). Then go to Step 11.

**NO :** It can be assumed that this malfunction is intermittent. Refer to GROUP 00, How to Use Troubleshooting/Inspection Service Points –How to Cope with Intermittent Malfunctions P.00-13.

---

**STEP 11. Test the OBD-II drive cycle.**

(1) Carry out a test drive with the drive cycle pattern. Refer to Diagnostic Function –OBD-II Drive Cycle –Pattern 2 P.13B-12.

(2) Check the diagnostic trouble code (DTC).

**Q: Is DTC P0031 set?**

**YES :** Retry the troubleshooting.

**NO :** The inspection is complete.



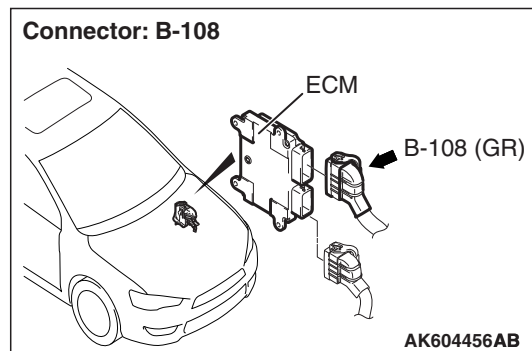
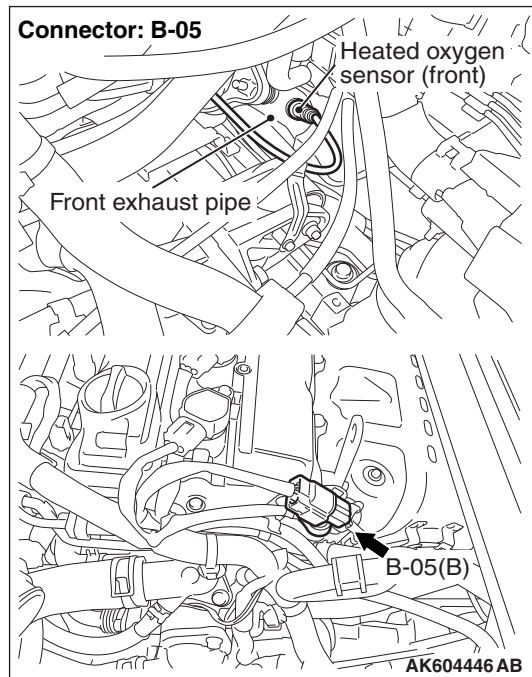
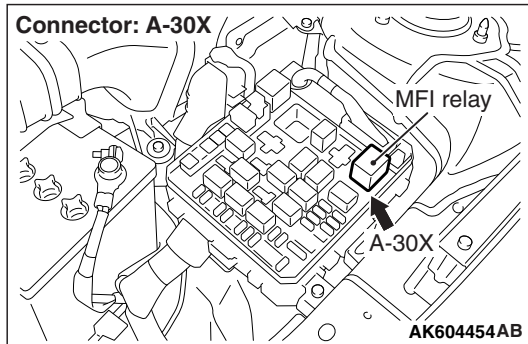
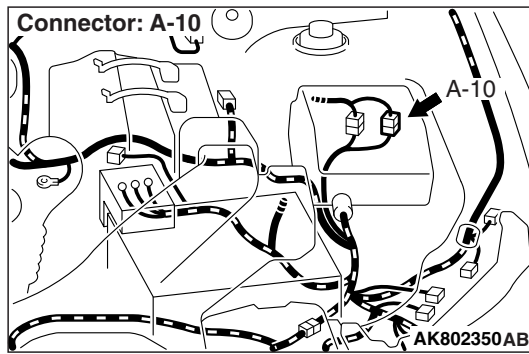

## CIRCUIT OPERATION

- Power is supplied from the MFI relay (terminal No. 2) to the heated oxygen sensor (front) heater.
- The ECM (terminal No. 34) controls continuity to the heated oxygen sensor (front) heater by turning the power transistor in the ECM "ON" and "OFF".

## TECHNICAL DESCRIPTION

- The ECM checks whether the heater current is within a specified range when the heater is energized.
- The ECM checks whether the heater voltage is within a specified range when the heater is not energized.

## DESCRIPTIONS OF MONITOR METHODS

Heated oxygen sensor (front) heater current or voltage is out of specified range.

## MONITOR EXECUTION

Continuous

## MONITOR EXECUTION CONDITIONS (Other monitor and Sensor)

**Other Monitor (There is no temporary DTC stored in memory for the item monitored below)**

- Not applicable

**Sensor (The sensor below is determined to be normal)**

- Not applicable

DTC SET CONDITIONS

Logic Flow Chart

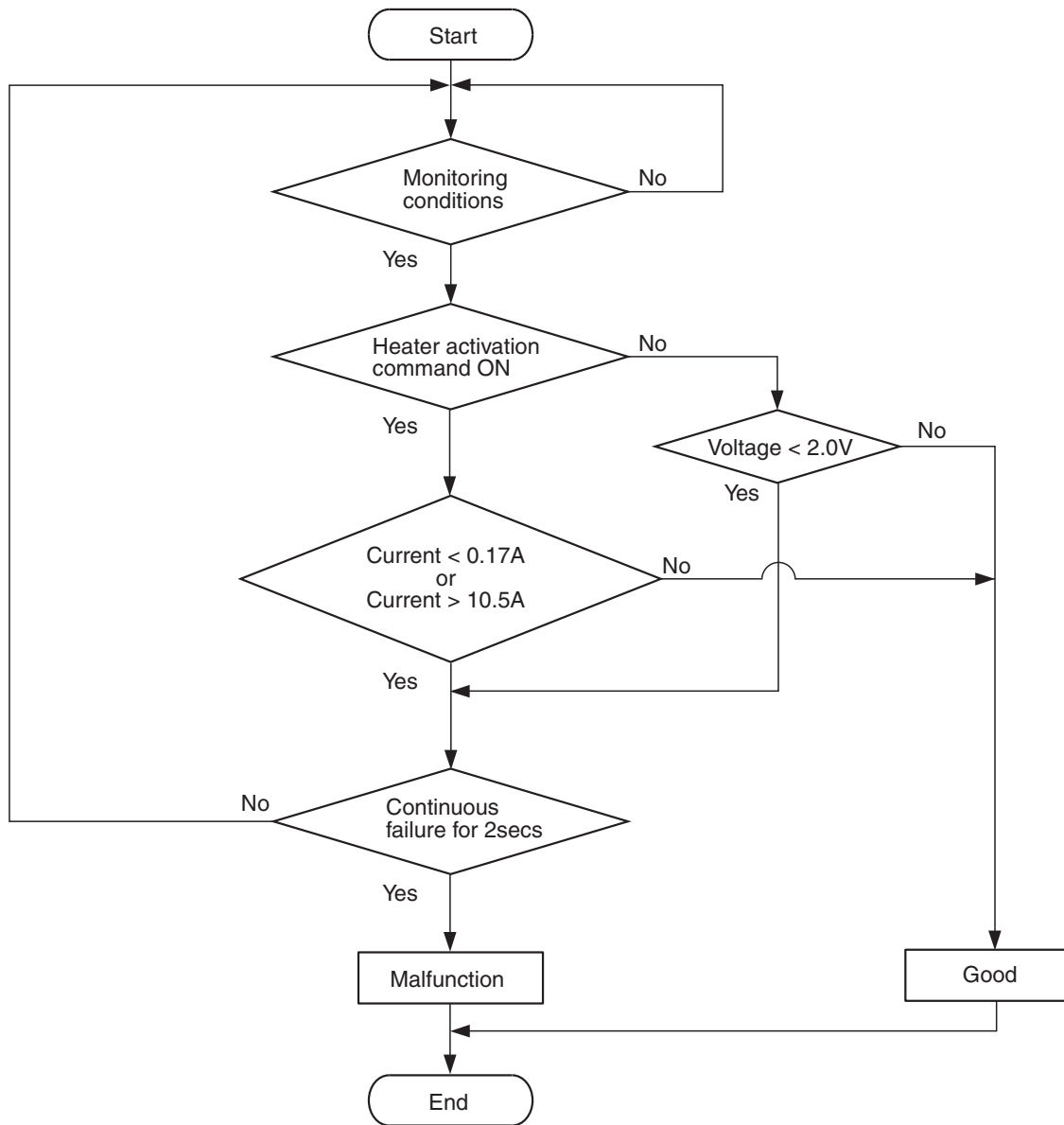

AK900352

**Check Conditions**

- More than 2 seconds have passed since the engine starting sequence was completed.
- While the heated oxygen sensor (front) heater is on.
- Battery positive voltage is between 11 and 16.5 volts.

**Judgement Criterion**

- The heated oxygen sensor (front) heater current is less than 0.17 ampere for 2 seconds.

**Check Conditions**

- More than 2 seconds have passed since the engine starting sequence was completed.

- While the heated oxygen sensor (front) heater is off.
- Battery positive voltage is between 11 and 16.5 volts.

**Judgement Criterion**

- The heated oxygen sensor (front) heater voltage is less than 2.0 volts for 2 seconds.

**FAIL-SAFE AND BACKUP FUNCTION**

- None



## OBD-II DRIVE CYCLE PATTERN

Refer to Diagnostic Function –OBD-II Drive Cycle –  
Pattern 2 [P.13B-12](#).

## TROUBLESHOOTING HINTS (The most likely causes for this code to be set are:)

- Open or shorted heated oxygen sensor (front) heater circuit, harness damage or connector damage.
- Heated oxygen sensor (front) heater failed.
- ECM failed.

## DIAGNOSIS

### Required Special Tools:

- MB991958: Scan Tool (M.U.T-III Sub Assembly)
  - MB991824: V.C.I.
  - MB991827: USB Cable
  - MB991910: Main Harness A
- MD998464: Test Harness
- MB992110: Power Plant ECU Check Harness

### STEP 1. Check harness connector B-05 at heated oxygen sensor (front) for damage.

#### Q: Is the harness connector in good condition?

**YES** : Go to Step 2.

**NO** : Repair or replace it. Refer to GROUP 00E, Harness Connector Inspection [P.00E-2](#). Then go to Step 11.

### STEP 2. Check the heated oxygen sensor (front).

- (1) Disconnect heated oxygen sensor (front) connector B-05 and connect test harness special tool, MD998464, to the connector on the heated oxygen sensor (front) side.
- (2) Measure the resistance between heated oxygen sensor connector terminal No. 1 (red clip) and terminal No. 3 (blue clip).

**Standard value: 4.5 –8.0  $\Omega$  [at 20° C (68° F)]**

#### Q: Is the measured resistance between 4.5 and 8.0 $\Omega$ [at 20° C (68° F)]?

**YES** : Go to Step 3.

**NO** : Replace the heated oxygen sensor (front). Then go to Step 11.

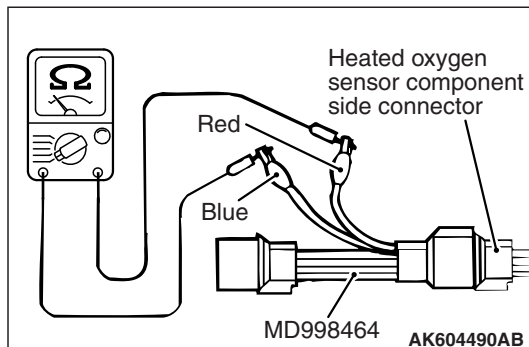

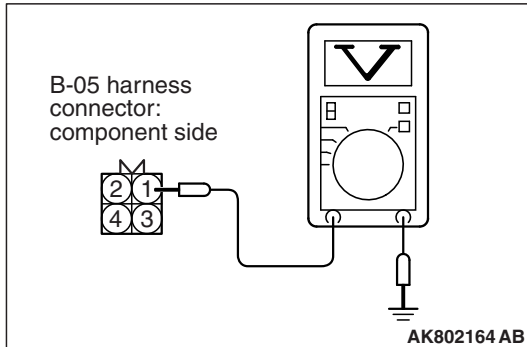

---

**STEP 3. Measure the power supply voltage at heated oxygen sensor (front) harness side connector B-05.**

- (1) Disconnect the connector B-05 and measure at the harness side.
- (2) Turn the ignition switch to the "ON" position.
- (3) Measure the voltage between terminal No. 1 and ground.
  - Voltage should be battery positive voltage.
- (4) Turn the ignition switch to the "LOCK" (OFF) position.

**Q: Is battery positive voltage (approximately 12 volts) present?**

**YES :** Go to Step 5.

**NO :** Go to Step 4.

---

**STEP 4. Check harness connector A-30X at MFI relay for damage.**

**Q: Is the harness connector in good condition?**

**YES :** Check harness connector A-10 at intermediate connector for damage, and repair or replace as required. Refer to GROUP 00E, Harness Connector Inspection [P.00E-2](#). If intermediate connector is in good condition, repair harness wire between MFI relay connector A-30X (terminal No. 2) and heated oxygen sensor (front) connector B-05 (terminal No. 1) because of open circuit or short circuit to ground. Then go to Step 11.

**NO :** Repair or replace it. Refer to GROUP 00E, Harness Connector Inspection [P.00E-2](#). Then go to Step 11.

---

**STEP 5. Check harness connector B-108 at ECM for damage.**

**Q: Is the harness connector in good condition?**

**YES :** Go to Step 6.

**NO :** Repair or replace it. Refer to GROUP 00E, Harness Connector Inspection [P.00E-2](#). Then go to Step 11.

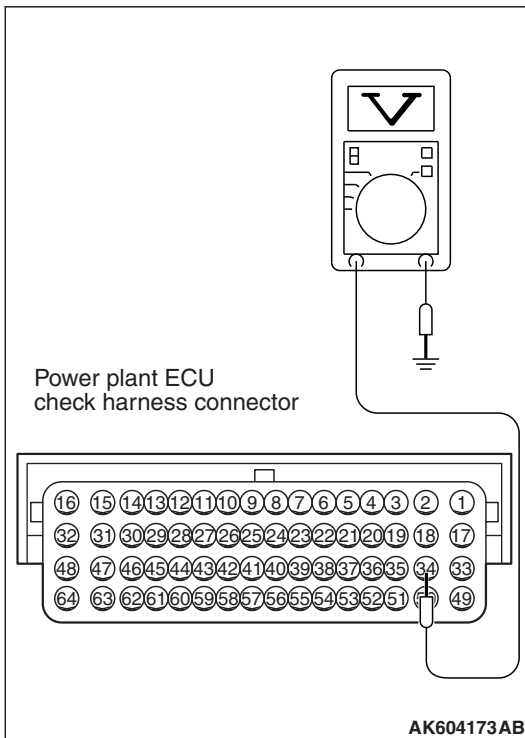
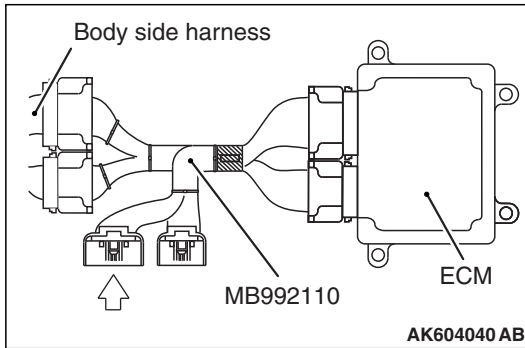

**STEP 6. Measure the power supply voltage at ECM connector B-108 by using power plant ECU check harness special tool MB992110.**

(1) Disconnect all ECM connectors. Connect the power plant ECU check harness special tool MB992110 between the separated connectors.

(2) Turn the ignition switch to the "ON" position.

(3) Measure the voltage between terminal No. 34 and ground.

- Voltage should be battery positive voltage.

(4) Turn the ignition switch to the "LOCK" (OFF) position.

**Q: Is battery positive voltage (approximately 12 volts) present?**

**YES :** Go to Step 7.

**NO :** Repair harness wire between heated oxygen sensor (front) connector B-05 (terminal No. 3) and ECM connector B-108 (terminal No. 34) because of open circuit or short circuit to ground. Then go to Step 11.

**STEP 7. Check harness connector A-30X at MFI relay for damage.**

**Q: Is the harness connector in good condition?**

**YES :** Go to Step 8.

**NO :** Repair or replace it. Refer to GROUP 00E, Harness Connector Inspection [P.00E-2](#). Then go to Step 11.

---

**STEP 8. Check for harness damage between MFI relay connector A-30X (terminal No. 2) and heated oxygen sensor (front) connector B-05 (terminal No. 1).**

*NOTE: Check harness after checking intermediate connector A-10. If intermediate connector is damaged, repair or replace it. Refer to GROUP 00E, Harness Connector Inspection P.00E-2. Then go to Step 11.*

**Q: Is the harness wire in good condition?**

**YES :** Go to Step 9.

**NO :** Repair it. Then go to Step 11.

---

**STEP 9. Check for harness damage between heated oxygen sensor (front) connector B-05 (terminal No. 3) and ECM connector B-108 (terminal No. 34).**

**Q: Is the harness wire in good condition?**

**YES :** Go to Step 10.

**NO :** Repair it. Then go to Step 11.

---

**STEP 10. Check the trouble symptoms.**

(1) Carry out a test drive with the drive cycle pattern. Refer to Diagnostic Function –OBD-II Drive Cycle –Pattern 2 P.13B-12.

(2) Check the diagnostic trouble code (DTC).

**Q: Is DTC P0031 set?**

**YES :** Replace the ECM (Refer to, Removal and Installation P.13B-1022). Then go to Step 11.

**NO :** It can be assumed that this malfunction is intermittent. Refer to GROUP 00, How to Use Troubleshooting/Inspection Service Points –How to Cope with Intermittent Malfunctions P.00-13.

---

**STEP 11. Test the OBD-II drive cycle.**

(1) Carry out a test drive with the drive cycle pattern. Refer to Diagnostic Function –OBD-II Drive Cycle –Pattern 2 P.13B-12.

(2) Check the diagnostic trouble code (DTC).

**Q: Is DTC P0031 set?**

**YES :** Retry the troubleshooting.

**NO :** The inspection is complete.

DTC P0032: Heated Oxygen Sensor (front) Heater Control Circuit High <Except vehicles for California>

HEATED OXYGEN SENSOR (FRONT) HEATER CIRCUIT <EXCEPT VEHICLES FOR CALIFORNIA>

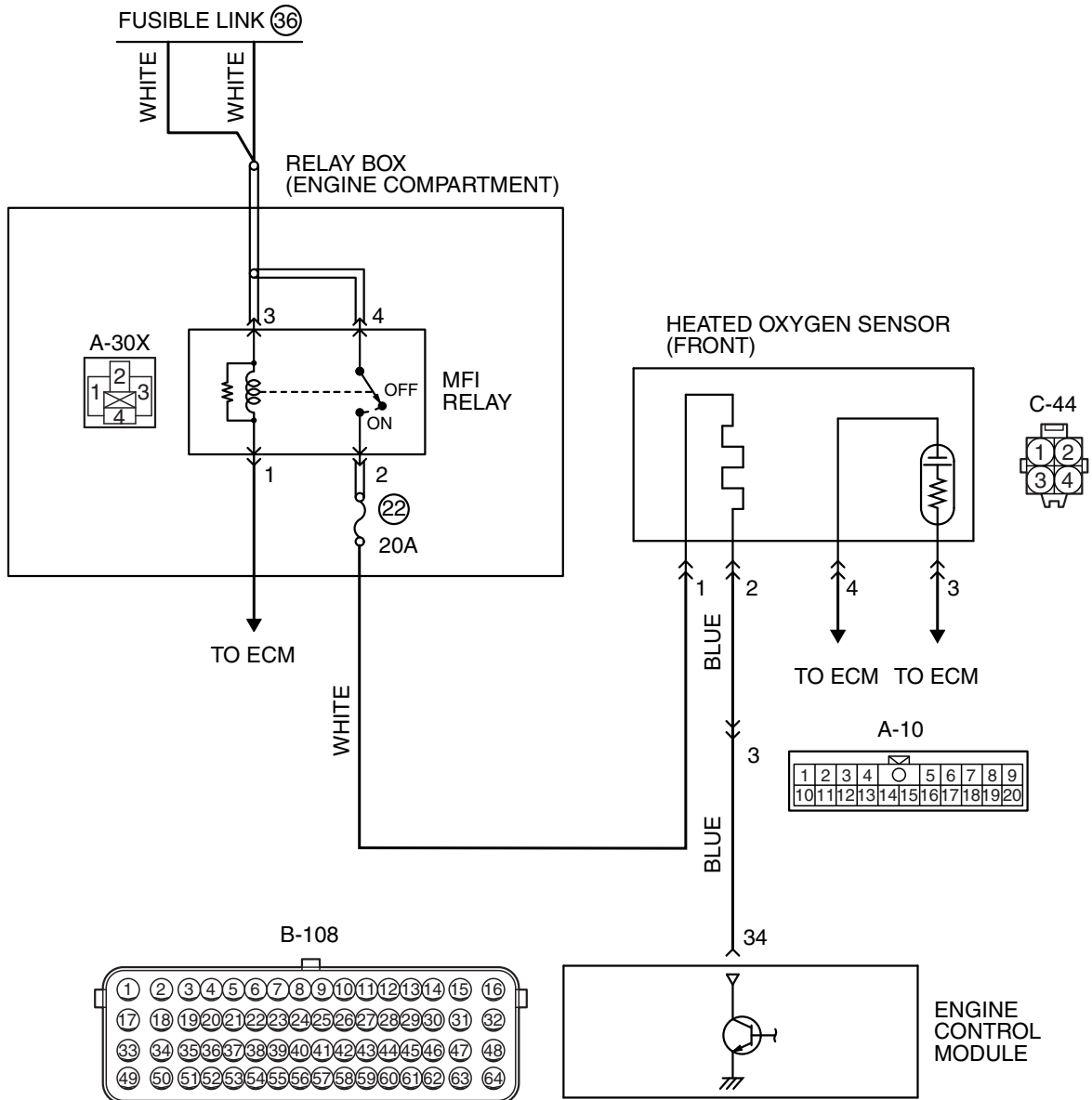

AK802010 AB

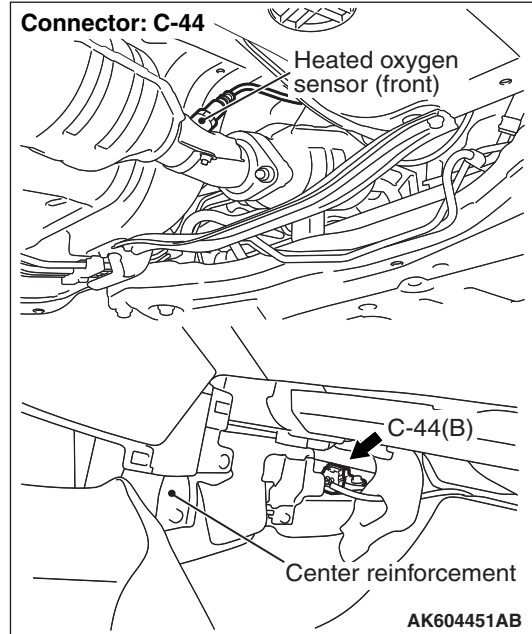
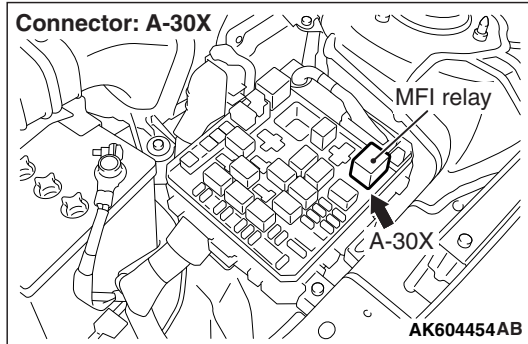
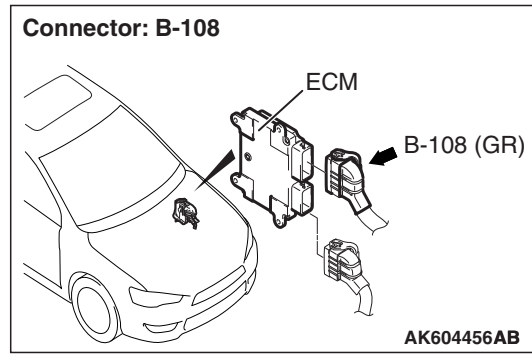
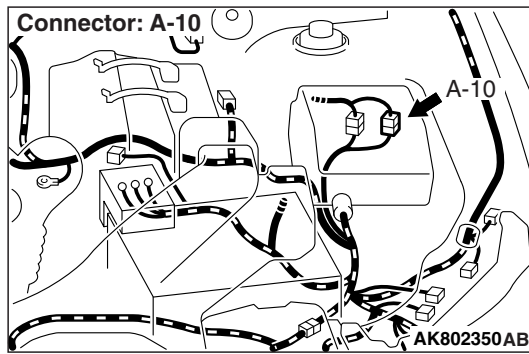

## CIRCUIT OPERATION

- Power is supplied from the MFI relay (terminal No. 2) to the heated oxygen sensor (front) heater.
- The ECM (terminal No. 34) controls continuity to the heated oxygen sensor (front) heater by turning the power transistor in the ECM "ON" and "OFF".

## TECHNICAL DESCRIPTION

- The ECM checks whether the heater current is within a specified range when the heater is energized.

## DESCRIPTIONS OF MONITOR METHODS

Heated oxygen sensor (front) heater current is out of specified range.

## MONITOR EXECUTION

Continuous

## MONITOR EXECUTION CONDITIONS (Other monitor and Sensor)

**Other Monitor (There is no temporary DTC stored in memory for the item monitored below)**

- Not applicable

**Sensor (The sensor below is determined to be normal)**

- Not applicable

**DTC SET CONDITIONS**

**Logic Flow Chart**

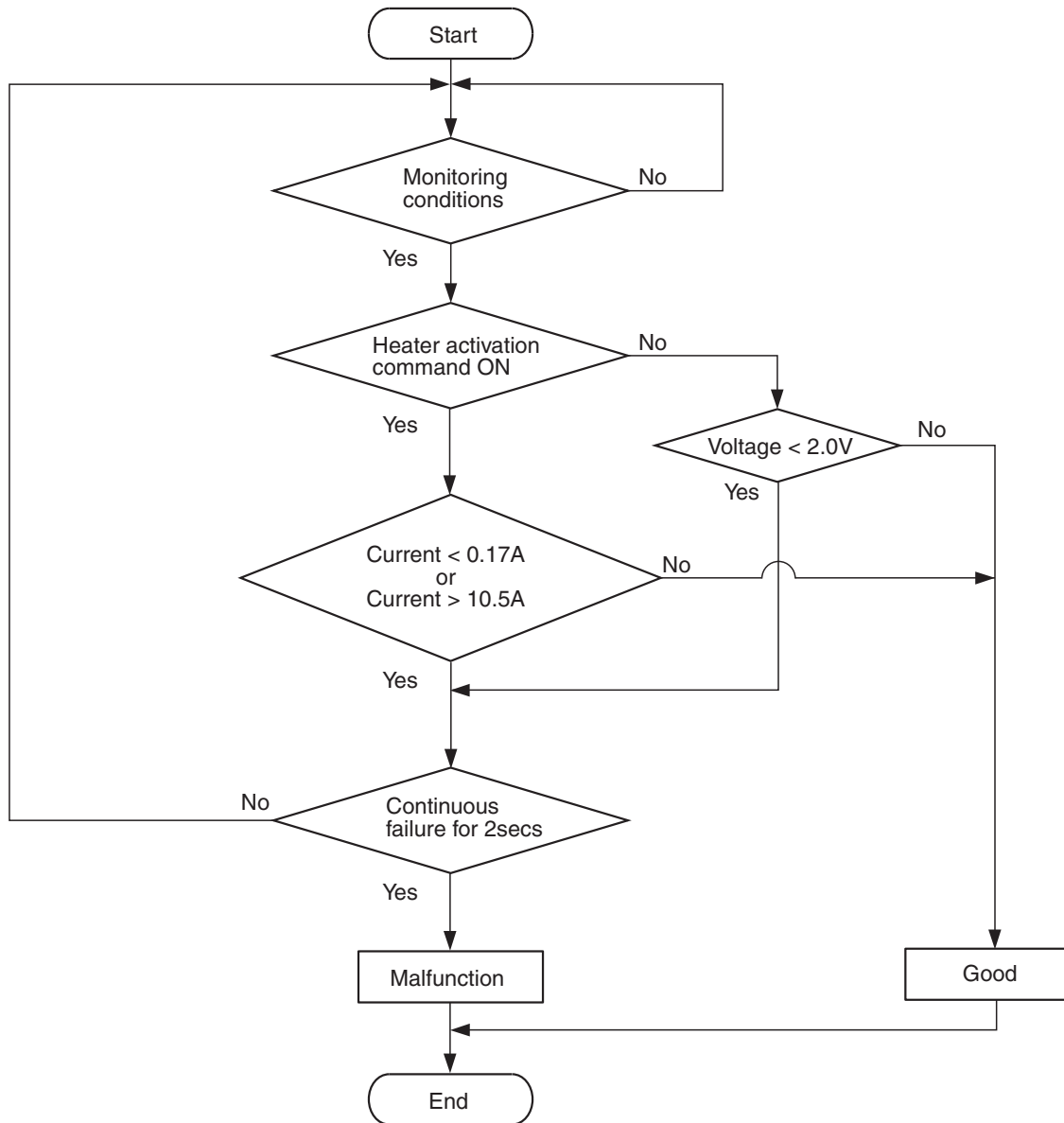

AK900352

**Check Conditions**

- More than 2 seconds have passed since the engine starting sequence was completed.
- While the heated oxygen sensor (front) heater is on.
- Battery positive voltage is between 11 and 16.5 volts.

**Judgement Criterion**

- The heated oxygen sensor (front) heater current is more than 10.5 amperes for 2 seconds.

**FAIL-SAFE AND BACKUP FUNCTION**

- None

**OBD-II DRIVE CYCLE PATTERN**

Refer to Diagnostic Function –OBD-II Drive Cycle – Pattern 2 [P.13B-12](#).

**TROUBLESHOOTING HINTS (The most likely causes for this code to be set are:)**

- Shorted heated oxygen sensor (front) heater circuit or connector damage.
- Heated oxygen sensor (front) heater failed.
- ECM failed.

## DIAGNOSIS

### Required Special Tools:

- MB991958: Scan Tool (M.U.T-III Sub Assembly)
  - MB991824: V.C.I.
  - MB991827: USB Cable
  - MB991910: Main Harness A
- MB991658: Test Harness

**STEP 1. Check harness connector C-44 at heated oxygen sensor (front) for damage.**

**Q: Is the harness connector in good condition?**

**YES :** Go to Step 2.

**NO :** Repair or replace it. Refer to GROUP 00E, Harness Connector Inspection [P.00E-2](#). Then go to Step 8.

**STEP 2. Check the heated oxygen sensor (front).**

- (1) Disconnect heated oxygen sensor (front) connector C-44 and connect test harness special tool, MB991658, to the connector on the heated oxygen sensor (front) side.
- (2) Measure the resistance between heated oxygen sensor connector terminal No. 1 and terminal No. 2.

**Standard value: 4.5 –8.0 Ω [at 20° C (68° F)]**

**Q: Is the measured resistance between 4.5 and 8.0 Ω [at 20° C (68° F)]?**

**YES :** Go to Step 3.

**NO :** Replace the heated oxygen sensor (front). Then go to Step 8.

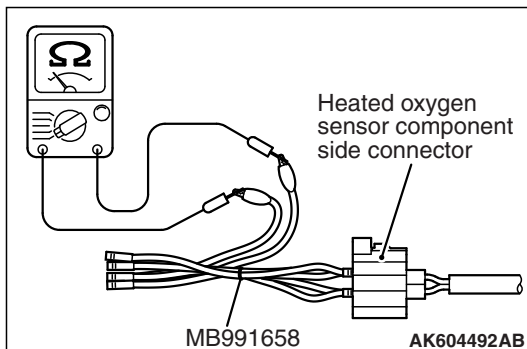

**STEP 3. Check harness connector A-30X at MFI relay for damage.**

**Q: Is the harness connector in good condition?**

**YES :** Go to Step 4.

**NO :** Repair or replace it. Refer to GROUP 00E, Harness Connector Inspection [P.00E-2](#). Then go to Step 8.

**STEP 4. Check for short circuit to power supply between MFI relay connector A-30X (terminal No. 2) and heated oxygen sensor (front) connector C-44 (terminal No. 1).**

**Q: Is the harness wire in good condition?**

**YES :** Go to Step 5.

**NO :** Repair it. Then go to Step 8.

**STEP 5. Check harness connector B-108 at ECM for damage.**

**Q: Is the harness connector in good condition?**

**YES :** Go to Step 6.

**NO :** Repair or replace it. Refer to GROUP 00E, Harness Connector Inspection [P.00E-2](#). Then go to Step 8.



---

**STEP 6. Check for short circuit to power supply between heated oxygen sensor (front) connector C-44 (terminal No. 2) and ECM connector B-108 (terminal No. 34).**

*NOTE: Check harness after checking intermediate connector A-10. If intermediate connector is damaged, repair or replace it. Refer to GROUP 00E, Harness Connector Inspection P.00E-2. Then go to Step 8.*

**Q: Is the harness wire in good condition?**

**YES :** Go to Step 7.

**NO :** Repair it. Then go to Step 8.

---

**STEP 7. Check the trouble symptoms.**

(1) Carry out a test drive with the drive cycle pattern. Refer to Diagnostic Function –OBD-II Drive Cycle –Pattern 2 P.13B-12.

(2) Check the diagnostic trouble code (DTC).

**Q: Is DTC P0032 set?**

**YES :** Replace the ECM (Refer to, Removal and Installation P.13B-1022). Then go to Step 8.

**NO :** It can be assumed that this malfunction is intermittent. Refer to GROUP 00, How to Use Troubleshooting/Inspection Service Points –How to Cope with Intermittent Malfunctions P.00-13.

---

**STEP 8. Test the OBD-II drive cycle.**

(1) Carry out a test drive with the drive cycle pattern. Refer to Diagnostic Function –OBD-II Drive Cycle –Pattern 2 P.13B-12.

(2) Check the diagnostic trouble code (DTC).

**Q: Is DTC P0032 set?**

**YES :** Retry the troubleshooting.

**NO :** The inspection is complete.

DTC P0032: Heated Oxygen Sensor (front) Heater Control Circuit High <Vehicles for California>

HEATED OXYGEN SENSOR (FRONT) HEATER CONTROL CIRCUIT <VEHICLES FOR CALIFORNIA>

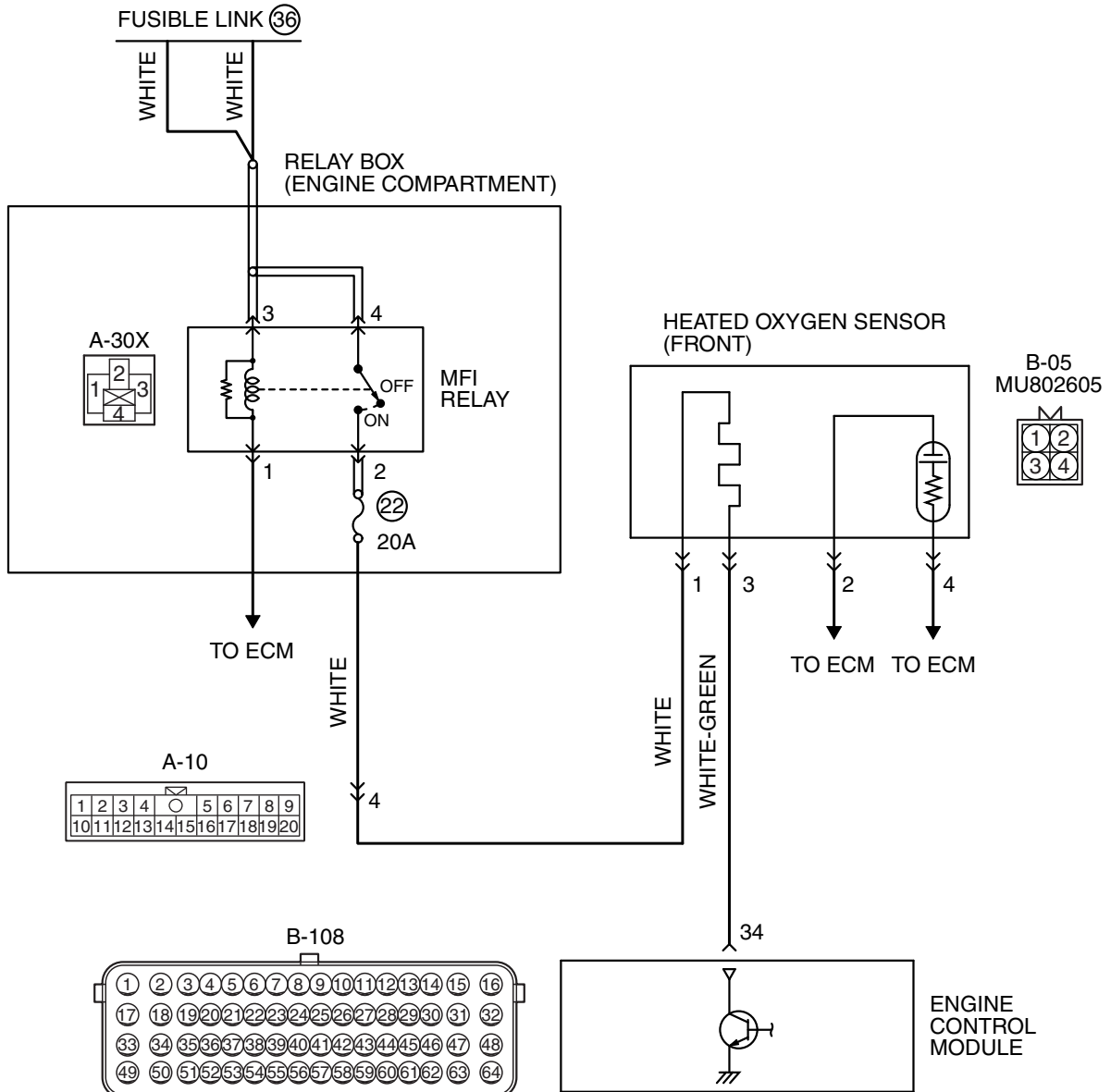

AK704941AD

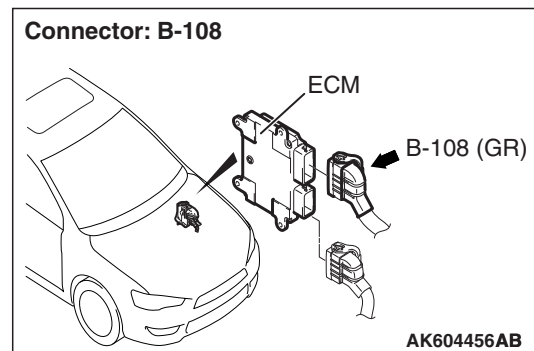
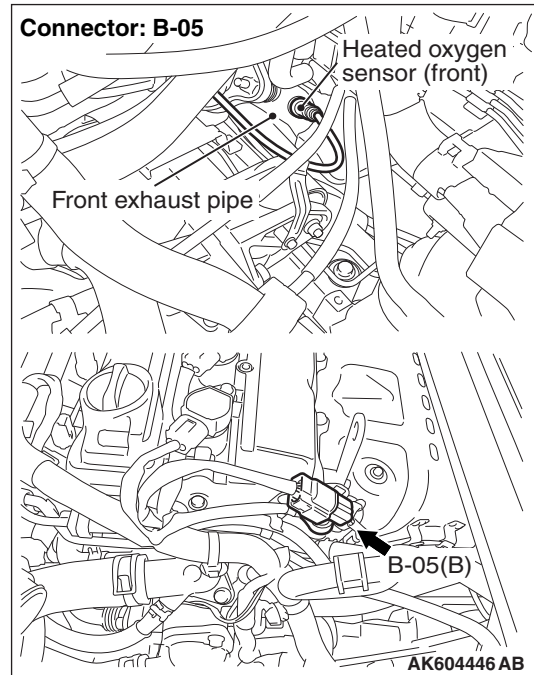
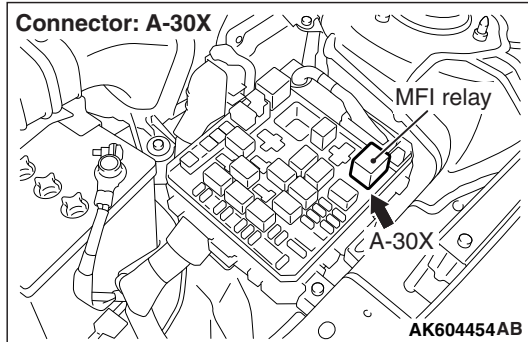
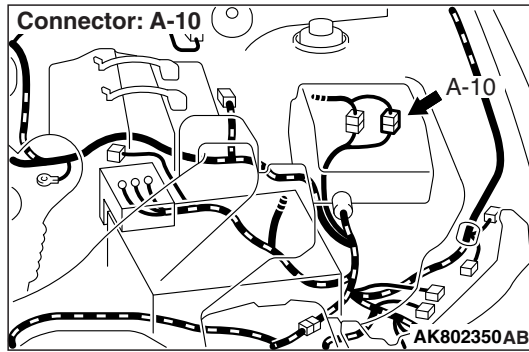

## CIRCUIT OPERATION

- Power is supplied from the MFI relay (terminal No. 2) to the heated oxygen sensor (front) heater.
- The ECM (terminal No. 34) controls continuity to the heated oxygen sensor (front) heater by turning the power transistor in the ECM "ON" and "OFF".

## TECHNICAL DESCRIPTION

- The ECM checks whether the heater current is within a specified range when the heater is energized.

## DESCRIPTIONS OF MONITOR METHODS

Heated oxygen sensor (front) heater current is out of specified range.

## MONITOR EXECUTION

Continuous

## MONITOR EXECUTION CONDITIONS (Other monitor and Sensor)

**Other Monitor (There is no temporary DTC stored in memory for the item monitored below)**

- Not applicable

**Sensor (The sensor below is determined to be normal)**

- Not applicable

DTC SET CONDITIONS

Logic Flow Chart

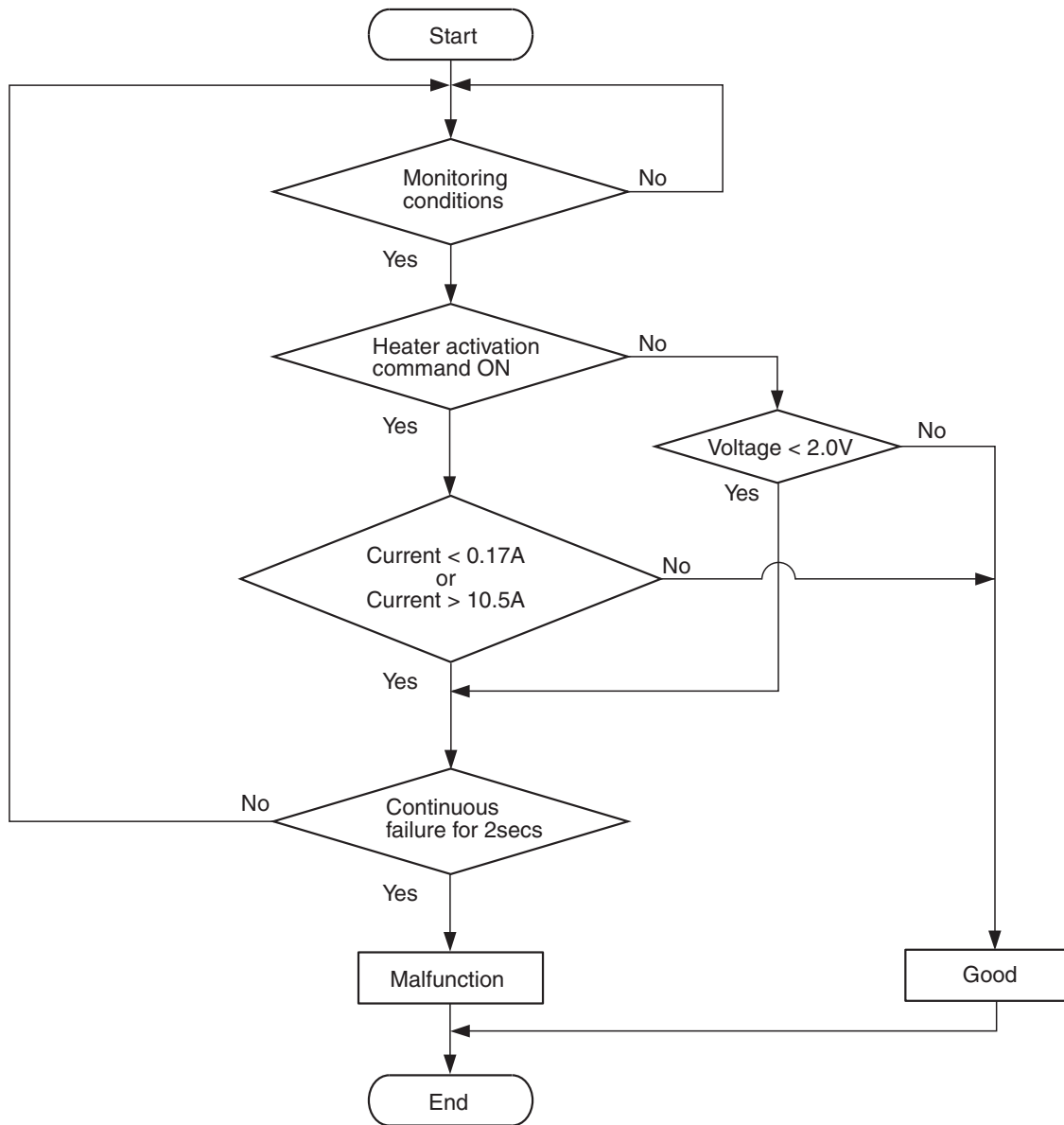

AK900352

**Check Conditions**

- More than 2 seconds have passed since the engine starting sequence was completed.
- While the heated oxygen sensor (front) heater is on.
- Battery positive voltage is between 11 and 16.5 volts.

**Judgement Criterion**

- The heated oxygen sensor (front) heater current is more than 10.5 amperes for 2 seconds.

**FAIL-SAFE AND BACKUP FUNCTION**

- None

**OBD-II DRIVE CYCLE PATTERN**

Refer to Diagnostic Function –OBD-II Drive Cycle – Pattern 2 P.13B-12.

**TROUBLESHOOTING HINTS (The most likely causes for this code to be set are:)**

- Shorted heated oxygen sensor (front) heater circuit or connector damage.
- Heated oxygen sensor (front) heater failed.
- ECM failed.

## DIAGNOSIS

### Required Special Tools:

- MB991958: Scan Tool (M.U.T-III Sub Assembly)
  - MB991824: V.C.I.
  - MB991827: USB Cable
  - MB991910: Main Harness A
- MD998464: Test Harness

**STEP 1. Check harness connector B-05 at heated oxygen sensor (front) for damage.**

**Q: Is the harness connector in good condition?**

**YES :** Go to Step 2.

**NO :** Repair or replace it. Refer to GROUP 00E, Harness Connector Inspection [P.00E-2](#). Then go to Step 8.

**STEP 2. Check the heated oxygen sensor (front).**

- (1) Disconnect heated oxygen sensor (front) connector B-05 and connect test harness special tool, MD998464, to the connector on the heated oxygen sensor (front) side.
- (2) Measure the resistance between heated oxygen sensor connector terminal No. 1 (red clip) and terminal No. 3 (blue clip).

**Standard value: 4.5 –8.0 Ω [at 20° C (68° F)]**

**Q: Is the measured resistance between 4.5 and 8.0 Ω [at 20° C (68° F)]?**

**YES :** Go to Step 3.

**NO :** Replace the heated oxygen sensor (front). Then go to Step 8.

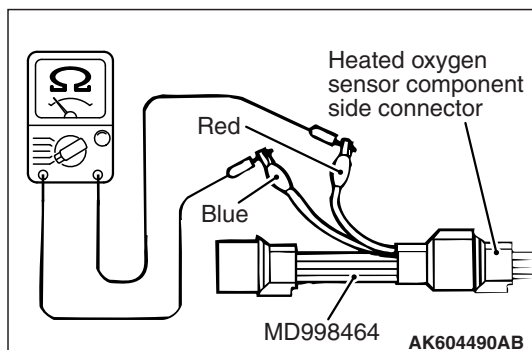

**STEP 3. Check harness connector A-30X at MFI relay for damage.**

**Q: Is the harness connector in good condition?**

**YES :** Go to Step 4.

**NO :** Repair or replace it. Refer to GROUP 00E, Harness Connector Inspection [P.00E-2](#). Then go to Step 8.

**STEP 4. Check for short circuit to power supply between MFI relay connector A-30X (terminal No. 2) and heated oxygen sensor (front) connector B-05 (terminal No. 1).**

*NOTE: Check harness after checking intermediate connector A-10. If intermediate connector is damaged, repair or replace it. Refer to GROUP 00E, Harness Connector Inspection [P.00E-2](#). Then go to Step 8.*

**Q: Is the harness wire in good condition?**

**YES :** Go to Step 5.

**NO :** Repair it. Then go to Step 8.

---

**STEP 5. Check harness connector B-108 at ECM for damage.**

**Q: Is the harness connector in good condition?**

**YES :** Go to Step 6.

**NO :** Repair or replace it. Refer to GROUP 00E, Harness Connector Inspection [P.00E-2](#). Then go to Step 8.

---

**STEP 6. Check for short circuit to power supply between heated oxygen sensor (front) connector B-05 (terminal No. 3) and ECM connector B-108 (terminal No. 34).**

**Q: Is the harness wire in good condition?**

**YES :** Go to Step 7.

**NO :** Repair it. Then go to Step 8.

---

**STEP 7. Check the trouble symptoms.**

(1) Carry out a test drive with the drive cycle pattern. Refer to Diagnostic Function –OBD-II Drive Cycle –Pattern 2 [P.13B-12](#).

(2) Check the diagnostic trouble code (DTC).

**Q: Is DTC P0032 set?**

**YES :** Replace the ECM (Refer to, Removal and Installation [P.13B-1022](#)). Then go to Step 8.

**NO :** It can be assumed that this malfunction is intermittent. Refer to GROUP 00, How to Use Troubleshooting/Inspection Service Points –How to Cope with Intermittent Malfunctions [P.00-13](#).

---

**STEP 8. Test the OBD-II drive cycle.**

(1) Carry out a test drive with the drive cycle pattern. Refer to Diagnostic Function –OBD-II Drive Cycle –Pattern 2 [P.13B-12](#).

(2) Check the diagnostic trouble code (DTC).

**Q: Is DTC P0032 set?**

**YES :** Retry the troubleshooting.

**NO :** The inspection is complete.

**DTC P0037: Heated Oxygen Sensor (rear) Heater Control Circuit Low <Except vehicles for California>**

HEATED OXYGEN SENSOR (REAR) HEATER CIRCUIT <EXCEPT VEHICLES FOR CALIFORNIA>

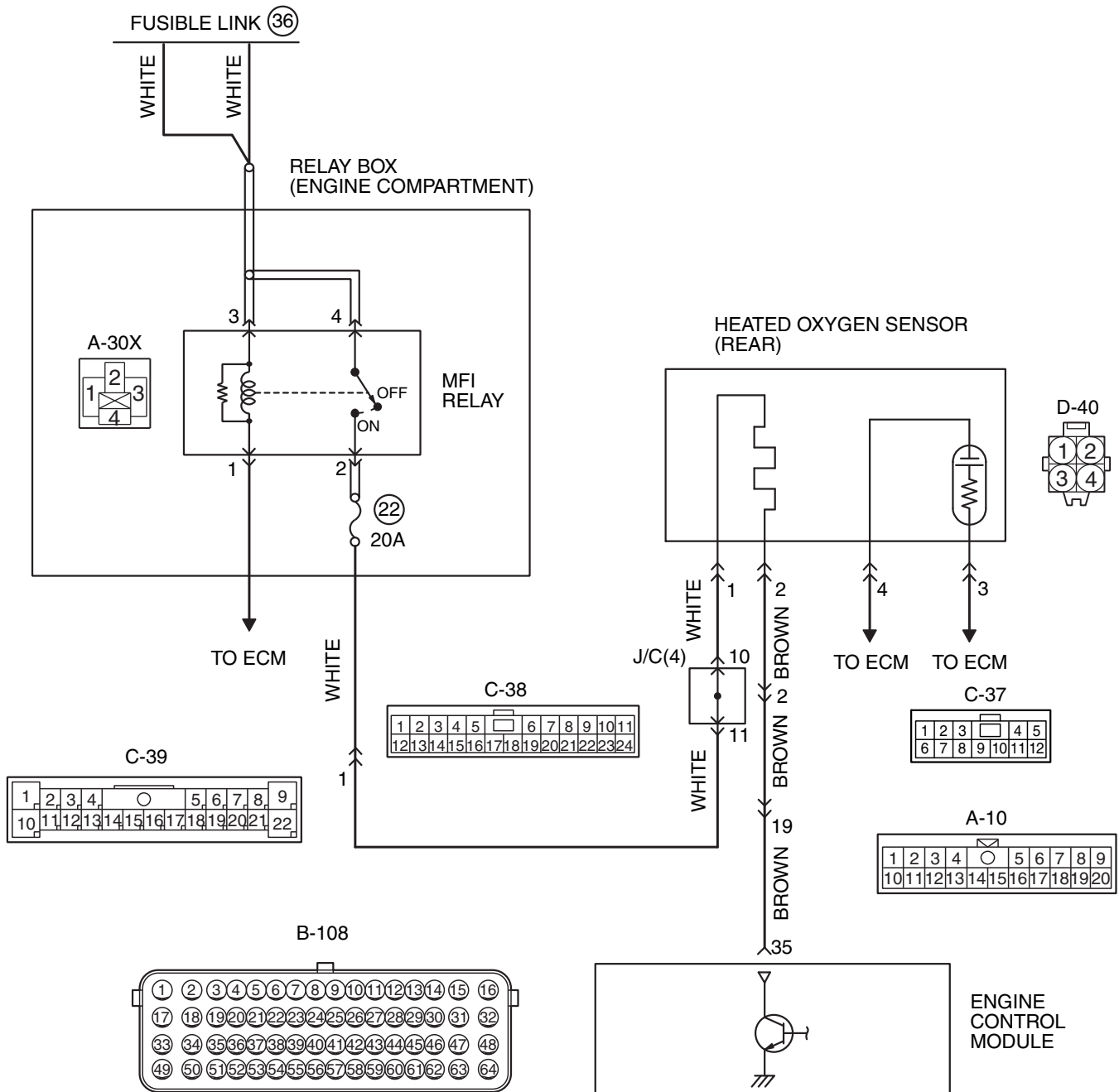

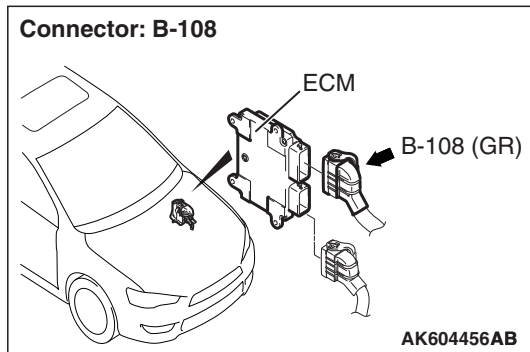
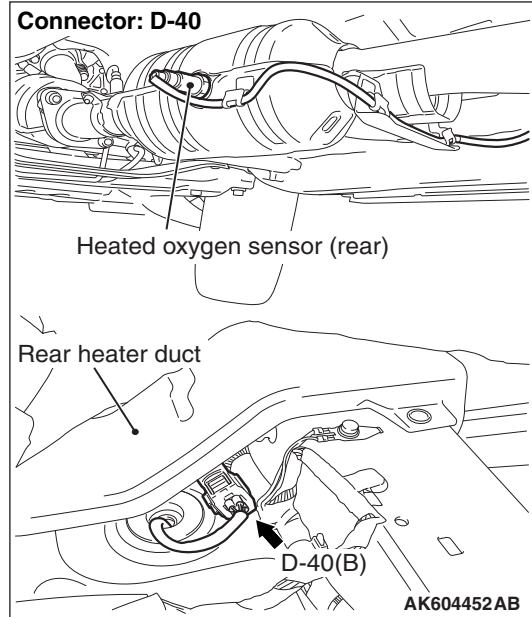
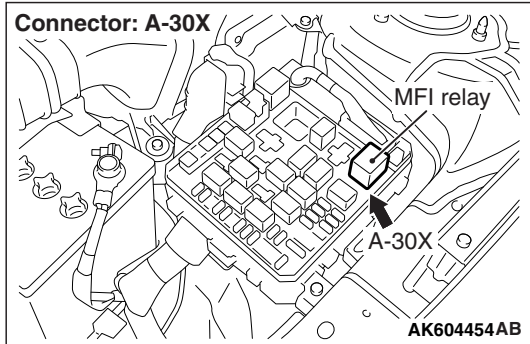
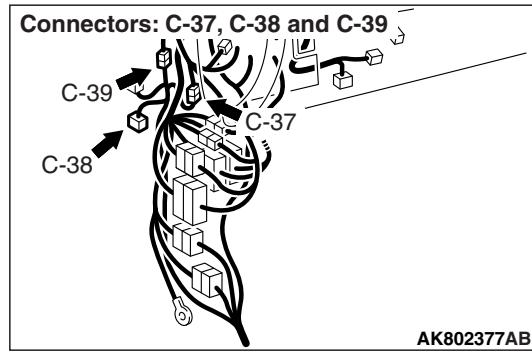
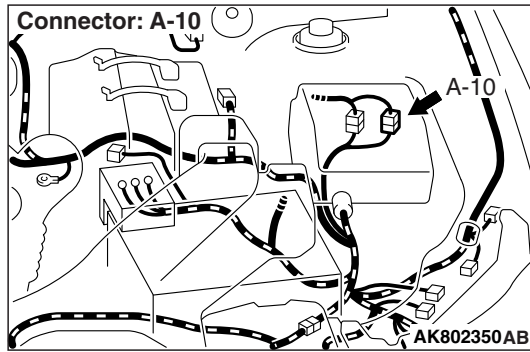

**CIRCUIT OPERATION**

- Power is supplied from the MFI relay (terminal No. 2) to the heated oxygen sensor (rear) heater.
- The ECM (terminal No. 35) controls continuity to the heated oxygen sensor (rear) heater by turning the power transistor in the ECM "ON" and "OFF".

**TECHNICAL DESCRIPTION**

- The ECM checks whether the heater current is within a specified range when the heater is energized.
- The ECM checks whether the heater voltage is within a specified range when the heater is not energized.

**DESCRIPTIONS OF MONITOR METHODS**

Heated oxygen sensor (rear) heater current or voltage is out of specified range.

**MONITOR EXECUTION**

Continuous

**MONITOR EXECUTION CONDITIONS (Other monitor and Sensor)**

**Other Monitor (There is no temporary DTC stored in memory for the item monitored below)**

- Not applicable

**Sensor (The sensor below is determined to be normal)**

- Not applicable



DTC SET CONDITIONS

Logic Flow Chart

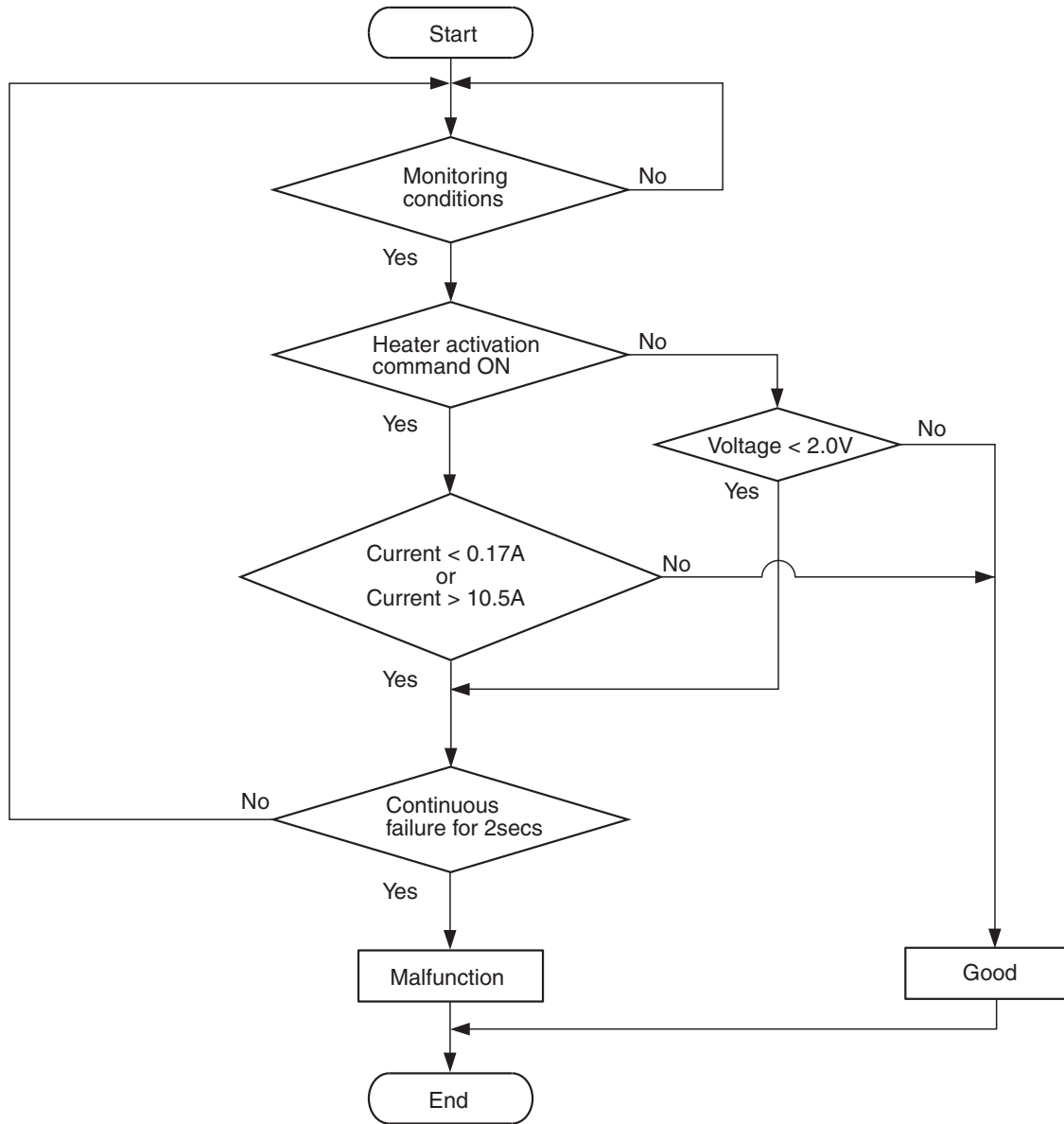

AK900352

**Check Conditions**

- More than 2 seconds have passed since the engine starting sequence was completed.
- While the heated oxygen sensor (rear) heater is on.
- Battery positive voltage is between 11 and 16.5 volts.

**Judgement Criterion**

- The heated oxygen sensor (rear) heater current is less than 0.17 ampere for 2 seconds.

**Check Conditions**

- More than 2 seconds have passed since the engine starting sequence was completed.

- While the heated oxygen sensor (rear) heater is off.
- Battery positive voltage is between 11 and 16.5 volts.

**Judgement Criterion**

- The heated oxygen sensor (rear) heater voltage is less than 2.0 volts for 2 seconds.

**FAIL-SAFE AND BACKUP FUNCTION**

- None

**OBD-II DRIVE CYCLE PATTERN**

Refer to Diagnostic Function –OBD-II Drive Cycle –  
Pattern 2 [P.13B-12](#).

**TROUBLESHOOTING HINTS (The most likely causes for this code to be set are:)**

- Open or shorted heated oxygen sensor (rear) heater circuit, harness damage or connector damage.
- Heated oxygen sensor (rear) heater failed.
- ECM failed.

**DIAGNOSIS****Required Special Tools:**

- MB991958: Scan Tool (M.U.T-III Sub Assembly)
  - MB991824: V.C.I.
  - MB991827: USB Cable
  - MB991910: Main Harness A
- MB991658: Test Harness
- MB992110: Power Plant ECU Check Harness

**STEP 1. Check harness connector D-40 at heated oxygen sensor (rear) for damage.****Q: Is the harness connector in good condition?**

**YES** : Go to Step 2.

**NO** : Repair or replace it. Refer to GROUP 00E, Harness Connector Inspection [P.00E-2](#). Then go to Step 11.

**STEP 2. Check the heated oxygen sensor (rear).**

- (1) Disconnect heated oxygen sensor (rear) connector D-40 and connect test harness special tool, MB991658, to the connector on the heated oxygen sensor (rear) side.
- (2) Measure the resistance between heated oxygen sensor connector terminal No. 1 and terminal No. 2.

**Standard value: 4.5 –8.0  $\Omega$  [at 20° C (68° F)]**

**Q: Is the measured resistance between 4.5 and 8.0  $\Omega$  [at 20° C (68° F)]?**

**YES** : Go to Step 3.

**NO** : Replace the heated oxygen sensor (rear). Then go to Step 11.

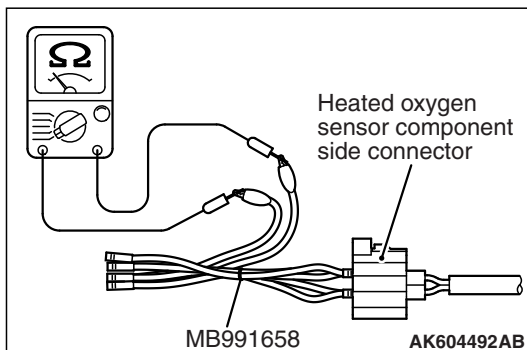

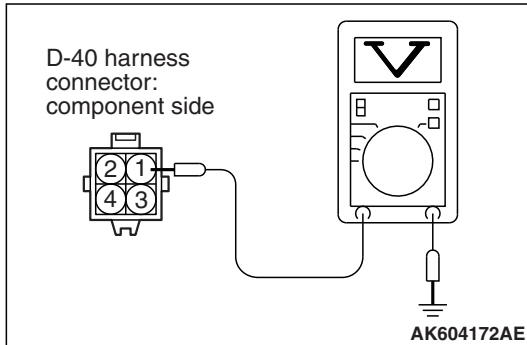

**STEP 3. Measure the power supply voltage at heated oxygen sensor (rear) harness side connector D-40.**

- (1) Disconnect the connector D-40 and measure at the harness side.
- (2) Turn the ignition switch to the "ON" position.
- (3) Measure the voltage between terminal No. 1 and ground.
  - Voltage should be battery positive voltage.
- (4) Turn the ignition switch to the "LOCK" (OFF) position.

**Q: Is battery positive voltage (approximately 12 volts) present?**

**YES :** Go to Step 5.

**NO :** Go to Step 4.

**STEP 4. Check harness connector A-30X at MFI relay for damage.**

**Q: Is the harness connector in good condition?**

**YES :** Check harness connector C-38 and C-39 at intermediate connectors for damage, and repair or replace as required. Refer to GROUP 00E, Harness Connector Inspection [P.00E-2](#). If intermediate connectors are in good condition, repair harness wire between MFI relay connector A-30X (terminal No. 2) and heated oxygen sensor (rear) connector D-40 (terminal No. 1) because of open circuit or short circuit to ground. Then go to Step 11.

**NO :** Repair or replace it. Refer to GROUP 00E, Harness Connector Inspection [P.00E-2](#). Then go to Step 11.

**STEP 5. Check harness connector B-108 at ECM for damage.**

**Q: Is the harness connector in good condition?**

**YES :** Go to Step 6.

**NO :** Repair or replace it. Refer to GROUP 00E, Harness Connector Inspection [P.00E-2](#). Then go to Step 11.

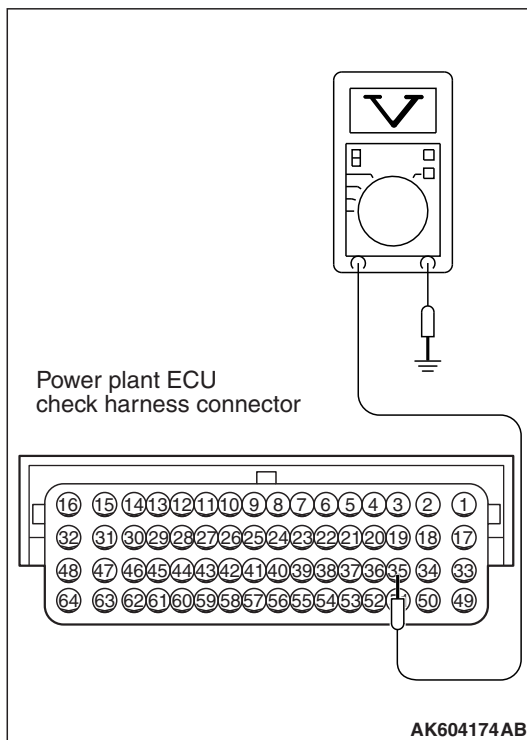
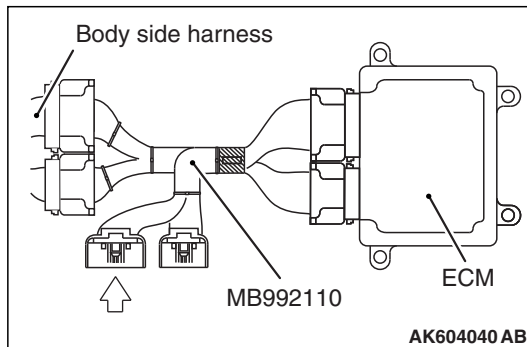

**STEP 6. Measure the power supply voltage at ECM connector B-108 by using power plant ECU check harness special tool MB992110.**

- (1) Disconnect all ECM connectors. Connect the power plant ECU check harness special tool MB992110 between the separated connectors.
- (2) Turn the ignition switch to the "ON" position.

- (3) Measure the voltage between terminal No. 35 and ground.
  - Voltage should be battery positive voltage.
- (4) Turn the ignition switch to the "LOCK" (OFF) position.

**Q: Is battery positive voltage (approximately 12 volts) present?**

**YES :** Go to Step 7.

**NO :** Check harness connectors A-10 and C-37 at intermediate connectors for damage, and repair or replace as required. Refer to GROUP 00E, Harness Connector Inspection [P.00E-2](#). If intermediate connectors are in good condition, repair harness wire between heated oxygen sensor (rear) connector D-40 (terminal No. 2) and ECM connector B-108 (terminal No. 35) because of open circuit or short circuit to ground. Then go to Step 11.

**STEP 7. Check harness connector A-30X at MFI relay for damage.**

**Q: Is the harness connector in good condition?**

**YES :** Go to Step 8.

**NO :** Repair or replace it. Refer to GROUP 00E, Harness Connector Inspection [P.00E-2](#). Then go to Step 11.

---

**STEP 8. Check for harness damage between MFI relay connector A-30X (terminal No. 2) and heated oxygen sensor (rear) connector D-40 (terminal No. 1).**

*NOTE: Check harness after checking intermediate connectors C-38 and C-39. If intermediate connectors are damaged, repair or replace them. Refer to GROUP 00E, Harness Connector Inspection P.00E-2. Then go to Step 11.*

**Q: Is the harness wire in good condition?**

**YES :** Go to Step 9.

**NO :** Repair it. Then go to Step 11.

---

**STEP 9. Check for harness damage between heated oxygen sensor (rear) connector D-40 (terminal No. 2) and ECM connector B-108 (terminal No. 35).**

*NOTE: Check harness after checking intermediate connectors A-10 and C-37. If intermediate connectors are damaged, repair or replace them. Refer to GROUP 00E, Harness Connector Inspection P.00E-2. Then go to Step 11.*

**Q: Is the harness wire in good condition?**

**YES :** Go to Step 10.

**NO :** Repair it. Then go to Step 11.

---

**STEP 10. Check the trouble symptoms.**

(1) Carry out a test drive with the drive cycle pattern. Refer to Diagnostic Function –OBD-II Drive Cycle –Pattern 2 P.13B-12.

(2) Check the diagnostic trouble code (DTC).

**Q: Is DTC P0037 set?**

**YES :** Replace the ECM (Refer to, Removal and Installation P.13B-1022). Then go to Step 11.

**NO :** It can be assumed that this malfunction is intermittent. Refer to GROUP 00, How to Use Troubleshooting/Inspection Service Points –How to Cope with Intermittent Malfunctions P.00-13.

---

**STEP 11. Test the OBD-II drive cycle.**

(1) Carry out a test drive with the drive cycle pattern. Refer to Diagnostic Function –OBD-II Drive Cycle –Pattern 2 P.13B-12.

(2) Check the diagnostic trouble code (DTC).

**Q: Is DTC P0037 set?**

**YES :** Retry the troubleshooting.

**NO :** The inspection is complete.

DTC P0037: Heated Oxygen Sensor (rear) Heater Control Circuit Low <Vehicles for California>

HEATED OXYGEN SENSOR (REAR) HEATER CONTROL CIRCUIT < VEHICLES FOR CALIFORNIA >

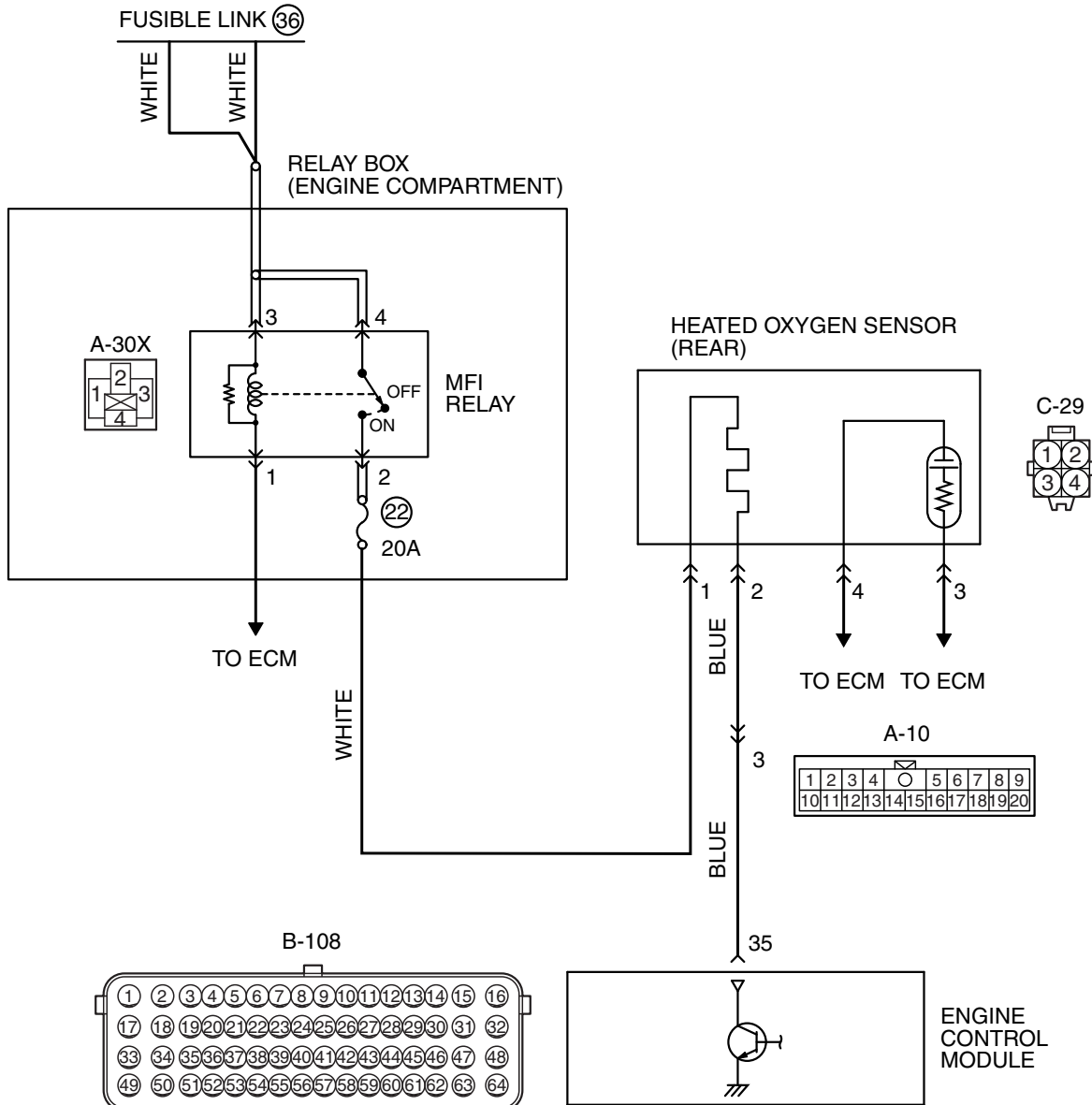

AK802010 AC

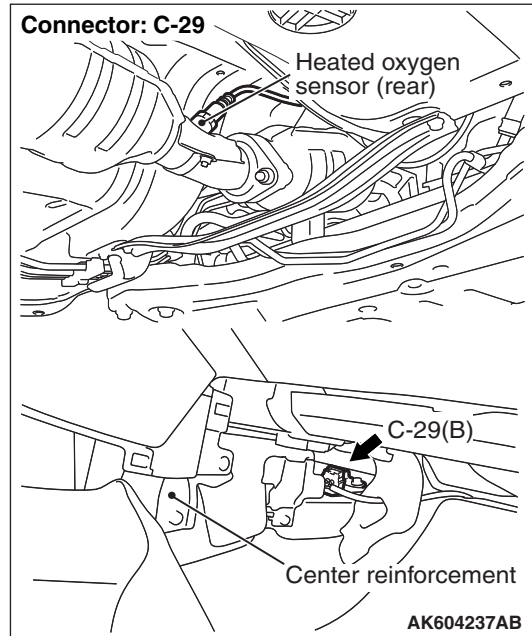
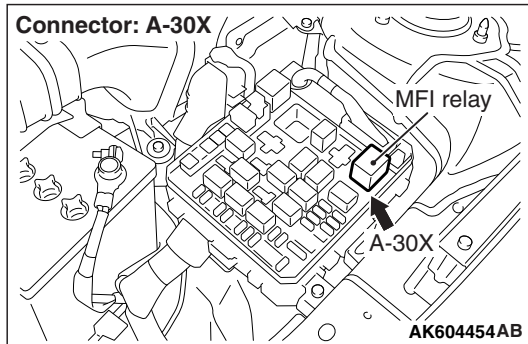
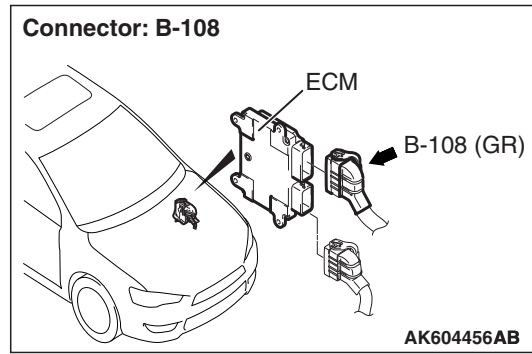
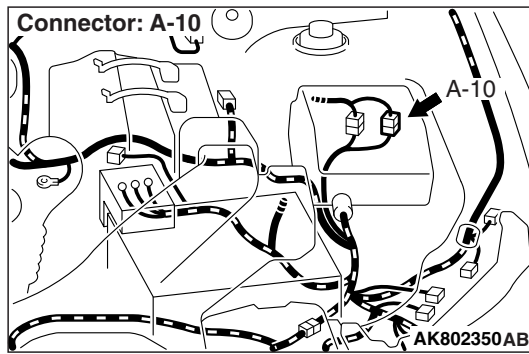

## CIRCUIT OPERATION

- Power is supplied from the MFI relay (terminal No. 2) to the heated oxygen sensor (rear) heater.
- The ECM (terminal No. 35) controls continuity to the heated oxygen sensor (rear) heater by turning the power transistor in the ECM "ON" and "OFF".

## TECHNICAL DESCRIPTION

- The ECM checks whether the heater current is within a specified range when the heater is energized.
- The ECM checks whether the heater voltage is within a specified range when the heater is not energized.

## DESCRIPTIONS OF MONITOR METHODS

Heated oxygen sensor heater (rear) current or voltage is out of specified range.

## MONITOR EXECUTION

Continuous

## MONITOR EXECUTION CONDITIONS (Other monitor and Sensor)

**Other Monitor (There is no temporary DTC stored in memory for the item monitored below)**

- Not applicable

**Sensor (The sensor below is determined to be normal)**

- Not applicable

DTC SET CONDITIONS

Logic Flow Chart

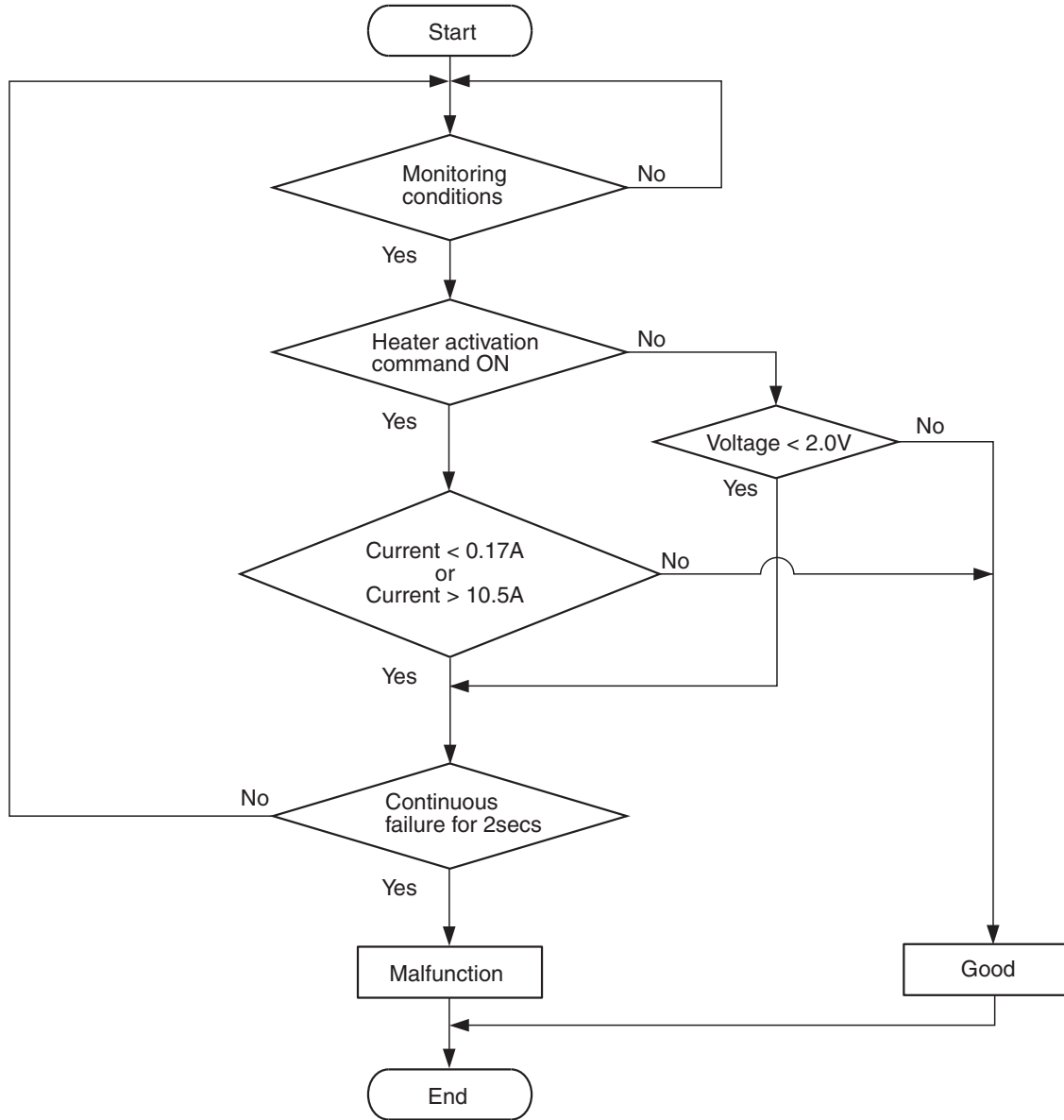

AK900352

**Check Conditions**

- More than 2 seconds have passed since the engine starting sequence was completed.
- While the heated oxygen sensor (rear) heater is on.
- Battery positive voltage is between 11 and 16.5 volts.

**Judgement Criterion**

- The heated oxygen sensor (rear) heater current is less than 0.17 ampere for 2 seconds.

**Check Conditions**

- More than 2 seconds have passed since the engine starting sequence was completed.

- While the heated oxygen sensor (rear) heater is off.
- Battery positive voltage is between 11 and 16.5 volts.

**Judgement Criterion**

- The heated oxygen sensor (rear) heater voltage is less than 2.0 volts for 2 seconds.

**FAIL-SAFE AND BACKUP FUNCTION**

- None



## OBD-II DRIVE CYCLE PATTERN

Refer to Diagnostic Function –OBD-II Drive Cycle –  
Pattern 2 [P.13B-12](#).

## TROUBLESHOOTING HINTS (The most likely causes for this code to be set are:)

- Open or shorted heated oxygen sensor (rear) heater circuit, harness damage or connector damage.
- Heated oxygen sensor (rear) heater failed.
- ECM failed.

## DIAGNOSIS

### Required Special Tools:

- MB991958: Scan Tool (M.U.T-III Sub Assembly)
  - MB991824: V.C.I.
  - MB991827: USB Cable
  - MB991910: Main Harness A
- MB991658: Test Harness
- MB992110: Power Plant ECU Check Harness

### STEP 1. Check harness connector C-29 at heated oxygen sensor (rear) for damage.

#### Q: Is the harness connector in good condition?

**YES** : Go to Step 2.

**NO** : Repair or replace it. Refer to GROUP 00E, Harness Connector Inspection [P.00E-2](#). Then go to Step 11.

### STEP 2. Check the heated oxygen sensor (rear).

- (1) Disconnect heated oxygen sensor (rear) connector C-29 and connect test harness special tool, MB991658, to the connector on the heated oxygen sensor (rear) side.
- (2) Measure the resistance between heated oxygen sensor (rear) connector terminal No. 1 and terminal No. 2.

**Standard value: 4.5 –8.0  $\Omega$  [at 20° C (68° F)]**

#### Q: Is the measured resistance between 4.5 and 8.0 $\Omega$ [at 20° C (68° F)]?

**YES** : Go to Step 3.

**NO** : Replace the heated oxygen sensor (rear). Then go to Step 11.

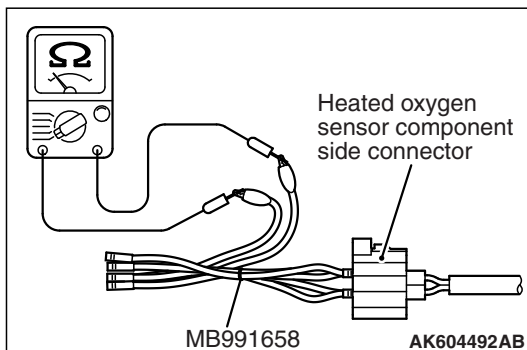

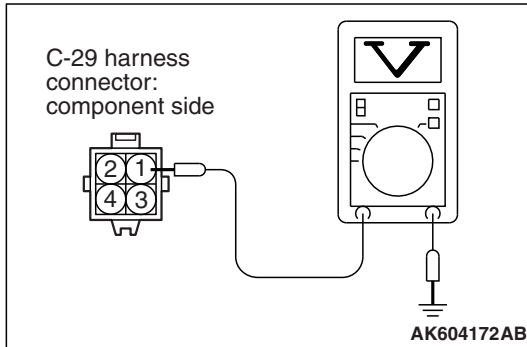

---

**STEP 3. Measure the power supply voltage at heated oxygen sensor (rear) harness side connector C-29.**

- (1) Disconnect the connector C-29 and measure at the harness side.
- (2) Turn the ignition switch to the "ON" position.
- (3) Measure the voltage between terminal No. 1 and ground.
  - Voltage should be battery positive voltage.
- (4) Turn the ignition switch to the "LOCK" (OFF) position.

**Q: Is battery positive voltage (approximately 12 volts) present?**

**YES :** Go to Step 5.

**NO :** Go to Step 4.

---

**STEP 4. Check harness connector A-30X at MFI relay for damage.**

**Q: Is the harness connector in good condition?**

**YES :** Repair harness wire between MFI relay connector A-30X (terminal No. 2) and heated oxygen sensor (rear) connector C-29 (terminal No. 1) because of open circuit or short circuit to ground. Then go to Step 11.

**NO :** Repair or replace it. Refer to GROUP 00E, Harness Connector Inspection [P.00E-2](#). Then go to Step 11.

---

**STEP 5. Check harness connector B-108 at ECM for damage.**

**Q: Is the harness connector in good condition?**

**YES :** Go to Step 6.

**NO :** Repair or replace it. Refer to GROUP 00E, Harness Connector Inspection [P.00E-2](#). Then go to Step 11.

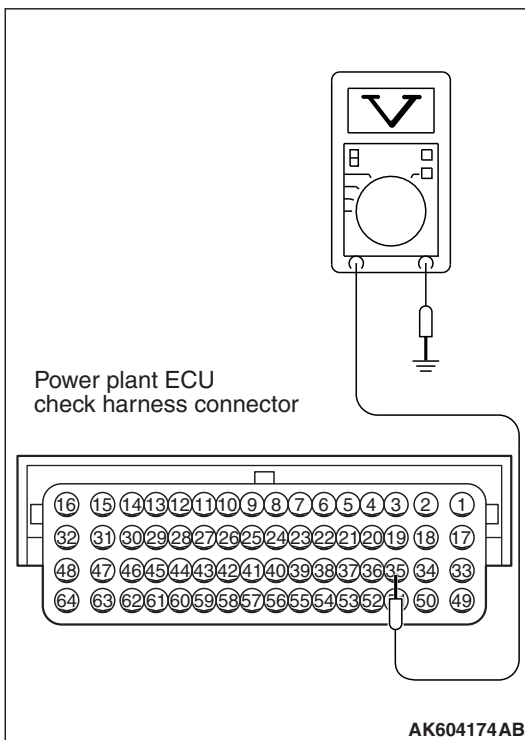
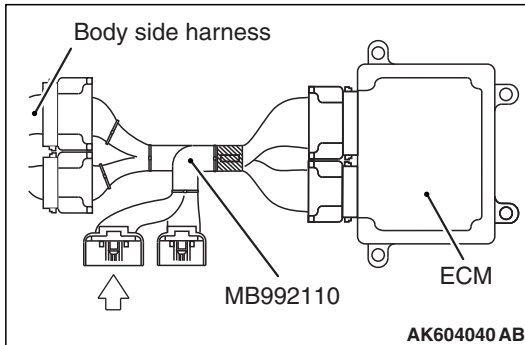

**STEP 6. Measure the power supply voltage at ECM connector B-108 by using power plant ECU check harness special tool MB992110.**

(1) Disconnect all ECM connectors. Connect the power plant ECU check harness special tool MB992110 between the separated connectors.

(2) Turn the ignition switch to the "ON" position.

(3) Measure the voltage between terminal No. 35 and ground.

- Voltage should be battery positive voltage.

(4) Turn the ignition switch to the "LOCK" (OFF) position.

**Q: Is battery positive voltage (approximately 12 volts) present?**

**YES :** Go to Step 7.

**NO :** Check harness connector A-10 at intermediate connector for damage, and repair or replace as required. Refer to GROUP 00E, Harness Connector Inspection [P.00E-2](#). If intermediate connector is in good condition, repair harness wire between heated oxygen sensor (rear) connector C-29 (terminal No. 2) and ECM connector B-108 (terminal No. 35) because of open circuit or short circuit to ground. Then go to Step 11.

**STEP 7. Check harness connector A-30X at MFI relay for damage.**

**Q: Is the harness connector in good condition?**

**YES :** Go to Step 8.

**NO :** Repair or replace it. Refer to GROUP 00E, Harness Connector Inspection [P.00E-2](#). Then go to Step 11.

**STEP 8. Check for harness damage between MFI relay connector A-30X (terminal No. 2) and heated oxygen sensor (rear) connector C-29 (terminal No. 1).**

**Q: Is the harness wire in good condition?**

**YES :** Go to Step 9.

**NO :** Repair it. Then go to Step 11.

**STEP 9. Check for harness damage between heated oxygen sensor (rear) connector C-29 (terminal No. 2) and ECM connector B-108 (terminal No. 35).**

*NOTE: Check harness after checking intermediate connector A-10. If intermediate connector is damaged, repair or replace it. Refer to GROUP 00E, Harness Connector Inspection P.00E-2. Then go to Step 11.*

**Q: Is the harness wire in good condition?**

**YES** : Go to Step 10.

**NO** : Repair it. Then go to Step 11.

---

**STEP 10. Check the trouble symptoms.**

(1) Carry out a test drive with the drive cycle pattern. Refer to Diagnostic Function –OBD-II Drive Cycle –Pattern 2 P.13B-12.

(2) Check the diagnostic trouble code (DTC).

**Q: Is DTC P0037 set?**

**YES** : Replace the ECM (Refer to, Removal and Installation P.13B-1022). Then go to Step 11.

**NO** : It can be assumed that this malfunction is intermittent. Refer to GROUP 00, How to Use Troubleshooting/Inspection Service Points –How to Cope with Intermittent Malfunctions P.00-13.

---

**STEP 11. Test the OBD-II drive cycle.**

(1) Carry out a test drive with the drive cycle pattern. Refer to Diagnostic Function –OBD-II Drive Cycle –Pattern 2 P.13B-12.

(2) Check the diagnostic trouble code (DTC).

**Q: Is DTC P0037 set?**

**YES** : Retry the troubleshooting.

**NO** : The inspection is complete.

DTC P0038: Heated Oxygen Sensor (rear) Heater Control Circuit High <Except vehicles for California>

HEATED OXYGEN SENSOR (REAR) HEATER CIRCUIT <EXCEPT VEHICLES FOR CALIFORNIA>

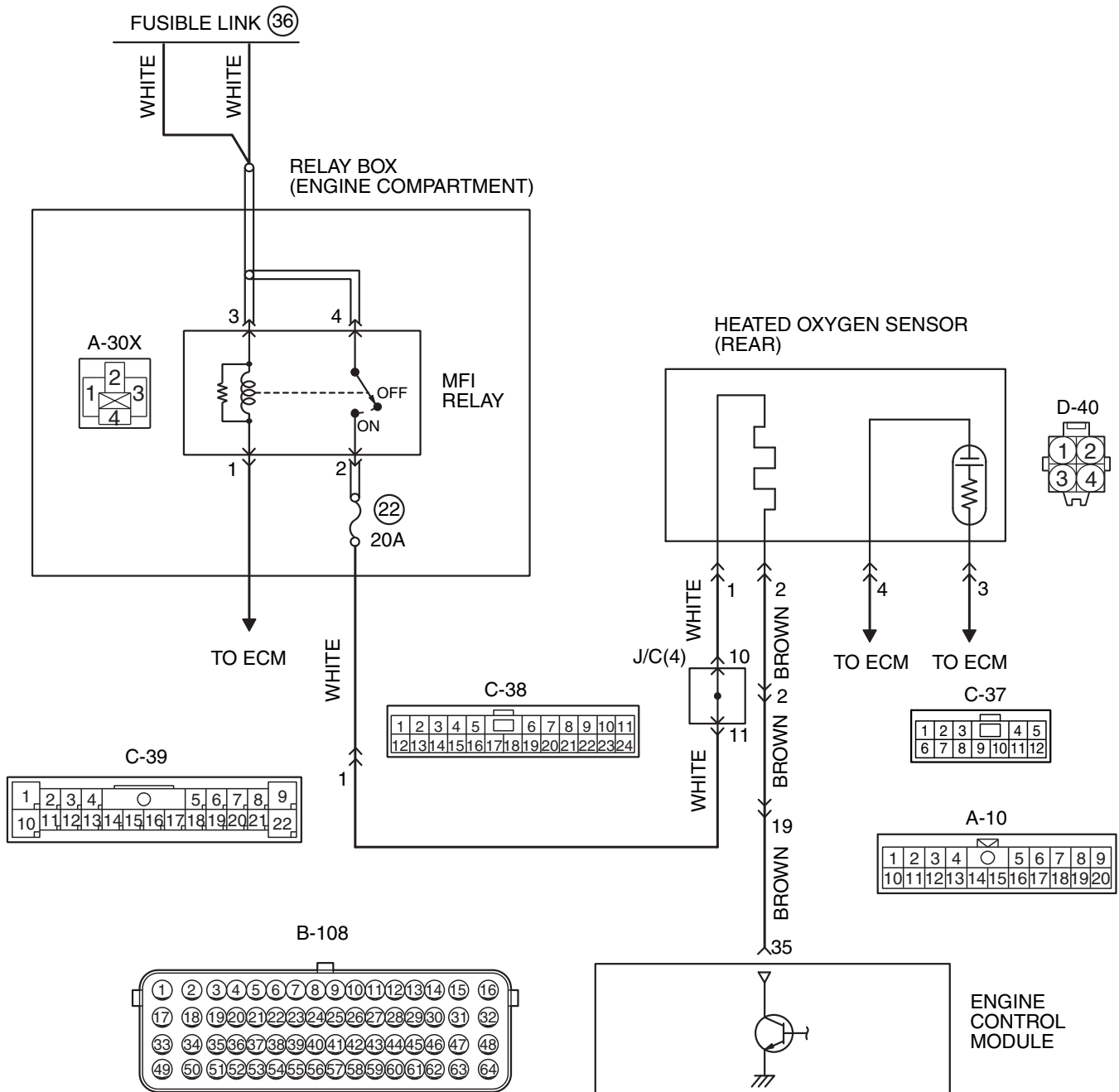

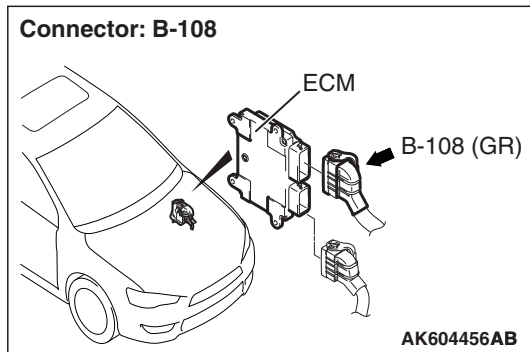
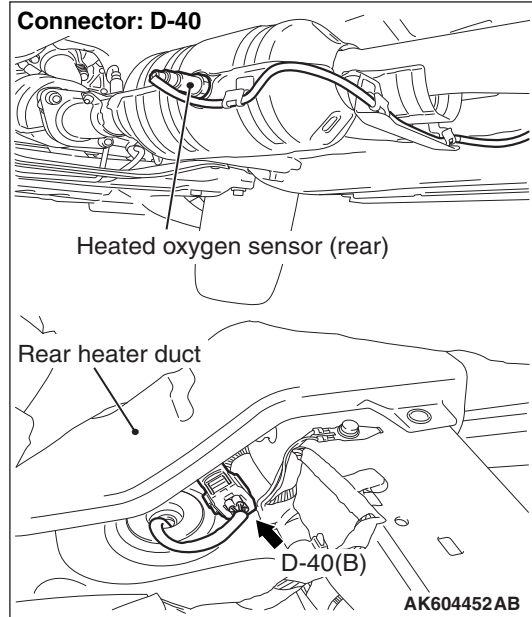
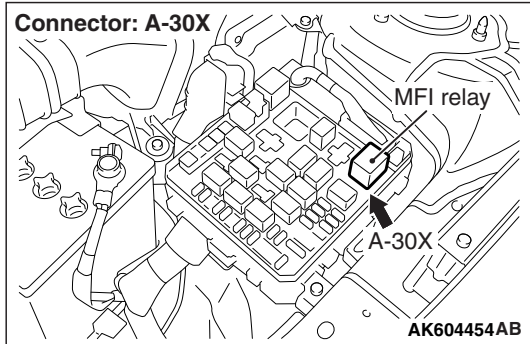
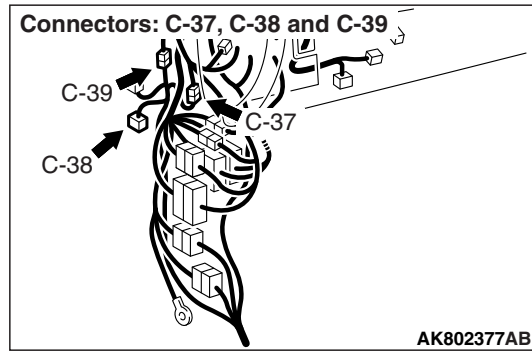
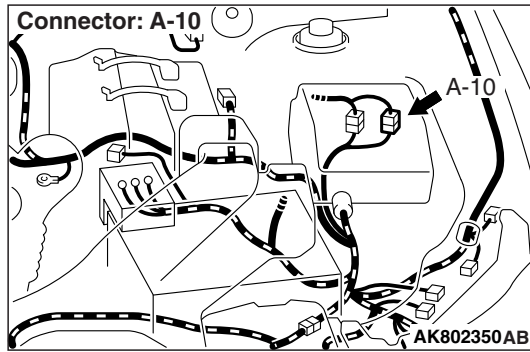

**CIRCUIT OPERATION**

- Power is supplied from the MFI relay (terminal No. 2) to the heated oxygen sensor (rear) heater.
- The ECM (terminal No. 35) controls continuity to the heated oxygen sensor (rear) heater by turning the power transistor in the ECM "ON" and "OFF".

**TECHNICAL DESCRIPTION**

- The ECM checks whether the heater current is within a specified range when the heater is energized.

**DESCRIPTIONS OF MONITOR METHODS**

Heated oxygen sensor (rear) heater current is out of specified range.

**MONITOR EXECUTION**

Continuous

**MONITOR EXECUTION CONDITIONS (Other monitor and Sensor)**

**Other Monitor (There is no temporary DTC stored in memory for the item monitored below)**

- Not applicable

**Sensor (The sensor below is determined to be normal)**

- Not applicable

**DTC SET CONDITIONS**

**Logic Flow Chart**

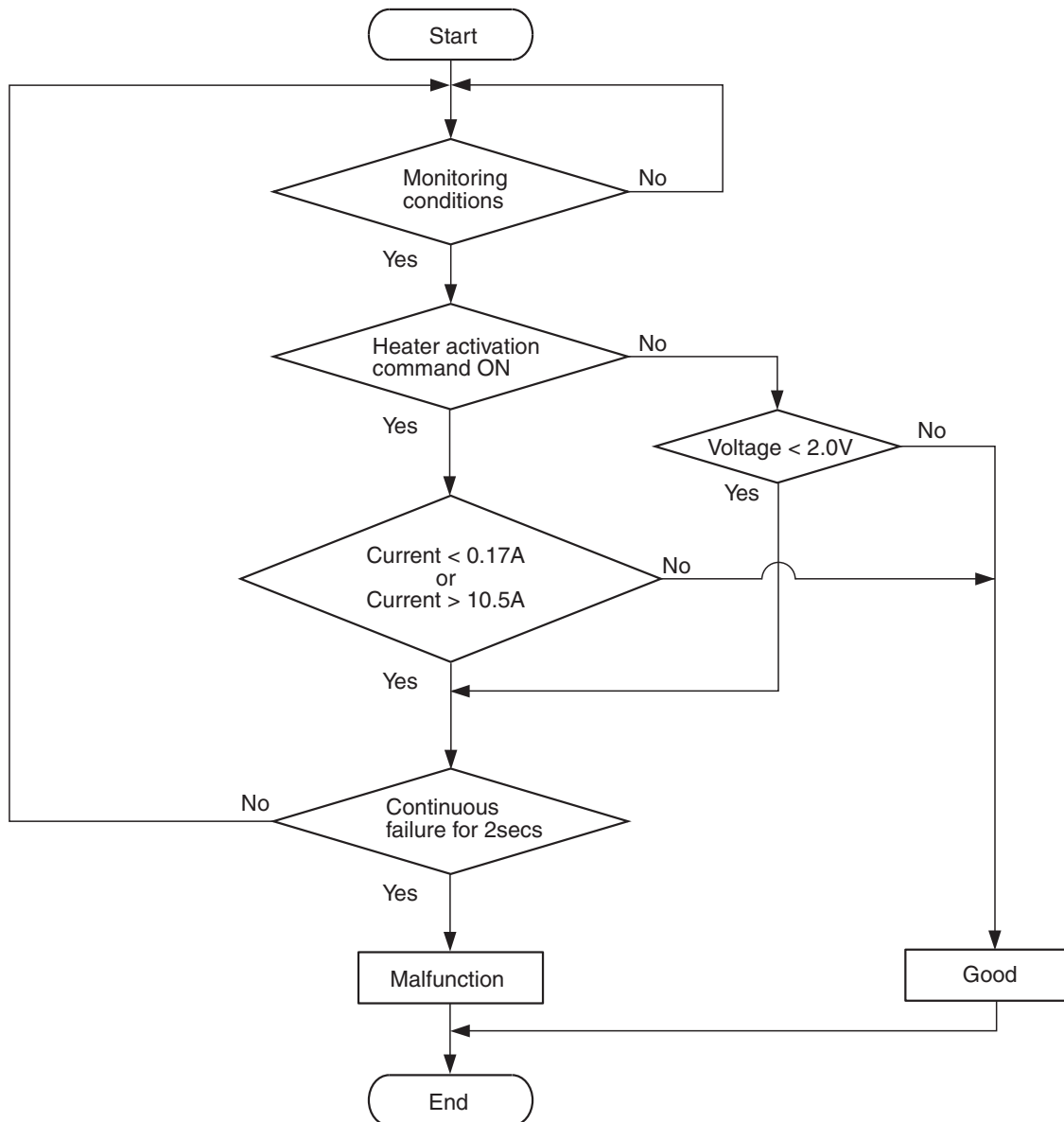

AK900352

**Check Conditions**

- More than 2 seconds have passed since the engine starting sequence was completed.
- While the heated oxygen sensor (rear) heater is on.
- Battery positive voltage is between 11 and 16.5 volts.

**Judgement Criterion**

- The heated oxygen sensor (rear) heater current is more than 10.5 amperes for 2 seconds.

**FAIL-SAFE AND BACKUP FUNCTION**

- None

**OBD-II DRIVE CYCLE PATTERN**

Refer to Diagnostic Function –OBD-II Drive Cycle – Pattern 2 P.13B-12.

**TROUBLESHOOTING HINTS (The most likely causes for this code to be set are:)**

- Shorted heated oxygen sensor (rear) heater circuit or connector damage.
- Heated oxygen sensor (rear) heater failed.
- ECM failed.

**DIAGNOSIS****Required Special Tools:**

- MB991958: Scan Tool (M.U.T-III Sub Assembly)
  - MB991824: V.C.I.
  - MB991827: USB Cable
  - MB991910: Main Harness A
- MB991658: Test Harness

**STEP 1. Check harness connector D-40 at heated oxygen sensor (rear) for damage.****Q: Is the harness connector in good condition?****YES** : Go to Step 2.**NO** : Repair or replace it. Refer to GROUP 00E, Harness Connector Inspection [P.00E-2](#). Then go to Step 8.**STEP 2. Check the heated oxygen sensor (rear).**

- (1) Disconnect heated oxygen sensor (rear) connector D-40 and connect test harness special tool, MB991658, to the connector on the heated oxygen sensor (rear) side.
- (2) Measure the resistance between heated oxygen sensor connector terminal No. 1 and terminal No. 2.

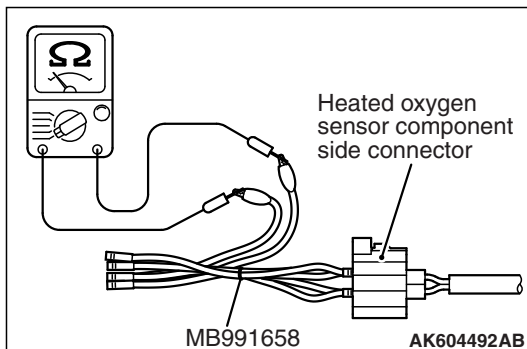
**Standard value: 4.5 –8.0 Ω [at 20° C (68° F)]****Q: Is the measured resistance between 4.5 and 8.0 Ω [at 20° C (68° F)]?****YES** : Go to Step 3.**NO** : Replace the heated oxygen sensor (rear). Then go to Step 8.**STEP 3. Check harness connector A-30X at MFI relay for damage.****Q: Is the harness connector in good condition?****YES** : Go to Step 4.**NO** : Repair or replace it. Refer to GROUP 00E, Harness Connector Inspection [P.00E-2](#). Then go to Step 8.**STEP 4. Check for short circuit to power supply between MFI relay connector A-30X (terminal No. 2) and heated oxygen sensor (rear) connector D-40 (terminal No. 1).**

*NOTE: Check harness after checking intermediate connectors C-38 and C-39. If intermediate connectors are damaged, repair or replace them. Refer to GROUP 00E, Harness Connector Inspection [P.00E-2](#). Then go to Step 8.*

**Q: Is the harness wire in good condition?****YES** : Go to Step 5.**NO** : Repair it. Then go to Step 8.



---

**STEP 5. Check harness connector B-108 at ECM for damage.**

**Q: Is the harness connector in good condition?**

**YES :** Go to Step 6.

**NO :** Repair or replace it. Refer to GROUP 00E, Harness Connector Inspection [P.00E-2](#). Then go to Step 8.

---

**STEP 6. Check for short circuit to power supply between heated oxygen sensor (rear) connector D-40 (terminal No. 2) and ECM connector B-108 (terminal No. 35).**

*NOTE: Check harness after checking intermediate connectors A-10 and C-37. If intermediate connectors are damaged, repair or replace them. Refer to GROUP 00E, Harness Connector Inspection [P.00E-2](#). Then go to Step 8.*

**Q: Is the harness wire in good condition?**

**YES :** Go to Step 7.

**NO :** Repair it. Then go to Step 8.

---

**STEP 7. Check the trouble symptoms.**

(1) Carry out a test drive with the drive cycle pattern. Refer to Diagnostic Function –OBD-II Drive Cycle –Pattern 2 [P.13B-12](#).

(2) Check the diagnostic trouble code (DTC).

**Q: Is DTC P0038 set?**

**YES :** Replace the ECM (Refer to, Removal and Installation [P.13B-1022](#)). Then go to Step 8.

**NO :** It can be assumed that this malfunction is intermittent. Refer to GROUP 00, How to Use Troubleshooting/Inspection Service Points –How to Cope with Intermittent Malfunctions [P.00-13](#).

---

**STEP 8. Test the OBD-II drive cycle.**

(1) Carry out a test drive with the drive cycle pattern. Refer to Diagnostic Function –OBD-II Drive Cycle –Pattern 2 [P.13B-12](#).

(2) Check the diagnostic trouble code (DTC).

**Q: Is DTC P0038 set?**

**YES :** Retry the troubleshooting.

**NO :** The inspection is complete.

DTC P0038: Heated Oxygen Sensor (rear) Heater Control Circuit High <Vehicles for California>

HEATED OXYGEN SENSOR (REAR) HEATER CONTROL CIRCUIT < VEHICLES FOR CALIFORNIA >

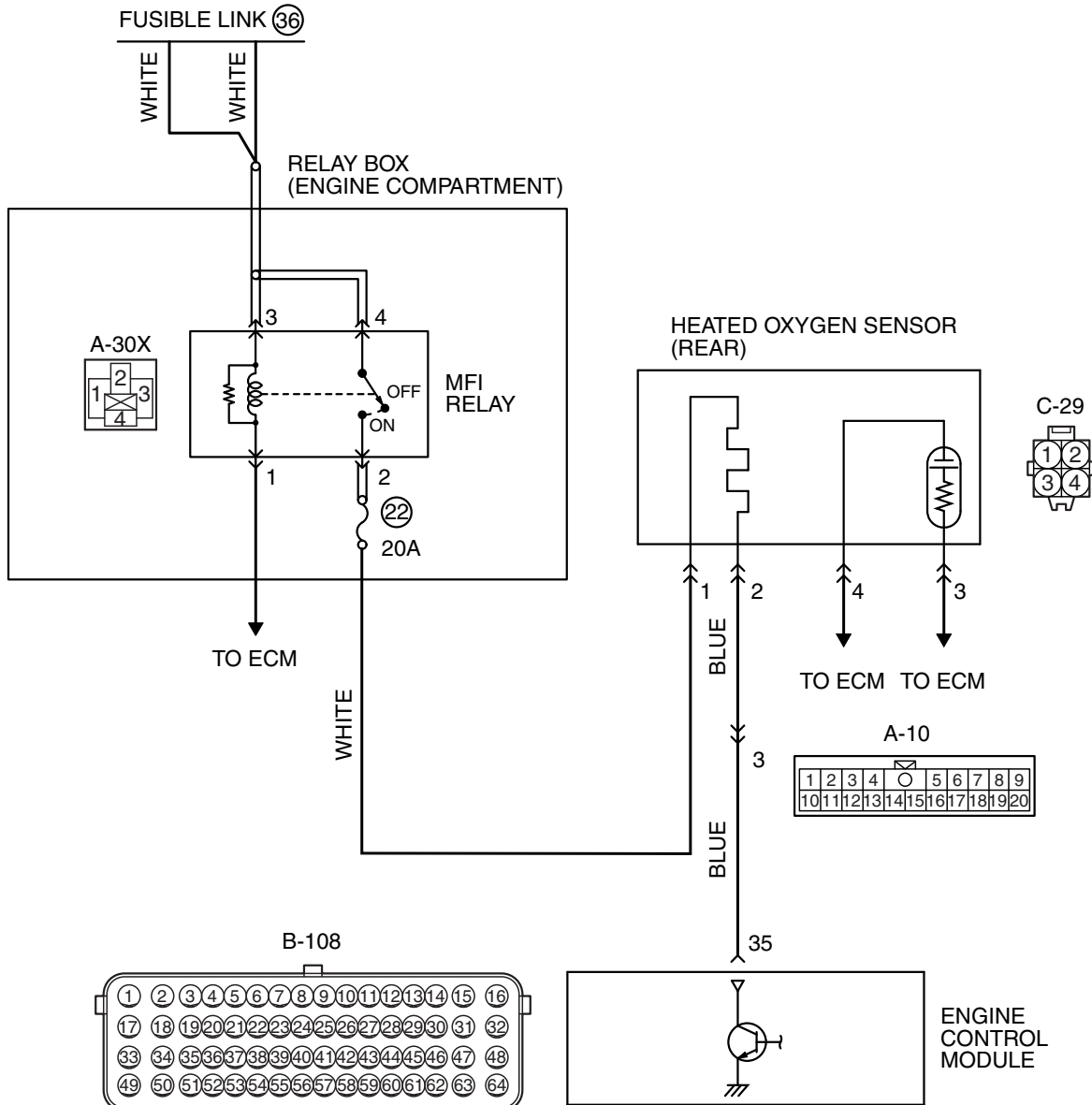

AK802010 AC

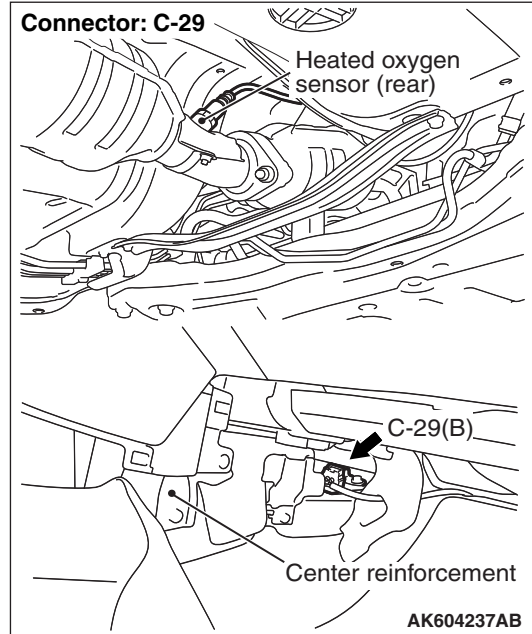
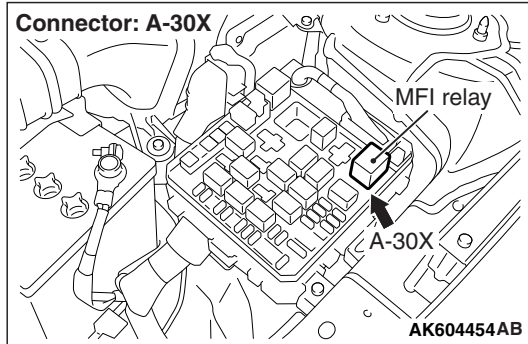
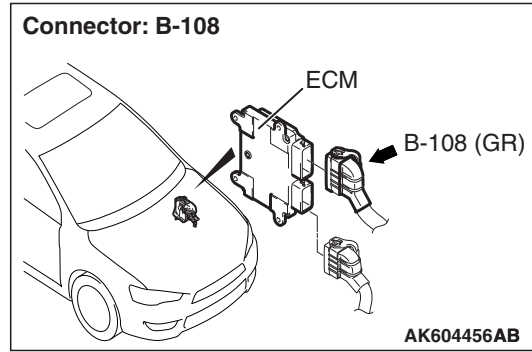
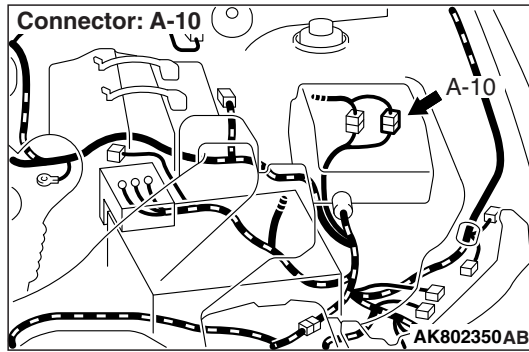

## CIRCUIT OPERATION

- Power is supplied from the MFI relay (terminal No. 2) to the heated oxygen sensor (rear) heater.
- The ECM (terminal No. 35) controls continuity to the heated oxygen sensor (rear) heater by turning the power transistor in the ECM "ON" and "OFF".

## TECHNICAL DESCRIPTION

- The ECM checks whether the heater current is within a specified range when the heater is energized.

## DESCRIPTIONS OF MONITOR METHODS

Heated oxygen sensor (rear) heater current is out of specified range.

## MONITOR EXECUTION

Continuous

## MONITOR EXECUTION CONDITIONS (Other monitor and Sensor)

**Other Monitor (There is no temporary DTC stored in memory for the item monitored below)**

- Not applicable

**Sensor (The sensor below is determined to be normal)**

- Not applicable

DTC SET CONDITIONS

Logic Flow Chart

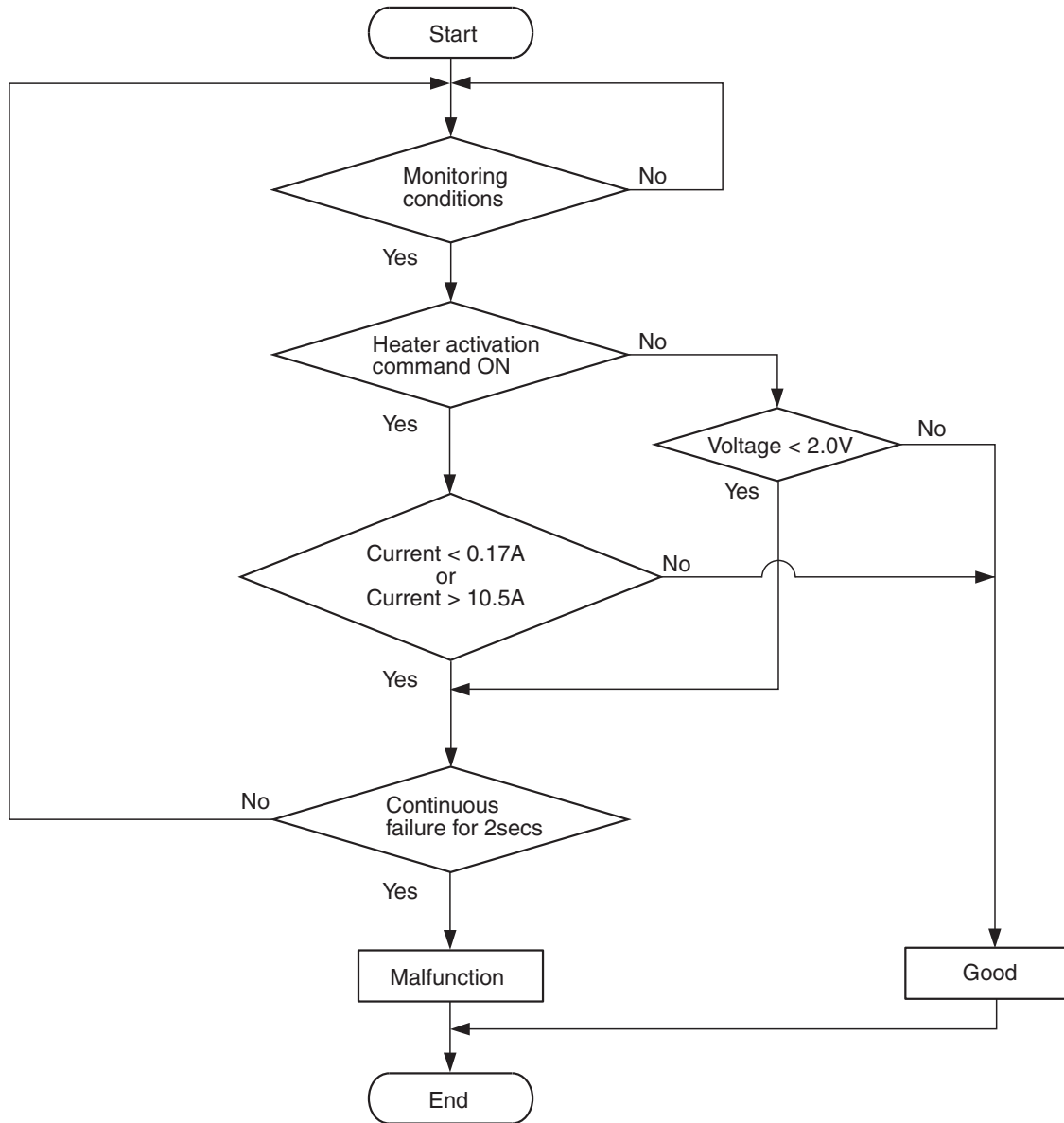

AK900352

**Check Conditions**

- More than 2 seconds have passed since the engine starting sequence was completed.
- While the heated oxygen sensor (rear) heater is on.
- Battery positive voltage is between 11 and 16.5 volts.

**Judgement Criterion**

- The heated oxygen sensor (rear) heater current is more than 10.5 amperes for 2 seconds.

**FAIL-SAFE AND BACKUP FUNCTION**

- None

**OBD-II DRIVE CYCLE PATTERN**

Refer to Diagnostic Function –OBD-II Drive Cycle – Pattern 2 P.13B-12.

**TROUBLESHOOTING HINTS (The most likely causes for this code to be set are:)**

- Shorted heated oxygen sensor (rear) heater circuit or connector damage.
- Heated oxygen sensor (rear) heater failed.
- ECM failed.

## DIAGNOSIS

### Required Special Tools:

- MB991958: Scan Tool (M.U.T-III Sub Assembly)
  - MB991824: V.C.I.
  - MB991827: USB Cable
  - MB991910: Main Harness A
- MB991658: Test Harness

**STEP 1. Check harness connector C-29 at heated oxygen sensor (rear) for damage.**

**Q: Is the harness connector in good condition?**

**YES :** Go to Step 2.

**NO :** Repair or replace it. Refer to GROUP 00E, Harness Connector Inspection [P.00E-2](#). Then go to Step 8.

**STEP 2. Check the heated oxygen sensor (rear).**

- (1) Disconnect heated oxygen sensor (rear) connector C-29 and connect test harness special tool, MB991658, to the connector on the heated oxygen sensor (rear) side.
- (2) Measure the resistance between heated oxygen sensor connector terminal No. 1 and terminal No. 2.

**Standard value: 4.5 –8.0  $\Omega$  [at 20° C (68° F)]**

**Q: Is the measured resistance between 4.5 and 8.0  $\Omega$  [at 20° C (68° F)]?**

**YES :** Go to Step 3.

**NO :** Replace the heated oxygen sensor (rear). Then go to Step 8.

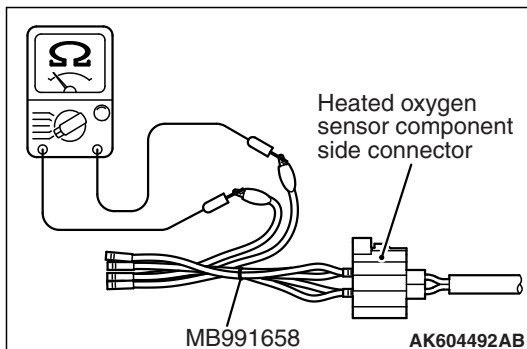

**STEP 3. Check harness connector A-30X at MFI relay for damage.**

**Q: Is the harness connector in good condition?**

**YES :** Go to Step 4.

**NO :** Repair or replace it. Refer to GROUP 00E, Harness Connector Inspection [P.00E-2](#). Then go to Step 8.

**STEP 4. Check for short circuit to power supply between MFI relay connector A-30X (terminal No. 2) and heated oxygen sensor (rear) connector C-29 (terminal No. 1).**

**Q: Is the harness wire in good condition?**

**YES :** Go to Step 5.

**NO :** Repair it. Then go to Step 8.

**STEP 5. Check harness connector B-108 at ECM for damage.**

**Q: Is the harness connector in good condition?**

**YES :** Go to Step 6.

**NO :** Repair or replace it. Refer to GROUP 00E, Harness Connector Inspection [P.00E-2](#). Then go to Step 8.

**STEP 6. Check for short circuit to power supply between heated oxygen sensor (rear) connector C-29 (terminal No. 2) and ECM connector B-108 (terminal No. 35).**

*NOTE: Check harness after checking intermediate connector A-10. If intermediate connector is damaged, repair or replace it. Refer to GROUP 00E, Harness Connector Inspection P.00E-2. Then go to Step 8.*

**Q: Is the harness wire in good condition?**

**YES** : Go to Step 7.

**NO** : Repair it. Then go to Step 8.

---

**STEP 7. Check the trouble symptoms.**

(1) Carry out a test drive with the drive cycle pattern. Refer to Diagnostic Function –OBD-II Drive Cycle –Pattern 2 P.13B-12.

(2) Check the diagnostic trouble code (DTC).

**Q: Is DTC P0038 set?**

**YES** : Replace the ECM (Refer to, Removal and Installation P.13B-1022). Then go to Step 8.

**NO** : It can be assumed that this malfunction is intermittent. Refer to GROUP 00, How to Use Troubleshooting/Inspection Service Points –How to Cope with Intermittent Malfunctions P.00-13.

---

**STEP 8. Test the OBD-II drive cycle.**

(1) Carry out a test drive with the drive cycle pattern. Refer to Diagnostic Function –OBD-II Drive Cycle –Pattern 2 P.13B-12.

(2) Check the diagnostic trouble code (DTC).

**Q: Is DTC P0038 set?**

**YES** : Retry the troubleshooting.

**NO** : The inspection is complete.



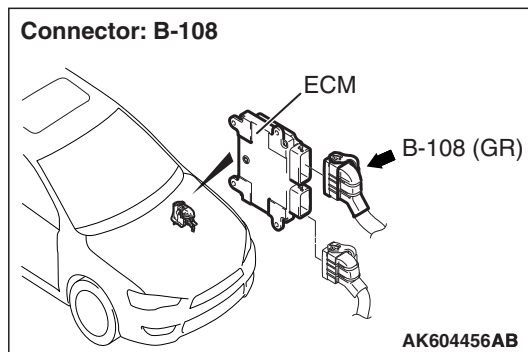
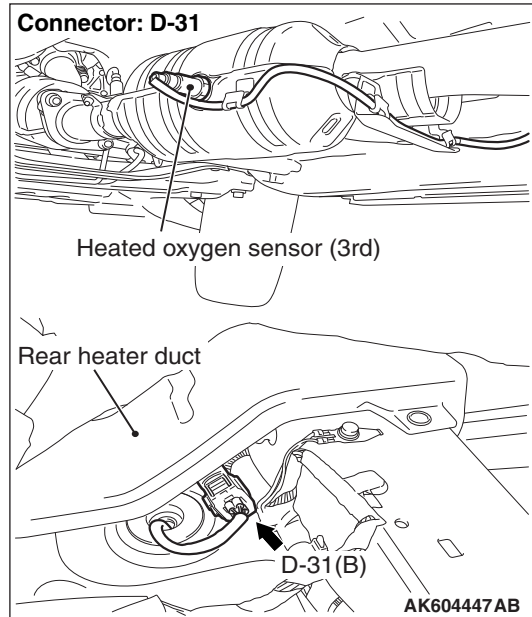
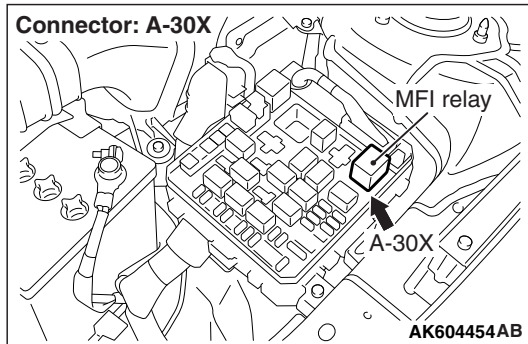
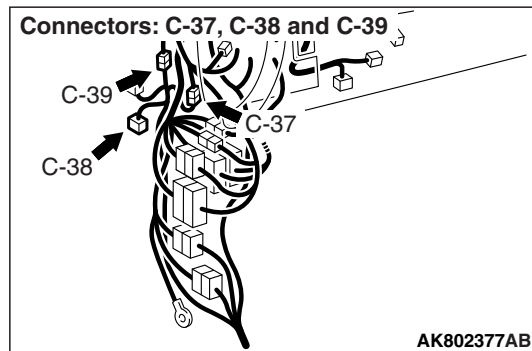
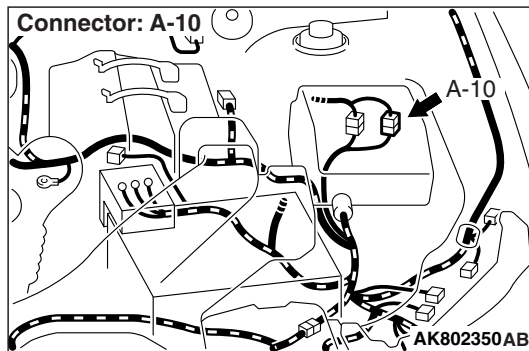

## CIRCUIT OPERATION

- Power is supplied from the MFI relay (terminal No. 2) to the heated oxygen sensor (3rd) heater.
- The ECM (terminal No. 33) controls continuity to the heated oxygen sensor (3rd) heater by turning the power transistor in the ECM "ON" and "OFF".

## TECHNICAL DESCRIPTION

- The ECM checks whether the heater current is within a specified range when the heater is energized.
- The ECM checks whether the heater voltage is within a specified range when the heater is not energized.

## DESCRIPTIONS OF MONITOR METHODS

Heated oxygen sensor (3rd) heater current or voltage is out of specified range.

## MONITOR EXECUTION

Continuous

## MONITOR EXECUTION CONDITIONS (Other monitor and Sensor)

**Other Monitor (There is no temporary DTC stored in memory for the item monitored below)**

- Not applicable

**Sensor (The sensor below is determined to be normal)**

- Not applicable



**DTC SET CONDITIONS**

**Logic Flow Chart**

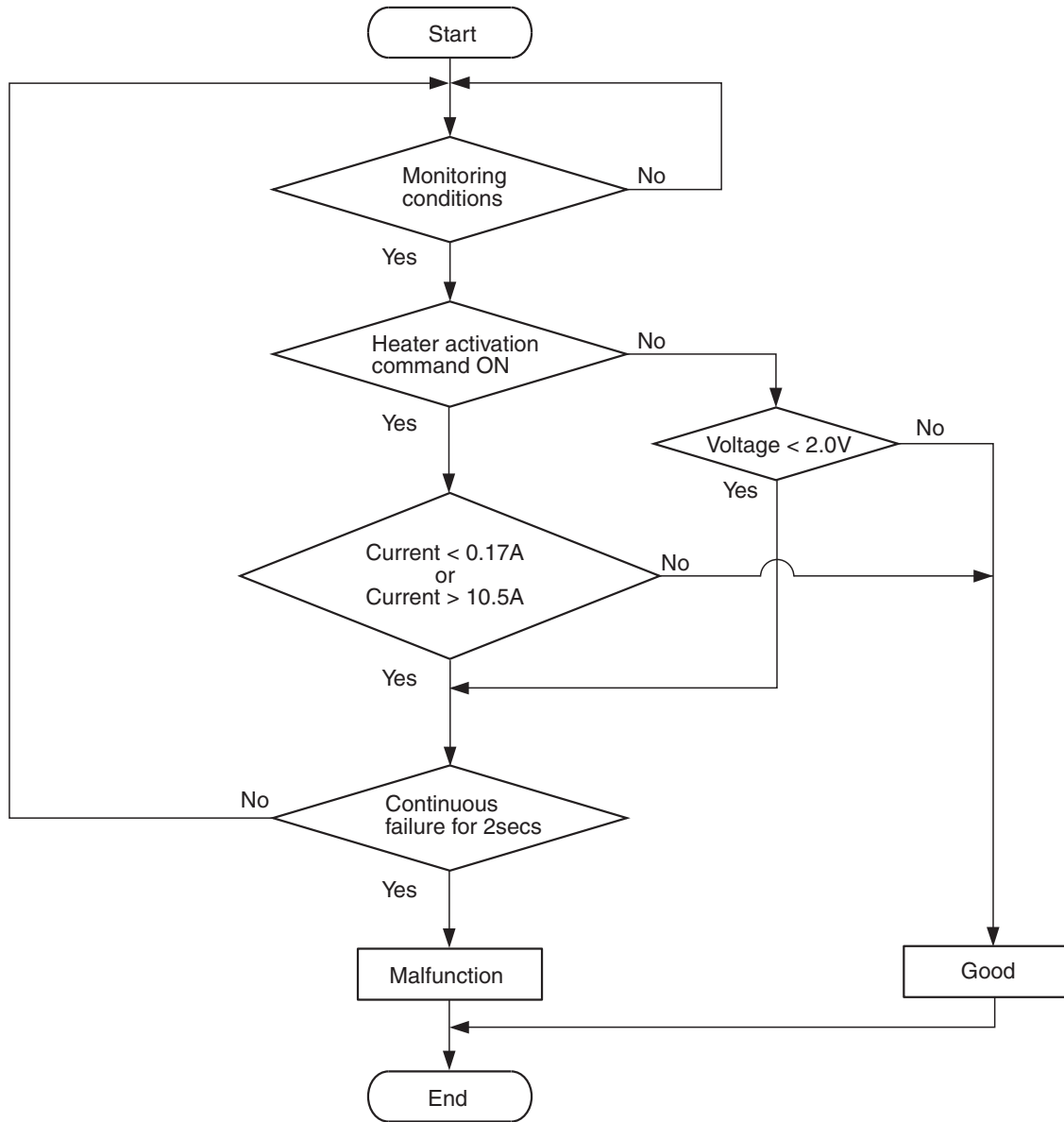

AK900352

**Check Conditions**

- More than 2 seconds have passed since the engine starting sequence was completed.
- While the heated oxygen sensor (3rd) heater is on.
- Battery positive voltage is between 11 and 16.5 volts.

**Judgement Criterion**

- The heated oxygen sensor (3rd) heater current is less than 0.17 ampere for 2 seconds.

**Check Conditions**

- More than 2 seconds have passed since the engine starting sequence was completed.

- While the heated oxygen sensor (3rd) heater is off.
- Battery positive voltage is between 11 and 16.5 volts.

**Judgement Criterion**

- The heated oxygen sensor (3rd) heater voltage is less than 2.0 volts for 2 seconds.

**FAIL-SAFE AND BACKUP FUNCTION**

- None

**OBD-II DRIVE CYCLE PATTERN**

Refer to Diagnostic Function –OBD-II Drive Cycle –  
Pattern 2 [P.13B-12](#).

**TROUBLESHOOTING HINTS (The most likely causes for this code to be set are:)**

- Open or shorted heated oxygen sensor (3rd) heater circuit, harness damage or connector damage.
- Heated oxygen sensor (3rd) heater failed.
- ECM failed.

**DIAGNOSIS****Required Special Tools:**

- MB991958: Scan Tool (M.U.T-III Sub Assembly)
  - MB991824: V.C.I.
  - MB991827: USB Cable
  - MB991910: Main Harness A
- MB991658: Test Harness
- MB992110: Power Plant ECU Check Harness

**STEP 1. Check harness connector D-31 at heated oxygen sensor (3rd) for damage.****Q: Is the harness connector in good condition?**

**YES** : Go to Step 2.

**NO** : Repair or replace it. Refer to GROUP 00E, Harness Connector Inspection [P.00E-2](#). Then go to Step 11.

**STEP 2. Check the heated oxygen sensor (3rd).**

- (1) Disconnect heated oxygen sensor (3rd) connector D-31 and connect test harness special tool, MB991658, to the connector on the heated oxygen sensor (3rd) side.
- (2) Measure the resistance between heated oxygen sensor connector terminal No. 1 and terminal No. 2.

**Standard value: 11 –18  $\Omega$  [at 20° C (68° F)]**

**Q: Is the measured resistance between 11 and 18  $\Omega$  [at 20° C (68° F)]?**

**YES** : Go to Step 3.

**NO** : Replace the heated oxygen sensor (3rd). Then go to Step 11.

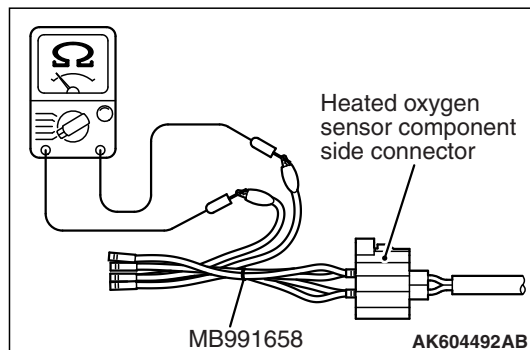

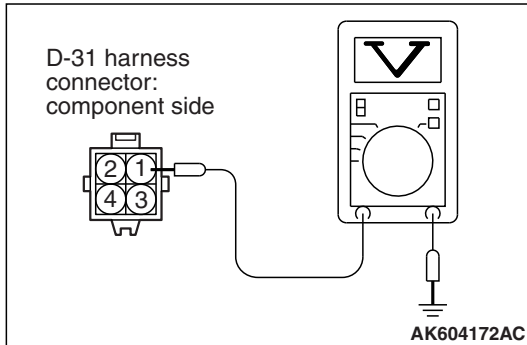

**STEP 3. Measure the power supply voltage at heated oxygen sensor (3rd) harness side connector D-31.**

- (1) Disconnect the connector D-31 and measure at the harness side.
- (2) Turn the ignition switch to the "ON" position.
- (3) Measure the voltage between terminal No. 1 and ground.
  - Voltage should be battery positive voltage.
- (4) Turn the ignition switch to the "LOCK" (OFF) position.

**Q: Is battery positive voltage (approximately 12 volts) present?**

**YES :** Go to Step 5.

**NO :** Go to Step 4.

**STEP 4. Check harness connector A-30X at MFI relay for damage.**

**Q: Is the harness connector in good condition?**

**YES :** Check harness connector C-38 and C-39 at intermediate connectors for damage, and repair or replace as required. Refer to GROUP 00E, Harness Connector Inspection [P.00E-2](#). If intermediate connectors are in good condition, repair harness wire between MFI relay connector A-30X (terminal No. 2) and heated oxygen sensor (3rd) connector D-31 (terminal No. 1) because of open circuit or short circuit to ground. Then go to Step 11.

**NO :** Repair or replace it. Refer to GROUP 00E, Harness Connector Inspection [P.00E-2](#). Then go to Step 11.

**STEP 5. Check harness connector B-108 at ECM for damage.**

**Q: Is the harness connector in good condition?**

**YES :** Go to Step 6.

**NO :** Repair or replace it. Refer to GROUP 00E, Harness Connector Inspection [P.00E-2](#). Then go to Step 11.

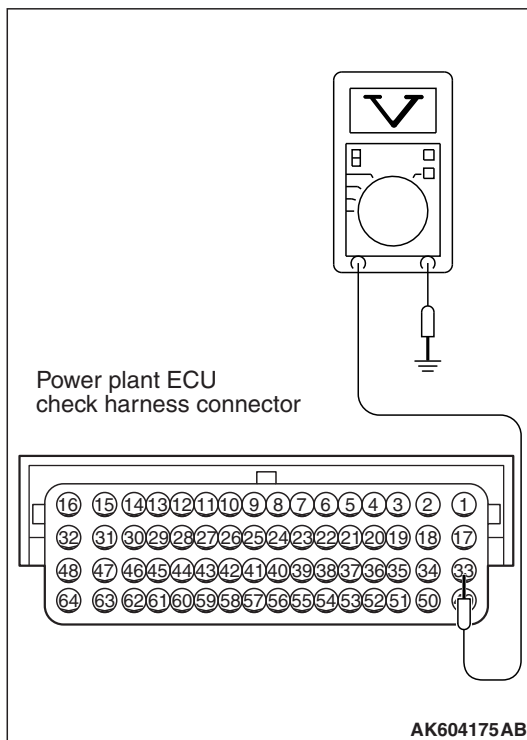
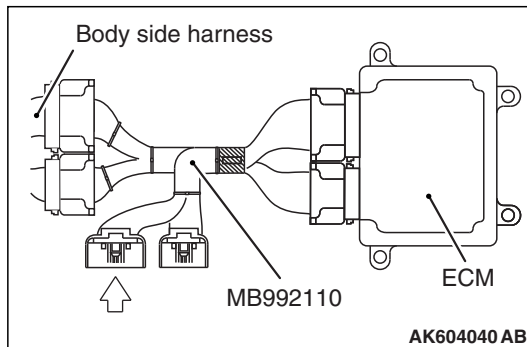

**STEP 6. Measure the power supply voltage at ECM connector B-108 by using power plant ECU check harness special tool MB992110.**

- (1) Disconnect all ECM connectors. Connect the power plant ECU check harness special tool MB992110 between the separated connectors.
- (2) Turn the ignition switch to the "ON" position.

- (3) Measure the voltage between terminal No. 33 and ground.
  - Voltage should be battery positive voltage.
- (4) Turn the ignition switch to the "LOCK" (OFF) position.

**Q: Is battery positive voltage (approximately 12 volts) present?**

**YES :** Go to Step 7.

**NO :** Check harness connectors A-10 and C-37 at intermediate connectors for damage, and repair or replace as required. Refer to GROUP 00E, Harness Connector Inspection [P.00E-2](#). If intermediate connectors are in good condition, repair harness wire between heated oxygen sensor (rear) connector D-31 (terminal No. 2) and ECM connector B-108 (terminal No. 33) because of open circuit or short circuit to ground. Then go to Step 11.

**STEP 7. Check harness connector A-30X at MFI relay for damage.**

**Q: Is the harness connector in good condition?**

**YES :** Go to Step 8.

**NO :** Repair or replace it. Refer to GROUP 00E, Harness Connector Inspection [P.00E-2](#). Then go to Step 11.

---

**STEP 8. Check for harness damage between MFI relay connector A-30X (terminal No. 2) and heated oxygen sensor (3rd) connector D-31 (terminal No. 1).**

*NOTE: Check harness after checking intermediate connectors C-38 and C-39. If intermediate connectors are damaged, repair or replace them. Refer to GROUP 00E, Harness Connector Inspection P.00E-2. Then go to Step 11.*

**Q: Is the harness wire in good condition?**

**YES :** Go to Step 9.

**NO :** Repair it. Then go to Step 11.

---

**STEP 9. Check for harness damage between heated oxygen sensor (3rd) connector D-31 (terminal No. 2) and ECM connector B-108 (terminal No. 33).**

*NOTE: Check harness after checking intermediate connectors A-10 and C-37. If intermediate connectors are damaged, repair or replace them. Refer to GROUP 00E, Harness Connector Inspection P.00E-2. Then go to Step 11.*

**Q: Is the harness wire in good condition?**

**YES :** Go to Step 10.

**NO :** Repair it. Then go to Step 11.

---

**STEP 10. Check the trouble symptoms.**

(1) Carry out a test drive with the drive cycle pattern. Refer to Diagnostic Function –OBD-II Drive Cycle –Pattern 2 P.13B-12.

(2) Check the diagnostic trouble code (DTC).

**Q: Is DTC P0043 set?**

**YES :** Replace the ECM (Refer to, Removal and Installation P.13B-1022). Then go to Step 11.

**NO :** It can be assumed that this malfunction is intermittent. Refer to GROUP 00, How to Use Troubleshooting/Inspection Service Points –How to Cope with Intermittent Malfunctions P.00-13.

---

**STEP 11. Test the OBD-II drive cycle.**

(1) Carry out a test drive with the drive cycle pattern. Refer to Diagnostic Function –OBD-II Drive Cycle –Pattern 2 P.13B-12.

(2) Check the diagnostic trouble code (DTC).

**Q: Is DTC P0043 set?**

**YES :** Retry the troubleshooting.

**NO :** The inspection is complete.

DTC P0044: Heated Oxygen Sensor (3rd) Heater Control Circuit High <Vehicles for California>

HEATED OXYGEN SENSOR (3RD) HEATER CIRCUIT <VEHICLES FOR CALIFORNIA>

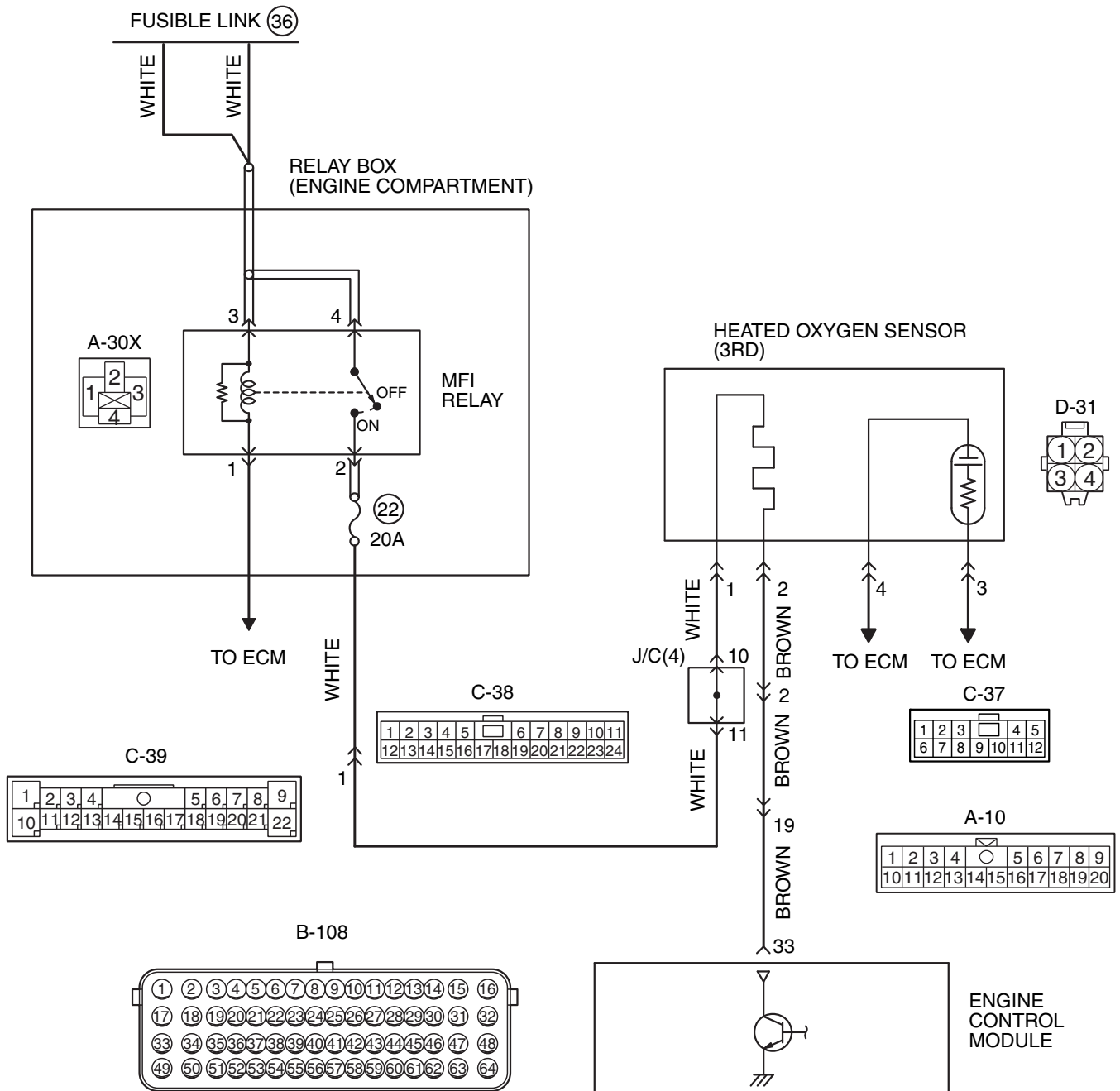

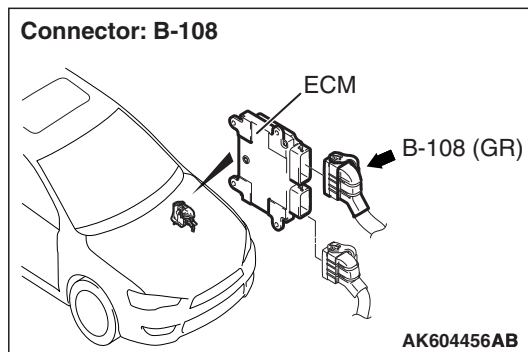
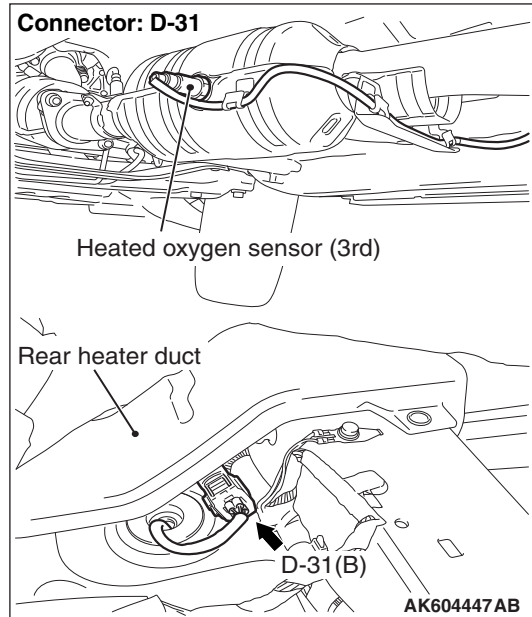
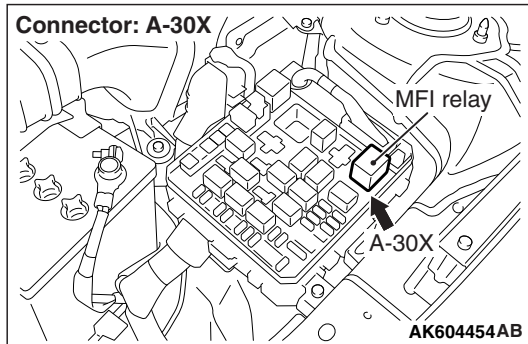
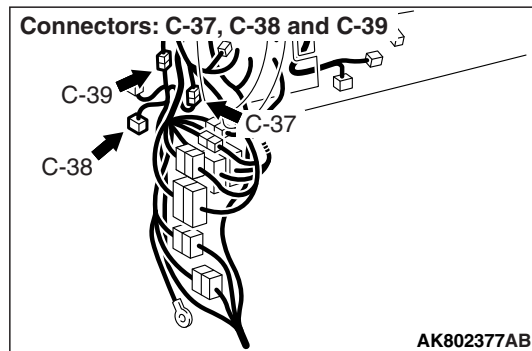
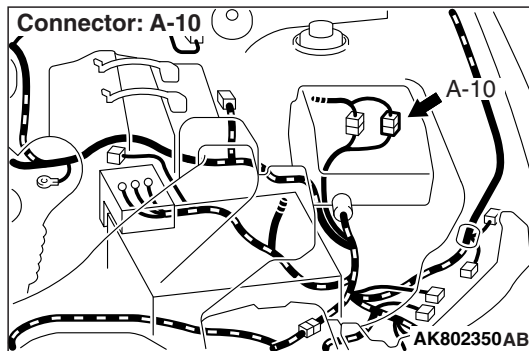

## CIRCUIT OPERATION

- Power is supplied from the MFI relay (terminal No. 2) to the heated oxygen sensor (3rd) heater.
- The ECM (terminal No. 33) controls continuity to the heated oxygen sensor (3rd) heater by turning the power transistor in the ECM "ON" and "OFF".

## TECHNICAL DESCRIPTION

- The ECM checks whether the heater current is within a specified range when the heater is energized.

## DESCRIPTIONS OF MONITOR METHODS

Heated oxygen sensor (3rd) heater current is out of specified range.

## MONITOR EXECUTION

Continuous

## MONITOR EXECUTION CONDITIONS (Other monitor and Sensor)

**Other Monitor (There is no temporary DTC stored in memory for the item monitored below)**

- Not applicable

**Sensor (The sensor below is determined to be normal)**

- Not applicable

DTC SET CONDITIONS

Logic Flow Chart

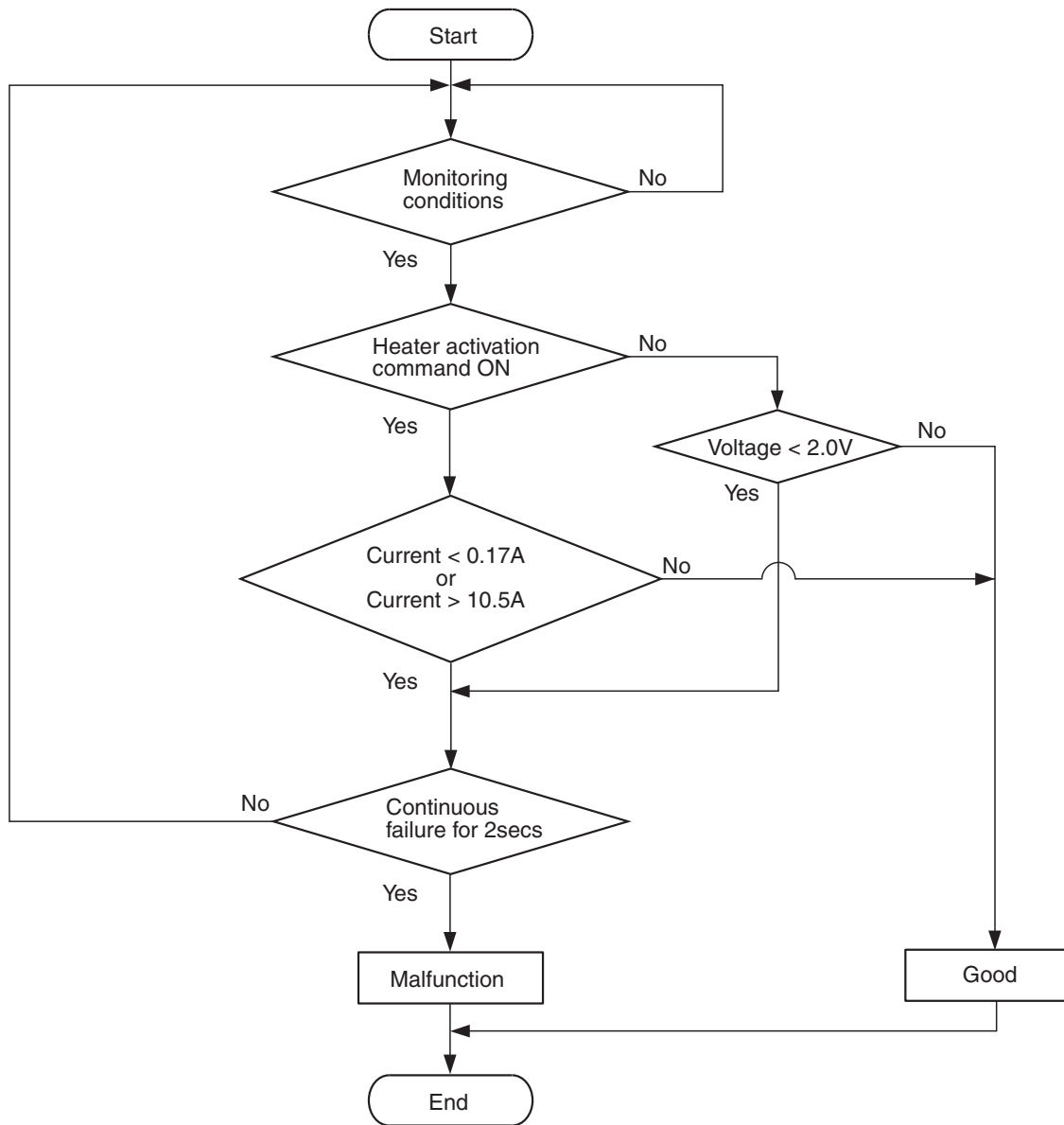

AK900352

**Check Conditions**

- More than 2 seconds have passed since the engine starting sequence was completed.
- While the heated oxygen sensor (3rd) heater is on.
- Battery positive voltage is between 11 and 16.5 volts.

**Judgement Criterion**

- The heated oxygen sensor (3rd) heater current is more than 10.5 amperes for 2 seconds.

**FAIL-SAFE AND BACKUP FUNCTION**

- None

**OBD-II DRIVE CYCLE PATTERN**

Refer to Diagnostic Function –OBD-II Drive Cycle – Pattern 2 P.13B-12.

**TROUBLESHOOTING HINTS (The most likely causes for this code to be set are:)**

- Shorted heated oxygen sensor (3rd) heater circuit or connector damage.
- Heated oxygen sensor (3rd) heater failed.
- ECM failed.



## DIAGNOSIS

### Required Special Tools:

- MB991958: Scan Tool (M.U.T-III Sub Assembly)
  - MB991824: V.C.I.
  - MB991827: USB Cable
  - MB991910: Main Harness A
- MB991658: Test Harness

---

### STEP 1. Check harness connector D-31 at heated oxygen sensor (3rd) for damage.

#### Q: Is the harness connector in good condition?

**YES** : Go to Step 2.

**NO** : Repair or replace it. Refer to GROUP 00E, Harness Connector Inspection [P.00E-2](#). Then go to Step 8.

---

### STEP 2. Check the heated oxygen sensor (3rd).

- (1) Disconnect heated oxygen sensor (3rd) connector D-31 and connect test harness special tool, MB991658, to the connector on the heated oxygen sensor (3rd) side.
- (2) Measure the resistance between heated oxygen sensor connector terminal No. 1 and terminal No. 2.

**Standard value: 11 –18  $\Omega$  [at 20° C (68° F)]**

#### Q: Is the measured resistance between 11 and 18 $\Omega$ [at 20° C (68° F)]?

**YES** : Go to Step 3.

**NO** : Replace the heated oxygen sensor (3rd). Then go to Step 8.

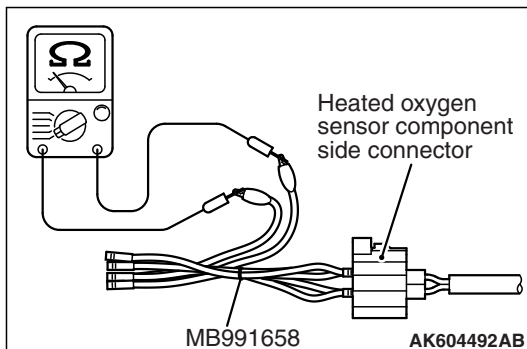

---

### STEP 3. Check harness connector A-30X at MFI relay for damage.

#### Q: Is the harness connector in good condition?

**YES** : Go to Step 4.

**NO** : Repair or replace it. Refer to GROUP 00E, Harness Connector Inspection [P.00E-2](#). Then go to Step 8.

---

### STEP 4. Check for short circuit to power supply between MFI relay connector A-30X (terminal No. 2) and heated oxygen sensor (3rd) connector D-31 (terminal No. 1).

*NOTE: Check harness after checking intermediate connectors C-38 and C-39. If intermediate connectors are damaged, repair or replace them. Refer to GROUP 00E, Harness Connector Inspection [P.00E-2](#). Then go to Step 8.*

#### Q: Is the harness wire in good condition?

**YES** : Go to Step 5.

**NO** : Repair it. Then go to Step 8.

---

**STEP 5. Check harness connector B-108 at ECM for damage.**

**Q: Is the harness connector in good condition?**

**YES :** Go to Step 6.

**NO :** Repair or replace it. Refer to GROUP 00E, Harness Connector Inspection [P.00E-2](#). Then go to Step 8.

---

**STEP 6. Check for short circuit to power supply between heated oxygen sensor (3rd) connector D-31 (terminal No. 2) and ECM connector B-108 (terminal No. 33).**

*NOTE: Check harness after checking intermediate connectors A-10 and C-37. If intermediate connectors are damaged, repair or replace them. Refer to GROUP 00E, Harness Connector Inspection [P.00E-2](#). Then go to Step 8.*

**Q: Is the harness wire in good condition?**

**YES :** Go to Step 7.

**NO :** Repair it. Then go to Step 8.

---

**STEP 7. Check the trouble symptoms.**

(1) Carry out a test drive with the drive cycle pattern. Refer to Diagnostic Function –OBD-II Drive Cycle –Pattern 2 [P.13B-12](#).

(2) Check the diagnostic trouble code (DTC).

**Q: Is DTC P0044 set?**

**YES :** Replace the ECM (Refer to, Removal and Installation [P.13B-1022](#)). Then go to Step 8.

**NO :** It can be assumed that this malfunction is intermittent. Refer to GROUP 00, How to Use Troubleshooting/Inspection Service Points –How to Cope with Intermittent Malfunctions [P.00-13](#).

---

**STEP 8. Test the OBD-II drive cycle.**

(1) Carry out a test drive with the drive cycle pattern. Refer to Diagnostic Function –OBD-II Drive Cycle –Pattern 2 [P.13B-12](#).

(2) Check the diagnostic trouble code (DTC).

**Q: Is DTC P0044 set?**

**YES :** Retry the troubleshooting.

**NO :** The inspection is complete.

---

**DTC P0069: Abnormal Correlation Between Manifold Absolute Pressure Sensor And Barometric Pressure Sensor**

---

**TECHNICAL DESCRIPTION**

- The ECM detects abnormality in the sensor by comparing the manifold absolute pressure sensor output with the barometric pressure sensor output.

**DESCRIPTIONS OF MONITOR METHODS**

The ECM compares the manifold absolute pressure sensor output with the barometric pressure sensor output while the engine control relay is in "ON" position after the ignition switch is in "LOCK" (OFF) position. When the difference exceeds the specified value between them, the ECM determines whether the manifold absolute pressure sensor / the barometric pressure sensor has malfunction or not.

**MONITOR EXECUTION**

Continuous

**MONITOR EXECUTION CONDITIONS  
(Other monitor and Sensor)**

**Other Monitor (There is no temporary DTC stored in memory for the item monitored below)**

- Not applicable

**Sensor (The sensor below is determined to be normal)**

- Mass airflow sensor
- Engine coolant temperature sensor
- Intake air temperature sensor
- Barometric pressure sensor
- Throttle position sensor
- Manifold absolute pressure sensor

DTC SET CONDITIONS

Logic Flow Chart

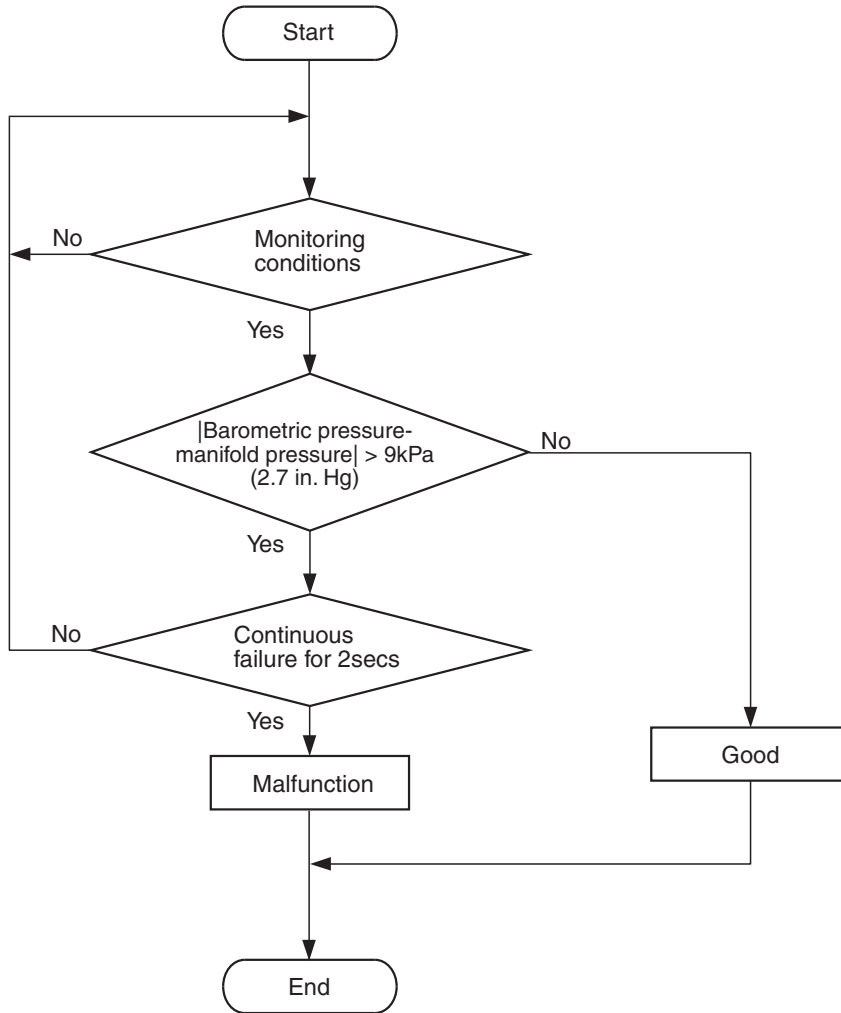

AK704095

**Check Conditions**

- Ignition switch is in "LOCK" (OFF) position.
- After 2 seconds pass from the time when the engine is stopped.
- Engine coolant temperature is more than 0° C (32° F).

**Judgement Criterion**

- Difference between barometric pressure sensor output and manifold absolute pressure sensor output is more than 9 kPa (2.7 in.Hg) for 2 seconds.

**FAIL-SAFE AND BACKUP FUNCTION**

- None

**OBD-II DRIVE CYCLE PATTERN**

None.

**TROUBLESHOOTING HINTS (The most likely causes for this code to be set are:)**

- Manifold absolute pressure sensor failed.
- Barometric pressure sensor failed.
- ECM failed.

## DIAGNOSIS

### Required Special Tool:

- MB991958: Scan Tool (M.U.T.-III Sub Assembly)
  - MB991824: V.C.I.
  - MB991827: USB Cable
  - MB991910: Main Harness A

**STEP 1. Using scan tool MB991958, read the diagnostic trouble code (DTC).**

### **⚠ CAUTION**

To prevent damage to scan tool MB991958, always turn the ignition switch to the "LOCK" (OFF) position before connecting or disconnecting scan tool MB991958.

- (1) Connect scan tool MB991958 to the data link connector.
- (2) Turn the ignition switch to the "ON" position.
- (3) Set scan tool MB991958, read the DTC.
- (4) Turn the ignition switch to the "LOCK" (OFF) position.

**Q: Is the diagnostic trouble code other than P0069 set?**

**YES :** Refer to, Diagnostic Trouble Code Chart [P.13B-51](#).

**NO :** Go to Step 2.

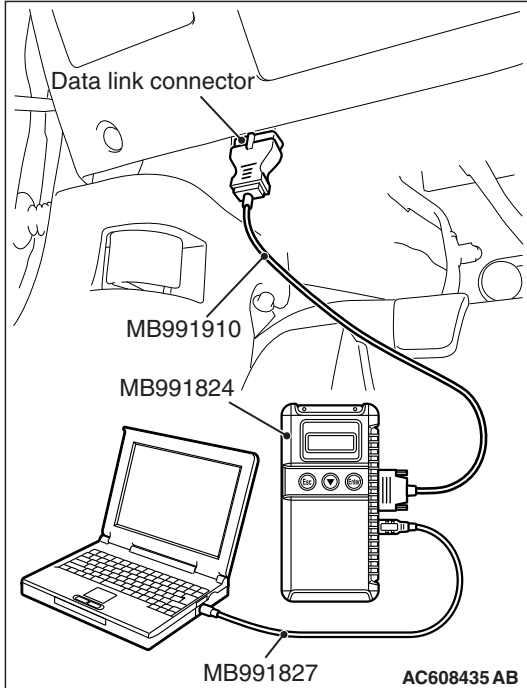

**STEP 2. Using scan tool MB991958, check data list item 8: Manifold Absolute Pressure Sensor.**

- (1) Turn the ignition switch to the "ON" position.
- (2) Set scan tool MB991958 to the data reading mode for item 8, Manifold Absolute Pressure Sensor.
  - When altitude is 0 m (0 foot), 101 kPa (29.8 in.Hg).
  - When altitude is 600 m (1,969 feet), 95 kPa (28.1 in.Hg).
  - When altitude is 1,200 m (3,937 feet), 88 kPa (26.0 in.Hg).
  - When altitude is 1,800 m (5,906 feet), 81 kPa (23.9 in.Hg).
- (3) Start the engine.
  - Warm up the engine. When the engine is idling, 16 –36 kPa (4.7 –10.6 in.Hg).
  - When the engine is suddenly revved, manifold absolute pressure varies.
- (4) Turn the ignition switch to the "LOCK" (OFF) position.

**Q: Is the sensor operating properly?****YES :** Go to Step 3.**NO :** Refer to, DTC P0106 –Manifold Absolute Pressure Circuit Range/Performance Problem [P.13B-170](#), DTC P0107 –Manifold Absolute Pressure Circuit Low Input [P.13B-179](#), DTC P0108 –Manifold Absolute Pressure Circuit High Input [P.13B-187](#).

---

**STEP 3. Using scan tool MB991958, read the diagnostic trouble code (DTC).**

- (1) Turn the ignition switch to the "ON" position.
- (2) Erase the DTC.
- (3) Start the engine.
- (4) Turn the ignition switch to "LOCK" (OFF) position and then wait 2 seconds.
- (5) Turn the ignition switch to the "ON" position.
- (6) Set scan tool MB991958, read the DTC.
- (7) Turn the ignition switch to the "LOCK" (OFF) position.

**Q: Is DTC P0069 set?****YES :** Replace the ECM (Refer to, Removal and Installation [P.13B-1022](#)). Then go to Step 4.**NO :** It can be assumed that this malfunction is intermittent. Refer to GROUP 00, How to Use Troubleshooting/Inspection Service Points –How to Cope with Intermittent Malfunctions [P.00-13](#).

**STEP 4. Using scan tool MB991958, read the diagnostic trouble code (DTC).**

- (1) Turn the ignition switch to the "ON" position.
- (2) Erase the DTC.
- (3) Start the engine.
- (4) Turn the ignition switch to "LOCK" (OFF) position and then wait 2 seconds.
- (5) Turn the ignition switch to the "ON" position.
- (6) Set scan tool MB991958, read the DTC.
- (7) Turn the ignition switch to the "LOCK" (OFF) position.

**Q: Is DTC P0069 set?**

**YES** : Retry the troubleshooting.

**NO** : The inspection is complete.

DTC P0101: Mass Airflow Circuit Range/Performance Problem

MASS AIRFLOW SENSOR CIRCUIT

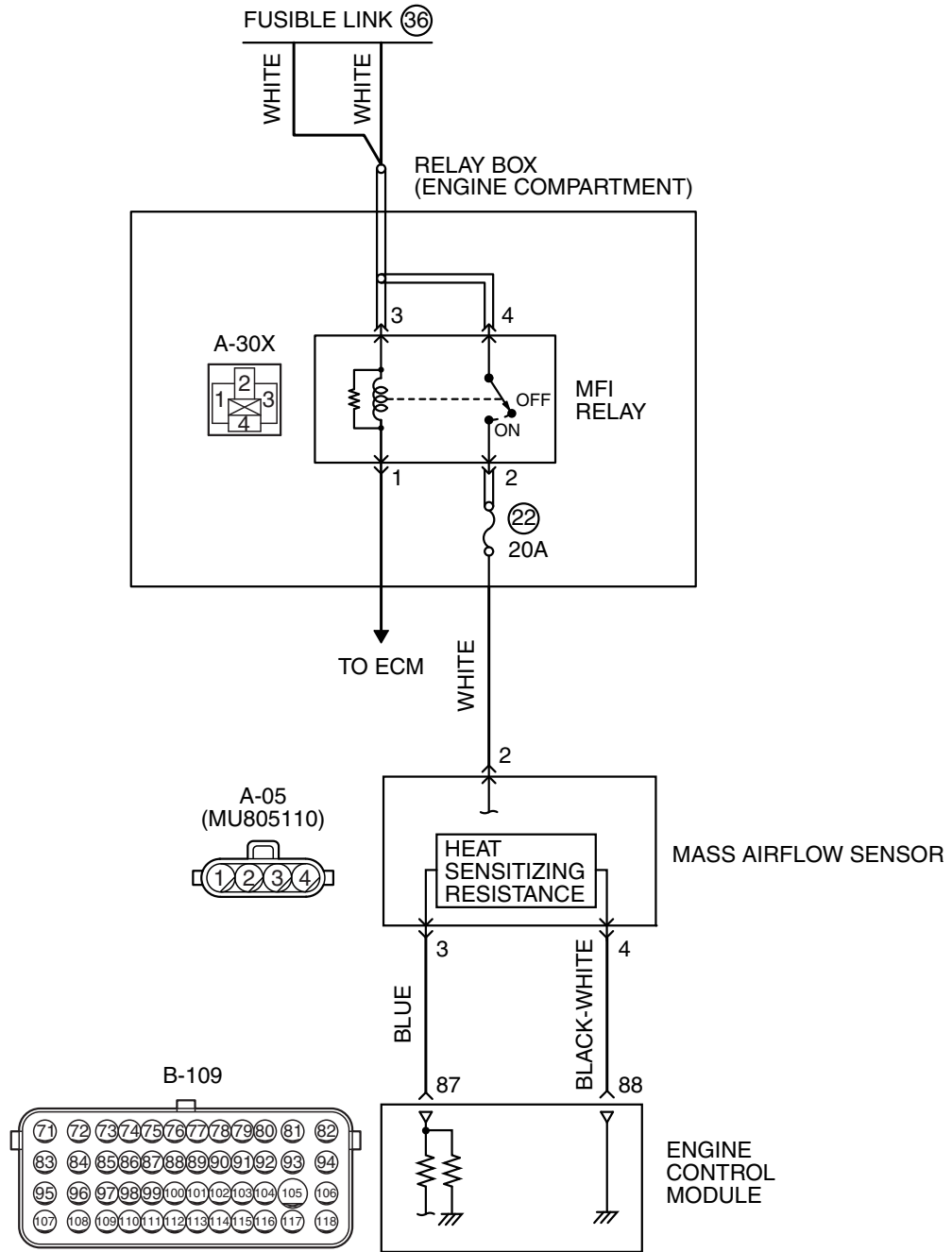

AK604114 AB



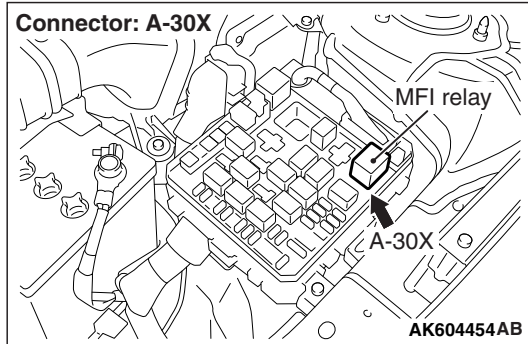
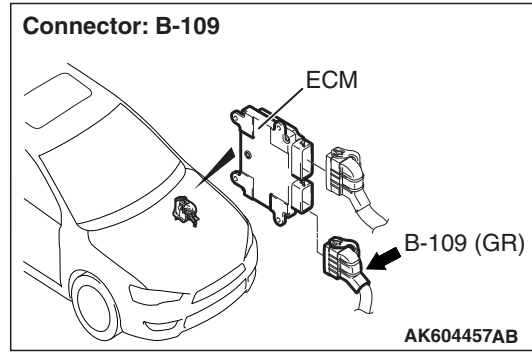
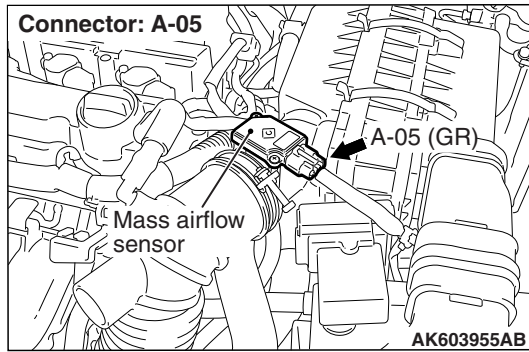

## CIRCUIT OPERATION

- The mass airflow sensor power is supplied from the MFI relay (terminal No. 2), and the ground is provided on the ECM (terminal No. 88).
- A voltage that is according to the mass airflow rate is sent to the ECM (terminal No. 87) from the mass airflow sensor output terminal (terminal No. 3).

## TECHNICAL DESCRIPTION

- While the engine is running, the mass airflow sensor outputs electric current which corresponds to the mass airflow rate.
- The ECM converts the electric current into the voltage and checks whether the voltage is within a specified range while the engine is running.

## DESCRIPTIONS OF MONITOR METHODS

Compare load value with mass airflow sensor output voltage.

## MONITOR EXECUTION

Continuous

## MONITOR EXECUTION CONDITIONS (Other monitor and Sensor)

**Other Monitor (There is no temporary DTC stored in memory for the item monitored below)**

- Not applicable

**Sensor (The sensor below is determined to be normal)**

- Throttle position sensor

## DTC SET CONDITIONS &lt;Range/Performance problem –high&gt;

## Logic Flow Chart

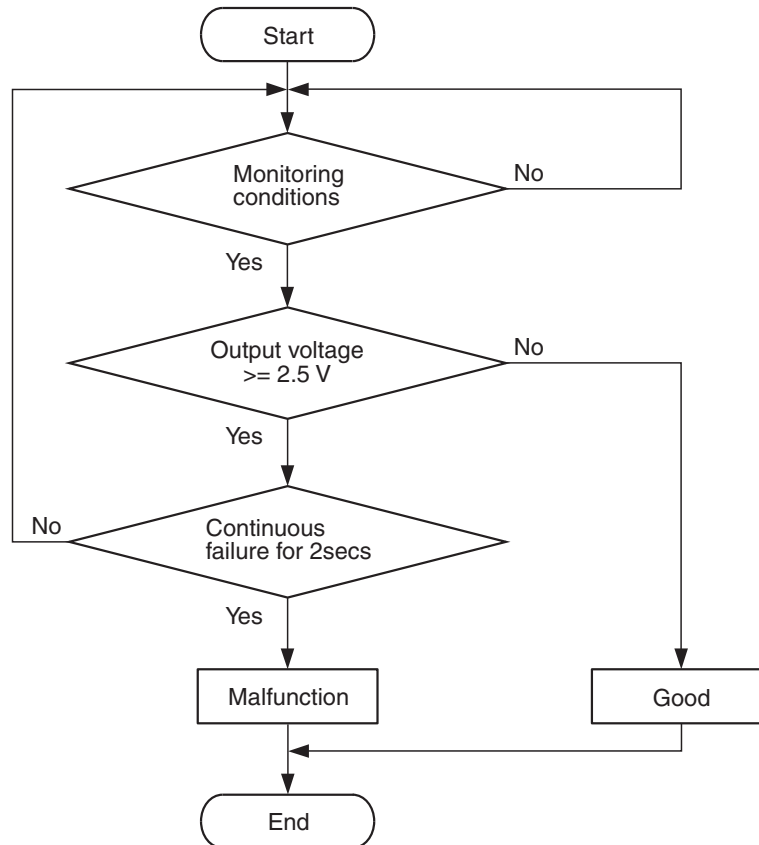

AK900353

**Check Conditions**

- Throttle position sensor output voltage is less than 0.8 volt.
- Mass airflow sensor output voltage is less than 4.9 volts (corresponding to an air flow rate of 295 g/sec).

**Judgement Criterion**

- Mass airflow sensor output voltage is more than 2.5 volts (corresponding to an air flow rate of 28 g/sec) for 2 seconds.

DTC SET CONDITIONS <Range/Performance problem –low >

Logic Flow Chart

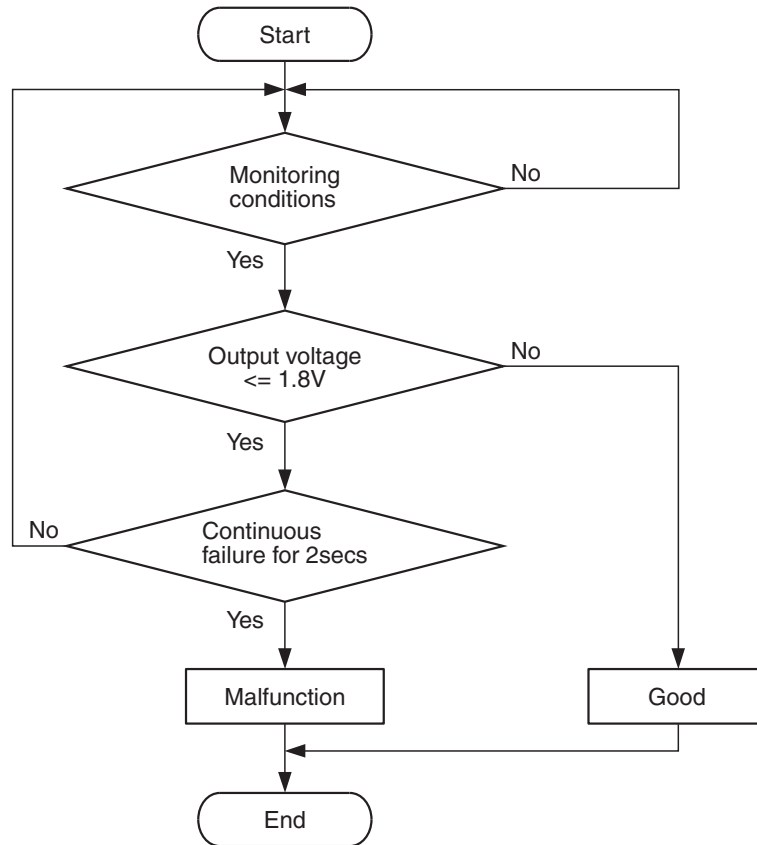

AK604309

**Check Conditions**

- Throttle position sensor output voltage is more than 1.5 volts.
- Mass airflow sensor output voltage is more than 0.2 volt (corresponding to an air flow rate of 0 g/sec).
- Engine speed is more than 1,500 r/min.

**Judgement Criterion**

- Mass airflow sensor output voltage is less than 1.8 volts (corresponding to an air flow rate of 8 g/sec) for 2 seconds.

**FAIL-SAFE AND BACKUP FUNCTION**

- Fuel control is carried out using throttle opening degree and engine speed in accordance with pre-set map.

**OBD-II DRIVE CYCLE PATTERN**

Refer to Diagnostic Function –OBD-II Drive Cycle – Pattern 7 P.13B-12.

**TROUBLESHOOTING HINTS (The most likely causes for this code to be set are:)**

- Mass airflow sensor failed.
- Mass airflow sensor circuit harness damage, or connector damage.
- ECM failed.

**DIAGNOSIS****Required Special Tool:**

- MB991958: Scan Tool (M.U.T.-III Sub Assembly)
  - MB991824: V.C.I.
  - MB991827: USB Cable
  - MB991910: Main Harness A

**STEP 1. Using scan tool MB991958, check data list item 10: Mass Airflow Sensor.****⚠ CAUTION**

To prevent damage to scan tool MB991958, always turn the ignition switch to the "LOCK" (OFF) position before connecting or disconnecting scan tool MB991958.

- (1) Connect scan tool MB991958 to the data link connector.
- (2) Start the engine and run at idle.
- (3) Set scan tool MB991958 to the data reading mode for item 10, Mass Airflow Sensor.
- (4) Warm up the engine to normal operating temperature: 80° C to 95° C (176° F to 203° F).
  - The standard value during idling should be between 1,350 and 1,670 millivolts.
  - When the engine is revved, the output voltage should increase according to the increase in engine speed.
- (5) Turn the ignition switch to the "LOCK" (OFF) position.

**Q: Is the sensor operating properly?**

**YES :** It can be assumed that this malfunction is intermittent. Refer to GROUP 00, How to Use Troubleshooting/Inspection Service Points –How to Cope with Intermittent Malfunctions [P.00-13](#).

**NO :** Go to Step 2.

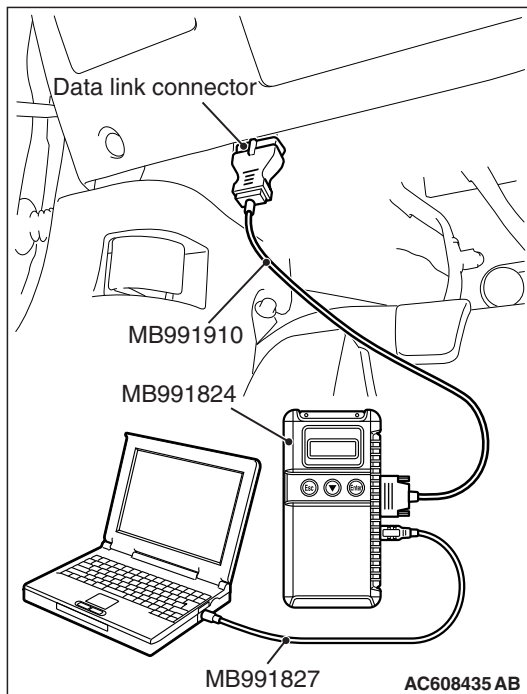
**STEP 2. Check harness connector A-05 at mass airflow sensor and harness connector A-30X at MFI relay for damage.****Q: Are the harness connectors in good condition?**

**YES :** Go to Step 3.

**NO :** Repair or replace them. Refer to GROUP 00E, Harness Connector Inspection [P.00E-2](#). Then go to Step 8.

**STEP 3. Check for harness damage between MFI relay connector A-30X (terminal No. 2) and mass airflow sensor connector A-05 (terminal No. 2).****Q: Is the harness wire in good condition?**

**YES :** Go to Step 4.

**NO :** Repair it. Then go to Step 8.

---

**STEP 4. Check harness connector B-109 at ECM for damage.**

**Q: Is the harness connector in good condition?**

**YES :** Go to Step 5.

**NO :** Repair or replace it. Refer to GROUP 00E, Harness Connector Inspection [P.00E-2](#). Then go to Step 8.

---

**STEP 5. Check for harness damage between mass airflow sensor connector A-05 (terminal No. 3) and ECM connector B-109 (terminal No. 87).**

**Q: Is the harness wire in good condition?**

**YES :** Go to Step 6.

**NO :** Repair it. Then go to Step 8.

---

**STEP 6. Check for harness damage between mass airflow sensor connector A-05 (terminal No. 4) and ECM connector B-109 (terminal No. 88).**

**Q: Is the harness wire in good condition?**

**YES :** Go to Step 7.

**NO :** Repair it. Then go to Step 8.

---

**STEP 7. Replace the mass airflow sensor.**

(1) Replace the mass airflow sensor.

(2) Carry out a test drive with the drive cycle pattern. Refer to Diagnostic Function –OBD-II Drive Cycle –Pattern 7 [P.13B-12](#).

(3) Check the diagnostic trouble code (DTC).

**Q: Is DTC P0101 set?**

**YES :** Replace the ECM (Refer to, Removal and Installation [P.13B-1022](#)). Then go to Step 8.

**NO :** The inspection is complete.

---

**STEP 8. Test the OBD-II drive cycle.**

(1) Carry out a test drive with the drive cycle pattern. Refer to Diagnostic Function –OBD-II Drive Cycle –Pattern 7 [P.13B-12](#).

(2) Check the diagnostic trouble code (DTC).

**Q: Is DTC P0101 set?**

**YES :** Retry the troubleshooting.

**NO :** The inspection is complete.

DTC P0102: Mass Airflow Circuit Low Input

MASS AIRFLOW SENSOR CIRCUIT

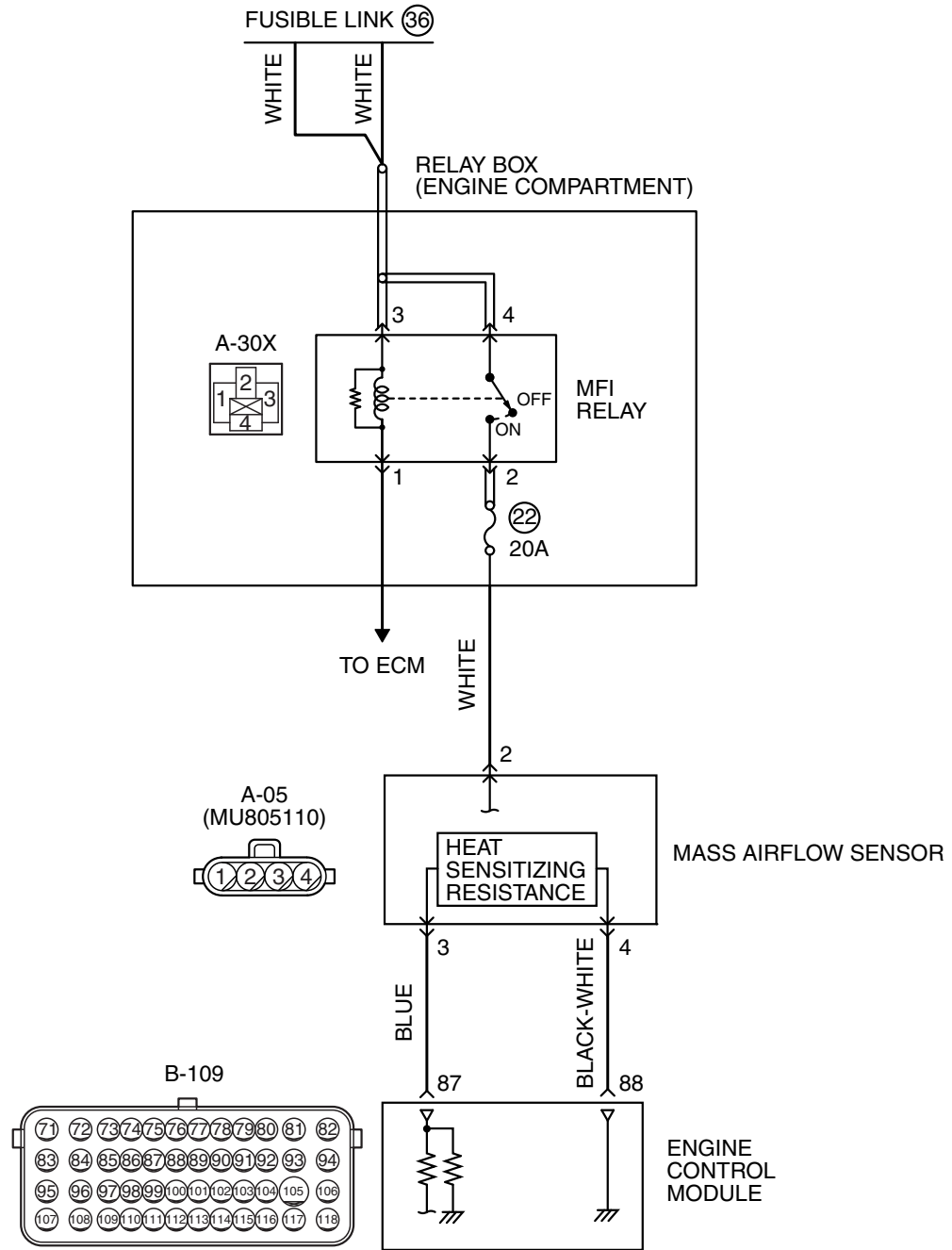

AK604114 AB

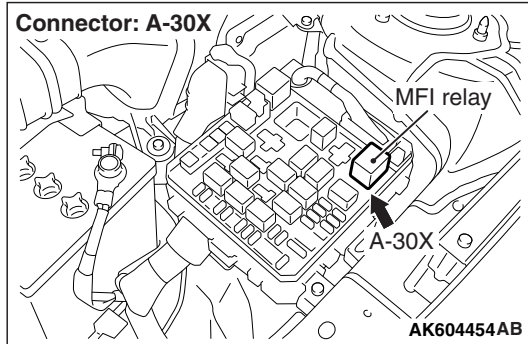
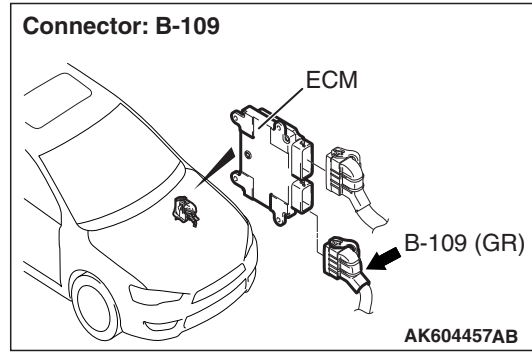
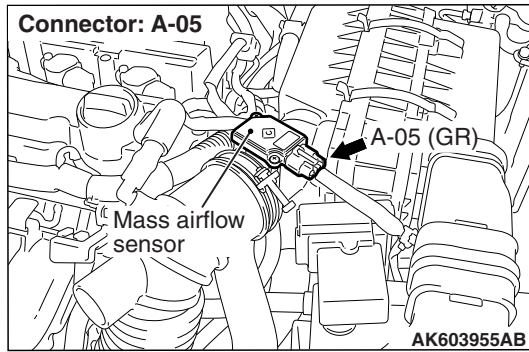

## CIRCUIT OPERATION

- The mass airflow sensor power is supplied from the MFI relay (terminal No. 2), and the ground is provided on the ECM (terminal No. 88).
- A voltage that is according to the mass airflow rate is sent to the ECM (terminal No. 87) from the mass airflow sensor output terminal (terminal No. 3).

## TECHNICAL DESCRIPTION

- While the engine is running, the mass airflow sensor outputs electric current which corresponds to the mass airflow rate.
- The ECM converts the electric current into the voltage and checks whether the voltage is within a specified range while the engine is running.

## DESCRIPTIONS OF MONITOR METHODS

Mass airflow sensor output voltage is out of specified range.

## MONITOR EXECUTION

Continuous

## MONITOR EXECUTION CONDITIONS (Other monitor and Sensor)

**Other Monitor (There is no temporary DTC stored in memory for the item monitored below)**

- Not applicable

**Sensor (The sensor below is determined to be normal)**

- Not applicable

## DTC SET CONDITIONS

## Logic Flow Chart

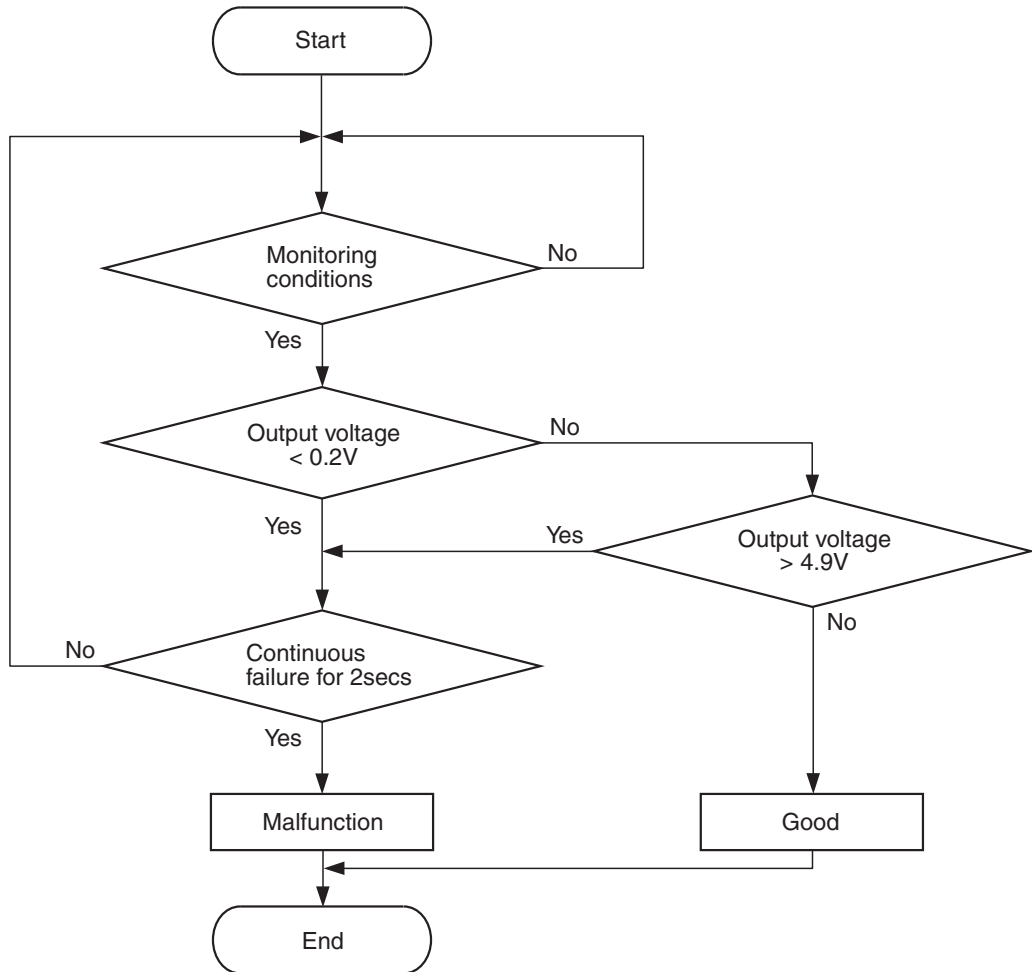

AK604310

**Check Condition**

- More than 3 seconds have passed since the ignition switch was turned to "ON" position.

**Judgement Criterion**

- Mass airflow sensor output voltage is less than 0.2 volt (corresponding to an air flow rate of 0 g/sec) for 2 seconds.

**FAIL-SAFE AND BACKUP FUNCTION**

- Fuel control is carried out using throttle opening degree and engine speed in accordance with pre-set map.

**OBD-II DRIVE CYCLE PATTERN**

Refer to Diagnostic Function –OBD-II Drive Cycle – Pattern 23 [P.13B-12](#).

**TROUBLESHOOTING HINTS (The most likely causes for this code to be set are:)**

- Mass airflow sensor failed.
- Open or shorted mass airflow sensor circuit, or connector damage.
- ECM failed.



## DIAGNOSIS

### Required Special Tools:

- MB991958: Scan Tool (M.U.T.-III Sub Assembly)
  - MB991824: V.C.I.
  - MB991827: USB Cable
  - MB991910: Main Harness A
- MB992110: Power Plant ECU Check Harness

### STEP 1. Using scan tool MB991958, check data list item 10: Mass Airflow Sensor.

#### **⚠ CAUTION**

To prevent damage to scan tool MB991958, always turn the ignition switch to the "LOCK" (OFF) position before connecting or disconnecting scan tool MB991958.

- (1) Connect scan tool MB991958 to the data link connector.
- (2) Start the engine and run at idle.
- (3) Set scan tool MB991958 to the data reading mode for item 10, Mass Airflow Sensor.
- (4) Warm up the engine to normal operating temperature: 80° C to 95° C (176° F to 203° F).
  - The standard value during idling should be between 1,350 and 1,670 millivolts.
  - When the engine is revved, the output voltage should increase according to the increase in engine speed.
- (5) Turn the ignition switch to the "LOCK" (OFF) position.

#### **Q: Is the sensor operating properly?**

**YES :** It can be assumed that this malfunction is intermittent. Refer to GROUP 00, How to Use Troubleshooting/Inspection Service Points –How to Cope with Intermittent Malfunctions [P.00-13](#).

**NO :** Go to Step 2.

### STEP 2. Check harness connector A-05 at mass airflow sensor for damage.

#### **Q: Is the harness connector in good condition?**

**YES :** Go to Step 3.

**NO :** Repair or replace it. Refer to GROUP 00E, Harness Connector Inspection [P.00E-2](#). Then go to Step 10.

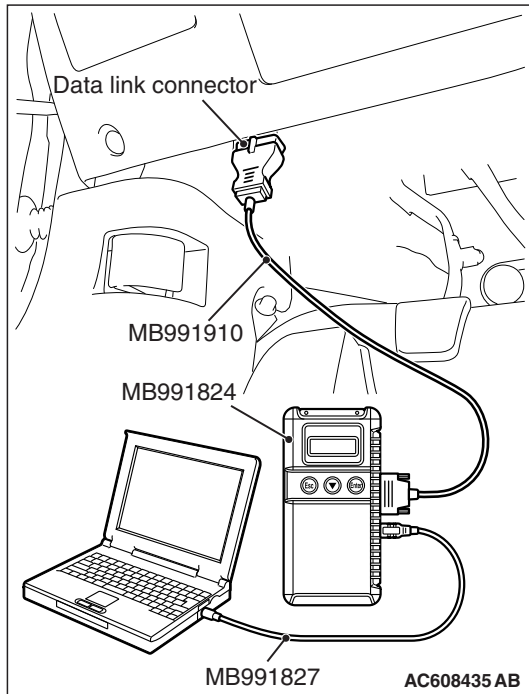

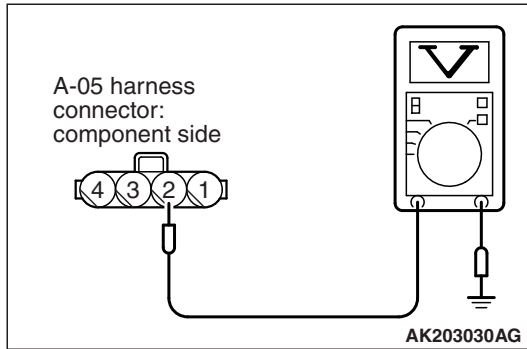
**STEP 3. Measure the power supply voltage at mass airflow sensor harness side connector A-05.**

- (1) Disconnect the connector A-05 and measure at the harness side.
- (2) Turn the ignition switch to the "ON" position.
- (3) Measure the voltage between terminal No. 2 and ground.
  - Voltage should be battery positive voltage.
- (4) Turn the ignition switch to the "LOCK" (OFF) position.

**Q: Is battery positive voltage (approximately 12 volts) present?**

**YES :** Go to Step 5.

**NO :** Go to Step 4.

**STEP 4. Check harness connector A-30X at MFI relay for damage.**

**Q: Is the harness connector in good condition?**

**YES :** Repair harness wire between MFI relay connector A-30X (terminal No. 2) and mass airflow sensor connector A-05 (terminal No. 2) because of open circuit or short circuit to ground. Then go to Step 10.

**NO :** Repair or replace it. Refer to GROUP 00E, Harness Connector Inspection [P.00E-2](#). Then go to Step 10.

**STEP 5. Check harness connector B-109 at ECM for damage.**

**Q: Is the harness connector in good condition?**

**YES :** Go to Step 6.

**NO :** Repair or replace it. Refer to GROUP 00E, Harness Connector Inspection [P.00E-2](#). Then go to Step 10.

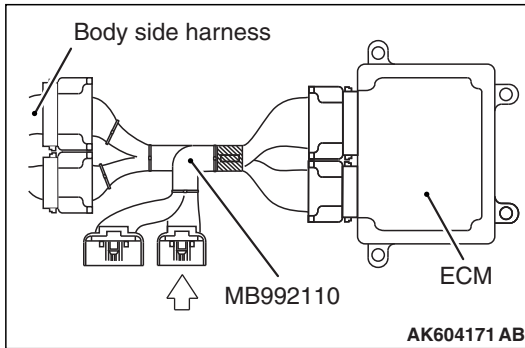

**STEP 6. Measure the sensor output voltage at ECM connector B-109 by using power plant ECU check harness special tool MB992110.**

(1) Disconnect all ECM connectors. Connect the power plant ECU check harness special tool MB992110 between the separated connectors.

(2) Start the engine.

(3) Measure the voltage between terminal No. 87 and ground.  
 • When the engine is revved, voltage should be increase in response to revving.

**Q: Is the measured voltage normal?**

**YES :** Go to Step 9.

**NO :** Go to Step 7.

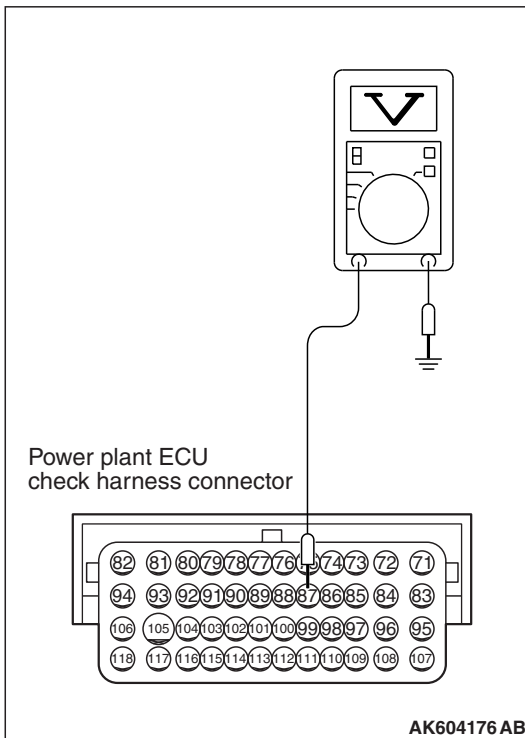

**STEP 7. Check for open circuit and short circuit to ground between mass airflow sensor connector A-05 (terminal No. 3) and ECM connector B-109 (terminal No. 87).**

**Q: Is the harness wire in good condition?**

**YES :** Go to Step 8.

**NO :** Repair it. Then go to Step 10.

**STEP 8. Replace the mass airflow sensor.**

- (1) Replace the mass airflow sensor.
- (2) Carry out a test drive with the drive cycle pattern. Refer to Diagnostic Function –OBD-II Drive Cycle –Pattern 23 [P.13B-12](#).
- (3) Check the diagnostic trouble code (DTC).

**Q: Is DTC P0102 set?**

**YES** : Replace the ECM (Refer to, Removal and Installation [P.13B-1022](#)). Then go to Step 10.

**NO** : The inspection is complete.

---

**STEP 9. Using scan tool MB991958, check data list item 10: Mass Airflow Sensor.**

- (1) Start the engine and run at idle.
- (2) Set scan tool MB991958 to the data reading mode for item 10, Mass Airflow Sensor.
- (3) Warm up the engine to normal operating temperature: 80° C to 95° C (176° F to 203° F).
  - The standard value during idling should be between 1,350 and 1,670 millivolts.
  - When the engine is revved, the output voltage should increase according to the increase in engine speed.
- (4) Turn the ignition switch to the "LOCK" (OFF) position.

**Q: Is the sensor operating properly?**

**YES** : It can be assumed that this malfunction is intermittent. Refer to GROUP 00, How to Use Troubleshooting/Inspection Service Points –How to Cope with Intermittent Malfunctions [P.00-13](#).

**NO** : Replace the ECM (Refer to, Removal and Installation [P.13B-1022](#)). Then go to Step 10.

---

**STEP 10. Test the OBD-II drive cycle.**

- (1) Carry out a test drive with the drive cycle pattern. Refer to Diagnostic Function –OBD-II Drive Cycle –Pattern 23 [P.13B-12](#).
- (2) Check the diagnostic trouble code (DTC).

**Q: Is DTC P0102 set?**

**YES** : Retry the troubleshooting.

**NO** : The inspection is complete.

DTC P0103: Mass Airflow Circuit High Input

MASS AIRFLOW SENSOR CIRCUIT

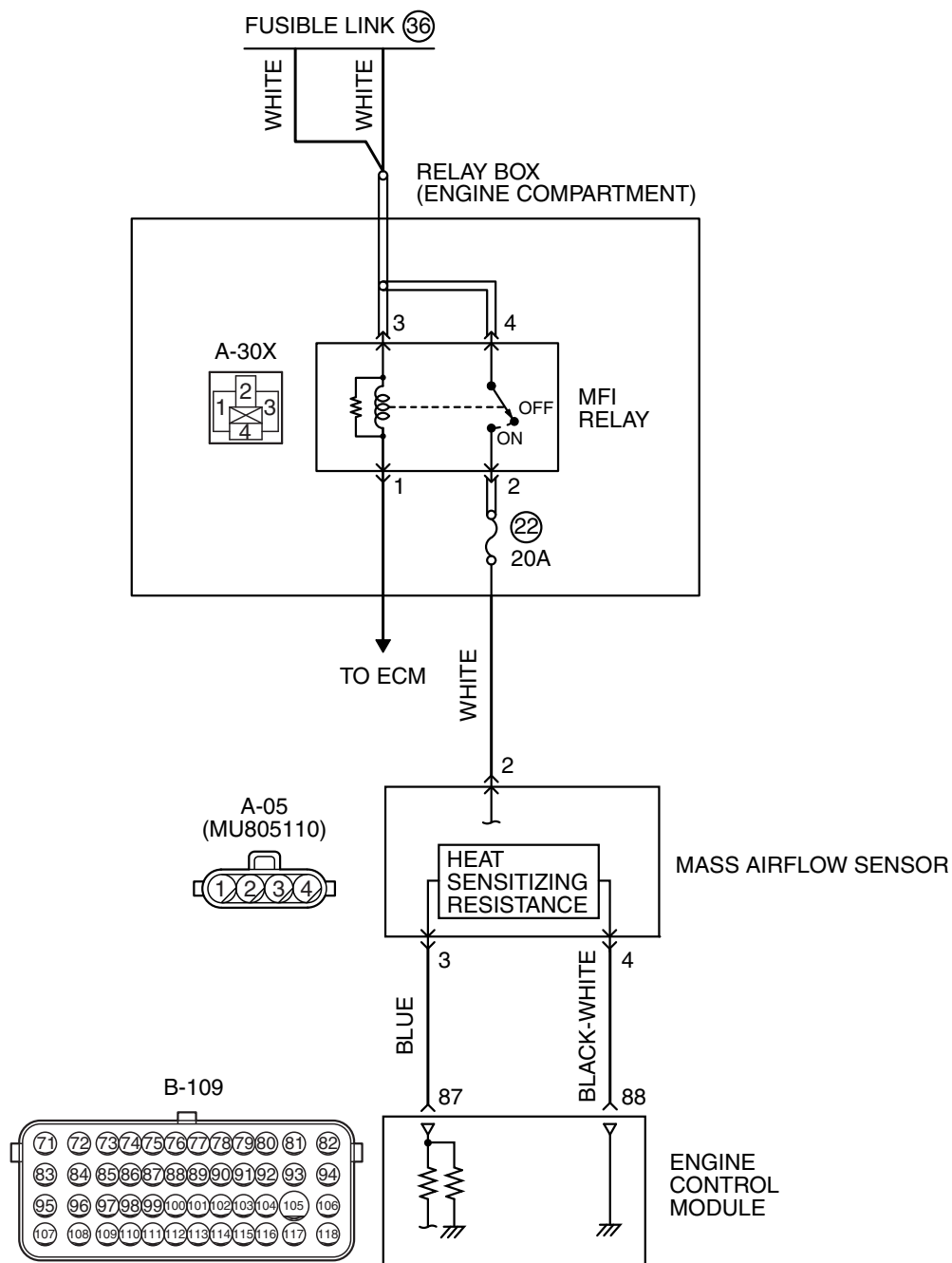

AK604114 AB

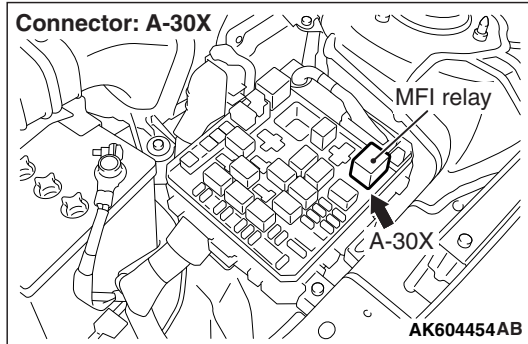
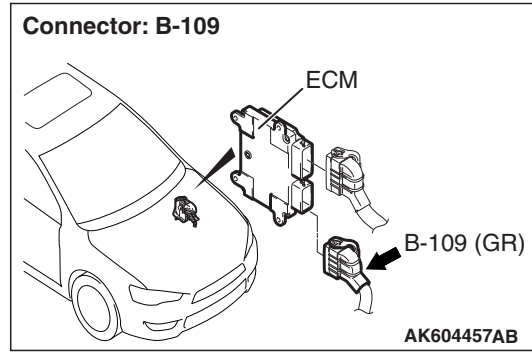
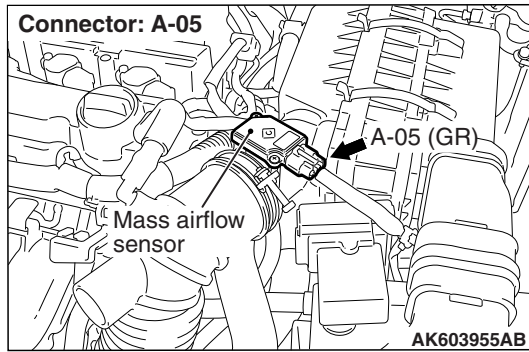

### CIRCUIT OPERATION

- The mass airflow sensor power is supplied from the MFI relay (terminal No. 2), and the ground is provided on the ECM (terminal No. 88).
- A voltage that is according to the mass airflow rate is sent to the ECM (terminal No. 87) from the mass airflow sensor output terminal (terminal No. 3).

### TECHNICAL DESCRIPTION

- While the engine is running, the mass airflow sensor outputs electric current which corresponds to the mass airflow rate.
- The ECM converts the electric current into the voltage and checks whether the voltage is within a specified range while the engine is running.

### DESCRIPTIONS OF MONITOR METHODS

Mass airflow sensor output voltage is out of specified range.

### MONITOR EXECUTION

Continuous

### MONITOR EXECUTION CONDITIONS (Other monitor and Sensor)

**Other Monitor (There is no temporary DTC stored in memory for the item monitored below)**

- Not applicable

**Sensor (The sensor below is determined to be normal)**

- Not applicable

DTC SET CONDITIONS

Logic Flow Chart

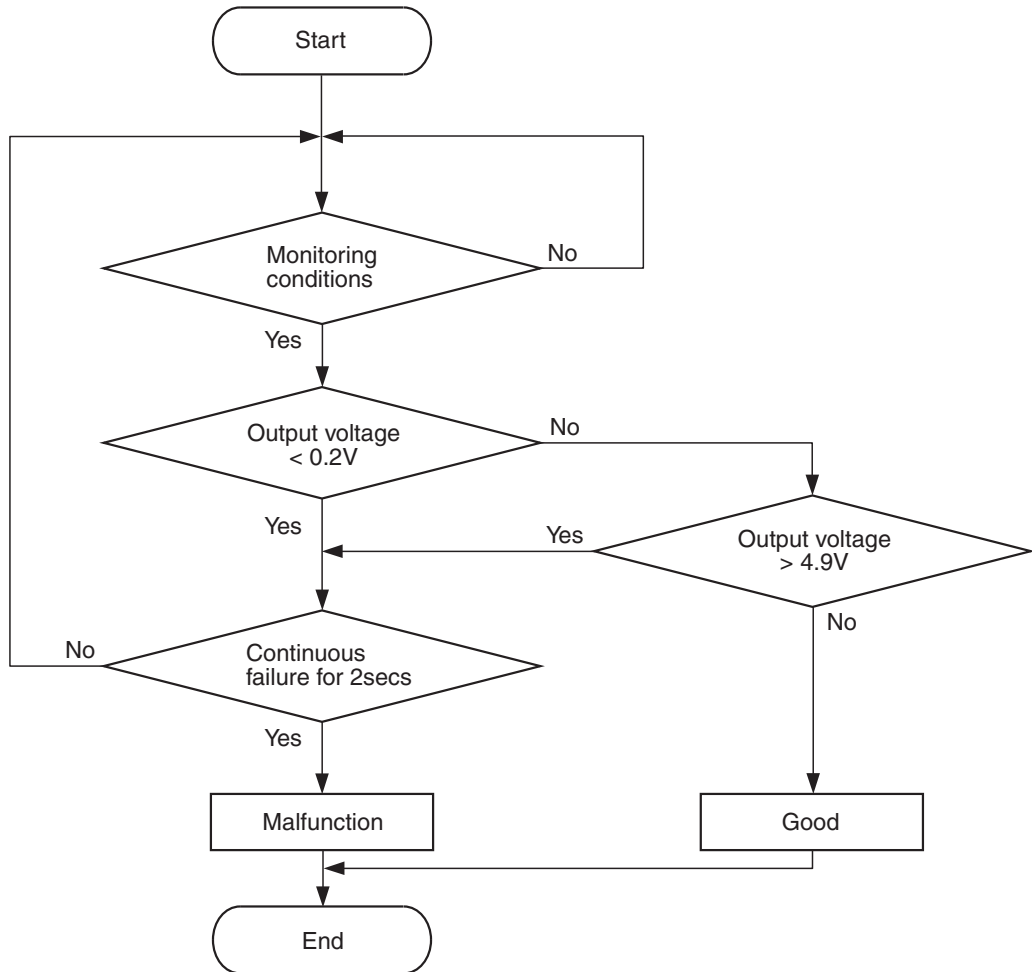

AK604310

**Check Condition**

- More than 3 seconds have passed since the ignition switch was turned to "ON" position.

**Judgement Criterion**

- Mass airflow sensor output voltage is more than 4.9 volts (corresponding to an air flow rate of 295 g/sec) for 2 seconds.

**FAIL-SAFE AND BACKUP FUNCTION**

- Fuel control is carried out using throttle opening degree and engine speed in accordance with pre-set map.

**OBD-II DRIVE CYCLE PATTERN**

Refer to Diagnostic Function –OBD-II Drive Cycle – Pattern 23 [P.13B-12](#).

**TROUBLESHOOTING HINTS (The most likely causes for this code to be set are:)**

- Mass airflow sensor failed.
- Open mass airflow sensor circuit, or connector damage.
- ECM failed.

**DIAGNOSIS****Required Special Tool:**

- MB991958: Scan Tool (M.U.T.-III Sub Assembly)
  - MB991824: V.C.I.
  - MB991827: USB Cable
  - MB991910: Main Harness A

**STEP 1. Using scan tool MB991958, check data list item 10: Mass Airflow Sensor.****⚠ CAUTION**

To prevent damage to scan tool MB991958, always turn the ignition switch to the "LOCK" (OFF) position before connecting or disconnecting scan tool MB991958.

- (1) Connect scan tool MB991958 to the data link connector.
- (2) Start the engine and run at idle.
- (3) Set scan tool MB991958 to the data reading mode for item 10, Mass Airflow Sensor.
- (4) Warm up the engine to normal operating temperature: 80° C to 95° C (176° F to 203° F).
  - The standard value during idling should be between 1,350 and 1,670 millivolts.
  - When the engine is revved, the output voltage should increase according to the increase in engine speed.
- (5) Turn the ignition switch to the "LOCK" (OFF) position.

**Q: Is the sensor operating properly?**

**YES :** It can be assumed that this malfunction is intermittent. Refer to GROUP 00, How to Use Troubleshooting/Inspection Service Points –How to Cope with Intermittent Malfunctions P.00-13.

**NO :** Go to Step 2.

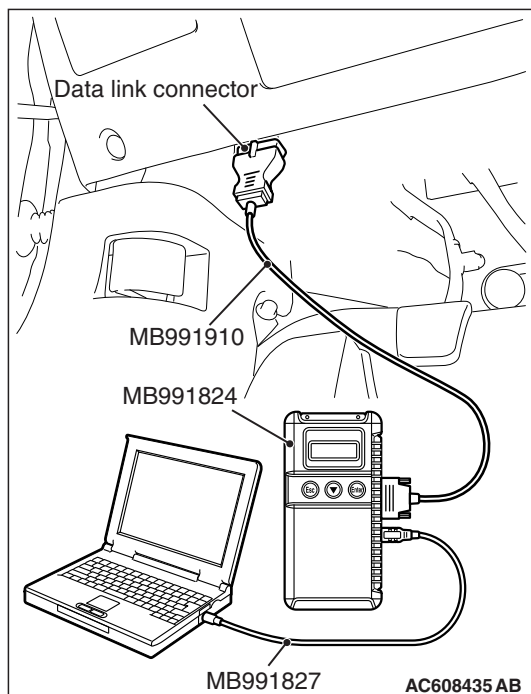
**STEP 2. Check harness connector A-05 at mass airflow sensor for damage.****Q: Is the harness connector in good condition?**

**YES :** Go to Step 3.

**NO :** Repair or replace it. Refer to GROUP 00E, Harness Connector Inspection P.00E-2. Then go to Step 8.

**STEP 3. Check the continuity at mass airflow sensor harness side connector A-05.**

- (1) Disconnect the connector A-05 and measure at the harness side.
- (2) Check for the continuity between terminal No. 4 and ground.
  - Continuity (2 ohms or less)

**Q: Does continuity exist?**

**YES :** Go to Step 7.

**NO :** Go to Step 4.

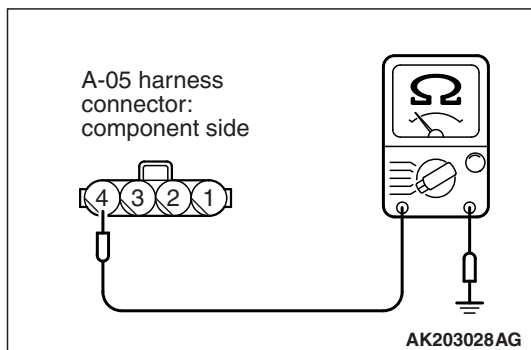



---

**STEP 4. Check harness connector B-109 at ECM for damage.**

**Q: Is the harness connector in good condition?**

**YES :** Go to Step 5.

**NO :** Repair or replace it. Refer to GROUP 00E, Harness Connector Inspection [P.00E-2](#). Then go to Step 8.

---

**STEP 5. Check for open circuit between mass airflow sensor connector A-05 (terminal No. 4) and ECM connector B-109 (terminal No. 88).**

**Q: Is the harness wire in good condition?**

**YES :** Go to Step 6.

**NO :** Repair it. Then go to Step 8.

---

**STEP 6. Using scan tool MB991958, check data list item 10: Mass Airflow Sensor.**

(1) Start the engine and run at idle.

(2) Set scan tool MB991958 to the data reading mode for item 10, Mass Airflow Sensor.

(3) Warm up the engine to normal operating temperature: 80° C to 95° C (176° F to 203° F).

- The standard value during idling should be between 1,350 and 1,670 millivolts.
- When the engine is revved, the output voltage should increase according to the increase in engine speed.

(4) Turn the ignition switch to the "LOCK" (OFF) position.

**Q: Is the sensor operating properly?**

**YES :** It can be assumed that this malfunction is intermittent. Refer to GROUP 00, How to Use Troubleshooting/Inspection Service Points –How to Cope with Intermittent Malfunctions [P.00-13](#).

**NO :** Replace the ECM (Refer to, Removal and Installation [P.13B-1022](#)). Then go to Step 8.

---

**STEP 7. Replace the mass airflow sensor.**

(1) Replace the mass airflow sensor.

(2) Carry out a test drive with the drive cycle pattern. Refer to Diagnostic Function –OBD-II Drive Cycle –Pattern 23 [P.13B-12](#).

(3) Check the diagnostic trouble code (DTC).

**Q: Is DTC P0103 set?**

**YES :** Replace the ECM (Refer to, Removal and Installation [P.13B-1022](#)). Then go to Step 8.

**NO :** The inspection is complete.

**STEP 8. Test the OBD-II drive cycle.**

- (1) Carry out a test drive with the drive cycle pattern. Refer to Diagnostic Function –OBD-II Drive Cycle –Pattern 23 P.13B-12.
- (2) Check the diagnostic trouble code (DTC).

**Q: Is DTC P0103 set?**

- YES :** Retry the troubleshooting.  
**NO :** The inspection is complete.

**DTC P0106: Manifold Absolute Pressure Circuit Range/Performance Problem**

**MANIFOLD ABSOLUTE PRESSURE SENSOR CIRCUIT**

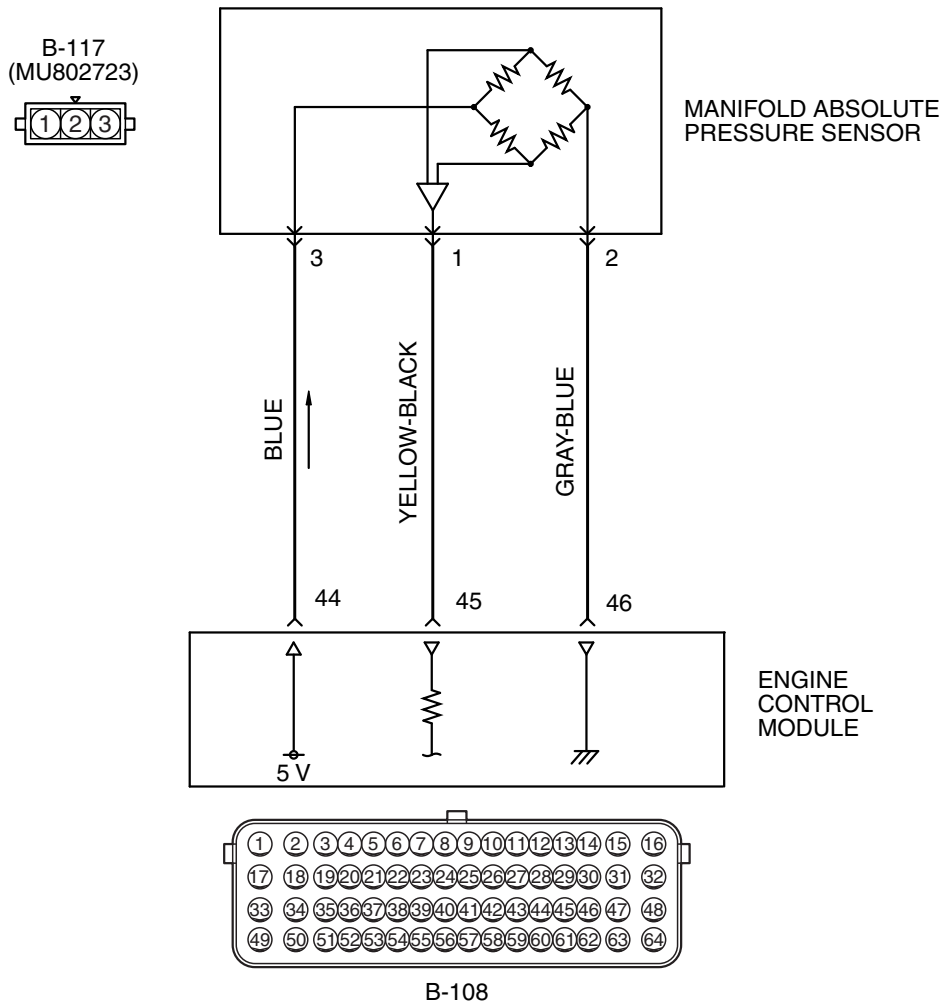

AK604115 AD

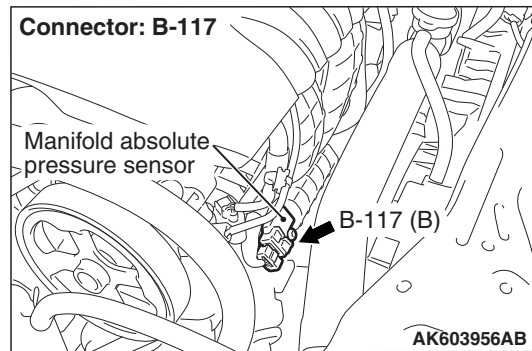
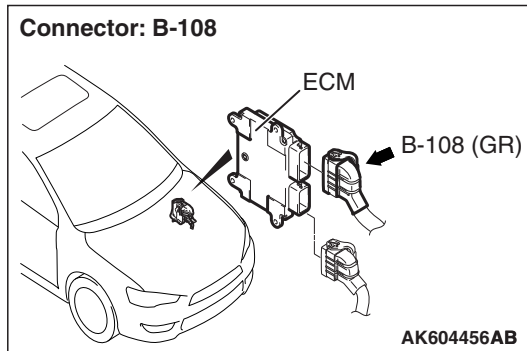

## CIRCUIT OPERATION

- A 5-volt voltage is supplied to the manifold absolute pressure sensor power terminal (terminal No. 3) from the ECM (terminal No. 44). The ground terminal (terminal No. 2) is grounded with ECM (terminal No. 46).
- A voltage that is proportional to the intake manifold pressure is sent to the ECM (terminal No. 45) from the manifold absolute pressure sensor output terminal (terminal No. 1).

## TECHNICAL DESCRIPTION

- The manifold absolute pressure sensor outputs a voltage which corresponds to the intake manifold pressure.
- The ECM checks whether this voltage is within a specified range.

## DESCRIPTIONS OF MONITOR METHODS

Compare load value with manifold absolute pressure sensor output voltage.

## MONITOR EXECUTION

Continuous

## MONITOR EXECUTION CONDITIONS (Other monitor and Sensor)

**Other Monitor (There is no temporary DTC stored in memory for the item monitored below)**

- Not applicable

**Sensor (The sensor below is determined to be normal)**

- Mass airflow sensor
- Engine coolant temperature sensor
- Intake air temperature sensor
- Barometric pressure sensor
- Throttle position sensor

## DTC SET CONDITIONS &lt;Range/Performance problem –high input&gt;

## Logic Flow Chart

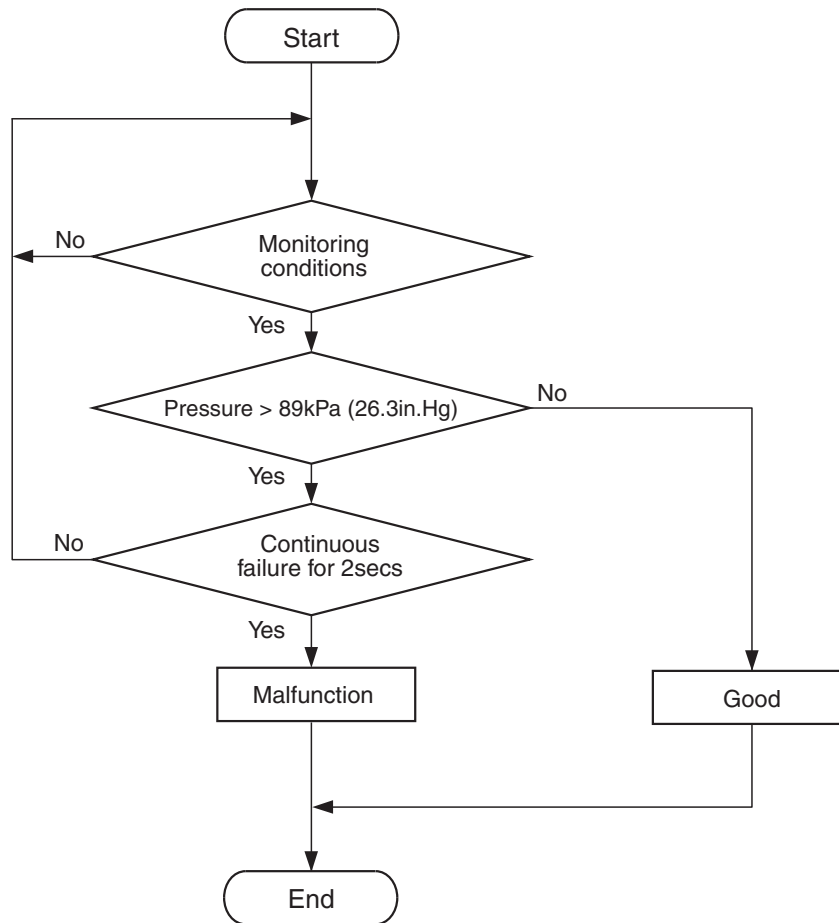

AK604311

**Check Conditions**

- More than 8 minutes have passed since the engine starting sequence was completed, when the engine coolant temperature at engine start is less than 0° C (32° F).
- Engine speed is between 500 r/min and 1,500 r/min.

- Throttle position sensor output voltage is less than 0.8 volt.

**Judgement Criterion**

- Manifold absolute pressure sensor output voltage is more than 3.5 volts [corresponding to a manifold absolute pressure of 89 kPa (26.3 in.Hg)] for 2 seconds.

**DTC SET CONDITIONS <Range/Performance problem –low input>**

**Logic Flow Chart**

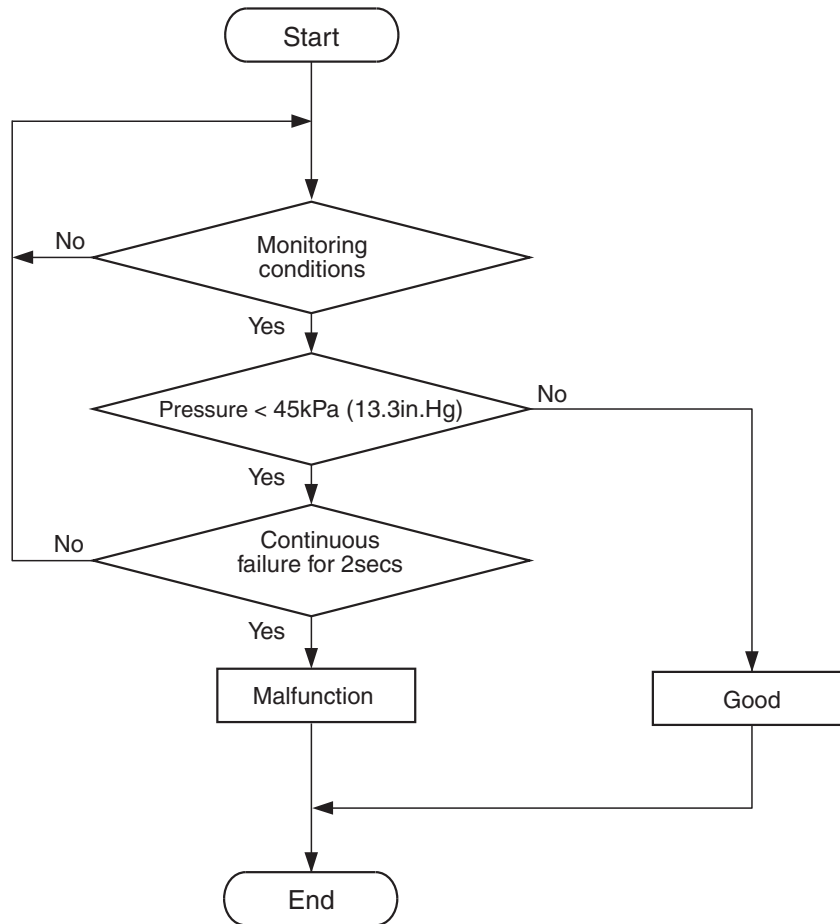

AK604312

**Check Conditions**

- More than 8 minutes have passed since the engine starting sequence was completed, when the engine coolant temperature at engine start is less than 0° C (32° F).
- Engine speed is more than 1,500 r/min.
- Throttle position sensor output voltage is more than 3.5 volts.

**Judgement Criterion**

- Manifold absolute pressure sensor output voltage is less than 1.8 volts [corresponding to a manifold absolute pressure of 45 kPa (13.3 in.Hg)] for 2 seconds.

**FAIL-SAFE AND BACKUP FUNCTION**

- Control as if the intake manifold vacuum pressure is 101 kPa (29.8 in.Hg)

**OBD-II DRIVE CYCLE PATTERN**

Refer to Diagnostic Function –OBD-II Drive Cycle – Pattern 7 [P.13B-12](#).

**TROUBLESHOOTING HINTS (The most likely causes for this code to be set are:)**

- Manifold absolute pressure sensor failed.
- Harness damage.
- Connector damage.
- ECM failed.

**DIAGNOSIS****Required Special Tools:**

- MB991958: Scan Tool (M.U.T.-III Sub Assembly)
  - MB991824: V.C.I.
  - MB991827: USB Cable
  - MB991910: Main Harness A
- MB992110: Power Plant ECU Check Harness

**STEP 1. Using scan tool MB991958, check data list item 8: Manifold Absolute Pressure Sensor.****⚠ CAUTION**

To prevent damage to scan tool MB991958, always turn the ignition switch to the "LOCK" (OFF) position before connecting or disconnecting scan tool MB991958.

- (1) Connect scan tool MB991958 to the data link connector.
- (2) Turn the ignition switch to the "ON" position.
- (3) Set scan tool MB991958 to the data reading mode for item 8, Manifold Absolute Pressure Sensor.
  - When altitude is 0 m (0 foot), 101 kPa (29.8 in.Hg).
  - When altitude is 600 m (1,969 feet), 95 kPa (28.1 in.Hg).
  - When altitude is 1,200 m (3,937 feet), 88 kPa (26.0 in.Hg).
  - When altitude is 1,800 m (5,906 feet), 81 kPa (23.9 in.Hg).
- (4) Start the engine.
  - Warm up the engine. When the engine is idling, 16 –36 kPa (4.7 –10.6 in.Hg).
  - When the engine is suddenly revved, manifold absolute pressure varies.
- (5) Turn the ignition switch to the "LOCK" (OFF) position.

**Q: Is the sensor operating properly?**

**YES** : It can be assumed that this malfunction is intermittent. Refer to GROUP 00, How to Use Troubleshooting/Inspection Service Points –How to Cope with Intermittent Malfunctions [P.00-13](#).

**NO** : Go to Step 2.

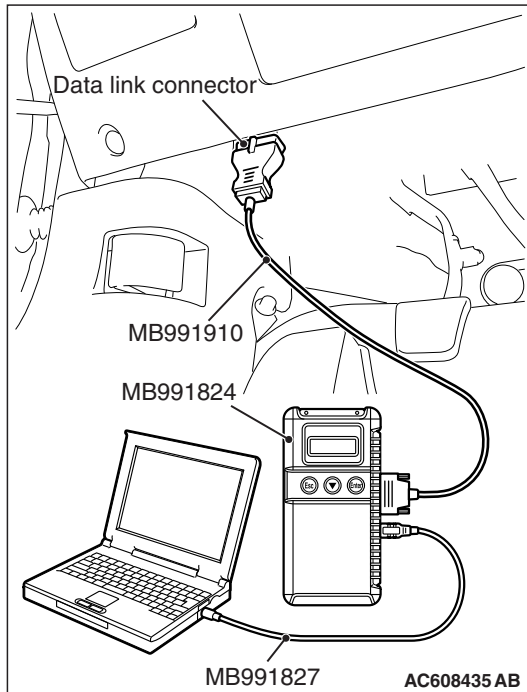

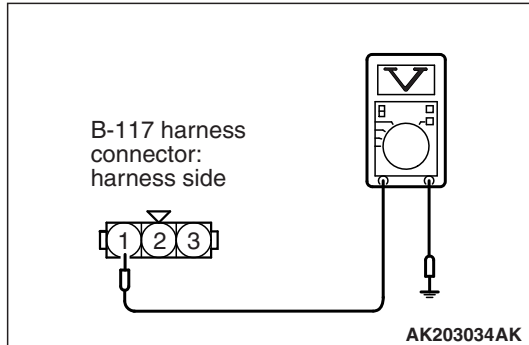

**STEP 2. Measure the sensor output voltage at manifold absolute pressure sensor connector B-117 by backprobing.**

- (1) Do not disconnect the connector B-117.
- (2) Turn the ignition switch to the "ON" position.
- (3) Measure the voltage between terminal No. 1 and ground by backprobing.
  - When altitude is 0 m (0 foot), voltage should be between 3.8 and 4.2 volts.
  - When altitude is 600 m (1,969 feet), voltage should be between 3.5 and 3.9 volts.
  - When altitude is 1,200 m (3,937 feet), voltage should be between 3.3 and 3.7 volts.
  - When altitude is 1,800 m (5,906 feet), voltage should be between 3.0 and 3.4 volts.
- (4) Turn the ignition switch to the "LOCK" (OFF) position.

**Q: Is the measured voltage normal?**

**YES** : Go to Step 10.

**NO** : Go to Step 3.

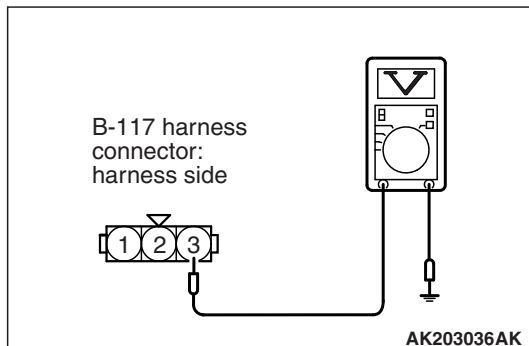

**STEP 3. Measure the sensor supply voltage at manifold absolute pressure sensor connector B-117 by backprobing.**

- (1) Do not disconnect the connector B-117.
- (2) Turn the ignition switch to the "ON" position.
- (3) Measure the voltage between terminal No. 3 and ground by backprobing.
  - Voltage should be between 4.9 and 5.1 volts.
- (4) Turn the ignition switch to the "LOCK" (OFF) position.

**Q: Is the measured voltage between 4.9 and 5.1 volts?**

**YES** : Go to Step 6.

**NO** : Go to Step 4.

**STEP 4. Check harness connector B-117 at manifold absolute pressure sensor and harness connector B-108 at ECM for damage.**

**Q: Are the harness connectors in good condition?**

**YES** : Go to step 5.

**NO** : Repair or replace them. Refer to GROUP 00E, Harness Connector Inspection [P.00E-2](#). Then go to Step 13.

**STEP 5. Check for harness damage between manifold absolute pressure sensor connector B-117 (terminal No. 3) and ECM connector B-108 (terminal No. 44).**

**Q: Is the harness wire in good condition?**

**YES** : Go to Step 12.

**NO** : Repair it. Then go to Step 13.

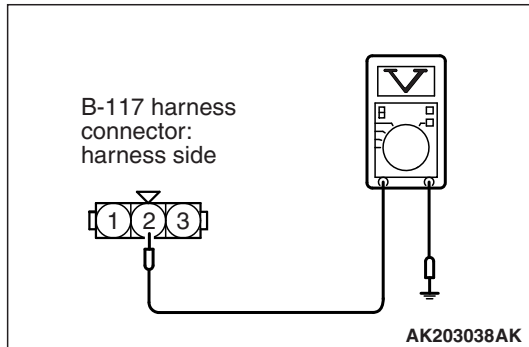

---

**STEP 6. Measure the ground voltage at manifold absolute pressure sensor connector B-117 by backprobing.**

- (1) Do not disconnect the connector B-117.
- (2) Turn the ignition switch to the "ON" position.
- (3) Measure the voltage between terminal No. 2 and ground by backprobing.
  - Voltage should be 0.5 volt or less.
- (4) Turn the ignition switch to the "LOCK" (OFF) position.

**Q: Is the measured voltage 0.5 volt or less?**

**YES :** Go to Step 9.

**NO :** Go to Step 7.

---

**STEP 7. Check harness connector B-117 at manifold absolute pressure sensor and harness connector B-108 at ECM for damage.**

**Q: Are the harness connectors in good condition?**

**YES :** Go to Step 8.

**NO :** Repair or replace them. Refer to GROUP 00E, Harness Connector Inspection [P.00E-2](#). Then go to Step 13.

---

**STEP 8. Check for harness damage between manifold absolute pressure sensor connector B-117 (terminal No. 2) and ECM connector B-108 (terminal No. 46).**

**Q: Is the harness wire in good condition?**

**YES :** Go to Step 12.

**NO :** Repair it. Then go to Step 13.

---

**STEP 9. Check harness connector B-117 at manifold absolute pressure sensor for damage.**

**Q: Is the harness connector in good condition?**

**YES :** Replace the manifold absolute pressure sensor. Then go to Step 13.

**NO :** Repair or replace it. Refer to GROUP 00E, Harness Connector Inspection [P.00E-2](#). Then go to Step 13.

---

**STEP 10. Check harness connector B-117 at manifold absolute pressure sensor and harness connector B-108 at ECM for damage.**

**Q: Are the harness connectors in good condition?**

**YES :** Go to Step 11.

**NO :** Repair or replace them. Refer to GROUP 00E, Harness Connector Inspection [P.00E-2](#). Then go to Step 13.



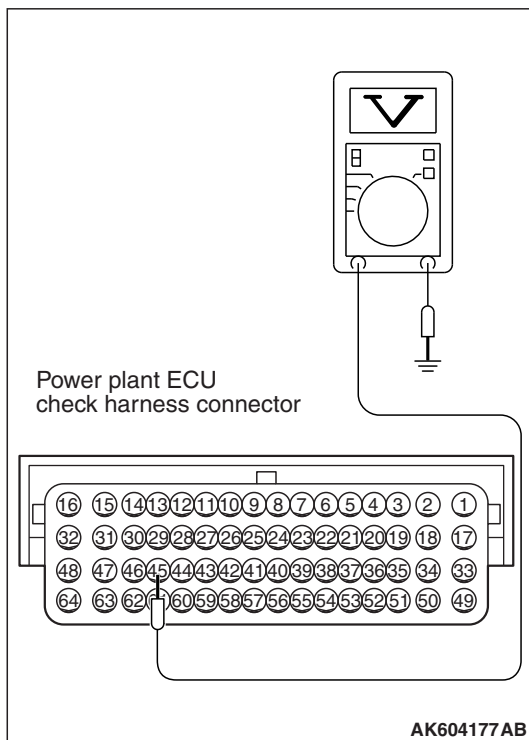
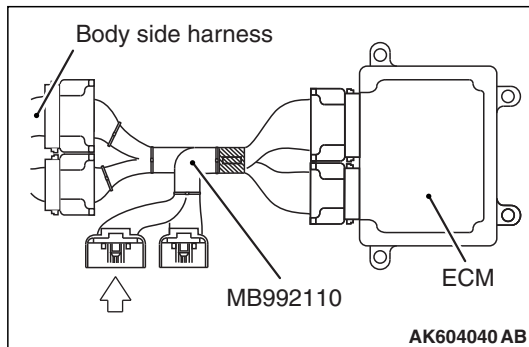

**STEP 11. Measure the sensor output voltage at ECM connector B-108 by using power plant ECU check harness special tool MB992110.**

(1) Disconnect all ECM connectors. Connect the power plant ECU check harness special tool MB992110 between the separated connectors.

(2) Turn the ignition switch to the "ON" position.

(3) Measure the voltage between terminal No. 45 and ground.

- When altitude is 0 m (0 foot), voltage should be between 3.8 and 4.2 volts.
- When altitude is 600 m (1,969 feet), voltage should be between 3.5 and 3.9 volts.
- When altitude is 1,200 m (3,937 feet), voltage should be between 3.3 and 3.7 volts.
- When altitude is 1,800 m (5,906 feet), voltage should be between 3.0 and 3.4 volts.

(4) Turn the ignition switch to the "LOCK" (OFF) position.

**Q: Is the measured voltage normal?**

**YES :** Go to Step 12.

**NO :** Repair harness wire between manifold absolute pressure sensor connector B-117 (terminal No. 1) and ECM connector B-108 (terminal No. 45) because of harness damage. Then go to Step 13.

**STEP 12. Using scan tool MB991958, check data list item 8: Manifold Absolute Pressure Sensor.**

- (1) Turn the ignition switch to the "ON" position.
- (2) Set scan tool MB991958 to the data reading mode for item 8, Manifold Absolute Pressure Sensor.
  - When altitude is 0 m (0 foot), 101 kPa (29.8 in.Hg).
  - When altitude is 600 m (1,969 feet), 95 kPa (28.1 in.Hg).
  - When altitude is 1,200 m (3,937 feet), 88 kPa (26.0 in.Hg).
  - When altitude is 1,800 m (5,906 feet), 81 kPa (23.9 in.Hg).
- (3) Start the engine.
  - Warm up the engine. When the engine is idling, 16 –36 kPa (4.7 –10.6 in.Hg).
  - When the engine is suddenly revved, manifold absolute pressure varies.
- (4) Turn the ignition switch to the "LOCK" (OFF) position.

**Q: Is the sensor operating properly?**

**YES** : It can be assumed that this malfunction is intermittent. Refer to GROUP 00, How to Use Troubleshooting/Inspection Service Points –How to Cope with Intermittent Malfunctions [P.00-13](#).

**NO** : Replace the ECM (Refer to, Removal and Installation [P.13B-1022](#)). Then go to Step 13.

---

**STEP 13. Test the OBD-II drive cycle.**

- (1) Carry out a test drive with the drive cycle pattern. Refer to Diagnostic Function –OBD-II Drive Cycle –Pattern 7 [P.13B-12](#).
- (2) Check the diagnostic trouble code (DTC).

**Q: Is DTC P0106 set?**

**YES** : Retry the troubleshooting.

**NO** : The inspection is complete.

DTC P0107: Manifold Absolute Pressure Circuit Low Input

MANIFOLD ABSOLUTE PRESSURE SENSOR CIRCUIT

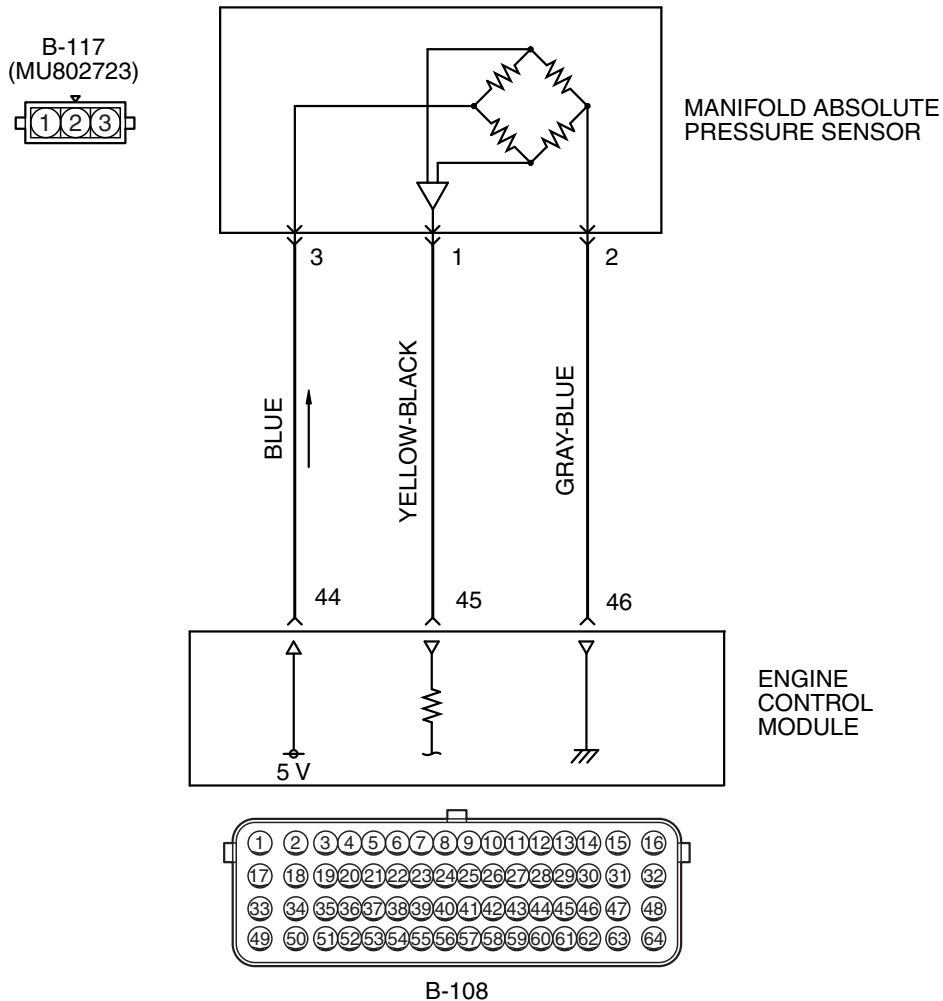

AK604115 AD

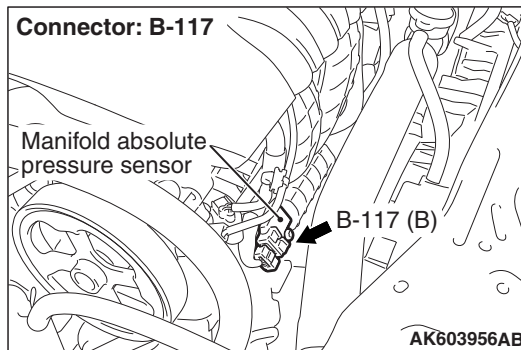
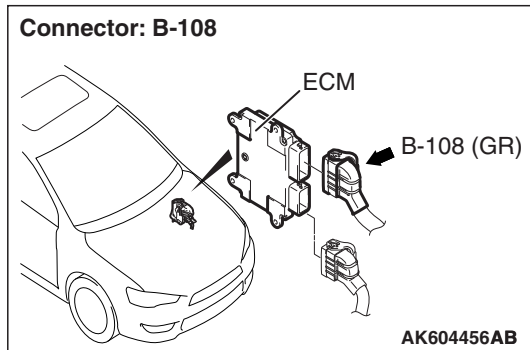

**CIRCUIT OPERATION**

- A 5-volt voltage is supplied to the manifold absolute pressure sensor power terminal (terminal No. 3) from the ECM (terminal No. 44). The ground terminal (terminal No. 2) is grounded with ECM (terminal No. 46).
- A voltage that is proportional to the intake manifold pressure is sent to the ECM (terminal No. 45) from the manifold absolute pressure sensor output terminal (terminal No. 1).

**TECHNICAL DESCRIPTION**

- The manifold absolute pressure sensor outputs a voltage which corresponds to the intake manifold pressure.
- The ECM checks whether this voltage is within a specified range.

**DESCRIPTIONS OF MONITOR METHODS**

Manifold absolute pressure sensor output voltage is out of specified range.

**MONITOR EXECUTION**

Continuous

**MONITOR EXECUTION CONDITIONS  
(Other monitor and Sensor)**

**Other Monitor (There is no temporary DTC stored in memory for the item monitored below)**

- Not applicable

**Sensor (The sensor below is determined to be normal)**

- Mass airflow sensor
- Engine coolant temperature sensor
- Intake air temperature sensor
- Barometric pressure sensor
- Throttle position sensor

## DTC SET CONDITIONS

### Logic Flow Chart

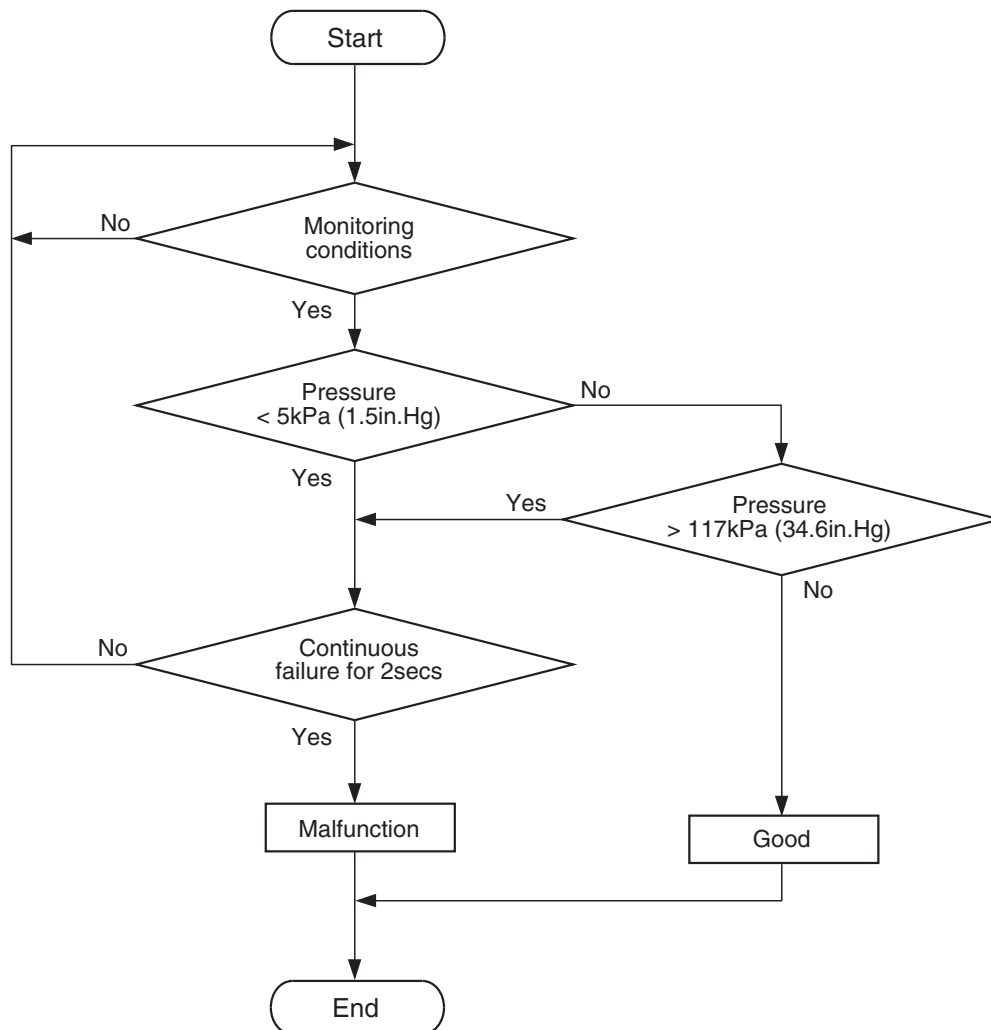

AK604313

#### Check Conditions

- More than 8 minutes have passed since the engine starting sequence was completed, when the engine coolant temperature at engine start is less than 0° C (32° F).
- Volumetric efficiency is more than 20 percent.

#### Judgement Criterion

- Manifold absolute pressure sensor output voltage is less than 0.2 volt [corresponding to a manifold absolute pressure of 5 kPa (1.5 in.Hg)] for 2 seconds.

#### FAIL-SAFE AND BACKUP FUNCTION

- Control as if the intake manifold vacuum pressure is 101 kPa (29.8 in.Hg).

#### OBD-II DRIVE CYCLE PATTERN

Refer to Diagnostic Function –OBD-II Drive Cycle – Pattern 7 [P.13B-12](#).

#### TROUBLESHOOTING HINTS (The most likely causes for this code to be set are:)

- Manifold absolute pressure sensor failed.
- Open or shorted manifold absolute pressure sensor circuit, harness damage or connector damage.
- ECM failed.

## DIAGNOSIS

### Required Special Tools:

- MB991958: Scan Tool (M.U.T.-III Sub Assembly)
  - MB991824: V.C.I.
  - MB991827: USB Cable
  - MB991910: Main Harness A
- MB992110: Power Plant ECU Check Harness

### STEP 1. Using scan tool MB991958, check data list item 8: Manifold Absolute Pressure Sensor.

#### **CAUTION**

To prevent damage to scan tool MB991958, always turn the ignition switch to the "LOCK" (OFF) position before connecting or disconnecting scan tool MB991958.

- (1) Connect scan tool MB991958 to the data link connector.
- (2) Turn the ignition switch to the "ON" position.
- (3) Set scan tool MB991958 to the data reading mode for item 8, Manifold Absolute Pressure Sensor.
  - When altitude is 0 m (0 foot), 101 kPa (29.8 in.Hg).
  - When altitude is 600 m (1,969 feet), 95 kPa (28.1 in.Hg).
  - When altitude is 1,200 m (3,937 feet), 88 kPa (26.0 in.Hg).
  - When altitude is 1,800 m (5,906 feet), 81 kPa (23.9 in.Hg).
- (4) Start the engine.
  - Warm up the engine. When the engine is idling, 16 –36 kPa (4.7 –10.6 in.Hg).
  - When the engine is suddenly revved, manifold absolute pressure varies.
- (5) Turn the ignition switch to the "LOCK" (OFF) position.

#### Q: Is the sensor operating properly?

**YES** : It can be assumed that this malfunction is intermittent. Refer to GROUP 00, How to Use Troubleshooting/Inspection Service Points –How to Cope with Intermittent Malfunctions P.00-13.

**NO** : Go to Step 2.

### STEP 2. Measure the sensor supply voltage at manifold absolute pressure sensor connector B-117 by backprobing.

- (1) Do not disconnect the connector B-117.
- (2) Turn the ignition switch to the "ON" position.
- (3) Measure the voltage between terminal No. 3 and ground by backprobing.
  - Voltage should be between 4.9 and 5.1 volts.
- (4) Turn the ignition switch to the "LOCK" (OFF) position.

#### Q: Is the measured voltage between 4.9 and 5.1 volts?

**YES** : Go to Step 8.

**NO** : Go to Step 3.

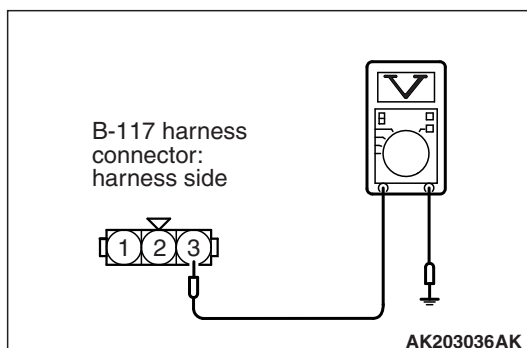
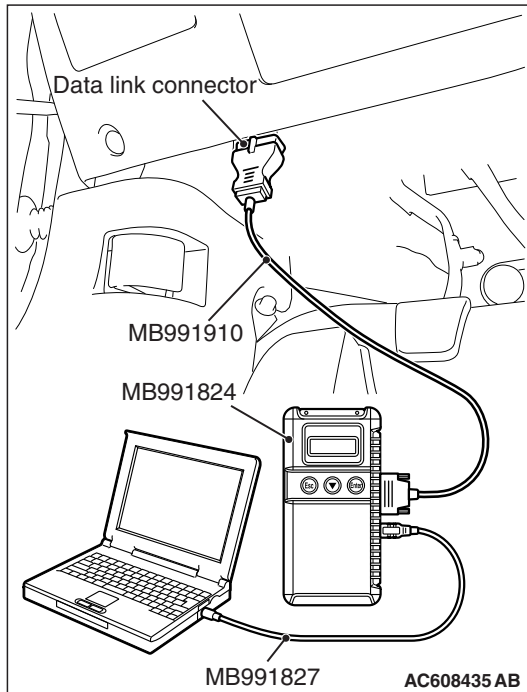

**STEP 3. Check harness connector B-108 at ECM for damage.**

**Q: Is the harness connector in good condition?**

**YES :** Go to Step 4.

**NO :** Repair or replace it. Refer to GROUP 00E, Harness Connector Inspection [P.00E-2](#). Then go to Step 13.

**STEP 4. Measure the sensor supply voltage at ECM connector B-108 by using power plant ECU check harness special tool MB992110.**

(1) Disconnect all ECM connectors. Connect the power plant ECU check harness special tool MB992110 between the separated connectors.

(2) Turn the ignition switch to the "ON" position.

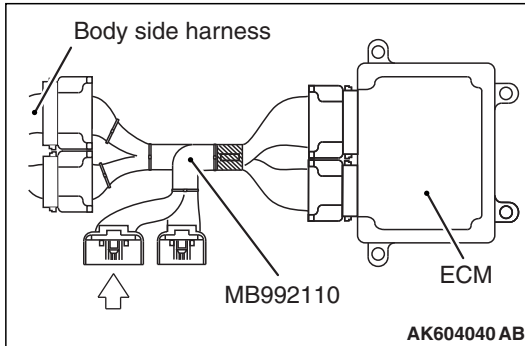

(3) Measure the voltage between terminal No. 44 and ground.

- Voltage should be between 4.9 and 5.1 volts.

(4) Turn the ignition switch to the "LOCK" (OFF) position.

**Q: Is the measured voltage between 4.9 and 5.1 volts?**

**YES :** Go to Step 7.

**NO :** Go to Step 5.

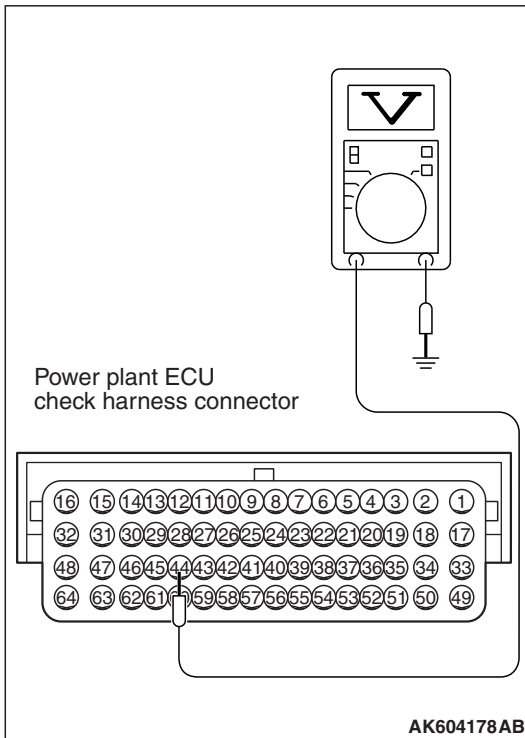

**STEP 5. Check harness connector B-117 at manifold absolute pressure sensor for damage.**

**Q: Is the harness connector in good condition?**

**YES :** Go to Step 6.

**NO :** Repair or replace it. Refer to GROUP 00E, Harness Connector Inspection [P.00E-2](#). Then go to Step 13.

**STEP 6. Check for short circuit to ground between manifold absolute pressure sensor connector B-117 (terminal No. 3) and ECM connector B-108 (terminal No. 44).**

**Q: Is the harness wire in good condition?**

**YES :** Go to Step 12.

**NO :** Repair it. Then go to Step 13.

**STEP 7. Check harness connector B-117 at manifold absolute pressure sensor for damage.**

**Q: Is the harness connector in good condition?**

**YES :** Repair harness wire between manifold absolute pressure sensor connector B-117 (terminal No. 3) and ECM connector B-108 (terminal No. 44) because of open circuit. Then go to Step 13.

**NO :** Repair or replace it. Refer to GROUP 00E, Harness Connector Inspection [P.00E-2](#). Then go to Step 13.

**STEP 8. Check harness connector B-108 at ECM for damage.**

**Q: Is the harness connector in good condition?**

**YES :** Go to Step 9.

**NO :** Repair or replace it. Refer to GROUP 00E, Harness Connector Inspection [P.00E-2](#). Then go to Step 13.

**STEP 9. Measure the sensor output voltage at ECM connector B-108 by using power plant ECU check harness special tool MB992110.**

- (1) Disconnect all ECM connectors. Connect the power plant ECU check harness special tool MB992110 between the separated connectors.
- (2) Turn the ignition switch to the "ON" position.

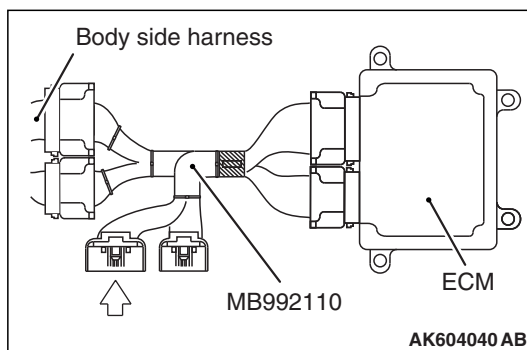



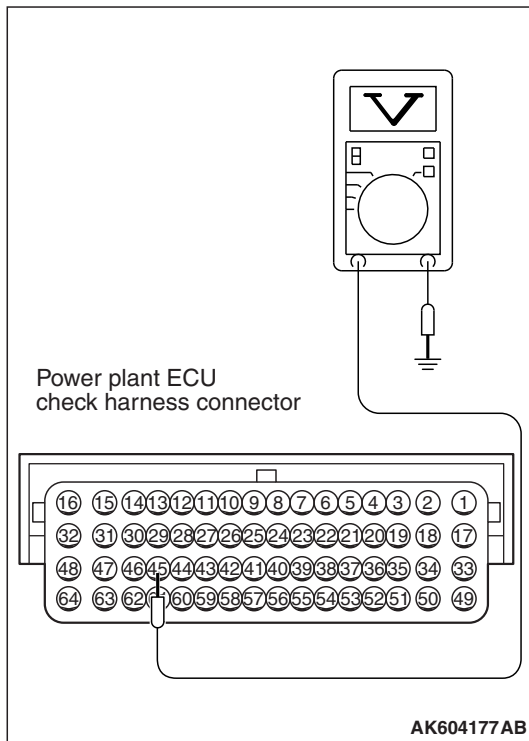

- (3) Measure the voltage between terminal No. 45 and ground.
- When altitude is 0 m (0 foot), voltage should be between 3.8 and 4.2 volts.
  - When altitude is 600 m (1,969 feet), voltage should be between 3.5 and 3.9 volts.
  - When altitude is 1,200 m (3,937 feet), voltage should be between 3.3 and 3.7 volts.
  - When altitude is 1,800 m (5,906 feet), voltage should be between 3.0 and 3.4 volts.
- (4) Turn the ignition switch to the "LOCK" (OFF) position.

**Q: Is the measured voltage normal?**

**YES :** Go to Step 12.

**NO :** Go to Step 10.

---

**STEP 10. Check harness connector B-117 at manifold absolute pressure sensor for damage.**

**Q: Is the harness connector in good condition?**

**YES :** Go to Step 11.

**NO :** Repair or replace it. Refer to GROUP 00E, Harness Connector Inspection [P.00E-2](#). Then go to Step 13.

---

**STEP 11. Check for open circuit and short circuit to ground between manifold absolute pressure sensor connector B-117 (terminal No. 1) and ECM connector B-108 (terminal No. 45).**

**Q: Is the harness wire in good condition?**

**YES :** Replace the manifold absolute pressure sensor. Then go to Step 13.

**NO :** Repair it. Then go to Step 13.

**STEP 12. Using scan tool MB991958, check data list item 8: Manifold Absolute Pressure Sensor.**

- (1) Turn the ignition switch to the "ON" position.
- (2) Set scan tool MB991958 to the data reading mode for item 8, Manifold Absolute Pressure Sensor.
  - When altitude is 0 m (0 foot), 101 kPa (29.8 in.Hg).
  - When altitude is 600 m (1,969 feet), 95 kPa (28.1 in.Hg).
  - When altitude is 1,200 m (3,937 feet), 88 kPa (26.0 in.Hg).
  - When altitude is 1,800 m (5,906 feet), 81 kPa (23.9 in.Hg).
- (3) Start the engine.
  - Warm up the engine. When the engine is idling, 16 –36 kPa (4.7 –10.6 in.Hg).
  - When the engine is suddenly revved, manifold absolute pressure varies.
- (4) Turn the ignition switch to the "LOCK" (OFF) position.

**Q: Is the sensor operating properly?**

**YES :** It can be assumed that this malfunction is intermittent. Refer to GROUP 00, How to Use Troubleshooting/Inspection Service Points –How to Cope with Intermittent Malfunctions [P.00-13](#).

**NO :** Replace the ECM (Refer to, Removal and Installation [P.13B-1022](#)). Then go to Step 13.

---

**STEP 13. Test the OBD-II drive cycle.**

- (1) Carry out a test drive with the drive cycle pattern. Refer to Diagnostic Function –OBD-II Drive Cycle –Pattern 7 [P.13B-12](#).
- (2) Check the diagnostic trouble code (DTC).

**Q: Is DTC P0107 set?**

**YES :** Retry the troubleshooting.

**NO :** The inspection is complete.

DTC P0108: Manifold Absolute Pressure Circuit High Input

MANIFOLD ABSOLUTE PRESSURE SENSOR CIRCUIT

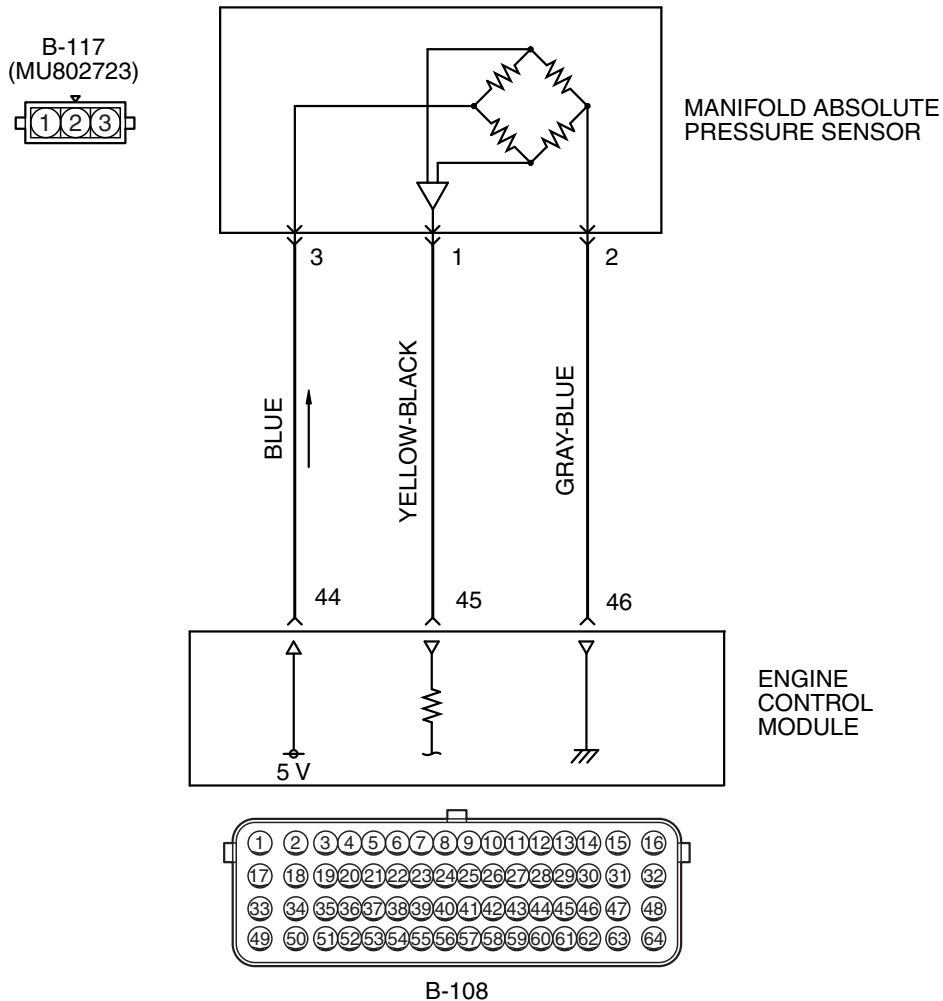

AK604115 AD

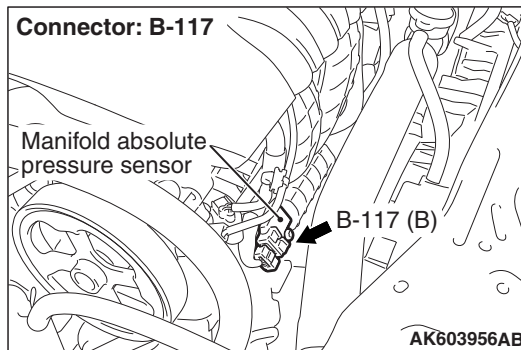
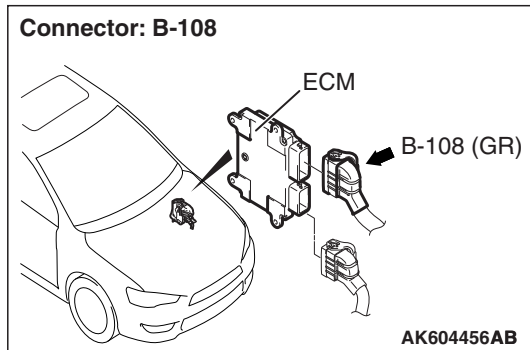

**CIRCUIT OPERATION**

- A 5-volt voltage is supplied to the manifold absolute pressure sensor power terminal (terminal No. 3) from ECM (terminal No. 44). The ground terminal (terminal No. 2) is grounded with ECM (terminal No. 46).
- A voltage that is proportional to the intake manifold pressure is sent to the ECM (terminal No. 45) from the manifold absolute pressure sensor output terminal (terminal No. 1).

**TECHNICAL DESCRIPTION**

- The manifold absolute pressure sensor outputs a voltage which corresponds to the intake manifold pressure.
- The ECM checks whether this voltage is within a specified range.

**DESCRIPTIONS OF MONITOR METHODS**

Manifold absolute pressure sensor output voltage is out of specified range.

**MONITOR EXECUTION**

Continuous

**MONITOR EXECUTION CONDITIONS  
(Other monitor and Sensor)**

**Other Monitor (There is no temporary DTC stored in memory for the item monitored below)**

- Not applicable

**Sensor (The sensor below is determined to be normal)**

- Mass airflow sensor
- Engine coolant temperature sensor
- Intake air temperature sensor
- Barometric pressure sensor
- Throttle position sensor

## DTC SET CONDITIONS

### Logic Flow Chart

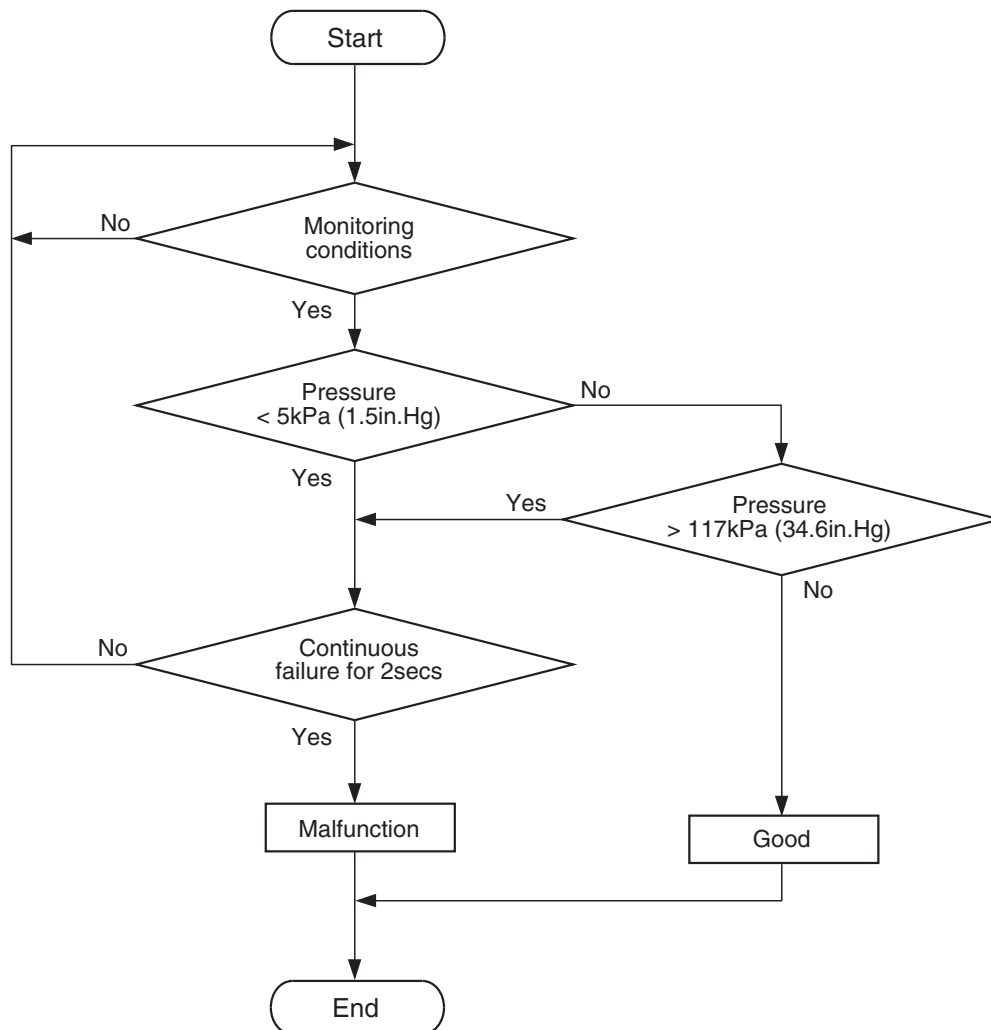

AK604313

#### Check Condition

- More than 8 minutes have passed since the engine starting sequence was completed, when the engine coolant temperature at engine start is less than 0° C (32° F).

#### Judgement Criterion

- Manifold absolute pressure sensor output voltage is more than 4.6 volts [corresponding to a manifold absolute pressure of 117 kPa (34.6 in.Hg)] for 2 seconds.

#### FAIL-SAFE AND BACKUP FUNCTION

- Control as if the intake manifold vacuum pressure is 101 kPa (29.8 in.Hg).

#### OBD-II DRIVE CYCLE PATTERN

Refer to Diagnostic Function –OBD-II Drive Cycle – Pattern 23 [P.13B-12](#).

#### TROUBLESHOOTING HINTS (The most likely causes for this code to be set are:)

- Manifold absolute pressure sensor failed.
- Open manifold absolute pressure sensor circuit, or connector damage.
- ECM failed.

**DIAGNOSIS****Required Special Tool:**

- MB991958: Scan Tool (M.U.T.-III Sub Assembly)
  - MB991824: V.C.I.
  - MB991827: USB Cable
  - MB991910: Main Harness A

**STEP 1. Using scan tool MB991958, check data list item 8: Manifold Absolute Pressure Sensor.****⚠ CAUTION**

To prevent damage to scan tool MB991958, always turn the ignition switch to the "LOCK" (OFF) position before connecting or disconnecting scan tool MB991958.

- (1) Connect scan tool MB991958 to the data link connector.
- (2) Turn the ignition switch to the "ON" position.
- (3) Set scan tool MB991958 to the data reading mode for item 8, Manifold Absolute Pressure Sensor.
  - When altitude is 0 m (0 foot), 101 kPa (29.8 in.Hg).
  - When altitude is 600 m (1,969 feet), 95 kPa (28.1 in.Hg).
  - When altitude is 1,200 m (3,937 feet), 88 kPa (26.0 in.Hg).
  - When altitude is 1,800 m (5,906 feet), 81 kPa (23.9 in.Hg).
- (4) Start the engine.
  - Warm up the engine. When the engine is idling, 16 –36 kPa (4.7 –10.6 in.Hg).
  - When the engine is suddenly revved, manifold absolute pressure varies.
- (5) Turn the ignition switch to the "LOCK" (OFF) position.

**Q: Is the sensor operating properly?**

- YES** : It can be assumed that this malfunction is intermittent. Refer to GROUP 00, How to Use Troubleshooting/Inspection Service Points –How to Cope with Intermittent Malfunctions P.00-13.
- NO** : Go to Step 2.

**STEP 2. Measure the ground voltage at manifold absolute pressure sensor connector B-117 by backprobing.**

- (1) Do not disconnect the connector B-117.
- (2) Turn the ignition switch to the "ON" position.
- (3) Measure the voltage between terminal No. 2 and ground by backprobing.
  - Voltage should be 0.5 volt or less.
- (4) Turn the ignition switch to the "LOCK" (OFF) position.

**Q: Is the measured voltage 0.5 volt or less?**

- YES** : Go to Step 6.
- NO** : Go to Step 3.

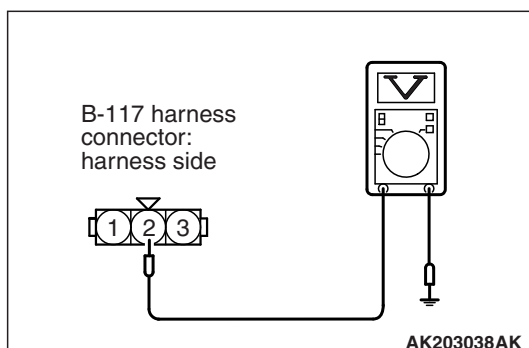
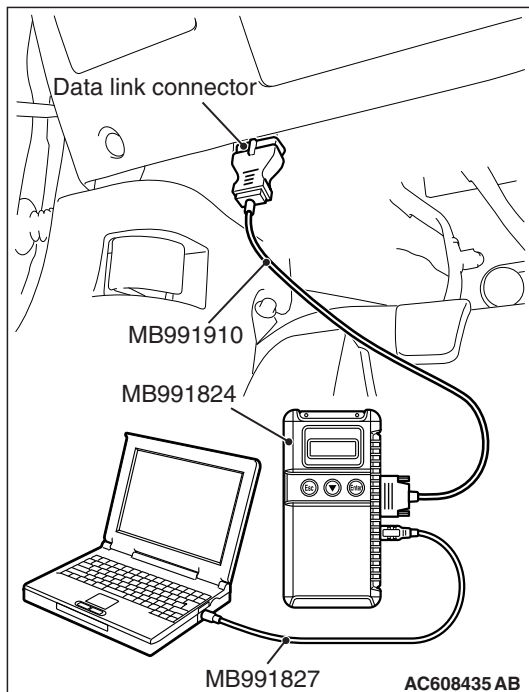

---

**STEP 3. Check harness connector B-117 at manifold absolute pressure sensor and harness connector B-108 at ECM for damage.**

**Q: Are the harness connectors in good condition?**

**YES :** Go to Step 4.

**NO :** Repair or replace them. Refer to GROUP 00E, Harness Connector Inspection [P.00E-2](#). Then go to Step 7.

---

**STEP 4. Check for open circuit between manifold absolute pressure sensor connector B-117 (terminal No. 2) and ECM connector B-108 (terminal No. 46).**

**Q: Is the harness wire in good condition?**

**YES :** Go to Step 5.

**NO :** Repair it. Then go to Step 7.

---

**STEP 5. Using scan tool MB991958, check data list item 8: Manifold Absolute Pressure Sensor.**

(1) Turn the ignition switch to the "ON" position.

(2) Set scan tool MB991958 to the data reading mode for item 8, Manifold Absolute Pressure Sensor.

- When altitude is 0 m (0 foot), 101 kPa (29.8 in.Hg).
- When altitude is 600 m (1,969 feet), 95 kPa (28.1 in.Hg).
- When altitude is 1,200 m (3,937 feet), 88 kPa (26.0 in.Hg).
- When altitude is 1,800 m (5,906 feet), 81 kPa (23.9 in.Hg).

(3) Start the engine.

- Warm up the engine. When the engine is idling, 16 –36 kPa (4.7 –10.6 in.Hg).
- When the engine is suddenly revved, manifold absolute pressure varies.

(4) Turn the ignition switch to the "LOCK" (OFF) position.

**Q: Is the sensor operating properly?**

**YES :** It can be assumed that this malfunction is intermittent. Refer to GROUP 00, How to Use Troubleshooting/Inspection Service Points –How to Cope with Intermittent Malfunctions [P.00-13](#).

**NO :** Replace the ECM (Refer to, Removal and Installation [P.13B-1022](#)). Then go to Step 7.

---

**STEP 6. Check harness connector B-117 at manifold absolute pressure sensor and harness connector B-108 at ECM for damage.**

**Q: Are the harness connectors in good condition?**

**YES :** Replace the manifold absolute pressure sensor. Then go to Step 7.

**NO :** Repair or replace them. Refer to GROUP 00E, Harness Connector Inspection [P.00E-2](#). Then go to Step 7.

**STEP 7. Test the OBD-II drive cycle.**

- (1) Carry out a test drive with the drive cycle pattern. Refer to Diagnostic Function –OBD-II Drive Cycle –Pattern 23 P.13B-12.
- (2) Check the diagnostic trouble code (DTC).

**Q: Is DTC P0108 set?**

- YES :** Retry the troubleshooting.  
**NO :** The inspection is complete.

**DTC P0111: Intake Air Temperature Circuit Range/Performance Problem**

**INTAKE AIR TEMPERATURE SENSOR CIRCUIT**

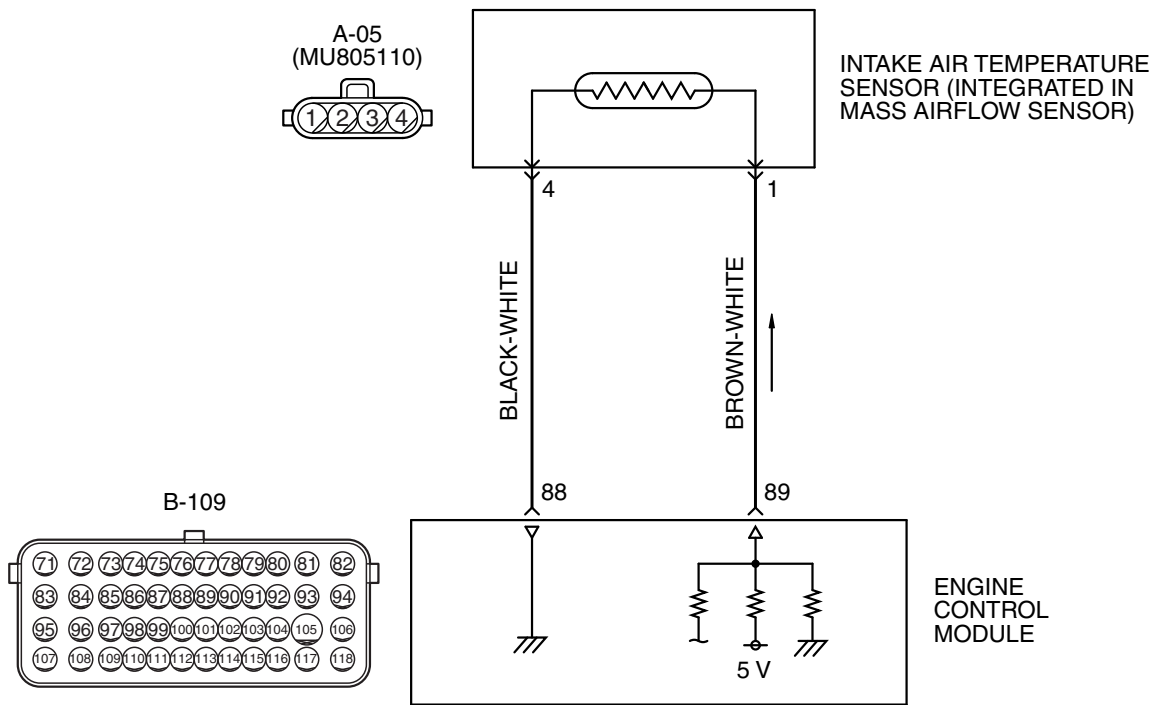

AK603947AB

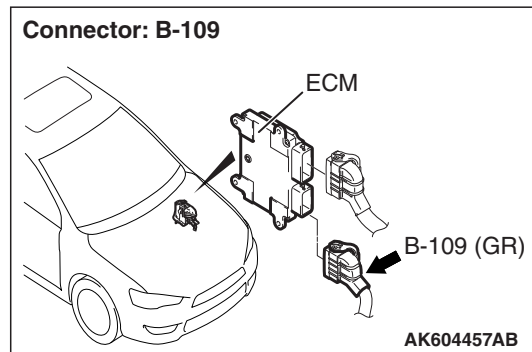
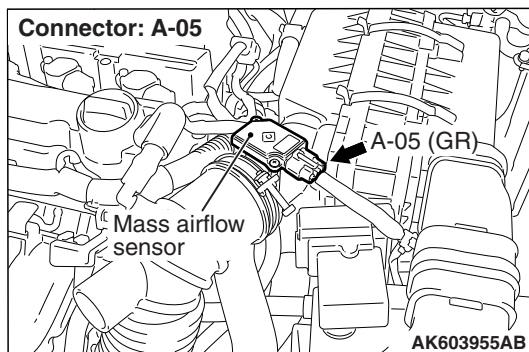



## CIRCUIT OPERATION

- Approximately 5 volts are applied to the intake air temperature sensor output terminal (terminal No. 1) from the ECM (terminal No. 89) via the resistor in the ECM. The ground terminal (terminal No. 4) is grounded with ECM (terminal No. 88).
- The intake air temperature sensor is a negative temperature coefficient type of resistor. When the intake air temperature rises, the resistance decreases.
- The intake air temperature sensor output voltage increases when the resistance increases and decreases when the resistance decreases.

## TECHNICAL DESCRIPTION

- The intake air temperature sensor converts the intake air temperature to a voltage.
- The ECM checks whether this voltage is within a specified range.

## DESCRIPTIONS OF MONITOR METHODS

Intake air temperature sensor output voltage does not change when specified go/stop operations are repeated.

## MONITOR EXECUTION

Continuous

## MONITOR EXECUTION CONDITIONS (Other monitor and Sensor)

**Other Monitor (There is no temporary DTC stored in memory for the item monitored below)**

- Not applicable

**Sensor (The sensor below is determined to be normal)**

- Engine coolant temperature sensor

## DTC SET CONDITIONS

## Logic Flow Chart

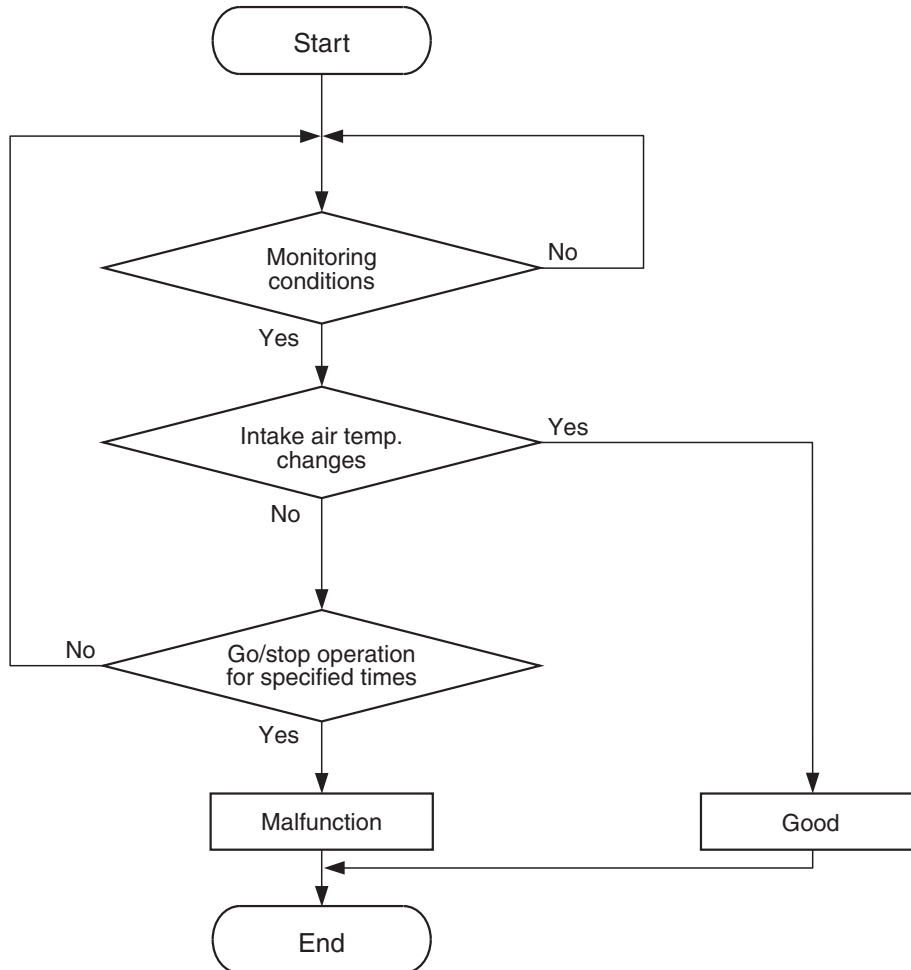

AK604314

**Check Conditions**

- Engine coolant temperature is more than 76° C (169° F).
- Repeat 2 times or more: drive<sup>\*1</sup>, stop<sup>\*2</sup>.  
Drive<sup>\*1</sup>:
  - Vehicle speed is more than 50 km/h (31 mph) lasting a total of 60 seconds or more.
- Stop<sup>\*2</sup>:
  - Vehicle speed is less than 1.5 km/h (1.0 mph) lasting 30 seconds or more.

**Judgement Criterion**

- Changes in the intake air temperature is less than 1° C (1.8° F).

**FAIL-SAFE AND BACKUP FUNCTION**

- Control as if the intake air temperature is 25° C (77° F).

**OBD-II DRIVE CYCLE PATTERN**

Refer to Diagnostic Function –OBD-II Drive Cycle – Pattern 8 [P.13B-12](#).

**TROUBLESHOOTING HINTS (The most likely causes for this code to be set are:)**

- Intake air temperature sensor failed.
- Harness damage or connector damage.
- ECM failed.

## DIAGNOSIS

### Required Special Tool:

- MB991958: Scan Tool (M.U.T.-III Sub Assembly)
  - MB991824: V.C.I.
  - MB991827: USB Cable
  - MB991910: Main Harness A

### STEP 1. Using scan tool MB991958, check data list item 5: Intake Air Temperature Sensor.

#### **CAUTION**

To prevent damage to scan tool MB991958, always turn the ignition switch to the "LOCK" (OFF) position before connecting or disconnecting scan tool MB991958.

- (1) Connect scan tool MB991958 to the data link connector.
- (2) Remove the mass airflow sensor from the air intake hose.
- (3) Turn the ignition switch to the "ON" position.
- (4) Set scan tool MB991958 to the data reading mode for item 5, Intake Air Temperature Sensor.

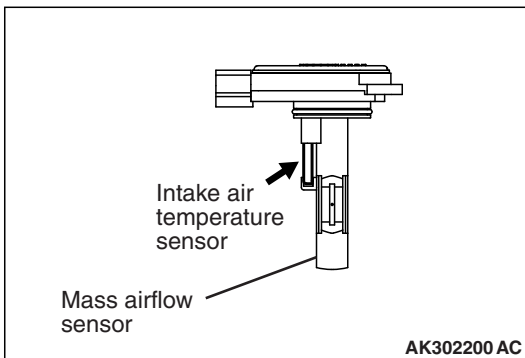
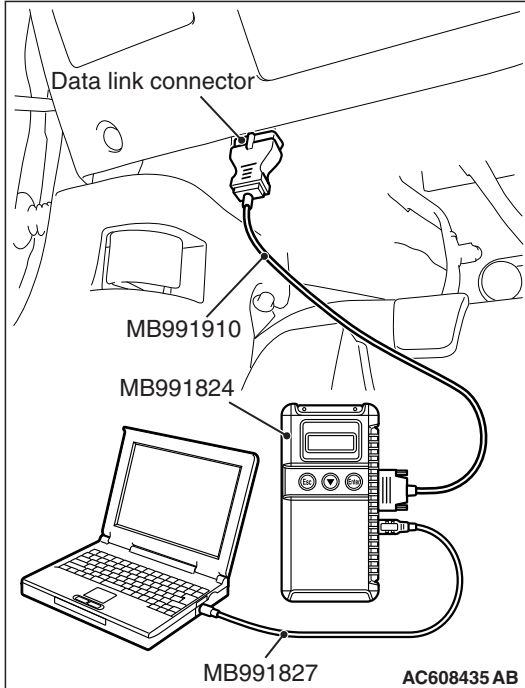

- (5) Heating the sensor using a hair drier.
  - The indicated temperature increases.

*NOTE: Do not allow it to increase over 80°C (176°F).*

- (6) Turn the ignition switch to the "LOCK" (OFF) position.
- (7) Attach the mass airflow sensor.

#### Q: Is the sensor operating properly?

**YES** : It can be assumed that this malfunction is intermittent. Refer to GROUP 00, How to Use Troubleshooting/Inspection Service Points –How to Cope with Intermittent Malfunctions P.00-13.

**NO** : Go to Step 2.

### STEP 2. Check harness connector A-05 at intake air temperature sensor for damage.

#### Q: Is the harness connector in good condition?

**YES** : Go to Step 3.

**NO** : Repair or replace it. Refer to GROUP 00E, Harness Connector Inspection P.00E-2. Then go to Step 10.

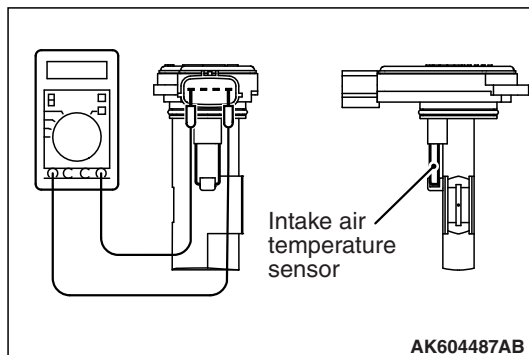
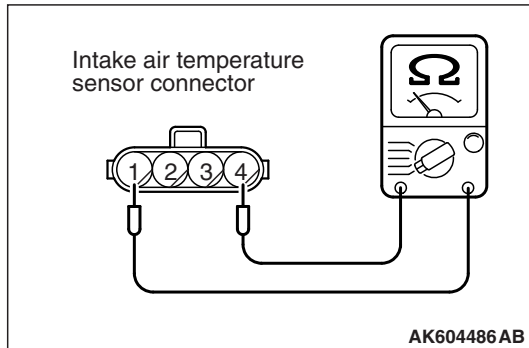
**STEP 3. Check the intake air temperature sensor.**

- (1) Disconnect the intake air temperature sensor connector A-05.
- (2) Measure the resistance between intake air temperature sensor side connector terminal No. 1 and No. 4.

- (3) Measure resistance while heating the sensor using a hair drier.

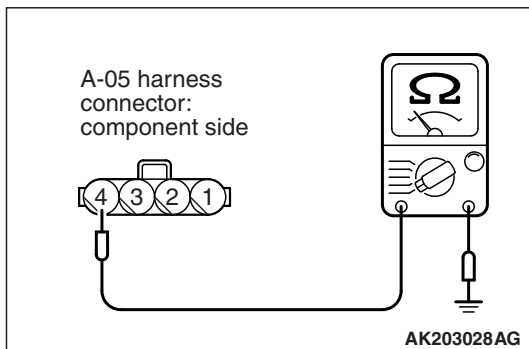
**Standard value:**13 –17 k $\Omega$  [at –20° C (–4° F)]5.4 –6.6 k $\Omega$  [at 0° C (32° F)]2.3 –3.0 k $\Omega$  [at 20° C (68° F)]1.0 –1.5 k $\Omega$  [at 40° C (104° F)]0.56 –0.76 k $\Omega$  [at 60° C (140° F)]0.31 –0.43 k $\Omega$  [at 80° C (176° F)]**Q: Is the measured resistance at the standard value?****YES** : Go to Step 4.**NO** : Replace the mass airflow sensor. Then go to Step 10.**STEP 4. Check the continuity at intake air temperature sensor harness side connector A-05.**

- (1) Disconnect the connector A-05 and measure at the harness side.
- (2) Check for the continuity between terminal No. 4 and ground.
  - Continuity (2 ohms or less)

**Q: Does continuity exist?****YES** : Go to Step 7.**NO** : Go to Step 5.**STEP 5. Check harness connector B-109 at ECM for damage.****Q: Is the harness connector in good condition?****YES** : Go to Step 6.**NO** : Repair or replace it. Refer to GROUP 00E, Harness Connector Inspection [P.00E-2](#). Then go to Step 10.

---

**STEP 6. Check for harness damage between intake air temperature sensor connector A-05 (terminal No. 4) and ECM connector B-109 (terminal No. 88).**

**Q: Is the harness wire in good condition?**

**YES :** Go to Step 9.

**NO :** Repair it. Then go to Step 10.

---

**STEP 7. Check harness connector B-109 at ECM for damage.**

**Q: Is the harness connector in good condition?**

**YES :** Go to Step 8.

**NO :** Repair or replace it. Refer to GROUP 00E, Harness Connector Inspection [P.00E-2](#). Then go to Step 10.

---

**STEP 8. Check for harness damage between intake air temperature sensor connector A-05 (terminal No. 1) and ECM connector B-109 (terminal No. 89).**

**Q: Is the harness wire in good condition?**

**YES :** Go to Step 9.

**NO :** Repair it. Then go to Step 10.

---

**STEP 9. Using scan tool MB991958, check data list item 5: Intake Air Temperature Sensor.**

(1) Turn the ignition switch to the "ON" position.

(2) Set scan tool MB991958 to the data reading mode for item 5, Intake Air Temperature Sensor.

- The intake air temperature and temperature shown with the scan tool should approximately match.

(3) Turn the ignition switch to the "LOCK" (OFF) position.

**Q: Is the sensor operating properly?**

**YES :** It can be assumed that this malfunction is intermittent. Refer to GROUP 00, How to Use Troubleshooting/Inspection Service Points –How to Cope with Intermittent Malfunctions [P.00-13](#).

**NO :** Replace the ECM (Refer to, Removal and Installation [P.13B-1022](#)). Then go to Step 10.

---

**STEP 10. Test the OBD-II drive cycle.**

(1) Carry out a test drive with the drive cycle pattern. Refer to Diagnostic Function –OBD-II Drive Cycle –Pattern 8 [P.13B-12](#).

(2) Check the diagnostic trouble code (DTC).

**Q: Is DTC P0111 set?**

**YES :** Retry the troubleshooting.

**NO :** The inspection is complete.

DTC P0112: Intake Air Temperature Circuit Low Input

INTAKE AIR TEMPERATURE SENSOR CIRCUIT

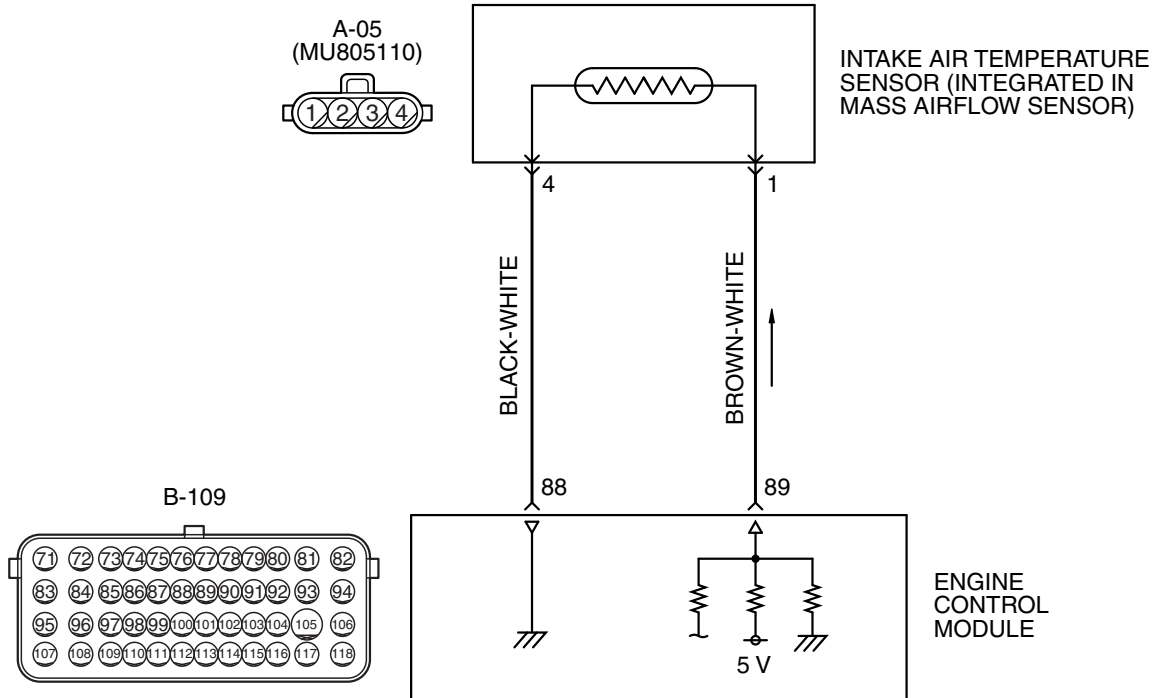

AK603947AB

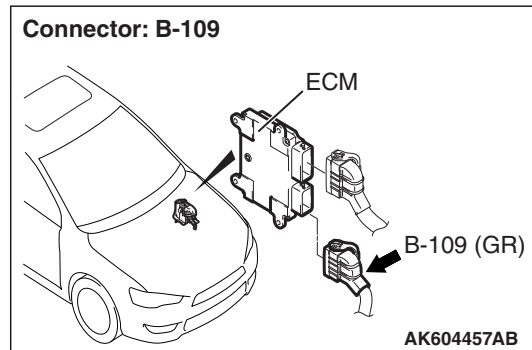
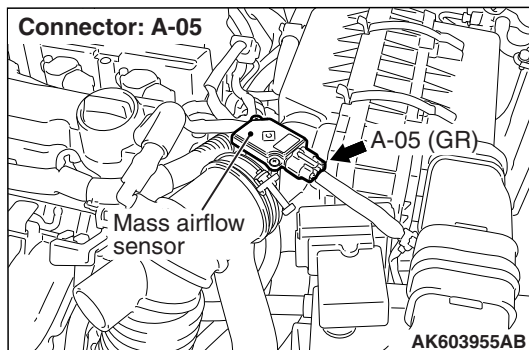

**CIRCUIT OPERATION**

- Approximately 5 volts are applied to the intake air temperature sensor output terminal (terminal No. 1) from the ECM (terminal No. 89) via the resistor in the ECM. The ground terminal (terminal No. 4) is grounded with ECM (terminal No. 88).
- The intake air temperature sensor is a negative temperature coefficient type of resistor. When the intake air temperature rises, the resistance decreases.

- The intake air temperature sensor output voltage increases when the resistance increases and decreases when the resistance decreases.

**TECHNICAL DESCRIPTION**

- The intake air temperature sensor converts the intake air temperature to a voltage.
- The ECM checks whether this voltage is within a specified range.

**DESCRIPTIONS OF MONITOR METHODS**

Intake air temperature sensor output voltage is out of specified range.

**MONITOR EXECUTION**

Continuous

**MONITOR EXECUTION CONDITIONS**

**(Other monitor and Sensor)**

**Other Monitor (There is no temporary DTC stored in memory for the item monitored below)**

- Not applicable

**Sensor (The sensor below is determined to be normal)**

- Not applicable

**DTC SET CONDITIONS**

**Logic Flow Chart**

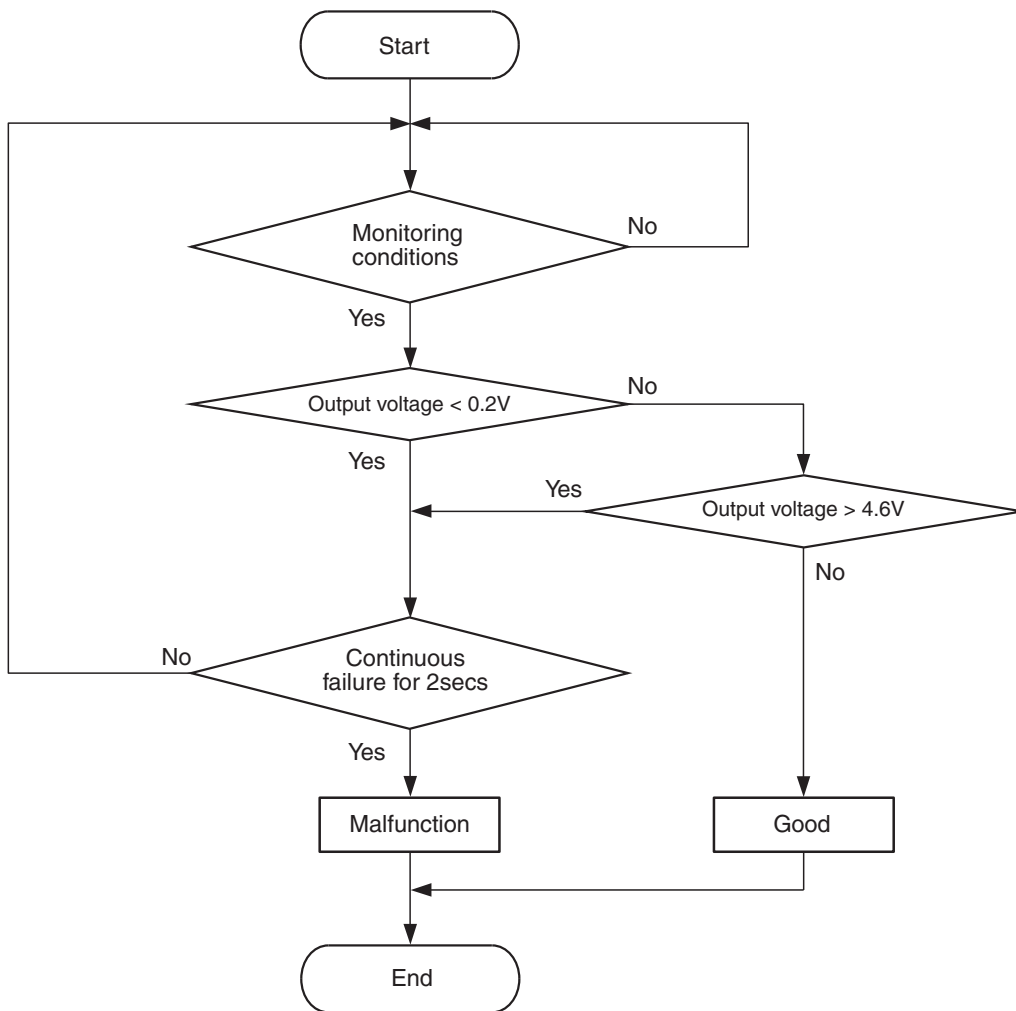

AK604315

**Check Condition**

- More than 2 seconds have passed since the engine starting sequence was completed.

**Judgement Criterion**

- Intake air temperature sensor output voltage is less than 0.2 volt [corresponding to an intake air temperature of 115° C (239° F) or more] for 2 seconds.

**FAIL-SAFE AND BACKUP FUNCTION**

- Control as if the intake air temperature is 25° C (77° F).

**OBD-II DRIVE CYCLE PATTERN**

Refer to Diagnostic Function –OBD-II Drive Cycle – Pattern 23 [P.13B-12](#).

**TROUBLESHOOTING HINTS (The most likely causes for this code to be set are:)**

- Intake air temperature sensor failed.
- Shorted intake air temperature sensor circuit, or connector damage.
- ECM failed.

**DIAGNOSIS****Required Special Tool:**

- MB991958: Scan Tool (M.U.T.-III Sub Assembly)
  - MB991824: V.C.I.
  - MB991827: USB Cable
  - MB991910: Main Harness A

**STEP 1. Using scan tool MB991958, check data list item 5: Intake Air Temperature Sensor.****⚠ CAUTION**

To prevent damage to scan tool MB991958, always turn the ignition switch to the "LOCK" (OFF) position before connecting or disconnecting scan tool MB991958.

- Connect scan tool MB991958 to the data link connector.
- Turn the ignition switch to the "ON" position.
- Set scan tool MB991958 to the data reading mode for item 5, Intake Air Temperature Sensor.
  - The intake air temperature and temperature shown with the scan tool should approximately match.
- Turn the ignition switch to the "LOCK" (OFF) position.

**Q: Is the sensor operating properly?**

- YES** : It can be assumed that this malfunction is intermittent. Refer to GROUP 00, How to Use Troubleshooting/Inspection Service Points –How to Cope with Intermittent Malfunctions [P.00-13](#).
- NO** : Go to Step 2.

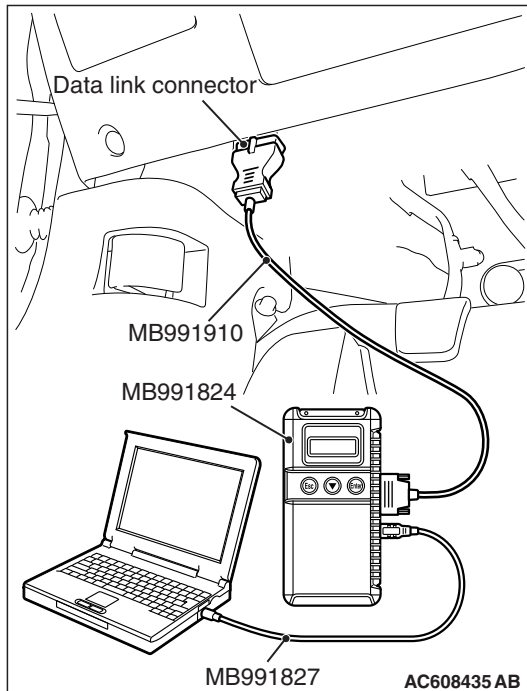
**STEP 2. Check harness connector A-05 at intake air temperature sensor for damage.****Q: Is the harness connector in good condition?**

- YES** : Go to Step 3.
- NO** : Repair or replace it. Refer to GROUP 00E, Harness Connector Inspection [P.00E-2](#). Then go to Step 7.



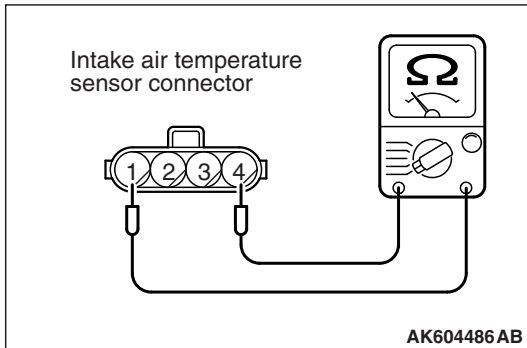

**STEP 3. Check the intake air temperature sensor.**

- (1) Disconnect the intake air temperature sensor connector A-05.
- (2) Measure the resistance between intake air temperature sensor side connector terminal No. 1 and No. 4.
  - There should be continuity. (0.31 –17 k $\Omega$ )

**Q: Is the measured resistance between 0.31 and 17 k $\Omega$ ?**

**YES :** Go to Step 4.

**NO :** Replace the mass airflow sensor. Then go to Step 7.

**STEP 4. Check harness connector B-109 at ECM for damage.**

**Q: Is the harness connector in good condition?**

**YES :** Go to Step 5.

**NO :** Repair or replace it. Refer to GROUP 00E, Harness Connector Inspection [P.00E-2](#). Then go to Step 7.

**STEP 5. Check for short circuit to ground between intake air temperature sensor connector A-05 (terminal No. 1) and ECM connector B-109 (terminal No. 89).**

**Q: Is the harness wire in good condition?**

**YES :** Go to Step 6.

**NO :** Repair it. Then go to Step 7.

**STEP 6. Using scan tool MB991958, check data list item 5: Intake Air Temperature Sensor.**

- (1) Turn the ignition switch to the "ON" position.
- (2) Set scan tool MB991958 to the data reading mode for item 5, Intake Air Temperature Sensor.
  - The intake air temperature and temperature shown with the scan tool should approximately match.
- (3) Turn the ignition switch to the "LOCK" (OFF) position.

**Q: Is the sensor operating properly?**

**YES :** It can be assumed that this malfunction is intermittent. Refer to GROUP 00, How to Use Troubleshooting/Inspection Service Points –How to Cope with Intermittent Malfunctions [P.00-13](#).

**NO :** Replace the ECM (Refer to, Removal and Installation [P.13B-1022](#)). Then go to Step 7.

**STEP 7. Test the OBD-II drive cycle.**

- (1) Carry out a test drive with the drive cycle pattern. Refer to Diagnostic Function –OBD-II Drive Cycle –Pattern 23 P.13B-12.
- (2) Check the diagnostic trouble code (DTC).

**Q: Is DTC P0112 set?**

- YES :** Retry the troubleshooting.  
**NO :** The inspection is complete.

**DTC P0113: Intake Air Temperature Circuit High Input**

**INTAKE AIR TEMPERATURE SENSOR CIRCUIT**

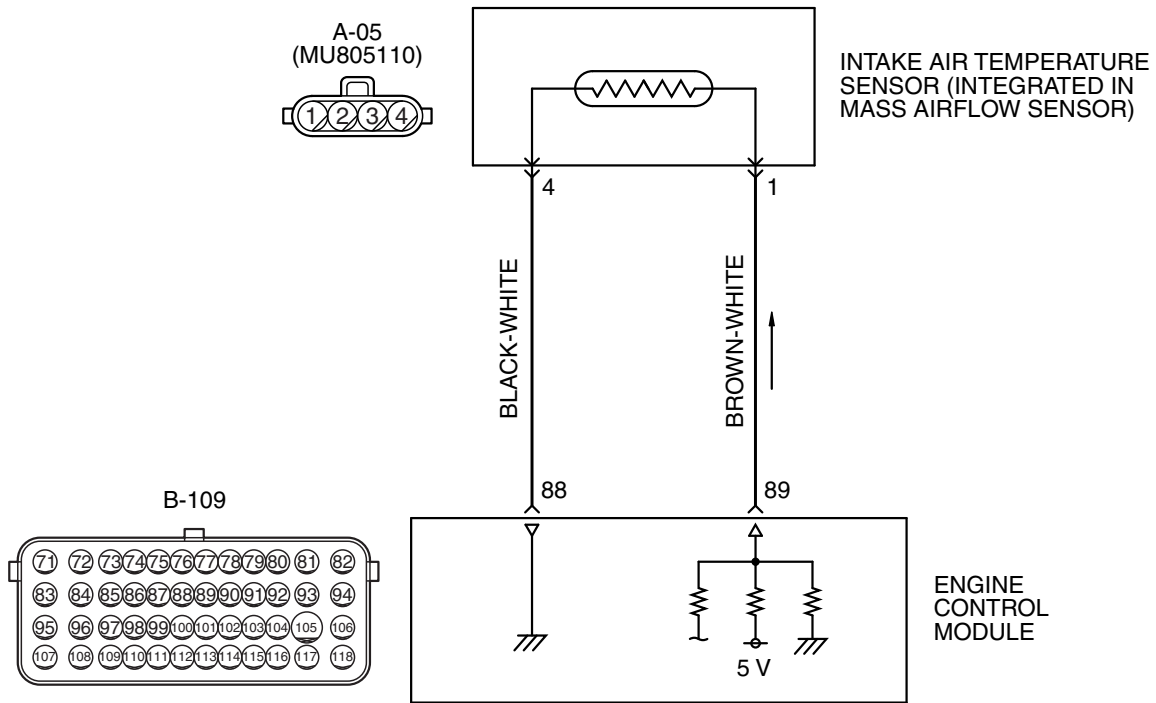

AK603947AB

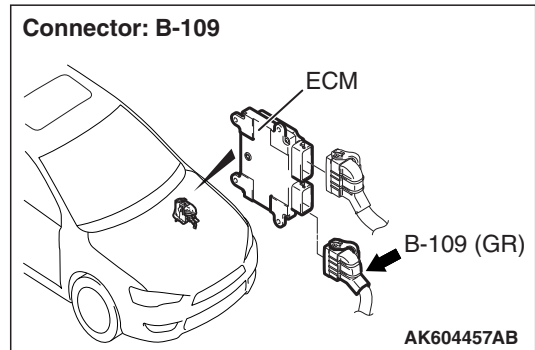
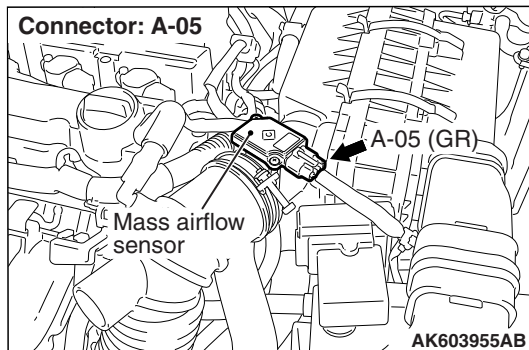

## CIRCUIT OPERATION

- Approximately 5 volts are applied to the intake air temperature sensor output terminal (terminal No. 1) from the ECM (terminal No. 89) via the resistor in the ECM. The ground terminal (terminal No. 4) is grounded with ECM (terminal No. 88).
- The intake air temperature sensor is a negative temperature coefficient type of resistor. When the intake air temperature rises, the resistance decreases.
- The intake air temperature sensor output voltage increases when the resistance increases and decreases when the resistance decreases.

## TECHNICAL DESCRIPTION

- The intake air temperature sensor converts the intake air temperature to a voltage.
- The ECM checks whether this voltage is within a specified range.

## DESCRIPTIONS OF MONITOR METHODS

Intake air temperature sensor output voltage is out of specified range.

## MONITOR EXECUTION

Continuous

## MONITOR EXECUTION CONDITIONS (Other monitor and Sensor)

**Other Monitor (There is no temporary DTC stored in memory for the item monitored below)**

- Not applicable

**Sensor (The sensor below is determined to be normal)**

- Not applicable

## DTC SET CONDITIONS

## Logic Flow Chart

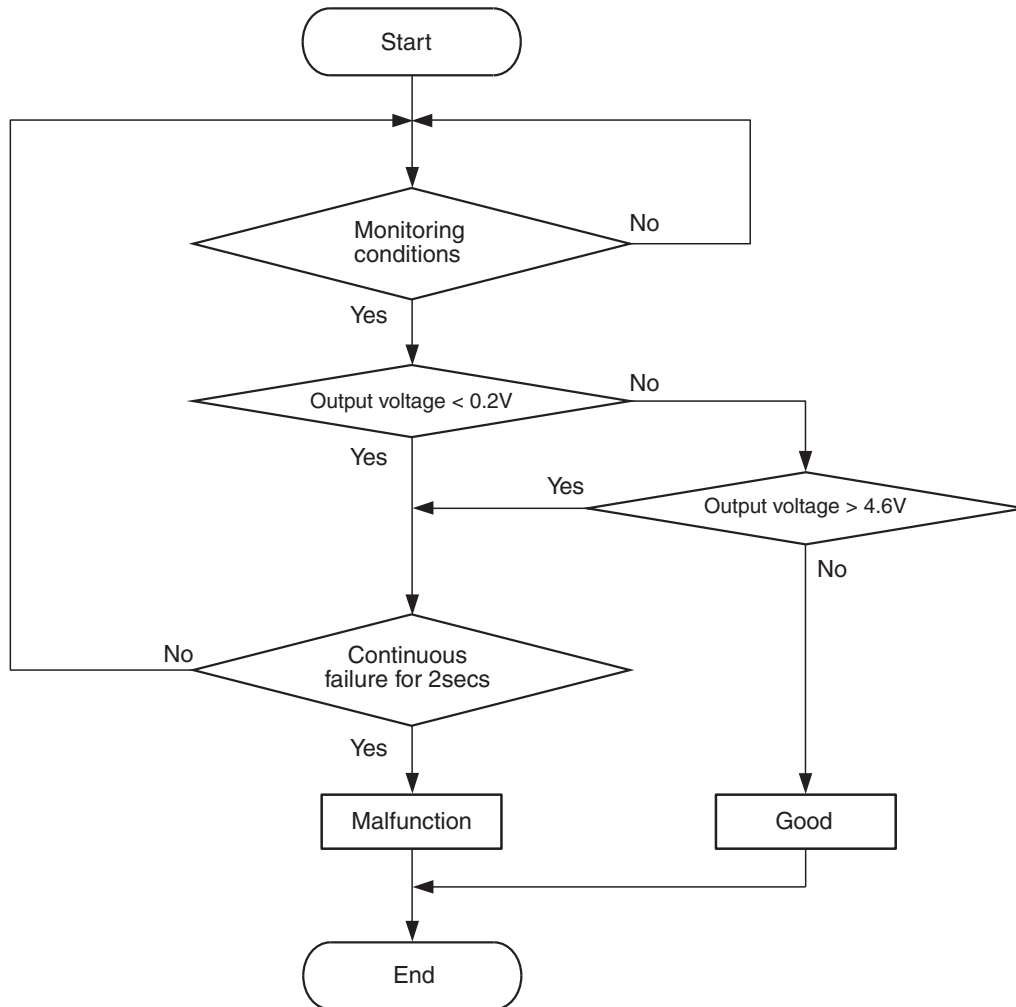

AK604315

**Check Condition**

- More than 2 seconds have passed since the engine starting sequence was completed.

**Judgement Criterion**

- Intake air temperature sensor output voltage is more than 4.6 volts [corresponding to an intake air temperature of  $-40^{\circ}\text{C}$  ( $-40^{\circ}\text{F}$ ) or less] for 2 seconds.

**FAIL-SAFE AND BACKUP FUNCTION**

- Control as if the intake air temperature is  $25^{\circ}\text{C}$  ( $77^{\circ}\text{F}$ ).

**OBD-II DRIVE CYCLE PATTERN**

Refer to Diagnostic Function –OBD-II Drive Cycle – Pattern 23 [P.13B-12](#).

**TROUBLESHOOTING HINTS (The most likely causes for this code to be set are: )**

- Intake air temperature sensor failed.
- Open intake air temperature sensor circuit, or connector damage.
- ECM failed.

## DIAGNOSIS

### Required Special Tools:

- MB991958: Scan Tool (M.U.T.-III Sub Assembly)
  - MB991824: V.C.I.
  - MB991827: USB Cable
  - MB991910: Main Harness A
- MB992110: Power Plant ECU Check Harness

### STEP 1. Using scan tool MB991958, check data list item 5: Intake Air Temperature Sensor.

#### **⚠ CAUTION**

To prevent damage to scan tool MB991958, always turn the ignition switch to the "LOCK" (OFF) position before connecting or disconnecting scan tool MB991958.

- (1) Connect scan tool MB991958 to the data link connector.
- (2) Turn the ignition switch to the "ON" position.
- (3) Set scan tool MB991958 to the data reading mode for item 5, Intake Air Temperature Sensor.
  - The intake air temperature and temperature shown with the scan tool should approximately match.
- (4) Turn the ignition switch to the "LOCK" (OFF) position.

#### **Q: Is the sensor operating properly?**

**YES** : It can be assumed that this malfunction is intermittent. Refer to GROUP 00, How to Use Troubleshooting/Inspection Service Points –How to Cope with Intermittent Malfunctions P.00-13.

**NO** : Go to Step 2.

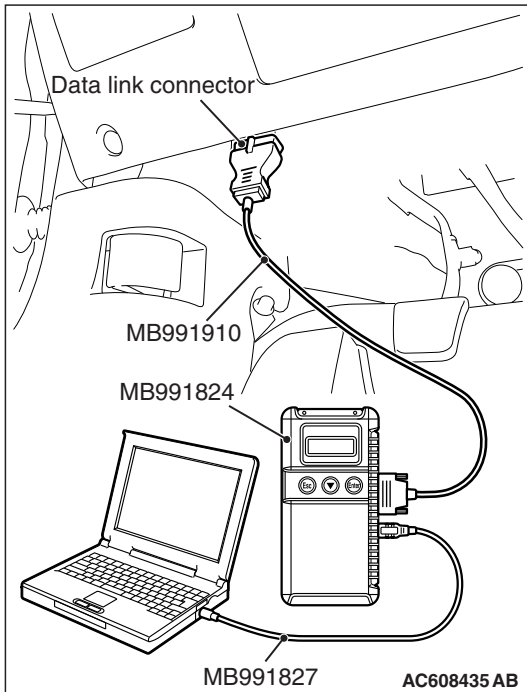

### STEP 2. Check harness connector A-05 at intake air temperature sensor for damage.

#### **Q: Is the harness connector in good condition?**

**YES** : Go to Step 3.

**NO** : Repair or replace it. Refer to GROUP 00E, Harness Connector Inspection P.00E-2. Then go to Step 11.

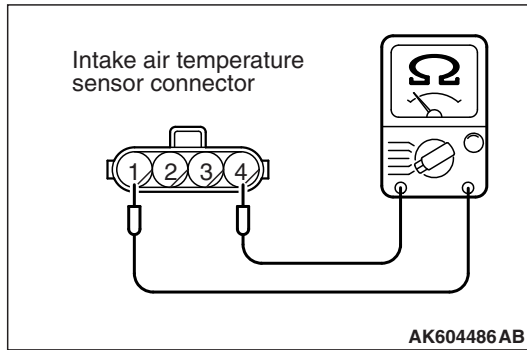
**STEP 3. Check the intake air temperature sensor.**

- (1) Disconnect the intake air temperature sensor connector A-05.
- (2) Measure the resistance between intake air temperature sensor side connector terminal No. 1 and No. 4.
  - There should be continuity. (0.31 –17 k $\Omega$ )

**Q: Is the measured resistance between 0.31 and 17 k $\Omega$ ?**

**YES :** Go to Step 4.

**NO :** Replace the mass airflow sensor. Then go to Step 11.

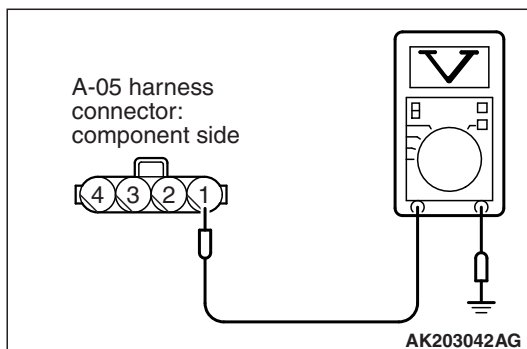
**STEP 4. Measure the sensor supply voltage at intake air temperature sensor harness side connector A-05.**

- (1) Disconnect the connector A-05 and measure at the harness side.
- (2) Turn the ignition switch to the "ON" position.
- (3) Measure the voltage between terminal No. 1 and ground.
  - Voltage should be between 4.5 and 4.9 volts.
- (4) Turn the ignition switch to the "LOCK" (OFF) position.

**Q: Is the measured voltage between 4.5 and 4.9 volts?**

**YES :** Go to Step 7.

**NO :** Go to Step 5.

**STEP 5. Check harness connector B-109 at ECM for damage.**

**Q: Is the harness connector in good condition?**

**YES :** Go to Step 6.

**NO :** Repair or replace it. Refer to GROUP 00E, Harness Connector Inspection [P.00E-2](#). Then go to Step 11.

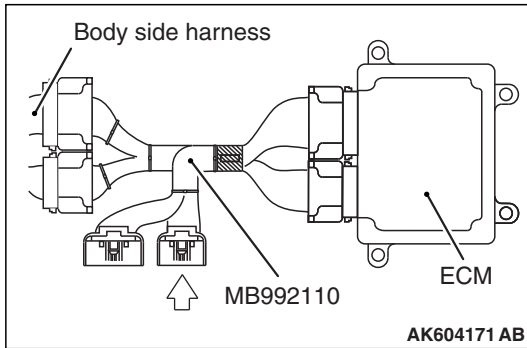

**STEP 6. Measure the sensor supply voltage at ECM connector B-109 by using power plant ECU check harness special tool MB992110.**

- (1) Disconnect all ECM connectors. Connect the power plant ECU check harness special tool MB992110 between the separated connectors.
- (2) Disconnect the intake air temperature sensor connector A-05.
- (3) Turn the ignition switch to the "ON" position.

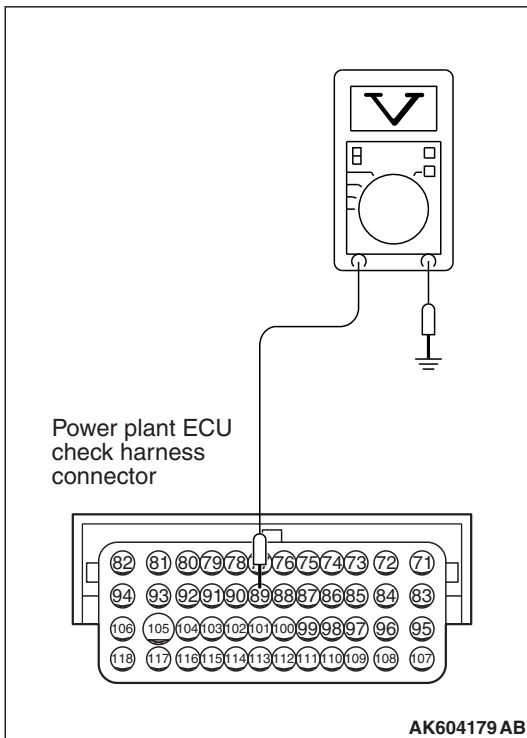

- (4) Measure the voltage between terminal No. 89 and ground.
  - Voltage should be between 4.5 and 4.9 volts.
- (5) Turn the ignition switch to the "LOCK" (OFF) position.

**Q: Is the measured voltage between 4.5 and 4.9 volts?**

**YES :** Repair harness wire between intake air temperature sensor connector A-05 (terminal No. 1) and ECM connector B-109 (terminal No. 89) because of open circuit. Then go to Step 11.

**NO :** Go to Step 10.

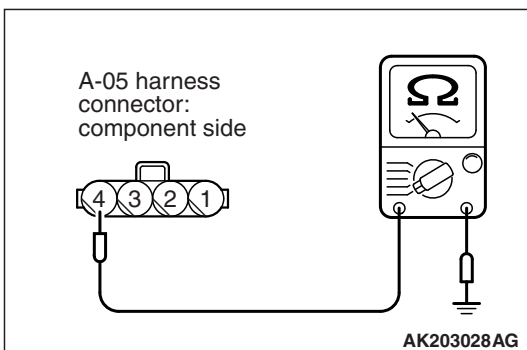

**STEP 7. Check the continuity at intake air temperature sensor harness side connector A-05.**

- (1) Disconnect the connector A-05 and measure at the harness side.
- (2) Check for the continuity between terminal No. 4 and ground.
  - Continuity (2 ohms or less)

**Q: Does continuity exist?**

**YES :** Go to Step 10.

**NO :** Go to Step 8.

---

**STEP 8. Check harness connector B-109 at ECM for damage.**

**Q: Is the harness connector in good condition?**

**YES :** Go to Step 9.

**NO :** Repair or replace it. Refer to GROUP 00E, Harness Connector Inspection [P.00E-2](#). Then go to Step 11.

---

**STEP 9. Check for open circuit between intake air temperature sensor connector A-05 (terminal No. 4) and ECM connector B-109 (terminal No. 88).**

**Q: Is the harness wire in good condition?**

**YES :** Go to Step 10.

**NO :** Repair it. Then go to Step 11.

---

**STEP 10. Using scan tool MB991958, check data list item 5: Intake Air Temperature Sensor.**

(1) Turn the ignition switch to the "ON" position.

(2) Set scan tool MB991958 to the data reading mode for item 5, Intake Air Temperature Sensor.

- The intake air temperature and temperature shown with the scan tool should approximately match.

(3) Turn the ignition switch to the "LOCK" (OFF) position.

**Q: Is the sensor operating properly?**

**YES :** It can be assumed that this malfunction is intermittent. Refer to GROUP 00, How to Use

Troubleshooting/Inspection Service Points –How to Cope with Intermittent Malfunctions [P.00-13](#).

**NO :** Replace the ECM (Refer to, Removal and Installation [P.13B-1022](#)). Then go to Step 11.

---

**STEP 11. Test the OBD-II drive cycle.**

(1) Carry out a test drive with the drive cycle pattern. Refer to Diagnostic Function –OBD-II Drive Cycle –Pattern 23 [P.13B-12](#).

(2) Check the diagnostic trouble code (DTC).

**Q: Is DTC P0113 set?**

**YES :** Retry the troubleshooting.

**NO :** The inspection is complete.



DTC P0116: Engine Coolant Temperature Circuit Range/Performance Problem

ENGINE COOLANT TEMPERATURE SENSOR CIRCUIT

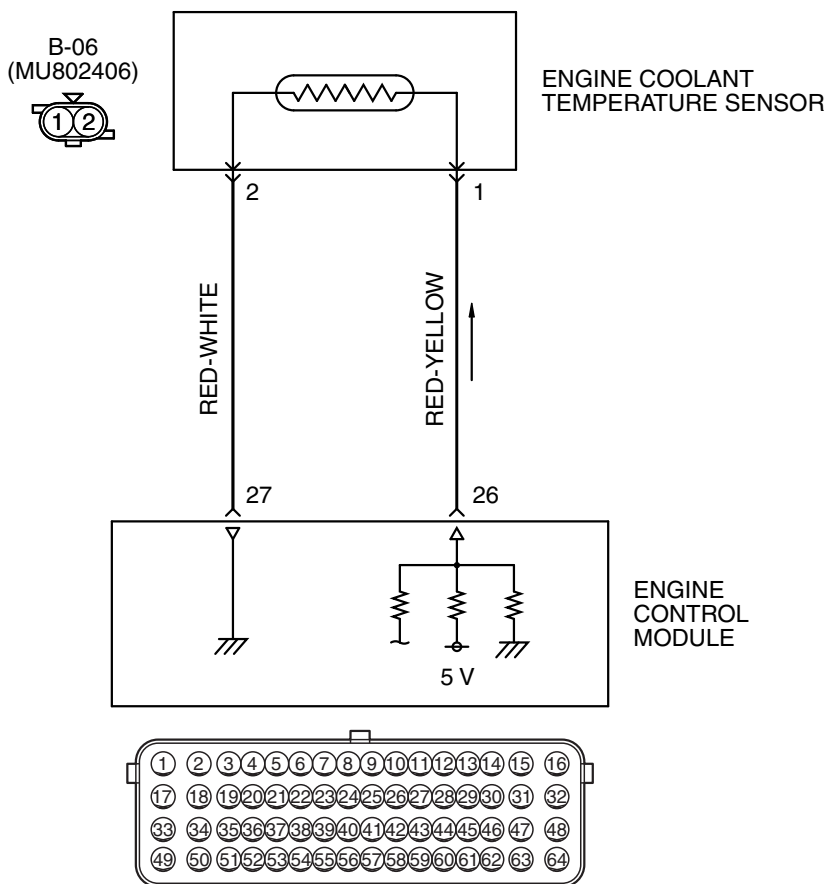

AK603948 AF

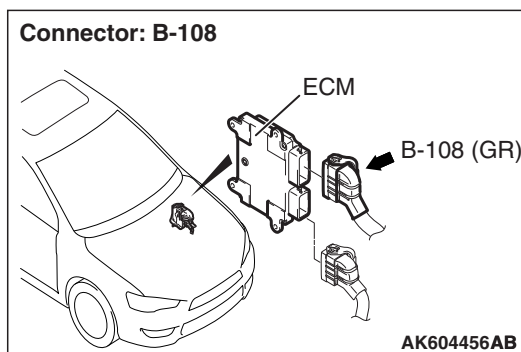
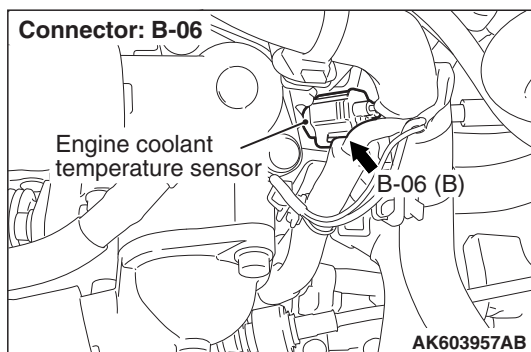

**CIRCUIT OPERATION**

- 5-volt voltage is applied to the engine coolant temperature sensor output terminal (terminal No. 1) from the ECM (terminal No. 26) via the resistor in the ECM. The ground terminal (terminal No. 2) is grounded with ECM (terminal No. 27).
- The engine coolant temperature sensor is a negative temperature coefficient type of resistor. It has the characteristic that when the engine coolant temperature rises the resistance decreases.
- The engine coolant temperature sensor output voltage increases when the resistance increases and decreases when the resistance decreases.

**TECHNICAL DESCRIPTION**

- The engine coolant temperature sensor converts the engine coolant temperature to a voltage and outputs it.
- The ECM checks whether this voltage is within a specified range.

**DESCRIPTIONS OF MONITOR METHODS**

Engine coolant temperature sensor output voltage does not change for specified period when engine coolant temperature sensor output voltage at engine start is over 7° C (45° F).

**MONITOR EXECUTION**

Once per driving cycle

**MONITOR EXECUTION CONDITIONS  
(Other monitor and Sensor)**

**Other Monitor (There is no temporary DTC stored in memory for the item monitored below)**

- Not applicable

**Sensor (The sensor below is determined to be normal)**

- Mass airflow sensor
- Intake air temperature sensor

DTC SET CONDITIONS

Logic Flow Chart

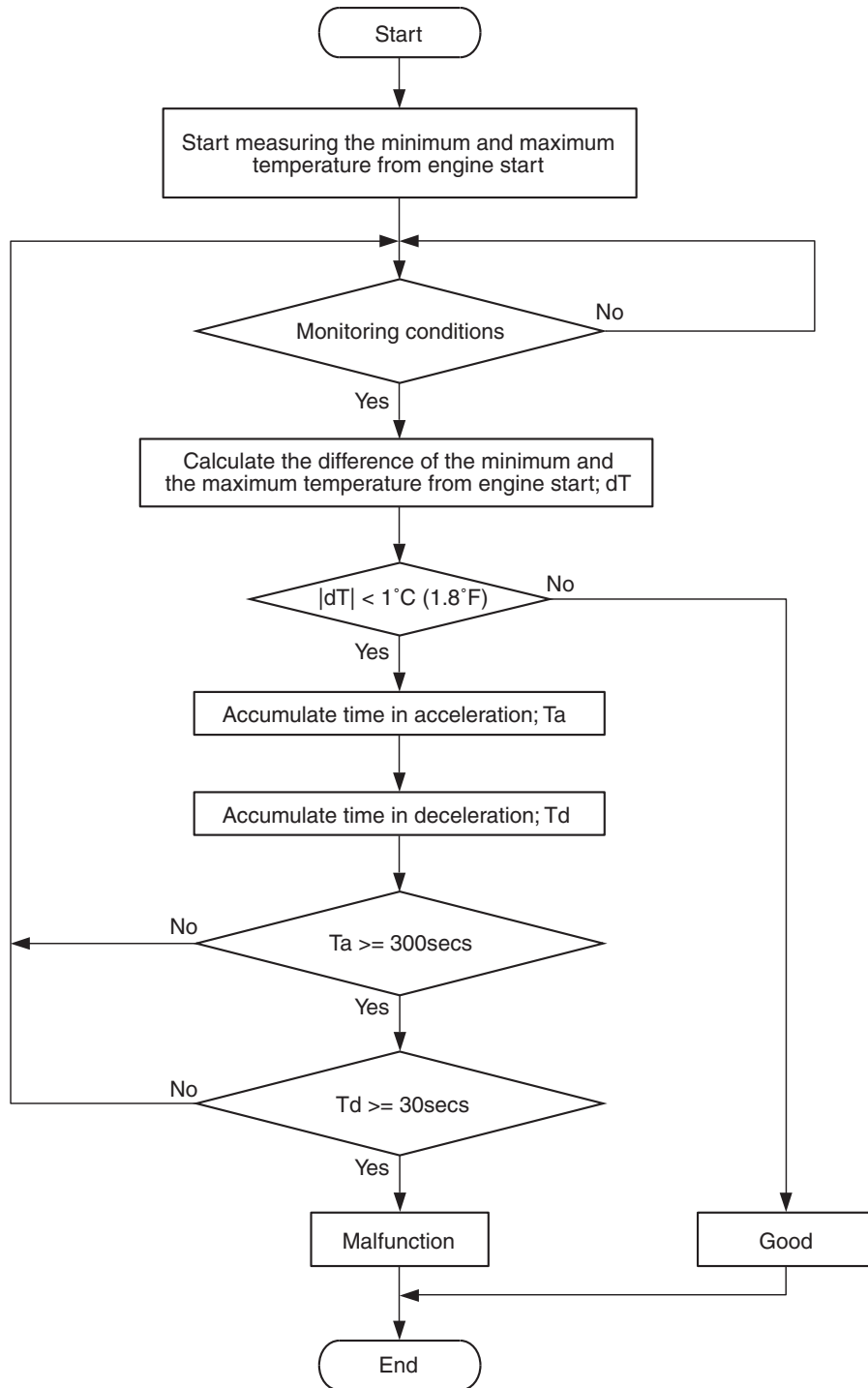

**Check Conditions**

- Engine coolant temperature was more than 0° C (32° F) when the engine started.
- The accumulation is more than 300 seconds during the acceleration having the mass airflow rate of 12 g/sec or more.
- The accumulation is more than 30 seconds during the deceleration having the mass airflow rate of 9 g/sec or less.

**Judgement Criteria**

- Engine coolant temperature fluctuates within 1° C (1.8° F) after 330 seconds have passed since the engine was started.
- However, time is not counted if any of the following conditions are met.
  1. Intake air temperature is more than 60° C (140° F).
  2. During fuel shut-off operation.

**FAIL-SAFE AND BACKUP FUNCTION**

- Control as if the engine coolant temperature is 80° C (176° F).

**OBD-II DRIVE CYCLE PATTERN**

Refer to Diagnostic Function –OBD-II Drive Cycle – Pattern 9 [P.13B-12](#).

**TROUBLESHOOTING HINTS (The most likely causes for this code to be set are:)**

- Engine coolant temperature sensor failed.
- Harness damage or connector damage.
- ECM failed.

**DIAGNOSIS****Required Special Tool:**

- MB991958: Scan Tool (M.U.T.-III Sub Assembly)
  - MB991824: V.C.I.
  - MB991827: USB Cable
  - MB991910: Main Harness A

**STEP 1. Using scan tool MB991958, check data list item 6: Engine Coolant Temperature Sensor.****⚠ CAUTION**

To prevent damage to scan tool MB991958, always turn the ignition switch to the "LOCK" (OFF) position before connecting or disconnecting scan tool MB991958.

- (1) Connect scan tool MB991958 to the data link connector.
- (2) Turn the ignition switch to the "ON" position.
- (3) Set scan tool MB991958 to the data reading mode for item 6, Engine Coolant Temperature Sensor.
  - The engine coolant temperature and temperature shown with the scan tool should approximately match.
- (4) Turn the ignition switch to the "LOCK" (OFF) position.

**Q: Is the sensor operating properly?**

**YES** : It can be assumed that this malfunction is intermittent. Refer to GROUP 00, How to Use Troubleshooting/Inspection Service Points –How to Cope with Intermittent Malfunctions [P.00-13](#).

**NO** : Go to Step 2.

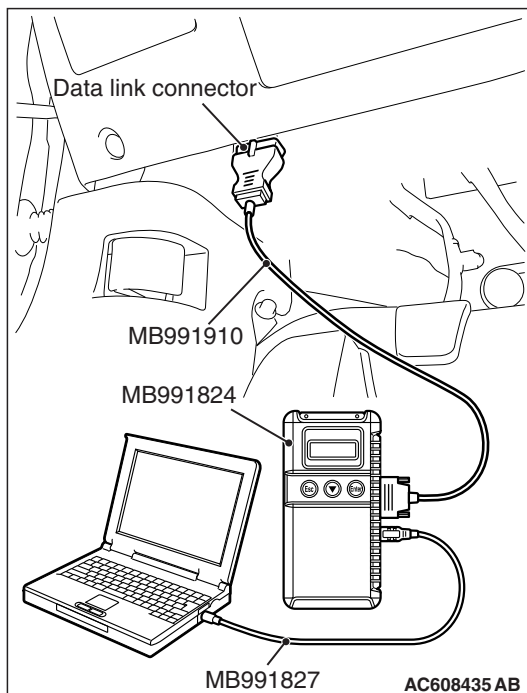

---

**STEP 2. Check harness connector B-06 at engine coolant temperature sensor for damage.**

**Q: Is the harness connector in good condition?**

**YES :** Go to Step 3.

**NO :** Repair or replace it. Refer to GROUP 00E, Harness Connector Inspection [P.00E-2](#). Then go to Step 10.

---

**STEP 3. Check the engine coolant temperature sensor.**

Refer to, Engine Coolant Temperature Sensor Check [P.13B-1005](#).

**Q: Is the engine coolant temperature sensor normal?**

**YES :** Go to Step 4.

**NO :** Replace the engine coolant temperature sensor. Then go to Step 10.

---

**STEP 4. Check the continuity at engine coolant temperature sensor harness side connector B-06.**

(1) Disconnect the connector B-06 and measure at the harness side.

(2) Check for the continuity between terminal No. 2 and ground.

- Continuity (2 ohms or less)

**Q: Does continuity exist?**

**YES :** Go to Step 7.

**NO :** Go to Step 5.

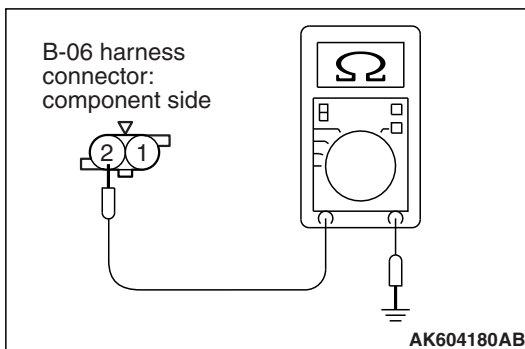

---

**STEP 5. Check harness connector B-108 at ECM for damage.**

**Q: Is the harness connector in good condition?**

**YES :** Go to Step 6.

**NO :** Repair or replace it. Refer to GROUP 00E, Harness Connector Inspection [P.00E-2](#). Then go to Step 10.

---

**STEP 6. Check for harness damage between engine coolant temperature sensor connector B-06 (terminal No. 2) and ECM connector B-108 (terminal No. 27).**

**Q: Is the harness wire in good condition?**

**YES :** Go to Step 9.

**NO :** Repair it. Then go to Step 10.

---

**STEP 7. Check harness connector B-108 at ECM for damage.**

**Q: Is the harness connector in good condition?**

**YES :** Go to Step 8.

**NO :** Repair or replace it. Refer to GROUP 00E, Harness Connector Inspection [P.00E-2](#). Then go to Step 10.

---

**STEP 8. Check for harness damage between engine coolant temperature sensor connector B-06 (terminal No. 1) and ECM connector B-108 (terminal No. 26).**

**Q: Is the harness wire in good condition?**

**YES :** Go to Step 9.

**NO :** Repair it. Then go to Step 10.

---

**STEP 9. Using scan tool MB991958, check data list item 6: Engine Coolant Temperature Sensor.**

(1) Turn the ignition switch to the "ON" position.

(2) Set scan tool MB991958 to the data reading mode for item 6, Engine Coolant Temperature Sensor.

- The engine coolant temperature and temperature shown with the scan tool should approximately match.

(3) Turn the ignition switch to the "LOCK" (OFF) position.

**Q: Is the sensor operating properly?**

**YES :** It can be assumed that this malfunction is intermittent. Refer to GROUP 00, How to Use Troubleshooting/Inspection Service Points –How to Cope with Intermittent Malfunctions [P.00-13](#).

**NO :** Replace the ECM (Refer to, Removal and Installation [P.13B-1022](#)). Then go to Step 10.

---

**STEP 10. Test the OBD-II drive cycle.**

(1) Carry out a test drive with the drive cycle pattern. Refer to Diagnostic Function –OBD-II Drive Cycle –Pattern 9 [P.13B-12](#).

(2) Check the diagnostic trouble code (DTC).

**Q: Is DTC P0116 set?**

**YES :** Retry the troubleshooting.

**NO :** The inspection is complete.

DTC P0117: Engine Coolant Temperature Circuit Low Input

ENGINE COOLANT TEMPERATURE SENSOR CIRCUIT

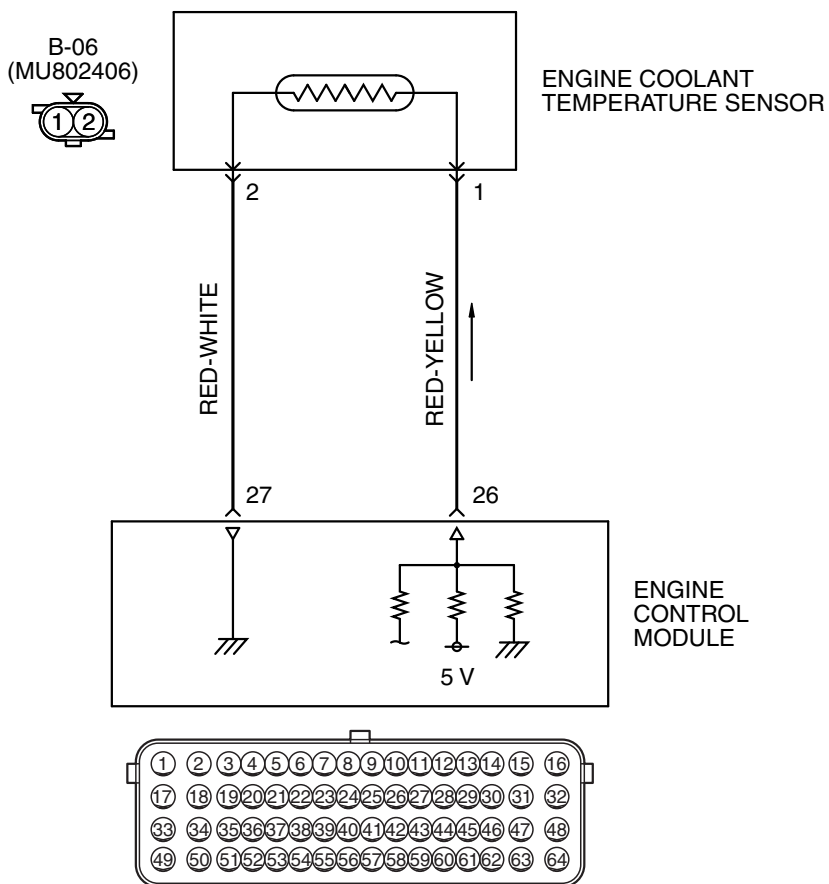

AK603948 AF

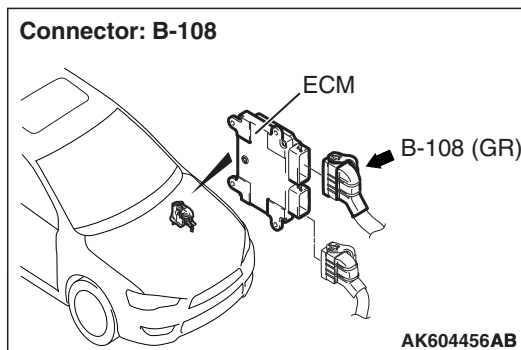
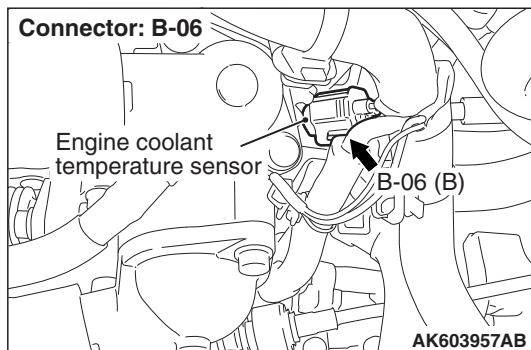

**CIRCUIT OPERATION**

- 5-volt voltage is applied to the engine coolant temperature sensor output terminal (terminal No. 1) from the ECM (terminal No. 26) via the resistor in the ECM. The ground terminal (terminal No. 2) is grounded with ECM (terminal No. 27).
- The engine coolant temperature sensor is a negative temperature coefficient type of resistor. It has the characteristic that when the engine coolant temperature rises the resistance decreases.
- The engine coolant temperature sensor output voltage increases when the resistance increases and decreases when the resistance decreases.

**TECHNICAL DESCRIPTION**

- The engine coolant temperature sensor converts the engine coolant temperature to a voltage and outputs it.
- The ECM checks whether this voltage is within a specified range.

**DESCRIPTIONS OF MONITOR METHODS**

Engine coolant temperature sensor output voltage is out of specified range.

**MONITOR EXECUTION**

Continuous

**MONITOR EXECUTION CONDITIONS  
(Other monitor and Sensor)**

**Other Monitor (There is no temporary DTC stored in memory for the item monitored below)**

- Not applicable

**Sensor (The sensor below is determined to be normal)**

- Not applicable



**DTC SET CONDITIONS**

**Logic Flow Chart**

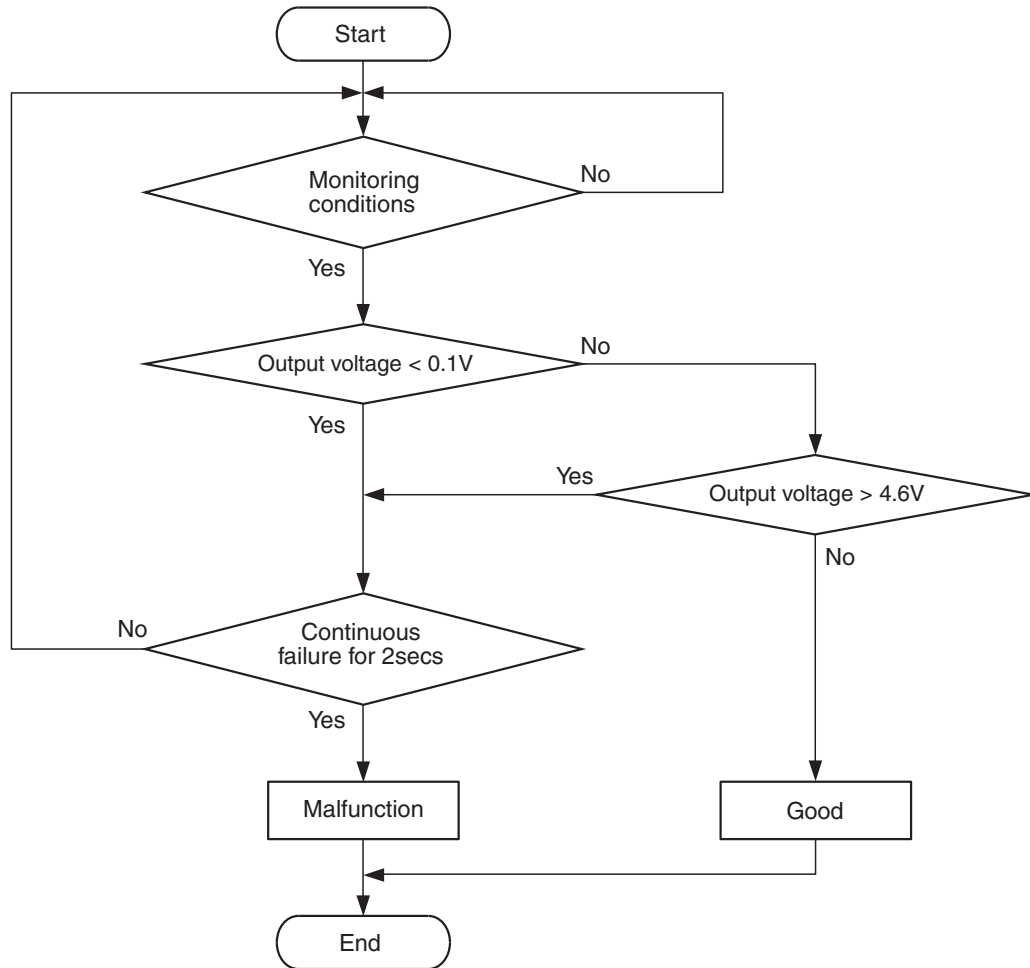

AK604317

**Check Condition**

- More than 2 seconds have passed since the engine starting sequence was completed.

**Judgement Criterion**

- Engine coolant temperature sensor output voltage is less than 0.1 volt for 2 seconds.

**FAIL-SAFE AND BACKUP FUNCTION**

- Control as if the engine coolant temperature is 80° C (176° F).

**OBD-II DRIVE CYCLE PATTERN**

Refer to Diagnostic Function –OBD-II Drive Cycle – Pattern 23 [P.13B-12](#).

**TROUBLESHOOTING HINTS (The most likely causes for this code to be set are:)**

- Engine coolant temperature sensor failed.
- Shorted engine coolant temperature sensor circuit, or connector damage.
- ECM failed.

**DIAGNOSIS****Required Special Tool:**

- MB991958: Scan Tool (M.U.T.-III Sub Assembly)
  - MB991824: V.C.I.
  - MB991827: USB Cable
  - MB991910: Main Harness A

**STEP 1. Using scan tool MB991958, check data list item 6: Engine Coolant Temperature Sensor.****⚠ CAUTION**

To prevent damage to scan tool MB991958, always turn the ignition switch to the "LOCK" (OFF) position before connecting or disconnecting scan tool MB991958.

- (1) Connect scan tool MB991958 to the data link connector.
- (2) Turn the ignition switch to the "ON" position.
- (3) Set scan tool MB991958 to the data reading mode for item 6, Engine Coolant Temperature Sensor.
  - The engine coolant temperature and temperature shown with the scan tool should approximately match.
- (4) Turn the ignition switch to the "LOCK" (OFF) position.

**Q: Is the sensor operating properly?**

**YES :** It can be assumed that this malfunction is intermittent.

Refer to GROUP 00, How to Use

Troubleshooting/Inspection Service Points –How to Cope with Intermittent Malfunctions [P.00-13](#).

**NO :** Go to Step 2.

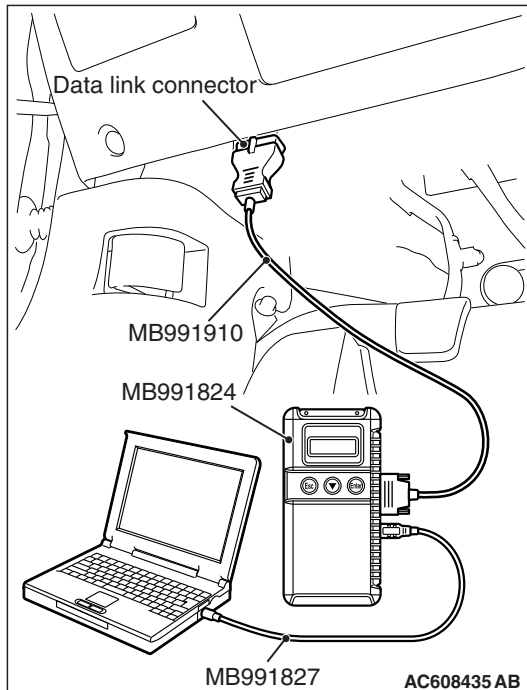
**STEP 2. Check harness connector B-06 at engine coolant temperature sensor for damage.****Q: Is the harness connector in good condition?**

**YES :** Go to Step 3.

**NO :** Repair or replace it. Refer to GROUP 00E, Harness Connector Inspection [P.00E-2](#). Then go to Step 7.

**STEP 3. Check the engine coolant temperature sensor.**

Refer to, Engine Coolant Temperature Sensor Check [P.13B-1005](#).

**Q: Is the engine coolant temperature sensor normal?**

**YES :** Go to Step 4.

**NO :** Replace the engine coolant temperature sensor. Then go to Step 7.

---

**STEP 4. Check harness connector B-108 at ECM for damage.**

**Q: Is the harness connector in good condition?**

**YES :** Go to Step 5.

**NO :** Repair or replace it. Refer to GROUP 00E, Harness Connector Inspection [P.00E-2](#). Then go to Step 7.

---

**STEP 5. Check for short circuit to ground between engine coolant temperature sensor connector B-06 (terminal No. 1) and ECM connector B-108 (terminal No. 26).**

**Q: Is the harness wire in good condition?**

**YES :** Go to Step 6.

**NO :** Repair it. Then go to Step 7.

---

**STEP 6. Using scan tool MB991958, check data list item 6: Engine Coolant Temperature Sensor.**

(1) Turn the ignition switch to the "ON" position.

(2) Set scan tool MB991958 to the data reading mode for item 6, Engine Coolant Temperature Sensor.

- The engine coolant temperature and temperature shown with the scan tool should approximately match.

(3) Turn the ignition switch to the "LOCK" (OFF) position.

**Q: Is the sensor operating properly?**

**YES :** It can be assumed that this malfunction is intermittent. Refer to GROUP 00, How to Use Troubleshooting/Inspection Service Points –How to Cope with Intermittent Malfunctions [P.00-13](#).

**NO :** Replace the ECM (Refer to, Removal and Installation [P.13B-1022](#)). Then go to Step 7.

---

**STEP 7. Test the OBD-II drive cycle.**

(1) Carry out a test drive with the drive cycle pattern. Refer to Diagnostic Function –OBD-II Drive Cycle –Pattern 23 [P.13B-12](#).

(2) Check the diagnostic trouble code (DTC).

**Q: Is DTC P0117 set?**

**YES :** Retry the troubleshooting.

**NO :** The inspection is complete.

DTC P0118: Engine Coolant Temperature Circuit High Input

ENGINE COOLANT TEMPERATURE SENSOR CIRCUIT

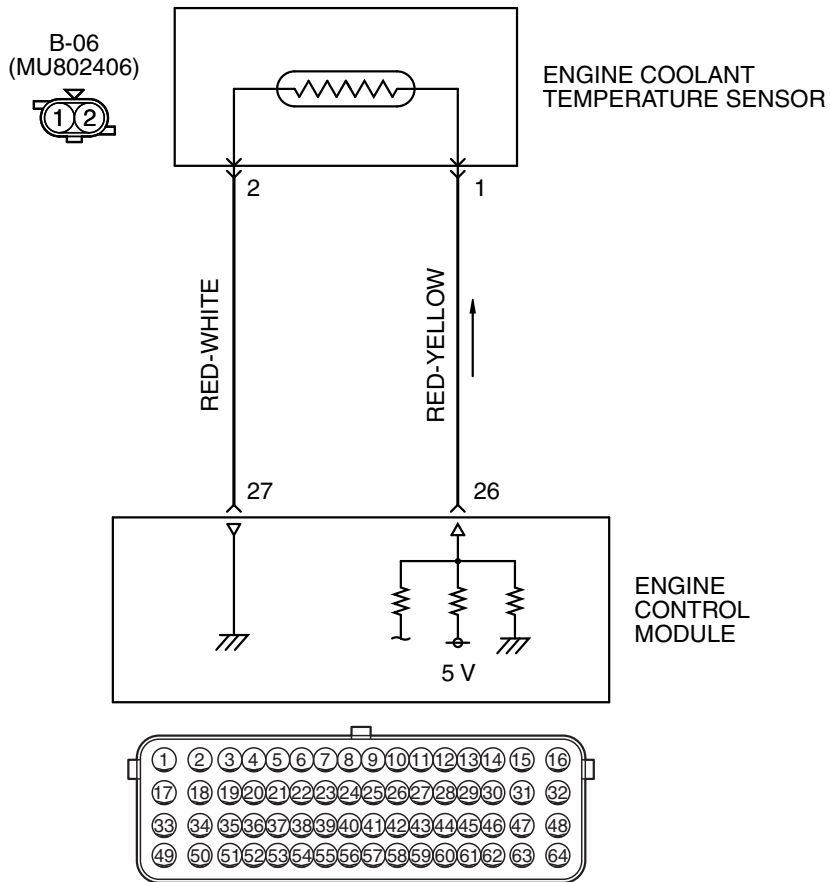

AK603948 AF

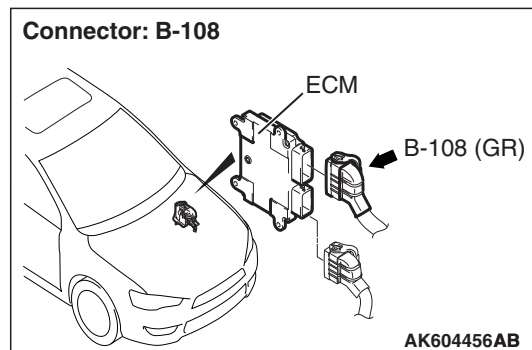
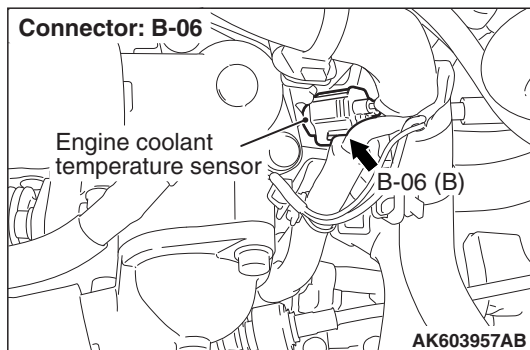

## CIRCUIT OPERATION

- 5-volt voltage is applied to the engine coolant temperature sensor output terminal (terminal No. 1) from the ECM (terminal No. 26) via the resistor in the ECM. The ground terminal (terminal No. 2) is grounded with ECM (terminal No. 27).
- The engine coolant temperature sensor is a negative temperature coefficient type of resistor. It has the characteristic that when the engine coolant temperature rises the resistance decreases.
- The engine coolant temperature sensor output voltage increases when the resistance increases and decreases when the resistance decreases.

## TECHNICAL DESCRIPTION

- The engine coolant temperature sensor converts the engine coolant temperature to a voltage and outputs it.
- The ECM checks whether this voltage is within a specified range.

## DESCRIPTIONS OF MONITOR METHODS

Engine coolant temperature sensor output voltage is out of specified range.

## MONITOR EXECUTION

Continuous

## MONITOR EXECUTION CONDITIONS (Other monitor and Sensor)

**Other Monitor (There is no temporary DTC stored in memory for the item monitored below)**

- Not applicable

**Sensor (The sensor below is determined to be normal)**

- Not applicable

DTC SET CONDITIONS

Logic Flow Chart

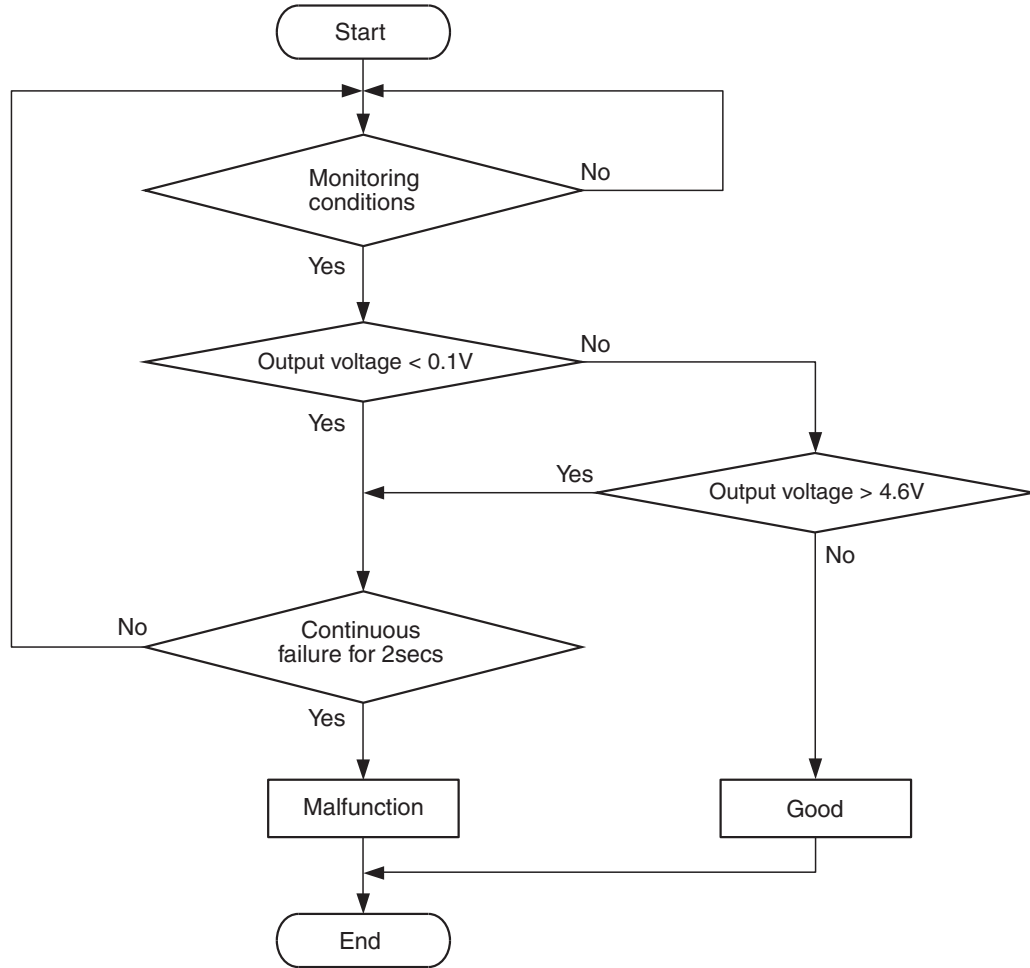

AK604317

**Check Condition**

- More than 2 seconds have passed since the engine starting sequence was completed.

**Judgement Criterion**

- Engine coolant temperature sensor output voltage is more than 4.6 volts for 2 seconds.

**FAIL-SAFE AND BACKUP FUNCTION**

- Control as if the engine coolant temperature is 80° C (176° F).

**OBD-II DRIVE CYCLE PATTERN**

Refer to Diagnostic Function-OBD-II Drive Cycle-Pattern 23 P.13B-12.

**TROUBLESHOOTING HINTS (The most likely causes for this code to be set are: )**

- Engine coolant temperature sensor failed.
- Open engine coolant temperature sensor circuit, or connector damage.
- ECM failed.

## DIAGNOSIS

### Required Special Tools:

- MB991958: Scan Tool (M.U.T.-III Sub Assembly)
  - MB991824: V.C.I.
  - MB991827: USB Cable
  - MB991910: Main Harness A
- MB992110: Power Plant ECU Check Harness

---

### STEP 1. Using scan tool MB991958, check data list item 6: Engine Coolant Temperature Sensor.

#### **⚠ CAUTION**

To prevent damage to scan tool MB991958, always turn the ignition switch to the "LOCK" (OFF) position before connecting or disconnecting scan tool MB991958.

- (1) Connect scan tool MB991958 to the data link connector.
- (2) Turn the ignition switch to the "ON" position.
- (3) Set scan tool MB991958 to the data reading mode for item 6, Engine Coolant Temperature Sensor.
  - The engine coolant temperature and temperature shown with the scan tool should approximately match.
- (4) Turn the ignition switch to the "LOCK" (OFF) position.

#### Q: Is the sensor operating properly?

**YES** : It can be assumed that this malfunction is intermittent. Refer to GROUP 00, How to Use Troubleshooting/Inspection Service Points –How to Cope with Intermittent Malfunctions P.00-13.

**NO** : Go to Step 2.

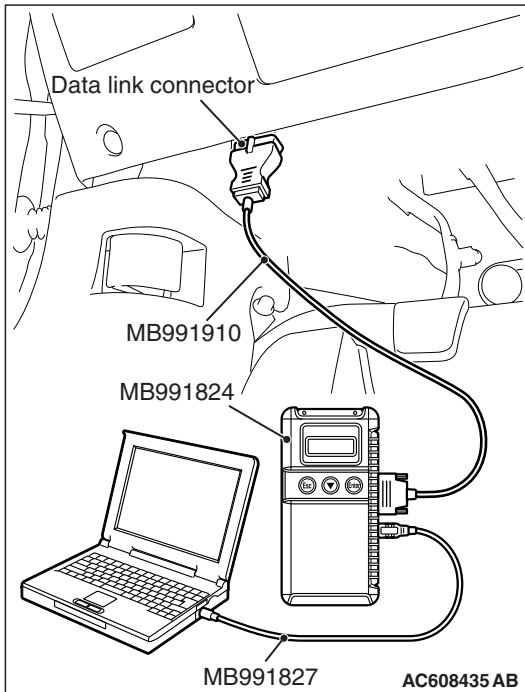

---

### STEP 2. Check harness connector B-06 at engine coolant temperature sensor for damage.

#### Q: Is the harness connector in good condition?

**YES** : Go to Step 3.

**NO** : Repair or replace it. Refer to GROUP 00E, Harness Connector Inspection P.00E-2. Then go to Step 11.

---

### STEP 3. Check the engine coolant temperature sensor.

Refer to, Engine Coolant Temperature Sensor Check P.13B-1005.

#### Q: Is the engine coolant temperature sensor normal?

**YES** : Go to Step 4.

**NO** : Replace the engine coolant temperature sensor. Then go to Step 11.

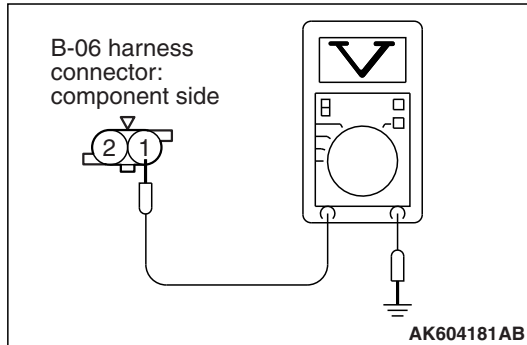

**STEP 4. Measure the sensor supply voltage at engine coolant temperature sensor harness side connector B-06.**

- (1) Disconnect the connector B-06 and measure at the harness side.
- (2) Turn the ignition switch to the "ON" position.
- (3) Measure the voltage between terminal No. 1 and ground.
  - Voltage should be between 4.5 and 4.9 volts.
- (4) Turn the ignition switch to the "LOCK" (OFF) position.

**Q: Is the measured voltage between 4.5 and 4.9 volts?**

**YES :** Go to Step 7.

**NO :** Go to Step 5.

**STEP 5. Check harness connector B-108 at ECM for damage.**

**Q: Is the harness connector in good condition?**

**YES :** Go to Step 6.

**NO :** Repair or replace it. Refer to GROUP 00E, Harness Connector Inspection [P.00E-2](#). Then go to Step 11.

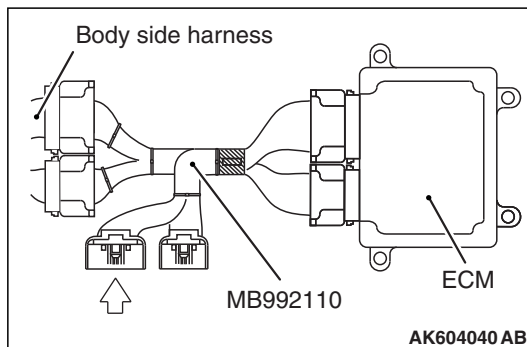

**STEP 6. Measure the sensor supply voltage at ECM connector B-108 by using power plant ECU check harness special tool MB992110.**

- (1) Disconnect all ECM connectors. Connect the power plant ECU check harness special tool MB992110 between the separated connectors.
- (2) Disconnect the engine coolant temperature sensor connector B-06.
- (3) Turn the ignition switch to the "ON" position.



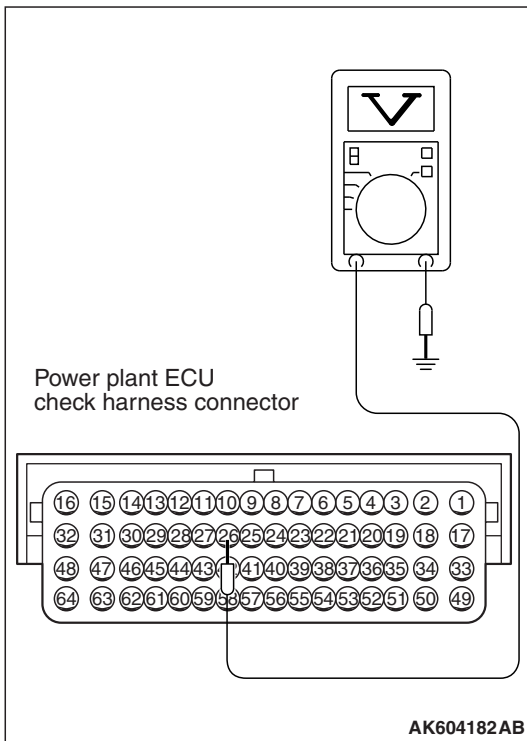

- (4) Measure the voltage between terminal No. 26 and ground.
  - Voltage should be between 4.5 and 4.9 volts.
- (5) Turn the ignition switch to the "LOCK" (OFF) position.

**Q: Is the measured voltage between 4.5 and 4.9 volts?**

**YES :** Repair harness wire between engine coolant temperature sensor connector B-06 (terminal No. 1) and ECM connector B-108 (terminal No. 26) because of open circuit. Then go to Step 11.

**NO :** Go to Step 10.

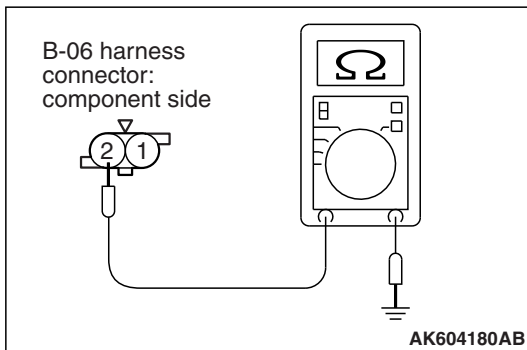

**STEP 7. Check the continuity at engine coolant temperature sensor harness side connector B-06.**

- (1) Disconnect the connector B-06 and measure at the harness side.
- (2) Check for the continuity between terminal No. 2 and ground.
  - Continuity (2 ohms or less)

**Q: Does continuity exist?**

**YES :** Go to Step 10.

**NO :** Go to Step 8.

**STEP 8. Check harness connector B-108 at ECM for damage.**

**Q: Is the harness connector in good condition?**

**YES :** Go to Step 9.

**NO :** Repair or replace it. Refer to GROUP 00E, Harness Connector Inspection [P.00E-2](#). Then go to Step 11.

**STEP 9. Check for open circuit between engine coolant temperature sensor connector B-06 (terminal No. 2) and ECM connector B-108 (terminal No. 27).**

**Q: Is the harness wire in good condition?**

**YES :** Go to Step 10.

**NO :** Repair it. Then go to Step 11.

**STEP 10. Using scan tool MB991958, check data list item 6:  
Engine Coolant Temperature Sensor.**

- (1) Turn the ignition switch to the "ON" position.
- (2) Set scan tool MB991958 to the data reading mode for item 6, Engine Coolant Temperature Sensor.
  - The engine coolant temperature and temperature shown with the scan tool should approximately match.
- (3) Turn the ignition switch to the "LOCK" (OFF) position.

**Q: Is the sensor operating properly?**

**YES** : It can be assumed that this malfunction is intermittent. Refer to GROUP 00, How to Use Troubleshooting/Inspection Service Points –How to Cope with Intermittent Malfunctions [P.00-13](#).

**NO** : Replace the ECM (Refer to, Removal and Installation [P.13B-1022](#)). Then go to Step 11.

---

**STEP 11. Test the OBD-II drive cycle.**

- (1) Carry out a test drive with the drive cycle pattern. Refer to Diagnostic Function –OBD-II Drive Cycle –Pattern 23 [P.13B-12](#).
- (2) Check the diagnostic trouble code (DTC).

**Q: Is DTC P0118 set?**

**YES** : Retry the troubleshooting.

**NO** : The inspection is complete.

DTC P0122: Throttle Position Sensor (main) Circuit Low Input

THROTTLE POSITION SENSOR (MAIN) CIRCUIT

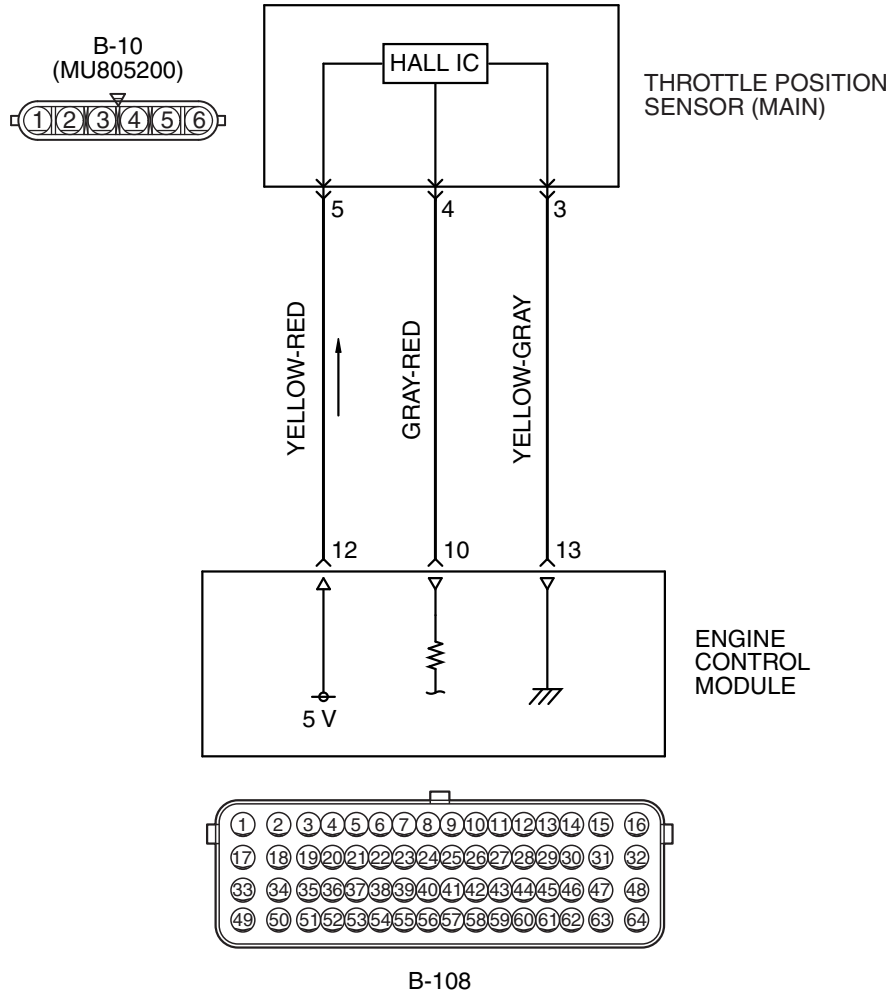

AK603950 AE

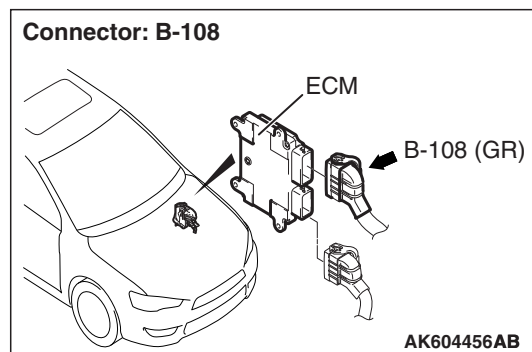
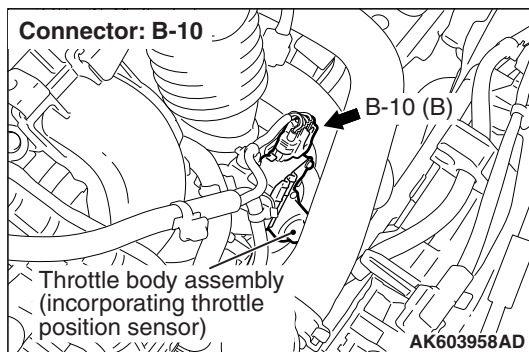

**CIRCUIT OPERATION**

- A 5-volt power supply is applied on the throttle position sensor (main) power terminal (terminal No. 5) from the ECM (terminal No. 12).
- A voltage that is according to the throttle opening angle is sent to the ECM (terminal No. 10) from the throttle position sensor (main) output terminal (terminal No. 4).

- The ground terminal (terminal No. 3) is grounded with ECM (terminal No. 13).

**TECHNICAL DESCRIPTION**

- The throttle position sensor (main) outputs voltage which corresponds to the throttle valve opening angle.
- The ECM checks whether the voltage is within a specified range.

**DESCRIPTIONS OF MONITOR METHODS**

Throttle position sensor (main) output voltage is out of specified range.

**DTC SET CONDITIONS**

**Logic Flow Chart**

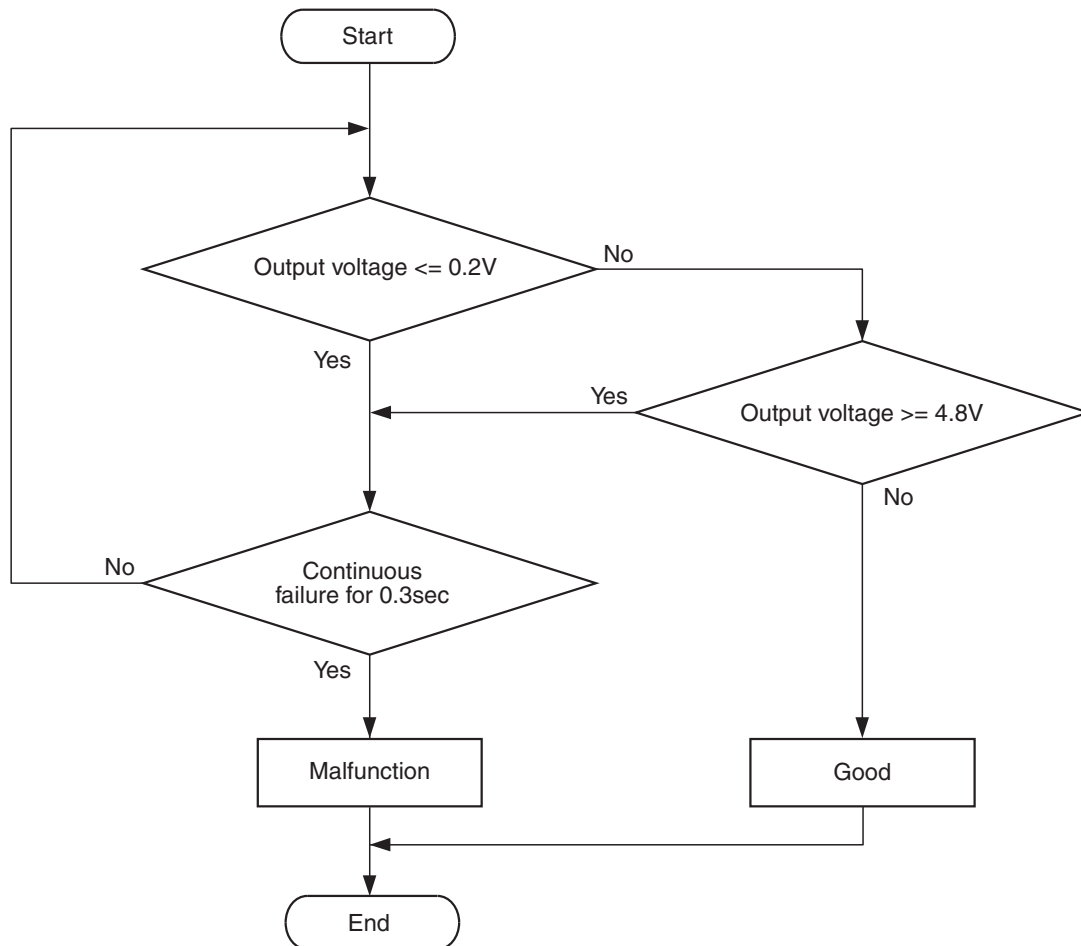

**MONITOR EXECUTION**

Continuous

**MONITOR EXECUTION CONDITIONS  
(Other monitor and Sensor)**

**Other Monitor (There is no temporary DTC stored in memory for the item monitored below)**

- Not applicable

**Sensor (The sensor below is determined to be normal)**

- Not applicable

### Check Condition

- Ignition switch is "ON" position.

### Judgement Criterion

- Throttle position sensor (main) output voltage is less than 0.2 volt for 0.3 second.

### FAIL-SAFE AND BACKUP FUNCTION

- Throttle opening degree is restricted.
- Throttle opening degree position is in default position if throttle position sensor (sub) fails.

### OBD-II DRIVE CYCLE PATTERN

None.

### TROUBLESHOOTING HINTS (The most likely causes for this code to be set are:)

- Throttle position sensor failed.
- Shorted throttle position sensor (main) circuit, harness damage, or connector damage.
- ECM failed.

### DIAGNOSIS

#### Required Special Tools:

- MB991958: Scan Tool (M.U.T.-III Sub Assembly)
  - MB991824: V.C.I.
  - MB991827: USB Cable
  - MB991910: Main Harness A
- MB991658: Test Harness

#### STEP 1. Using scan tool MB991958, check data list item 13: Throttle Position Sensor (main).

#### **CAUTION**

To prevent damage to scan tool MB991958, always turn the ignition switch to the "LOCK" (OFF) position before connecting or disconnecting scan tool MB991958.

- (1) Connect scan tool MB991958 to the data link connector.
- (2) Detach the intake air hose at the throttle body.
- (3) Disconnect the connector of the electronic-controlled throttle valve.
- (4) Use test harness special tool (MB991658) to connect only terminals No. 3, No. 4, No. 5, and No. 6.
- (5) Turn the ignition switch to the "ON" position.
- (6) Set scan tool MB991958 to the data reading mode for item 13, Throttle Position Sensor (main).
  - Output voltage should be between 300 and 700 millivolts when the throttle valve is fully closed with your finger.
  - Output voltage should be 4,000 millivolts or more when the throttle valve is fully open with your finger.
- (7) Turn the ignition switch to the "LOCK" (OFF) position.

#### Q: Is the sensor operating properly?

**YES** : It can be assumed that this malfunction is intermittent. Refer to GROUP 00, How to Use Troubleshooting/Inspection Service Points –How to Cope with Intermittent Malfunctions P.00-13.

**NO** : Go to Step 2.

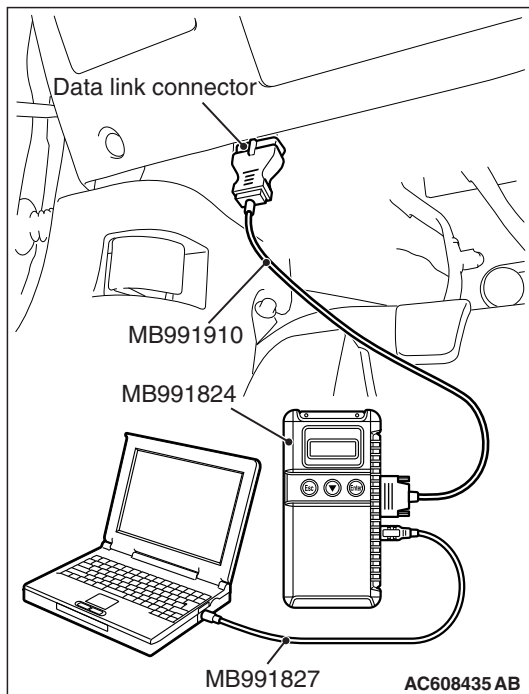

---

**STEP 2. Check harness connector B-10 at electronic-controlled throttle valve and harness connector B-108 at ECM for damage.**

**Q: Are the harness connectors in good condition?**

**YES :** Go to Step 3.

**NO :** Repair or replace them. Refer to GROUP 00E, Harness Connector Inspection [P.00E-2](#). Then go to Step 7.

---

**STEP 3. Check for harness damage between electronic-controlled throttle valve connector B-10 (terminal No. 5) and ECM connector B-108 (terminal No. 12).**

**Q: Is the harness wire in good condition?**

**YES :** Go to Step 4.

**NO :** Repair it. Then go to Step 7.

---

**STEP 4. Check for short circuit to ground and harness damage between electronic-controlled throttle valve connector B-10 (terminal No. 4) and ECM connector B-108 (terminal No. 10).**

**Q: Is the harness wire in good condition?**

**YES :** Go to Step 5.

**NO :** Repair it. Then go to Step 7.

---

**STEP 5. Using scan tool MB991958, check data list item 13: Throttle Position Sensor (main).**

- (1) Detach the intake air hose at the throttle body.
- (2) Disconnect the connector of the electronic-controlled throttle valve.
- (3) Use test harness special tool (MB991658) to connect only terminals No. 3, No. 4, No. 5, and No. 6.
- (4) Turn the ignition switch to the "ON" position.
- (5) Set scan tool MB991958 to the data reading mode for item 13, Throttle Position Sensor (main).
  - Output voltage should be between 300 and 700 millivolts when the throttle valve is fully closed with your finger.
  - Output voltage should be 4,000 millivolts or more when the throttle valve is fully open with your finger.
- (6) Turn the ignition switch to the "LOCK" (OFF) position.

**Q: Is the sensor operating properly?**

**YES :** It can be assumed that this malfunction is intermittent. Refer to GROUP 00, How to Use Troubleshooting/Inspection Service Points –How to Cope with Intermittent Malfunctions [P.00-13](#).

**NO :** Go to Step 6.

---

**STEP 6. Replace the throttle body assembly.**

- (1) Replace the throttle body assembly.
- (2) Turn the ignition switch to the "ON" position.
- (3) After the DTC has been deleted, read the DTC again.
- (4) Turn the ignition switch to the "LOCK" (OFF) position.

**Q: Is DTC P0122 set?**

**YES :** Replace the ECM (Refer to, Removal and Installation P.13B-1022). Then go to Step 7.

**NO :** The inspection is complete.

---

**STEP 7. Using scan tool MB991958, read the diagnostic trouble code (DTC).**

- (1) Turn the ignition switch to the "ON" position.
- (2) After the DTC has been deleted, read the DTC again.
- (3) Turn the ignition switch to the "LOCK" (OFF) position.

**Q: Is DTC P0122 set?**

**YES :** Retry the troubleshooting.

**NO :** The inspection is complete.

DTC P0123: Throttle Position Sensor (main) Circuit High Input

THROTTLE POSITION SENSOR (MAIN) CIRCUIT

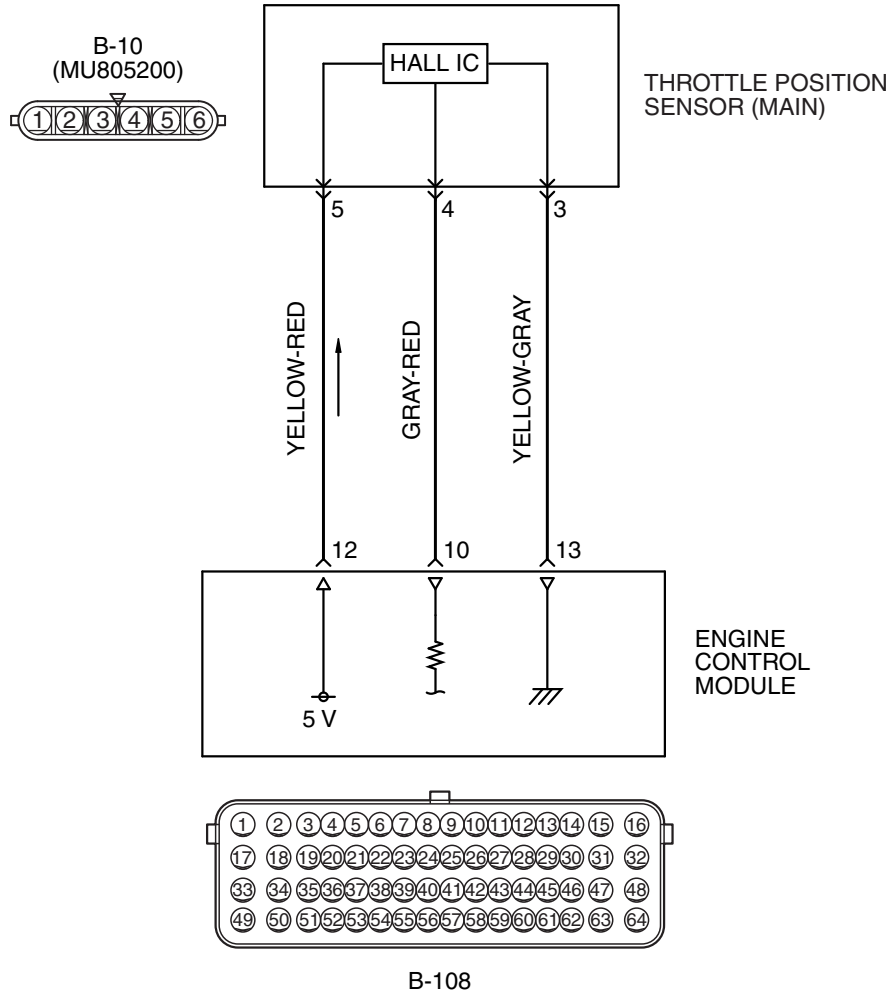

AK603950 AE

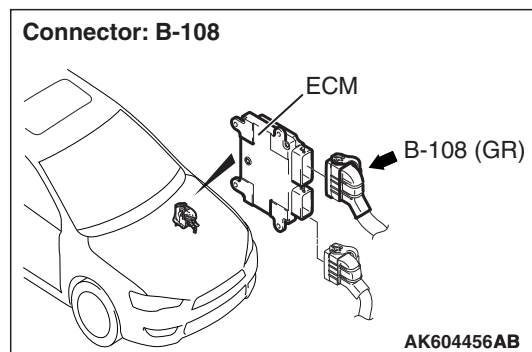
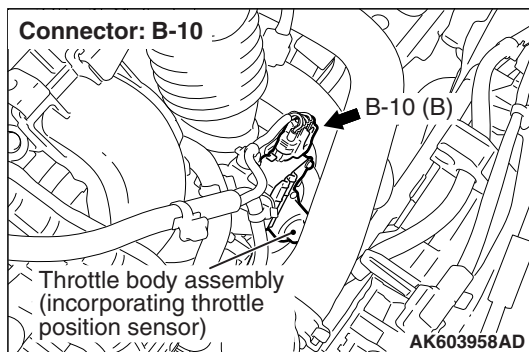

CIRCUIT OPERATION

- A 5-volt power supply is applied on the throttle position sensor (main) power terminal (terminal No. 5) from the ECM (terminal No. 12).
- A voltage that is according to the throttle opening angle is sent to the ECM (terminal No. 10) from the throttle position sensor (main) output terminal (terminal No. 4)



- The ground terminal (terminal No. 3) is grounded with ECM (terminal No. 13).

### TECHNICAL DESCRIPTION

- The throttle position sensor (main) outputs voltage which corresponds to the throttle valve opening angle.
- The ECM checks whether the voltage is within a specified range.

### DESCRIPTIONS OF MONITOR METHODS

Throttle position sensor (main) output voltage is out of specified range.

### MONITOR EXECUTION

Continuous

### MONITOR EXECUTION CONDITIONS (Other monitor and Sensor)

**Other Monitor (There is no temporary DTC stored in memory for the item monitored below)**

- Not applicable

**Sensor (The sensor below is determined to be normal)**

- Not applicable

### DTC SET CONDITIONS

#### Logic Flow Chart

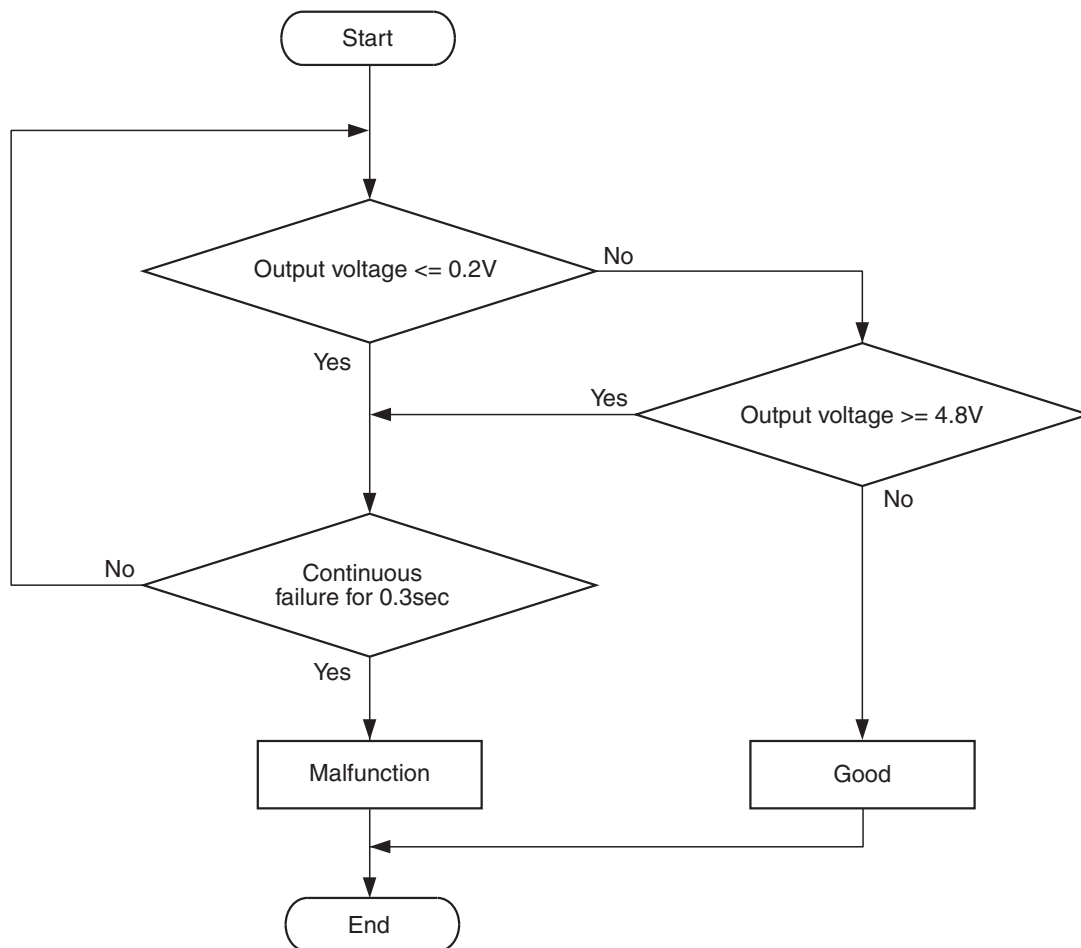

AK604318

**Check Condition**

- Ignition switch is "ON" position.

**Judgement Criterion**

- Throttle position sensor (main) output voltage is more than 4.8 volts for 0.3 second.

**FAIL-SAFE AND BACKUP FUNCTION**

- Throttle opening degree is restricted.
- Throttle opening degree position is in default position if throttle position sensor (sub) fails.

**OBD-II DRIVE CYCLE PATTERN**

None.

**TROUBLESHOOTING HINTS (The most likely causes for this code to be set are:)**

- Throttle position sensor failed.
- Open or shorted throttle position sensor (main) circuit, harness damage or connector damage.
- ECM failed.

**DIAGNOSIS****Required Special Tools:**

- MB991958: Scan Tool (M.U.T.-III Sub Assembly)
  - MB991824: V.C.I.
  - MB991827: USB Cable
  - MB991910: Main Harness A
- MB991658: Test Harness

**STEP 1. Using scan tool MB991958, check data list item 13: Throttle Position Sensor (main).****⚠ CAUTION**

To prevent damage to scan tool MB991958, always turn the ignition switch to the "LOCK" (OFF) position before connecting or disconnecting scan tool MB991958.

- (1) Connect scan tool MB991958 to the data link connector.
- (2) Detach the intake air hose at the throttle body.
- (3) Disconnect the connector of the electronic-controlled throttle valve.
- (4) Use test harness special tool (MB991658) to connect only terminals No. 3, No. 4, No. 5, and No. 6.
- (5) Turn the ignition switch to the "ON" position.
- (6) Set scan tool MB991958 to the data reading mode for item 13, Throttle Position Sensor (main).
  - Output voltage should be between 300 and 700 millivolts when the throttle valve is fully closed with your finger.
  - Output voltage should be 4,000 millivolts or more when the throttle valve is fully open with your finger.
- (7) Turn the ignition switch to the "LOCK" (OFF) position.

**Q: Is the sensor operating properly?**

**YES** : It can be assumed that this malfunction is intermittent. Refer to GROUP 00, How to Use Troubleshooting/Inspection Service Points –How to Cope with Intermittent Malfunctions P.00-13.

**NO** : Go to Step 2.

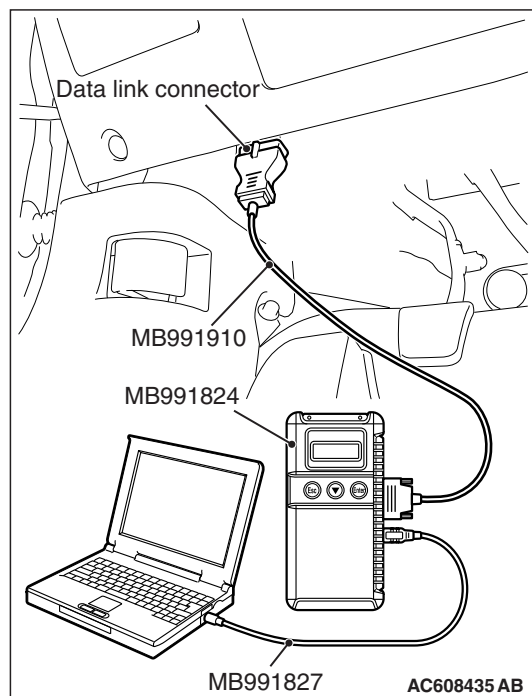

---

**STEP 2. Check harness connector B-10 at electronic-controlled throttle valve for damage.**

**Q: Is the harness connector in good condition?**

**YES :** Go to Step 3.

**NO :** Repair or replace it. Refer to GROUP 00E, Harness Connector Inspection [P.00E-2](#). Then go to Step 14.

---

**STEP 3. Measure the sensor supply voltage at electronic-controlled throttle valve harness side connector B-10.**

(1) Disconnect the connector B-10 and measure at the harness side.

(2) Turn the ignition switch to the "ON" position.

(3) Measure the voltage between terminal No. 5 and ground.  
• Voltage should be between 4.9 and 5.1 volts.

(4) Turn the ignition switch to the "LOCK" (OFF) position.

**Q: Is the measured voltage between 4.9 and 5.1 volts?**

**YES :** Go to Step 6.

**NO :** Go to Step 4.

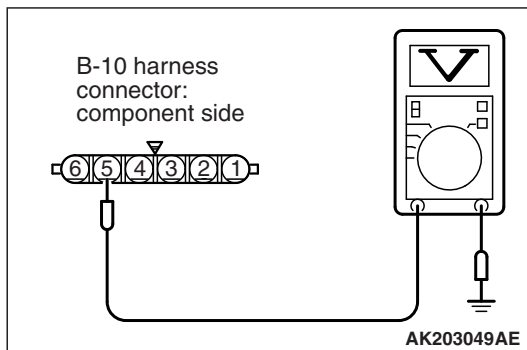

---

**STEP 4. Check harness connector B-108 at ECM for damage.**

**Q: Is the harness connector in good condition?**

**YES :** Go to Step 5.

**NO :** Repair or replace it. Refer to GROUP 00E, Harness Connector Inspection [P.00E-2](#). Then go to Step 14.

---

**STEP 5. Check for open circuit and short circuit to ground between electronic-controlled throttle valve connector B-10 (terminal No. 5) and ECM connector B-108 (terminal No. 12).**

**Q: Is the harness wire in good condition?**

**YES :** Go to Step 9.

**NO :** Repair it. Then go to Step 14.

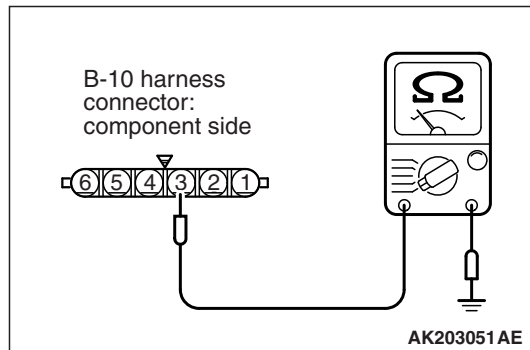
**STEP 6. Check the continuity at electronic-controlled throttle valve harness side connector B-10.**

- (1) Disconnect the connector B-10 and measure at the harness side.
- (2) Check for the continuity between terminal No. 3 and ground.
  - Continuity (2 ohms or less)

**Q: Does continuity exist?**

- YES :** Go to Step 10.  
**NO :** Go to Step 7.

**STEP 7. Check harness connector B-108 at ECM for damage.****Q: Is the harness connector in good condition?**

- YES :** Go to Step 8.  
**NO :** Repair or replace it. Refer to GROUP 00E, Harness Connector Inspection [P.00E-2](#). Then go to Step 14.

**STEP 8. Check for open circuit and harness damage between electronic-controlled throttle valve connector B-10 (terminal No. 3) and ECM connector B-108 (terminal No. 13).****Q: Is the harness wire in good condition?**

- YES :** Go to Step 9.  
**NO :** Repair it. Then go to Step 14.

**STEP 9. Using scan tool MB991958, check data list item 13: Throttle Position Sensor (main).**

- (1) Detach the intake air hose at the throttle body.
- (2) Disconnect the connector of the electronic-controlled throttle valve.
- (3) Use test harness special tool (MB991658) to connect only terminals No. 3, No. 4, No. 5, and No. 6.
- (4) Turn the ignition switch to the "ON" position.
- (5) Set scan tool MB991958 to the data reading mode for item 13, Throttle Position Sensor (main).
  - Output voltage should be between 300 and 700 millivolts when the throttle valve is fully closed with your finger.
  - Output voltage should be 4,000 millivolts or more when the throttle valve is fully open with your finger.
- (6) Turn the ignition switch to the "LOCK" (OFF) position.

**Q: Is the sensor operating properly?**

- YES :** It can be assumed that this malfunction is intermittent. Refer to GROUP 00, How to Use Troubleshooting/Inspection Service Points –How to Cope with Intermittent Malfunctions [P.00-13](#).  
**NO :** Replace the ECM (Refer to, Removal and Installation [P.13B-1022](#)). Then go to Step 14.

---

**STEP 10. Check harness connector B-108 at ECM for damage.**

**Q: Is the harness connector in good condition?**

**YES :** Go to Step 11.

**NO :** Repair or replace it. Refer to GROUP 00E, Harness Connector Inspection [P.00E-2](#). Then go to Step 14.

---

**STEP 11. Check for harness damage between electronic-controlled throttle valve connector B-10 (terminal No. 5) and ECM connector B-108 (terminal No. 12).**

**Q: Is the harness wire in good condition?**

**YES :** Go to Step 12.

**NO :** Repair it. Then go to Step 14.

---

**STEP 12. Check for open circuit and harness damage between electronic-controlled throttle valve connector B-10 (terminal No. 4) and ECM connector B-108 (terminal No. 10).**

**Q: Is the harness wire in good condition?**

**YES :** Go to Step 13.

**NO :** Repair it. Then go to Step 14.

---

**STEP 13. Replace the throttle body assembly.**

- (1) Replace the throttle body assembly.
- (2) Turn the ignition switch to the "ON" position.
- (3) After the DTC has been deleted, read the DTC again.
- (4) Turn the ignition switch to the "LOCK" (OFF) position.

**Q: Is DTC P0123 set?**

**YES :** Replace the ECM (Refer to, Removal and Installation [P.13B-1022](#)). Then go to Step 14.

**NO :** The inspection is complete.

---

**STEP 14. Using scan tool MB991958, read the diagnostic trouble code (DTC).**

- (1) Turn the ignition switch to the "ON" position.
- (2) After the DTC has been deleted, read the DTC again.
- (3) Turn the ignition switch to the "LOCK" (OFF) position.

**Q: Is DTC P0123 set?**

**YES :** Retry the troubleshooting.

**NO :** The inspection is complete.