

## GROUP 42C

# WIRELESS CONTROL MODULE (WCM)

## CONTENTS

<b>GENERAL INFORMATION</b> .....	<b>42C-2</b>	<b>ON-VEHICLE SERVICE</b> .....	<b>42C-101</b>
<b>SPECIAL TOOL</b> .....	<b>42C-6</b>	ID CODES REGISTRATION	
<b>DIAGNOSIS</b> .....	<b>42C-7</b>	PROCEDURE .....	42C-101
STANDARD FLOW OF DIAGNOSTIC		TPMS TRANSMITTER CHECK .....	42C-113
TROUBLESHOOTING .....	42C-7	TPMS TRANSMITTER ID CHECK .....	42C-113
DIAGNOSTIC FUNCTION .....	42C-7	KEYLESS ENTRY SYSTEM CHECK .....	42C-113
ID CODES REGISTRATION JUDGMENT		INSPECTION OF KEYLESS ENTRY TIMER	
TABLE .....	42C-10	LOCK FUNCTION .....	42C-113
WARNINGS/ALARMS <VEHICLES WITHOUT		POWER DOOR LOCKS WITH SELECTIVE	
COLOR LIQUID CRYSTAL DISPLAY> ...	42C-13	UNLOCKING INSPECTION .....	42C-114
WARNINGS/ALARMS <VEHICLES WITH		CUSTOMIZATION FUNCTION .....	42C-115
COLOR LIQUID CRYSTAL DISPLAY> ...	42C-15	<b>WCM</b> .....	<b>42C-117</b>
DIAGNOSTIC TROUBLE CODE CHART ..	42C-18	REMOVAL AND INSTALLATION .....	42C-117
DIAGNOSTIC TROUBLE CODE		<b>TRANSMITTER</b> .....	<b>42C-118</b>
PROCEDURES .....	42C-20	DISASSEMBLY AND ASSEMBLY .....	42C-118
DATA LIST REFERENCE TABLE .....	42C-82	<b>TPMS TRANSMITTER</b> .....	<b>42C-120</b>
TROUBLE SYMPTOM CHART .....	42C-84	REMOVAL AND INSTALLATION .....	42C-120
SYMPTOM PROCEDURES .....	42C-84		
CHECK AT ECU TERMINALS .....	42C-101		

## GENERAL INFORMATION

M1427500100157

The wireless control module (WCM) is a system that integrates the keyless entry function with which remote operation (opening/closing of all doors, opening of liftgate, and warning function to warn a person who intends to damage the vehicle<sup>\*</sup>) can be performed by operating the lock/unlock button or panic button on the ignition key (transmitter). Also, WCM incorporates the immobilizer function, which prohibits the starting of engine using an unauthorized key, and the tire pressure monitoring system (TPMS), which issues a warning to a driver by illuminating or flashing the warning light if an abnormality to the tire pressure or system is detected. WCM has the following features:

- The ignition key has an indicator light that enables the driver to check if the signal is transmitted correctly or if the battery in the key is discharged.
- Each vehicle is provided with two ignition keys, and up to eight ignition keys can be registered.
- Settings of the keyless entry function can be adjusted using a customization function.

*NOTE: <sup>\*</sup>: Horn sounds, and headlights and taillights flash.*

CONSTRUCTION DIAGRAM

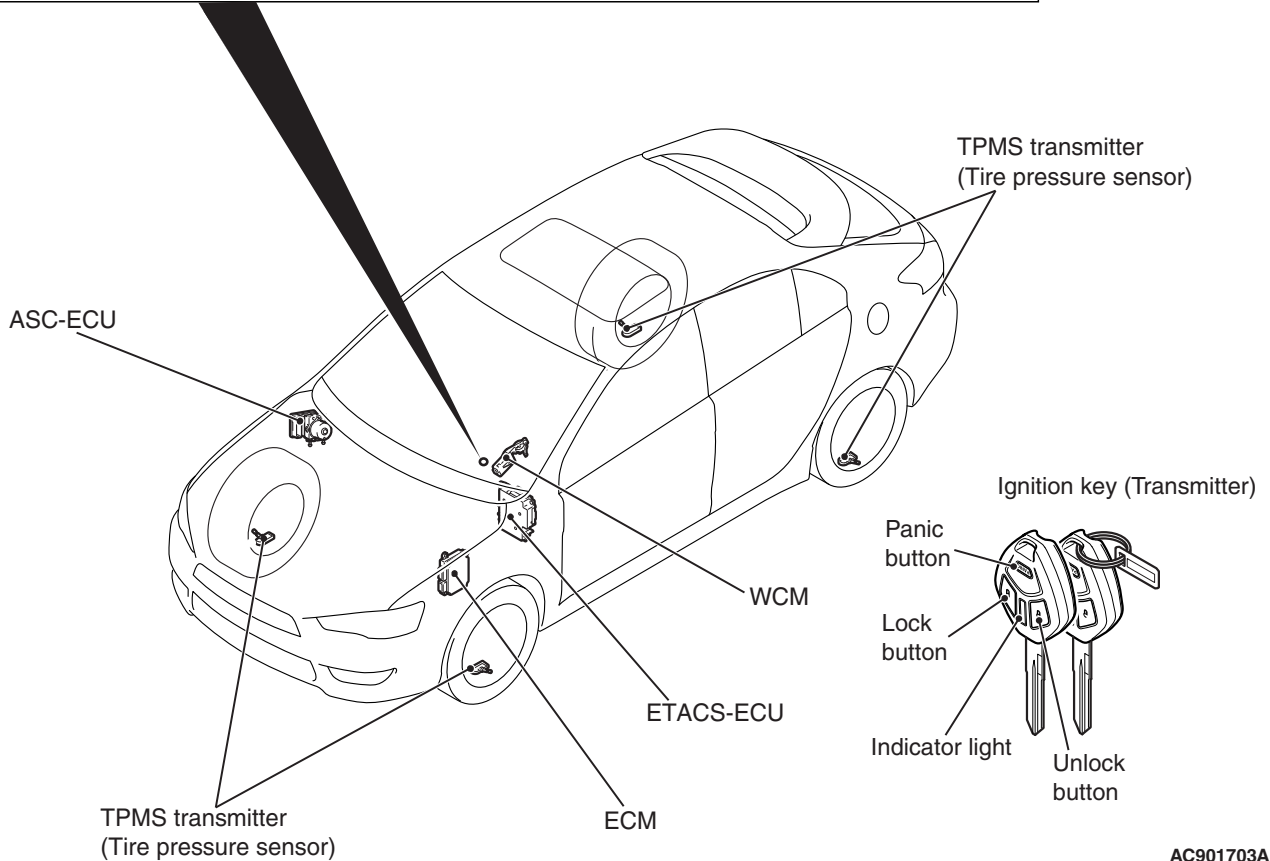
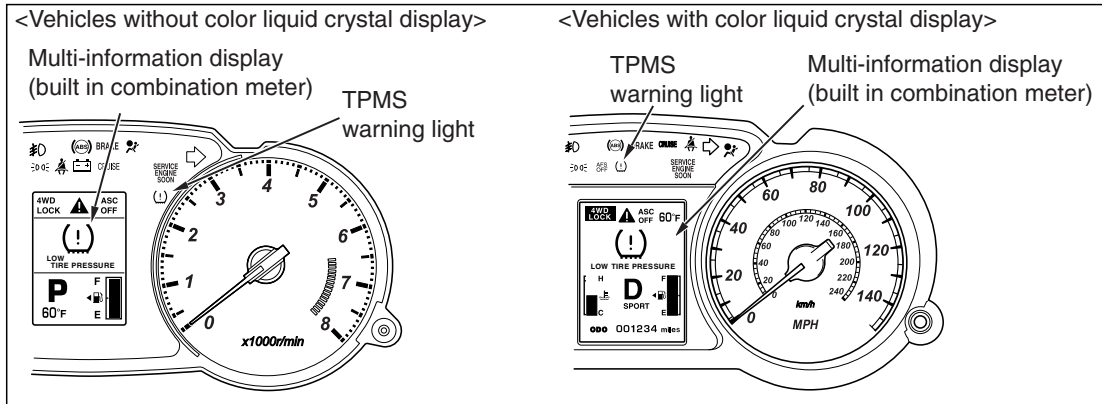

AC901703AB

**Main components and functions**

<b>Parts name</b>	<b>Functional description</b>
Wireless control module (WCM)	Controls the keyless entry functions, TPMS functions and starting of the engine by using the following communications. <ul style="list-style-type: none"> <li>• Communications with ETACS-ECU, ECM, ABS-ECU and combination meter via CAN</li> <li>• Wire communication with the steering lock unit</li> <li>• Wireless communication with the ignition key</li> <li>• Wireless communication with the TPMS transmitter</li> </ul>
Ignition key	The ignition key receives signals sent from WCM, certifies the key ID, calculates the key ID, and sends the reply data signal to WCM. The ignition key also sends signals to WCM when the lock/unlock button and panic button on it are operated.
Combination meter (Multi information display, TPMS warning light)	Communicates with WCM via CAN. Send ignition switch status. Receives the warning request or warning information from WCM, activates* the TPMS warning light. Warning symbol and message is additionally displayed on the Multi information display.
ETACS-ECU	Communicates with WCM via CAN. Receives the door lock/unlock request from WCM, outputs the lock/unlock signal and flashes the turn signal light to inform the driver that the doors are locked/unlocked.
ASC-ECU	Communicates with WCM via CAN. Sends the vehicle speed data.
Engine control module (ECM)	Communication with WCM via CAN. Send atmospheric pressure data.
TPMS transmitter	Measure tire pressure directly, then send radio frequency signal to WCM.

**NOTE:**

- \*: *Illuminates for tire pressure warning.*
- \*: *Flashes for about 1 minute and then continuously illuminated for TPMS malfunction warning.*

System configuration

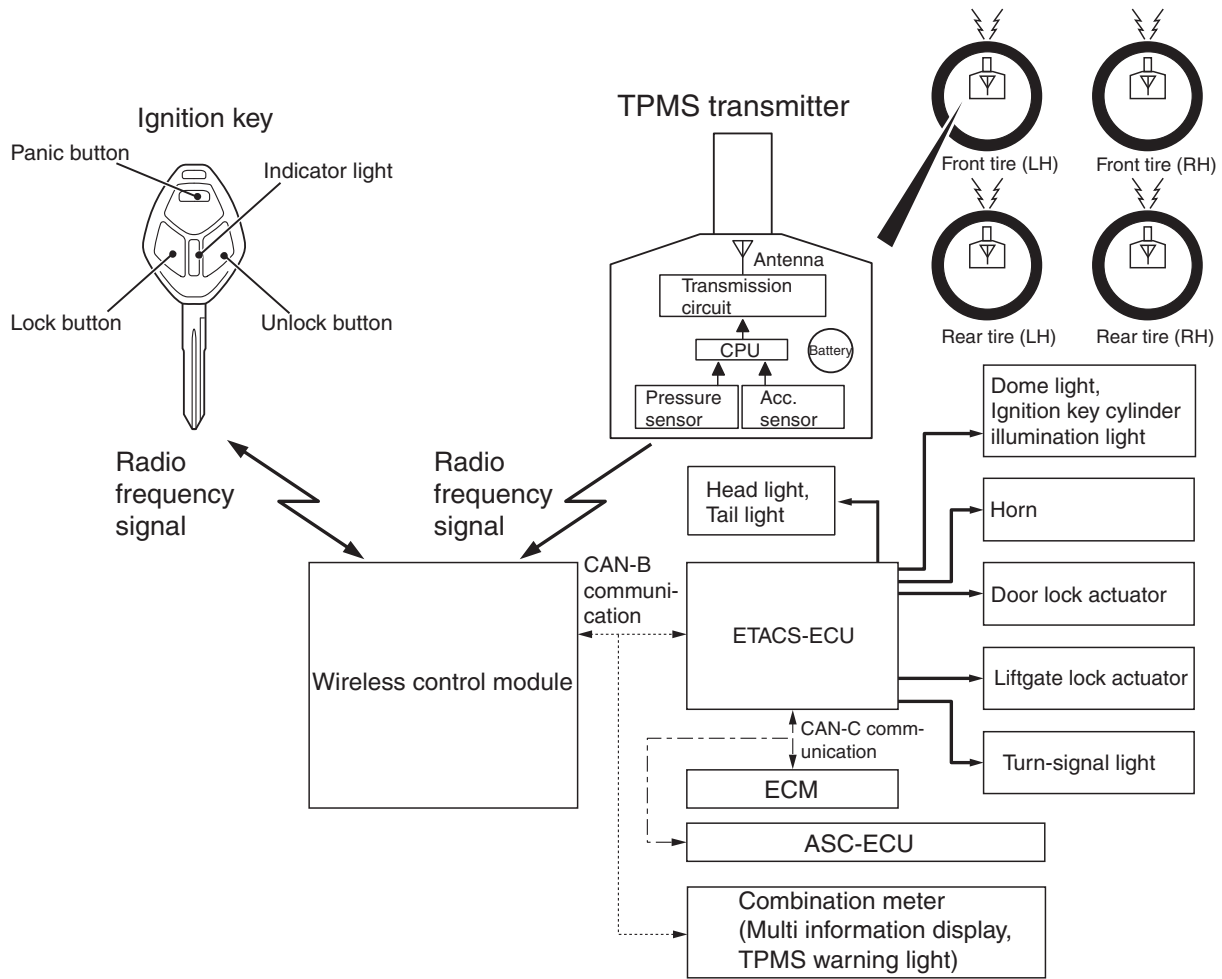

AC609283AD

*NOTE: In case of replacement of WCM, all keyless ID, key ID and tire pressure sensor ID should be re-registered using scan tool MB991958 (M.U.T.-III sub-assembly).*

**SPECIAL TOOL**

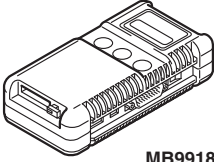
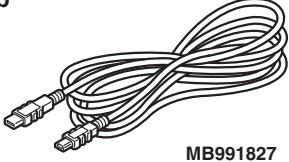
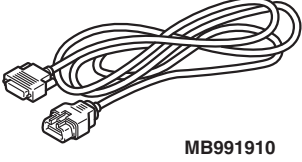
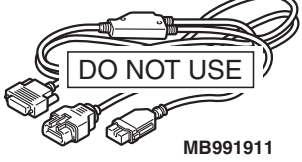
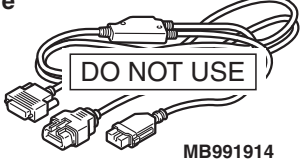
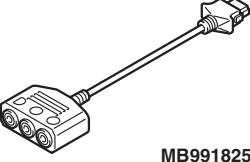
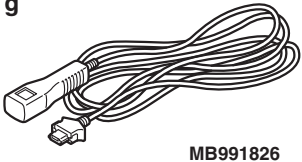
Tool	Tool number and name	Supersession	Application
<p>a</p>  <p>MB991824</p> <p>b</p>  <p>MB991827</p> <p>c</p>  <p>MB991910</p> <p>d</p>  <p>MB991911</p> <p>e</p>  <p>MB991914</p> <p>f</p>  <p>MB991825</p> <p>g</p>  <p>MB991826 MB991958</p>	<p>MB991958</p> <p>a. MB991824</p> <p>b. MB991827</p> <p>c. MB991910</p> <p>d. MB991911</p> <p>e. MB991914</p> <p>f. MB991825</p> <p>g. MB991826</p> <p>M.U.T.-III sub assembly</p> <p>a. Vehicle communication interface (V.C.I.)</p> <p>b. M.U.T.-III USB cable</p> <p>c. M.U.T.-III main harness A (Vehicles with CAN communication system)</p> <p>d. M.U.T.-III main harness B (Vehicles without CAN communication system)</p> <p>e. M.U.T.-III main harness C (for Chrysler models only)</p> <p>f. M.U.T.-III measurement adapter</p> <p>g. M.U.T.-III trigger harness</p>	<p>MB991824-KIT</p> <p><i>NOTE: G: MB991826 M.U.T.-III Trigger Harness is not necessary when pushing V.C.I. ENTER key.</i></p>	<p><b>⚠ CAUTION</b></p> <p><b>M.U.T.-III main harness A (MB991910) should be used. M.U.T.-III main harness B and C should not be used for this vehicle.</b></p> <p>ETACS-ECU check (Diagnostic trouble code, service data)</p>

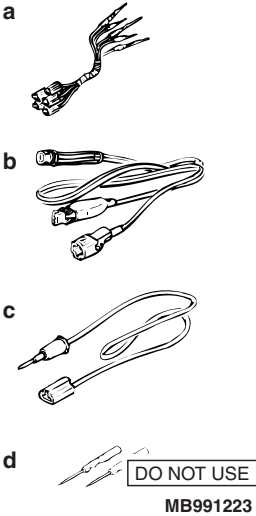
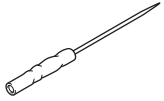
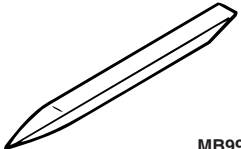
Tool	Tool number and name	Supersession	Application
	<p>MB991223</p> <p>a. MB991219 b. MB991220 c. MB991221 d. MB991222</p> <p>Harness set</p> <p>a. Test harness b. LED harness c. LED harness adaptor d. Probe</p>	<p>General service tools</p>	<p>Continuity check and voltage measurement at harness wire or connector for loose, corroded or damaged terminals, or terminals pushed back in the connector.</p> <p>a. Connector pin contact pressure inspection b. Power circuit inspection c. Power circuit inspection d. Commercial tester connection</p>
 <p align="center">MB992006</p>	<p>MB992006</p> <p>Extra fine probe</p>	<p>–</p>	<p>Making voltage and resistance measurement during troubleshooting</p>
 <p align="center">MB990784</p>	<p>MB990784</p> <p>Ornament remover</p>	<p>General service tool</p>	<p>Steering column cover removal</p>

## DIAGNOSIS

### STANDARD FLOW OF DIAGNOSTIC TROUBLESHOOTING

M1427504600035

Refer to GROUP 00 –How to Use Troubleshooting/Inspection Service Points, Contents of Troubleshooting [P.00-6](#).

### DIAGNOSTIC FUNCTION

M1427501400098

### HOW TO CONNECT THE SCAN TOOL (M.U.T.-III)

#### Required Special Tools:

- MB991958: Scan Tool (M.U.T.-III Sub Assembly)
  - MB991824: Vehicle Communication Interface (V.C.I.)
  - MB991827: M.U.T.-III USB Cable
  - MB991910: M.U.T.-III Main Harness A (Vehicles with CAN communication system)

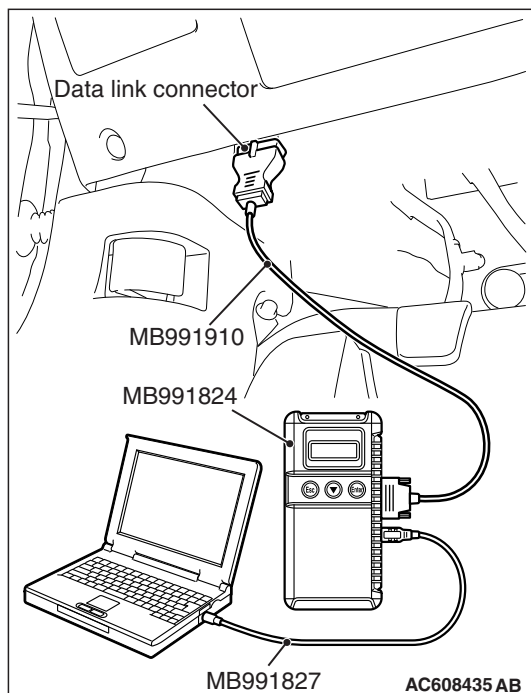
**⚠ CAUTION**

To prevent damage to scan tool MB991958, always turn the ignition switch to the "LOCK" (OFF) position before connecting or disconnecting scan tool MB991958.

1. Ensure that the ignition switch is at the "LOCK" (OFF) position.
2. Start up the personal computer.
3. Connect special tool MB991827 to special tool MB991824 and the personal computer.
4. Connect special tool MB991910 to special tool MB991824.
5. Connect special tool MB991910 to the data link connector.
6. Turn the power switch of special tool MB991824 to the "ON" position.

*NOTE: When special tool MB991824 is energized, special tool MB991824 indicator light will be illuminated in a green color.*

7. Start the M.U.T.-III system on the personal computer.

*NOTE: Disconnecting scan tool MB991958 is the reverse of the connecting sequence, making sure that the ignition switch is at the "LOCK" (OFF) position.*

## HOW TO READ AND ERASE DIAGNOSTIC TROUBLE CODES

### Required Special Tools:

- MB991958: Scan Tool (M.U.T.-III Sub Assembly)
  - MB991824: Vehicle Communication Interface (V.C.I.)
  - MB991827: M.U.T.-III USB Cable
  - MB991910: M.U.T.-III Main Harness A (Vehicles with CAN communication system)

**⚠ CAUTION**

To prevent damage to scan tool MB991958, always turn the ignition switch to the "LOCK" (OFF) position before connecting or disconnecting scan tool MB991958.

*NOTE: If the battery voltage is low, diagnostic trouble codes will not be set. Check the battery if scan tool MB991958 does not display.*

1. Connect scan tool MB991958 to the data link connector.
2. Turn the ignition switch to the "ON" position.
3. Select "System select" from the start-up screen.
4. Select "From 2006 MY" of "Model Year." When the "Vehicle Information" is displayed, check the contents.
5. Select "WCM" from "System List", and press the "OK" button.

*NOTE: When the "Loading Option Setup" list is displayed, check the applicable item.*

6. Select "Diagnostic Trouble Code." to read the DTC.
7. If a DTC is set, it is shown.
8. Choose "Erase DTCs" to erase the DTC.



**CHECK OF FREEZE FRAME DATA**

The freeze frame data can be checked by using the scan tool (GROUP 00, How to Cope with Intermittent Malfunction P.00-13).

When detecting fault and storing the DTC, the ECU connected to CAN bus line obtains the data before the determination of the DTC and the data when the DTC is determined, and then stores the ECU status of that time. By analyzing each data from scan tool, the troubleshooting can be performed more efficiently. The displayed items are as the table below.

**DISPLAY ITEM LIST**

Item No.	Item name	Data item	Unit
01	Odometer	Total driving distance after the diagnostic trouble code is generated	mile <sup>*</sup>
02	Ignition cycle	Number of times the ignition switch is turned "ON" or "LOCK (OFF)" after the past failure transition	Number of counts is displayed.
04	Current trouble accumulative time	Cumulative time for current malfunction of diagnostic trouble code	min

*NOTE: \* : If a failure occurs to both the ABS-ECU and ETACS-ECU, 0000 mile or FFFF mile is displayed to the scan tool MB991958.*

## ID CODES REGISTRATION JUDGMENT TABLE

M1427504400495

**⚠ CAUTION**

Do not replace the engine control module (ECM) and WCM at the same time. When replacing several ECUs, always replace one ECU at a time, register the necessary IDs in it, and then replace the next ECU.

The transponder (a small transmitter) in the ignition key, WCM, and the ECM have their own ID codes stored in them. When the cases listed in the table below occur, the ID codes must be registered in the WCM or ECM again.

*NOTE: Up to eight ignition keys (key ID and keyless entry secret code) can be stored in the memory of WCM.*

Item	Operation contents and procedure	Reference page for registration contents
When the ECM is replaced	<ol style="list-style-type: none"> <li>1. Registration of ENG key code.</li> <li>2. VIN programmed.</li> </ol>	ENG key code & VIN reg (Refer to GROUP 00 –Precautions before Service –How to Perform VIN Writing <a href="#">P.00-24</a> ).
When WCM is replaced	<ol style="list-style-type: none"> <li>1. VIN programmed</li> <li>2. Register all the key IDs of the ignition keys again.</li> <li>3. Register all the keyless IDs of the ignition keys again.</li> <li>4. Register the TPMS transmitters</li> </ol>	<ul style="list-style-type: none"> <li>• Write the VIN (Refer to GROUP 00 –Precautions before Service –How to Perform VIN Writing <a href="#">P.00-24</a>).</li> <li>• Key Registration, Keyless ID Registration and TPMS transmitter ID registration (Refer to <a href="#">P.42C-101</a>).</li> </ul>
When the ignition key is added as a single unit	<ol style="list-style-type: none"> <li>1. Register all the key IDs of the ignition keys again.</li> <li>2. Register all the keyless IDs of the ignition keys again.</li> </ol>	Key Registration and Keyless ID Registration (Refer to <a href="#">P.42C-101</a> )
When the ignition key is lost as a single unit	<ol style="list-style-type: none"> <li>1. Register all the key IDs of ignition keys other than the lost one again.</li> <li>2. Register all the keyless IDs of ignition keys other than the lost one again.</li> </ol>	
When the ignition key is replaced by the full service key set or the handle lock service key set is replaced by the piece.	<ol style="list-style-type: none"> <li>1. Register the key ID of the replaced ignition key again. &lt;Barcode No. input&gt;</li> <li>2. Register the keyless ID for all the ignition keys again.</li> </ol>	Key Registration (Barcode No.) and Keyless ID Registration (Refer to <a href="#">P.42C-101</a> )
When the key* is replaced by the door service key set is added by the piece.	Operation is not needed	–
When TPMS transmitter is replaced	Register the TPMS transmitter	Registering tire pressure sensor ID (Refer to <a href="#">P.42C-101</a> ).

*NOTE: \*: Key (the key that can be used to lock/unlock the door only)*

**SUPPLY UNIT LIST FOR INDIVIDUAL KEY**

Ignition key (with transmitter)
 AC709991

**KEY SUPPLY UNIT LIST FOR OTHER THAN INDIVIDUAL KEY**

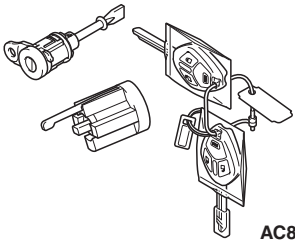
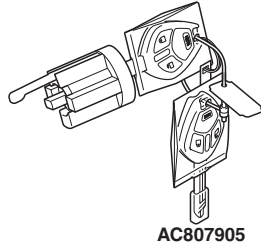
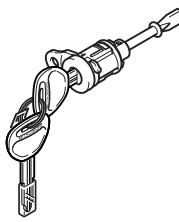
Full service key set	Handle lock service key set
 AC807904	 AC807905
<p><b>Door service key set (It can only be used for locking and unlocking, and it cannot start the engine.)</b></p>  AC702143	

Registration flow chart

**Caution:**  
Do not replace the ECM and the WCM simultaneously.  
Always replace the ECU by ones when the multiple ECU is replaced, and then replace the next ECU after registering the necessary IDs.

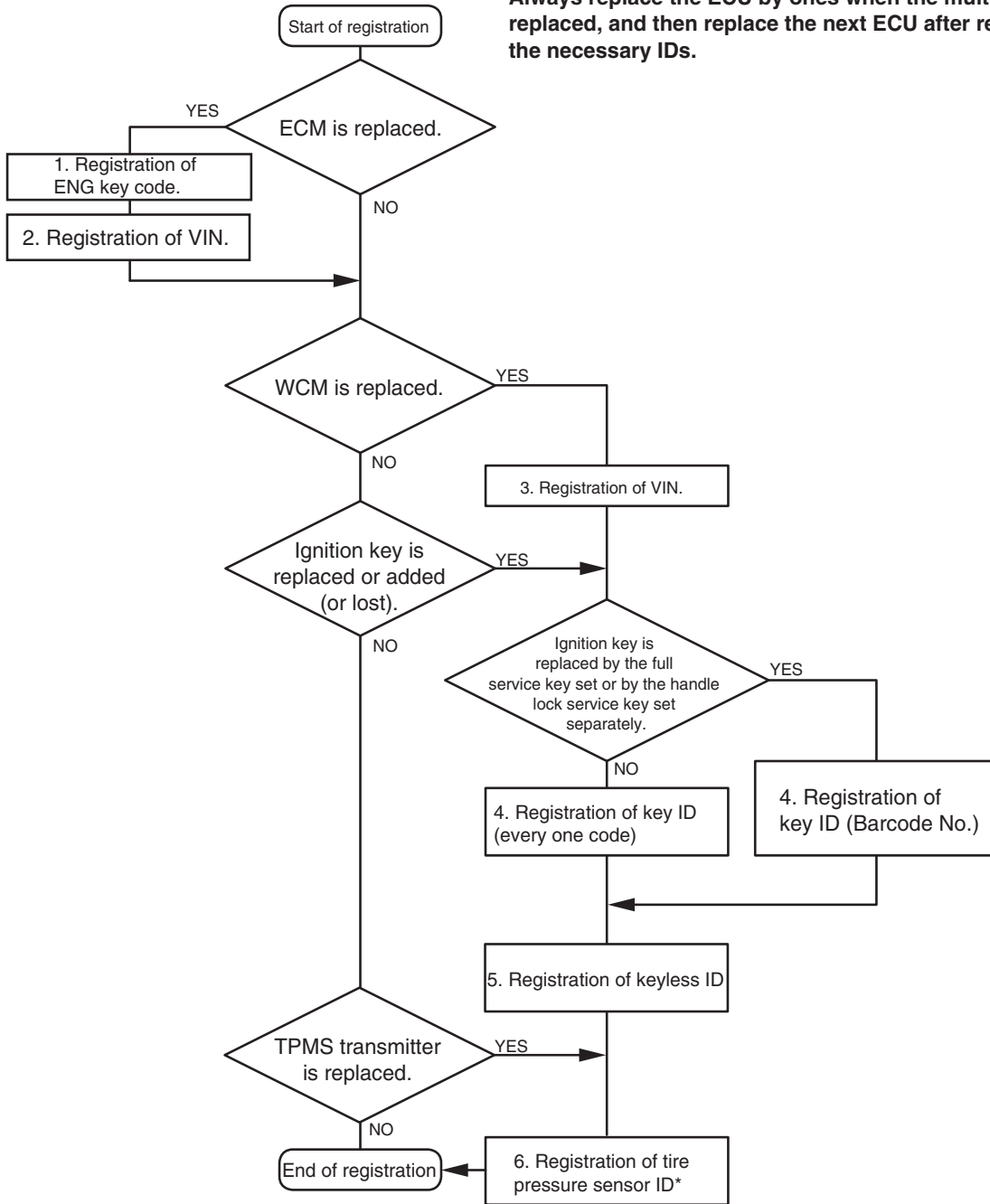



NOTE  
\*: When WCM or TPMS transmitter is replaced.

AC709689AB

**WARNINGS/ALARMS <VEHICLES WITHOUT COLOR LIQUID CRYSTAL DISPLAY>**

M1427508800031

If the TPMS fails or the tire pressure is low, the WCM warns the driver of that state by the TPMS warning light and the multi information display in the combination meter.

Display contents	Message	Item		State	Warning operations		Warning cancellation conditions (Cancels warning operations when one of the conditions met)
					TPMS warning light	Multi information display	
Not displayed	-	TPMS warning light bulb open circuit check		The ignition switch is turned from "LOCK" (OFF) to "ON."	Illuminates for 3 seconds.	-	3 seconds have passed after the TPMS warning light is lit.
 <small>AC809643</small>	LOW TIRE PRESSURE	Tire pressure alarm		The received tire pressure value is under the alarm ON threshold value.	Illuminates.	Symbol and "LOW TIRE PRESSURE" is displayed.	The received tire pressure value is over the alarm OFF threshold value.
 <small>AC809643</small>	SERVICE REQUIRED	TPMS failure warning	ID not stored	The TPMS transmitter ID is not registered in the WCM.	Flashes *	Symbol and "SERVICE REQUIRED" is displayed.	ID is registered normally.
			Defective EEPROM	Abnormality of data in the EEPROM of the WCM is detected.			Data in the EEPROM of the WCM is checked to be normal.
			Problem in signal reception	The signals from TPMS transmitters cannot be received while driving for about 20 minutes.			The signal from the TPMS transmitter that was warned is received.

Display contents	Message	Item		State	Warning operations		Warning cancellation conditions (Cancels warning operations when one of the conditions met)
					TPMS warning light	Multi information display	
 <small>AC809643</small>	SERVICE REQUIRED	TPMS failure warning	Defective sensor	The sensor failure signal is received from the TPMS transmitter.	Flashes *	Symbol and "SERVICE REQUIRE D" is displayed.	A normal signal is received from the TPMS transmitter that was warned.
			The battery voltage of the TPMS transmitter is low.	The reception problem warning is activated because of the low battery voltage of the TPMS transmitter.			The signal of normal battery voltage is received from the TPMS transmitter that was warned.
			Vehicle speed input problem	The vehicle speed is not input.			The vehicle speed is input.
			Abnormal vehicle speed value	The vehicle speed value is abnormal.			The normal vehicle speed value is received.

NOTE: \*: Change to continuous illumination after flashing for about 1 minute.

**WARNINGS/ALARMS <VEHICLES WITH COLOR LIQUID CRYSTAL DISPLAY>**

M1427508800042

If the TPMS fails or the tire pressure is low, the WCM warns the driver of that state by the TPMS warning light and the multi information display in the combination meter.

Display contents	Message	Item	State	Warning operations		Warning cancellation conditions (Cancels warning operations when one of the conditions met)
				TPMS warning light	Multi information display	
Not displayed	-	TPMS warning light bulb open circuit check	The ignition switch is turned from "LOCK" (OFF) to "ON."	Illuminates for 3 seconds.	-	3 seconds have passed after the TPMS warning light is lit.
 <small>AC809643</small>	LOW TIRE PRESSURE	Tire pressure alarm	The received tire pressure value is under the alarm ON threshold value.	Illuminates.	Symbol and "LOW TIRE PRESSURE" is displayed.	The received tire pressure value is over the alarm OFF threshold value.

Display contents	Message	Item		State	Warning operations		Warning cancellation conditions (Cancels warning operations when one of the conditions met)
					TPMS warning light	Multi information display	
 <small>AC809643</small>	TPMS SERVICE REQUIRED	TPMS failure warning	ID not stored	The TPMS transmitter ID is not registered in the WCM.	Flashes *	Symbol and "SERVICE REQUIRE D" is displayed.	ID is registered normally.
			Defective EEPROM	Abnormality of data in the EEPROM of the WCM is detected.			Data in the EEPROM of the WCM is checked to be normal.
			Problem in signal reception	The signals from TPMS transmitters cannot be received while driving for about 20 minutes.			The signal from the TPMS transmitter that was warned is received.
			Defective sensor	The sensor failure signal is received from the TPMS transmitter.			A normal signal is received from the TPMS transmitter that was warned.
			The battery voltage of the TPMS transmitter is low.	The reception problem warning is activated because of the low battery voltage of the TPMS transmitter.			The signal of normal battery voltage is received from the TPMS transmitter that was warned.
			Vehicle speed input problem	The vehicle speed is not input.			The vehicle speed is input.



Display contents	Message	Item		State	Warning operations		Warning cancellation conditions (Cancels warning operations when one of the conditions met)
					TPMS warning light	Multi information display	
 <small>AC809643</small>	TPMS SERVICE REQUIRED	TPMS failure warning	Abnormal vehicle speed value	The vehicle speed value is abnormal.	Flashes *	Symbol and "SERVICE REQUIRE D" is displayed.	The normal vehicle speed value is received.

*NOTE: \*: Change to continuous illumination after flashing for about 1 minute.*

## DIAGNOSTIC TROUBLE CODE CHART

M1427500200400

**⚠ CAUTION**

During diagnosis, a DTC associated with other system may be set when the ignition switch is turned on with connector(s) disconnected. On completion, confirm all systems for DTC(s). If DTC(s) are set, erase them all.

Diagnostic trouble code number	Diagnostic item	Reference page
B1731	Engine control module communication timeout	P.42C-20
B1761	VIN code not programmed	P.42C-22
B1A08	Keyless/KOS key1 performance	P.42C-24
B1A09	Keyless/KOS key2 performance	
B1A0A	Keyless/KOS key3 performance	
B1A0B	Keyless/KOS key4 performance	
B1A0C	Keyless key 5 performance	
B1A0D	Keyless key 6 performance	
B1A0E	Keyless key 7 performance	
B1A0F	Keyless key 8 performance	
B1A10	Keyless/KOS key 1 low battery	
B1A11	Keyless/KOS key 2 low battery	
B1A12	Keyless/KOS key 3 low battery	
B1A13	Keyless/KOS key 4 low battery	
B1A14	Keyless key 5 low battery	
B1A15	Keyless key 6 low battery	
B1A16	Keyless key 7 low battery	
B1A17	Keyless key 8 low battery	
B1A24	Key ID not registered	P.42C-26
B1A25	Key ID unmatched	P.42C-28
B1A28	Engine control module authenticate error	P.42C-30
B1A35	Transponder read error	P.42C-32
B2101	IG SW start POS.circuit low	P.42C-35
B2102	IG SW start POS.circuit high	
B2204	Coding data mismatch	P.42C-38
B2206	VIN code mismatch	P.42C-40
B2352	Antenna fail	P.42C-41
B2401	Keyless/KOS key ID not register	P.42C-42
B2416	ECU internal error	P.42C-43
C1608	EEPROM error	P.42C-44
C1900	No registration	P.42C-45
C1901	Vehicle speed information abnormality	P.42C-47

<b>Diagnostic trouble code number</b>	<b>Diagnostic item</b>	<b>Reference page</b>
C1910	Transmitter low battery voltage abnormality 1	P.42C-49
C1920	Transmitter low battery voltage abnormality 2	
C1930	Transmitter low battery voltage abnormality 3	
C1940	Transmitter low battery voltage abnormality 4	
C1911	Reception abnormality 1	
C1921	Reception abnormality 2	
C1931	Reception abnormality 3	
C1941	Reception abnormality 4	
C1912	Tire inflation pressure warning 1	P.42C-50
C1922	Tire inflation pressure warning 2	
C1932	Tire inflation pressure warning 3	
C1942	Tire inflation pressure warning 4	
C1913	Acceleration sensor abnormality 1	P.42C-53
C1923	Acceleration sensor abnormality 2	
C1933	Acceleration sensor abnormality 3	
C1943	Acceleration sensor abnormality 4	
C1914	Pressure sensor abnormality 1	
C1924	Pressure sensor abnormality 2	
C1934	Pressure sensor abnormality 3	
C1944	Pressure sensor abnormality 4	
C1915	Transmitter OFF mode 1	P.42C-55
C1925	Transmitter OFF mode 2	
C1935	Transmitter OFF mode 3	
C1945	Transmitter OFF mode 4	
U0019	Bus off (CAN-B)	P.42C-56
U0141	ETACS-ECU CAN timeout	P.42C-58
U0151	SRS-ECU CAN timeout	P.42C-60
U0154	Occupant classification-ECU CAN timeout	P.42C-62
U0155	Combination meter CAN timeout	P.42C-64
U0164	A/C-ECU CAN timeout	P.42C-66
U0184	Audio CAN timeout	P.42C-68
U0195	Satellite radio tuner CAN timeout	P.42C-70
U0197	Hands free module CAN timeout	P.42C-72
U0245	Audio visual navigation unit CAN timeout	P.42C-74
U1412	Implausible vehicle speed signal received	P.42C-76
U1415	Coding not completed/Data fail	P.42C-77
U1417	Implausible coding data	P.42C-79

## DIAGNOSTIC TROUBLE CODE PROCEDURES

## DTC B1731: Engine control module communication timeout

**CAUTION**

- When the DTC B1731 is set, be sure to diagnose the CAN bus line.
- When replacing the ECU, always check that the communication circuit is normal.

**DTC SET CONDITION**

WCM checks that the engine control module data has been received via the CAN bus lines, and if not, sets the DTC No. B1731.

**TECHNICAL DESCRIPTION (COMMENT)**

If no data [ETACS transmits engine random number data to WCM via the CAN bus lines] is received from the engine control module via the CAN bus lines when the ignition switch is turned to ON position, it is judged as abnormal.

**TROUBLESHOOTING HINTS**

- Malfunction of CAN bus line
- Damaged wiring harness and connectors
- Malfunction of WCM
- Malfunction of engine control module
- Malfunction of ETACS-ECU

**DIAGNOSIS****Required Special Tools:**

- MB991958: Scan Tool (M.U.T.-III Sub Assembly)
  - MB991824: Vehicle Communication Interface (V.C.I.)
  - MB991827: M.U.T.-III USB Cable
  - MB991910: M.U.T.-III Main Harness A (Vehicles with CAN communication system)

**STEP 1. Using scan tool MB991958, diagnose the CAN bus line.****CAUTION**

To prevent damage to scan tool (MB991958), always turn the ignition switch to the "LOCK" (OFF) position before connecting or disconnecting scan tool (MB991958).

- (1) Connect scan tool MB991958 to the data link connector.
- (2) Turn the ignition switch to the "ON" position.
- (3) Diagnose the CAN bus line.
- (4) Turn the ignition switch to the "LOCK" (OFF) position.

**Q: Is the CAN bus line found to be normal?**

**YES** : Go to Step 2.

**NO** : Repair the CAN bus line. (Refer to GROUP 54C, Diagnosis P.54C-16).

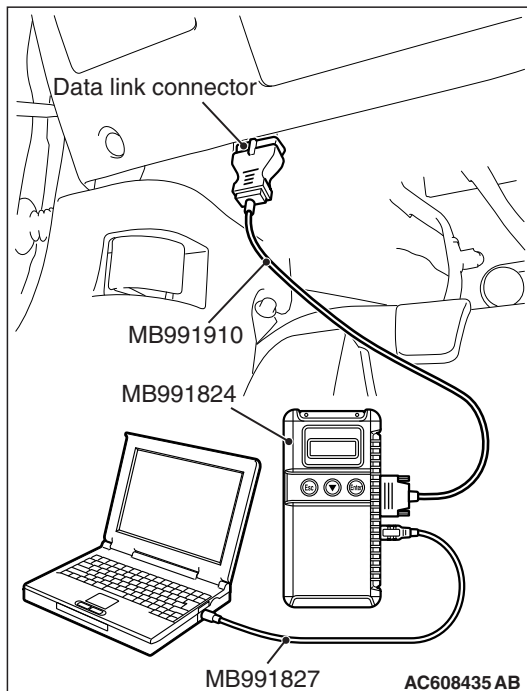

---

**STEP 2. Using scan tool MB991958, read the engine control module diagnostic trouble code.**

Check again if the DTC is set to the engine control module.

**Q: Is the DTC set?**

**YES :** Troubleshoot the MFI system (Refer to GROUP 13A, Diagnostic trouble code chart [P.13A-50](#) <2.0L Engine>, GROUP 13B, Diagnostic trouble code chart [P.13B-51](#) <2.4L Engine>)..

**NO :** Go to Step 3.

---

**STEP 3. Using scan tool MB991958, read the other system diagnostic trouble code.**

Check if DTC U0100 is set to ETACS-ECU.

**Q: Is the DTC set?**

**YES :** Go to Step 5.

**NO :** Go to Step 4.

---

**STEP 4. Recheck for diagnostic trouble code.**

Check again if the DTC is set to the WCM.

(1) Turn the ignition switch from "LOCK" (OFF) position to "ON" position.

(2) Check if DTC is set.

(3) Turn the ignition switch to the "LOCK" (OFF) position.

**Q: Is the DTC set?**

**YES :** Replace WCM and register the ID codes. (Refer to [P.42C-10](#).) After registering the ID codes, go to Step 6.

**NO :** The trouble can be an intermittent malfunction (Refer to GROUP 00 –How to use Troubleshooting/inspection Service Points –How to Cope with Intermittent Malfunction [P.00-13](#)).

---

**STEP 5. Recheck for diagnostic trouble code.**

Check again if the DTC is set to the WCM.

(1) Turn the ignition switch from "LOCK" (OFF) position to "ON" position.

(2) Check if DTC is set.

(3) Turn the ignition switch to the "LOCK" (OFF) position.

**Q: Is the DTC set?**

**YES :** Replace the engine control module and record the VIN (Refer to GROUP 00 - How To Perform Vehicle Identification Number (VIN) Writing [P.00-24](#)). Then go to Step 6.

**NO :** The procedure is complete.

**STEP 6. Recheck for diagnostic trouble code.**

Check again if the DTC is set to the WCM.

- (1) Turn the ignition switch from "LOCK" (OFF) position to "ON" position.
- (2) Check if DTC is set.
- (3) Turn the ignition switch to the "LOCK" (OFF) position.

**Q: Is the DTC set?**

**YES** : Replace the ETACS-ECU.

**NO** : The procedure is complete.

---

**DTC B1761: VIN code not programmed**

---

**⚠ CAUTION**

- When the DTC No. B1761 is set, be sure to diagnose the CAN bus line.
- When replacing the ECU, always check that the communication circuit is normal.

**DTC SET CONDITION**

WCM sets DTC B1761 when no VIN is recorded in it.

**TECHNICAL DESCRIPTION (COMMENT)**

WCM determines that the abnormality is present when no VIN is recorded in it.

**TROUBLESHOOTING HINTS**

- Malfunction of CAN bus line
- VIN not programmed
- Malfunction of the WCM

**DIAGNOSIS****Required Special Tools:**

- MB991958: Scan Tool (M.U.T.-III Sub Assembly)
  - MB991824: Vehicle Communication Interface (V.C.I.)
  - MB991827: M.U.T.-III USB Cable
  - MB991910: M.U.T.-III Main Harness A (Vehicles with CAN communication system)

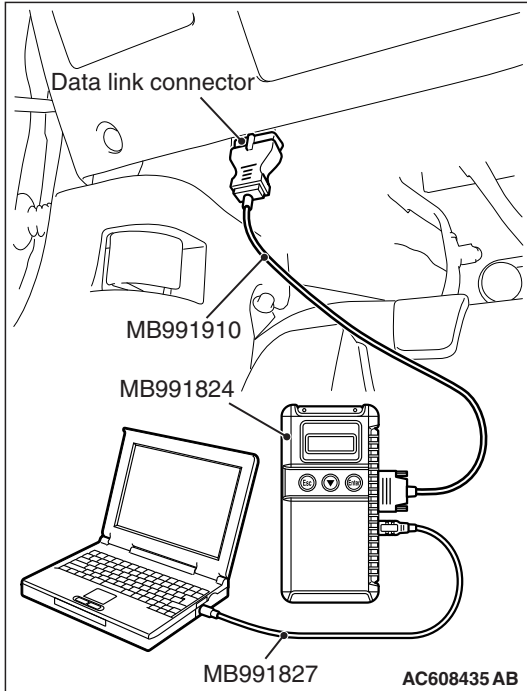

**STEP 1. Using scan tool MB991958, diagnose the CAN bus line.**

**⚠ CAUTION**

To prevent damage to scan tool (MB991958), always turn the ignition switch to the "LOCK" (OFF) position before connecting or disconnecting scan tool (MB991958).

- (1) Connect scan tool MB991958 to the data link connector.
- (2) Turn the ignition switch to the "ON" position.
- (3) Diagnose the CAN bus line.
- (4) Turn the ignition switch to the "LOCK" (OFF) position.

**Q: Is the CAN bus line found to be normal?**

**YES :** Go to Step 2.

**NO :** Repair the CAN bus line. (Refer to GROUP 54C, Diagnosis P.54C-16).

**STEP 2. Register the VIN and recheck the diagnostic trouble code.**

Register VIN in WCM (Refer to GROUP 00 –How to Perform Vehicle Identification Number (VIN) Writing P.00-24) and recheck if the DTC is set.

- (1) Turn the ignition switch from the "LOCK" (OFF) position to the "ON" position.
- (2) Check if DTC is set.
- (3) Turn the ignition switch to the "LOCK" (OFF) position.

**Q: Is the DTC set?**

**YES :** Replace WCM and register the ID codes. (Refer to P.42C-10.)

**NO :** The procedure is complete.

DTC B1A08: Keyless/KOS key1 performance  
 DTC B1A09: Keyless/KOS key2 performance  
 DTC B1A0A: Keyless/KOS key3 performance  
 DTC B1A0B: Keyless/KOS key4 performance  
 DTC B1A0C: Keyless key 5 performance  
 DTC B1A0D: Keyless key 6 performance  
 DTC B1A0E: Keyless key 7 performance  
 DTC B1A0F: Keyless key 8 performance

### CAUTION

When replacing the ECU, always check that the communication circuit is normal.

### DTC SET CONDITION

The door locking/unlocking code is automatically updated every time the doors are locked (rolling code). WCM stores DTC B1A08, B1A09, B1A0A, B1A0B, B1A0C, B1A0D, B1A0E, or B1A0F when it receives wrong signal (rolling code out of synchronization) from the transmitter.

### TECHNICAL DESCRIPTION (COMMENT)

- B1A08: WCM determines that the abnormality is present when the rolling code received from the transmitter 1 (the first transmitter registered in WCM) greatly differs from the rolling code stored in WCM.
- B1A09: WCM determines that the abnormality is present when the rolling code received from the transmitter 2 (the second transmitter registered in WCM) greatly differs from the rolling code stored in WCM.
- B1A0A: WCM determines that the abnormality is present when the rolling code received from the transmitter 3 (the third transmitter registered in WCM) greatly differs from the rolling code stored in WCM.
- B1A0B: WCM determines that the abnormality is present when the rolling code received from the transmitter 4 (the fourth transmitter registered in WCM) greatly differs from the rolling code stored in WCM.
- B1A0C: WCM determines that the abnormality is present when the rolling code received from the transmitter 5 (the fifth transmitter registered in WCM) greatly differs from the rolling code stored in WCM.

- B1A0D: WCM determines that the abnormality is present when the rolling code received from the transmitter 6 (the sixth transmitter registered in WCM) greatly differs from the rolling code stored in WCM.
- B1A0E: WCM determines that the abnormality is present when the rolling code received from the transmitter 7 (the seventh transmitter registered in WCM) greatly differs from the rolling code stored in WCM.
- B1A0F: WCM determines that the abnormality is present when the rolling code received from the transmitter 8 (the eighth transmitter registered in WCM) greatly differs from the rolling code stored in WCM.

### TROUBLESHOOTING HINTS

- Rolling code out of synchronization
- Malfunction of the transmitter
- Malfunction of the WCM

### DIAGNOSIS

#### STEP 1. Synchronize the rolling code and recheck the diagnostic trouble code.

- (1) Synchronize the rolling code. Use either way to synchronize the rolling code:
  - Push the transmitter switches twice or more.
  - Register the keyless ID (Refer to P.42C-101).
- (2) Recheck if the DTC is set.
  - a. Erase the DTC.
  - b. Push the lock switch or unlock switch of transmitter.
  - c. Check if the DTC is set.

#### Q: Is the DTC set?

**YES** : Go to Step 2.

**NO** : The diagnosis is complete.



---

**STEP 2. Check whether the diagnostic trouble code is reset.**

Replace the transmitter by which the DTC is set with a new one, register the key ID and the keyless ID (Refer to P.42C-101), and recheck if the DTC is set.

- (1) Erase the DTC.
- (2) Push the lock switch or unlock switch of transmitter.
- (3) Check if the DTC is set.

**Q: Is the DTC set?**

**YES** : Replace WCM and register the ID codes (Refer to P.42C-10).

**NO** : The diagnosis is complete.

---

**DTC B1A10: Keyless/KOS key 1 low battery**

**DTC B1A11: Keyless/KOS key 2 low battery**

**DTC B1A12: Keyless/KOS key 3 low battery**

**DTC B1A13: Keyless/KOS key 4 low battery**

**DTC B1A14: Keyless key 5 low battery**

**DTC B1A15: Keyless key 6 low battery**

**DTC B1A16: Keyless key 7 low battery**

**DTC B1A17: Keyless key 8 low battery**

---

**⚠ CAUTION**

When replacing the ECU, always check that the communication circuit is normal.

**DTC SET CONDITION**

WCM sets DTC B1A10, B1A11, B1A12, B1A13, B1A14, B1A15, B1A16, or B1A17 when it receives low battery voltage signal from the transmitter.

**TECHNICAL DESCRIPTION (COMMENT)**

- B1A10: WCM determines that the abnormality is present when it receives low battery voltage signal from the transmitter 1 (the first transmitter registered in WCM) five consecutive times.
- B1A11: WCM determines that the abnormality is present when it receives low battery voltage signal from the transmitter 2 (the second transmitter registered in WCM) five consecutive times.
- B1A12: WCM determines that the abnormality is present when it receives low battery voltage signal from the transmitter 3 (the third transmitter registered in WCM) five consecutive times.

- B1A13: WCM determines that the abnormality is present when it receives low battery voltage signal from the transmitter 4 (the fourth transmitter registered in WCM) five consecutive times.
- B1A14: WCM determines that the abnormality is present when it receives low battery voltage signal from the transmitter 5 (the fifth transmitter registered in WCM) five consecutive times.
- B1A15: WCM determines that the abnormality is present when it receives low battery voltage signal from the transmitter 6 (the sixth transmitter registered in WCM) five consecutive times.
- B1A16: WCM determines that the abnormality is present when it receives low battery voltage signal from the transmitter 7 (the seventh transmitter registered in WCM) five consecutive times.
- B1A17: WCM determines that the abnormality is present when it receives low battery voltage signal from the transmitter 8 (the eighth transmitter registered in WCM) five consecutive times.

**TROUBLESHOOTING HINTS**

- Battery failure in the transmitter
- Malfunction of the transmitter
- Malfunction of WCM

**DIAGNOSIS****STEP 1. Replace the battery in the transmitter and recheck the diagnostic trouble code.**

Replace the battery in the transmitter by which the DTC is set with a new one, and recheck if the DTC is set (Refer to P.42C-118).

- (1) Replace the battery in the transmitter by which the DTC is set.
- (2) Use the transmitter to lock/unlock the doors.
- (3) Check if the DTC is set.

**Q: Is the DTC set?**

**YES** : Go to Step 2.

**NO** : The diagnosis is complete (Discharged battery).

**STEP 2. Replace the transmitter and recheck the diagnostic trouble code.**

Replace the transmitter by which the DTC is set with a new one, register the key ID and the keyless entry secret code (Refer to P.42C-101), and recheck if the DTC is set.

- (1) Use the transmitter to lock/unlock the doors.
- (2) Check if the DTC is set.

**Q: Is the DTC set?**

**YES** : Replace WCM and register the ID codes (Refer to P.42C-10).

**NO** : The diagnosis is complete.

**DTC B1A24: Key ID not registered****⚠ CAUTION**

- When the DTC B1A24 is set, be sure to diagnose the CAN bus line.
- When replacing the ECU, always check that the communication circuit is normal.

**DTC SET CONDITION**

WCM sets DTC B1A24 when the encrypted code was not registered in it.

**TECHNICAL DESCRIPTION (COMMENT)**

WCM determines that the abnormality is present, if the ignition key's key ID is not registered in WCM when the ignition switch is turned ON.

**TROUBLESHOOTING HINTS**

- Key ID not registered
- Malfunction of CAN bus line
- Malfunction of WCM

**DIAGNOSIS****Required Special Tools:**

- MB991958: Scan Tool (M.U.T.-III Sub Assembly)
  - MB991824: Vehicle Communication Interface (V.C.I.)
  - MB991827: M.U.T.-III USB Cable
  - MB991910: M.U.T.-III Main Harness A (Vehicles with CAN communication system)

**STEP 1. Using scan tool MB991958, diagnose the CAN bus line.**

**⚠ CAUTION**

To prevent damage to scan tool (MB991958), always turn the ignition switch to the "LOCK" (OFF) position before connecting or disconnecting scan tool (MB991958).

- (1) Connect scan tool MB991958 to the data link connector.
- (2) Turn the ignition switch to the "ON" position.
- (3) Diagnose the CAN bus line.
- (4) Turn the ignition switch to the "LOCK" (OFF) position.

**Q: Is the CAN bus line found to be normal?**

**YES :** Go to Step 2.

**NO :** Repair the CAN bus line. (Refer to GROUP 54C, Diagnosis P.54C-16).

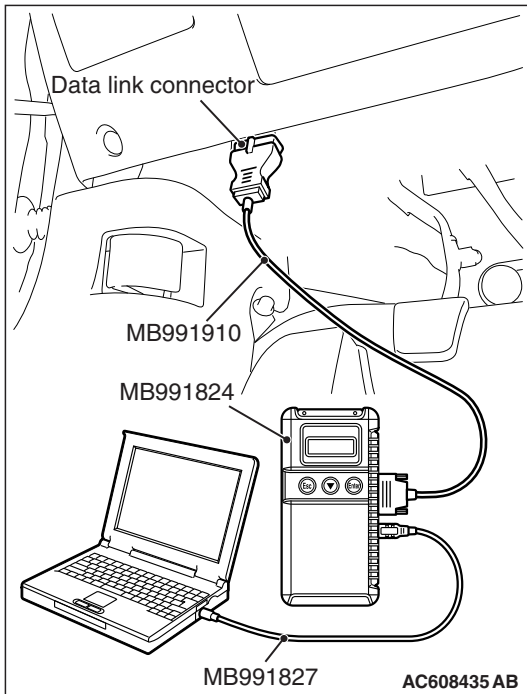

**STEP 2. Register the key ID and recheck the diagnostic trouble code.**

Register the key ID of the ignition key (refer to P.42C-10), and recheck if the DTC is set.

- (1) Turn the ignition switch from the "LOCK" (OFF) position to the "ON" position.
- (2) Check if the DTC is set.

**Q: Is the DTC set?**

**YES :** Replace WCM and register the ID codes. (Refer to P.42C-10.)

**NO :** The procedure is complete.

**DTC B1A25: Key ID unmatched****CAUTION**

When the DTC B1A25 is set, be sure to diagnose the CAN bus line. When replacing the ECU, always check that the communication circuit is normal.

**DTC SET CONDITION**

WCM sets DTC B1A25 when the received key ID is different from the one registered in it.

**TECHNICAL DESCRIPTION (COMMENT)**

WCM determines that the abnormality is present, if the key ID for the ignition key does not match the one registered in WCM when the ignition switch is turned ON.

**TROUBLESHOOTING HINTS**

- Malfunction of CAN bus line
- Malfunction of the ignition key
- Accessory key not registered
- Key is registered to another vehicle
- Malfunction of WCM

**DIAGNOSIS****Required Special Tools:**

- MB991958: Scan Tool (M.U.T.-III Sub Assembly)
  - MB991824: Vehicle Communication Interface (V.C.I.)
  - MB991827: M.U.T.-III USB Cable
  - MB991910: M.U.T.-III Main Harness A (Vehicles with CAN communication system)

**STEP 1. Using scan tool MB991958, diagnose the CAN bus line.****CAUTION**

To prevent damage to scan tool (MB991958), always turn the ignition switch to the "LOCK" (OFF) position before connecting or disconnecting scan tool (MB991958).

- (1) Connect scan tool MB991958 to the data link connector.
- (2) Turn the ignition switch to the "ON" position.
- (3) Diagnose the CAN bus line.
- (4) Turn the ignition switch to the "LOCK" (OFF) position.

**Q: Is the CAN bus line found to be normal?**

**YES** : Go to Step 2.

**NO** : Repair the CAN bus line. (Refer to GROUP 54C, Diagnosis [P.54C-16](#)).

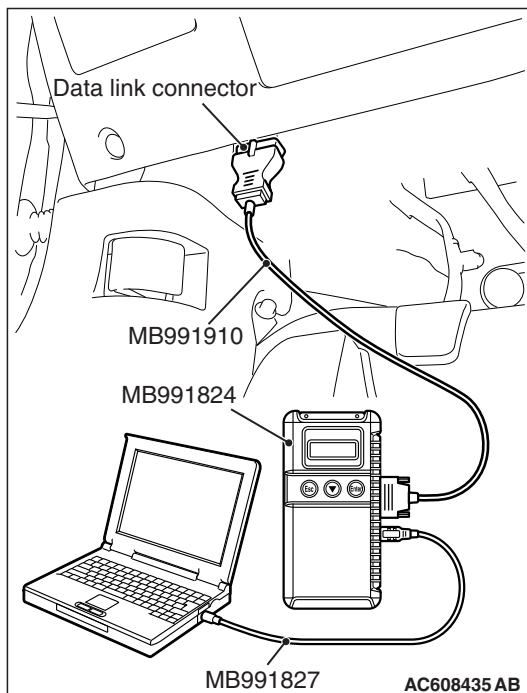

---

**STEP 2. Register the key ID and recheck the diagnostic trouble code.**

Register the key ID of the ignition key (refer to [P.42C-10](#)), and recheck if the DTC is set.

- (1) Turn the ignition switch from the "LOCK" (OFF) position to the "ON" position.
- (2) Check if the DTC is set.

**Q: Is the DTC set?**

**YES** : Go to Step 3.

**NO** : The procedure is complete.

---

**STEP 3. Replace the ignition key and recheck the diagnostic trouble code.**

Replace the ignition key by which the DTC is set with the other key, and recheck if the DTC is set.

- (1) Turn the ignition switch from the "LOCK" (OFF) position to the "ON" position.
- (2) Check if the DTC is set.

**Q: Is the DTC set?**

**YES** : Go to Step 4.

**NO** : Go to Step 5.

---

**STEP 4. Register the key ID and recheck the diagnostic trouble code.**

Register the key ID of the ignition key (refer to [P.42C-10](#)), and recheck if the DTC is set.

- (1) Turn the ignition switch from the "LOCK" (OFF) position to the "ON" position.
- (2) Check if the DTC is set.

**Q: Is the DTC set?**

**YES** : Go to Step 5.

**NO** : The procedure is complete.

---

**STEP 5. Replace the ignition key and recheck the diagnostic trouble code.**

Replace the ignition key with a new one, register the key ID and keyless ID of the new key, (refer to [P.42C-10](#)), and recheck if the DTC is set.

- (1) Turn the ignition switch from the "LOCK" (OFF) position to the "ON" position.
- (2) Check if the DTC is set.

**Q: Is the DTC set?**

**YES** : Replace WCM and register the ID codes (Refer to [P.42C-10](#)).

**NO** : The procedure is complete.

**DTC B1A28: Engine control module authenticate error****CAUTION**

- When the DTC B1A28 is set, be sure to diagnose the CAN bus line.
- When replacing the ECU, always check that the communication circuit is normal.

**DTC SET CONDITION**

WCM sets DTC B1A28 when the ignition key certification result and the engine control module starting condition do not match.

**TECHNICAL DESCRIPTION (COMMENT)**

WCM determines that the abnormality is present, if the key certification result and the engine control module starting condition do not match after the engine start permission communication is completed.

**TROUBLESHOOTING HINTS**

- Malfunction of CAN bus line
- Malfunction of WCM
- Engine control module malfunction
- VIN registered in engine control module unmatched

**DIAGNOSIS****Required Special Tools:**

- MB991958: Scan Tool (M.U.T.-III Sub Assembly)
  - MB991824: Vehicle Communication Interface (V.C.I.)
  - MB991827: M.U.T.-III USB Cable
  - MB991910: M.U.T.-III Main Harness A (Vehicles with CAN communication system)

**STEP 1. Using scan tool MB991958, diagnose the CAN bus line.****CAUTION**

To prevent damage to scan tool (MB991958), always turn the ignition switch to the "LOCK" (OFF) position before connecting or disconnecting scan tool (MB991958).

- (1) Connect scan tool MB991958 to the data link connector.
- (2) Turn the ignition switch to the "ON" position.
- (3) Diagnose the CAN bus line.
- (4) Turn the ignition switch to the "LOCK" (OFF) position.

**Q: Is the CAN bus line found to be normal?**

**YES** : Go to Step 2.

**NO** : Repair the CAN bus line. (Refer to GROUP 54C, Diagnosis [P.54C-16](#)).

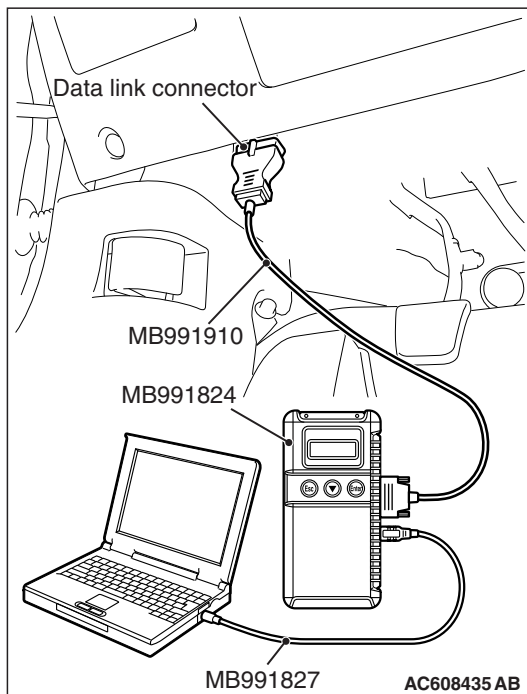

---

**STEP 2. Using scan tool MB991958, read the engine control module diagnostic trouble code.**

Check again if the DTC is set to the engine control module.

**Q: Is the DTC set?**

**YES** : Troubleshoot the MFI system (Refer to GROUP 13A, Diagnostic trouble code chart [P.13A-50](#) <2.0L Engine>, GROUP 13B, Diagnostic trouble code chart [P.13B-51](#) <2.4L Engine>). Then go to Step 3.

**NO** : Go to Step 3.

---

**STEP 3. Using scan tool MB991958, read the diagnostic trouble code.**

Check if the DTC is set to the WCM.

(1) Turn the ignition switch from the "LOCK" (OFF) position to the "ON" position.

(2) Check if the DTC is set.

**Q: Is DTC B1761 or B2206 set other than B1A28?**

**YES** : Perform the troubleshooting for each DTC. Refer to [P.42C-22](#) <B1761> and [P.42C-40](#) <B2206>. Then go to Step 4.

**NO** : Go to Step 4.

---

**STEP 4. Recheck for diagnostic trouble code.**

Check again if the DTC is set to the WCM.

(1) Turn the ignition switch from the "LOCK" (OFF) position to the "ON" position.

(2) Check if the DTC is set.

**Q: Is the DTC set?**

**YES** : Replace WCM and register the ID codes (Refer to [P.42C-10](#)). Then go to Step 5.

**NO** : The diagnosis is complete.

---

**STEP 5. Recheck for diagnostic trouble code.**

Check again if the DTC is set to the WCM.

(1) Turn the ignition switch from the "LOCK" (OFF) position to the "ON" position.

(2) Check if the DTC is set.

**Q: Is the DTC set?**

**YES** : Replace the engine control module and record VIN (Refer to GROUP 00 –How to Perform Vehicle Identification Number (VIN) Writing [P.00-24](#)).

**NO** : The procedure is complete.



**DTC B1A35: Transponder read error****CAUTION**

- When DTC B1A35 is set, be sure to diagnose the CAN bus line.
- When replacing the ECU, always check that the communication circuit is normal.

**DTC SET CONDITION**

WCM sets DTC B1A35 when it cannot receive data from the transponder.

**TECHNICAL DESCRIPTION (COMMENT)**

WCM determines that the abnormality is present, if it cannot receive the key ID for the ignition key when the ignition switch is turned ON.

**TROUBLESHOOTING HINTS**

- Malfunction of CAN bus line
- Malfunction of the ignition key
- Malfunction of WCM
- Interference of the encrypted code

**DIAGNOSIS****Required Special Tools:**

- MB991958: Scan Tool (M.U.T.-III Sub Assembly)
  - MB991824: Vehicle Communication Interface (V.C.I.)
  - MB991827: M.U.T.-III USB Cable
  - MB991910: M.U.T.-III Main Harness A (Vehicles with CAN communication system)

**STEP 1. Using scan tool MB991958, diagnose the CAN bus line.****CAUTION**

To prevent damage to scan tool (MB991958), always turn the ignition switch to the "LOCK" (OFF) position before connecting or disconnecting scan tool (MB991958).

- (1) Connect scan tool MB991958 to the data link connector.
- (2) Turn the ignition switch to the "ON" position.
- (3) Diagnose the CAN bus line.
- (4) Turn the ignition switch to the "LOCK" (OFF) position.

**Q: Is the CAN bus line found to be normal?**

**YES** : Go to Step 2.

**NO** : Repair the CAN bus line. (Refer to GROUP 54C, Diagnosis [P.54C-16](#)).

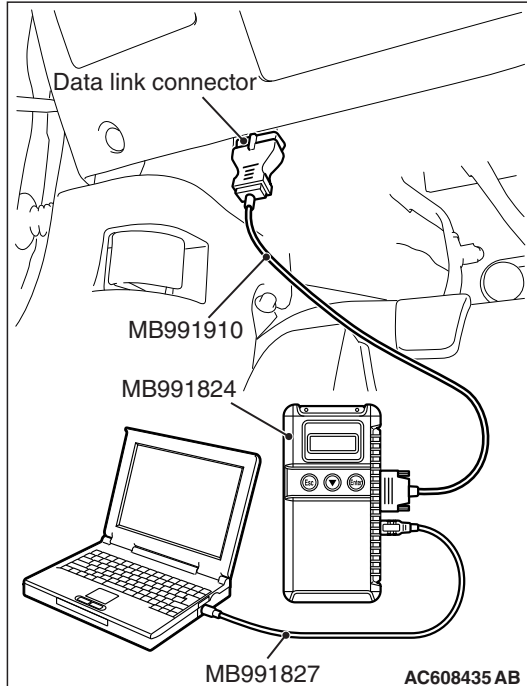



---

**STEP 2. Check the ignition key inserted in the key cylinder for interference.**

**Q: Are there other ignition keys or anything that interferes with the communication (things that generate radio waves such as magnets or air-cleaning device that has a power plug) near the ignition key inserted in the key cylinder?**

**YES :** Move away or remove other ignition keys or anything that interferes with the communication, and go to Step 3.

**NO :** Go to Step 3.

---

**STEP 3. Recheck for diagnostic trouble code.**

Check again if the DTC is set to the WCM.

(1) Turn the ignition switch from the "LOCK" (OFF) position to the "ON" position.

(2) Check if the DTC is set.

**Q: Is the DTC set?**

**YES :** Go to Step 4.

**NO :** The procedure is complete.

---

**STEP 4. Replace the ignition key and recheck the diagnostic trouble code.**

Replace the ignition key by which the DTC is set with the other key, and recheck if the DTC is set.

(1) Turn the ignition switch from the "LOCK" (OFF) position to the "ON" position.

(2) Check if the DTC is set.

**Q: Is the DTC set?**

**YES :** Go to Step 5.

**NO :** Go to Step 6.

---

**STEP 5. Register the key ID and recheck the diagnostic trouble code.**

Register the key ID of the ignition key (refer to [P.42C-10](#)), and recheck if the DTC is set.

(1) Turn the ignition switch from the "LOCK" (OFF) position to the "ON" position.

(2) Check if the DTC is set.

**Q: Is the DTC set?**

**YES :** Go to Step 6.

**NO :** The procedure is complete.

**STEP 6. Replace the ignition key and recheck the diagnostic trouble code.**

Replace the ignition key by which the DTC is set with a new one, register the key ID of the new key, (refer to [P.42C-10](#)), and recheck if the DTC is set.

- (1) Turn the ignition switch from the "LOCK" (OFF) position to the "ON" position.
- (2) Check if the DTC is set.

**Q: Is the DTC set?**

**YES** : Replace WCM and register the ID codes (Refer to [P.42C-10](#)).

**NO** : The procedure is complete.

DTC B2101: IG SW start POS.circuit low  
DTC B2102: IG SW start POS.circuit high

**CAUTION**

- If DTC B2101 or B2102 is set, be sure to diagnose the CAN bus line.
- Before replacing the ECU, ensure that the communication circuit is normal.

WCM Communication Circuit

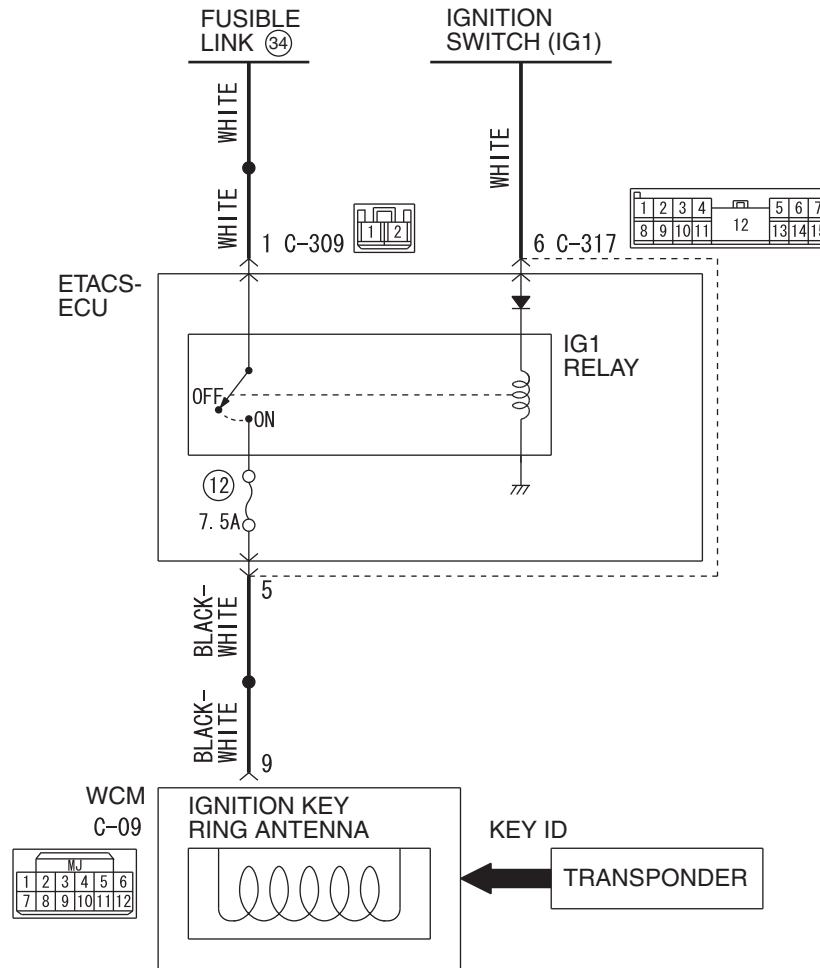

W8G54M054A

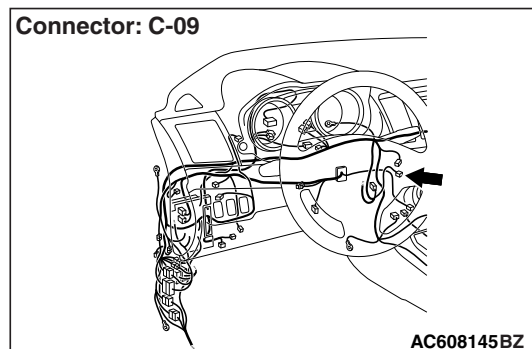
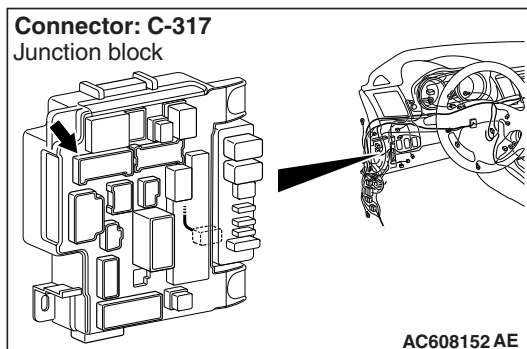

**DTC SET CONDITION**

WCM sets DTC B2101 or B2102 when the actual state of the ignition switch and the ignition switch position information received from ETACS-ECU via CAN do not match.

**TECHNICAL DESCRIPTION (COMMENT)**

WCM determines that the abnormality is present, if it has detected discrepancy in the ignition switch level shown below ten consecutive times when WCM has received the CAN message (ignition switch position information) from ETACS-ECU with the ignition switch turned to the ON or START position.

**B2101**

- Status of ignition switch: OFF position
- Ignition switch position information from the ETACS-ECU: ON

**B2102**

- Status of ignition switch: ON position
- Ignition switch position information from the ETACS-ECU: OFF

**TROUBLESHOOTING HINTS**

- Malfunction of CAN bus line
- Malfunction of the WCM
- Malfunction of the ignition switch
- Damaged wiring harness and connectors
- Malfunction of ETACS-ECU

**DIAGNOSIS****Required Special Tools:**

- MB991958: Scan Tool (M.U.T.-III Sub Assembly)
  - MB991824: Vehicle Communication Interface (V.C.I.)
  - MB991827: M.U.T.-III USB Cable
  - MB991910: M.U.T.-III Main Harness A (Vehicles with CAN communication system)

**STEP 1. Using scan tool MB991958, diagnose the CAN bus line.****⚠ CAUTION**

To prevent damage to scan tool (MB991958), always turn the ignition switch to the "LOCK" (OFF) position before connecting or disconnecting scan tool (MB991958).

- (1) Connect scan tool MB991958 to the data link connector.
- (2) Turn the ignition switch to the "ON" position.
- (3) Diagnose the CAN bus line.
- (4) Turn the ignition switch to the "LOCK" (OFF) position.

**Q: Is the CAN bus line found to be normal?**

**YES** : Go to Step 2.

**NO** : Repair the CAN bus line. (Refer to GROUP 54C, Diagnosis [P.54C-16](#)).

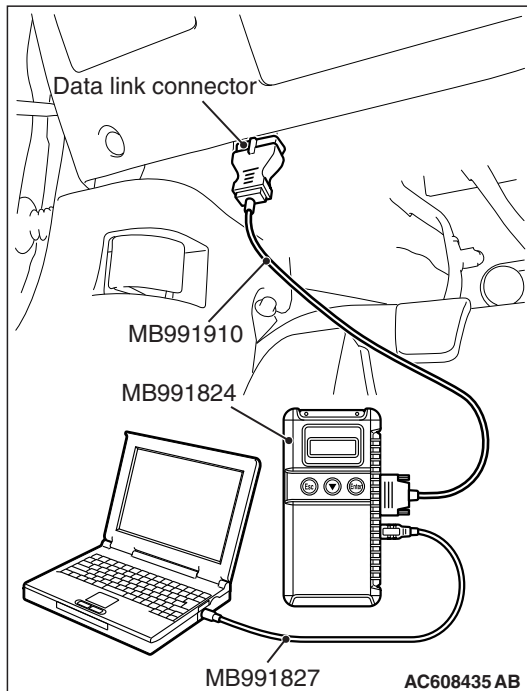

---

**STEP 2. Check ETACS-ECU connector C-317 and WCM connector C-09 for loose, corroded or damaged terminals, or terminals pushed back in the connector.**

**Q: Is ETACS-ECU connector C-317 and WCM connector C-09 in good condition?**

**YES :** Go to Step 3.

**NO :** Repair the defective connector.

---

**STEP 3. Check the wiring harness between WCM connector C-09 (terminal No.9) and ETACS-ECU connector C-317 (terminal No.5).**

- Check the power supply line for open circuit.

**Q: Is the wiring harness between WCM connector C-09 (terminal No. 9) and ETACS-ECU connector C-317 (terminal No. 5) in good condition?**

**YES :** Go to Step 4.

**NO :** The wiring harness may be damaged or the connector(s) may have loose, corroded or damaged terminals, or terminals pushed back in the connector.

---

**STEP 4. Using scan tool MB991958, check data list.**

Use the ETACS-ECU data list to check the signals related to the ignition voltage.

Turn the ignition switch from "LOCK" (OFF) position to "ON" position.

Item No.	Item name	Normal conditions
Item 254	IG voltage	Battery positive voltage

**Q: Does scan tool MB991958 display the item "IG voltage" as normal condition?**

**YES :** Go to Step 5.

**NO :** Diagnose the ETACS-ECU. Refer to GROUP 54A, Diagnosis [P.54A-674](#).

**STEP 5. Recheck for diagnostic trouble code.**

Check again if the DTC is set to the WCM.

- (1) Erase the DTC.
- (2) Turn the ignition switch from "LOCK" (OFF) position to "ON" position.
- (3) Check if DTC is set.
- (4) Turn the ignition switch to the "LOCK" (OFF) position.

**Q: Is the DTC set?**

**YES** : Replace WCM and register the ID codes. (Refer to [P.42C-10.](#))

**NO** : The trouble can be an intermittent malfunction (Refer to GROUP 00 –How to use Troubleshooting/inspection Service Points –How to Cope with Intermittent Malfunction [P.00-13](#)).

**DTC B2204: Coding data mismatch****⚠ CAUTION**

- When DTC B2204 is set, be sure to diagnose the CAN bus line.
- When replacing the ECU, always check that the communication circuit is normal.

**DTC SET CONDITION**

If the vehicle information data transmitted from the ETACS-ECU via the CAN bus lines is different from that registered in the WCM, the WCM sets the DTC No. B2204.

**TECHNICAL DESCRIPTION (COMMENT)**

WCM determines that the abnormality is present when the vehicle information registered in it does not match the vehicle information data.

**TROUBLESHOOTING HINTS**

- Malfunction of CAN bus line
- Malfunction of WCM
- Malfunction of ETACS-ECU

**DIAGNOSIS****Required Special Tools:**

- MB991958: Scan Tool (M.U.T.-III Sub Assembly)
  - MB991824: Vehicle Communication Interface (V.C.I.)
  - MB991827: M.U.T.-III USB Cable
  - MB991910: M.U.T.-III Main Harness A

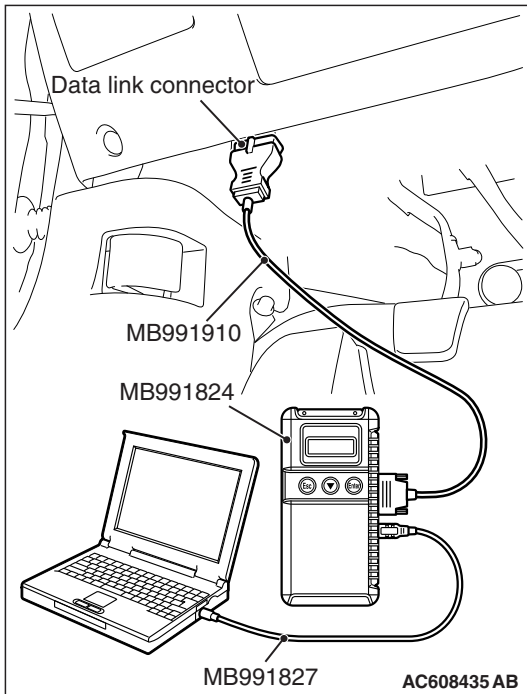

**STEP 1. Using scan tool MB991958, diagnose the CAN bus line.**

**⚠ CAUTION**

To prevent damage to scan tool (MB991958), always turn the ignition switch to the "LOCK" (OFF) position before connecting or disconnecting scan tool (MB991958).

- (1) Connect scan tool MB991958 to the data link connector.
- (2) Turn the ignition switch to the "ON" position.
- (3) Diagnose the CAN bus line.
- (4) Turn the ignition switch to the "LOCK" (OFF) position.

**Q: Is the CAN bus line found to be normal?**

**YES :** Go to Step 2.

**NO :** Repair the CAN bus line. (Refer to GROUP 54C, Diagnosis [P.54C-16](#)).

**STEP 2. Using scan tool MB991958, read the ETACS-ECU diagnostic trouble code**

Check if a coding-related DTC is set in the ETACS-ECU.

**Q: Is the DTC set?**

**YES :** Troubleshoot the ETACS (Refer to GROUP 54A, Diagnosis [P.54A-674](#)). Then go to Step 3.

**NO :** Go to Step 3.

**STEP 3. Recheck for diagnostic trouble code.**

Check again if the DTC is set to the WCM.

- (1) Erase the DTC.
- (2) Turn the ignition switch from "LOCK" (OFF) position to "ON" position.
- (3) Check if DTC is set.
- (4) Turn the ignition switch to the "LOCK" (OFF) position.

**Q: Is the DTC set?**

**YES :** Replace WCM and register the ID codes. (Refer to [P.42C-10](#).)

**NO :** The trouble can be an intermittent malfunction (Refer to GROUP 00 –How to use Troubleshooting/inspection Service Points –How to Cope with Intermittent Malfunction [P.00-13](#)).

**DTC B2206: VIN code mismatch****DTC SET CONDITION**

WCM sets DTC B2206 when chassis number registered in it and the VIN that has been transmitted on the CAN bus do not match.

**TECHNICAL DESCRIPTION (COMMENT)**

WCM determines that the abnormality is present when VIN registered in it and the one that has been transmitted on the CAN bus do not match.

**TROUBLESHOOTING HINTS**

- Malfunction of WCM
- VIN registered in engine ECU unmatched
- WCM being registered to another vehicle

**DIAGNOSIS****Required Special Tools:**

- MB991958: Scan Tool (M.U.T.-III Sub Assembly)
  - MB991824: Vehicle Communication Interface (V.C.I.)
  - MB991827: M.U.T.-III USB Cable
  - MB991910: M.U.T.-III Main Harness A (Vehicles with CAN communication system)

**STEP 1. Check the VIN registered in the engine control module and the VIN of the vehicle.**

Check if the VIN registered in the engine control module matches with the VIN of the vehicle.

**⚠ CAUTION**

To prevent damage to scan tool (MB991958), always turn the ignition switch to the "LOCK" (OFF) position before connecting or disconnecting scan tool (MB991958).

- (1) Connect scan tool MB991958 to the data link connector.
- (2) On the system selection screen of the scan tool, select "MFI/GDI/Diesel".
- (3) Select "Coding."
- (4) Select "VIN Information."
- (5) Compare with the VIN of the vehicle.

**Q: Does the VIN of the engine control module match with the VIN of the vehicle?**

**YES** : Go to Step 2.

**NO** : Write the VIN to the engine control module. [Refer to GROUP 00 –How to Perform Vehicle Identification Number (VIN) Writing P.00-24]. Record VIN and go to Step 2.

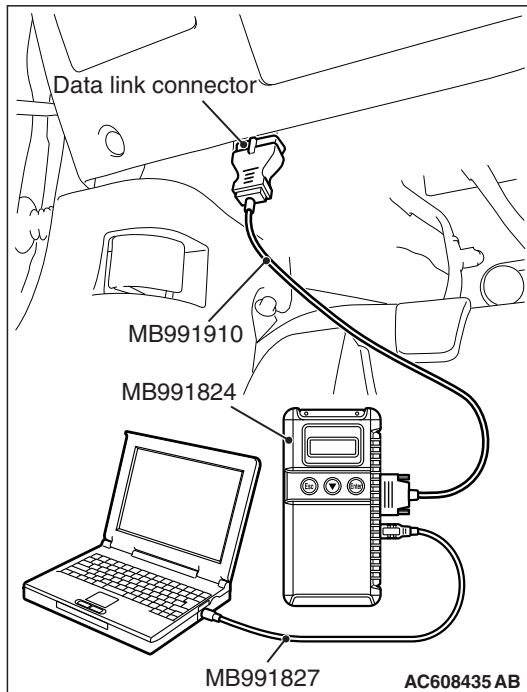



---

**STEP 2. Recheck for diagnostic trouble code.**

Check again if the DTC is set to the WCM.

- (1) Turn the ignition switch to the "ON" position.
- (2) Check if the DTC is set.

**Q: Is the DTC set?**

**YES** : Replace WCM and register the ID codes (Refer to [P.42C-10](#)). After registering the ID codes, go to Step 3.

**NO** : The procedure is complete.

---

**STEP 3. Recheck for diagnostic trouble code.**

Check again if the DTC is set to the WCM.

- (1) Turn the ignition switch to the "ON" position.
- (2) Check if the DTC is set.

**Q: Is the DTC set?**

**YES** : Replace the engine control module and record the VIN [Refer to GROUP 00 –How To Perform Vehicle Identification Number (VIN) Writing [P.00-24](#)].

**NO** : The procedure is complete.

---

**DTC B2352: Antenna fail**

**DTC SET CONDITION**

WCM sets the DTC B2352 when open or short circuit to the ground in the antenna is detected.

**TECHNICAL DESCRIPTION (COMMENT)**

When the ignition switch is turned ON, WCM transmits signal to the antenna. When the antenna is found faulty, WCM determines that the abnormality is present.

**TROUBLESHOOTING HINT**

Malfunction of WCM (Open circuit in antenna)

**DIAGNOSIS**

**Required Special Tools:**

- MB991958: Scan Tool (M.U.T.-III Sub Assembly)
  - MB991824: Vehicle Communication Interface (V.C.I.)
  - MB991827: M.U.T.-III USB Cable
  - MB991910: M.U.T.-III Main Harness A (Vehicles with CAN communication system)

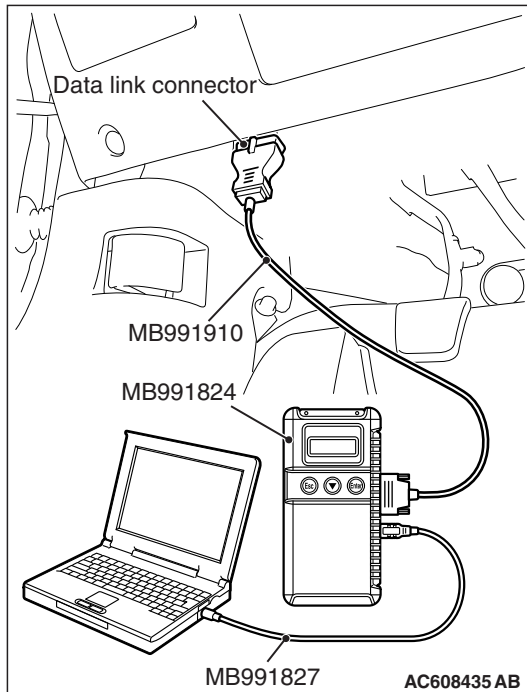
**Recheck for diagnostic trouble code.**

Check again if the DTC is set to the WCM.

**⚠ CAUTION**

To prevent damage to scan tool (MB991958), always turn the ignition switch to the "LOCK" (OFF) position before connecting or disconnecting scan tool (MB991958).

- (1) Connect scan tool MB991958 to the data link connector. Erase the DTC.
- (2) Turn the ignition switch from "LOCK" (OFF) position to "ON" position.
- (3) Check if DTC is set.
- (4) Turn the ignition switch to the "LOCK" (OFF) position.

**Q: Is the DTC set?**

**YES** : Replace WCM and register the ID codes. (Refer to [P.42C-10.](#))

**NO** : The procedure is complete.

**DTC B2401: Keyless/KOS key ID not register****⚠ CAUTION**

- If the DTC B2401 is set, be sure to diagnose the CAN bus line.
- When replacing the ECU, always check that the communication circuit is normal.

**DTC SET CONDITION**

If the keyless ID registered transmitter is not registered to the WCM, the WCM sets the DTC No. B2401.

**TECHNICAL DESCRIPTION (COMMENT)**

If the number of keyless ID registered transmitter is zero, the WCM determines that there is a problem.

**TROUBLESHOOTING HINTS**

- Malfunction of CAN bus line
- Failure of transmitter registration process
- Malfunction of WCM

**DIAGNOSIS****Required Special Tools:**

- MB991958: Scan Tool (M.U.T.-III Sub Assembly)
  - MB991824: Vehicle Communication Interface (V.C.I.)
  - MB991827: M.U.T.-III USB Cable
  - MB991910: M.U.T.-III Main Harness A (Vehicles with CAN communication system)

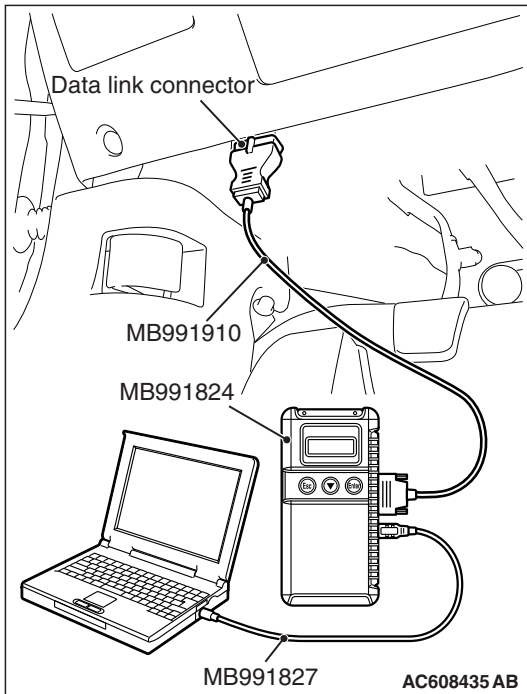

**STEP 1. Using scan tool MB991958, diagnose the CAN bus line.**

**⚠ CAUTION**

To prevent damage to scan tool (MB991958), always turn the ignition switch to the "LOCK" (OFF) position before connecting or disconnecting scan tool (MB991958).

- (1) Connect scan tool MB991958 to the data link connector.
- (2) Turn the ignition switch to the "ON" position.
- (3) Diagnose the CAN bus line.
- (4) Turn the ignition switch to the "LOCK" (OFF) position.

**Q: Is the CAN bus line found to be normal?**

**YES :** Go to Step 2.

**NO :** Repair the CAN bus line (Refer to GROUP 54C, Diagnosis P.54C-16). On completion, go to Step 2.

**STEP 2. Register the transmitter and recheck the diagnostic trouble code.**

Register the keyless ID (Refer to P.42C-10), and recheck if the DTC is set.

- (1) Erase the DTC.
- (2) Turn the ignition switch from the "LOCK" (OFF) position to the "ON" position.
- (3) Check if the DTC is set.

**Q: Is the DTC set?**

**YES :** Replace WCM and register the ID codes. (Refer to P.42C-10.)

**NO :** The procedure is complete.

**DTC B2416: ECU internal error**

**DTC SET CONDITION**

WCM sets DTC B2416 when it determines an abnormal status within itself.

**TECHNICAL DESCRIPTION (COMMENT)**

WCM determines that the abnormality is present, if the data abnormality is found when the ignition switch is turned ON and then EEPROM is written.

**TROUBLESHOOTING HINTS**

Malfunction of WCM

**DIAGNOSIS****Required Special Tools:**

- MB991958: Scan Tool (M.U.T.-III Sub Assembly)
  - MB991824: Vehicle Communication Interface (V.C.I.)
  - MB991827: M.U.T.-III USB Cable
  - MB991910: M.U.T.-III Main Harness A (Vehicles with CAN communication system)

**Recheck for diagnostic trouble code.**

Check again if the DTC is set to the WCM.

**⚠ CAUTION**

To prevent damage to scan tool (MB991958), always turn the ignition switch to the "LOCK" (OFF) position before connecting or disconnecting scan tool (MB991958).

- (1) Connect scan tool MB991958 to the data link connector.
- (2) Erase the DTC.
- (3) Turn the ignition switch from "LOCK" (OFF) position to "ON" position.
- (4) Check if DTC is set.
- (5) Turn the ignition switch to the "LOCK" (OFF) position.

**Q: Is the DTC set?**

**YES** : Replace WCM and register the ID codes. (Refer to [P.42C-10.](#))

**NO** : The trouble can be an intermittent malfunction (Refer to GROUP 00 –How to use Troubleshooting/inspection Service Points –How to Cope with Intermittent Malfunction [P.00-13.](#))

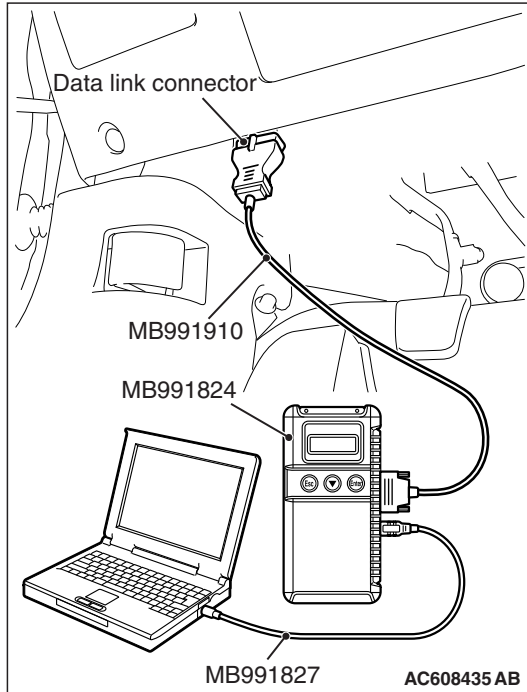
**DTC C1608: EEPROM Error****⚠ CAUTION**

If there is any problem in the CAN bus lines, an incorrect diagnostic trouble code may be set. Prior to this diagnosis, diagnose the CAN bus lines (Refer to GROUP 54C, Trouble code diagnosis [P.54C-14.](#))

**DTC SET CONDITION**

WCM incorporates EEPROM (nonvolatile memory), and that EEPROM stores the TPMS, WCM and immobilizer information. When the data in EEPROM is failed, this code is set.

**TROUBLESHOOTING HINTS**

The most likely causes for this DTC to set are:

- Damaged wiring harness and connector
- Malfunction of WCM

---

## DIAGNOSIS

### Required Special Tools:

- MB991958 Scan Tool (M.U.T.-III Sub Assembly)
  - MB991824: Vehicle Communication Interface (V.C.I.)
  - MB991827 M.U.T.-III USB Cable
  - MB991910 M.U.T.-III Main Harness A

---

### STEP 1. Using scan tool MB991958, diagnose the CAN bus lines.

Use scan tool to diagnose the CAN bus lines.

#### Q: Is the check result normal?

**YES** : Go to Step 2.

**NO** : Repair the CAN bus lines (Refer to GROUP 54C – CAN Bus Diagnostics table [P.54C-9](#)). On completion, go to Step 2.

---

### STEP 2. Diagnostic trouble code check

- (1) Turn the ignition switch to the "LOCK" (OFF) position.
- (2) Turn the ignition switch to the "ON" position.
- (3) Check if the DTC is set.
- (4) Turn the ignition switch to the "LOCK" (OFF) position.

#### Q: Is the DTC C1608 set?

**YES** : Replace the WCM and register the ID codes (Refer to [P.42C-101](#)). Then go to Step 3.

**NO** : The procedure is complete.

---

### STEP 3. Diagnostic trouble code check

- (1) Turn the ignition switch to the "LOCK" (OFF) position.
- (2) Turn the ignition switch to the "ON" position.
- (3) Check if the DTC is set.
- (4) Turn the ignition switch to the "LOCK" (OFF) position.

#### Q: Is the DTC C1608 set?

**YES** : Start over at Step 1.

**NO** : The procedure is complete.

---

## DTC C1900: No Registration

---

### CAUTION

If there is any problem in the CAN bus lines, an incorrect diagnostic trouble code may be set. Prior to this diagnosis, diagnose the CAN bus lines (Refer to GROUP 54C, Trouble code diagnosis [P.54C-14](#)).

### DTC SET CONDITION

When the ID registration information of the TPMS transmitter is not stored in the WCM, and/or when the WCM is replaced with a new one, this code is set. If the ID registration mode is terminated forcibly or time-out after one or more TPMS transmitters are registered in the ID registration mode, the ID information in the WCM is erased, and this diagnostic trouble code is set.

**TROUBLESHOOTING HINTS**

The most likely causes for this DTC to set are:

- Damaged wiring harness and connector
- Malfunction of TPMS transmitter
- Malfunction of WCM
- ID code registration failed.

**DIAGNOSIS****Required Special Tools:**

- MB991958 Scan Tool (M.U.T.-III Sub Assembly)
  - MB991824: Vehicle Communication Interface (V.C.I.)
  - MB991827 M.U.T.-III USB Cable
  - MB991910 M.U.T.-III Main Harness A

---

**STEP 1. Using scan tool MB991958, diagnose the CAN bus lines.**

Use scan tool to diagnose the CAN bus lines.

**Q: Is the check result normal?**

**YES** : Go to Step 2.

**NO** : Repair the CAN bus lines (Refer to GROUP 54C – CAN Bus Diagnostics table [P.54C-279](#)). On completion, go to Step 2.

---

**STEP 2. Diagnostic trouble code check**

- (1) Turn the ignition switch to the "LOCK" (OFF) position.
- (2) Turn the ignition switch to the "ON" position.
- (3) Check if the DTC is set.
- (4) Turn the ignition switch to the "LOCK" (OFF) position.

**Q: Is the DTC C1900 set?**

**YES** : Register the ID codes (Refer to [P.42C-101](#)). Then go to Step 3.

**NO** : The procedure is complete.

---

**STEP 3. Recheck for diagnostic trouble code.**

Check again if the DTC is set.

- (1) Turn the ignition switch to the "LOCK" (OFF) position.
- (2) Turn the ignition switch to the "ON" position.
- (3) Check if the DTC is set.
- (4) Turn the ignition switch to the "LOCK" (OFF) position.

**Q: Is the DTC C1900 reset?**

**YES** : Replace the WCM and register the ID codes (Refer to [P.42C-101](#)). Then start over at Step 1.

**NO** : The procedure is complete.

---

DTC C1901: Vehicle speed information abnormality

---

 **CAUTION**

If there is any problem in the CAN bus lines, an incorrect diagnostic trouble code may be set. Prior to this diagnosis, diagnose the CAN bus lines (Refer to GROUP 54C, Trouble code diagnosis P.54C-14).

**DTC SET CONDITION**

WCM receives the wheel speed information from ASC-ECU via the CAN-bus line. Although WCM receives the information that the wheel is not currently rotated from ASC-ECU, if the TPMS transmitter sends the information that the wheel is rotated, this code is set.

**TROUBLESHOOTING HINTS**

The most likely causes for this DTC to set are:

- Damaged wiring harness and connector
- Malfunction of TPMS transmitter
- Malfunction of WCM
- Malfunction of ASC-ECU
- Malfunction of ETACS-ECU

**DIAGNOSIS**

**Required Special Tools:**

- MB991958: Scan Tool (M.U.T.-III Sub Assembly)
  - MB991824: Vehicle Communication Interface (V.C.I.)
  - MB991827: M.U.T.-III USB Cable
  - MB991910: M.U.T.-III Main Harness A

---

**STEP 1. Using scan tool MB991958, diagnose the CAN bus lines.**

Use scan tool to diagnose the CAN bus lines.

**Q: Is the check result normal?**

**YES** : Go to Step 3.

**NO** : Repair the CAN bus lines (Refer to GROUP 54C – CAN Bus Diagnostics Table P.54C-14). On completion, go to Step 2.

---

**STEP 2. Diagnostic trouble code recheck after resetting CAN bus lines**

- (1) Turn the ignition switch to the "LOCK" (OFF) position.
- (2) Turn the ignition switch to the "ON" position.
- (3) Check if the DTC is set.
- (4) Turn the ignition switch to the "LOCK" (OFF) position.

**Q: Is the DTC C1901 set?**

**YES** : Go to Step 3.

**NO** : The procedure is complete.

**STEP 3. Check for other diagnostic trouble code.**

Check if the diagnostic trouble code is set from ASC-ECU (Refer to GROUP 35C, Diagnostic Trouble Code Chart [P.35C-27](#)).

**Q: Is the check result normal?**

**YES** : Go to Step 4.

**NO** : Carry out the troubleshooting for ASC-ECU (Refer to GROUP 35C, Diagnostic Trouble Code Chart [P.35C-27](#)). Then go to Step 6.

---

**STEP 4. Check for other diagnostic trouble code.**

Check if the diagnostic trouble code is set from ETACS-ECU (Refer to GROUP 54A, ETACS –Diagnostic Trouble Code Chart [P.54A-674](#)).

**Q: Is the check result normal?**

**YES** : Go to Step 5.

**NO** : Troubleshoot the set DTC (Refer to GROUP 54A, ETACS –Diagnostic Trouble Code Chart [P.54A-674](#)). Then go to Step 6.

---

**STEP 5. Check the TPMS transmitter acceleration.**

Check the acceleration value of each TPMS transmitter by the air pressure of data list (Refer to [P.42C-82](#)).

**OK:**

**Acceleration value: 5G or less**

**Q: Is the check result OK?**

**YES** : Replace the WCM and register ID codes (Refer to [P.42C-10](#)). Then go to Step 6.

**NO** : Replace the TPMS transmitter and register ID codes (Refer to [P.42C-10](#)). Then go to Step 6.

---

**STEP 6. Recheck for diagnostic trouble code.**

(1) Turn the ignition switch to the "LOCK" (OFF) position.

(2) Turn the ignition switch to the "ON" position.

(3) Check if the DTC is set.

(4) Turn the ignition switch to the "LOCK" (OFF) position.

**Q: Is the DTC C1901 set?**

**YES** : Start over at Step 1.

**NO** : The procedure is complete.



DTC C1910: Transmitter low battery voltage abnormality 1  
DTC C1920: Transmitter low battery voltage abnormality 2  
DTC C1930: Transmitter low battery voltage abnormality 3  
DTC C1940: Transmitter low battery voltage abnormality 4  
DTC C1911: Reception abnormality 1  
DTC C1921: Reception abnormality 2  
DTC C1931: Reception abnormality 3  
DTC C1941: Reception abnormality 4

**⚠ CAUTION**

If there is any problem in the CAN bus lines, an incorrect diagnostic trouble code may be set. Prior to this diagnosis, diagnose the CAN bus lines (Refer to GROUP 54C, Trouble code diagnosis [P.54C-16](#)).

**DTC SET CONDITION**

**DTC C1910, C1920, C1930, C1940**

- When the reception abnormality warning is activated because of the low battery voltage of the TPMS transmitter.

**DTC C1911, C1921, C1931, C1941**

- When WCM cannot receive the signals from the TPMS transmitters while driving for about 20 minutes, this code is set.

**TROUBLESHOOTING HINTS**

The most likely causes for this DTC to set are:

- Low battery that is incorporated into the TPMS transmitter
- Damaged wiring harness and connector
- Registered IDs unmatched
- Malfunction of TPMS transmitter
- Malfunction of WCM

**DIAGNOSIS**

**Required Special Tools:**

- MB991958: Scan Tool (M.U.T.-III Sub Assembly)
  - MB991824: Vehicle Communication Interface (V.C.I.)
  - MB991827: M.U.T.-III USB Cable
  - MB991910: M.U.T.-III Main Harness A

**STEP 1. Using scan tool MB991958, diagnose the CAN bus lines.**

Use scan tool to diagnose the CAN bus lines.

**Q: Is the check result normal?**

**YES** : Go to Step 3.

**NO** : Repair the CAN bus lines (Refer to GROUP 54C – CAN Bus Diagnostics table [P.54C-16](#)). On completion, go to Step 2.

**STEP 2. Diagnostic trouble code recheck after resetting CAN bus lines**

**Q: Is the DTC C1910, C1920, C1930, C1940, C1911, C1921, C1931 or C1941 set?**

**YES :** Go to Step 3.

**NO :** The procedure is complete.

**STEP 3. Check for TPMS transmitter.**

Identify the TPMS transmitter which the DTC is set by TPMS transmitter check (Refer to [P.42C-101](#)).

*NOTE: The TPMS transmitter which cannot be checked may be faulty or the ID code may not be registered, thus do not replace it, but register the ID code. If the transmitter is faulty, it is replaced in the ID code registration process.*

**Q: Are there any TPMS transmitters which are identified?**

**YES :** Among the checked TPMS transmitters, replace the TPMS transmitters to which the DTC is set. Then register the ID codes (Refer to [P.42C-10](#)). Then go to Step 4.

**NO :** Even when no transmitter is checked, register the ID codes (Refer to [P.42C-101](#)). Then go to Step 4.

**STEP 4. Diagnostic trouble code recheck after register the ID codes**

- (1) Turn the ignition switch to the "LOCK" (OFF) position.
- (2) Turn the ignition switch to the "ON" position.
- (3) Check if the DTC is set.
- (4) Turn the ignition switch to the "LOCK" (OFF) position.

**Q: Is the DTC C1910, C1920, C1930, C1940, C1911, C1921, C1931 or C1941 set?**

**YES :** Replace the WCM and register the ID codes (Refer to [P.42C-10](#)). Then start over at Step 1.

**NO :** The procedure is complete.

**DTC C1912: Tire inflation pressure warning 1**

**DTC C1922: Tire inflation pressure warning 2**

**DTC C1932: Tire inflation pressure warning 3**

**DTC C1942: Tire inflation pressure warning 4**

**⚠ CAUTION**

If there is any problem in the CAN bus lines, an incorrect diagnostic trouble code may be set. Prior to this diagnosis, diagnose the CAN bus lines (Refer to **GROUP 54C, Trouble code diagnosis [P.54C-14](#)**).

**DTC SET CONDITION**

When the tire pressure included in the signal from the TPMS transmitter is less than the specified value, WCM sets this code.

---

## TROUBLESHOOTING HINTS

The most likely causes for this DTC to set is:

- Drop of tire pressure
- Loose TPMS transmitter mounting nut
- Flat tire
- TPMS transmitter malfunction
- WCM malfunction
- CAN-bus line malfunction

## DIAGNOSIS

### Required Special Tools:

- MB991958: Scan Tool (M.U.T.-III Sub Assembly)
  - MB991824: Vehicle Communication Interface (V.C.I.)
  - MB991827: M.U.T.-III USB Cable
  - MB991910: M.U.T.-III Main Harness A

---

### STEP 1. Using scan tool MB991958, diagnose the CAN bus lines.

Use scan tool to diagnose the CAN bus lines.

#### Q: Is the check result normal?

**YES** : Go to Step 3.

**NO** : Repair the CAN bus lines (Refer to GROUP 54C – CAN Bus Diagnostics table [P.54C-14](#)). On completion, go to Step 2.

---

### STEP 2. Diagnostic trouble code recheck after resetting CAN bus lines

#### Q: Is DTC C1912, C1922, C1932 or C1942 set?

**YES** : Go to Step 3.

**NO** : The procedure is complete.

---

### STEP 3. Tire check

Check that there is no abnormality for the items below.

- Flat tire
- Cracked tire
- Air leak from valve
- Loose TPMS transmitter mounting nut (Refer to [P.42C-120](#)).

#### Q: Is the check result normal?

**YES** : Go to Step 4.

**NO** : Repair or replace it. Then go to Step 4.

---

### STEP 4. Diagnostic trouble code check

(1) Turn the ignition switch to the "ON" position, and adjust the pressure to the recommended tire pressure.

(2) Check if the DTC is set.

#### Q: Is DTC C1912, C1922, C1932 or C1942 set?

**YES** : Go to Step 5.

**NO** : The procedure is complete.

**STEP 5. Diagnostic trouble code check**

(1) Drive the vehicle for five minutes.

*NOTE: Even within 5 minutes, if the TPMS warning light goes out, finish the driving and perform the operation (2).*

(2) Check if the DTC is set.

**Q: Is DTC C1912, C1922, C1932 or C1942 set?**

**YES** : Go to Step 6.

**NO** : The procedure is complete.

---

**STEP 6. Tire pressure check by scan tool**

(1) Perform the transmitter check using the scan tool (Refer to [P.42C-101](#)), and check the tire pressure values of all the wheels.

(2) Check the tire pressure of all the wheels using the tire pressure gauge.

(3) Compare the measured value (1) with (2).

**OK: 20 kPa (2.9 psi) or less**

*NOTE: Do not replace the TPMS transmitter which cannot be checked.*

**Q: Is the check result OK?**

**YES** : Replace the WCM and register the ID codes (Refer to [P.42C-10](#)). Then go to Step 9.

**NO** : Go to Step 7.

---

**STEP 7. Tire pressure check by scan tool**

(1) Perform the transmitter check using the scan tool (Refer to [P.42C-101](#)), and check the tire pressure values of all the wheels.

(2) Check the tire pressure of all the wheels using the tire pressure gauge.

(3) Compare the measured value (1) with (2).

**OK: 20 kPa (2.9 psi) or less**

**Q: Is the check result OK?**

**YES** : Replace the WCM and register the ID codes (Refer to [P.42C-10](#)). Then go to Step 9.

**NO** : Replace the TPMS transmitter and register the ID codes (Refer to [P.42C-10](#)). Then go to Step 8.

---

**STEP 8. Recheck for diagnostic trouble code.**

(1) Turn the ignition switch to the "LOCK" (OFF) position.

(2) Turn the ignition switch to the "ON" position.

(3) Check if the DTC is set.

(4) Turn the ignition switch to the "LOCK" (OFF) position.

**Q: Is the DTC C1912, C1922, C1932 or C1942 set?**

**YES** : Replace the WCM and register the ID codes (Refer to [P.42C-10](#)). Then go to Step 9.

**NO** : The procedure is complete.

---

**STEP 9. Recheck for diagnostic trouble code.**

- (1) Turn the ignition switch to the "LOCK" (OFF) position.
- (2) Turn the ignition switch to the "ON" position.
- (3) Check if the DTC is set.
- (4) Turn the ignition switch to the "LOCK" (OFF) position.

**Q: Is the DTC C1912, C1922, C1932 or C1942 set?**

**YES :** Start over at Step 1.

**NO :** The procedure is complete.

---

**DTC C1913: Acceleration sensor abnormality 1**

**DTC C1923: Acceleration sensor abnormality 2**

**DTC C1933: Acceleration sensor abnormality 3**

**DTC C1943: Acceleration sensor abnormality 4**

**DTC C1914: Pressure sensor abnormality 1**

**DTC C1924: Pressure sensor abnormality 2**

**DTC C1934: Pressure sensor abnormality 3**

**DTC C1944: Pressure sensor abnormality 4**

---

 **CAUTION**

If there is any problem in the CAN bus lines, an incorrect diagnostic trouble code may be set. Prior to this diagnosis, diagnose the CAN bus lines (Refer to GROUP 54C, Trouble code diagnosis [P.54C-16](#)).

**DTC SET CONDITION**

**DTC C1913, C1923, C1933, C1943**

- The TPMS transmitter detects if the wheel is rotated by the acceleration sensor and sends the signals to WCM. When the TPMS transmitter judges that the acceleration sensor is failed, the failure signal is send to WCM, and WCM sets this code.

**DTC C1914, C1924, C1934, C1944**

- The TPMS transmitter detects if the tire pressure sensor is normal and sends the signal to WCM. When the TPMS transmitter judges that the tire pressure sensor is failed, the failure signal is send to WCM, and WCM sets this code.

**TROUBLESHOOTING HINTS**

The most likely causes for this DTC to set are:

- Low battery that is incorporated into the TPMS transmitter
- Damaged wiring harness and connector
- Registered IDs unmatched
- Malfunction of TPMS transmitter
- Malfunction of WCM

**DIAGNOSIS****Required Special Tools:**

- MB991958: Scan Tool (M.U.T.-III Sub Assembly)
  - MB991824: Vehicle Communication Interface (V.C.I.)
  - MB991827: M.U.T.-III USB Cable
  - MB991910: M.U.T.-III Main Harness A

---

**STEP 1. Using scan tool MB991958, diagnose the CAN bus lines.**

Use scan tool to diagnose the CAN bus lines.

**Q: Is the check result normal?**

**YES** : Go to Step 3.

**NO** : Repair the CAN bus lines (Refer to GROUP 54C – CAN Bus Diagnostics table [P.54C-16](#)). On completion, go to Step 2.

---

**STEP 2. Diagnostic trouble code recheck after resetting CAN bus lines****Q: Is the DTC C1913, C1923, C1933, C1943, C1914, C1924, C1934 or C1944 set?**

**YES** : Go to Step 3.

**NO** : The procedure is complete.

---

**STEP 3. Check for TPMS transmitter.**

Identify the TPMS transmitter which the DTC is set by TPMS transmitter check (Refer to [P.42C-101](#)).

*NOTE: The TPMS transmitter which cannot be checked may be faulty or the ID code may not be registered, thus do not replace it, but register the ID code. If the transmitter is faulty, it is replaced in the ID code registration process.*

**Q: Are there any TPMS transmitters which are identified?**

**YES** : Among the checked TPMS transmitters, replace the TPMS transmitters to which the DTC is set. Then register the ID codes (Refer to [P.42C-10](#)). Then go to Step 4.

**NO** : Even when no transmitter is checked, register the ID codes (Refer to [P.42C-101](#)). Then go to Step 4.

---

**STEP 4. Diagnostic trouble code recheck after register the ID codes**

- (1) Turn the ignition switch to the "LOCK" (OFF) position.
- (2) Turn the ignition switch to the "ON" position.
- (3) Check if the DTC is set.
- (4) Turn the ignition switch to the "LOCK" (OFF) position.

**Q: Is the DTC C1913, C1923, C1933, C1943, C1914, C1924, C1934 or C1944 set?**

**YES** : Replace the WCM and register the ID codes (Refer to [P.42C-10](#)). Then start over at Step 1.

**NO** : The procedure is complete.

---

DTC C1915: Transmitter OFF mode 1  
DTC C1925: Transmitter OFF mode 2  
DTC C1935: Transmitter OFF mode 3  
DTC C1945: Transmitter OFF mode 4

---

**⚠ CAUTION**

If there is any problem in the CAN bus lines, an incorrect diagnostic trouble code may be set. Prior to this diagnosis, diagnose the CAN bus lines (Refer to GROUP 54C, Trouble code diagnosis P.54C-14).

**DTC SET CONDITION**

When the TPMS transmitter(s) is in the OFF MODE, this code is set.

**TROUBLESHOOTING HINTS**

The most likely causes for this DTC to set are:

- OFF mode cancellation not performed
- Damaged wiring harness and connector
- Malfunction of TPMS transmitter
- Malfunction of WCM

**DIAGNOSIS**

**Required Special Tools:**

- MB991958: Scan Tool (M.U.T.-III Sub Assembly)
  - MB991824: Vehicle Communication Interface (V.C.I.)
  - MB991827: M.U.T.-III USB Cable
  - MB991910: M.U.T.-III Main Harness A

---

**STEP 1. Using scan tool MB991958, diagnose the CAN bus lines.**

Use scan tool to diagnose the CAN bus lines.

**Q: Is the check result normal?**

**YES** : Go to Step 3.

**NO** : Repair the CAN bus lines (Refer to GROUP 54C – CAN Bus Diagnostics table P.54C-14). On completion, go to Step 2.

---

**STEP 2. Diagnostic trouble code recheck after resetting CAN bus lines**

- (1) Turn the ignition switch to the "LOCK" (OFF) position.
- (2) Turn the ignition switch to the "ON" position.
- (3) Check if the DTC is set.
- (4) Turn the ignition switch to the "LOCK" (OFF) position.

**Q: Is DTC C1915, C1925, C1935 or C1945 set?**

**YES** : Go to Step 3.

**NO** : The procedure is complete.

**STEP 3. Diagnostic trouble code check**

- (1) Drive the vehicle for five minutes.
- (2) Turn the ignition switch to the "LOCK" (OFF) position.
- (3) Turn the ignition switch to the "ON" position.
- (4) Check if the DTC is set.
- (5) Turn the ignition switch to the "LOCK" (OFF) position.

**Q: Are the all DTC C1915, C1925, C1935 and C1945 set?**

**YES** : Replace the TPMS transmitters of all the four wheels, and register ID codes (Refer to [P.42C-10](#)). Then go to Step 4.

**NO** : Register the ID codes (Refer to [P.42C-101](#)). Then go to Step 4.

**STEP 4. Diagnostic trouble code recheck after register the ID codes**

- (1) Turn the ignition switch to the "ON" position.
- (2) Check if the DTC is set.
- (3) Turn the ignition switch to the "LOCK" (OFF) position.

**Q: Is DTC C1915, C1925, C1935 or C1945 set?**

**YES** : Replace the WCM and register the ID codes (Refer to [P.42C-10](#)). Then start over at Step 1.

**NO** : The procedure is complete.

**DTC U0019: Bus off(CAN-B)****CAUTION**

- If DTC U0019 is set, be sure to diagnose the CAN bus line.
- When replacing the ECU, always check that the communication circuit is normal.

**DTC SET CONDITION**

If the CAN-B circuit malfunctions, the WCM sets DTC U0019.

**TECHNICAL DESCRIPTION(COMMENT)**

If WCM cannot perform the data transmission in normal conditions due to a malfunction of the CAN-B bus circuit, WCM determines that there is a problem.

**TROUBLESHOOTING HINT**

- Malfunction of CAN bus line
- Malfunction of the WCM
- Malfunction of wiring harness or connector

**DIAGNOSIS****Required Special Tools:**

- MB991958: Scan Tool (M.U.T.-III Sub Assembly)
  - MB991824: Vehicle Communication Interface (V.C.I.)
  - MB991827: M.U.T.-III USB Cable
  - MB991910: M.U.T.-III Main Harness A (Vehicles with CAN communication system)



**STEP 1. Using scan tool MB991958, diagnose the CAN bus line**

**⚠ CAUTION**

To prevent damage to scan tool MB991958, always turn the ignition switch to the "LOCK" (OFF) position before connecting or disconnecting scan tool MB991958.

- (1) Connect scan tool MB991958. Refer to "How to connect the Scan Tool (M.U.T.-III) P.42B-9."
- (2) Turn the ignition switch to the "ON" position.
- (3) Diagnose the CAN bus line.
- (4) Turn the ignition switch to the "LOCK" (OFF) position.

**Q: Is the CAN bus line found to be normal?**

**YES** : Go to Step 2.

**NO** : Repair the CAN bus line. (Refer to GROUP 54C, Diagnosis P.54C-16).

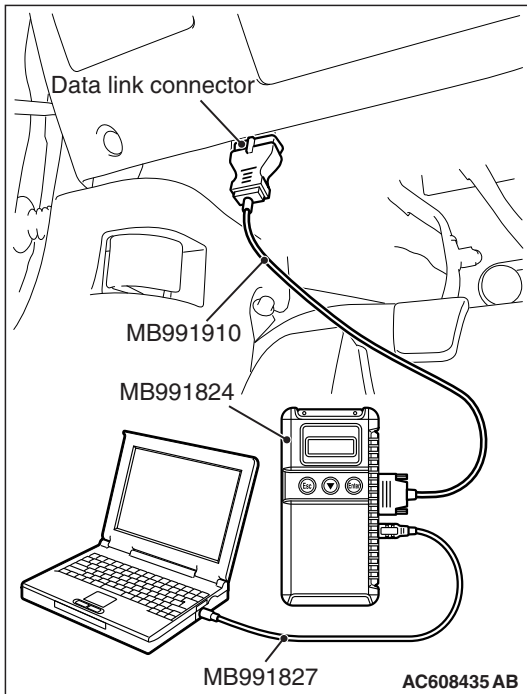

**STEP 2. Recheck for diagnostic trouble code.**

Check again if the DTC is set to the WCM.

- (1) Erase the DTC.
- (2) Turn the ignition switch from "LOCK" (OFF) position to "ON" position.
- (3) Check if DTC is set.
- (4) Turn the ignition switch to the "LOCK" (OFF) position.

**Q: Is the DTC set?**

**YES** : Replace WCM and register the ID codes. (Refer to P.42C-10.)

**NO** : The trouble can be an intermittent malfunction (Refer to GROUP 00 –How to use Troubleshooting/inspection Service Points –How to Cope with Intermittent Malfunction P.00-13).

**DTC U0141: ETACS-ECU CAN timeout****CAUTION**

- If the DTC U0141 is set, be sure to diagnose the CAN bus line.
- When replacing the ECU, always check that the communication circuit is normal.

**DIAGNOSTIC FUNCTION**

If the signal from ETACS-ECU cannot be received, the WCM sets DTC U0141.

**TROUBLESHOOTING HINTS**

- Malfunction of CAN bus line
- Malfunction of WCM
- Malfunction of ETACS-ECU

**DIAGNOSIS****Required Special Tools:**

- MB991958: Scan Tool (M.U.T.-III Sub Assembly)
  - MB991824: Vehicle Communication Interface (V.C.I.)
  - MB991827: M.U.T.-III USB Cable
  - MB991910: M.U.T.-III Main Harness A (Vehicles with CAN communication system)

**STEP 1. Using scan tool MB991958, diagnose the CAN bus line.****CAUTION**

To prevent damage to scan tool MB991958, always turn the ignition switch to the "LOCK" (OFF) position before connecting or disconnecting scan tool MB991958.

- (1) Connect scan tool MB991958. Refer to "How to connect the Scan Tool (M.U.T.-III) P.42C-7."
- (2) Turn the ignition switch to the "ON" position.
- (3) Diagnose the CAN bus line.
- (4) Turn the ignition switch to the "LOCK" (OFF) position.

**Q: Is the CAN bus line found to be normal?**

**YES** : Go to Step 2.

**NO** : Repair the CAN bus line. (Refer to GROUP 54C, Diagnosis P.54C-16).

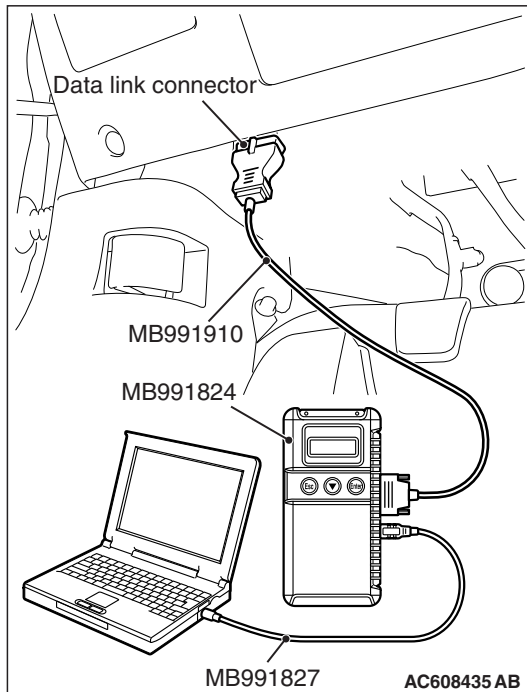
**STEP 2. Using scan tool MB991958, read the ETACS-ECU diagnostic trouble code.**

Check again if the DTC is set to the ETACS-ECU.

**Q: Is the DTC set?**

**YES** : Diagnose the ETACS-ECU (Refer to GROUP 54A P.54A-674 ).

**NO** : Go to Step 3.

---

**STEP 3. Using scan tool MB991958, read the other system diagnostic trouble code.**

Check if DTC U0141 is set to the combination meter.

**Q: Is the DTC set?**

**YES** : Go to Step 4.

**NO** : Go to Step 5.

---

**STEP 4. Recheck for diagnostic trouble code.**

Check again if the DTC is set to the WCM.

(1) Erase the DTC.

(2) Turn the ignition switch from "LOCK" (OFF) position to "ON" position.

(3) Check if DTC is set.

(4) Turn the ignition switch to the "LOCK" (OFF) position.

**Q: Is the DTC set?**

**YES** : Replace the ETACS-ECU.

**NO** : The trouble can be an intermittent malfunction (Refer to GROUP 00 –How to use Troubleshooting/inspection Service Points –How to Cope with Intermittent Malfunction [P.00-13](#)).

---

**STEP 5. Recheck for diagnostic trouble code.**

Check again if the DTC is set to the WCM.

(1) Erase the DTC.

(2) Turn the ignition switch from "LOCK" (OFF) position to "ON" position.

(3) Check if DTC is set.

(4) Turn the ignition switch to the "LOCK" (OFF) position.

**Q: Is the DTC set?**

**YES** : Replace WCM and register the ID codes. (Refer to [P.42C-10](#).)

**NO** : The trouble can be an intermittent malfunction (Refer to GROUP 00 –How to use Troubleshooting/inspection Service Points –How to Cope with Intermittent Malfunction [P.00-13](#)).

**DTC U0151: SRS-ECU CAN timeout****CAUTION**

- If the DTC U0151 is set, be sure to diagnose the CAN bus line.
- When replacing the ECU, always check that the communication circuit is normal.

**DIAGNOSTIC FUNCTION**

If no signal from SRS-ECU can be received, WCM sets diagnostic trouble code U0151.

**TROUBLESHOOTING HINTS**

- The CAN bus line may be defective
- The SRS-ECU may be defective
- Malfunction of WCM

**DIAGNOSIS****Required Special Tools:**

- MB991958: Scan Tool (M.U.T.-III Sub Assembly)
  - MB991824: Vehicle Communication Interface (V.C.I.)
  - MB991827: M.U.T.-III USB Cable
  - MB991910: M.U.T.-III Main Harness A (Vehicles with CAN communication system)

**STEP 1. Using scan tool MB991958, diagnose the CAN bus line.****CAUTION**

To prevent damage to scan tool MB991958, always turn the ignition switch to the "LOCK" (OFF) position before connecting or disconnecting scan tool MB991958.

- (1) Connect scan tool MB991958. Refer to "How to connect the Scan Tool (M.U.T.-III) P.42C-7."
- (2) Turn the ignition switch to the "ON" position.
- (3) Diagnose the CAN bus line.
- (4) Turn the ignition switch to the "LOCK" (OFF) position.

**Q: Is the CAN bus line found to be normal?**

**YES** : Go to Step 2.

**NO** : Repair the CAN bus line. (Refer to GROUP 54C, Diagnosis P.54C-16).

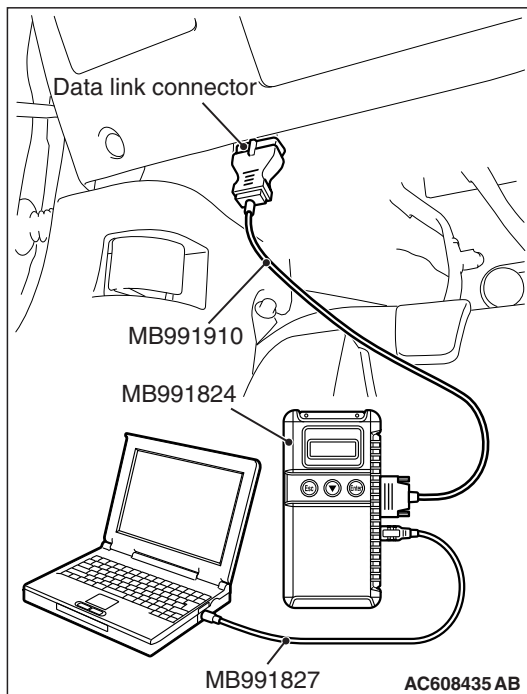
**STEP 2. Using scan tool MB991958, read the SRS-ECU diagnostic trouble code.**

Check again if the DTC is set to the SRS-ECU.

**Q: Is the DTC set?**

**YES** : Troubleshoot the SRS (Refer to GROUP 52B, Troubleshooting P.52B-32).

**NO** : Go to Step 3.

---

**STEP 3. Using scan tool MB991958, read the other system diagnostic trouble code.**

Check if DTC U0151 is set to the combination meter.

**Q: Is the DTC set?**

**YES** : Go to Step 4.

**NO** : Go to Step 5.

---

**STEP 4. Recheck for diagnostic trouble code.**

Check again if the DTC is set to the WCM.

(1) Erase the DTC.

(2) Turn the ignition switch from "LOCK" (OFF) position to "ON" position.

(3) Check if DTC is set.

(4) Turn the ignition switch to the "LOCK" (OFF) position.

**Q: Is the DTC set?**

**YES** : Replace the SRS-ECU.

**NO** : The trouble can be an intermittent malfunction (Refer to GROUP 00 –How to use Troubleshooting/inspection Service Points –How to Cope with Intermittent Malfunction [P.00-13](#)).

---

**STEP 5. Recheck for diagnostic trouble code.**

Check again if the DTC is set to the WCM.

(1) Erase the DTC.

(2) Turn the ignition switch from "LOCK" (OFF) position to "ON" position.

(3) Check if DTC is set.

(4) Turn the ignition switch to the "LOCK" (OFF) position.

**Q: Is the DTC set?**

**YES** : Replace WCM and register the ID codes. (Refer to [P.42C-10](#).)

**NO** : The trouble can be an intermittent malfunction (Refer to GROUP 00 –How to use Troubleshooting/inspection Service Points –How to Cope with Intermittent Malfunction [P.00-13](#)).

**DTC U0154: Occupant classification-ECU CAN timeout****CAUTION**

- If DTC U0154 is set, be sure to diagnose the CAN bus line.
- When replacing the ECU, always check that the communication circuit is normal.

**DIAGNOSTIC FUNCTION**

When the signals from occupant classification-ECU cannot be received, the WCM sets DTC U0154.

**TROUBLESHOOTING HINTS**

- The CAN bus line may be defective.
- The WCM may be defective.
- The occupant classification-ECU may be defective.

**DIAGNOSIS****Required Special Tools:**

- MB991958: Scan Tool (M.U.T.-III Sub Assembly)
  - MB991824: Vehicle Communication Interface (V.C.I.)
  - MB991827: M.U.T.-III USB Cable
  - MB991910: M.U.T.-III Main Harness A (Vehicles with CAN communication system)

**STEP 1. Using scan tool MB991958, diagnose the CAN bus line.****CAUTION**

To prevent damage to scan tool MB991958, always turn the ignition switch to the "LOCK" (OFF) position before connecting or disconnecting scan tool MB991958.

- (1) Connect scan tool MB991958. Refer to "How to connect the Scan Tool (M.U.T.-III) P.42C-7."
- (2) Turn the ignition switch to the "ON" position.
- (3) Diagnose the CAN bus line.
- (4) Turn the ignition switch to the "LOCK" (OFF) position.

**Q: Is the CAN bus line found to be normal?**

**YES** : Go to Step 2.

**NO** : Repair the CAN bus line. (Refer to GROUP 54C, Diagnosis P.54C-16).

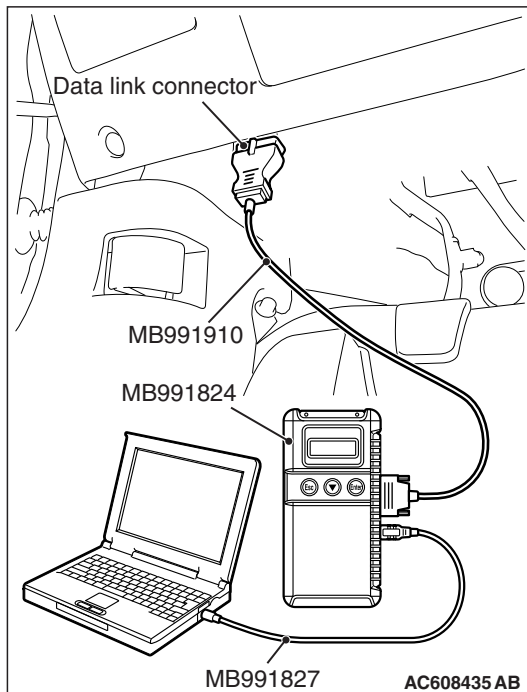
**STEP 2. Using scan tool MB991958, read the occupant classification-ECU diagnostic trouble code.**

Check if DTC is set to the occupant classification-ECU.

**Q: Is the DTC set?**

**YES** : Troubleshoot the SRS. (Refer to GROUP 52B, Diagnosis P.52B-315.)

**NO** : Go to Step 3.

---

**STEP 3. Using scan tool MB991958, read the other system diagnostic trouble code.**

Check if DTC U0154 is set to the combination meter.

**Q: Is the DTC set?**

**YES** : Go to Step 4.

**NO** : Go to Step 5.

---

**STEP 4. Recheck for diagnostic trouble code.**

Check again if the DTC is set to the WCM.

(1) Erase the DTC.

(2) Turn the ignition switch from "LOCK" (OFF) position to "ON" position.

(3) Check if DTC is set.

(4) Turn the ignition switch to the "LOCK" (OFF) position.

**Q: Is the DTC set?**

**YES** : Replace the occupant classification-ECU.

**NO** : The trouble can be an intermittent malfunction (Refer to GROUP 00 –How to use Troubleshooting/inspection Service Points –How to Cope with Intermittent Malfunction [P.00-13](#)).

---

**STEP 5. Recheck for diagnostic trouble code.**

Check again if the DTC is set to the WCM.

(1) Erase the DTC.

(2) Turn the ignition switch from "LOCK" (OFF) position to "ON" position.

(3) Check if DTC is set.

(4) Turn the ignition switch to the "LOCK" (OFF) position.

**Q: Is the DTC set?**

**YES** : Replace WCM and register the ID codes. (Refer to [P.42C-10](#).)

**NO** : The trouble can be an intermittent malfunction (Refer to GROUP 00 –How to use Troubleshooting/inspection Service Points –How to Cope with Intermittent Malfunction [P.00-13](#)).

**DTC U0155: Combination meter CAN timeout****CAUTION**

- If the diagnostic trouble code U0155 is set, be sure to diagnose the CAN bus line.
- When replacing the ECU, always check that the communication circuit is normal.

**TROUBLE JUDGMENT**

If no signal from the combination meter can be received, WCM sets DTC U0155.

**TROUBLESHOOTING HINTS**

- Malfunction of CAN bus line
- Combination meter malfunction
- Malfunction of WCM

**DIAGNOSIS****Required Special Tools:**

- MB991958: Scan Tool (M.U.T.-III Sub Assembly)
  - MB991824: Vehicle Communication Interface (V.C.I.)
  - MB991827: M.U.T.-III USB Cable
  - MB991910: M.U.T.-III Main Harness A (Vehicles with CAN communication system)

**STEP 1. Using scan tool MB991958, diagnose the CAN bus line.****CAUTION**

To prevent damage to scan tool MB991958, always turn the ignition switch to the "LOCK" (OFF) position before connecting or disconnecting scan tool MB991958.

- (1) Connect scan tool MB991958. Refer to "How to connect the Scan Tool (M.U.T.-III) P.42C-7."
- (2) Turn the ignition switch to the "ON" position.
- (3) Diagnose the CAN bus line.
- (4) Turn the ignition switch to the "LOCK" (OFF) position.

**Q: Is the CAN bus line found to be normal?**

**YES** : Go to Step 2.

**NO** : Repair the CAN bus line. (Refer to GROUP 54C, Diagnosis P.54C-16).

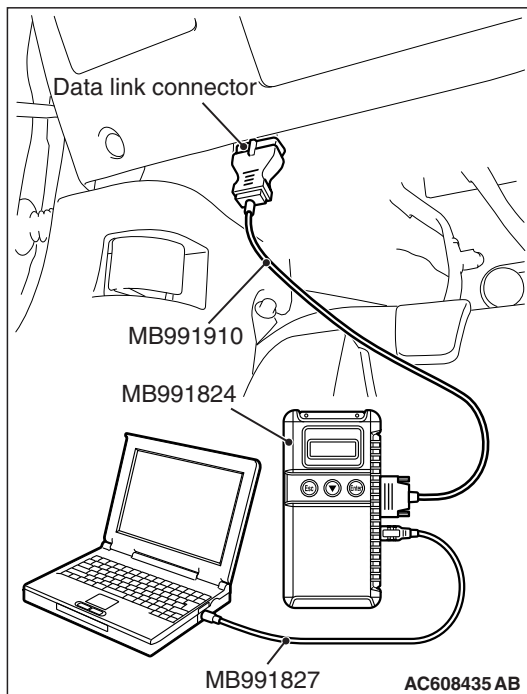
**STEP 2. Using scan tool MB991958, read the combination meter diagnostic trouble code.**

Check if DTC is set to the combination meter.

**Q: Is the DTC set?**

**YES** : Troubleshoot the combination meter. (Refer to GROUP 54A, Diagnosis P.54A-33.)

**NO** : Go to Step 3.



---

**STEP 3. Using scan tool MB991958, read the A/C-ECU diagnostic trouble code.**

Check if the DTC U0155 is set to the A/C-ECU.

**Q: Is the DTC set?**

**YES** : Go to Step 4.

**NO** : Go to Step 5.

---

**STEP 4. Recheck for diagnostic trouble code.**

Check again if the DTC is set to the WCM.

(1) Erase the DTC.

(2) Turn the ignition switch from "LOCK" (OFF) position to "ON" position.

(3) Check if DTC is set.

(4) Turn the ignition switch to the "LOCK" (OFF) position.

**Q: Is the DTC set?**

**YES** : Replace the combination meter.

**NO** : The trouble can be an intermittent malfunction such as a poor connection or open circuit in the CAN bus lines between the combination meter and the WCM. (Refer to GROUP 00, How to Cope with Intermittent Malfunction [P.00-13](#))

---

**STEP 5. Recheck for diagnostic trouble code.**

Check again if the DTC is set to the WCM.

(1) Erase the DTC.

(2) Turn the ignition switch from "LOCK" (OFF) position to "ON" position.

(3) Check if DTC is set.

(4) Turn the ignition switch to the "LOCK" (OFF) position.

**Q: Is the DTC set?**

**YES** : Replace WCM and register the ID codes. (Refer to [P.42C-10.](#))

**NO** : The trouble can be an intermittent malfunction such as a poor connection or open circuit in the CAN bus lines between the combination meter and the WCM. (Refer to GROUP 00, How to Cope with Intermittent Malfunction [P.00-13](#))

**DTC U0164: A/C-ECU CAN timeout****CAUTION**

- If DTC U0164 is set, be sure to diagnose the CAN bus line.
- When replacing the ECU, always check that the communication circuit is normal.

**DIAGNOSTIC FUNCTION**

If the signal from A/C-ECU cannot be received, the WCM sets DTC U0164.

**TROUBLESHOOTING HINTS**

- The CAN bus line may be defective.
- The A/C-ECU may be defective.
- The WCM may be defective.

**DIAGNOSIS****Required Special Tools:**

- MB991958: Scan Tool (M.U.T.-III Sub Assembly)
  - MB991824: Vehicle Communication Interface (V.C.I.)
  - MB991827: M.U.T.-III USB Cable
  - MB991910: M.U.T.-III Main Harness A (Vehicles with CAN communication system)

**STEP 1. Using scan tool MB991958, diagnose the CAN bus line****CAUTION**

To prevent damage to scan tool MB991958, always turn the ignition switch to the "LOCK" (OFF) position before connecting or disconnecting scan tool MB991958.

- (1) Connect scan tool MB991958. Refer to "How to connect the Scan Tool (M.U.T.-III) P.42C-7."
- (2) Turn the ignition switch to the "ON" position.
- (3) Diagnose the CAN bus line.
- (4) Turn the ignition switch to the "LOCK" (OFF) position.

**Q: Is the CAN bus line found to be normal?**

**YES** : Go to Step 2.

**NO** : Repair the CAN bus line. (Refer to GROUP 54C, Diagnosis P.54C-16).

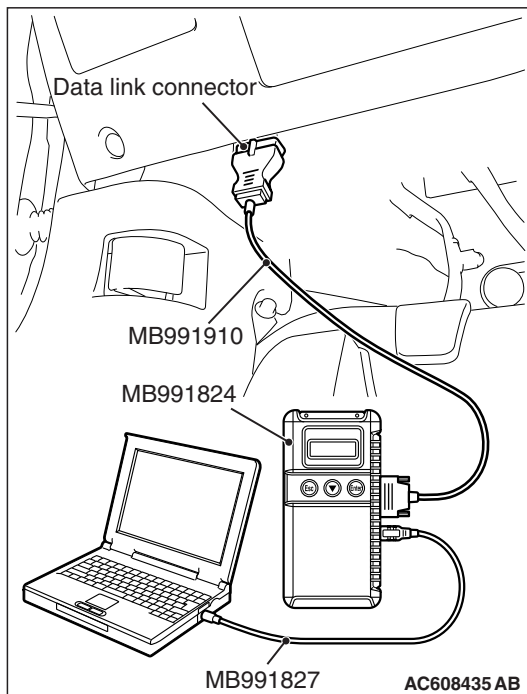
**STEP 2. Using scan tool MB991958, read the A/C diagnostic trouble code**

Check if DTC is set to the A/C-ECU.

**Q: Is the DTC set?**

**YES** : Troubleshoot the A/C (Refer to GROUP 55, Diagnosis P.55-9).

**NO** : Go to Step 3.

---

**STEP 3. Using scan tool MB991958, read the other system diagnostic trouble code.**

Check if DTC U0164 is set to the combination meter.

**Q: Is the DTC set?**

**YES** : Go to Step 4.

**NO** : Go to Step 5.

---

**STEP 4. Recheck for diagnostic trouble code.**

Check again if the DTC is set to the WCM.

(1) Erase the DTC.

(2) Turn the ignition switch from "LOCK" (OFF) position to "ON" position.

(3) Check if DTC is set.

(4) Turn the ignition switch to the "LOCK" (OFF) position.

**Q: Is the DTC set?**

**YES** : Replace the A/C-ECU.

**NO** : The trouble can be an intermittent malfunction (Refer to GROUP 00 –How to use Troubleshooting/inspection Service Points –How to Cope with Intermittent Malfunction [P.00-13](#)).

---

**STEP 5. Recheck for diagnostic trouble code.**

Check again if the DTC is set to the WCM.

(1) Erase the DTC.

(2) Turn the ignition switch from "LOCK" (OFF) position to "ON" position.

(3) Check if DTC is set.

(4) Turn the ignition switch to the "LOCK" (OFF) position.

**Q: Is the DTC set?**

**YES** : Replace WCM and register the ID codes. (Refer to [P.42C-10](#).)

**NO** : The trouble can be an intermittent malfunction (Refer to GROUP 00 –How to use Troubleshooting/inspection Service Points –How to Cope with Intermittent Malfunction [P.00-13](#)).

**DTC U0184: Audio CAN timeout****⚠ CAUTION**

- If DTC U0184 is set, be sure to diagnose the CAN bus line.
- When replacing the ECU, always check that the communication circuit is normal.

**DIAGNOSTIC FUNCTION**

When the signals from radio and CD player or CD changer cannot be received, the WCM sets DTC U0184.

**TROUBLESHOOTING HINTS**

- The CAN bus line may be defective.
- The WCM may be defective.
- The radio and CD player or CD changer may be defective.

**DIAGNOSIS****Required Special Tools:**

- MB991958: Scan Tool (M.U.T.-III Sub Assembly)
  - MB991824: Vehicle Communication Interface (V.C.I.)
  - MB991827: M.U.T.-III USB Cable
  - MB991910: M.U.T.-III Main Harness A (Vehicles with CAN communication system)

**STEP 1. Using scan tool MB991958, diagnose the CAN bus line.****⚠ CAUTION**

To prevent damage to scan tool MB991958, always turn the ignition switch to the "LOCK" (OFF) position before connecting or disconnecting scan tool MB991958.

- (1) Connect scan tool MB991958. Refer to "How to connect the Scan Tool (M.U.T.-III) P.42C-7."
- (2) Turn the ignition switch to the "ON" position.
- (3) Diagnose the CAN bus line.
- (4) Turn the ignition switch to the "LOCK" (OFF) position.

**Q: Is the CAN bus line found to be normal?**

**YES** : Go to Step 2.

**NO** : Repair the CAN bus line. (Refer to GROUP 54C, Diagnosis P.54C-16).

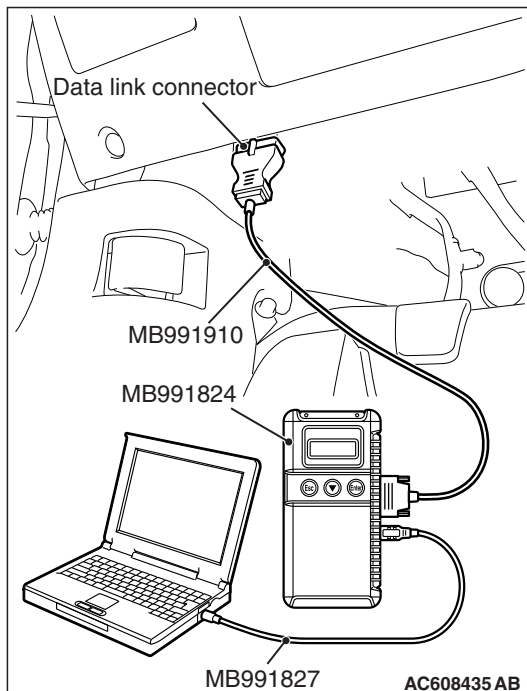

---

**STEP 2. Using scan tool MB991958, read the audio diagnostic trouble code.**

Check again if the DTC is set to the audio.

**Q: Is the DTC set?**

**YES** : Troubleshoot the radio and CD player. Refer to GROUP 54A, Diagnosis <radio and CD player>[P.54A-343](#) .

**NO** : Go to Step 3.

---

**STEP 3. Using scan tool MB991958, read the other system diagnostic trouble code.**

Check if DTC U0184 is set to the combination meter.

**Q: Is the DTC set?**

**YES** : Go to Step 4.

**NO** : Go to Step 5.

---

**STEP 4. Recheck for diagnostic trouble code.**

Check again if the DTC is set to the WCM.

(1) Erase the DTC.

(2) Turn the ignition switch from "LOCK" (OFF) position to "ON" position.

(3) Check if DTC is set.

(4) Turn the ignition switch to the "LOCK" (OFF) position.

**Q: Is the DTC set?**

**YES** : Replace the radio and CD player or CD changer.

**NO** : The trouble can be an intermittent malfunction (Refer to GROUP 00 –How to use Troubleshooting/inspection Service Points –How to Cope with Intermittent Malfunction [P.00-13](#)).

---

**STEP 5. Recheck for diagnostic trouble code.**

Check again if the DTC is set to the WCM.

(1) Erase the DTC.

(2) Turn the ignition switch from "LOCK" (OFF) position to "ON" position.

(3) Check if DTC is set.

(4) Turn the ignition switch to the "LOCK" (OFF) position.

**Q: Is the DTC set?**

**YES** : Replace WCM and register the ID codes. (Refer to [P.42C-10](#).)

**NO** : The trouble can be an intermittent malfunction (Refer to GROUP 00 –How to use Troubleshooting/inspection Service Points –How to Cope with Intermittent Malfunction [P.00-13](#)).

**DTC U0195: Satellite radio tuner CAN timeout****CAUTION**

- If DTC U0195 is set to the ETACS-ECU, always diagnose the CAN bus line.
- Before replacing the ECU, ensure that the communication circuit is normal.

**TROUBLE JUDGMENT**

If the signal from satellite radio tuner cannot be received, the WCM sets DTC U0195.

**TROUBLESHOOTING HINTS**

- The satellite radio tuner may be defective.
- The WCM may be defective.
- The CAN bus may be defective.

**DIAGNOSIS****Required Special Tools:**

- MB991958: Scan Tool (M.U.T.-III Sub Assembly)
  - MB991824: Vehicle Communication Interface (V.C.I.)
  - MB991827: M.U.T.-III USB Cable
  - MB991910: M.U.T.-III Main Harness A (Vehicles with CAN communication system)

**STEP 1. Using scan tool MB991958, diagnose the CAN bus line.****CAUTION**

To prevent damage to scan tool MB991958, always turn the ignition switch to the "LOCK" (OFF) position before connecting or disconnecting scan tool MB991958.

- (1) Connect scan tool MB991958. Refer to "How to connect the Scan Tool (M.U.T.-III) P.42C-7."
- (2) Turn the ignition switch to the "ON" position.
- (3) Diagnose the CAN bus line.
- (4) Turn the ignition switch to the "LOCK" (OFF) position.

**Q: Is the CAN bus line found to be normal?**

**YES** : Go to Step 2.

**NO** : Repair the CAN bus line. (Refer to GROUP 54C, Diagnosis P.54C-16).

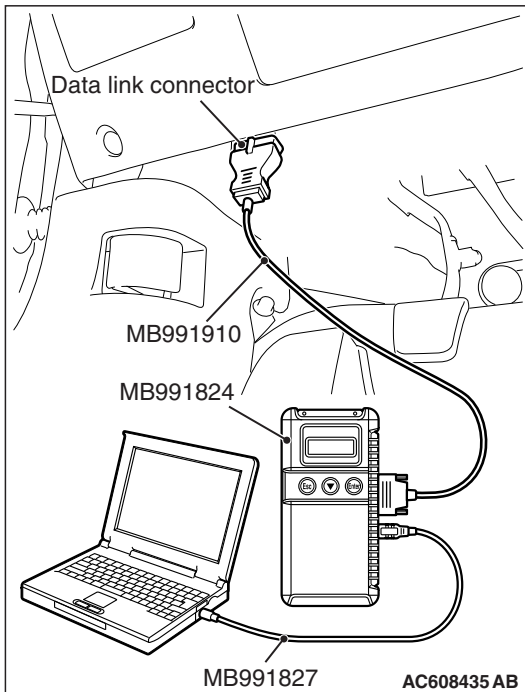
**STEP 2. Using scan tool MB991958, read the satellite radio tuner diagnostic trouble code.**

Check if DTC is set to the satellite radio tuner.

**Q: Is the DTC set?**

**YES** : Troubleshoot the satellite radio (Refer to GROUP 54B, Diagnosis <Satellite Radio tuner>).

**NO** : Go to Step 3.

---

**STEP 3. Using scan tool MB991958, read the other system diagnostic trouble code.**

Check if DTC U0195 is set to the combination meter.

**Q: Is the DTC set?**

**YES** : Go to Step 4.

**NO** : Go to Step 5.

---

**STEP 4. Recheck for diagnostic trouble code.**

Check again if the DTC is set to the WCM.

(1) Erase the DTC.

(2) Turn the ignition switch from "LOCK" (OFF) position to "ON" position.

(3) Check if DTC is set.

(4) Turn the ignition switch to the "LOCK" (OFF) position.

**Q: Is the DTC set?**

**YES** : Replace the satellite radio tuner.

**NO** : The trouble can be an intermittent malfunction such as a poor connection or open circuit in the CAN bus lines between the satellite radio tuner and the WCM. (Refer to GROUP 00, How to Cope with Intermittent Malfunction [P.00-13](#))

---

**STEP 5. Recheck for diagnostic trouble code.**

Check again if the DTC is set to the WCM.

(1) Erase the DTC.

(2) Turn the ignition switch from "LOCK" (OFF) position to "ON" position.

(3) Check if DTC is set.

(4) Turn the ignition switch to the "LOCK" (OFF) position.

**Q: Is the DTC set?**

**YES** : Replace WCM and register the ID codes. (Refer to [P.42C-10.](#))

**NO** : The trouble can be an intermittent malfunction such as a poor connection or open circuit in the CAN bus lines between the satellite radio tuner and the WCM. (Refer to GROUP 00, How to Cope with Intermittent Malfunction [P.00-13](#))

**DTC U0197: Hands free module CAN timeout****CAUTION**

- If DTC U0197 is set, be sure to diagnose the CAN bus line.
- When replacing the ECU, always check that the communication circuit is normal.

**DIAGNOSTIC FUNCTION**

When the signals from hands free module cannot be received, the WCM sets DTC U0197.

**TROUBLESHOOTING HINTS**

- The CAN bus line may be defective.
- The WCM may be defective.
- The hands free module may be defective.

**DIAGNOSIS****Required Special Tools:**

- MB991958: Scan Tool (M.U.T.-III Sub Assembly)
  - MB991824: Vehicle Communication Interface (V.C.I.)
  - MB991827: M.U.T.-III USB Cable
  - MB991910: M.U.T.-III Main Harness A (Vehicles with CAN communication system)

**STEP 1. Using scan tool MB991958, diagnose the CAN bus line.****CAUTION**

To prevent damage to scan tool MB991958, always turn the ignition switch to the "LOCK" (OFF) position before connecting or disconnecting scan tool MB991958.

- (1) Connect scan tool MB991958. Refer to "How to connect the Scan Tool (M.U.T.-III) P.42C-7."
- (2) Turn the ignition switch to the "ON" position.
- (3) Diagnose the CAN bus line.
- (4) Turn the ignition switch to the "LOCK" (OFF) position.

**Q: Is the CAN bus line found to be normal?**

**YES** : Go to Step 2.

**NO** : Repair the CAN bus line. (Refer to GROUP 54C, Diagnosis P.54C-16).

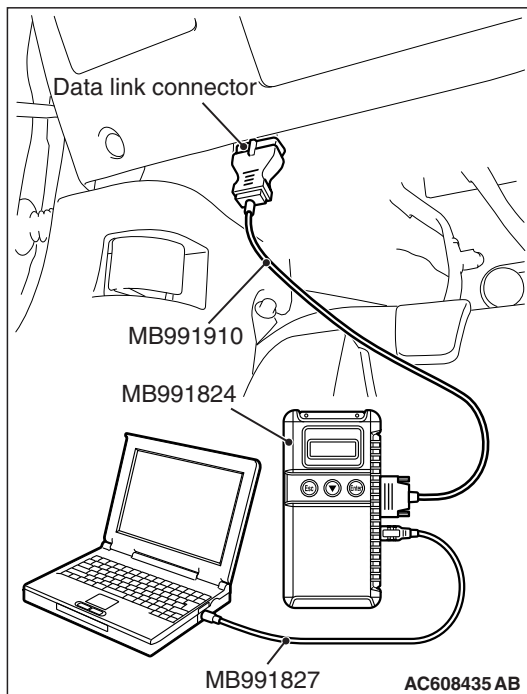



---

**STEP 2. Using scan tool MB991958, read the hands free module diagnostic trouble code.**

Check again if the DTC is set to the hands free module.

**Q: Is the DTC set?**

**YES :** Troubleshoot the hands-free cellular phone system.  
Refer to GROUP 54A, Diagnosis <hands-free cellular phone system>.

**NO :** Go to Step 3.

---

**STEP 3. Using scan tool MB991958, read the other system diagnostic trouble code.**

Check if DTC U0197 is set to the combination meter.

**Q: Is the DTC set?**

**YES :** Go to Step 4.

**NO :** Go to Step 5.

---

**STEP 4. Recheck for diagnostic trouble code.**

Check again if the DTC is set to the WCM.

(1) Erase the DTC.

(2) Turn the ignition switch from "LOCK" (OFF) position to "ON" position.

(3) Check if DTC is set.

(4) Turn the ignition switch to the "LOCK" (OFF) position.

**Q: Is the DTC set?**

**YES :** Replace The hands free module.

**NO :** The trouble can be an intermittent malfunction (Refer to GROUP 00 –How to use Troubleshooting/inspection Service Points –How to Cope with Intermittent Malfunction [P.00-13](#)).

---

**STEP 5. Recheck for diagnostic trouble code.**

Check again if the DTC is set to the WCM.

(1) Erase the DTC.

(2) Turn the ignition switch from "LOCK" (OFF) position to "ON" position.

(3) Check if DTC is set.

(4) Turn the ignition switch to the "LOCK" (OFF) position.

**Q: Is the DTC set?**

**YES :** Replace WCM and register the ID codes. (Refer to [P.42C-10](#).)

**NO :** The trouble can be an intermittent malfunction (Refer to GROUP 00 –How to use Troubleshooting/inspection Service Points –How to Cope with Intermittent Malfunction [P.00-13](#)).

**DTC U0245: Audio visual navigation unit CAN timeout****CAUTION**

- If DTC U0245 is set, be sure to diagnose the CAN bus line.
- When replacing the ECU, always check that the communication circuit is normal.

**DIAGNOSTIC FUNCTION**

When the signals from audio visual navigation unit cannot be received, the WCM sets DTC U0245.

**TROUBLESHOOTING HINTS**

- The CAN bus line may be defective.
- The WCM may be defective.
- The audio visual navigation unit may be defective.

**DIAGNOSIS****Required Special Tools:**

- MB991958: Scan Tool (M.U.T.-III Sub Assembly)
  - MB991824: Vehicle Communication Interface (V.C.I.)
  - MB991827: M.U.T.-III USB Cable
  - MB991910: M.U.T.-III Main Harness A (Vehicles with CAN communication system)

**STEP 1. Using scan tool MB991958, diagnose the CAN bus line****CAUTION**

To prevent damage to scan tool MB991958, always turn the ignition switch to the "LOCK" (OFF) position before connecting or disconnecting scan tool MB991958.

- (1) Connect scan tool MB991958. Refer to "How to connect the Scan Tool (M.U.T.-III) P.42C-7."
- (2) Turn the ignition switch to the "ON" position.
- (3) Diagnose the CAN bus line.
- (4) Turn the ignition switch to the "LOCK" (OFF) position.

**Q: Is the CAN bus line found to be normal?**

**YES** : Go to Step 2.

**NO** : Repair the CAN bus line. (Refer to GROUP 54C, Diagnosis P.54C-16).

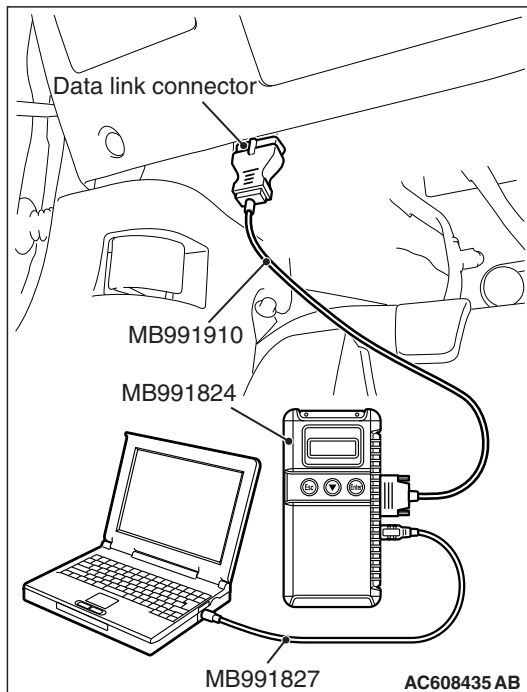
**STEP 2. Using scan tool MB991958, read the audio visual navigation unit diagnostic trouble code.**

Check if DTC is set to the audio visual navigation unit.

**Q: Is the DTC set?**

**YES** : Troubleshoot the MMCS. (Refer to GROUP 54A, Diagnosis <MMCS>P.54A-436 .)

**NO** : Go to Step 3.

---

**STEP 3. Using scan tool MB991958, read the other system diagnostic trouble code.**

Check if DTC U0245 is set to the combination meter.

**Q: Is the DTC set?**

**YES** : Go to Step 4.

**NO** : Go to Step 5.

---

**STEP 4. Recheck for diagnostic trouble code.**

Check again if the DTC is set to the WCM.

(1) Erase the DTC.

(2) Turn the ignition switch from "LOCK" (OFF) position to "ON" position.

(3) Check if DTC is set.

(4) Turn the ignition switch to the "LOCK" (OFF) position.

**Q: Is the DTC set?**

**YES** : Replace the audio visual navigation unit.

**NO** : The trouble can be an intermittent malfunction (Refer to GROUP 00 –How to use Troubleshooting/inspection Service Points –How to Cope with Intermittent Malfunction [P.00-13](#)).

---

**STEP 5. Recheck for diagnostic trouble code.**

Check again if the DTC is set to the WCM.

(1) Erase the DTC.

(2) Turn the ignition switch from "LOCK" (OFF) position to "ON" position.

(3) Check if DTC is set.

(4) Turn the ignition switch to the "LOCK" (OFF) position.

**Q: Is the DTC set?**

**YES** : Replace WCM and register the ID codes. (Refer to [P.42C-10](#).)

**NO** : The trouble can be an intermittent malfunction (Refer to GROUP 00 –How to use Troubleshooting/inspection Service Points –How to Cope with Intermittent Malfunction [P.00-13](#)).

---

**DTC U1412: Implausible vehicle speed signal received**

---

**⚠ CAUTION**

If there is any problem in the CAN bus lines, an incorrect diagnostic trouble code may be set. Prior to this diagnosis, diagnose the CAN bus lines (Refer to GROUP 54C, Trouble code diagnosis [P.54C-16](#)).

**TPMS DTC SET CONDITION**

WCM receives the wheel speed information from ASC-ECU via the CAN-bus line. If WCM cannot receive the information about the wheel speed sensor from ASC-ECU, this code is set.

**TROUBLESHOOTING HINTS**

The most likely causes for this DTC to set are:

- Damaged wiring harness and connector
- Malfunction of ASC-ECU
- Malfunction of WCM
- Malfunction of ETACS-ECU

**DIAGNOSIS****Required Special Tools:**

- MB991958: Scan Tool (M.U.T.-III Sub Assembly)
  - MB991824: Vehicle Communication Interface (V.C.I.)
  - MB991827: M.U.T.-III USB Cable
  - MB991910: M.U.T.-III Main Harness A

---

**STEP 1. Using scan tool MB991958, diagnose the CAN bus lines.**

Use scan tool to diagnose the CAN bus lines.

**Q: Is the check result normal?**

**YES** : Go to Step 3.

**NO** : Repair the CAN bus lines (Refer to GROUP 54C – CAN Bus Diagnostics Table [P.54C-16](#)). On completion, go to Step 2.

---

**STEP 2. Diagnostic trouble code recheck after resetting CAN bus lines**

- (1) Turn the ignition switch to the "LOCK" (OFF) position.
- (2) Turn the ignition switch to the "ON" position.
- (3) Check if the DTC is set.
- (4) Turn the ignition switch to the "LOCK" (OFF) position.

**Q: Is the DTC U1412 set?**

**YES** : Go to Step 3.

**NO** : The procedure is complete.

---

**STEP 3. Check for other diagnostic trouble code.**

Check if the diagnostic trouble code is set from ASC-ECU (Refer to GROUP 35C, Diagnostic Trouble Code Chart P.35C-27).

**Q: Is the check result normal?**

**YES :** Go to Step 4.

**NO :** Carry out the troubleshooting for ASC-ECU (Refer to GROUP 35C, Diagnostic Trouble Code Chart P.35C-27). Then go to Step 5.

---

**STEP 4. Check for other diagnostic trouble code.**

Check if the diagnostic trouble code is set from ETACS-ECU (Refer to GROUP 54A –Diagnostic Trouble Code Chart P.54A-674).

**Q: Is the check result normal?**

**YES :** Replace the WCM and register ID codes (Refer to P.42C-10). Then go to Step 5.

**NO :** Carry out the troubleshooting (Refer to GROUP 54A – Diagnostic Trouble Code Chart P.54A-674). Then go to Step 5.

---

**STEP 5. Recheck for diagnostic trouble code.**

Check again if the DTC is set.

- (1) Turn the ignition switch to the "LOCK" (OFF) position.
- (2) Turn the ignition switch to the "ON" position.
- (3) Check if the DTC is set.
- (4) Turn the ignition switch to the "LOCK" (OFF) position.

**Q: Is the DTC U1412 reset?**

**YES :** Start over at Step 1.

**NO :** The procedure is complete.

---

**DTC U1415: Coding not completed/Data fail**

 **CAUTION**

- If DTC U1415 is set, diagnose the CAN bus lines.
- When replacing the ECU, always check that the communication circuit is normal.

**DIAGNOSTIC FUNCTION**

If the vehicle information data is not registered to the combination meter, the WCM sets DTC U1415.

**JUDGMENT CRITERIA**

With the global coding counter value "0," if all the global coding data (vehicle information) are not stored, the WCM determines that a problem has occurred.

**TROUBLESHOOTING HINTS**

- The CAN bus line may be defective.
- The WCM may be defective.
- The ETACS-ECU may be defective.

**DIAGNOSIS**

**Required Special Tools:**

- MB991958: Scan Tool (M.U.T.-III Sub Assembly)
  - MB991824: Vehicle Communication Interface (V.C.I.)
  - MB991827: M.U.T.-III USB Cable
  - MB991910: M.U.T.-III Main Harness A (Vehicles with CAN communication system)

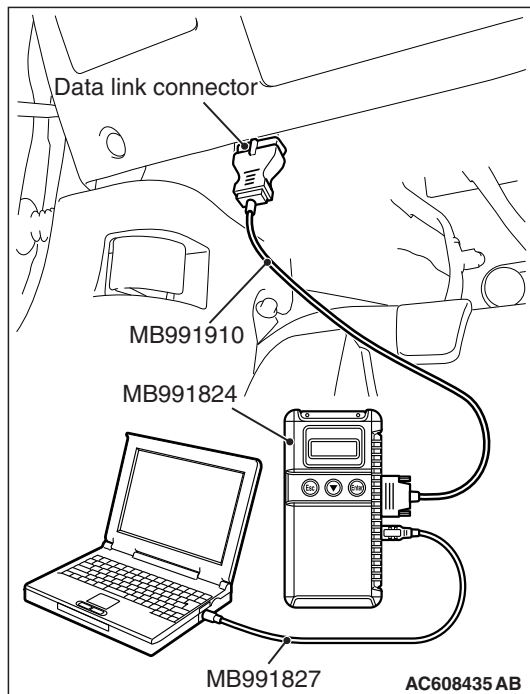

**STEP 1. Using scan tool MB991958, diagnose the CAN bus line.**

**⚠ CAUTION**

To prevent damage to scan tool MB991958, always turn the ignition switch to the "LOCK" (OFF) position before connecting or disconnecting scan tool MB991958.

- (1) Connect scan tool MB991958. Refer to "How to connect the Scan Tool (M.U.T.-III) P.42C-7."
- (2) Turn the ignition switch to the "ON" position.
- (3) Diagnose the CAN bus line.
- (4) Turn the ignition switch to the "LOCK" (OFF) position.

**Q: Is the CAN bus line found to be normal?**

**YES :** Go to Step 2.

**NO :** Repair the CAN bus line. (Refer to GROUP 54C, Diagnosis P.54C-16).

**STEP 2. Using scan tool MB991958, read the ETACS-ECU diagnostic trouble code.**

Check if a coding-related DTC is set to the ETACS-ECU.

**Q: Is the DTC set?**

**YES :** Troubleshoot the ETACS-ECU. Refer to GROUP 54A –ETACS –Troubleshooting P.54A-674. Then go to Step 3.

**NO :** Go to Step 3.

**STEP 3. Recheck for diagnostic trouble code.**

Check again if the DTC is set to the WCM.

- (1) Erase the DTC.
- (2) Turn the ignition switch from "LOCK" (OFF) position to "ON" position.
- (3) Check if DTC is set.
- (4) Turn the ignition switch to the "LOCK" (OFF) position.

**Q: Is the DTC set?**

**YES :** Replace WCM and register the ID codes. (Refer to P.42C-10.)

**NO :** The trouble can be an intermittent malfunction (Refer to GROUP 00 –How to use Troubleshooting/inspection Service Points –How to Cope with Intermittent Malfunction P.00-13).

---

Code No.U1417 Implausible coding data

---

 **CAUTION**

- If diagnostic trouble code U1417 is set in WCM, always diagnose the CAN bus lines. If there is any fault in the CAN bus lines, an incorrect diagnostic trouble code may be set. In this case, the set diagnostic trouble code is not highly reliable.
- Before replacing the ECU, ensure that the communication circuit is normal.
- When diagnostic trouble code U1417 is set in WCM, the diagnostic trouble code may also be set in ETACS-ECU. When the diagnostic trouble code is set in ETACS-ECU, carry out the diagnosis of the diagnostic trouble code for ETACS-ECU first.

### **CIRCUIT OPERATION**

WCM receives the vehicle information stored in the ETACS-ECU via CAN bus lines.

### **DTC SET CONDITIONS**

WCM communicates with ETACS-ECU via CAN bus lines. This diagnostic trouble code is set when the vehicle information received from the ETACS-ECU is invalid.

### **PROBABLE CAUSES**

- Malfunction of ETACS-ECU
- Engine control module malfunction
- ETACS-ECUs have been interchanged between two vehicles.
- WCM malfunction
- External noise interference
- WCMs have been interchanged between two vehicles.

### **DIAGNOSIS**

#### **Required Special Tools:**

- MB991958: Scan Tool (M.U.T.-III Sub Assembly)
  - MB991824: Vehicle Communication Interface (V.C.I.)
  - MB991827: M.U.T.-III USB Cable
  - MB991910: M.U.T.-III Main Harness A

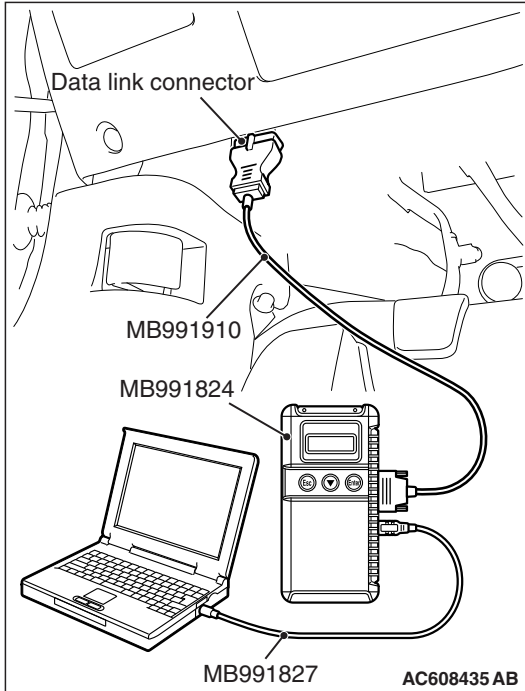

**STEP 1. Using scan tool MB991958, diagnose the CAN bus line.**

**⚠ CAUTION**

To prevent damage to scan tool MB991958, always turn the ignition switch to the "LOCK" (OFF) position before connecting or disconnecting scan tool MB991958.

- (1) Connect scan tool MB991958. Refer to "How to connect the Scan Tool (M.U.T.-III) P.42C-7."
- (2) Turn the ignition switch to the "ON" position.
- (3) Diagnose the CAN bus line.
- (4) Turn the ignition switch to the "LOCK" (OFF) position.

**Q: Is the CAN bus line found to be normal?**

**YES :** Go to Step 2.

**NO :** Repair the CAN bus line. (Refer to GROUP 54C, Diagnosis P.54C-16).

**STEP 2. Using scan tool MB991958, read the other system diagnostic trouble code.**

Check if DTC is set to the ETACS-ECU or engine control module.

**Q: Is the DTC set?**

**YES (DTC is set to ETACS-ECU.) :** Troubleshoot the ETACS (Refer to GROUP 54A, Diagnosis P.54A-674.). Then go to Step 3.

**YES (DTC is set to the engine control module.) :** Troubleshoot the MFI system (Refer to GROUP 13A, Diagnosis P.13A-50 <2.0L Engine> or GROUP 13B, Diagnosis P.13B-51 <2.4L Engine>.). Then go to Step 3.

**NO :** Go to Step 3.

**STEP 3. Check part number of ETACS-ECU**

Check the part number of ETACS-ECU.

**OK: 8637A320**

**Q: Is the check result normal?**

**YES :** Go to Step 4.

**NO :** Replace ETACS-ECU.



---

**STEP 4. Check part number of WCM**

Check the part number of WCM.

**OK: MN141352**

**Q: Is the check result normal?**

**YES :** Go to Step 5.

**NO :** Replace WCM and register the ID codes. (Refer to [P.42C-10.](#))

---

**STEP 5. Recheck for diagnostic trouble code.**

Check again if the DTC is set to the WCM.

(1) Erase the DTC.

(2) Turn the ignition switch from "LOCK" (OFF) position to "ON" position.

(3) Check if DTC is set.

(4) Turn the ignition switch to the "LOCK" (OFF) position.

**Q: Is the DTC set?**

**YES :** Replace WCM and register the ID codes. (Refer to [P.42C-10.](#))

**NO :** The trouble can be an intermittent malfunction (Refer to GROUP 00 –How to use Troubleshooting/inspection Service Points –How to Cope with Intermittent Malfunction [P.00-13](#)).

## DATA LIST REFERENCE TABLE

M1427501000034

Item No.	Scan tool MB991958 display	Check conditions	Normal conditions
1	Received key data(ID)	–	Key ID for stored ignition key
2	Received key data(button)	–	Switch display of transmitter
13	Number of registered IMMOB.key	–	Number of stored ignition keys (Number of registered ignition keys that can start the engine)
21	Air pressure, Tire 1	–	–
22	Air pressure, Tire 2		
23	Air pressure, Tire 3		
24	Air pressure, Tire 4		
25*	Air pressure, Tire 5		
31	Acceleration, Tire 1	–	–
32	Acceleration, Tire 2		
33	Acceleration, Tire 3		
34	Acceleration, Tire 4		
35*	Acceleration, Tire 5		
36	Threshold of PRS. warning	The tire pressure is within the specified value range.	OFF
		The tire pressure is not within the specified value range.	ON
37	Threshold of PRS. warning release	The tire pressure is within the specified value range.	ON
		The tire pressure is not within the specified value range.	OFF
38	Number of registered TPMS ID	–	Number of stored TPMS
39	Ignition signal(CAN data)	Ignition switch status information received from ETACS-ECU via CAN:ON	ON
		Ignition switch status information received from ETACS-ECU via CAN:OFF	OFF
40	Ignition signal(Port input)	Ignition switch: ON	ON
		Ignition switch: OFF	OFF
41	VSS	Drive the vehicle	The scan tool and the speedometer readings are approximately the same
50	Registered ID reception, Tier1	Ignition switch: ON	Yes
		Ignition switch: OFF	No
51	Registered ID reception, Tier2	Ignition switch: ON	Yes
		Ignition switch: OFF	No

<b>Item No.</b>	<b>Scan tool MB991958 display</b>	<b>Check conditions</b>	<b>Normal conditions</b>
52	Registered ID reception, Tier3	Ignition switch: ON	Yes
		Ignition switch: OFF	No
53	Registered ID reception, Tier4	Ignition switch: ON	Yes
		Ignition switch: OFF	No
54*	Registered ID reception, Tier5	–	–
61	Air pressure, Tire1(not adjusted)	–	–
62	Air pressure, Tire2(not adjusted)		
63	Air pressure, Tire3(not adjusted)		
64	Air pressure, Tire4(not adjusted)		
65*	Air pressure, Tire5(not adjusted)		

*NOTE: \* shows that it is displayed but not used.*

## TROUBLE SYMPTOM CHART

**⚠ CAUTION**

During diagnosis, a DTC associated with other system may be set when the ignition switch is turned on with connector(s) disconnected. On completion, check all systems for DTC(s). If DTC(s) are set, erase them all.

Trouble symptom	Inspection procedure number	Reference page
Scan tool cannot communicate with WCM.	1	P.42C-84
The ignition key cannot be registered using scan tool.	2	P.42C-86
Engine does not start.	3	P.42C-87
Abnormality in WCM power supply and ground circuits.	4	P.42C-90
Keyless entry system does not work.	5	P.42C-93
Keyless entry hazard light answerback function, the dome light answerback function or the horn answerback function does not work normally.	6	P.42C-97
The timer lock function does not work after the doors have been unlocked by the keyless entry system.	7	P.42C-99
Power door locks with selective unlocking does not work.	8	P.42C-100

## SYMPTOM PROCEDURES

**Inspection Procedure 1: Scan tool cannot communicate with WCM.****⚠ CAUTION**

Before replacing the ECU, ensure that the communication circuit is normal.

**TECHNICAL DESCRIPTION (COMMENT)**

If the scan tool cannot communicate with the WCM, the CAN bus lines may be defective. If the WCM does not work, the WCM or the power supply circuit may be defective.

**TROUBLESHOOTING HINTS**

- Malfunction of the power supply or ground of WCM
- Malfunction of CAN bus line
- Malfunction of WCM

**DIAGNOSIS****Required Special Tools:**

- MB991958: Scan Tool (M.U.T.-III Sub Assembly)
  - MB991824: Vehicle Communication Interface (V.C.I.)
  - MB991827: M.U.T.-III USB Cable
  - MB991910: M.U.T.-III Main Harness A (Vehicles with CAN communication system)

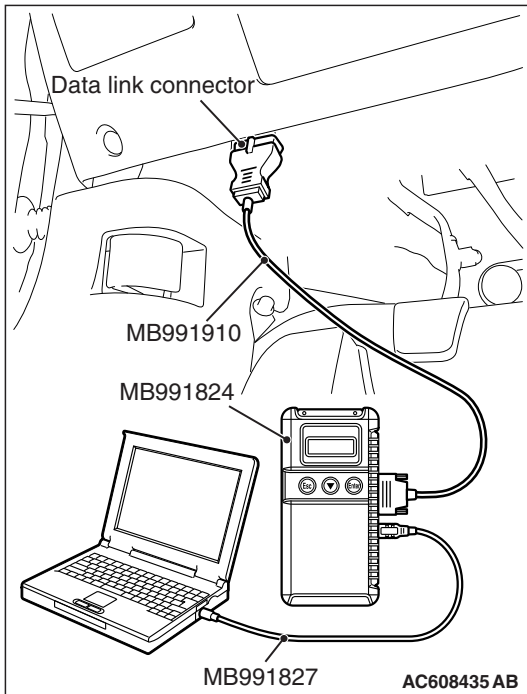

**STEP 1. Using scan tool MB991958, diagnose the CAN bus line.**

**⚠ CAUTION**

**To prevent damage to scan tool MB991958, always turn the ignition switch to the "LOCK" (OFF) position before connecting or disconnecting scan tool MB991958.**

- (1) Connect scan tool MB991958. Refer to "How to connect the Scan Tool (M.U.T.-III) P.42C-7."
- (2) Turn the ignition switch to the "ON" position.
- (3) Diagnose the CAN bus line.
- (4) Turn the ignition switch to the "LOCK" (OFF) position.

**Q: Is the CAN bus line found to be normal?**

**YES :** Go to Step 2.

**NO :** Repair the CAN bus line. (Refer to GROUP 54C, Diagnosis P.54C-16).

**STEP 2. Check the power supply circuit and the ground circuit to WCM.**

Refer to Inspection Procedure 4 "Abnormality in WCM power supply and ground circuits." P.42C-90.

**Q: Are the power supply circuit and the ground circuit to WCM in good condition ?**

**YES :** Go to Step 3.

**NO :** Repair the power supply circuit and the ground circuit to WCM.

**STEP 3. Retest the system**

Check if scan tool can communicate with WCM.

**Q: Does the scan tool cannot communicate with WCM in good condition?**

**YES :** The trouble can be an intermittent malfunction (Refer to GROUP 00 –How to use Troubleshooting/inspection Service Points –How to Cope with Intermittent Malfunction P.00-13).

**NO :** Replace WCM and register the ID codes. (Refer to P.42C-10.)

---

**Inspection Procedure 2: The ignition key cannot be registered using scan tool.**

---

**TECHNICAL DESCRIPTION (COMMENT)**

If only some ignition keys cannot be registered, the ignition key itself may be faulty. If no ignition key can be registered, the key assembly may have already been registered for another vehicle, or the WCM may be faulty.

**TROUBLESHOOTING HINTS**

- Malfunction of the ignition key
- Damaged wiring harness and connectors
- Malfunction of WCM
- Ignition key registered for other vehicle

**DIAGNOSIS****Required Special Tools:**

- MB991958: Scan Tool (M.U.T.-III Sub Assembly)
  - MB991824: Vehicle Communication Interface (V.C.I.)
  - MB991827: M.U.T.-III USB Cable
  - MB991910: M.U.T.-III Main Harness A

---

**STEP 1. Check the ignition key inserted in the key cylinder for interference.**

**Q: Are there other ignition keys or anything that interferes with the communication (things that generate radio waves such as magnets and an air-cleaning device that has a power plug) near the ignition key inserted in the key cylinder?**

**YES :** Move away or remove other ignition keys or things that interfere with the communication (things that generate radio waves such as magnets and an air-cleaning device that has a power plug) near the ignition key. Then, go to step 2.

**NO :** Go to Step 3.

---

**STEP 2. Retest the system**

Check that the ignition key can be registered.

**Q: Is the ignition key that cannot be registered using scan tool?**

**YES :** Go to Step 3.

**NO :** The procedure is complete.

---

**STEP 3. Check which ignition key cannot be registered.**

**Q: Can any one of the ignition keys be registered?**

**YES (Only some keys) :** Replace the key that cannot be registered and register the ID codes (Refer to [P.42C-10](#)). After registering the ID codes, go to Step 5.

**NO (All keys) :** Go to Step 4.

---

**STEP 4. Retest the system**

Check the scan tool screen when the key was not able to be registered.

**Q: Is the error message of scan tool screen "Abnormality in key" ?**

**YES (Abnormality in key) :** Carry out DTC B1A25: Key ID unmatched and DTC B1A35: Transponder read error (Refer to [P.42C-28](#) <B1A25>, [P.42C-32](#) <B1A35>). Then, go to Step 5.

**NO (ECU internal error) :** Replace WCM and register the ID codes (Refer to [P.42C-10](#)).

---

**STEP 5. Retest the system**

Check that the ignition key can be registered.

**Q: Is the ignition key that cannot be registered using scan tool?**

**YES :** Replace WCM and register the ID codes (Refer to [P.42C-10](#)).

**NO :** The procedure is complete.

---

**Inspection Procedure 3: Engine does not start.**

**TECHNICAL DESCRIPTION (COMMENT)**

If the fuel injection does not work, WCM and the MFI system may have a problem. This symptom is not considered abnormal when the engine is started by an ignition key that has not been registered.

**TROUBLESHOOTING HINTS**

- Malfunction of battery
- Malfunction of the MFI system
- Malfunction of WCM
- Malfunction of CAN bus line
- Malfunction of the transponder
- VIN not programmed

**DIAGNOSIS**

**Required Special Tools:**

- MB991958: Scan Tool (M.U.T.-III Sub Assembly)
  - MB991824: Vehicle Communication Interface (V.C.I.)
  - MB991827: M.U.T.-III USB Cable
  - MB991910: M.U.T.-III Main Harness A (Vehicles with CAN communication system)

---

**STEP 1. Check the battery voltage.**

Measure the battery voltage when cranking.

- The voltage should measure 8 volt or more.

**Q: Is the measured voltage 8 volt or more?**

**YES :** Go to Step 2.

**NO :** Check the battery. (Refer to GROUP 54A –Battery test [P.54A-8](#).)

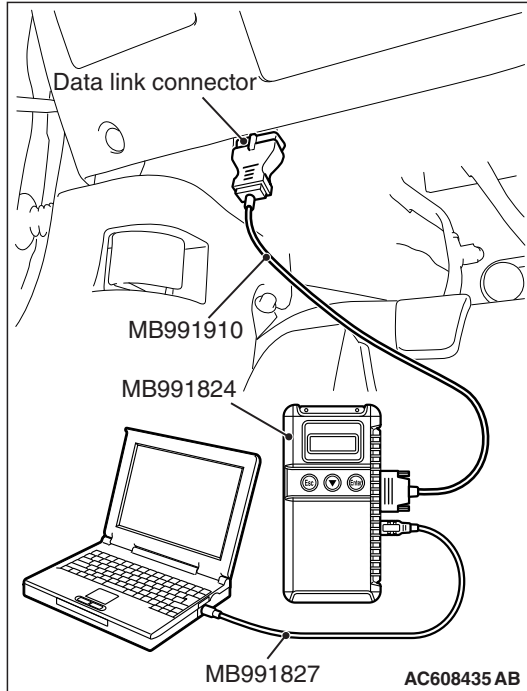

**STEP 2. Using scan tool MB991958, diagnose the CAN bus line.**

**⚠ CAUTION**

To prevent damage to scan tool MB991958, always turn the ignition switch to the "LOCK" (OFF) position before connecting or disconnecting scan tool MB991958.

- (1) Connect scan tool MB991958. Refer to "How to connect the Scan Tool (M.U.T.-III) P.42C-7."
- (2) Turn the ignition switch to the "ON" position.
- (3) Diagnose the CAN bus line.
- (4) Turn the ignition switch to the "LOCK" (OFF) position.

**Q: Is the CAN bus line found to be normal?**

**YES :** Go to Step 3.

**NO :** Repair the CAN bus line. (Refer to GROUP 54C, Diagnosis P.54C-16).

**STEP 3. Using scan tool MB991958, read the MFI system diagnostic trouble code.**

Check if DTC is set to the engine control module.

**Q: Is the DTC set?**

**YES :** Troubleshoot the MFI system (Refer to Refer to GROUP 13A, Diagnostic Trouble Code Chart P.13A-50 <2.0L Engine>, GROUP 13B, Diagnostic Trouble Code Chart P.13B-51 <2.4L Engine>). Then go to Step 4.

**NO :** Go to Step 4.



---

**STEP 4. Using scan tool MB991958, read the WCM diagnostic trouble code.**

Check if DTC is set to the WCM.

**Q: Is the DTC set?**

**YES** : Troubleshoot the WCM. (Refer to [P.42C-7.](#))

**NO** : Go to Step 5.

---

**STEP 5. Check that the engine starts.**

**Q: Does the engine start?**

**YES** : The procedure is complete.

**NO** : Refer to Refer to GROUP 13A, Diagnostic Trouble Code Chart [P.13A-50](#) <2.0L Engine>, GROUP 13B, Diagnostic Trouble Code Chart [P.13B-51](#) <2.4L Engine>. When the cause of the failure cannot be tracked down by the troubleshooting in GROUP 13A <2.0L Engine> or GROUP 13B <2.4L Engine>, replace WCM and register the ID codes. (Refer to [P.42C-10.](#))

Inspection Procedure 4: Abnormality in WCM power supply and ground circuits.

**CAUTION**

Before replacing the ECU, ensure that the power supply circuit, the ground circuit and the communication circuit are normal.

WCM Power Supply Circuit

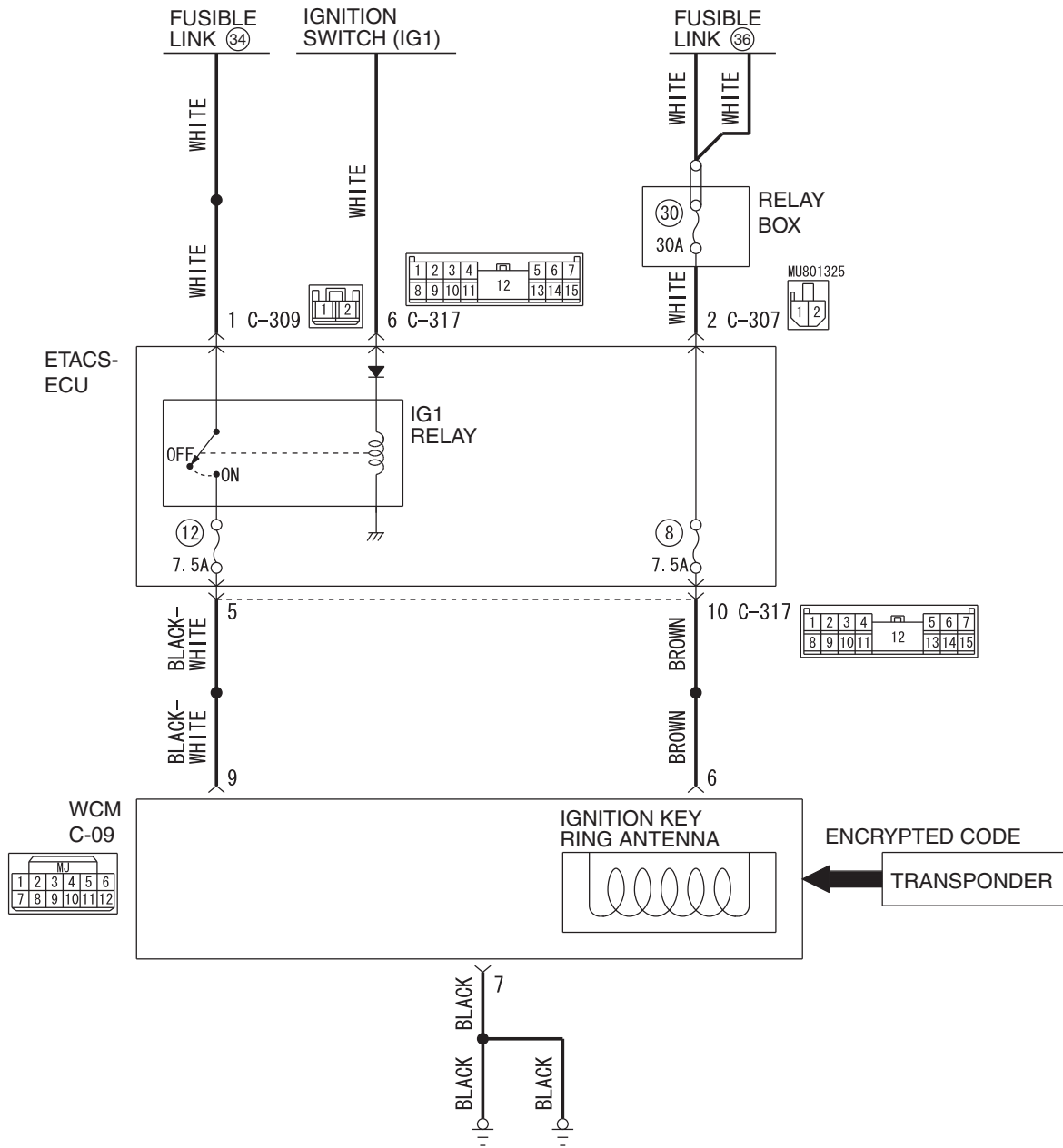

Connector: C-09

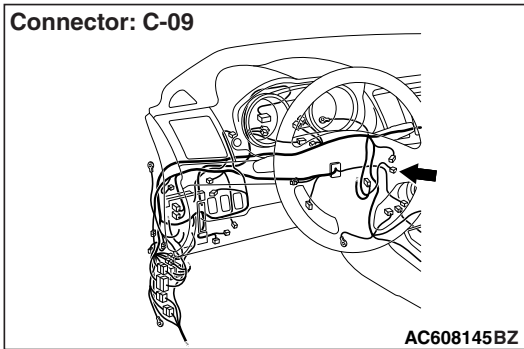

### TECHNICAL DESCRIPTION (COMMENT)

If the WCM does not work at all or if the WCM cannot communicate with the scan tool, the WCM power supply or the ground circuit may be defective.

### TROUBLESHOOTING HINTS

- Damaged wiring harness and connectors
- Malfunction of the WCM

Connectors: C-307, C-309, C-317  
Junction block

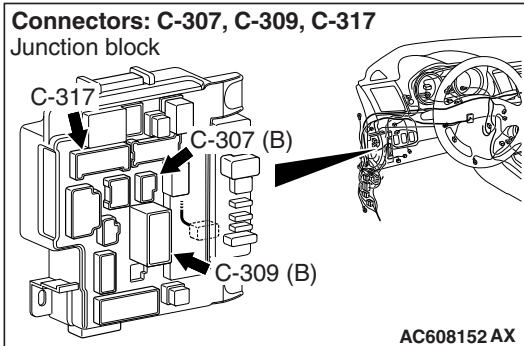

### DIAGNOSIS

#### Required Special Tools:

- MB992006: Extra fine probe
- MB991223: Harness set

**STEP 1. Check WCM connector C-09 and ETACS-ECU connector C-317 for loose, corroded or damaged terminals, or terminals pushed back in the connector.**

**Q: Is the WCM connector C-09 and ETACS-ECU connector C-317 in good condition?**

**YES :** Go to Step 2.

**NO :** Repair the defective connector.

**STEP 2. Check the wiring harness between WCM connector C-09 (terminal No.6, 9) and the ETACS-ECU connector C-317 (terminal No.10, 5) for open circuit.**

- (1) Disconnect WCM connector C-09 and ETACS-ECU connector C-317, and check the wiring harness.
- (2) Check the wiring harness between WCM connector C-09 (terminal No.6) and ETACS-ECU connector C-317 (terminal No.10)

**OK: Continuity exists (2 Ω or less)**

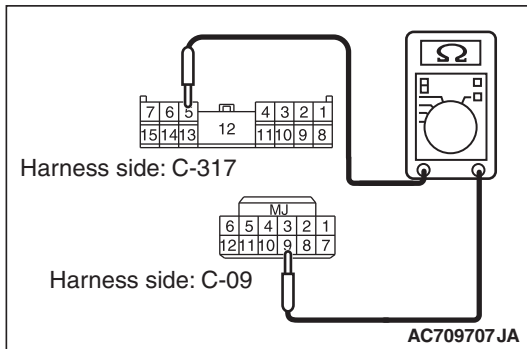
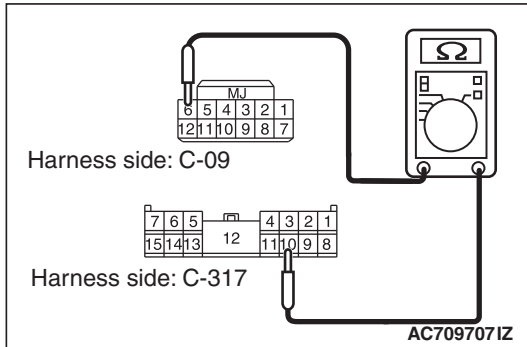

- (3) Check the wiring harness between WCM connector C-09 (terminal No.9) and ETACS-ECU connector C-317 (terminal No.5)

**OK: Continuity exists (2 Ω or less)**

**Q: Is the wiring harness between WCM connector C-09 and the ETACS-ECU connector C-317 in good condition?**

**YES :** Go to Step 3.

**NO :** Repair the wiring harness between WCM connector C-09 (terminal No.6, 9) and ETACS-ECU connector C-317 (terminal No.10, 5).

**STEP 3. Check the wiring harness between the WCM connector C-09 (terminal No.7) and the ground for open circuit.**

- (1) Disconnect the connector and measure the resistance at the wiring harness side.
- (2) Measure the resistance between terminal No.7 and the ground.

**OK: Continuity exists (2 Ω or less)**

**Q: Is the wiring harness between WCM connector C-09 and the ground in good condition?**

**YES :** Go to Step 4.

**NO :** Repair the wiring harness between WCM connector C-09 (terminal No.7) and ground.

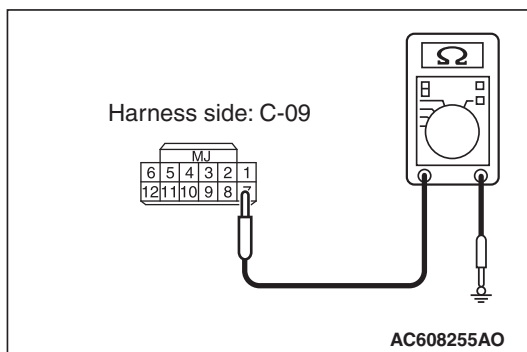

---

**STEP 4. Retest the system**

**Q: Does the abnormality in WCM power supply and ground circuits in good condition?**

**YES :** The trouble can be an intermittent malfunction (Refer to GROUP 00, How to use Troubleshooting/inspection Service Points - How to Cope with Intermittent Malfunction [P.00-13](#)).

**NO :** Replace WCM and register the ID codes (Refer to [P.42C-10](#)).

---

**Inspection Procedure 5: Keyless entry system does not work.**

---

**⚠ CAUTION**

Before replacing the ECU, ensure that the power supply circuit, the ground circuit and the communication circuit are normal.

**TECHNICAL DESCRIPTION (COMMENT)**

The lock/unlock signals from the transmitter are received by WCM, and then sent to ETACS-ECU from WCM. When ETACS-ECU receives signals from the key reminder switch and all the door switches, ETACS-ECU actuates the keyless entry system.

**TROUBLESHOOTING HINTS**

- The key reminder switch may be defective
- The door switches may be defective
- The liftgate latch assembly may defective
- The keyless entry transmitter may be defective
- The WCM may be defective
- The ETACS-ECU may be defective
- The wiring harness or connectors may have loose, corroded, or damaged terminals, or terminals pushed back in the connector
- Option coding information

**DIAGNOSIS**

**Required Special Tools:**

- MB992006: Extra fine probe
- MB991223: Harness set
- MB991958 Scan Tool (M.U.T.-III Sub Assembly)
  - MB991824: Vehicles Communication Interface (V.C.I.)
  - MB991827 M.U.T.-III USB Cable
  - MB991910 M.U.T.-III Main Harness A

**STEP 1.** Using scan tool MB991958, check for CAN bus the diagnostic trouble code.

**⚠ CAUTION**

To prevent damage to scan tool MB991958, always turn the ignition switch to the "LOCK" (OFF) position before connecting or disconnecting scan tool MB991958.

- (1) Connect scan tool MB991958. Refer to "How to connect scan tool (M.U.T.-III) P.42C-7."
- (2) Turn the ignition switch to the "ON" position.
- (3) Check whether the CAN bus lines related DTC is set.
- (4) Turn the ignition switch to the "LOCK" (OFF) position.

**Q: Is the DTC set?**

**YES :** Repair the CAN bus line (Refer to GROUP 54C, CAN bus diagnostics table P.54C-14).

**NO :** Go to Step 2.

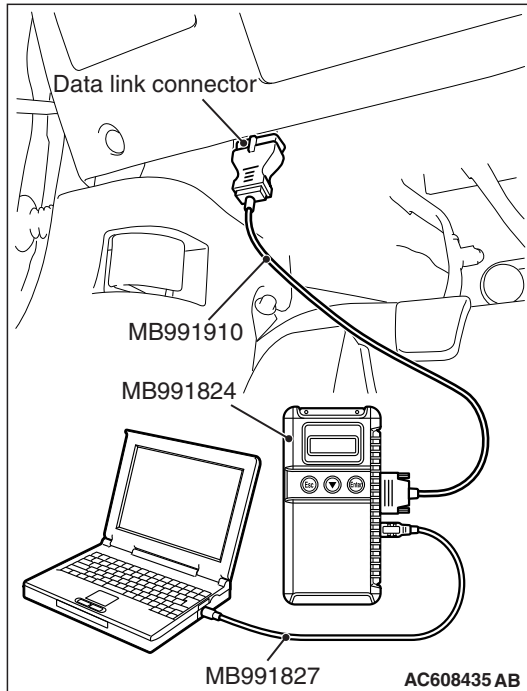

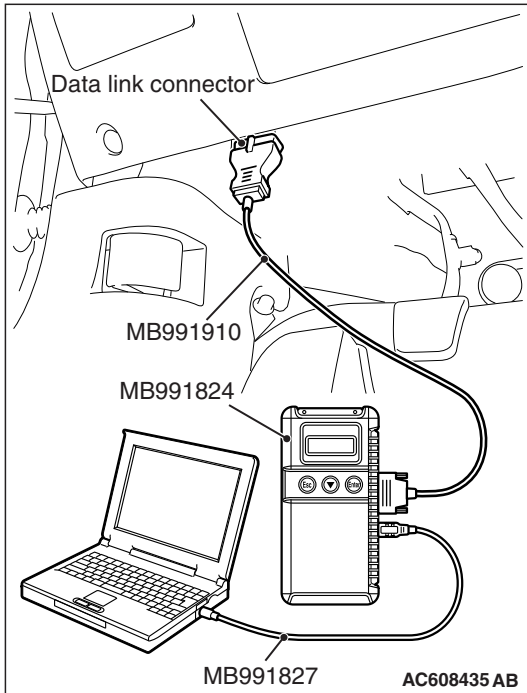

**STEP 2. Using scan tool MB991958, read the diagnostic trouble code.**

**⚠ CAUTION**

To prevent damage to scan tool MB991958, always turn the ignition switch to the "LOCK" (OFF) position before connecting or disconnecting scan tool MB991958.

- (1) Connect scan tool MB991958. Refer to "How to connect scan tool (M.U.T.-III) P.42C-7."
- (2) Turn the ignition switch to the "ON" position.
- (3) Check whether the ETACS-ECU related DTC is set.
- (4) Turn the ignition switch to the "LOCK" (OFF) position.

**Q: Is the DTC set?**

- YES** : Diagnose the ETACS-ECU. Refer to P.42C-18.  
**NO** : Go to Step 3.

**STEP 3. Check the power supply system**

With the ignition switch in the LOCK (OFF) position, check if the following function operates normally:

- Hazard warning light

**Q: Is the check result normal?**

- YES** : Go to Step 4.  
**NO** : Refer to GROUP 54A –Malfunction of ETACS-ECU power supply circuit P.54A-727.

**STEP 4. Verify the central door locking system.**

Check that the central door locking system works normally.

**Q: Is the check result normal?**

- YES** : Go to Step 5.  
**NO** : Refer to GROUP 42A –Troubleshooting P.42A-31.

**STEP 5. Using scan tool MB991958, check data list.**

Check the signals related to the keyless entry system operation.

**⚠ CAUTION**

To prevent damage to scan tool MB991958, always turn the ignition switch to the "LOCK" (OFF) position before connecting or disconnecting scan tool MB991958.

(1) Connect scan tool MB991958. Refer to "How to connect the Scan Tool (M.U.T.-III) P.42C-7."

(2) Turn the ignition switch to the "LOCK" (OFF) position.

(3) Check the ETACS data list.

- Close the driver's door.
- Close the passenger's door.
- Close the RH-side rear door.
- Close the LH-side rear door.
- Close the liftgate.
- Remove the ignition key from the ignition key cylinder.

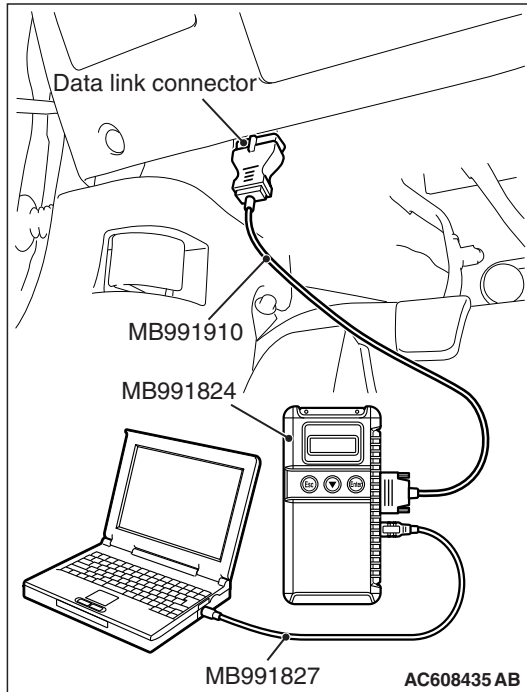

Item No.	Item name	Normal condition
Item 256	Dr door ajar switch	Close
Item 257	As door ajar switch	Close
Item 258	RR door ajar switch	Close
Item 259	RL door ajar switch	Close
Item 260	Trunk/gate trunk ajar switch	Close
Item 264	Handle lock switch	Key in →Key out

**OK:** Normal condition are displayed.

**Q:** Are the check result normal?

**YES** <Normal conditions are displayed for all the items.> : Go to Step 6.

**NO** <Normal condition is not displayed for item No. 256.> : Refer to GROUP 54A, Inspection Procedure 5: ETACS-ECU does not receive any signal from the front door switch (LH) P.54A-749.

**NO** <Normal condition is not displayed for item No. 257.> : Refer to GROUP 54A, Inspection Procedure 6: ETACS-ECU does not receive any signal from the front door switch (RH) P.54A-747.

**NO** <Normal condition is not displayed for item No. 258.> : Refer to GROUP 54A, Inspection Procedure 8: ETACS-ECU does not receive any signal from the rear door switch (RH) P.54A-754.

**NO** <Normal condition is not displayed for item No. 259.> : Refer to GROUP 54A, Inspection Procedure 7: ETACS-ECU does not receive any signal from the rear door switch (LH) P.54A-752.



- NO <Normal condition is not displayed for item No. 260.>** : Refer to GROUP 54A –Inspection Procedure 9: The liftgate latch switch signal is not received [P.54A-757](#).
- NO <Normal condition is not displayed for item No. 264.>** : Refer to GROUP 54A, Inspection Procedure 3: ETACS-ECU does not receive any signal from the key reminder switch. [P.54A-737](#).

---

**STEP 6. Retest the system.**

Check if the keyless entry system works normally.

**Q: Is the check result normal?**

- YES** : Intermittent malfunction (Refer to GROUP 00 –How to Use Troubleshooting/Inspection Service Points - How to Cope with Intermittent Malfunction [P.00-13](#)).
- NO** : Replace WCM and register the ID codes (Refer to [P.42C-10](#)).

---

**Inspection Procedure 6: Keyless entry hazard light answerback function, the dome light answerback function or the horn answerback function does not work normally.**

---

**⚠ CAUTION**

Before replacing the ECU, ensure that the power supply circuit, the ground circuit and the communication circuit are normal.

**TECHNICAL DESCRIPTION (COMMENT)**

If the hazard warning light and the dome light works normally, ETACS-ECU may be faulty. Also, the answerback function may have been disabled using the customization function.

**TROUBLESHOOTING HINTS**

- The turn signal lights may be defective
- The dome light may be defective
- The horn may be defective
- The ETACS-ECU may be defective
- The wiring harness or connectors may have loose, corroded, or damaged terminals, or terminals pushed back in the connector

**DIAGNOSIS**

---

**STEP 1. Verify the operation hazard warning light.**

Check that the hazard warning light illuminate normally.

**Q: Is the check result normal?**

- YES** : Go to Step 2.
- NO** : Refer to GROUP 54A –inspection procedure 1: "Hazard warning light does not illuminate [P.54A-307](#)."

---

**STEP 2. Verify the operation of the dome light.**

Check that the dome lights illuminate normally.

**Q: Is the check result normal?**

- YES** : Go to Step 3.
- NO** : Refer to GROUP 54A –inspection procedure 1 "The front dome light does not illuminate normally [P.54A-280](#)." or inspection procedure 2 "The rear dome light does not illuminate normally [P.54A-286](#)."

**STEP 3. Verify the horn.**

Check that the horn normally.

**Q: Is the check result normal?**

**YES** : Go to Step 4.

**NO** : Replace the horn (Refer to GROUP 54A, Horn [P.54A-309](#)).

**STEP 4. Check the operation of the keyless entry system.**

Operate the transmitter and check that all doors lock and unlock.

**Q: Is the check result normal?**

**YES** : Go to Step 5.

**NO** : Refer to inspection procedure 5: "Keyless entry system does not work [P.42C-93](#)."

**STEP 5. Check the customize function (Hazard light answerback).**

Check that any one of the followings other than "Lock: 0, Unlock: 0" is set for "Hazard answerback" with a customization function.

- Lock:1, Unlock:2
- Lock:1, Unlock:0
- Lock:0, Unlock:2
- Lock:2, Unlock:1
- Lock:2, Unlock:0
- Lock:0, Unlock:1

**Q: Is the check result normal?**

**YES** : Go to Step 6.

**NO** : Set "Hazard answerback" to any one other than "Lock: 0, Unlock: 0" with a customization function (Refer to [P.42C-115](#)).

**STEP 6. Check the customize function (Horn answerback).**

Check that any one of the followings other than "Not sound horn" is set for "Horn chirp by keyless" with a customization function.

- Lock any time
- W lock any time

**Q: Is the check result normal?**

**YES** : Go to Step 7.

**NO** : Set "Horn chirp by keyless" to any one other than "Not sound horn" with a customization function (Refer to [P.42C-115](#)).

**STEP 7. Check of the troubles**

Check if the keyless entry answerback function works normally.

**Q: Is the check result normal?**

**YES** : Intermittent malfunction (Refer to GROUP 00, How to Use Troubleshooting/Inspection Service Points - How to Cope with Intermittent Malfunction [P.00-13](#)).

**NO** : Replace ETACS-ECU.

---

**Inspection Procedure 7: The timer lock function does not work after the doors have been unlocked by the keyless entry system.**

---

**⚠ CAUTION**

Before replacing the ECU, ensure that the power supply circuit, the ground circuit and the communication circuit are normal.

**TECHNICAL DESCRIPTION (COMMENT)**

If the timer lock function does not work normally, the keyless entry transmitter input signal circuit or ETACS-ECU may be faulty.

**TROUBLESHOOTING HINTS**

- The keyless entry transmitter may be defective
- The ETACS-ECU may be defective
- The wiring harness or connectors may have loose, corroded, or damaged terminals, or terminals pushed back in the connector

**DIAGNOSIS**

---

**STEP 1. Check the operation of the keyless entry system.**

Operate the transmitter and check that all doors lock and unlock.

**Q: Is the check result normal?**

**YES :** Go to Step 2.

**NO :** Refer to inspection procedure 5: "Keyless entry system does not work [P.42C-93](#)."

---

**STEP 2. Check the customize function.**

The "Timer lock timer" has been set to one of the followings with the customization function. Check if the doors are locked at the set period.

- 30sec
- 60sec
- 120sec
- 180sec

**Q: Is the check result normal?**

**YES :** Intermittent malfunction (Refer to GROUP 00 –How to Use Troubleshooting/Inspection Service Points - How to Cope with Intermittent Malfunction [P.00-13](#)).

**NO :** Replace ETACS-ECU.

**Inspection Procedure 8: Power door locks with selective unlocking does not work.****CAUTION**

Before replacing the ECU, ensure that the power supply circuit, the ground circuit and the communication circuit are normal.

**COMMENT ON TROUBLE SYMPTOM**

If the keyless entry system works normally and only the power door locks with selective unlocking does not work normally, ETACS-ECU may be defective. In addition, it is possible that the function has been disabled by using the customization function.

**PROBABLE CAUSES**

- Malfunction of ETACS-ECU
- Damaged wiring harness and connectors

**DIAGNOSTIC PROCEDURE****STEP 1. Check the customization**

**Q: Are the power door locks with selective unlocking enabled by the customization function?**

**YES :** Go to Step 2.

**NO :** Set the power door locks with selective unlocking to "Enabled" by using the customization function. Refer to [P.42C-115](#).

**STEP 2. Keyless entry system operation check**

Press the unlock button of the transmitter and check that only the driver's door is unlocked. Then, press the unlock button once again within 2 seconds after that to check that the front passenger's door, rear doors, and liftgate are unlocked.

**Q: Does the keyless entry system work normally?**

**YES :** Go to Step 3.

**NO (Only the driver's door is not unlocked.) :** Replace the ETACS-ECU.

**NO (The driver's door, front passenger's door, rear doors, and liftgate are not unlocked.) :** Refer to Inspection Procedure 5: "Keyless entry system does not work [P.42C-93](#)."

**STEP 3. Check of the troubles**

Check that the power door locks with selective unlocking works normally.

**Q: Is the check result normal?**

**YES :** Intermittent malfunction (Refer to GROUP 00 –How to Use Troubleshooting/Inspection Service Points –How to Cope with Intermittent Malfunction [P.00-13](#)).

**NO :** Replace ETACS-ECU.

**CHECK AT ECU TERMINALS**

M1427500900197

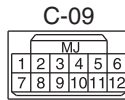

AC507349AE

Terminal No.	Check items	Check conditions	Normal conditions
1 -5	-	-	-
6	Power supply (Battery)	Always	Battery positive voltage
7	Ground	Always	1 V or less
8	-	-	-
9	Power supply (Ignition switch: IG1)	Ignition switch: ON	Battery positive voltage
10	CAN L	-	-
11	CAN H	-	-

## ON-VEHICLE SERVICE

### ID CODES REGISTRATION PROCEDURE

M1427506300579

### REGISTRATION USING SCAN TOOL MB991958 (M.U.T.-III SUB ASSEMBLY)

**Required Special Tools:**

- MB991958 Scan Tool (M.U.T.-III Sub Assembly)
  - MB991824: Vehicle Communication Interface (V.C.I.)
  - MB991827 M.U.T.-III USB Cable
  - MB991910 M.U.T.-III Main Harness A

The ID codes necessary for the engine immobilizer system, the keyless entry system and the TPMS can be registered using the scan tool MB991958 (M.U.T.-III sub assembly). KOS and keyless operation key are indicated as F.A.S.T and F.A.S.T.-key respectively in the scan tool MB991958 (M.U.T.-III sub assembly) screen.

**⚠ CAUTION**

If the ignition key with transmitter is added or replaced, register the key (key ID), and then register the keyless ID again.

**⚠ CAUTION**

Do not register the ignition key registered for other vehicles.

**SUPPLY UNIT LIST FOR INDIVIDUAL KEY**

<p>Ignition key (with transmitter)</p>  <p>AC709991</p>
---

**KEY SUPPLY UNIT LIST FOR OTHER THAN INDIVIDUAL KEY**

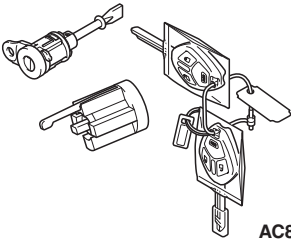
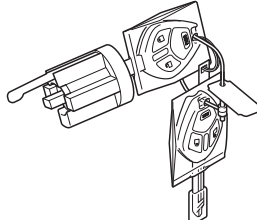
<p>Full service key set</p>  <p>AC807904</p>	<p>Handle lock service key set</p>  <p>AC807905</p>
---	---

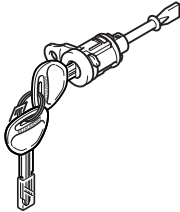
<p>Door service key set (It can only be used for locking and unlocking, and it cannot start the engine.)</p>  <p>AC702143</p>
---

**NOTE:**

- When re-registering the key (key ID and keyless ID), all the keys (key ID and keyless ID) registered before must be re-registered because all of them will be erased.
- After registering the keys, make sure that the engine is started normally with all of the keys registered.

Screen flow of scan tool MB991958 (M.U.T.-III sub assembly)

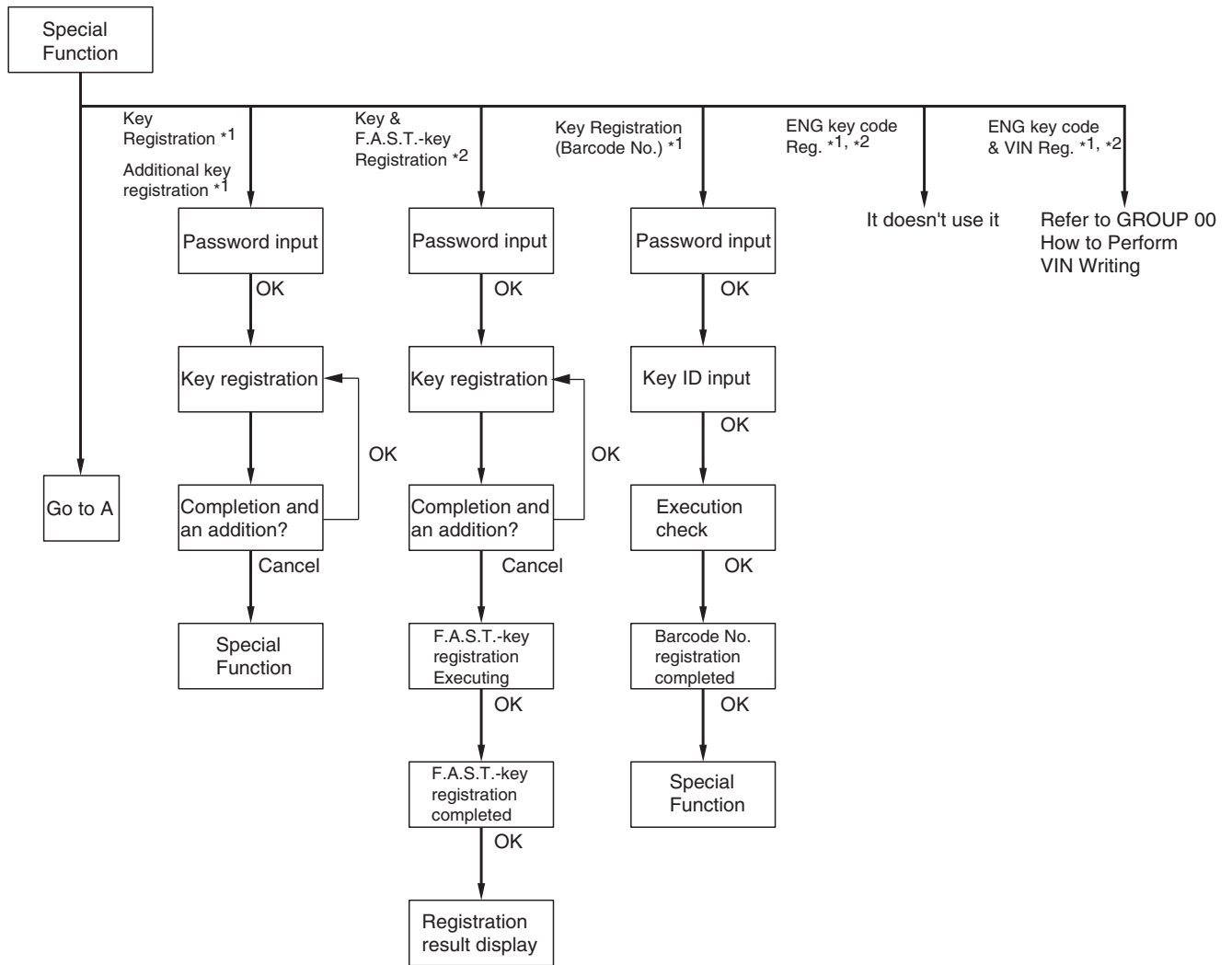

NOTE:  
 \*1 Show the menu displayed when the vehicles for WCM.  
 \*2 Show the menu displayed when the vehicles for KOS.

AC802951AB

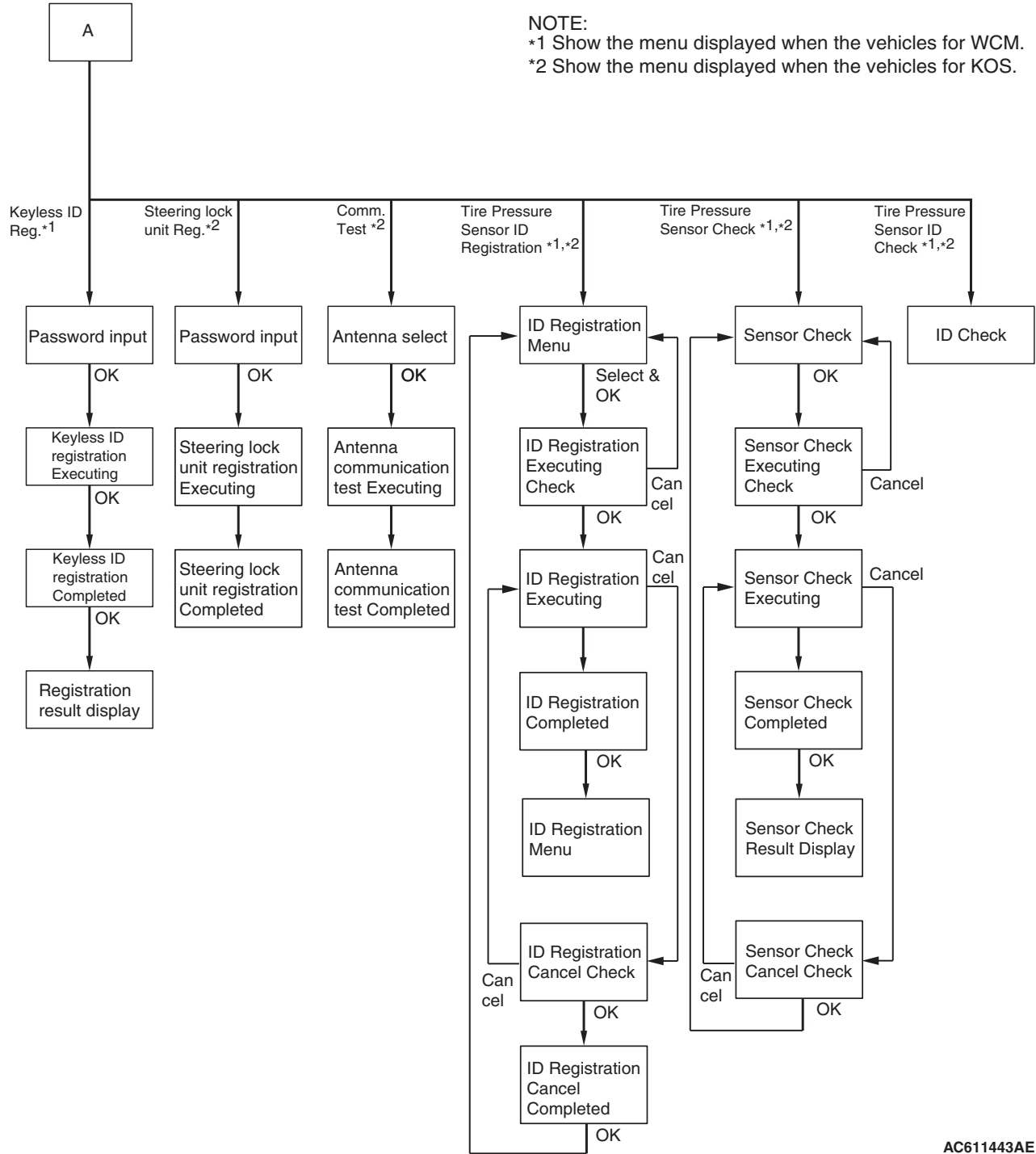

AC611443AE



**CAUTION**

To prevent damage to scan tool MB991958, always turn the ignition switch to the "LOCK" (OFF) position before connecting or disconnecting scan tool MB991958.

Connect the scan tool to the 16-pin data link connector as follows.

*NOTE: For details on how to use the scan tool, refer to the "M.U.T.-III User's Manual."*

1. Start the scan tool MB991958 system on the personal computer and turn the ignition switch to the "ON" position.

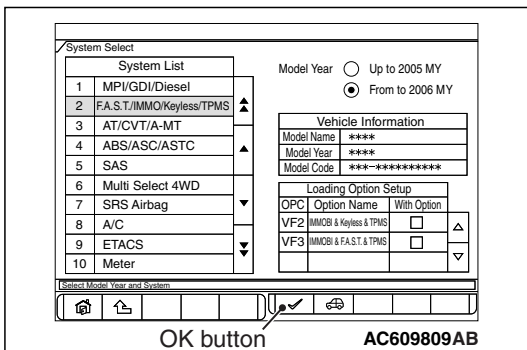
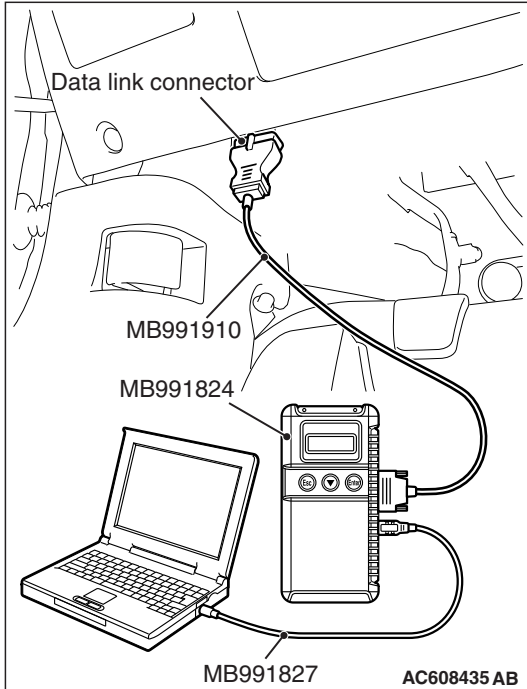

2. Select "F.A.S.T./IMMO/Keyless/TPMS" button from the "System Select" screen. Then, select the applicable option code item and push the OK button.

3. Select "Special Function" on the next screen.

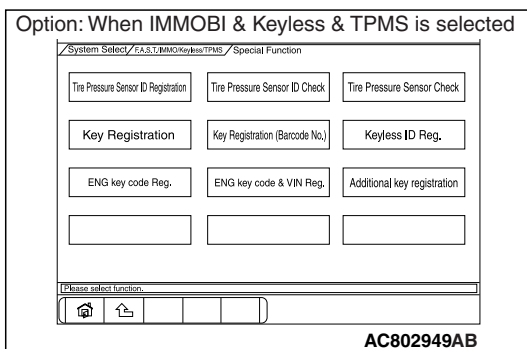

4. Select the button of the operation to be performed from the "Special Function" screen.

- "Tire Pressure Sensor ID Registration": When the TPMS transmitter is replaced and/or the WCM is replaced.
- "Tire Pressure Sensor Check": When the tire pressure sensor data is checked.
- "Tire Pressure Sensor ID Check": When the tire pressure sensor ID is checked.
- "Key Registration": When the ignition key is replaced or added as a single unit and/or the WCM replaced.
- "Key Registration (Barcode No.)": When the ignition key is replaced by the full service key set. The handle lock service key set is replaced by the piece.
- "Keyless ID Reg.": When the ignition key is replaced or added as a single unit and the immobi and keyless key assembly.
- "ENG Key Code Reg.": It doesn't use it.
- "ENG Key Code & VIN Reg.": When the engine control module is replaced.
- "Additional key registration": When the ignition key is added as a single unit.

*NOTE: For "ENG Key Code & VIN Reg," refer to GROUP 00 -Precautions before Service P.00-24.*

- After operation check, turn the ignition switch to the "LOCK" (OFF) position.
- Remove the scan tool MB991958.

## "KEY REGISTRATION"/"ADDITIONAL KEY REGISTRATION" METHOD

- When "Key registration" or "Additional key registration" screen is displayed, enter the password for the key registration and press the OK button. Then, "Executing!" is displayed and the registration process starts.

*NOTE:*

- If the wrong password is entered consecutively 5 times, the password entry for the key registration will be disabled for 16 minutes.*
- The key registration cannot be cancelled during the operation.*

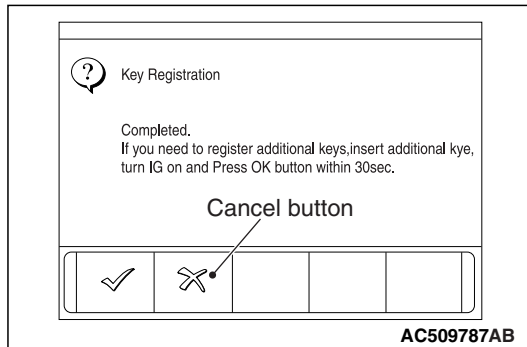
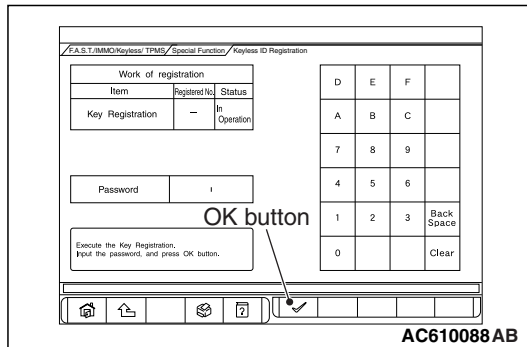

- When the key registration is completed, "Completed" is displayed. To register the next key, follow the message on the screen and press the OK button. Then, "Executing!" is displayed again and the registration process for the next key starts. To finish the key registration, press the cancel button.

*NOTE:*

- In order to register another key consecutively after registering the first key, the ignition switch must be turned to the ON position with the second key within 30 seconds after turning it to the "LOCK" (OFF) position with the first key.*
- Up to eight keys can be registered.*
- When the key cannot be registered using scan tool MB991958, refer to Inspection Procedure 2 "The ignition key cannot be registered using scan tool P.42C-86.*

**"KEY REGISTRATION (BARCODE NO.)" METHOD**

1. When "Key Registration (Barcode No.)" screen is displayed, enter the password for the key registration and press the OK button.

*NOTE: If the wrong password is entered consecutively 5 times, the password entry for the key registration will be disabled for 16 minutes.*

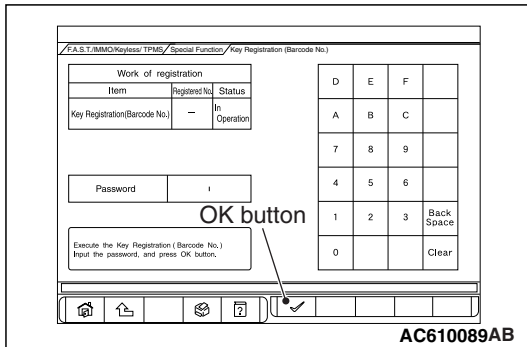
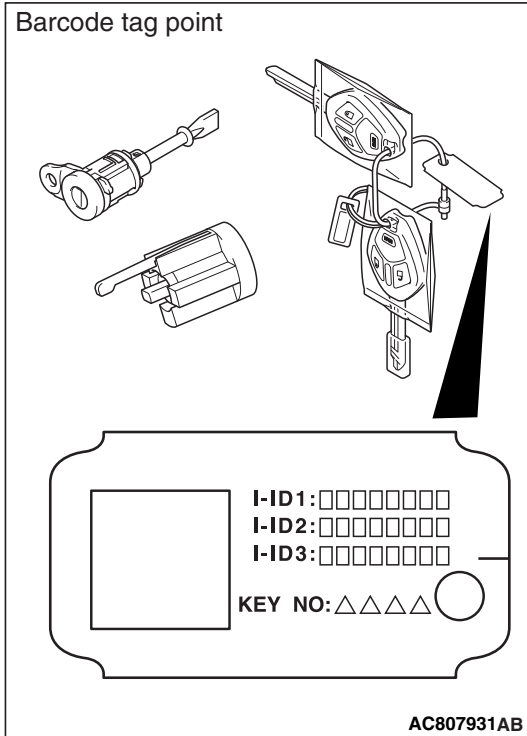

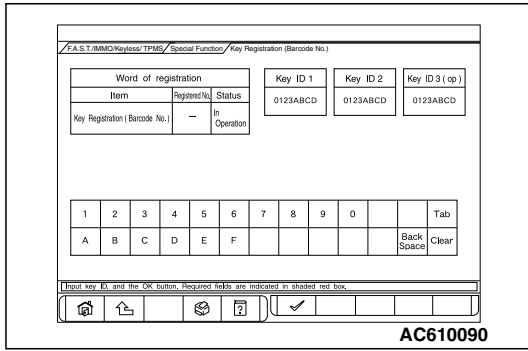

2. Follow the message on the screen to enter the bar code No., and then press the OK button.
3. When "Do you want to start?" is displayed, press the OK button to start the registration, or press the Cancel button to cancel the registration.
4. "Completed" is displayed. Press the OK button to finish the registration.

**NOTE:** When the key cannot be registered using scan tool MB991958, refer to Inspection Procedure 2 "The ignition key cannot be registered using scan tool P.42C-86."

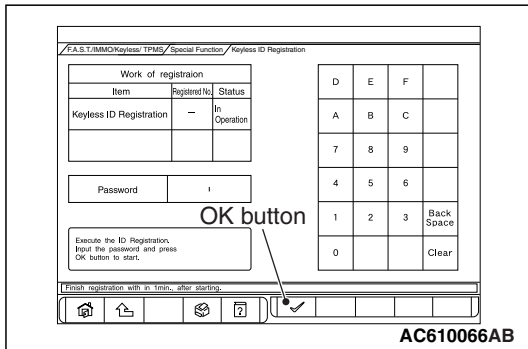
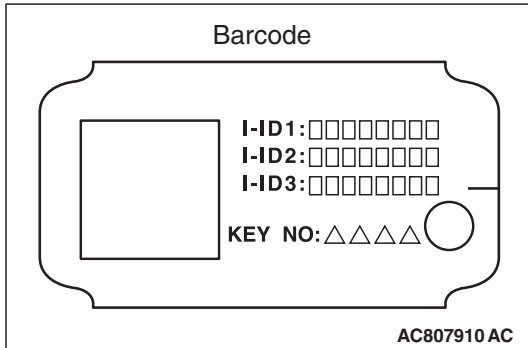

**"KEYLESS ID REG." METHOD**

1. On the "Keyless ID Reg." screen, enter the password and press the OK button.
2. Register within 1 minute and send the programming packet\* to register the keyless ID. To register multiple keys, register the next key within 1 minute from the registration operation of previous key. Complete the registration of necessary keys, then press the OK button to finish the keyless ID registration.

**NOTE:**

- Up to eight ignition keys can be registered.
- \*: Programming packet sending procedure  
Complete the following steps 1 to 3 within four seconds.
  1. Press and hold both the lock and the unlock switch for 1 second or longer.
  2. Release both the lock and the unlock switch for 0.5 second or longer.
  3. Press the unlock switch.

3. Push the OK button after "Keyless ID Registration was finished." is displayed.

The screenshot shows a software interface for WCM registration. At the top, it says 'F.A.S.T./MMIO/Keyless TPMS /Special Function/ Keyless ID Registration'. Below this is a table titled 'Work of registration' with columns 'Item', 'Registered No.', and 'Status'. The first row shows 'Keyless ID Registration' with '4' in the 'Registered No.' column and 'Completed' in the 'Status' column. To the right of this table is a numeric keypad with letters A-F above the numbers 1-9, and 'Back Space' and 'Clear' at the bottom. Below the keypad is a 'Password' field with four asterisks. At the bottom left, there is a text box that says 'Check the number of registration.' and a set of navigation icons. The part number 'AC610067' is printed at the bottom right of the screenshot.

4. Check number of the keyless IDs registered.

## "TIRE PRESSURE SENSOR ID REGISTRATION" METHOD

1. Select "4tires ID Reg. (Change tire PRS.)" and start the tire pressure sensor ID registration.

### **CAUTION**

**Register all tire pressure sensor IDs within twenty minutes.**

2. "4 SNSR ID Registration Do you want to start? Note Finish ID Registration within 20 minutes." is displayed. Then, press "OK."

*NOTE: If the ID code registration is not finished within 20 minutes, all the ID codes registered in the TPMS transmitter before will be erased. For this reason, the ID codes need to be registered again.*

3. Decrease the tire pressure to 174 kPa (25.2 psi) or less by changing 20 kPa (2.9 psi) or more, and register the TPMS transmitter ID code of each wheel to WCM.

### **NOTE:**

- You can start out the operations from any TPMS transmitter. The tire pressure sensor ID registration has no order.
- On completion of the TPMS transmitter ID code registration, the TPMS transmitter ID code is displayed on the scan tool screen.
- Scan tool cannot identify which registered TPMS transmitter is used for each wheel. For this reason, write down the tire number for each wheel when the tire number and ID code is displayed on the scan tool during ID code registration.
- It may take approximately one minute for the ID code to be displayed on the scan tool screen after the tire pressure is reduced.
- If the ID code is not displayed, reduce the tire pressure another 20 kPa (2.9 psi) or more. If the ID code is not displayed yet, rotate the tire to displace the TPMS transmitter, and reduce the tire pressure 20 kPa (2.9 psi) or more again.
- If the ID code cannot be registered for all the four wheels, the WCM may be faulty, thus replace the WCM.

- *If the ID code can be registered for one wheel or more, the TPMS transmitter in which the code cannot be registered may be faulty, thus replace that TPMS transmitter.*
4. "4 SNSR ID Registration Completed." is displayed. Then, select "OK."

*NOTE: The TPMS indicator illuminates for tire pressure alarm.*

5. After one minute or more has passed, correct the tire pressure for all wheels with ignition switch "ON".
6. Check the data list "Registered ID reception, Tire 1, 2, 3, 4" if "YES" is displayed for each tire. When "NO" is displayed, drive the vehicle for approximately 5 minutes, check the display again. If "NO" is still displayed, register the ID code again.

### **"TPMS TRANSMITTER CHECK" METHOD**

According to the following procedures, identify which registered TPMS transmitter corresponds to which wheel, and check the tire pressure and acceleration value of each TPMS transmitter.

1. Check the data list "Air Pressure, Tire1, 2, 3, 4" and write down the tire pressure for all wheels.

*NOTE: The display at this time is the data received most recently.*

2. Perform the following procedures for four wheels in order, identify the wheel by checking the tire pressure of each wheel.
  - (1) Change the pressure of tire for 20 kPa (2.9 psi) or more so that the TPMS transmitter sends the latest sensor data (The tire pressure can either be decreased or increased).
  - (2) Check the data list screen to determine which tire number corresponds to the wheel whose tire pressure has changed.

**NOTE:**

- *It may take approximately one minute that the data of tire pressure change is displayed on the scan tool screen.*
- *If the data of tire pressure change is not displayed on the scan tool screen, the most possible cause is that the radio wave sent from the TPMS transmitter cannot be received. In this case, the radio wave may be received by performing the procedures from (1) again after turning the tire to change the TPMS transmitter position. If the tire pressure change is still not displayed on the scan tool screen, the TPMS transmitter in which the ID code is not registered may be installed, or the TPMS transmitter may be faulty. Therefore, perform ID code registration or replace the TPMS transmitter according to the instructions of troubleshooting for DTCs. (At this time, do not register the ID codes or replace the TPMS transmitter.)*

3. Check the tire pressure or acceleration value shown in the screen (if needed).

- After checking by the tire pressure change, adjust the checked tire pressure to the proper value.

### "TIRE PRESSURE SENSOR ID CHECK" METHOD

- Select "Tire Pressure Sensor ID Check".
- Check the registered TPMS transmitter IDs on the scan tool screen.

### REGISTRATION NOT USING SCAN TOOL MB991958 (M.U.T.-III SUB ASSEMBLY) <USA ONLY>

When the ignition key is lost or additional keys are requested, the ignition key must be used to register key ID.

#### **CAUTION**

**Two ignition keys that have been registered are needed.**

- Turn the ignition switch to the "ON" position using the registered ignition key and keep it there for 5 seconds.
- Turn the ignition switch to the "LOCK" (OFF) position, and remove the registered ignition key.
- Within 30 seconds after the ignition key is removed, insert the other registered ignition key that has already been registered and turn the ignition switch to the "ON" position.
- The immobilizer indicator starts flashing in approximately 10 seconds after the ignition switch is turned to the "ON" position.
- When the immobilizer indicator starts flashing, turn the ignition switch to the "LOCK" (OFF) position and remove the ignition key.  
*NOTE: When an error occurs while the immobilizer indicator is flashing, the immobilizer indicator extinguishes.*
- Within 30 seconds after the immobilizer indicator flashes in Step 5, insert the ignition key to be added and turn the ignition switch to the "ON" position.
- When registering another ignition key, repeat the procedure from the beginning.

*NOTE:*

#### **<When the additional ignition key cannot be registered>**

- When the immobilizer indicator is not illuminated during registration
- When the immobilizer indicator does not change in 3 seconds after carrying out step 6

#### **<When the additional registration of the ignition key terminates automatically>**

- When 30 seconds have passed before inserting the ignition key in Step 3 after the ignition key is removed in Step 2.
- When 30 seconds have passed after the immobilizer indicator flashed

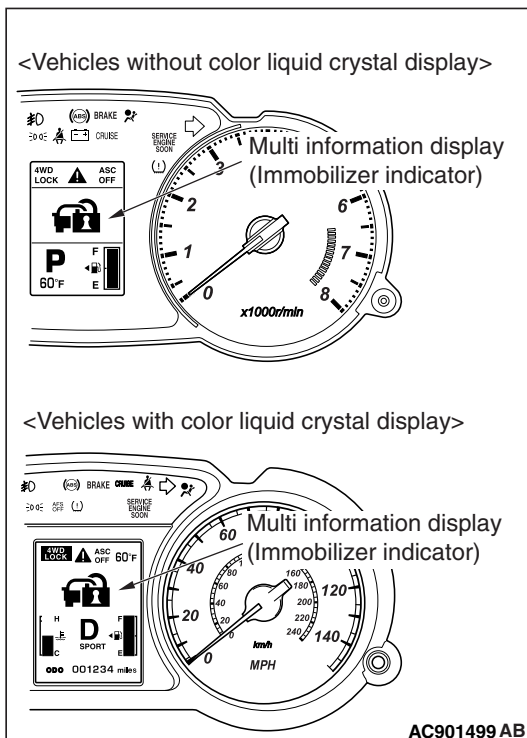

**KEYLESS ID NOT USING SCAN TOOL MB991958  
(M.U.T.-III SUB ASSEMBLY) <USA ONLY>**

When the keyless ID code is already registered in the transmitter, the keyless ID code can be registered without using the scan tool MB991958 (M.U.T.-III sub assembly) according to the following procedures.

1. Prepare all the transmitters for ID code registration before starting the operation.
2. Press the unlock button of the transmitter in which the keyless ID code is registered.
3. After pressing the unlock button, press the lock button within 4 seconds to less than 10 seconds.
4. Release the lock button within 10 seconds after pressing it.
5. Release the unlock button 0.5 seconds after releasing the lock button.

*NOTE: The WCM erases the keyless ID codes of the transmitters other than the operated transmitter.*

*NOTE: The WCM sets the transmitter registration number to 1.*

6. When the operations from Step 1 to Step 4 are completed, the door can be locked or unlocked, and the mode shifts to the customer-programming mode. Within 1 minute after the mode shifted to the customer-programming mode, the signal for registration is transmitted from the transmitter to be added.

*NOTE: How to transmit the transmitter registration signal*

1. Press the lock button and the unlock button of the transmitter to be added for 1 second or more simultaneously.
2. Release the lock button and the unlock button simultaneously.
3. After releasing the lock button and unlock button simultaneously, when 0.5 seconds or more has elapsed, press the unlock button.

*NOTE: The WCM receives the registration signal, and stores the keyless ID code of the transmitter.*

*NOTE: The WCM adds the transmitter registration number by 1.*

7. When the operation of Step 5 is finished, the door can be locked or unlocked to notify that the transmitter registration is completed.
8. To register another transmitter, repeat the operation of Step 5 within 1 minute after the previous transmitter registration.



9. The customer-programming mode is terminated by any of the following conditions.
- When the registration of 8 transmitters are completed
  - When 1 minute has elapsed without registration after the shift to the customer-programming mode
  - when 1 minute has elapsed after previous transmitter registration
  - When the engine speed is more than 200 rpm
  - The EEPROM abnormality occurs [When the EEPROM abnormality occurs during the transmitter registration, delete all the transmitters stored (including the transmitters used for the shift to the customer-programming mode), and finish the customer-programming mode.]

### TPMS TRANSMITTER CHECK

M1427509000027

Refer to ID codes registration procedure [P.42B-198](#).

### TPMS TRANSMITTER ID CHECK

M1427509100024

Refer to ID codes registration procedure [P.42B-198](#).

### KEYLESS ENTRY SYSTEM CHECK

M1427505600168

Check the keyless entry system as described below. If it does not work, perform troubleshooting. Refer to [P.42C-84](#).

- Operate the transmitter to check that the doors and liftgate can be locked and unlocked.
- Operate the transmitter to check that the answerback function works in response to doors and liftgate locking/unlocking.

*NOTE: The hazard answerback setting can be changed using the customization function. Confirm which setting is activated before performing these checks. Refer to [P.42C-115](#).*

### INSPECTION OF KEYLESS ENTRY TIMER LOCK FUNCTION

M1427505800140

Attempt to unlock the doors and the liftgate by using the transmitter. If the doors and the liftgate are not locked within 30 seconds, carry out diagnosis. Note that the doors will not be locked if the ignition key is inserted within the 30-second period, or the doors and the liftgate are opened. Refer to [P.42C-84](#).

*NOTE: The operation time of the keyless entry timer lock function can be set using the customization function. Confirm the operation time before performing the diagnosis. Refer to [P.42C-115](#).*

**POWER DOOR LOCKS WITH SELECTIVE  
UNLOCKING INSPECTION**

M1427510800016

Press the unlock button on the transmitter once to unlock only the driver's door. Press the unlock button of the transmitter once again within 2 seconds after the driver's door is unlocked, and check that the front passenger's door, rear doors, and lift-gate are unlocked. If they are not unlocked, carry out troubleshooting. Refer to [P.42C-84](#).

*NOTE: Press the unlock button on the transmitter once to unlock only the driver's door. When the unlock button of the transmitter is pressed once again more than 2 seconds after the driver's door is unlocked, only the driver's door is unlocked.*

*NOTE: The setting of the power door locks with selective unlocking can be changed using the customization function. Confirm which setting is activated before performing these checks. Refer to [P.42C-115](#).*

**CUSTOMIZATION FUNCTION**

M1427504500470

By operating the ETACS system or MMCS of scan tool MB991958, the following functions can be programmed. The programmed information is held even when the battery is disconnected.

<b>Adjustment item (scan tool MB991958 display)</b>	<b>Adjustment item</b>	<b>Adjusting contents (scan tool MB991958 display)</b>	<b>Adjusting contents</b>
Hazard answer back	Adjustment of the number of keyless hazard warning light answer back flashes	Lock:1, Unlock:2	LOCK: Flashes once, UNLOCK: Flashes twice (initial condition)
		Lock:1, Unlock:0	LOCK: Flashes once, UNLOCK: No flash
		Lock:0, Unlock:2	LOCK: No flash, UNLOCK: Flash twice
		Lock:2, Unlock:1	LOCK: Flash twice, UNLOCK: Flash once
		Lock:2, Unlock:0	LOCK: Flash twice, UNLOCK: No flash
		Lock:0, Unlock:1	LOCK: No flash, UNLOCK: Flash once
		Lock:0, Unlock:0	No function
Dome light delay timer with door	Adjustment of interior light delay shutdown time	0sec	0 second
		7.5sec	7.5 seconds
		15sec	15 seconds
		30sec	30 seconds (initial condition)
		60sec	60 seconds
		120sec	120 seconds
		180sec	180 seconds
Welcome light	Disabling or enabling welcome light function <Vehicles with color liquid crystal meter>	Disabled	No function
		Small light	Tail light illuminates. (initial condition)
		Head light	Headlight illuminates.
Door unlock mode	Adjustment of power door locks with selective unlocking	All doors unlock	Without function: The first operation of keyless entry system or unlock operation by KOS unlocks all doors.
		Dr door unlock	With function: The first operation of keyless entry system or unlock operation by KOS unlocks the driver's door only, and the second unlock operation within 2 seconds after that unlocks all doors. (initial condition)

Adjustment item (scan tool MB991958 display)	Adjustment item	Adjusting contents (scan tool MB991958 display)	Adjusting contents
Auto door unlock	Adjustment of the auto door unlock function	Disabled	Without function (initial condition) <M/T, CVT, TC-SST>
		Always (P pos)	With function: Operates when the shift lever or the selector lever is moved to the P position. <CVT, TC-SST>
		P/W unlock (P)	With function: Operates when the shift lever or the selector lever is moved to the P position with the power window lock switch in the OFF position. <CVT, TC-SST>
		Always(Lock pos)	With function: Operates when the ignition switch is moved to the LOCK (OFF) position. <M/T, CVT, TC-SST>
		P/W unlock(Lock)	With function: Operates when the ignition switch is turned to the LOCK (OFF) position with the power window lock switch in the OFF position. <M/T, CVT, TC-SST>
Duration of horn chirp	Horn sounding time during horn answer back	Short	0.01 second (initial condition)
		Long	0.02 second
Horn chirp by keyless	Horn chirp by keyless entry system <vehicles without auto light>	Not sound horn	No horn answerback function
		Lock any time	The horn sounds when the lock button of keyless entry transmitter is pressed once.
		W lock any time	The horn sounds when the lock button of keyless entry transmitter is pressed twice. (initial condition)
	Horn chirp by keyless entry system <vehicles with auto light>	Not sound horn	No horn answerback function
		Lock any time	The horn sounds when the lock button of keyless entry transmitter is pressed once.
		Lock/auto ON	During daytime, while the lighting switch is in the AUTO position, the horn sounds once when the lock is pressed once.
		W lock any time	The horn sounds when the lock button of keyless entry transmitter is pressed twice. (initial condition)
	Timer lock timer	Timer lock period adjustment	30sec
60sec			60 seconds
120sec			120 seconds
180sec			180 seconds
Panic alarm switch	With/without panic alarm function	Disable	No function
		Enable	With function (initial condition)

# WCM

## REMOVAL AND INSTALLATION

M1427500800101

**CAUTION**

When WCM has been replaced, all key ID codes should be registered, referring to the ID code registration judgment table P.42C-10.

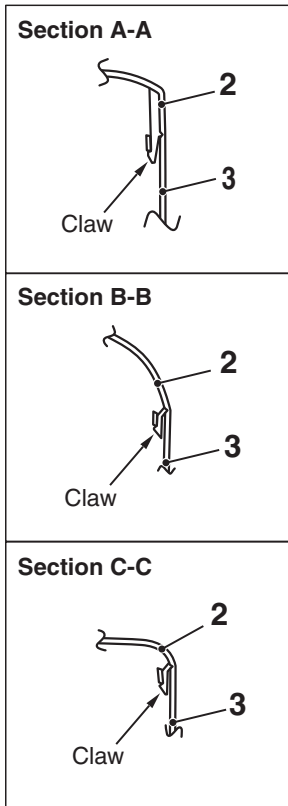

NOTE: Claw position is symmetrical

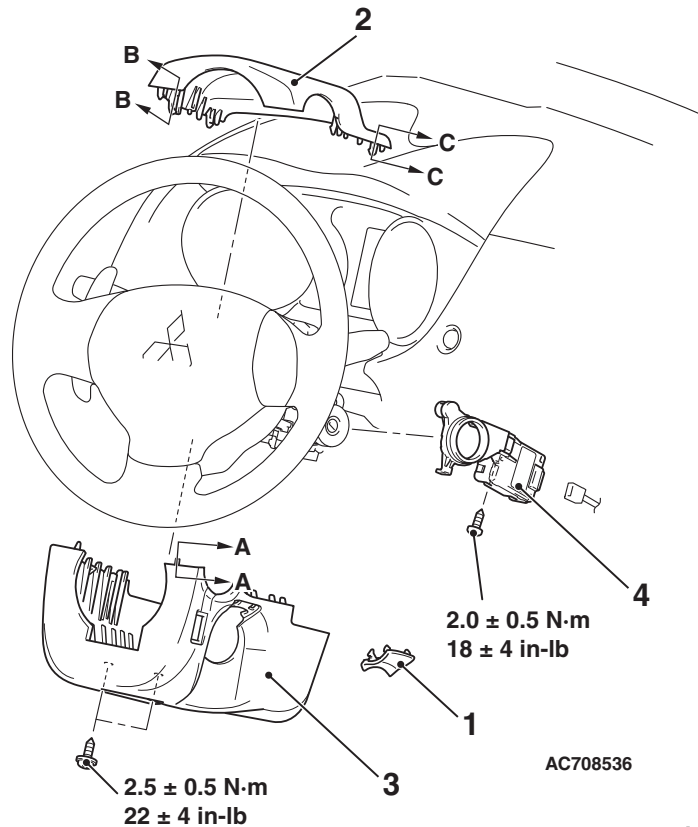

**Removal steps**

1. Ignition key cover
2. Steering column upper cover

**Removal steps (Continued)**

3. Steering column lower cover
- >>A<< 4. WCM

## INSTALLATION SERVICE POINT

### >>A<< WCM INSTALLATION

Check that the top claw of WCM is fixed securely to the boss of steering lock and the antenna is not floated on the key cylinder.

# TRANSMITTER

## DISASSEMBLY AND ASSEMBLY

M1427506100092

**⚠ WARNING**

**Coin-type lithium battery may contain perchlorate materials. Special handling may apply. For additional information, see [www.dtsc.ca.gov/hazardouswaste/perchlorate](http://www.dtsc.ca.gov/hazardouswaste/perchlorate).**

**Post-installation operation**

- Transmitter operation check

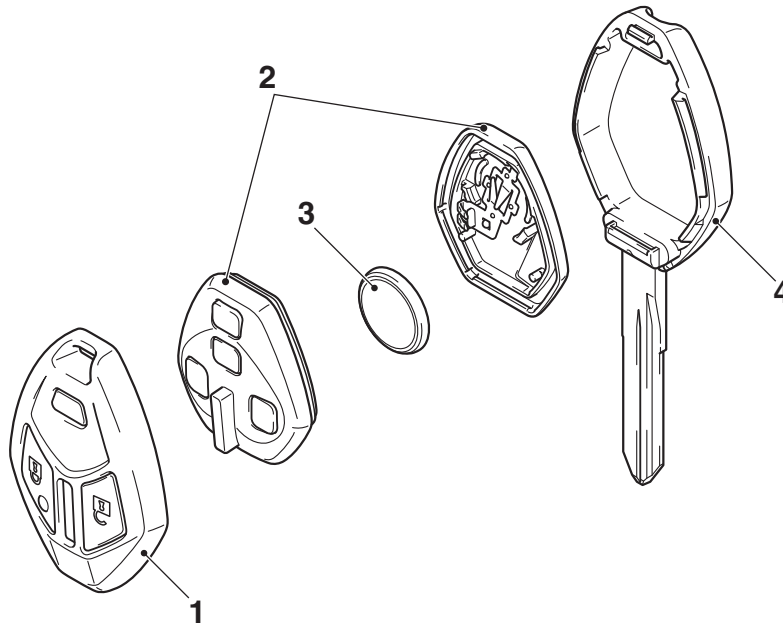

AC405679AD

<<A>>

**Disassembly steps**

1. Upper cover
2. Transmitter assembly

<<B>> >>A<<

**Disassembly steps (Continued)**

3. Battery
4. Master key

## DISASSEMBLY SERVICE POINTS

### <<A>> UPPER COVER REMOVAL

**⚠ CAUTION**

To prevent damage to the transmitter, wrap a flat-tipped screwdriver with protective tape before prying. Insert a flat-tipped screwdriver in the area shown, and remove the upper cover by prying it with the screwdriver.

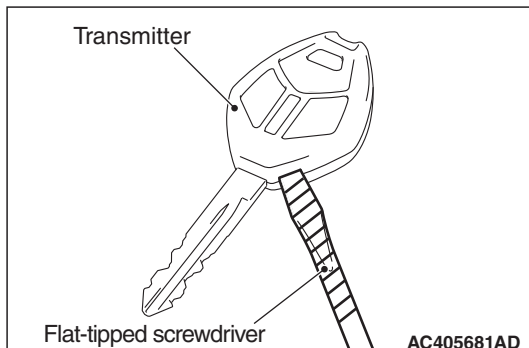

AC405681AD

## <<B>> BATTERY REMOVAL

### ⚠ CAUTION

- Do not allow water or dust to enter the inside of the transmitter assembly when it is open. Also, do not touch the precision electronic device.
- To prevent damage to the transmitter assembly, wrap a flat-tipped screwdriver with protective tape before prying.

Insert a flat-tipped screwdriver in the area shown, and remove the battery by prying it with the screwdriver.

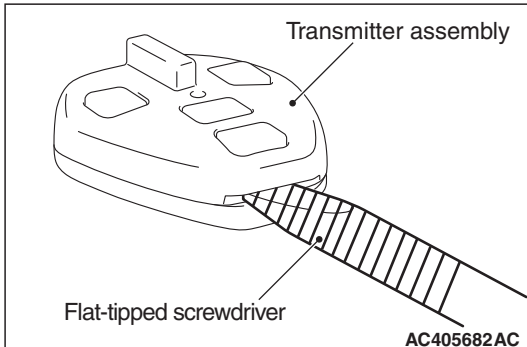

## ASSEMBLY SERVICE POINT

### >>A<< BATTERY INSTALLATION

### ⚠ CAUTION

Do not allow water or dust to enter the inside of the transmitter assembly when it is open. Also, do not touch the precision electronic device.

Install a new battery to the transmitter assembly with its (+) side facing towards the master key side.

**Battery required for replacement: Coin type battery  
CR1620**

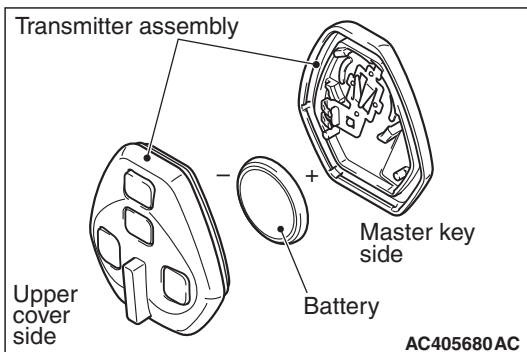

# TPMS TRANSMITTER

## REMOVAL AND INSTALLATION

M1427509300017

**⚠ WARNING**

*Certain components of this vehicles, such as TPMS transmitters, may contain perchlorate materials. Special handling may apply. For additional information, see [www.dtsc.ca.gov/hazardouswaste/perchlorate](http://www.dtsc.ca.gov/hazardouswaste/perchlorate).*

**⚠ CAUTION**

- Do not vary the angle of valve except at mounting on the rim. If varying the angle over and over, it may cause breakage of antenna plate resulting in the failure of TPMS transmitter.
- Ensure valve cap is always in place except when adjusting tire pressure.
- If the valve core and valve cap are replaced, use a genuine replacement part. The valve core is similar to a conventional one, but uses nickel plating to avoid corrosion.
- Replace the seal and seal washer with a new one every five years or when the tire is replaced.
- Do not drop the TPMS transmitter from height greater than 1 meter (3.3 feet).
- Do not expose the TPMS transmitter to extraneous magnetic fields.
- TPMS transmitter should not be stored at temperatures above 80° C (176° F).
- TPMS transmitter should not be exposed to temperatures above 100° C (212° F).
- If the TPMS transmitter is replaced, execute "Tire Pressure Sensor ID Registration" on scan tool MB991958 "Special Function."
- Be careful not to damage the TPMS transmitter.

**Pre-removal Operation**

- Wheel and Tire Removal

**Post-installation Operation**

- Wheel and Tire Installation
- Tire Pressure Sensor ID Registration If a new TPMS transmitter is installed (Refer to [P.42C-10](#)).
- After the tire pressure sensor ID registration, check that the TPMS warning light does not illuminate or flash.



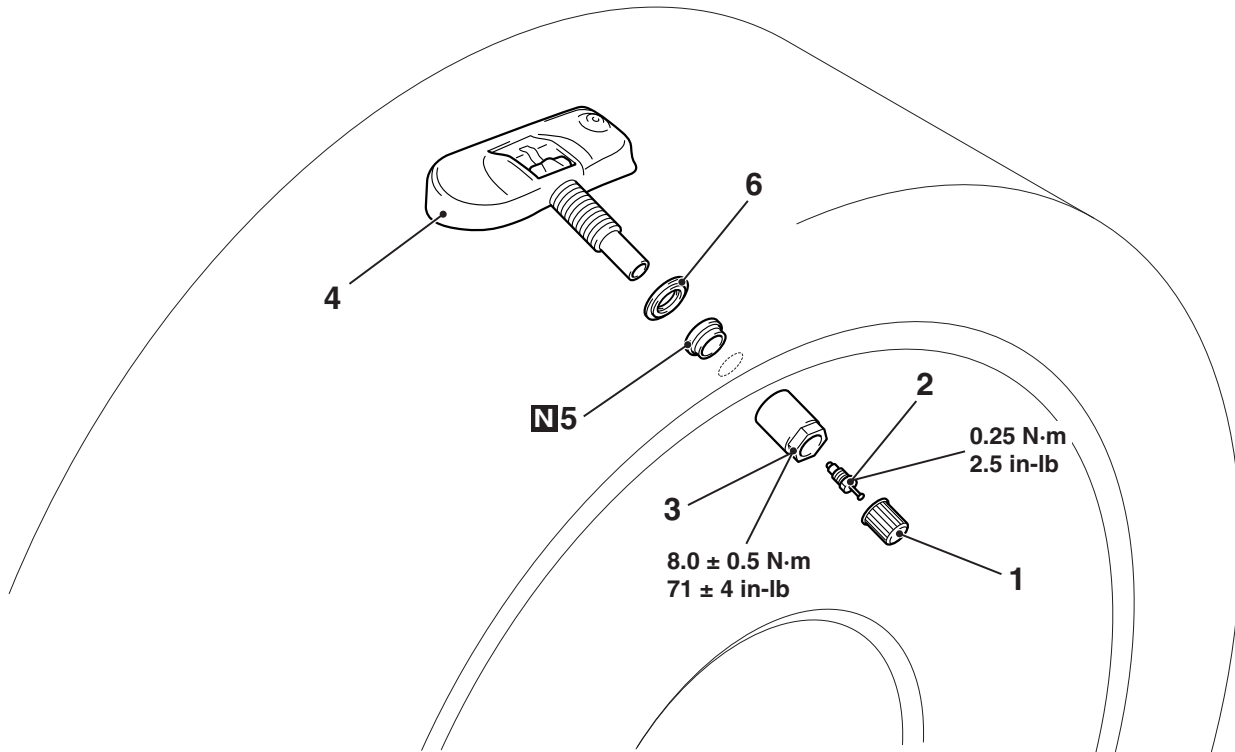

AC610443AB

<<A>>  
<<A>>  
<<A>>

**Removal steps**

1. Cap
2. Valve core
3. Nut
  - Let TPMS transmitter fall into tire
  - Tire bead
4. TPMS transmitter
5. Seal
6. Seal washer

<<B>>  
<<C>>  
<<C>>

>>A<<  
>>A<<  
>>A<<  
>>A<<  
>>B<<

**Installation steps**

6. Seal washer
5. Seal
4. TPMS transmitter
3. Nut
  - Tire bead mounting
2. Valve core
  - Tire pressure inflation
  - Valve nut retightening
1. Cap

>>C<<  
>>C<<

**REMOVAL SERVICE POINTS**

**<<A>> CAP/VALVE CORE/NUT REMOVAL**

**⚠ CAUTION**

Ensure cap is always in place except when adjusting tire pressure.

1. Remove the cap and valve core to deflate the tire.
2. Once tire pressure is released, remove nut and let TPMS transmitter fall into tire.

## &lt;&lt;B&gt;&gt; TPMS TRANSMITTER REMOVAL

**⚠ CAUTION**

Be careful not to damage the TPMS transmitter.

1. Place on tire changing machine and break both tire beads ensuring that the TPMS transmitter remains in the bottom of the tire.
2. Lubricate tire well and remove outer side of the tire.
3. Reach inside the tire and remove the TPMS transmitter.
4. Remove tire from rim using proper tire changing equipment procedures.

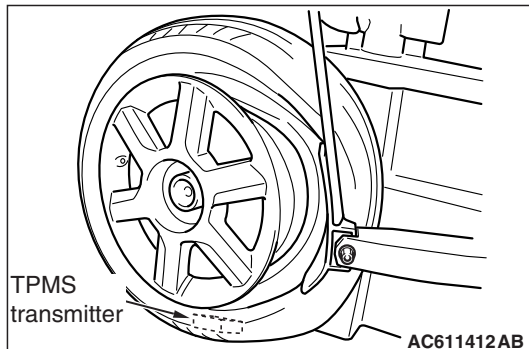

## &lt;&lt;C&gt;&gt; SEAL/SEAL WASHER REMOVAL

**⚠ CAUTION**

- Do not vary the angle of valve except at mounting on the rim. If varying the angle over and over, it may cause breakage of antenna plate resulting in the failure of TPMS transmitter.
- Use a soft tool to remove the grommet and washer to prevent scratching the valve of the TPMS transmitter.

1. Hold the TPMS transmitter and the seal washer, then extract it, this also extracts the seal. Take care to not damage the valve thread.

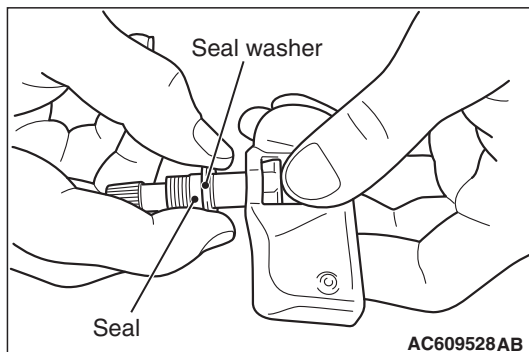

2. Clean the TPMS transmitter and the valve stem holding the valve as shown. Take care to support the rear of the valve with a thumb so that there is no movement of the stem.

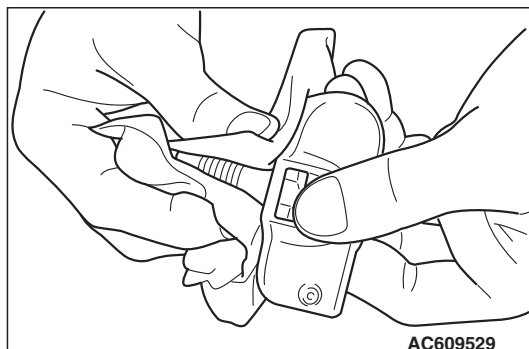

## INSTALLATION SERVICE POINTS

### >>A<< SEAL/SEAL WASHER/TPMS TRANSMITTER/NUT INSTALLATION

#### **⚠ CAUTION**

When installing a new seal and seal washer, make sure to support the valve stem base with a thumb so that there is no movement of the stem. Otherwise, the stem may protrude resulting in the breakage of antenna plate.

1. Insert these up to the base of the TPMS transmitter, making sure to secure the valve base with a thumb, as shown.  
Wipe the seal and threading.

#### **⚠ CAUTION**

- Visually check that TPMS transmitter is not deformed or damaged.
  - When installing the TPMS transmitter, be sure the rim, seal valve and nut are clean.
  - Ensure the grommet is located inside the valve hole before installing the nut.
  - While installing the nut, push the TPMS transmitter to maintain the lower lip of the transmitter case is in contact with the rim without clearance.
  - While installing the valve nut, ensure the tool is kept aligned to the valve and the valve hole.
  - After installing the nut, check that the seal is compressed and seal washer is bend.
2. Install the valve, in the valve hole, without modifying the angle of the stem (retain position of delivery). The laser marking should be visible at the operator.

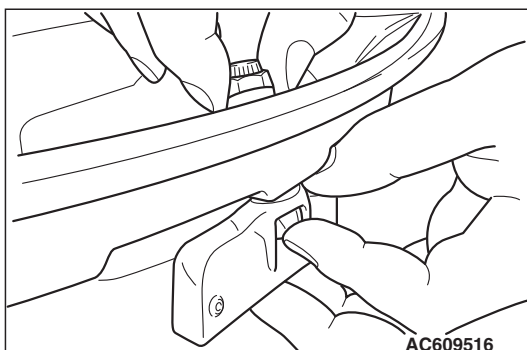
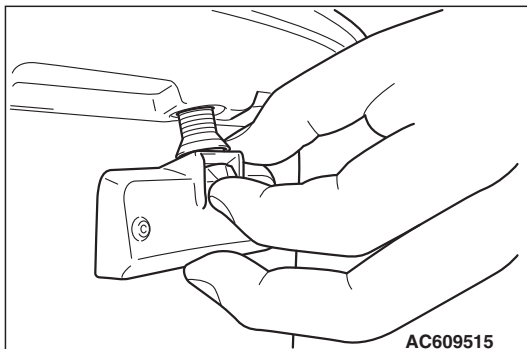
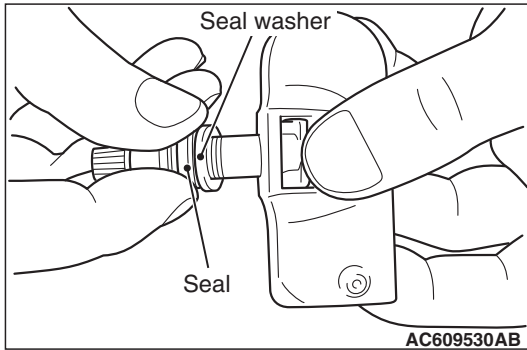

3. When the valve is completely inserted, maintain the TPMS transmitter in contact with the rim, then screw manually the nut until the contact with the wheel.

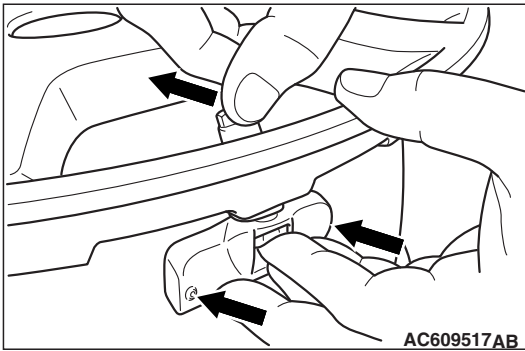

4. While maintaining the TPMS transmitter contact with the rim by applying pressure to the back of the valve, slightly press on the cap to wards the center of the wheel in order to adapt the angle of the valve/TPMS transmitter to the profile of the rim.

It is mandatory to guarantee the contact of the housing unit on the rim drop center.

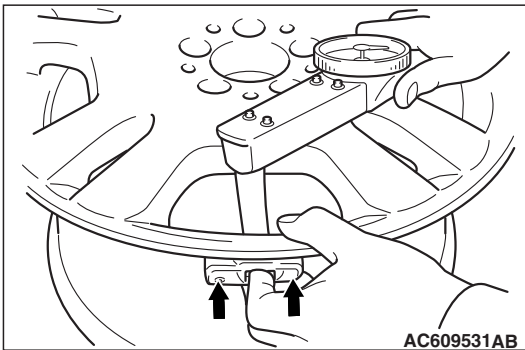

5. While maintaining the TPMS transmitter and valve in position, screw the nut with a torque wrench. Take care that the wrench socket is correctly inserted on the nut.

**Specified torque:  $8.0 \pm 0.5 \text{ N} \cdot \text{m}$  ( $71 \pm 4 \text{ in-lb}$ )**

### >>B<< TIRE BEAD MOUNTING

1. Prepare the tire and fix the rim as usual.

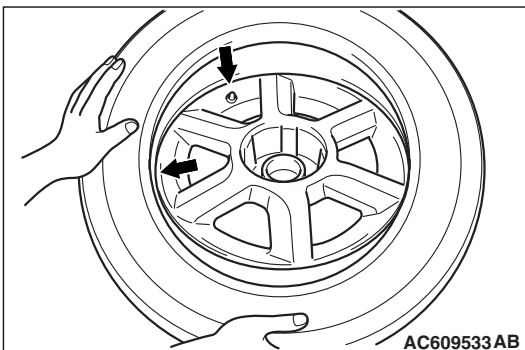
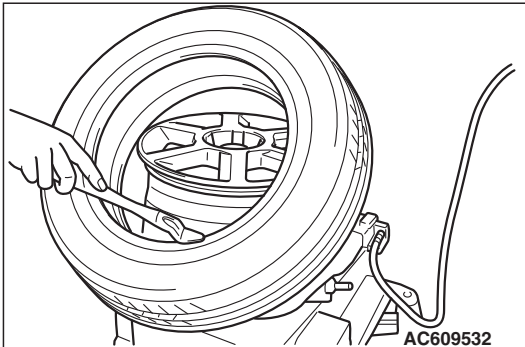

2. Put the tire on the rim, so that the cross point of the belt with the rim is approximately 20 cm (7.9 inch) away from the valve.

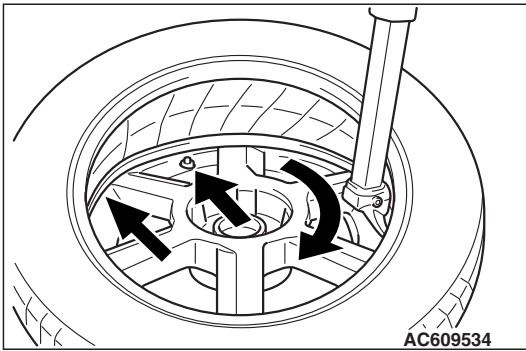

3. Engage the shoe and make sure that 20 cm (7.9 inch) is maintained between the cross point and the valve. The arrow shows the direction of rotation of the wheel.

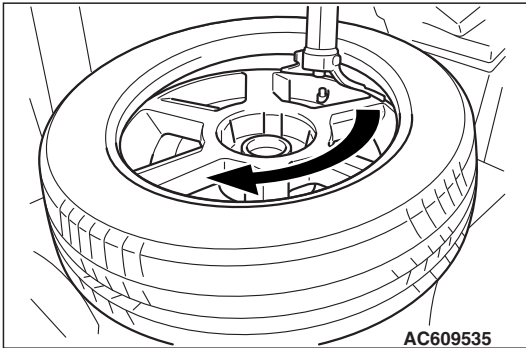

4. Turn the wheel in order to engage all the first side of the tire.  
*NOTE: The standard shoes can pass over the sensor without damaging it.*

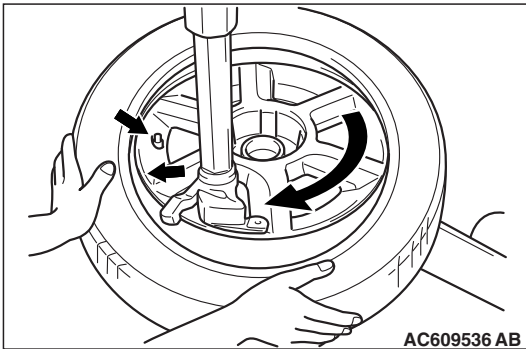

5. Put the second side of the tire in position, so that the cross point of the belt with the rim is approximately 20 cm (7.9 inch) away from the valve. The curved arrow shows the direction of rotation of the wheel.

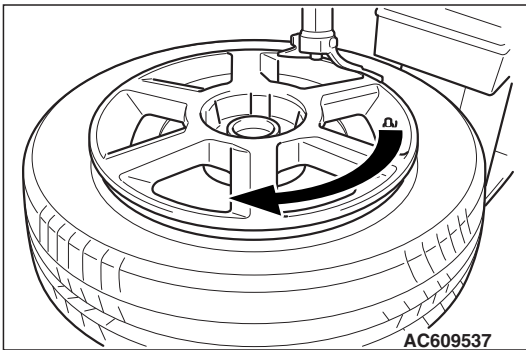

6. Turn the wheel in order to engage all of the second side of the tire.  
*NOTE: The standard shoes can pass over the sensor without damaging it.*

**>>C<< TIRE PRESSURE INFLATION/NUT  
RETIGHTENING**** CAUTION**

After tire inflation, retighten the valve nut to  $8.0 \pm 0.5$  N·m ( $71 \pm 4$  in-lb). This is necessary, because the TPMS transmitter is secured to the wheel with the valve nut and rubber grommet. The rubber grommet will be depressed by tire pressure or deteriorate over a period of time, which requires the valve nut to be retightened.

Inflate tire to required pressure, then retorque the valve nut to  $8.0 \pm 0.5$  N·m ( $71 \pm 4$  in-lb).